



The following procedure is a supplement to other documentation supplied with this equipment and will guide the user in properly wiring the iQpump and motor. It will also show the user how to configure the iQpump for a simplex pump application.

**DANGER!**  
*Improper wiring can and will cause bodily harm as well as damage to the equipment.*

When installing the system be sure to follow good wiring practices and all applicable codes. Ensure that the mounting of the various components are secure and that the environment, such as extreme dampness, poor ventilation etc. will not cause system degradation.

*Please read this cheat sheet and other documentation provided with the iQpump thoroughly before attempting any installation.*

## Step 1 iQpump Model Identification and Mounting

To make sure you received the correct model, it is essential to verify the iQpump nameplate with your order and make sure the iQpump has the correct rating so it can be used with your motor. Please check the nameplate information as shown in the example below.

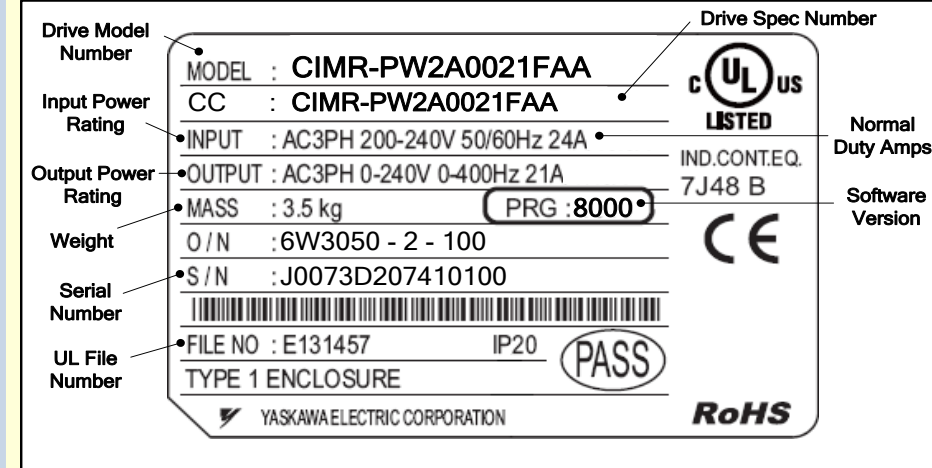

- Check that the available power will meet the **input power** requirements.
- Ensure that the **output power** from the iQpump is compatible with the motor requirements.
- In the case of systems with more than one iQpump, follow the above procedure for each iQpump and motor.

### Mounting the iQpump

The mounting of the iQpump is extremely important regarding environment and accessibility. Depending on your system, there are various models available and the mounting dimensions (footprint) may be different. Because the mounting procedure is fairly extensive, it is beyond the scope of this document; the user is referred to the iQpump Quick Start Guide (Document No. TOEP YAIP1W 01) received with the iQpump, Section 2.2 Mechanical Installation. Match the model that you received and follow the procedure described in the manual to ensure a safe and functional installation. In cases where the system has more than one iQpump, refer to the proper clearances required for adequate ventilation. *Please pay particular attention to:*

- The clearances to be maintained around the enclosure for adequate ventilation.
- The environmental specifications such as avoiding excessive dampness, extreme temperatures, chemical exposure, corrosive areas, etc. to avoid damage to the equipment and to maintain safety.

### Removing and Attaching the Terminal Cover

Improper removal of the iQpump terminal cover as well as front cover can cause extensive damage to the iQpump. To avoid damage to these items, please pay particular attention to the iQpump Quick Start Guide, Document No. TOEP YAIP1W 01, Section 3.5, Removing and Attaching the Terminal Cover.

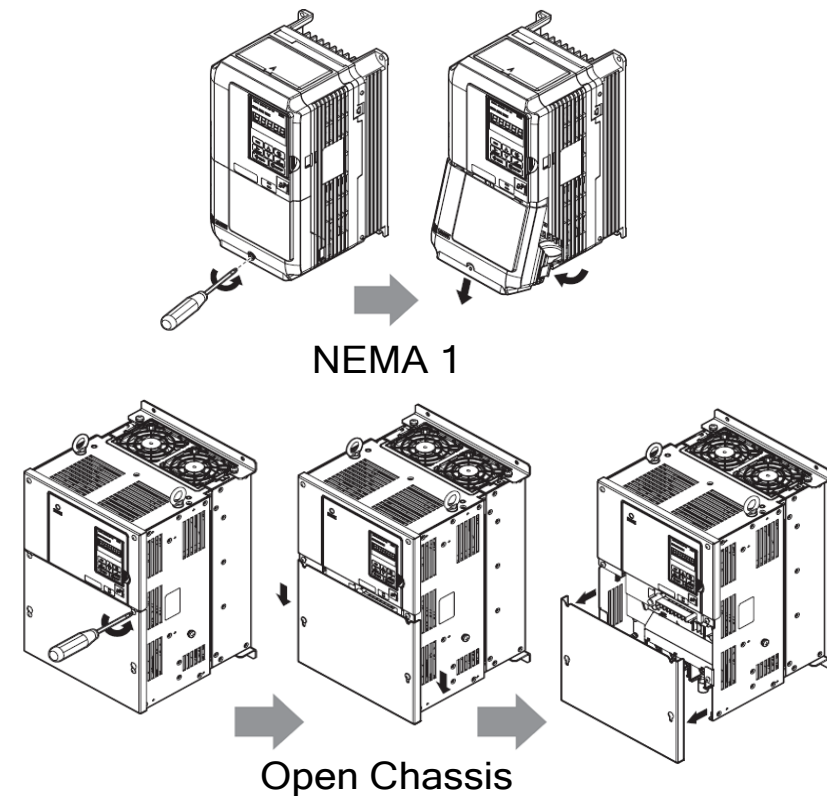

## Step 2 Connect Motor and Line Power

Fig. 1 & 2 below show the electrical connections for the input power and motor terminals for various iQpump models. Select the proper diagram for the model you are installing (see Step 1). **WITH POWER OFF** make the appropriate connections. *Make sure to follow good wiring practices and all applicable codes. Ensure that the equipment is grounded properly as shown in fig. 1*

**DANGER; LETHAL VOLTAGES ARE PRESENT- Before applying power to the iQpump, ensure that the terminal cover is fastened and all wiring connections are secure. After the power has been turned OFF, wait at least five minutes until the charge indicator extinguishes completely before touching any wiring, circuit boards or components.**

**WARNING DO NOT CONNECT ANY OF THE FOLLOWING TERMINALS TO EARTH GROUND**

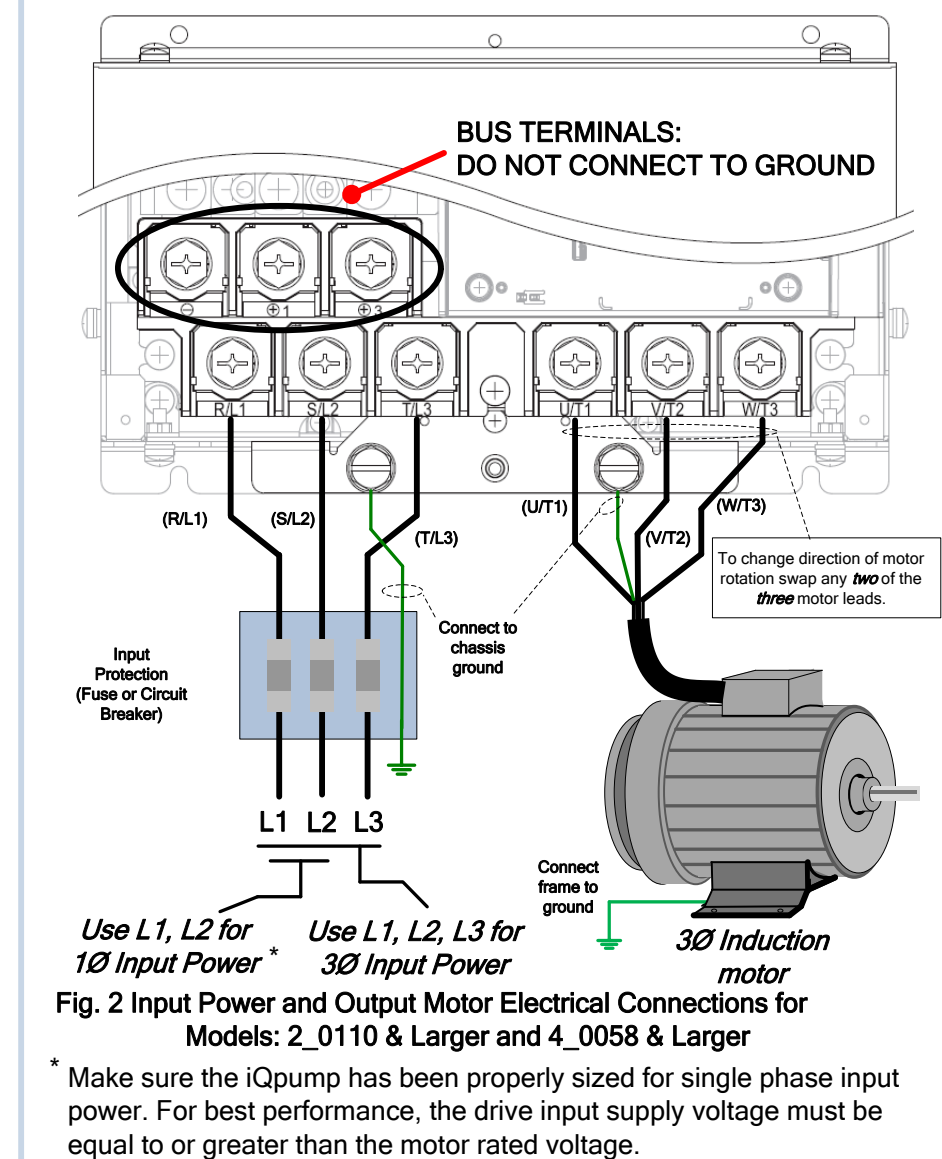
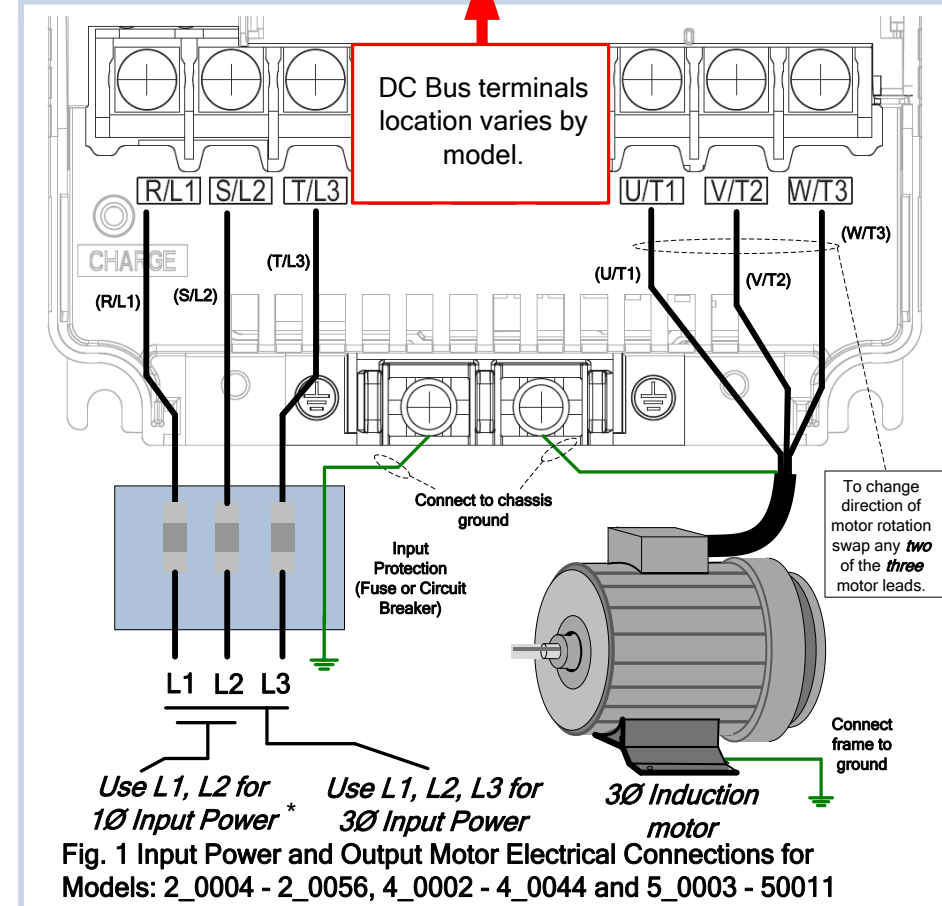
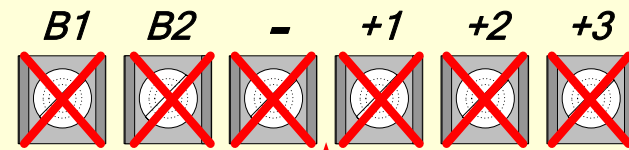

## Step 3 Real-time Clock Setup

This step shows how to setup the iQpump real-time clock for first use.

**Note:** If clock is not set the drive can still be programmed and operated, but ALM light will flash every 30s and showing Clock Not Set message.

Power up the drive and set the real-time Clock. The real-time Clock setup screen will appear at first power up.

Press **F2** to set the clock.

**Note:** After the real-time clock is set the real-time clock setup screen will not show again unless parameter o4-17 is set to "Set".

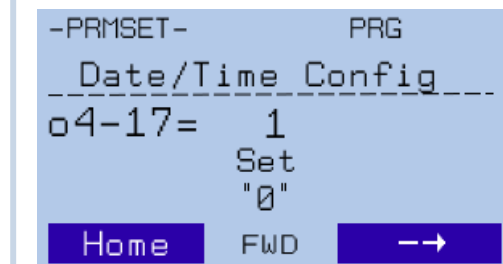

### Real-time Clock Setup Screen

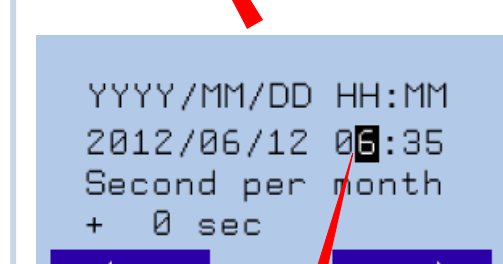
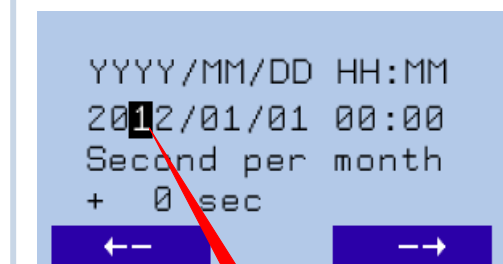
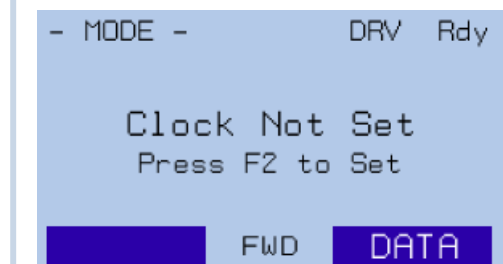

Use **F1** to move cursor to the left and **F2** to move cursor to the right. Use **▲** **▼** to adjust. When date and time are set press **ENTER** to save.

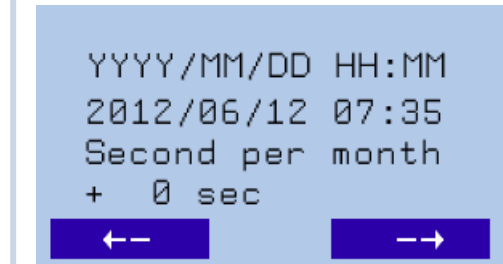

**Example:** Jun 12<sup>th</sup> 2012, 7:35am

**Note:** Do NOT adjust sec per month.

## Step 4 Selecting Start/Stop and Speed Method

This step shows how to connect control wiring and feedback signal to the iQpump. Before making any control connections **MAKE SURE POWER TO THE iQpump IS TURNED OFF!** Next remove the terminal cover to gain access to the control terminals. (Step 1.)

### SELECT START / STOP CONTROL METHOD b1-02

The iQpump is **DEFAULT SETUP TO START/STOP FROM THE KEYPAD** (digital operator). If this is the preferred start/stop method then continue to the feedback signal connection section. Please refer to the wiring diagram below to start/stop the iQpump using an external switch or contact.

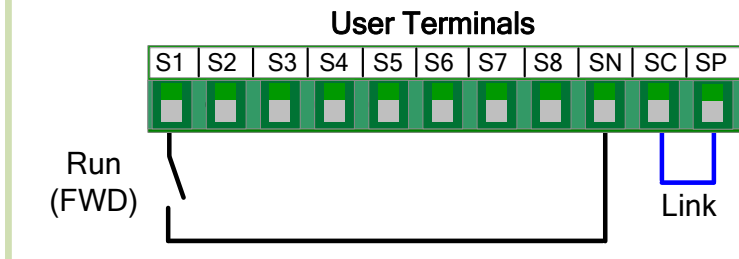

**Wiring Diagram: 2-Wire Control**  
Use for maintained contacts

**Note:** 3<sup>rd</sup> row of terminal board is shown here.

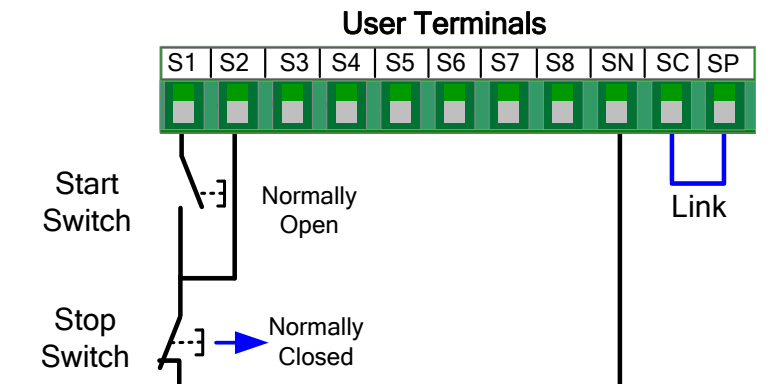

**Wiring Diagram: 3-Wire Control**  
Use for momentary contacts

To use 3-Wire Control first Initialize the iQpump using parameter A1-03 = 3330 (Refer to the Quick Start Guide TOEP YAIP1W 01)

### FEEDBACK SIGNAL WIRING (TRANSDUCER)

**Note:** 2<sup>nd</sup> row of terminal board is shown here.

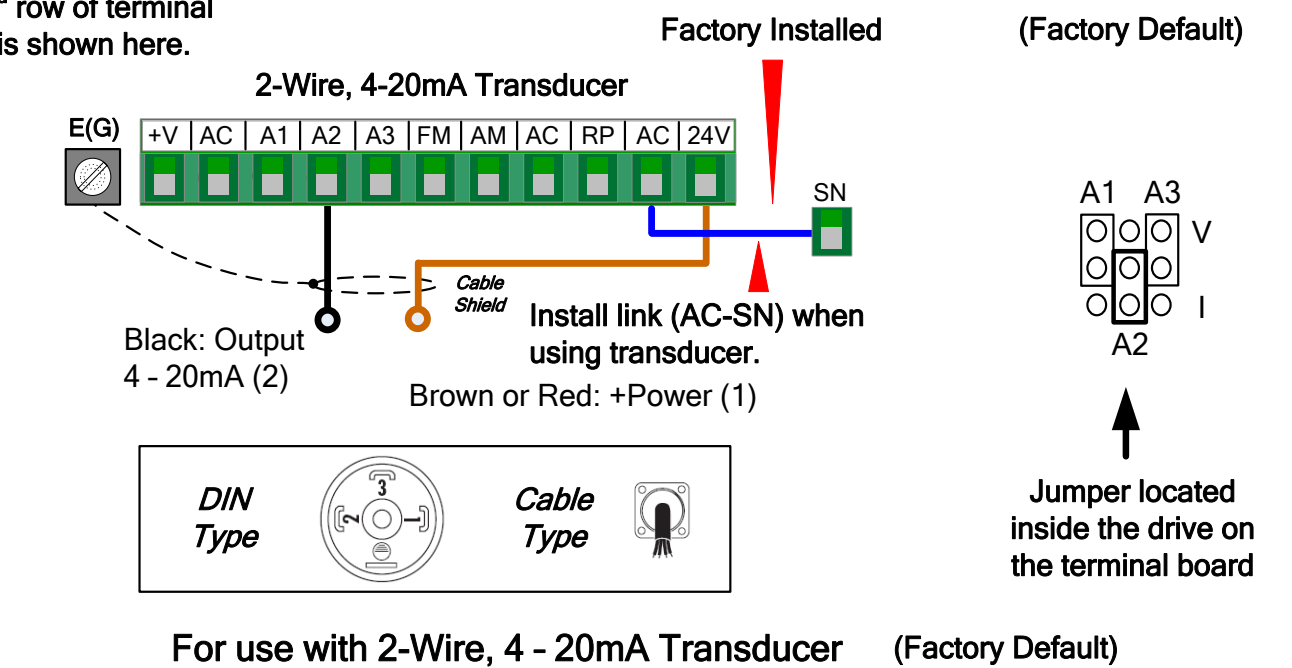

**Note:** 2<sup>nd</sup> row of terminal board is shown here.

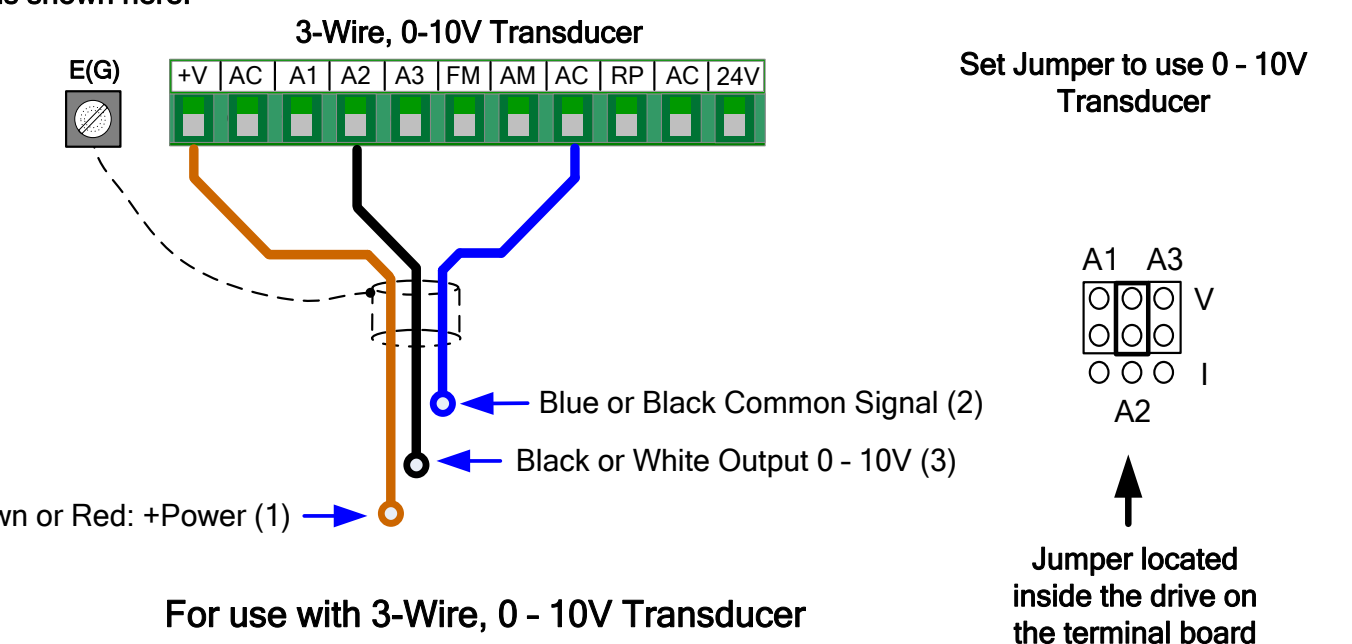

**Important Note:** Signal colors and numbering may vary depending on feedback device used, please consult feedback device manual.

**NOTE:** It is beyond the scope of this document to program the iQpump drive for network communication control. Please refer to the refer to the iQpump Quick Start Guide, (Document No. TOEP YAIP1W 01) for this selection.





## Step 5 Changing Parameters and Monitoring the iQpump

This step shows how to access and modify an iQpump parameter as well as how to monitor iQpump signals such as output frequency and motor current.

Make sure all protective covers have been re-attached and power is turned on. DO NOT RUN THE MOTOR.

### Access Parameter Menu and Change Parameter Value

Press **V** two times until the digital operator shows the parameter menu.



2X **V** → **ENTER** → **RESET** Select Digit



2X **RESET**

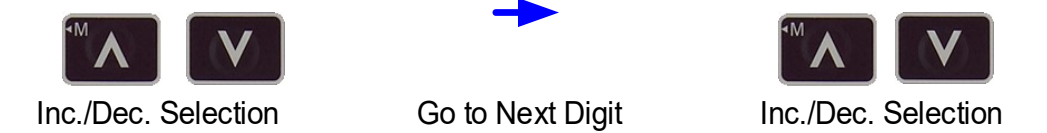

Inc./Dec. Selection      Go to Next Digit      Inc./Dec. Selection

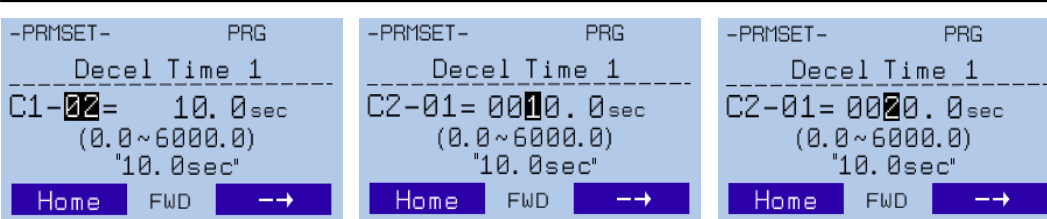

Switch to Edit Mode      Modify Value      Save New Value

Hold **ESC** button for 3 sec. to go back to the main menu.

### Monitor Motor Frequency and Motor Current

iQpump Digital Operator power-up state →

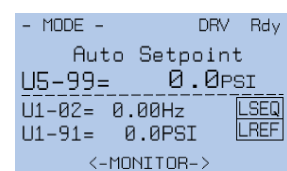

Output Frequency and Transducer Feedback can be monitored simultaneously. Use **F1** and **F2** to select monitor signals.

Press **ESC** **M** simultaneously shows the monitor menu.

Press **ENTER** to access monitor menu.

Use **M** **V** to select monitor.

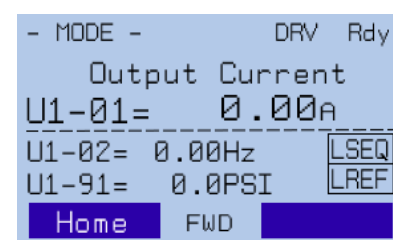

Please refer to the iQpump Quick Start Guide, (Document No. TOEP YAIP1W 01) on how to access other drive monitors.

## Step 6 Application Setup

This step shows how to configure the iQpump for a dedicated pump application.

Make sure all protective covers have been re-attached and power is turned on. DO NOT RUN THE MOTOR.

Available iQpump Application Macros:

- 6008 Constant Pressure Mode (PSI) ← **Default**
  - 6009 Pump Down Level Mode (Ft)
  - 6010 Geothermal Mode
  - 6011 VTC Pressure Control Mode
  - 6012 Pivot Panel VTC
  - 6013 Adv Pressure Ctrl
  - 6014 Pivot Panel Sub
  - 6015 VTC Pump Command
  - 6016 Sub Pump Command
  - 7770 General Purpose Mode
  - 7771 Sub Mtr GP Oper
- The factory default is setup for constant pressure PSI, only change if application different.**

### Select Application

Press **V** two times until the digital operator shows the parameter menu.



2X **V** → **ENTER** → 2X **RESET** Select Digit

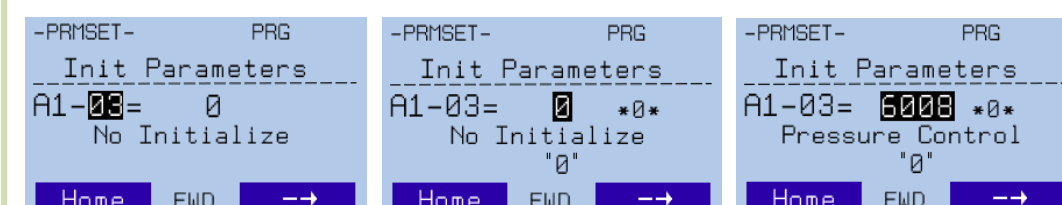

Inc./Dec. Selection      Switch to Edit Mode      Select Application

Press **ENTER** to select.

### Enter Application Parameters

Hold **ESC** button for 3 sec. to go back to the main menu.

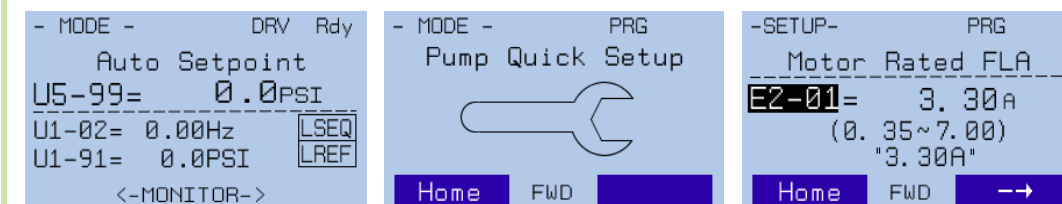

3X **V** → **ENTER** → **M** **V** Select Parameter.

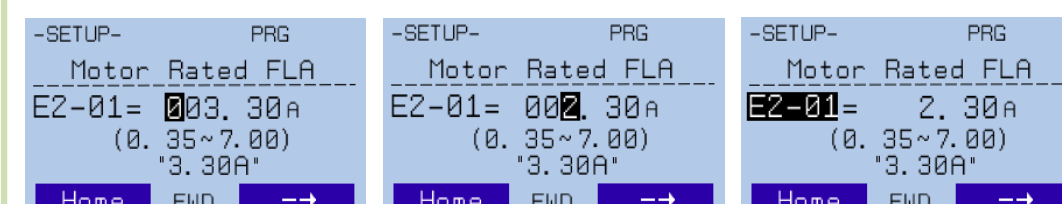

Switch to Edit Mode      Modify Value      Save New Value

### Go Back to Main Menu

Hold **ESC** button for 3 sec. to go back to the main menu.

## Step 7 iQpump Quick Setup Parameter Overview (Simplex)

Parameter	Value	Description	Reference	Comments
A1-06	Dependent on Initialization Mode	Application Selected	Displays selected applications, see Step 6.	Read-only cannot be modified
E2-01	Drive Size Dependent	Motor Rated Current	Set to the motor nameplate full load amps.	For submersible motors use service factor amps (SFA).
E2-04	2	Number of Motor Poles	Number of motor poles is used to show the correct motor RPM on the display Enter '4' for an 1800 RPM motor and '2' for a 3600 RPM motor.	Confirm number of poles 2 Pole Motor = 3600 RPM 4 Pole Motor = 1800 RPM 6 Pole Motor = 1200 RPM 8 Pole Motor = 900 RPM
P1-03	145	Feedback Device Scaling	System Scaling: Enter feedback device maximum: Example: Enter 200 for pressure transducer with a maximum of 200 PSI at 20mA.	Confirm feedback device scaling. <b>(See Illustration 1)</b>
Q1-01	0	Setpoint 1	Set System Setpoint	<b>Set to system pressure</b>
P1-04	0.0 PSI	Start / Drawn Down Level	When the iQpump is turned <b>On</b> and the feedback signal level (transducer) falls below this level, the pump system will start after the time specified in P1-05 (default 1 sec). <b>Programming the Start Level as an Absolute Value.</b> Start / Draw Down Level has to be programmed to a positive value in order for the Start / Draw Down Level to be an absolute value. Example: Start / Draw Down Level P1-04 set to <b>50 PSI</b> and delay time P1-05 set to <b>5 sec</b> . Pump system will start when the pressure drops below 50 PSI for 5 sec. <b>Programming the Start Level as a Delta Level from the System Setpoint</b> Start / Draw Down Level has to be programmed to a negative value in order for the Start Level to be a delta value from the setpoint. Example: Start / Draw Down Level P1-04 set to <b>-10 PSI</b> with a system setpoint of <b>50 PSI</b> and a delay time P1-05 set to <b>5 sec</b> . Pump system will start when the pressure drops below 40 PSI (50 - 10) for 5 sec.	It is mandatory to program the Start / Draw Down Level in order to use the sleep function. <b>(See Illustration 2 and 3)</b>
P1-06	40.0 Hz	Minimum Pump Speed	Minimum speed (Hz) the pump motor has to operate at. <b>Example:</b> Base pump motor speed is 3600 RPM, minimum speed is 2400 RPM. Set minimum pump frequency to 40.0 Hz. (2400 + 3600 x 60 Hz = 40 Hz)	Minimum pump frequency should be set to a value where the pump enters a no-flow condition.
P4-10	0 Disabled	Auto Mode Operator Run Power Down Storage	Stores the run status in the Auto mode when operating from digital operator (b1-02=0). 0: Disabled 1: Enabled	Recommended for use when Start/Stop command is from the keypad. <b>(See Step 9)</b>
P5-04	1 Enabled	Hand Key Enable / Disable	Enables or disables the Hand Key on the digital operator. 0: Disabled 1: Enabled	Hand Key on keypad. <b>(See Step 10)</b>





**Step 7**

**iQpump Factory Defaults Overview (only adjust settings based on your application)**

Parameter	Value	Description	Reference	Comments
b5-03	3.0 sec.	PI Integral Time	Decrease integral time to make iQpump more responsive.	<b>Caution:</b> can cause instability if value is too low.
b5-12	2 (Fault)	PI Feedback Reference Missing Detection Selection	Select what to do when the feedback device (transducer) fails or gets disconnected. 0: Disabled, continue running no message is displayed 1: Alarm, show warning on the keypad when the feedback device fails or is disconnected 2: Fault, stop pump system when the feedback fails or is disconnected	<b>NOTE:</b> Disable parameter b5-12 if no transducer is installed.
C1-01	20.0 sec. <b>See Note</b>	Acceleration Time 1	Time it takes to accelerate the pump motor from zero to maximum speed. <b>NOTE:</b> Factory default with Thrust Mode enabled is 12.0 sec, 20.0 sec when disabled.	Adjusted depending on system performance
C1-02	10.0 sec. <b>See Note</b>	Deceleration Time 1	Time it takes to decelerate the pump motor from maximum speed to zero. <b>NOTE:</b> Factory default with Thrust Mode enabled is 5.0 sec, 10.0 sec when disabled.	
L5-01	5	Number of Restart Attempts	Determines the number of times iQpump will perform an automatic restart on the faults listed in the comments column.  iQpump System Protection Faults that can be setup to restart are Low Level Feedback, High Level Feedback, Transducer Loss, Not Maintaining Setpoint, Loss of Prime, Pump Over Cycle. Refer to parameters P4-07 and P4-08. The number of restart attempts is set by L5-01.	<ul style="list-style-type: none"> <li>• Overcurrent</li> <li>• Ground Fault</li> <li>• Output Phase Loss</li> <li>• Input Phase Loss</li> <li>• iQpump Overload</li> <li>• Motor Overload</li> <li>• Overtorque</li> <li>• DC Bus Fuse Blown</li> <li>• DC Bus Undervoltage</li> <li>• DC Bus Overvoltage</li> <li>• Overheat</li> </ul>
L5-03	20 sec.	Maximum Restart Time After Fault	If the restart fails (or is not attempted due to a continuing fault condition) iQpump waits the Maximum Restart Time After Fault, before attempting another restart.	
P1-06	40.0 Hz	Minimum Pump Frequency	Minimum speed (Hz) the pump motor has to operate at. Example: Base pump motor speed is 3600 RPM, minimum speed is 2400 RPM. Set minimum pump frequency to 40.0 Hz. $(2400 \div 3600 \times 60 \text{ Hz} = 40 \text{ Hz})$	P1-06 should be set to the level where the pump can produce the minimum pressure even at zero flow.
P2-03	5 sec.	Sleep Delay Time	Time it takes before the pump system goes to sleep when the selected signal level (P2-01) falls below the specified sleep level (P2-02)	Adjust according to system requirements.
P4-12	30.0 Hz	Thrust Bearing Frequency	Sets the frequency reference used when the thrust bearing function is active. A value of 0 disables this function.	Primarily used for submersible pumps. Program P4-12 = 0.0 Hz to disable function when iQpump is used with a centrifugal pump.
P4-17	0.2 Min	Utility Start Delay	When utility power is restored and P4-10 is enabled (1), iQpump waits the time specified in P4-11 before auto operation becomes active.	Note: Only active when P4-10 is enabled (1) and operation (start/stop) is from the digital operator.

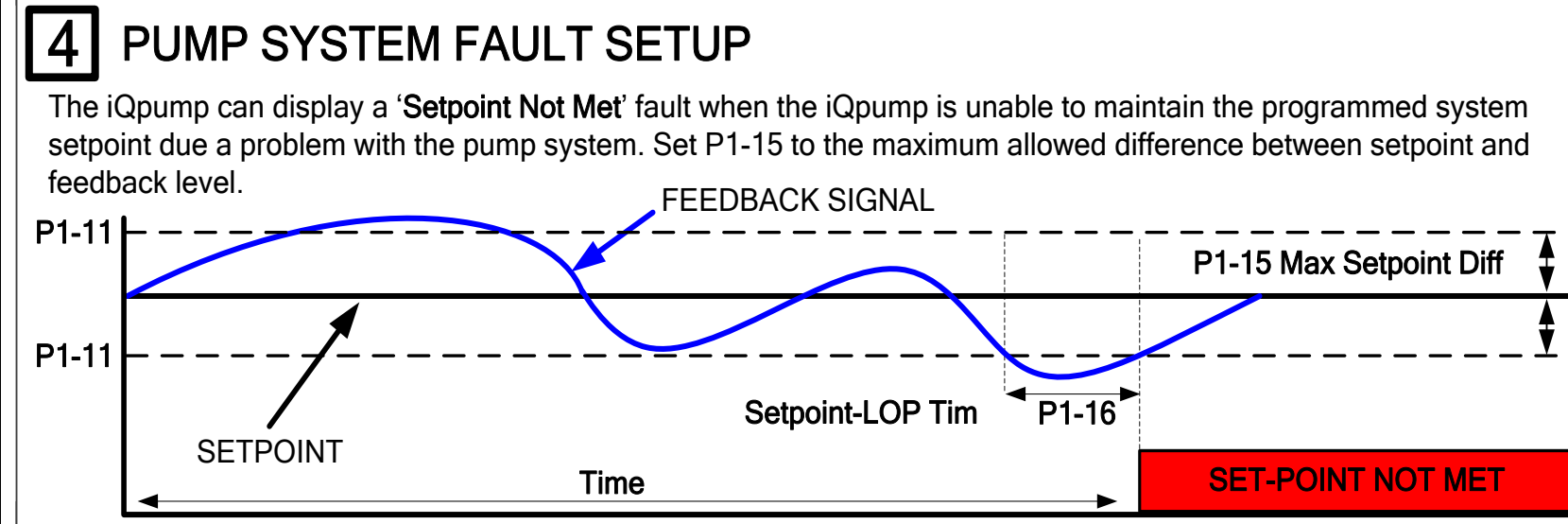
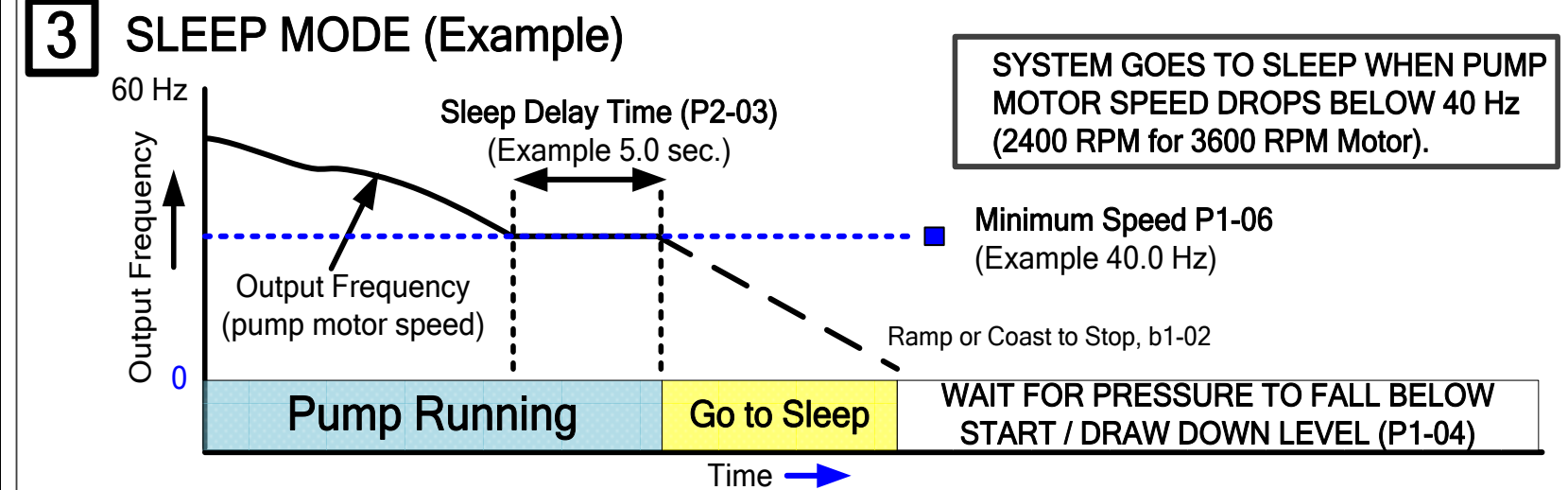

**5 LOW/HIGH FEEDBACK LEVEL DETECTION**

iQpump continuously monitors the system feedback signal. To display a 'Low Feedback' fault set the low feedback level parameter P1-08 to the minimum feedback level allowed for your system and to display a 'High Feedback' fault set the high feedback level parameter P1-11 to the maximum feedback level allowed.

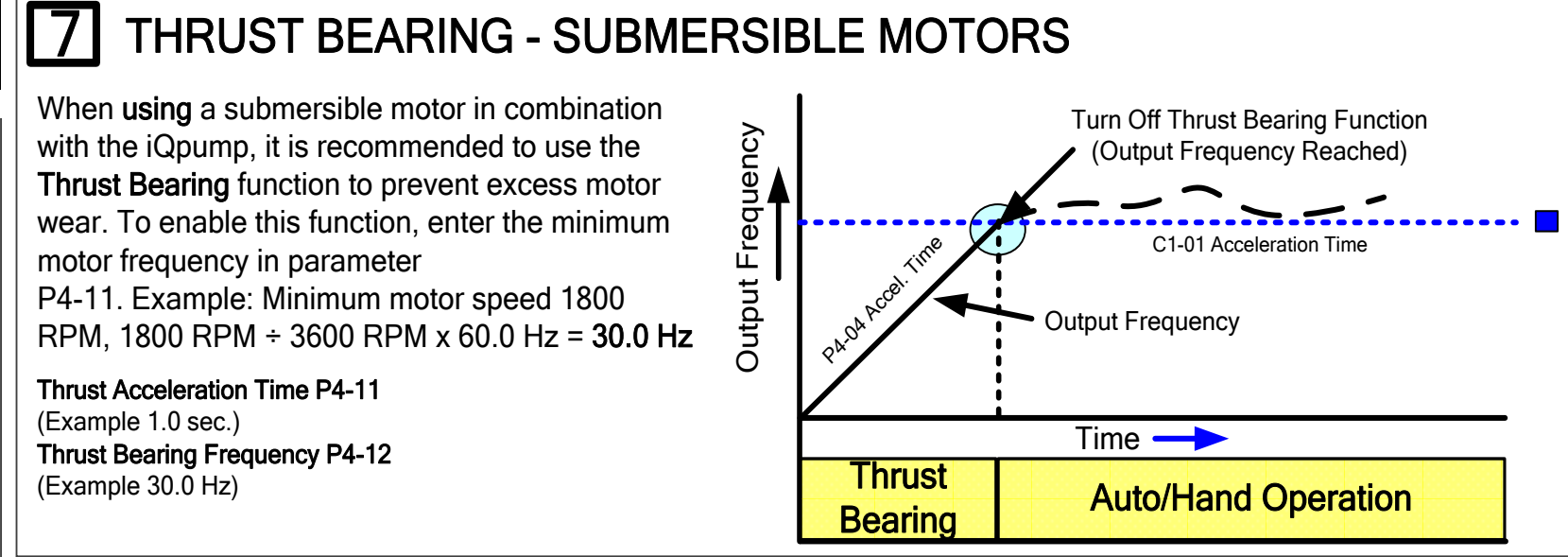
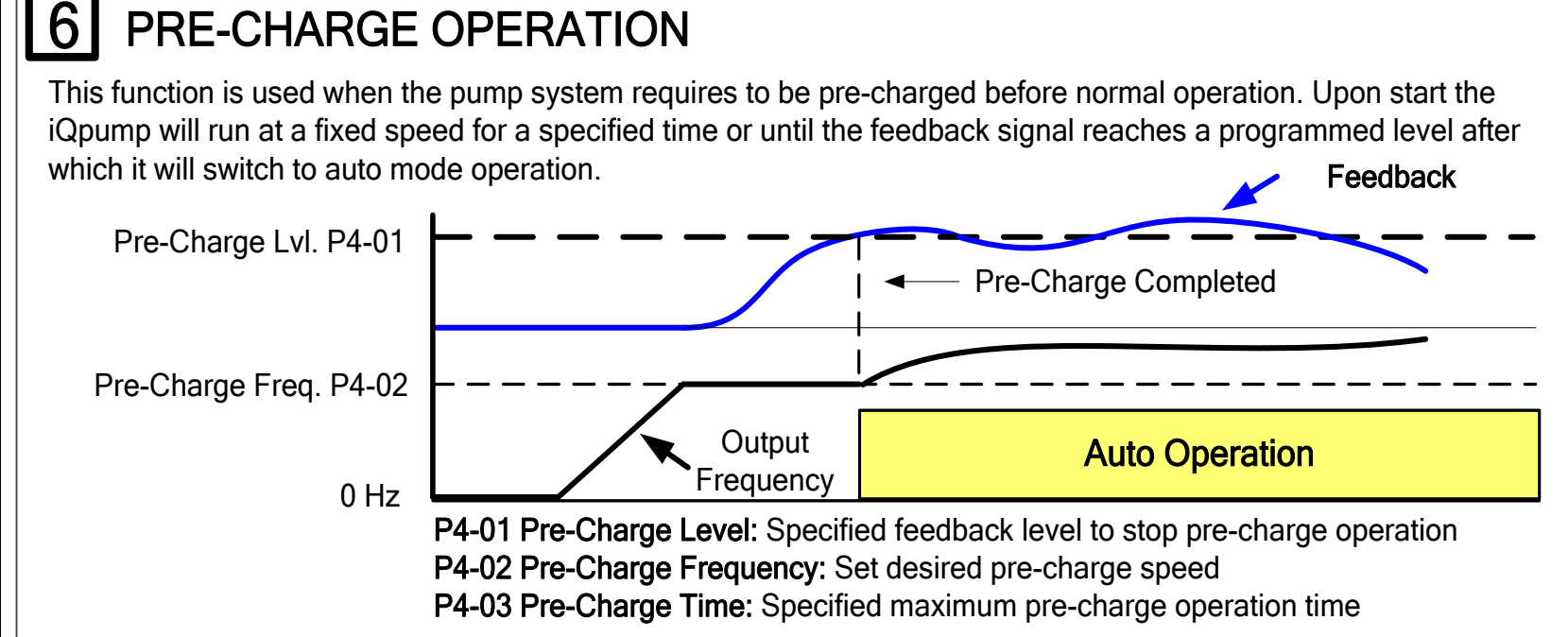

**8 AUTO OPERATION - POWER DOWN STORAGE**

Allows iQpump to automatically start after power failure when operated from keypad / digital operator. This function is recommended for use when operating the iQpump in remote / unmanned areas. Use parameter P4-10 to enable.

**⚠ When the iQpump is powered down while running, an internal run command will automatically be initiated upon power-up.**

**1 SYSTEM FEEDBACK UNIT / FEEDBACK DEVICE SCALING**

**P1-02 Feedback Unit**

0: Inch of Water	8: Bar
1: PSI	9: Pascal
2: GPM	10: Degrees Celsius
3: Degrees Fahrenheit	11: Meter
4: CFM	12: Feet
5: CMH	13: Liters per Minute
6: Liters / Hr	14: cm per Minute
7: Liters/Sec	15: Inch Hg
	25: No Unit

P1-03 = 200.0 PSI Feedback Scaling

**Feedback Maximum**

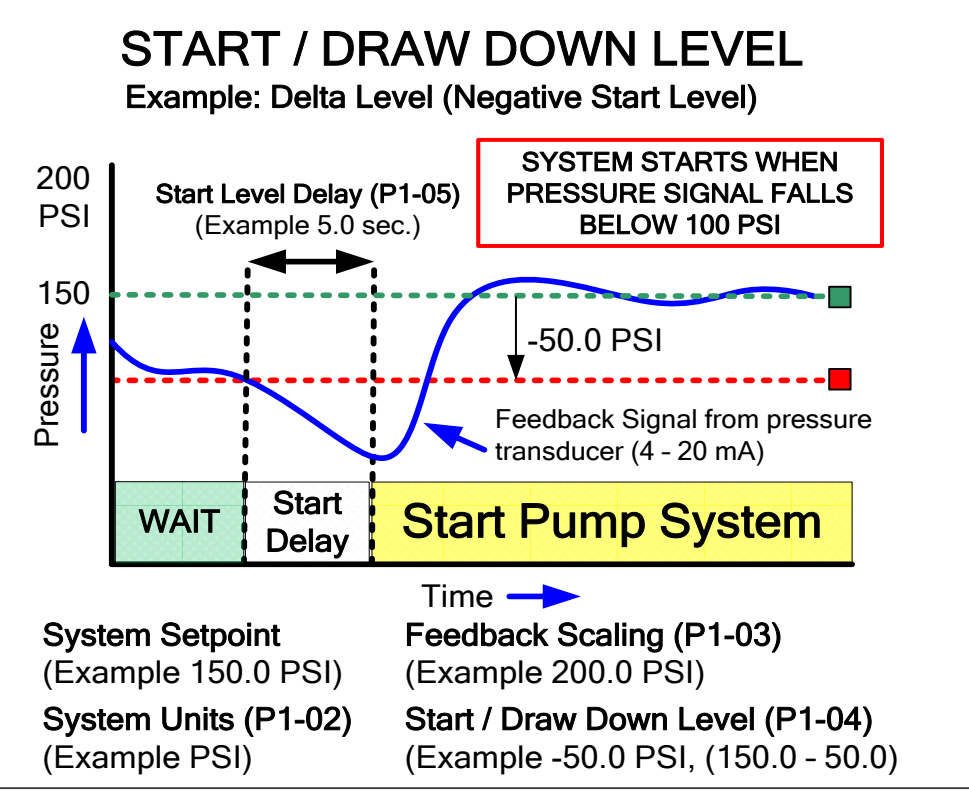
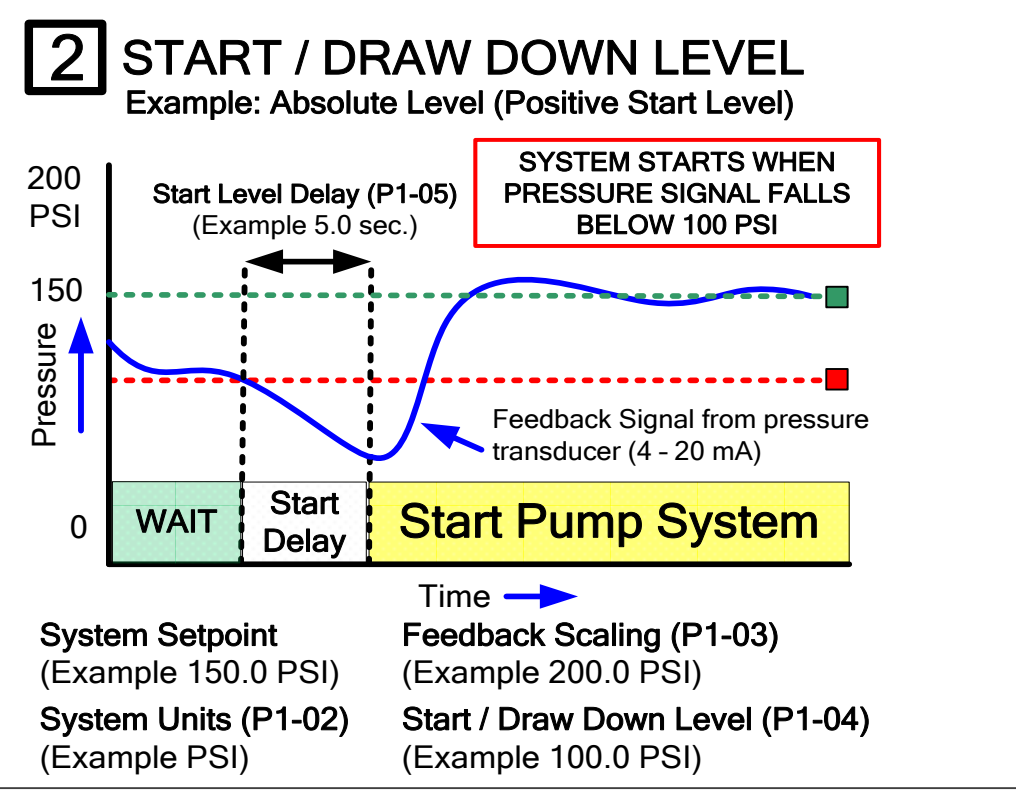





**Step 8 Pump Rotation and Feedback Signal Check**

In this step the motor is checked for proper direction and operation. This test is to be performed solely from the digital operator. Apply power to the iQpump after all the electrical connections have been made and protective covers have been re-attached. At this point, **DO NOT RUN THE MOTOR**, the Digital Operator should display as shown in *Fig. 3*.



Fig. 3: Digital Operator

**Motor Rotation Test**

Next, push **HAND** on the Digital Operator; the display should read

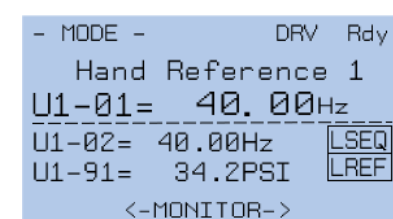

and the **HAND** LED should be *ON*.

The motor should now be operating at in the correct direction of pump.

Push **OFF** on the Digital Operator; the display should read as in Fig. 3.

Press **ENTER** to access Hand Speed. Use **↑** **↓** **RESET** to change Hand Speed value. Press **ENTER** to save value.

*If the direction is not correct, then power down the iQpump and follow*

*Instructions below.*

**⚠ DANGER**

*After the power has been turned OFF, wait at least five minutes until the charge indicator extinguishes completely before touching any wiring, circuit boards or components.*



Use precaution, and refer to *Fig. 1 or 2*, swap any **two** of the **three** output leads to the motor (U/T1, V/T2 and W/T3). After the wiring change, repeat **Step 8** and recheck motor direction.

Digital Operator turned off.

**FEEDBACK SIGNAL CHECK**

Verify feedback on display (show keypad) matches mechanical pressure gauge.

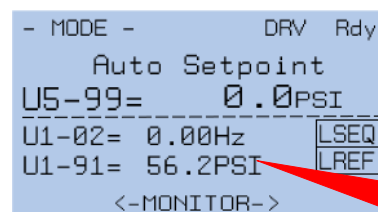

Refer to parameter P1-02 and P1-03, if the feedback device scaling or system units are incorrect.

**FEEDBACK SIGNAL LEVEL**

**Step 9 Auto Mode Operation**

**AUTO MODE**

The iQpump can be operated in AUTO mode when the following actions have been performed:

- All parameters are programmed
- Motor direction has been checked
- Auto Mode: Reference source selected in parameter b1-01 (See step 3)
- Auto Mode: Run source selected in parameter b1-02 (See Step 3)

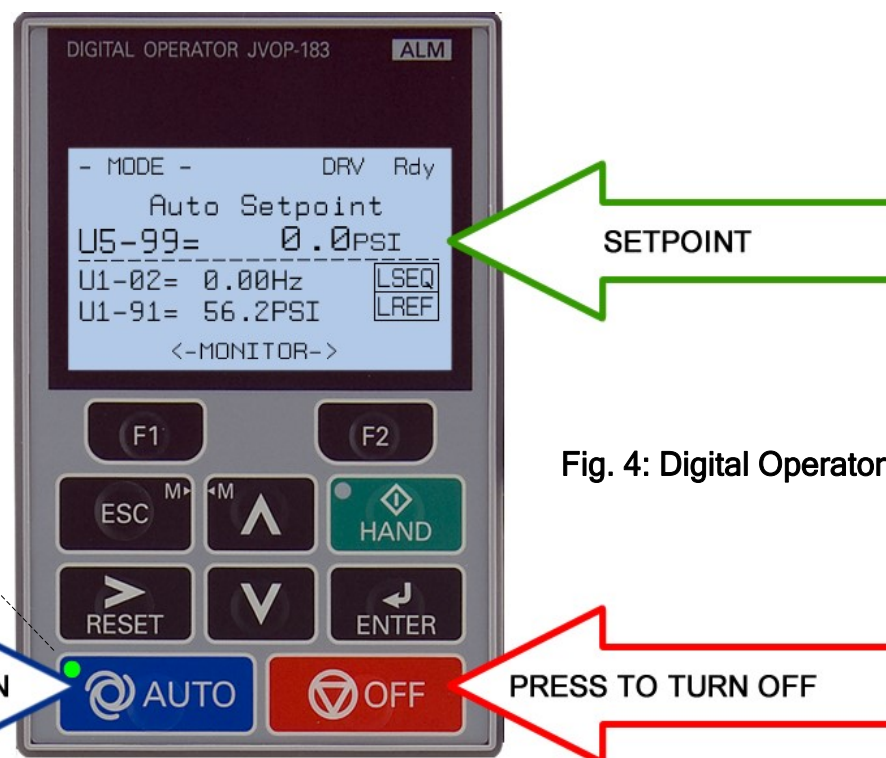

Fig. 4: Digital Operator

LED is blinking when AUTO mode is active but AUTO Run Command is not active.

PRESS AUTO BUTTON

PRESS TO TURN OFF

Press the **AUTO** button to put the iQpump into AUTO mode.

In AUTO mode the iQpump is capable of starting or stopping based on the Run Source Selection setting parameter b1-02. (See Step 3 Select Start/Stop Control Method) The setpoint used in AUTO mode is based on the Reference Source Selection setting parameter b1-01. (See Step 3 Select Speed Method)

**SET SYSTEM SETPOINT**

Next, press **ENTER** to access or modify the system setpoint that was entered using parameter Q1-01 System Setpoint in the iQpump Quick Setup Menu

Use **RESET** to select the digit and **↑** **↓** to change the system setpoint.

Next press **ENTER** to store setpoint and press **F1** to return to the main operation menu.

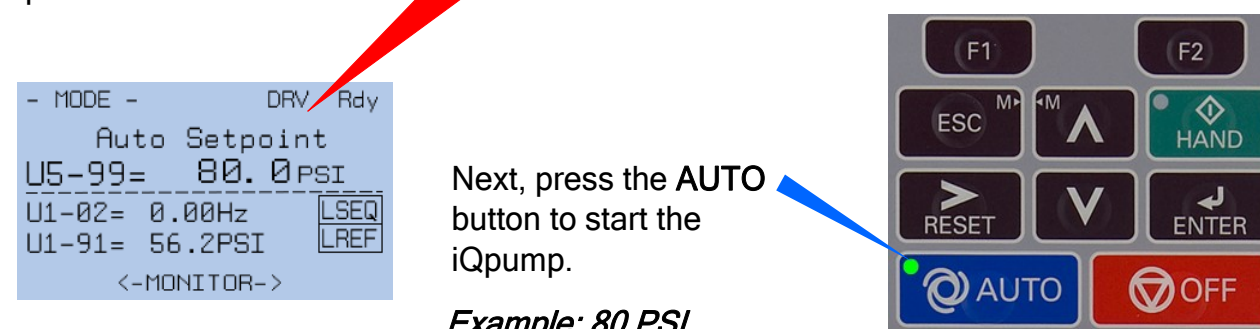

Next, press the **AUTO** button to start the iQpump.

*Example: 80 PSI*

iQpump automatically starts in Auto Mode when the feedback signal level falls below the programmed level in parameter P1-04 for the specified time in P1-05.

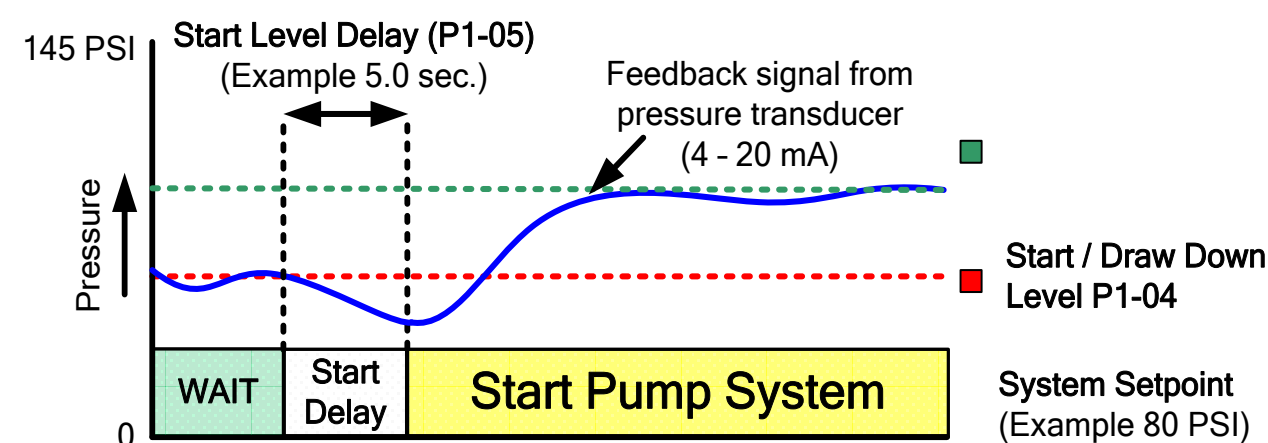

Refer to Illustration 2 on Page 3 of 4 for additional information on the Start Level Function.

**Step 10 Hand Mode Operation**

**HAND MODE**

The iQpump can be operated in HAND mode when the following actions have been performed:

- All parameters are programmed
- Motor direction has been checked

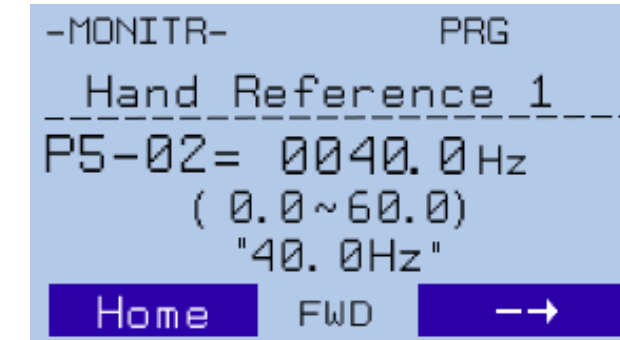
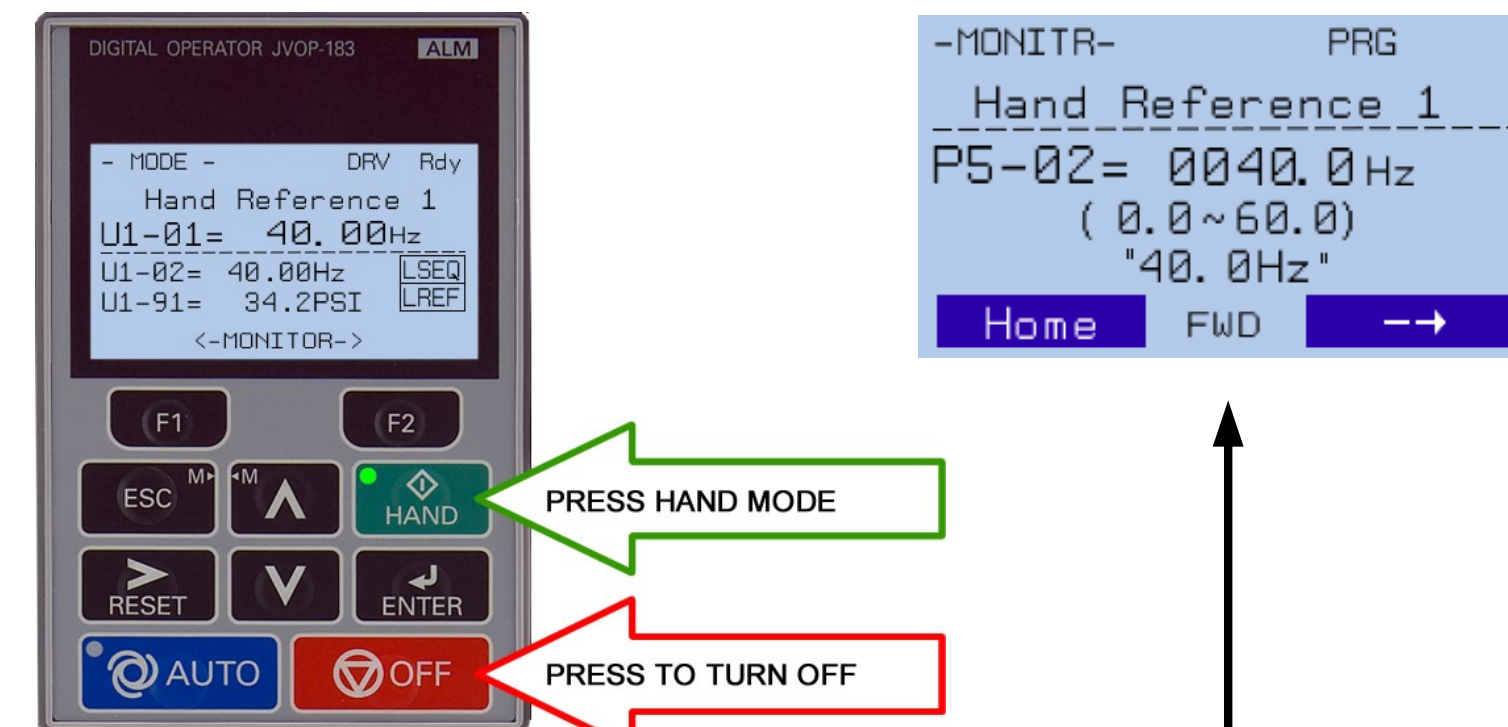

Press **ENTER** to access Hand Speed. Use **↑** **↓** **RESET** to change Hand Speed value. Press **ENTER**

to save value.

**Hand Speed from Analog Input (0 - 10V)**

Set parameter P5-01 'Hand Mode Ref.' to '0' to adjust the hand mode reference from an external 0 - 10V signal connected to terminal A3 and AC.

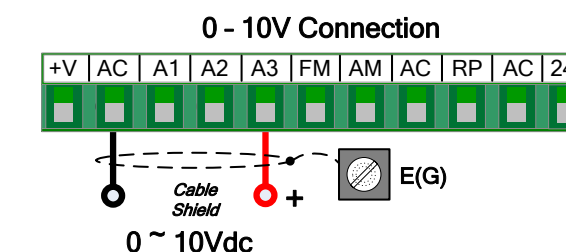

**Sleep and Anti-No-Flow (ANF) Detection** (P2-23, P2-24, P2-25)

**NOTE:** Before adjusting Anti-No-Flow operation ensure your system is regulating satisfactory while operating under normal running conditions.

If stable continue to Step 1 to verify no-flow/sleep operation. If unstable turn off the Anti-No-Flow function (P2-23 = 0.00%) and adjust the PI control parameters b5-02 and b5-03 to stabilize pump system. Refer to iQpump Quick Start Guide (Document No.TOEP YAIP1W 01) for additional information. Once the system is stable, re-enable the Anti-No-Flow function by setting P2-23 to 0.40% and continue to Step 1 to verify no-flow/sleep operation.

**Step 1:** Verify system holds pressure by creating a no-flow situation (e.g. close off discharge valve).

**Step 2:** Press OFF button on the digital operator, wait 1 min. until system stabilizes and verify system pressure feedback U1-91. If the pressure drops more than 3 PSI (U1-91) adjust P2-25 to the actual delta pressure drop plus 1 PSI.

**Example:** Setpoint is 80 PSI, pressure feedback U1-91 shows 76 PSI, P2-25 should be 4 + 1 or 5 PSI.

**Note:** This value should always be more than your start level (P1-04). If not, the system pressure is not holding and this needs to be corrected, or the pump system will continue to cycle on and off.

**Step 3:** Run system in normal automatic operation with flow. Next check monitor U1-99 "ANF Timer" and verify that the value is incrementing and resetting back to zero continuously. If the value holds at 10 sec. (P2-24) increase P2-24 "Anti-No-Flow Detection Time" by increments of 5 sec. Repeat Step 3 each time P2-24 is adjusted.

**Step 4:** Create a no-flow situation (e.g. close discharge valve) and monitor that U1-99 "ANF Timer" increments and holds at P2-24 time (value set in Step 3). Once the Anti-No-Flow timer expires the speed will reduce gradually until it reaches minimum pump speed (P1-06) where it will hold for 5 sec. (P2-03) before going to sleep.

**Step 5:** Run system in normal automatic operation and verify sleep and wake-up operation until system performs satisfactory.