

**YASKAWA**

# **INTEGRATED SOLUTIONS**

COMPLETE SOLUTIONS FOR YOUR AUTOMATION NEEDS



# INTEGRATED SOLUTIONS

## YASKAWA AMERICA, INC.

Yaskawa America, Inc. is a U.S. corporation, created to provide Automation Solutions and Support to our customers in North America, Central America, and South America. Yaskawa is the world's largest manufacturer of AC Inverter Drives, Servo and Motion Control, and Robotics Automation Systems. Products are marketed through direct sales, partners, representatives, dealers, and distributors. Yaskawa America is a wholly-owned corporation of Yaskawa Electric Corporation of Japan. Since 1915, Yaskawa Electric has served the world needs for products to improve global productivity through Automation.



## START HERE

Interested in something exceptional? Experience tells us that superior products start with a better understanding of customer needs.

That's why we take the extra time to learn more about your particular solution from the beginning. Often, this results in a product or service that performs far beyond original expectations.

Contact us today, and we'll dig into the details of your special need and begin the process of creating an engineered solution.



## THE RIGHT PRODUCTS

### Not Just Drives and Motion!

A complete automation solution requires more than just the best servomotors, drives and motion controllers in the industry.

Mechanical actuators, robotics, gearboxes, encoders, are just a few of the additional components that are required to build out a complete automation system.

Ensuring that those components work well together can make or break your next automation project, and getting those products from a single supplier simplifies and streamlines the entire process, from quoting through implementation.



Since 1915,  
Yaskawa has produced...

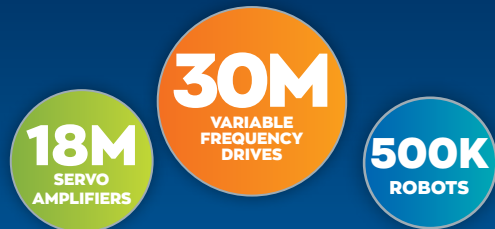

Per year, that's...

- > 40,000 ROBOTS
- > 825,000 SERVOPACKS
- > 1.12 MILLION SERVO MOTORS
- > 2.1 MILLION AC DRIVES

**30**  
Countries with  
Yaskawa sales, service  
and manufacturing  
locations

**14,800+** EMPLOYEES  
WORLD WIDE



GLOBAL SALES  
**\$4.5B**

**100+**  
YEARS  
MANUFACTURING  
EXCELLENCE

\*Based on 2021 reported sales. For reference only.



## CUSTOM ENGINEERING SERVICES

### From Blueprints to Invoices

Whether you are looking to retrofit an old control system or push the state of the art with a new design, Yaskawa's Engineered Systems team is your partner from specification and quoting, through building and testing, to post-sales support and training.

Nothing falls through the cracks; You will be supported by the same team of engineers and technicians that created the solution.

CUSTOM SOLUTIONS FOR CUSTOMER NEEDS

# ENGINEERED SERVICES GROUP

Our experts in automation and motion control are ready to design and build whatever is necessary to make new automation ideas possible.

Yaskawa is known for creating exceptional motion automation components. It is only natural to back up this reputation with an exceptional ability to help customers put them to use. Our capabilities range from custom enclosures, panels, and cables to complete retrofits and electromechanical assemblies.



## CONTROL SYSTEMS

### Equipped to Handle Every Facet of Automated Systems

Our A-to-Z capability includes development of mechanical systems and control architecture, panel design, wiring, mechanical design and assembly ...all the way to shipping, stocking and fulfillment.

Whether you are looking to outsource some or all of the control system manufacturing for a new machine design or seeking a turnkey retrofit of existing equipment, Yaskawa Engineered Systems Group is your one stop for integration of the best automation products in the industry.



## CUSTOM CABLES



### Plug and Play Cables for any Equipment!

Yaskawa Engineered Systems Group can provide everything from connectors and raw wire to complete wiring harness.

- Custom lengths
- Complete harnesses
- Connector installations
- Armored and special specification cables
- Conduit
- JIT / Stocking program

## CUSTOM ENCLOSURES AND PANELS

### Custom without Complexity

Every aspect of control enclosure manufacturing is covered by Engineered Systems, from design and component selection to cabinet manufacturing, wiring and preparation for final installation.

Combine top quality Yaskawa control components, with hardware, cabinetry and connectors to match. Enjoy Yaskawa performance without the complexity of panel design.



STEPPER MOTORS

# APPLIED MOTION PRODUCTS

Standalone and Integrated Drive Stepper Motors



## CLOSED LOOP INTEGRATED MOTORS



### Motor, Drive, and Control - All-in-One

Integrated steppers combine a high performance drive with a robust motor into a single package.

The space-saving design means reduced system cost and less panel space required per axis.

No wiring between the drive and motor saves cost and allows motors to be more easily mounted all over the machine, while the IP65 rating means they can withstand wet and dusty environments. EtherNet/IP and Modbus TCP interfaces permit integration into a wide variety of machine designs.



## FASTER AND MORE ACCURATE STEP MOTORS WITH HIGH EFFICIENCY AND TORQUE

StepSERVO™ closed-loop stepper products offer up to 50% more torque than traditional stepper motors due to their peak torque capacity, while only drawing the current they need to move the load. This increased torque allows you to accelerate faster with less heat.

High-resolution encoders and closed-loop servo control ensure higher overall system accuracy.



EtherNet/IP™ Modbus

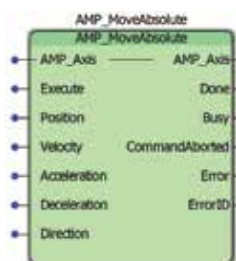

Yaskawa function blocks for MPIec controller

## STEPPER MOTORS AND DRIVES

### Stand-Alone Stepper Motors and Drives

Stand-alone stepper motors and drives offer the same performance as the integrated motors, but with a traditional architecture.

The IP65 rating means the motors can withstand wet and dusty environments, and can fit into even tighter spaces since the drive is mounted remotely in an electrical enclosure. EtherNet/IP and Modbus TCP interfaces permit integration into a wide variety of machine designs.



## ACTUATORS

# MACRON DYNAMICS

Actuators and Gantry Assemblies



## LINEAR ROBOTICS

### T-Bot and H-Bot Gantry Systems

- High speed Cartesian motion systems ideal for pick and place
- Fixed motors reduce moving mass and increase speed
- Two servomotors connected to a single belt drive both axes of motion
- H-Bot systems can be combined with a belt or screw actuator to add a 3rd axis
- Optional theta axis available
- Gantry systems include cable track, reducers, torque tubes, and sensors

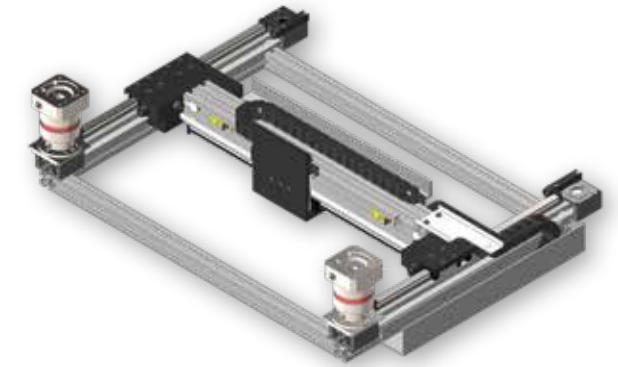

## BELT AND SCREW ACTUATORS

### Mechanical Solutions for Linear Motion

- Linear actuators designed for servo applications
- High speed, accuracy, and reliability
- Belt actuators are capable of very long travel
- Screw actuators provide exceptional positional accuracy
- Designed for either horizontal or vertical motion
- Single-axis and multi-axis configurations available
- Sanitary stainless steel models are cleanable and corrosion resistant



MACRON DYNAMICS, INC.

## ACTUATORS AND MECHANICAL SYSTEMS SINCE 1988

Macron Dynamics, Inc., manufactures linear and mechanical motion components and systems for applications across the globe. For over 30 years, Macron has refined each component and every product through time-tested installations and experience. Macron products are built with the highest quality materials, assembled in the USA, and engineered to withstand the abuses of rigorous, daily usage. The result is a combination of versatility, positioning repeatability durability, and virtually maintenance-free operation.

## ROBOTIC TRANSFER UNITS

### Add 7th Axis Capability to Robotic Systems

- Novel, flexible belt based "rack and pinion" design
- Aluminum extrusion frame for easy mounting
- Wide range of sizes and payload capacities available



# AUTONOX ROBOTICS

Controller-Independent Robot Mechanics



## UNIQUE MECHANICAL SOLUTIONS THAT ADD VALUE TO ROBOT PROJECTS WORLDWIDE

autonox Robotics specializes in the development and production of robot mechanics for mechanical engineers and robot integrators interested in an end to end control platform. With highly motivated experts, an extensively equipped robot development laboratory, and two application centers in Europe and North America, autonox supports Yaskawa to provide a complete solution.

The combination of autonox robot mechanics with Yaskawa servo motors, SERVOPACKs, and machine controllers offers the largest possible range of robot structures, degrees of freedom, payloads, working ranges and options to select.

## PARALLEL KINEMATICS

With parallel kinematics, all axis drives have a direct mechanical connection to the tool carrier and engage simultaneously/in parallel in the movement of the end effector. It is a closed, kinematic chain.

### DUOPOD

- Field of Application: Standard / Hygienic
- Degrees of Freedom (DoF): 2 to 4
- Nominal Payload: 3 to 150 kg
- Working area: 200 - 1,400 mm



### DELTA

- Field of Application: Standard / Hygienic
- Degrees of Freedom (DoF): 3 to 5
- Nominal Payload: 0.5 to 50 kg
- Working area: 200 - 2,000 mm



## HYGIENIC DESIGN (HHD) DELTA

Careful consideration given to holistic hygienic principles like:

- High pressure cleaning up to 28 bar, IP69K compliant, resistant to most chemicals
- FDA compliant materials without coatings or paint (e.g. 316L stainless steel, titanium, PEEK plastic)
- No joints, edges or gaps
- Sealed roller bearing joints eliminate wear of friction bearing joints, increasing performance and eliminating particulate contamination from friction bearings
- Limited surface temperature in motor area
- Superior repeatability and accuracy

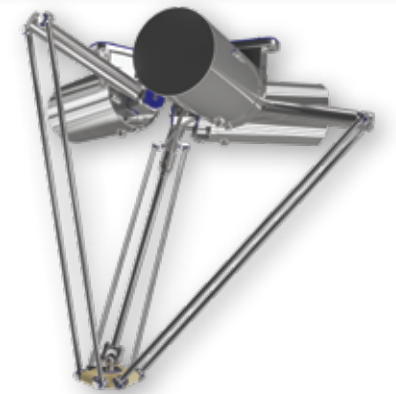

## lean line

autonox lean line mechanics are characterized by their attractive pricing.



### LEAN LINE DELTA

- Nominal payload is limited
- Average performance is reduced compared to classic autonox mechanics
- Available without a head plate
- Direct connection of gearbox support to machine frame reduces overall height
- Robots are delivered in pre-assembled main assemblies to save space



### LEAN LINE HYGIENIC DESIGN (HND) DELTA

- Mechanics partly made of materials not approved for the food industry (e.g. carbon fiber tubes, non-corrosion resistant steels, aluminum alloys)
- Surfaces provided with FDA-compliant, cleanable coating
- Lubricants approved for the food industry are used

# NIDEC-SHIMPO

Gear Reducers and Rack & Pinion Systems



## PLANETARY GEARBOXES

### Widest Range of Inline and Right-Angle Solutions

- High precision design originally developed for robotics
- Helical gears for 40% higher tooth contact area
- One-piece output shaft and planet carrier
- One-piece input coupling and sun gear
- Two bearings per planet gear increase stiffness and torque capacity
- Ring gear machined directly into the housing for greater concentricity
- Labyrinth seals for IP65 protection



## RIGHT ANGLE GEARBOXES

### High Precision Hypoid, Worm, and Bevel Units

- Compact, torque dense options
- Zero backlash options available
- Wide range of output mounting configurations
- Standard reduction ratios up to 100:1
- Smooth, quiet gearing solutions capable of high input speeds
- Maintenance-free, lubricated for life



NIDEC-SHIMPO CORPORATION

### LEADING SUPPLIER OF PRECISION GEARING

Nidec-Shimpo manufactures a wide range of precision gearing technologies, including planetary, strain wave, cycloidal, hypoid, bevel and worm solutions. Nidec-Shimpo ships over 100,000 gearheads per month out of manufacturing plants in Kyoto, Shanghai, Philippines and Germany. These products are used in robotics, machine tools, food packaging, printing, paper converting, material handling, medical, semiconductor and aerospace systems. The diverse product portfolio, state-of-the-art equipment, engineering knowhow and manufacturing scale allow customers to compete and expand their businesses globally.

## RACK & PINION SYSTEMS

### Completely Integrated Linear Drive Systems

- Induction hardened and ground quality 6 racks
- Backlash as low as 0.03  $\mu\text{m}$
- 23 gear ratios from 3:1 up to 100:1
- Wide range of frame sizes from 70 to 200 mm
- Designed for plasma, waterjet, routers, material handling, and gantry systems



# DIEQUA CORPORATION

Motion Control and Power Transmission Components



## CYCLOIDAL REDUCERS

True Zero-Backlash for Precision Applications

- Zero backlash
- High kinematic accuracy and ultra-low lost motion
- Cross roller bearings
- High bending moment and radial and axial stiffness
- ISO 9409 robotic output flanges



## DECADES OF POWER TRANSMISSION EXPERIENCE

Founded in 1980 by Dietmar Quaas, and now owned by his sons, DieQua Corporation has expanded from a single product line to become a leading manufacturer and supplier of an extensive line of high-quality power transmission and precision motion control products, including gearboxes, servo gearheads, screw jack systems, speed reducers, cycloidal reducers and connecting components. The company also offers custom product modifications and complete design solutions for virtually any application.



## HELICAL SPEED REDUCERS

Speed Reducers for Induction Motors

- Helical bevel, helical worm, and inline helical models
- Class 12 helical and spiral bevel gears for high efficiency, greater torque, and smaller size
- Multiple input and output options
- UNIBLOCK housing
- Sealed for washdown
- NEMA and IEC adapters
- Gearmotor combinations available



# FAGOR AUTOMATION

Optical Linear Encoders

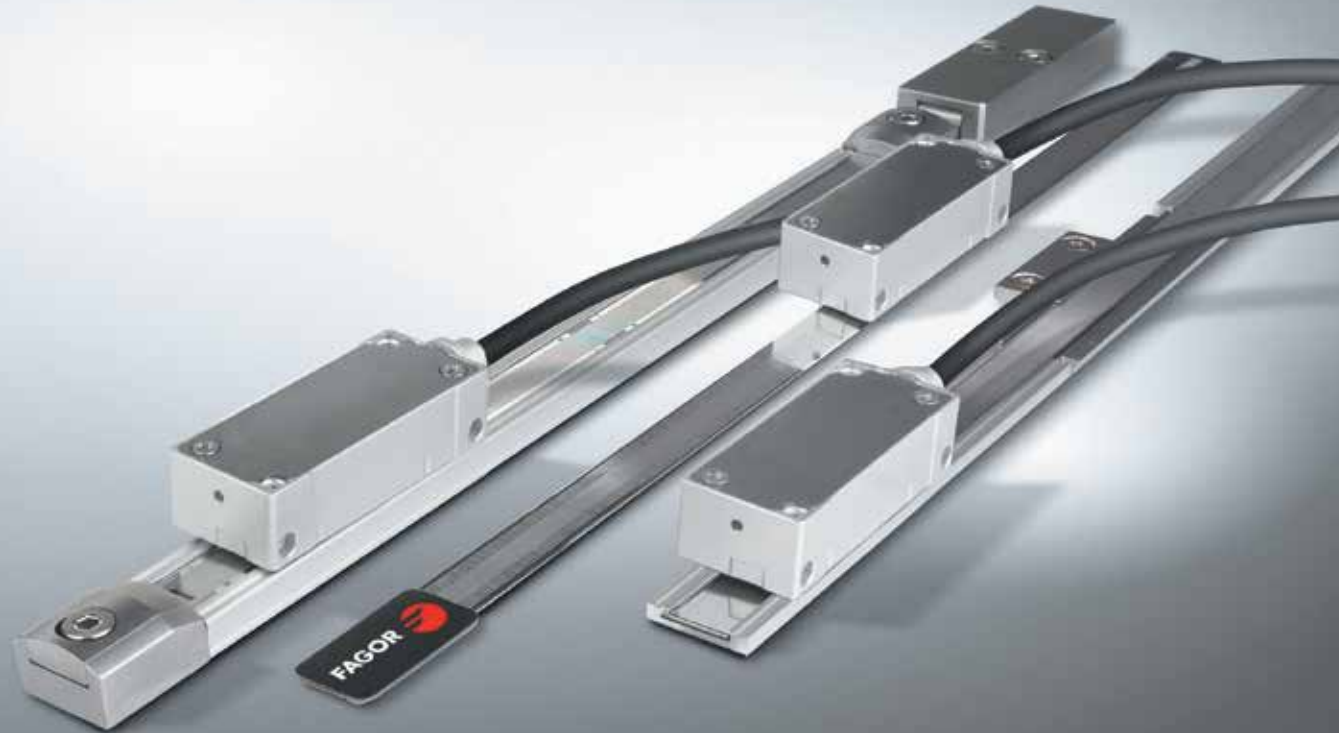

## EXA SERIES

### Designed for High Speed, High Accuracy

The EXA series non-contact open linear encoder consists of a compact reader head with all the electronics and optics integrated into a single body that may be mounted from the side or from the top. It has an LED to help with alignment and includes a 1 or 3 meter cable with a connector, and a 10 mm wide adhesive reflective stainless steel tape that is highly resistant to solvents. The connector can connect directly to a Sigma-V or Sigma-7 SERVOPACK, and extension cables are available to extend the length to up to 50m.



Characteristics	
Steel tape thermal expansion coefficient	$\alpha_{\text{therm}} \approx 11 \text{ ppm/K.}$
Measuring resolution	0.009765625 $\mu\text{m}$ / 0.078125 $\mu\text{m}$
Maximum speed	480 m/min
Maximum cable length	50 m
Supply voltage	5V $\pm$ 10%. < 250 mA (without load)
Reader head	1 or 3 meter cable with a connector
Reader head protection	IP 40
Accuracy	$\pm 10 \mu\text{m/m}$
Maximum vibration	200 m/s <sup>2</sup> (55 to 2000 Hz) IEC 60068-2-6
Maximum shock	1000 m/s <sup>2</sup> (11 ms) IEC 60068-2-27
Operating temperature	0°C to 50°C
Storage temperature	-20°C to 70°C
Weight	0.17 kg + 0.025 kg/m
Relative humidity	20 to 80%

**FAGOR**  
FAGOR AUTOMATION

### 35 YEARS OF ENCODER EXPERIENCE

Fagor Automation has been manufacturing high quality linear and rotary encoders using precision optical technology for more than 35 years. The absolute optical linear encoder is a direct digital measure of machine position. It is fast, accurate and does not require homing of the machine. The position value is available from the moment the machine is turned on and may be requested by the connected device (SERVOPACK or controller) at any time.

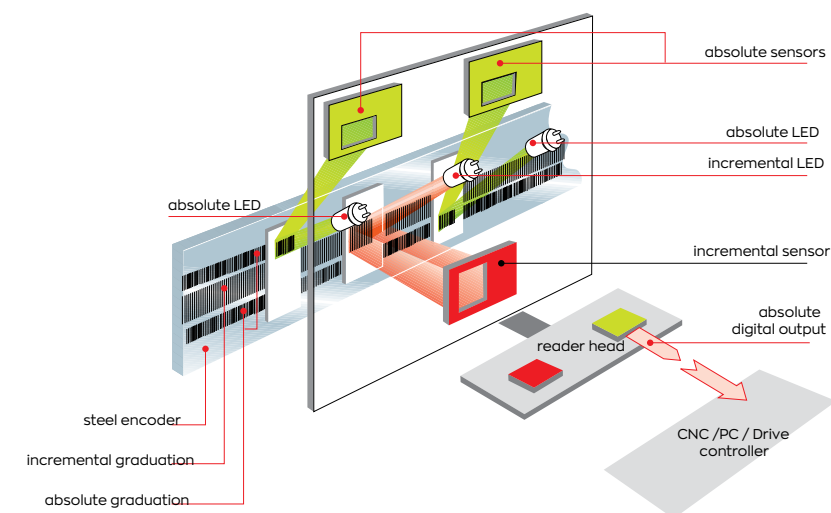

Fagor's non-contact open absolute linear encoders use the auto imaging principle, which uses diffuse light reflected from the graduated steel tape. The reading system consists of an LED as the light source of the linear encoder, a reticule that makes the image, and a monolithic photo detector element in the plane of the image, designed and patented by Fagor Automation.

ENCODERS

# MITUTOYO

## Electromagnetic Induction Linear Encoders

**ABSOLUTE**<sup>®</sup>

Absolute System Patented by MITUTOYO



**Mitutoyo**



**WORLD'S LARGEST METROLOGY COMPANY**

Mitutoyo was founded in 1934 by Yehan Numata with one product - the micrometer. Mitutoyo's philosophy at that time was to make the best mechanical micrometer in the world. As electronic technology became more widespread in the 70s, Mitutoyo applied electronics to its line of dimensional gaging equipment to include digital measuring tools. Mitutoyo America Corporation has provided sales, marketing, and most importantly, service in the United States since 1963.

### ST700 SERIES

#### Unaffected by Contamination

Electromagnetic induction linear encoders have a high resistance to oil, water, and other contaminants that would interfere with an optical encoder. The ST700 series encoders use an exciter coil and a detector coil in the sensor head, each facing a number of scale coils precisely spaced on the scale.

A current is sent through the exciter coil, creating a magnetic flux that induces a current in the facing scale coil. The magnetic flux created in turn induces a current in the facing detector coil. The degree of inductive coupling between the coils changes according to the displacement of the sensor, creating a sinusoidal signal with a cycle that corresponds to the pitch of the scale coils. Interpolation (division) of this sinusoidal signal creates high resolution position data.

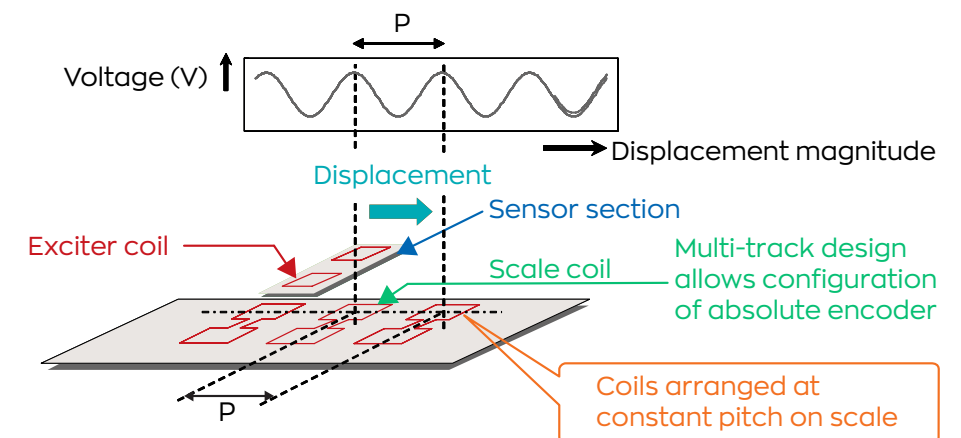

**Mitutoyo electromagnetic induction type sensors have excellent water resistance and oil resistance.**

Characteristics		
Resolution		0.1 μm (0.05 μm: special order)
Detection method		Electromagnetic induction absolute position detection
Effective range		100 to 3000 mm
Accuracy (20°C)		(5 + 5L/1000) μm L: Effective range mm
Maximum feed speed		5 m/s
Operating conditions	Temperature	(12.0 ± 1.5) × 10 <sup>-6</sup> / °C (when attached to material equivalent to steel)
	Humidity	0 to 50°C
Storage conditions	Temperature	-20 to 70°C
	Humidity	20 to 80% RH
Vibration resistance		300 m/s <sup>2</sup> (55 to 2000 Hz)
Shock resistance		500 m/s <sup>2</sup> (half-sine, 11 ms)
Head cable	Length/Cable diameter	1 m / φ3.8 mm (high-flex cable)
	Connector	D-sub (9-pin socket type) connector (not waterproof): for ST788A
Maximum signal cable length		Up to 29 m (head cable length included). Please consult user manual
Detector mounting		1 location each on top and sides
Direction of cable outlet		4 sides (top, bottom, left, right) can be selected
EMC standard		CE mark standard

YASKAWA.COM



Yaskawa is the leading global manufacturer of low and medium voltage variable frequency drives, servo systems, machine controllers and industrial robots. Our standard products, as well as tailor-made solutions, are well known and have a high reputation for outstanding quality and reliability.

# YASKAWA

**Yaskawa America, Inc.** | Drives & Motion Division

1-800-YASKAWA | Email: [info@yaskawa.com](mailto:info@yaskawa.com) | [yaskawa.com](http://yaskawa.com)

Document No. BL.YAI.23 | 02/27/2024 | © 2021 Yaskawa America, Inc.