

MACHINE CONTROLLER CP-9200SH/SVB
MOTION CONTROLLER
USER'S MANUAL

MECHATROLINK-COMPATIBLE TYPE

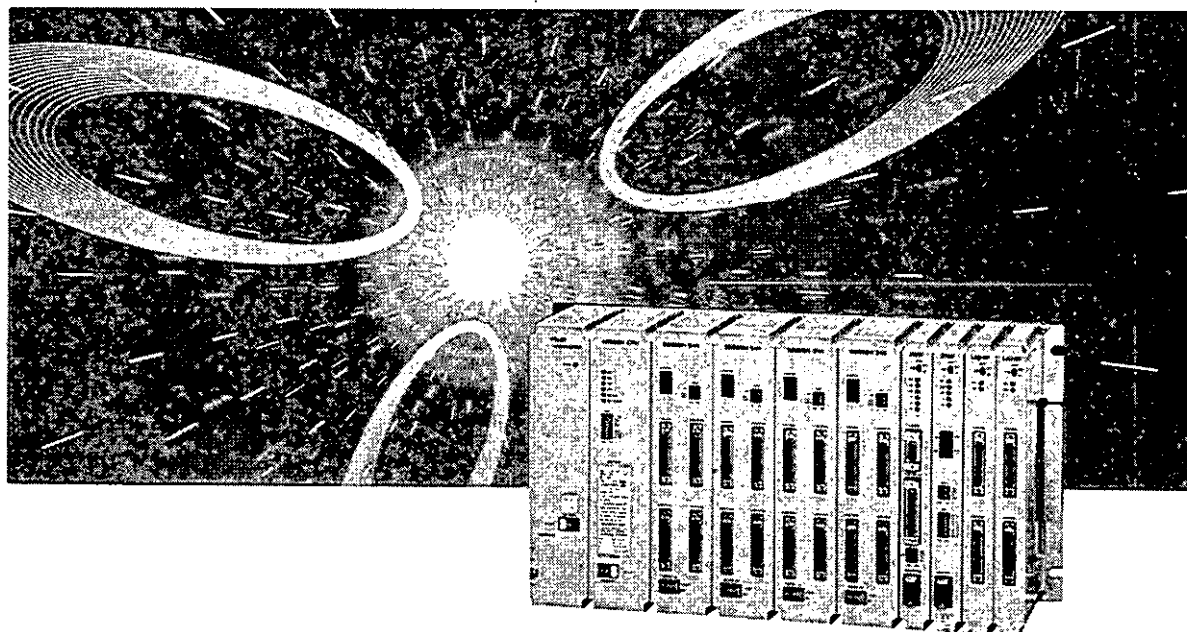

This manual describes the motion control module (SVB module), one of the modules of Machine Controller CP-9200SH (hereafter called "CP-9200SH").

The SVB module can be connected with servos and I/Os by means of high-speed field network MECHATROLINK (hereafter called "MECHATROLINK") and with CP-216 transmission-capable inverters (VS-616G5, VS-676H5) by means of CP-216 transmission. The number of connected stations is dependent on the parameter setting and slave equipment.

This manual describes the software of the SVB module (basic specifications, functions, examples of user programs, and motion parameters).

For the hardware of the SVB module (outside drawing, indicator lamps, setting switches, and connectors), refer to the Machine Controller CP-9200SH User's Manual (SIE-C879-40.1).

The CP-717, which is described in the document, refers to the Control Pack CP-717 (hereafter called "CP-717"), one of the peripheral units of CP-9200SH.

Refer to the following CP-9200SH-related documents.

< Relevant manuals >

Manual No.	Manual name
SIE-C873-16.4	FDS System Installation Manual
SIE-C877-17.4	Control Pack CP-717 Operation Manual Vol.1
SIE-C877-17.5	Control Pack CP-717 Operation Manual Vol.2
TOE-C877-17.7	Control Pack CP-717 Instructions
CHE-C879-40	Ultra-high Speed Machine Controller CP-9200SH
KAE-C879-40	Super-high Speed Machine Controller CP-9200SH
SIE-C879-40.1	Machine Controller CP-9200SH User's Manual
SIE-C879-40.3	Machine Controller CP-9200SH Programming Manual
SIE-C879-40.4	Machine Controller CP-9200SH/PO-01Motion Controller User's Manual

- ◆ Windows 95 and Windows NT4.0 are trademarks of Microsoft corporation, USA.
- ◆ Ethernet is a registered trademark of Xerox USA Corp.

SAFETY PRECAUTIONS

- For correct use, be sure to read the Instruction and Maintenance Manuals, this supplementary manual, and other attached documents thoroughly before use (installation, operation, maintenance, inspection, etc.). Also, be sure to use the equipment only after acquiring a thorough knowledge of the equipment, safety information, and all precautions. Be sure to store the documents in a place where they may be readily available for anyone using the device.
- "Safety Symbols" Used in this Manual
In this manual, the following symbols are used according to the descriptions on safety.



WARNING

- Warning

Indicates cases where erroneous handling may lead to a dangerous situation involving serious injury or death.



CAUTION

- Caution

Indicates cases where erroneous handling may lead to a dangerous situation involving light or medium injury or material damage.



PROHIBITED

- Prohibited

Indicates prohibited actions which may otherwise lead to serious consequences.



MANDATORY

- Mandatory

Indicates that grounding must be provided.

- In this manual, matters that do not correspond to "WARNING" or "CAUTION" should be adhered to by the user and are indicated next to the relevant items.

1 INSTALLATION

**WARNING**

- Be sure to perform installation and removal after turning OFF the power.
There is danger of electric shock, serious injury, or death if work is performed with the power ON.

**CAUTION**

- Use this product in an environment described in the Machine Controller CP-9200SH User's Manual (SIE-C879-40.1).
Electric shock, fire, or malfunction may occur if this product is used in an environment with high temperature, high humidity, dust, corrosive gas, vibration, or shock.
Specifically, avoid use in the following environments.
 - Places exposed to direct sunlight or places where the ambient temperature falls outside the range, 0 to +55°C.
 - Places where the relative humidity falls outside the range of 5 to 95%, and places where dew condensation may occur due to sudden changes in humidity.
 - Places with corrosive gas or flammable gas.
 - Places where vibration or shock may be transmitted directly to CP-9200SH.
 - Places where this product may get splashed with water, oil, chemicals, etc.
- This product should be installed in accordance with the instructions described in the Instruction Manual.
Improper installation may cause an accidental fall, failure, or malfunction.

① Fasten mounting screws securely

Be sure to securely fasten the mounting screws for CP-9200SH and the fixing screws for terminal blocks so as not to allow them to loosen.
A loose screw may result in the malfunction of the CP-9200SH.

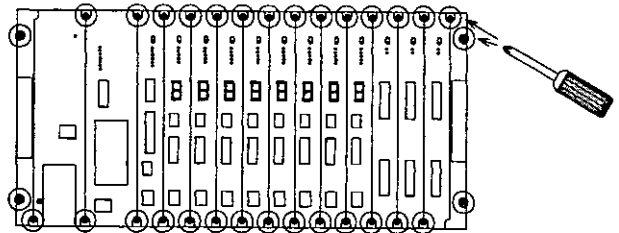

② Install this product correctly.

Incorrect installation may lead to abnormal heat generation and failure.

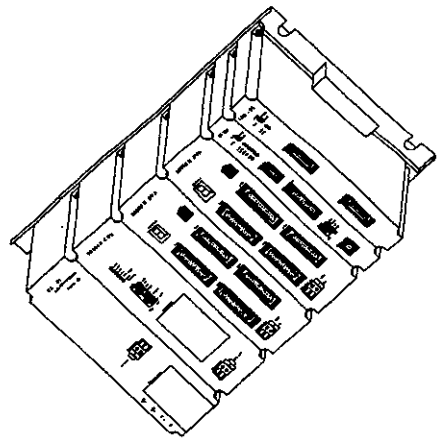
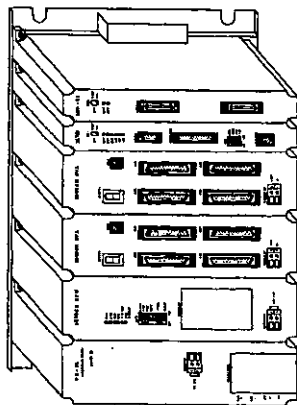
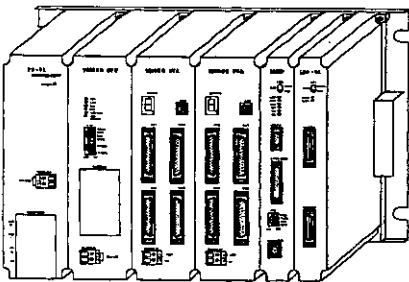

- Do not put foreign matter such as wire strips into the unit.
Such matter may cause fire, failure, or malfunction.

2 WIRING

⚠ CAUTION

- Connect the power supply conforming to the rated power.
Connecting a power source not conforming to the rated power may cause fire.

CP-9200SH supply voltage

For the PS-01 power supply
85 VAC to 132 VAC
or 90 VDC to 140 VDC

For the PS-02 power supply
170 VAC to 230 VAC

For the PS-03 power supply
19.2 VDC to 28.8 VDC

- Only qualified personnel should be allowed to work with wiring with the manual.
Improper wiring may cause electric shock, failure, or fire.

CONNECT THE INTERFACE SECURELY!

- Insert and fix the connectors of the various interface cables to be connected to CP-9200SH securely.

WHAT SHOULD BE DONE WHEN POWER SUPPLY IS UNSTABLE?

- When power supply is unstable, connect a line filter to the power supply line.
This will prevent malfunction of the CP-9200SH as a result of noise.

When PS-01 is used.

PS-01
(100 VAC, or 100 VDC)

When PS-02 is used.

PS-02 (200 VAC)

When PS-03 is used.

PS-03 (24 VDC)

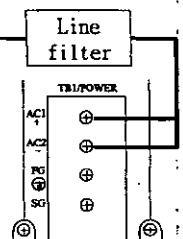

LAY THE EXTERNAL WIRING CORRECTLY.

- Select the I/O lines (external wiring) for connecting CP-9200SH with external equipment in consideration of the following.

- Mechanical strength
- Influence of noise
- Wiring distance
- Signal voltage, etc.

Lay and wire I/O lines apart from power lines at the interior and exterior of the control panel.

This will help in reducing the influence of noise.

(Wire rack)

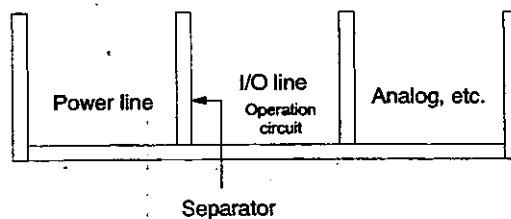

3 PRECAUTIONS UPON USE

**WARNING**

- Do not touch the terminals while the power is ON.
There is danger of electric shock.
- Provide an emergency stop circuit, interlock circuit, etc., at the exterior of CP-9200SH.

When it is anticipated that a failure of the CP-9200SH may cause operators to be hurt or products or peripheral units to be damaged, incorporate an emergency stop circuit or interlock circuit outside the CP-9200SH.

To start up the CP-9200SH by connecting a machine, make sure that the CP-9200SH can be stopped at any time for an emergency.

(Example)

Use relays having high contact reliability.

Use our Bestact relay or its equivalent, or low-level relay with two-point grounding parallel connection.

Provide limit switches before the limit points on both sides of the machine.

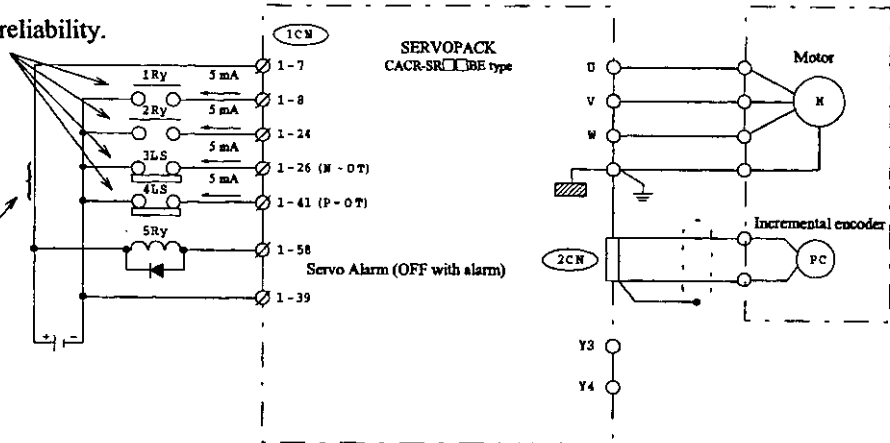
**CAUTION**

- Changing the program, performing forced output, and performing operations such as RUN, STOP, etc., while CP-9200SH is running may cause program errors and operation errors which may lead to machine damage or to accidents.

Perform these upon adequate verification and with the utmost care.

**CAUTION**

- Turn ON the power in proper order.
An erroneous order may lead to machine damage or an accident.

Turn ON the power of the SERVOPACK first!

First, turn ON the power of the SERVOPACK.

If CP-9200SH is started in advance, the system may malfunction or be damaged due to delays in input-output signals of the SERVOPACK.

Turn ON the power of the SERVOPACK simultaneously or in advance of the CP-9200SH.

4 MAINTENANCE AND DISPOSAL

WARNING

- Connect plus ⊕ and minus ⊖ poles of the battery correctly.
Do not charge, disassemble, heat up, throw into fire, or short-circuit the battery.
There is danger of explosion or fire.

CAUTION

- Handle the product as industrial waste upon disposal.

PROHIBITED

- Do not disassemble or modify.
There is danger of fire, failure, or malfunction.

PAY ATTENTION TO THE BATTERY LIFE.

- Pay attention to the battery life.
Lighting of the Battery Alarm lamp indicates the end of a battery's life. Replace with a new battery following the battery replacement procedure.

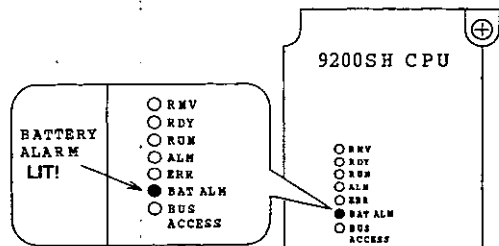

5 GENERAL PRECAUTIONS

PRECAUTIONS ON APPLICATION

- CP-9200SH is not designated or manufactured for use in devices or systems that concern people's lives. Users who intend to use the product described in this manual for special purposes such as for devices or systems relating to transportation, medical, space aviation, atomic power control, or underwater use must contact your Yaskawa representative beforehand.
- This product has been manufactured under strict quality control guidelines. However, if this product is to be installed in any location in which a failure of CP-9200SH involves a life and death situation or in a facility where failure may cause a serious accident, safety devices **MUST** be installed to minimize the likelihood of any accident.

1. OUTLINE	1-1
1.1 System Configuration.....	1-2
1.1.1 Configuration of CP-9200SH	1-2
1.2 How to Run the SVB Module	1-6
1.2.1 Setting the Module No.....	1-10
1.2.2 MECHATROLINK Assignment.....	1-11
1.2.3 Setting Motion Fixed Parameters	1-18
1.2.4 Setting Initial Values of Motion Setting Parameters.....	1-19
1.2.5 Setting SERVOPACK Parameters.....	1-20
1.2.6 Monitoring Running Status (Control Data).....	1-21
1.3 Module No. and Motion Parameter Register No.....	1-23
1.4 Outlines of functions	1-25
1.4.1 Outlines of motion commands	1-25
1.5 Hot Swapping.....	1-27
1.6 Precautions on Usage.....	1-28
2 BASIC SPECIFICATIONS.....	2-2
3 FUNCTIONAL DESCRIPTIONS AND EXAMPLES OF USER PROGRAMS	3-1
3.1 Setting Basic Motion Parameters	3-2
(1) Reference units	3-2
(2) Electronic gear.....	3-2
(3) Axis selection	3-5
(4) Position references.....	3-5
(5) Position monitoring	3-8
(6) Speed references.....	3-9
3.2 Positioning	3-11
3.3 External Positioning (EX_POSING).....	3-14
3.4 Zero Point Return.....	3-17
3.4.1 DEC + Phase-C Pulse	3-17
3.4.2 ZERO Signal.....	3-17
3.4.3 DEC + ZERO signal	3-18
3.4.4 Phase-C Pulse	3-18
3.4.5 An Example of Zero Point Return Methods	3-19
3.5 Interpolation (INTERPOLATE)	3-23
3.6 Interpolation with Position Detecting Function (LATCH).....	3-24
3.7 Constant Speed Feed (FEED)	3-25
3.8 Constant Step Feed (STEP).....	3-27
3.9 Zero Point Setting (ZSET)	3-30
4 I/O AND INVERTER	4-1
4.1 I/O and Inverter.....	4-2
4.2 Setting Transmission Parameters	4-3
4.2.1 The Number of Connectable Slave Stations	4-4
4.3 Setting I/O Assignment	4-6
4.4 Types of Messages.....	4-7
4.5 Control Data Configuration.....	4-8
(1) RIO-01, RIO-06.....	4-8
(2) Inverter	4-8
(3) MP930 I/O unit.....	4-8
(4) Absocoder.....	4-8
4.6 Control Command/Response Data	4-9
4.7 VS-616G5 Inverter Connection Example	4-13
4.7.1 Prepared Items and Startup Procedure.....	4-13
4.7.2 216IF/G5 Module Specifications.....	4-13
4.7.3 Mounting Procedure	4-15
4.7.4 Wiring.....	4-17
4.7.5 VS-616G5 Constant Settings.....	4-19
4.7.6 MECHATROLINK Definitions.....	4-21
4.7.7 Creating a Ladder Logic Program	4-22
5 MOTION PARAMETERS	5-1

5.1 List of Motion Parameters.....	5-
5.1.1 List of Motion Fixed Parameters	5-
5.1.2 List of Motion Setting Parameters	5-
5.1.3 List of Motion Monitoring Parameters	5-1
5.2 Details of Motion Parameters.....	5-1
5.2.1 Details of Motion Fixed Parameters	5-1
5.2.2 Details of Motion Setting Parameters	5-1
5.2.3 Details of Motion Monitoring Parameters	5-2
5.3 Examples of Motion Parameter Settings.....	5-3
5.3.1 Examples of Motion Fixed Parameter Settings.....	5-3
5.3.2 Examples of Motion Setting Parameter Settings.....	5-3
5.4 User Constants of MECHATROLINK Servo SGD-□□□N	5-4
6 ABSOLUTE VALUE DETECTION.....	6-
6.1 Mechanism of the absolute value detecting function.....	6-
6.1.1 Outline of the function.....	6-
6.1.2 Mechanism of the absolute position detection	6-
6.2 Start-up of the absolute value detecting function	6-
6.2.1 Procedure for starting up the system.....	6-
6.2.2 Setting the related parameters.....	6-
6.2.3 Initialization of the absolute encoder.....	6-
6.3 How to use the absolute encoder.....	6-
6.3.1 Using on a finite-length axis	6-
6.3.2 When using on an infinite-length axis.....	6-1
7 THROUGH COMMAND MODE.....	7-
7.1 Through command mode	7-
7.2 Motion parameters to be used when the through command mode is selected	7-
7.2.1 Motion fixed parameter	7-
7.2.2 Motion setting parameters	7-
7.2.3 Motion monitoring parameters	7-
7.3 Unusable MECHATROLINK commands.....	7-
7.4 Processes that are performed by the system on MECHATROLINK communications.....	7-
7.4.1 Connection control	7-
7.4.2 Watchdog timer process	7-
7.4.3 Interpolation issuing segment distribution.....	7-
7.5 Precautions.....	7-

1 OUTLINE

This chapter describes the system configuration diagram, the operating method, and the outline of units.

Be sure to read through this chapter as it provides the basis for using the module.

1.1 System Configuration

The CP-9200SH is an integrated controller provided with all general functions required for a machine controller.

Using the user programs allows users to freely design sequences suitable for machines or motion control.

The CP-9200SH consists of the following modules. Refer to the Machine Controller CP-9200SH User's Manual (SIE-C879-40.1) for details of each module.

1.1.1 Configuration of CP-9200SH

- ◆ **Power supply module**

Available for 24 V, 100 V, 200 V.

- ◆ **Mounting base**

A short mounting base and long mounting base are available.

Up to 4 mounting bases can be connected.

- ◆ **CPU Module**

Up to 24 CPU modules can be mounted. Each of them executes user programs independently.

- ◆ **Motion module**

There are three types of modules: SVA module of the analog output type, PO-01 module of the pulse-train output type, and SVB module of the MECHATROLINK compatible digital output type (this module). Up to 16 motion modules, including all types, can be connected.

The SVB module has position control functions such as positioning, zero point return, interpolation, constant speed feed and constant step feed, and can be connected with MECHATROLINK compatible servo drivers and I/Os up to 14 axes. Up to 16 modules (module No. = 1 to 16) can be mounted, which can control up to 224 axes.

It can also be connected with CP-216 transmission-capable inverters (CVS-616GS, VS-676HS) by means of CP-216 transmission.

The SVA module can perform position control, speed control, torque control and phase control independently on each axis. Up to 11 SVA modules (module No. = 1 to 11) can be mounted, which can control up to 64 axes.

The PO-01 module has position control functions such as positioning, zero point return, interpolation, constant speed feed and constant step feed, and can be connected with pulse motor drivers up to 4 axes. Up to 16 modules (module No. = 1 to 16) can be mounted, which can control up to 64 axes.

- ◆ **Communication module**

Various interface modules such as the CP-215 interface module, CP-216 interface module, and RS-232 interface module are available. The CP-717 is connected to the RS-232 interface module or CP-215 interface module.

- ◆ **I/O modules**

Can be connected with the local I/O and the 2000 series I/O modules.

- ◆ **Others**

A module for connecting between mounting bases is also available.

Table 1.1 Descriptions of register types

Register Type	Description
SW (System register)	Holds the operating status of the system or error information.
IW (Input register) OW (Output register)	The I/O register directly connected to the hardware which is accessible to the CPU module such as DI/DO and the 2000 series I/O, and the CP-215 or CP-217 which is accessible by a transmission route. Hardware and I/O registers are allocated at the CP-717 Window Setting. IW(OW)C000 to IW(OW)FFFF are used for transferring motion parameters. Accessible to both CPU#1 and CPU#2.
MW (DWG common register)	The general-purpose register common to each DWG. Used for transferring data between DWGs. Transferring data between CPUs is also allowed by defining a part of this register at CP-717. Refer to the "Shared Memory Allocation Screen" of CP-717.
DW (DWG individual register)	The general-purpose register specific to each DWG. Therefore, one DWG register cannot refer to other DWG D register. Using this register will make it simple to package software.

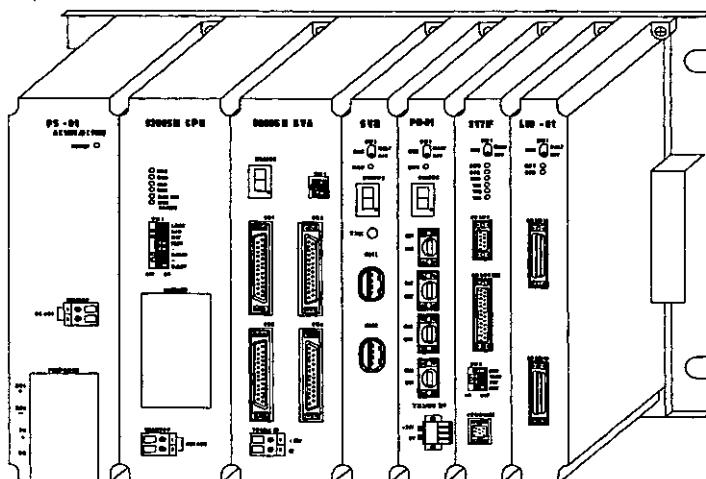

Fig. 1.1 Appearance of the CP-9200SH short mounting base

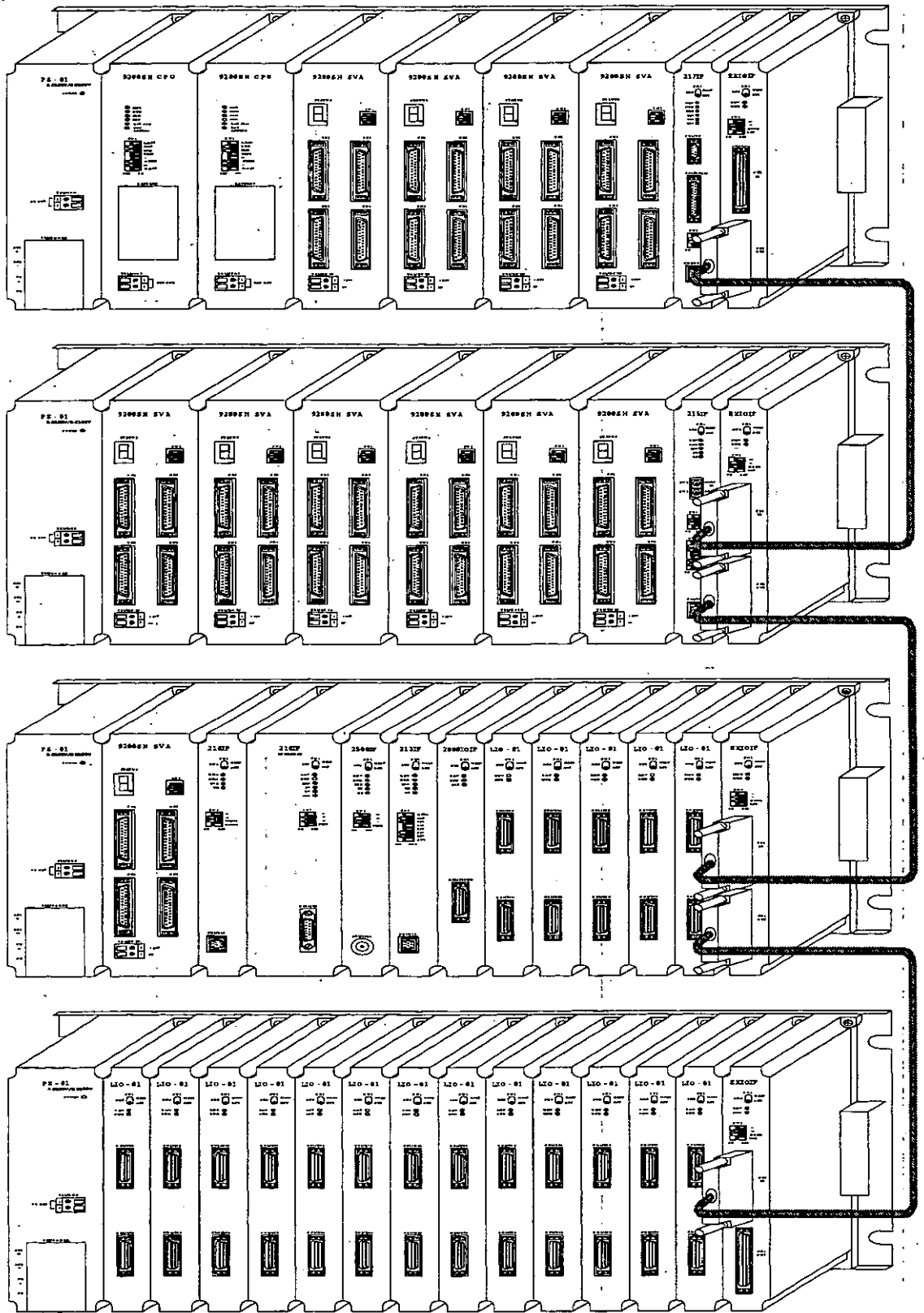

Fig. 1.2 Appearance of the CP-9200SH long mounting base

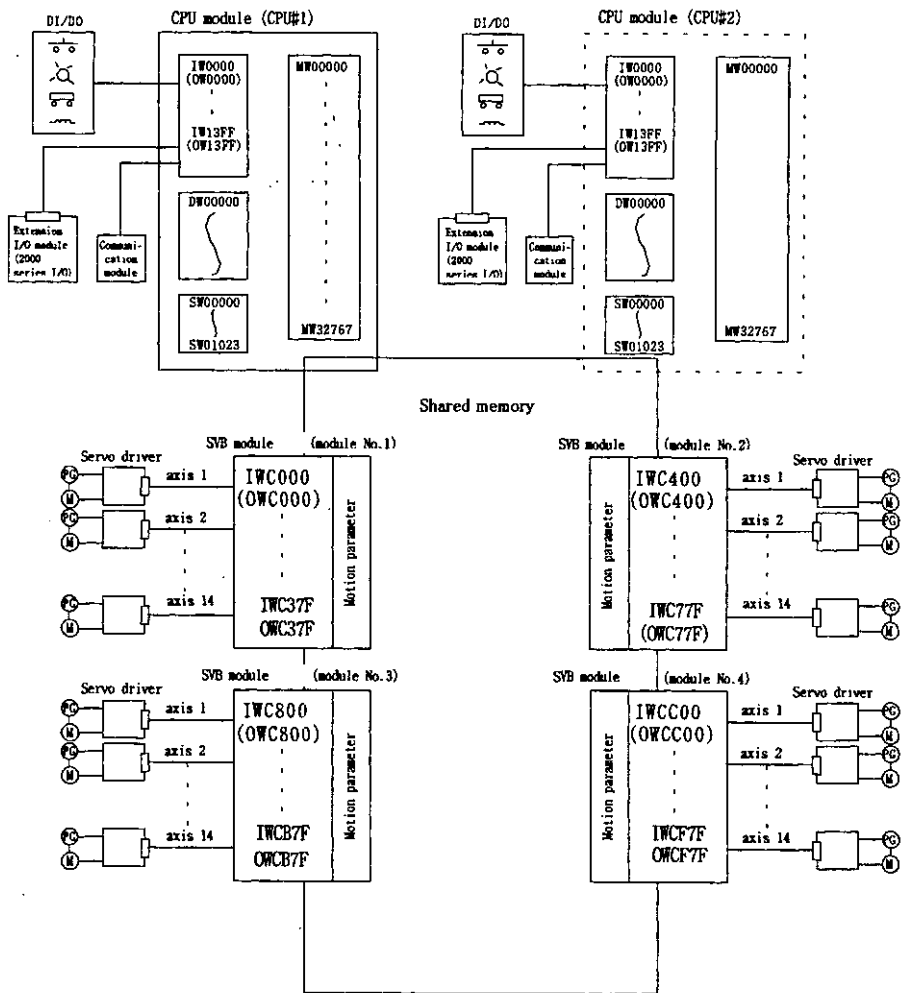

Fig. 1.3 Connection between CP-9200SH and its peripheral units (Software)

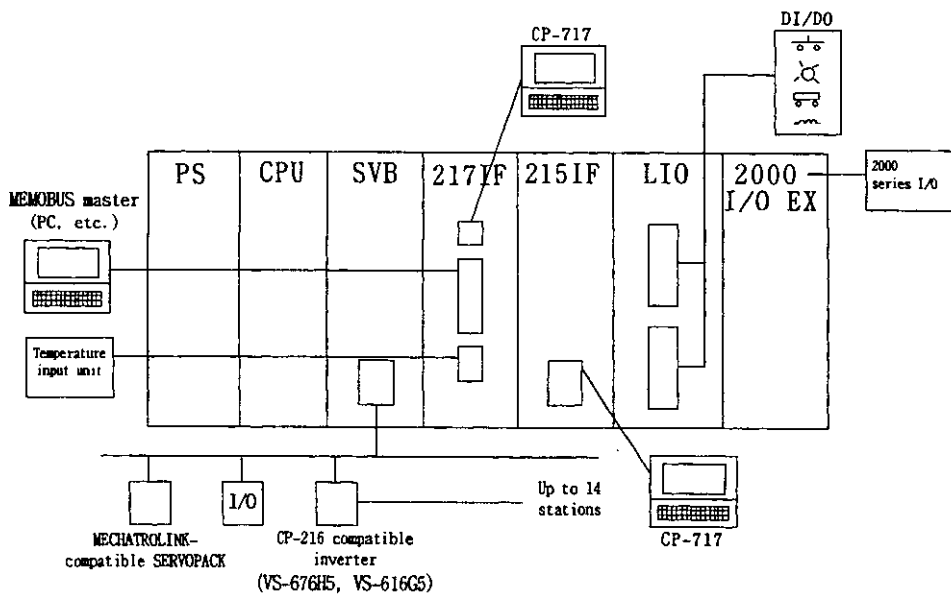

Fig. 1.4 Connection between CP-9200SH and its peripheral units (Hardware)

1.2 How to Run the SVB Module

First, assign an SVB module number. Then, by simply setting motion parameters, motion control can be performed. Designing these motion parameters freely by user CPU module programs provides motion control suitable for the machine.

◆ Assigning a module No.

Assign a module No. on the "Module Configuration" window of CP-717. Also, assign connection unit and station Nos. on the "I/O Assignment" window of MECHATROLINK.

◆ Data transfer between the CPU module and SVB module

Data are transferred via motion parameters. There are three types of motion parameter as follows.

(1) Motion fixed parameters

These parameters will, once set, normally be never changed as long as the configuration or specifications of the machine are not changed. Set them on the "Fixed parameter" window of CP-717.

If the motion fixed parameters are changed, motion monitoring parameters for monitoring the target position, etc., will be initialized.

(2) Motion-setting parameters

These parameters are used for giving commands from the CPU module to the SVB module. At the beginning of high-speed scanning, they are transferred to the SVB module in a batch. Motion control can be performed by simply setting these motion parameters.

(3) Motion monitoring parameters

These parameters are used for giving reports from the SVB module to the CPU module. At the beginning of high-speed scanning, they are transferred to the CPU module in a batch. These are used for application control and debugging user programs.

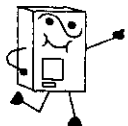

Let's run the Servomotor by using the "parameter setting" function of CP-717 without creating a user program.

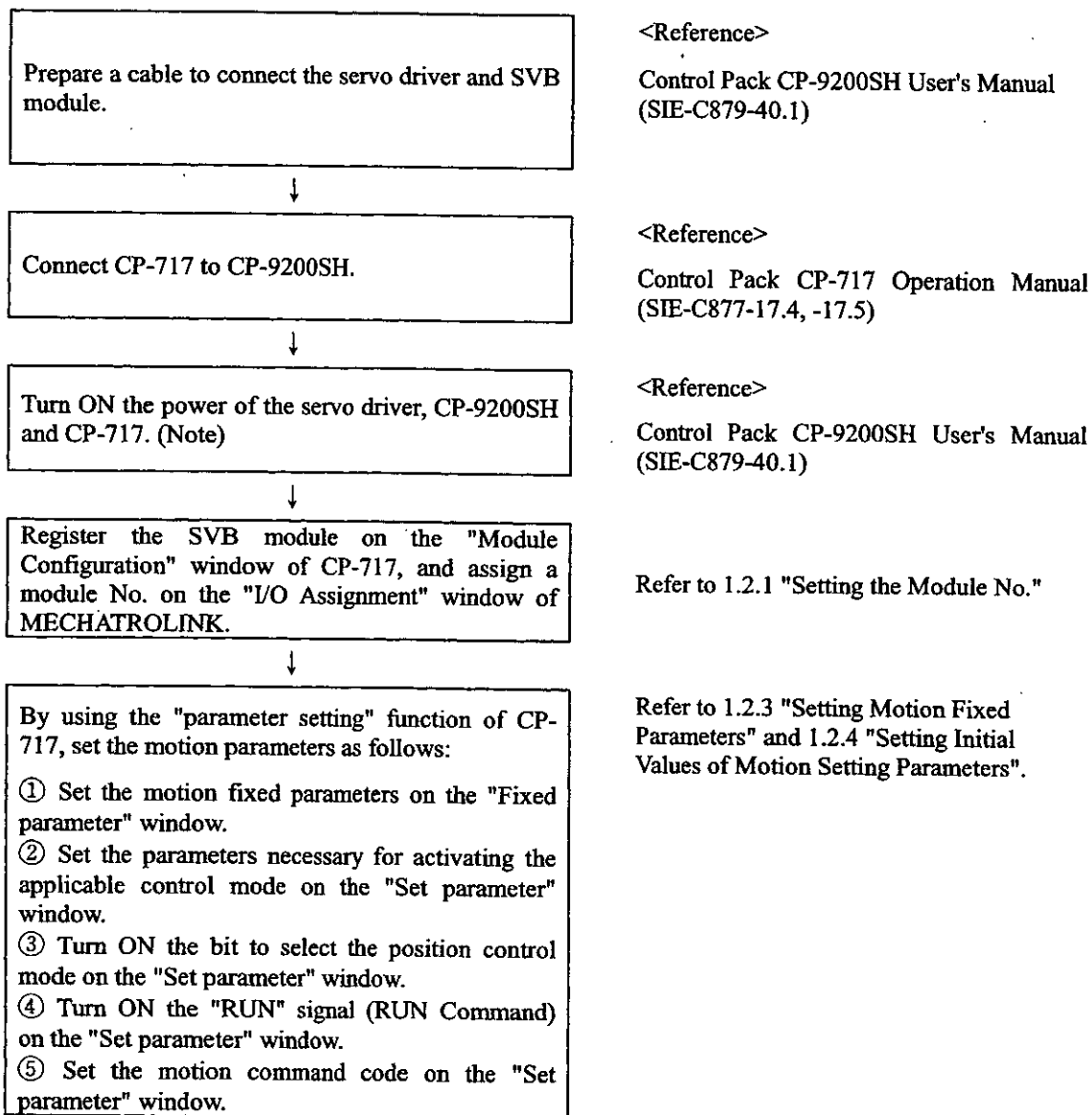
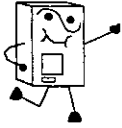

Fig. 1.5 Servomotor Operating Procedure

Note

Turn ON the power of CP-9200SH after or at the same time as the servo driver.



Now, let's create a simple program. Here is an example of the constant speed feed which is the simplest movement for performance tests on the Servomotor.

Set the motion parameters which have been set by using the "parameter setting" function in Fig. 1. "Servomotor Operating Procedure" on a user program.

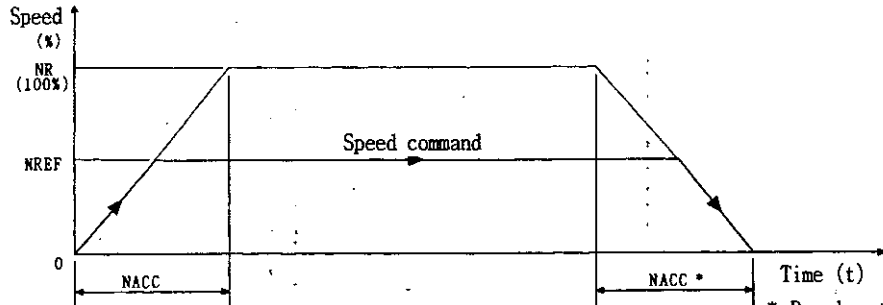

Fig. 1.6 An Example of Constant Speed Feed

* Decelerates the feed to stop in the same time as the acceleration time.

<Preconditions>

Motor rated revolution speed : NR = 3000 r/min

Feedback pulse resolution : FBppr = 2048 ppr

Set the above motion fixed parameters on the "Fixed parameter" window of CP-717.

<Operating conditions>

Linear acceleration time : NACC = 1 sec.

Motion command code : Constant feed speed

Rapid speed feed : 300,000 pulses /min.

In the above conditions, the SERVOPACK is used on the first axis of module No. 1.

Also, set the above motion setting parameters on the "Set parameter" window of CP-717.

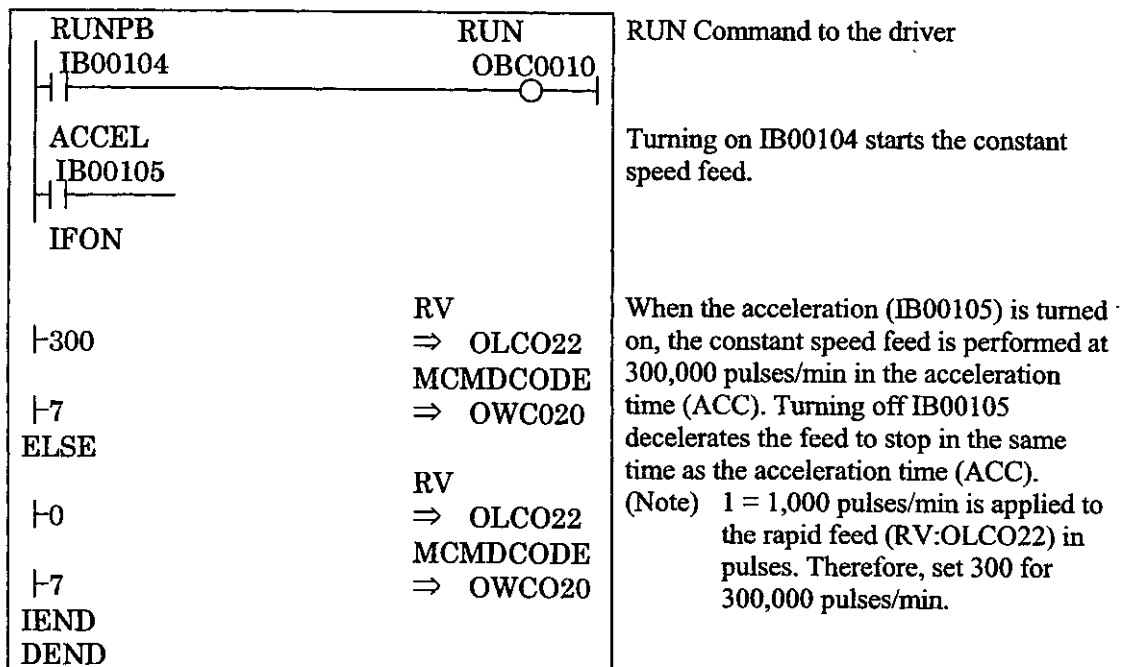

Fig. 1.7 Constant Speed Feed Command (DWG H01)

The example in Fig.1.7 has been simplified, however, each register, etc., can be freely controlled by the user's program.

1.2.1 Setting the Module No.

Set the module No. on the "Module Configuration" window of CP-717 as follows.

For the details, refer to the Control Pack CP-717 Operation Manual (SIE-C877-17.4, -17.5).

- ① Register the SVB to the slot where the SVB module is mounted.
- ② Set the module No. in the "Cir No." column.
- ③ The module No. setting is completed with the above procedure. Upon completion of setting the range of registers (IW/OW) for motion parameters is automatically displayed in the "Register Range" column.
- ④ Set the registers (IW/OW) used for MECHATROLINK assignment in "I/O Start Register" and "I/O End Register" columns.
- ⑤ Save the module configuration definition.

Configuration of the "Module Configuration" window

The screenshot shows the 'Module Configuration' window. At the top, there is a 'Rack' configuration table:

Select Rack	Rack Kind
Rack 1	Long
Rack 2	Not Used
Rack 3	Not Used
Rack 4	Not Used

Below this is a table for module configuration, with columns for Rack 1, Rack 2, Rack 3, and Rack 4. The table has multiple rows for various parameters:

	Rack 1	Rack 2	Rack 3	Rack 4
Module	CP-9200SH	RESERVED	CP-218	RESERVED
General I/P No.		01		01
Cir No.			01	
Module Dual				
CP Dual				
Replacement			Enable	
I/O Start Register				0100
I/O End Register				02FF
Input DISABLE				
Output DISABLE				
Motion Start Register				C000
Motion End Register				C3FF
Delay				M LINK
State				

(1) Rack information

Select the type of rack to which the module is connected.

(2) Module information

The module information is displayed.

1.2.2 MECHATROLINK Assignment

Set the type of unit to be connected to the SVB module and the station No.

◆ Setting parameters

Set the parameters necessary for using the MECHATROLINK transmission system.

Configuration of the "Transmission Parameters" window

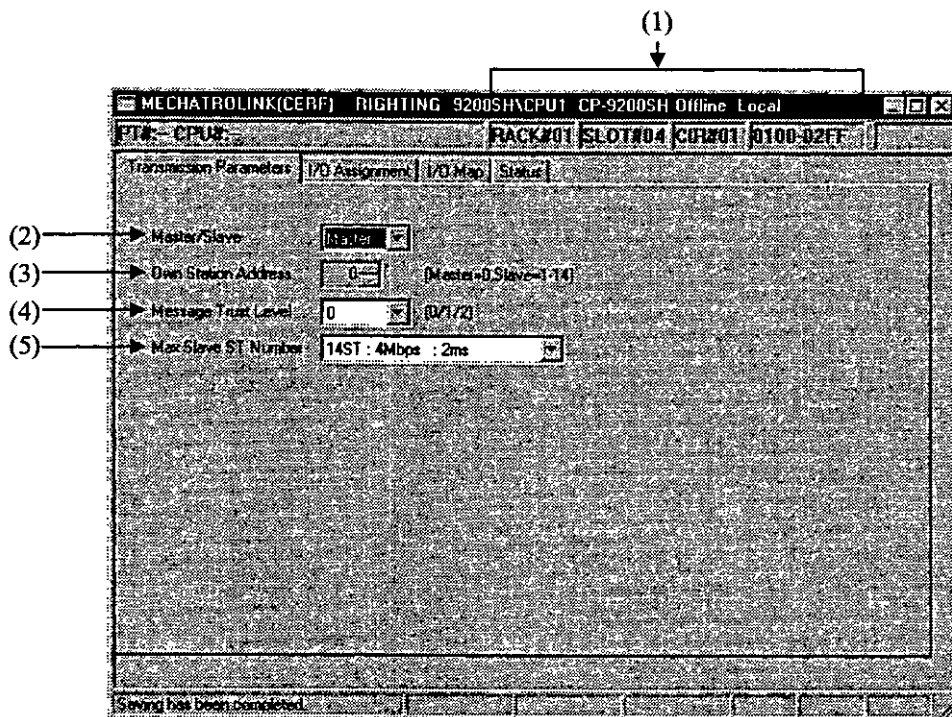

(1) Configuration Information

RACK#: Displays the rack No. to which MECHATROLINK is defined.

SLOT#: Displays the slot No. to which MECHATROLINK is defined.

CIR#: Displays the circuit No.

Register range: Displays the I/O register range.

(2) Master/Slave

Set whether the PLC is used as a master station or slave station.

Always select "Master". Slave function is not provided for this module.

(3) Own Station Address

In the case of a master station, fix the own station address to 0.

In the case of a slave station, set a station address between 1 and 30.

(4) Message Trust Level

Set the error recovery method for sending MEMOBUS commands.

0: A command is sent only once, and the response from the other side is waited indefinitely.

1: A command is sent once, and if there is no response in 8 seconds, the command is sent again.

2: When sending a command, the data are sent twice in succession word by word, and the response from the other side waits indefinitely.

The transmission reliability improves but the transmission time increases twofold.

(5) Maximum number of slave stations

Number of slave stations	Transmission speed	Transmission cycle
2	4 Mbps	500 μ s
2	10 Mbps	250 μ s
3	2 Mbps	1 ms
6	4 Mbps	1 ms
6	10 Mbps	500 μ s
7	2 Mbps	2 ms
14	4 Mbps	2 ms
14	10 Mbps	1 ms
15	2 Mbps	4 ms
29	4 Mbps	4 ms
29	10 Mbps	2 ms
30	10 Mbps	4 ms

Note

When connecting MECHATROLINK SERVOPACK, set the Max. No. of slave stations setting to 14 stations, 4 Mbps, and 2 ms.

◆ I/O assignment

1 Setting assignment data

Set the I/O units to be connected to MECHATROLINK and transmission definition data with the "I/O Assignment" tab.

Configuration of the "I/O Assignment" window

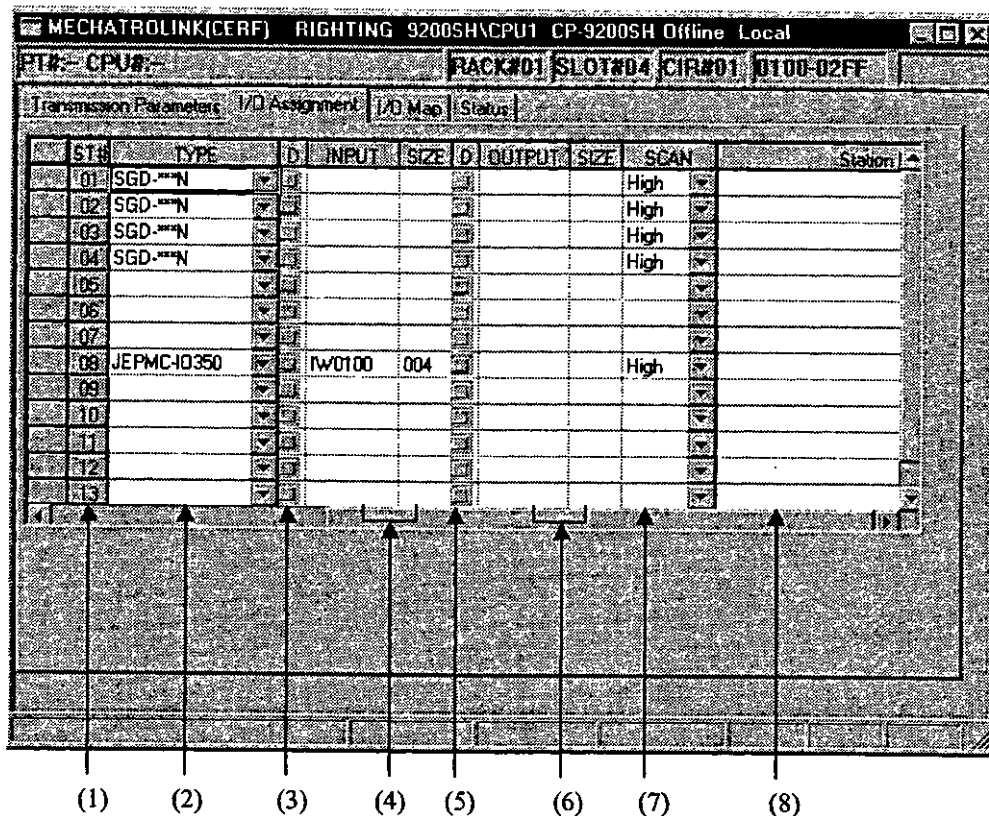

(1) ST#

Station Nos. are displayed. Up to 14 stations can be set.

(2) TYPE

Set the I/O units to be connected to the station from the combo box menu.

VS-676H5	Inverter
VS-676H5T	
VS-616G5	
RIO-01	Distributed I/O
RIO-06	RIO-06
ABS_CODER	Distributed I/O
JEPMC-IO350	Distributed I/O
SGD-□□□N	SERVOPACK
SGDB-□□□AN	

(3) D

Set the disable condition of the input register.

: enable

: disable

(5) INPUT, SIZE

Set the starting input register No. and the number of registers (size). The number of registers is automatically set. Do not overlap the register range between stations. The register No. can be set within the range between the start register No. and end register No. designated on the "Module Configuration" window.

This setting is not available when TYPE is SERVOPACK.

"Module Configuration" window

	Rack 1	Rack 2	Rack 3	Rack 4			
No.	00	01	02	03	04	05	06
Module	CP-9200SH	RESERVED	CP-218	RESERVED	SVB	UNDEFINED	UNDEFINED
Contact CPU No.			01		01		
Ct No.			01		01		
Module Dual							
Ct Dual							
Replacement			Enable				
I/O Start Register					0100		
I/O End Register					02FF		
Input DISABLE							
Output DISABLE							
Motion Start Register					C000		
Motion End Register					C3FF		
Detail					W-LINK		
Status							

Settable register range

(5) D

Set the disable condition of the output register.

- : enable
- : disable

(6) OUTPUT, SIZE

Set the starting output register No. and the number of registers (size). The number of registers is automatically set. Do not overlap the register range between stations. The register No. can be set within the range between the start register No. and end register No. specified on the "Module Configuration" window.

This setting is not available when TYPE is SERVOPACK.

(7) SCAN

Set the scan for I/O service. When TYPE is SERVOPACK, fix it to High.

- High : high-speed scan
- Low : low-speed scan

(8) Station name

Input comments for each station with up to 32 characters.

2 Deleting assignment data

(1) Delete assignment data for a station as follows:

Move the cursor to the line of the station to be deleted, and choose "Assignment Delete (A)" from the "Edit (E)" menu.

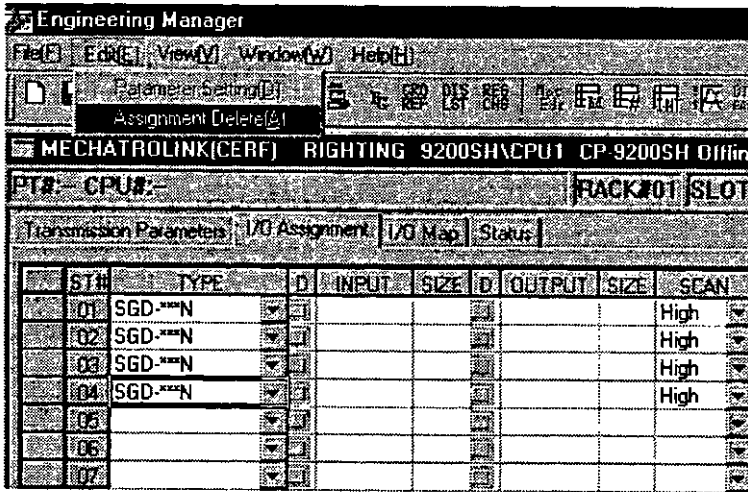

The data assigned to the station is deleted.

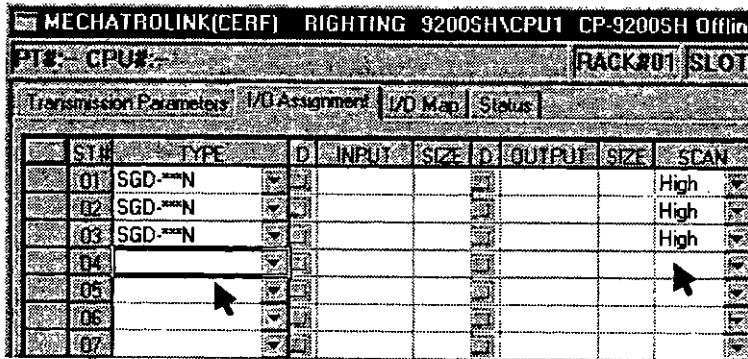

◆ I/O map

The PLC I/O assignment conditions are displayed with the "I/O Map" tab. The I/O register number defined on the "I/O Assignment" window is displayed, and cannot be changed.

Configuration of the "I/O Map" window

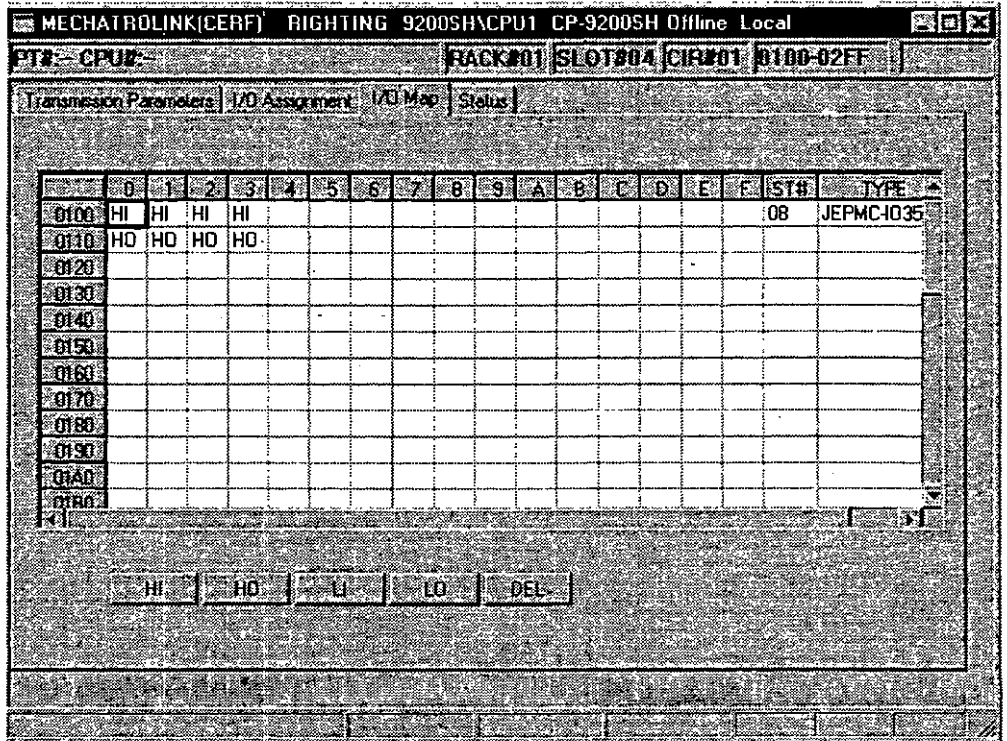

- HI : assigned to the high scan input
- HO : assigned to the high scan output
- LI : assigned to the low scan input
- LO : assigned to the low scan output

◆ Status

The data that MECHATROLINK is currently transmitting are displayed with the "Status" tab. In this tab window, only the status is displayed, and each set value cannot be changed.

Configuration of the "Status" window

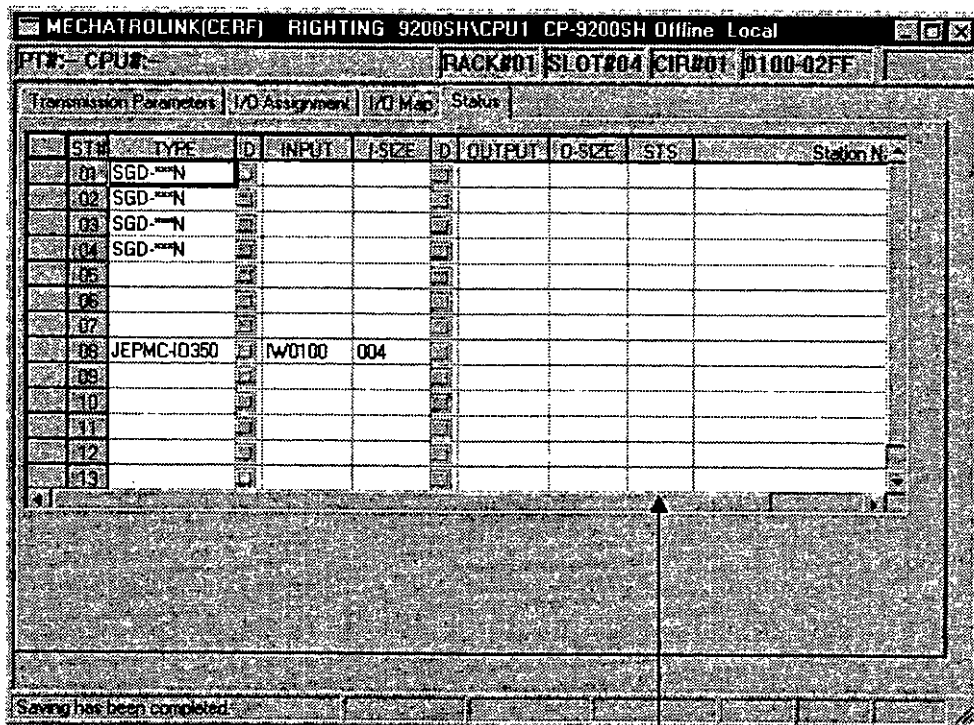

(1)

The meaning of each item is the same as that of the "I/O Assignment" tab, except the "STS" column marked by (1).

(1) STS

In the online mode, the details of the MECHATROLINK transmission status are displayed in hexadecimal. The meaning of each bit is as follows. Nothing is displayed in the offline mode.

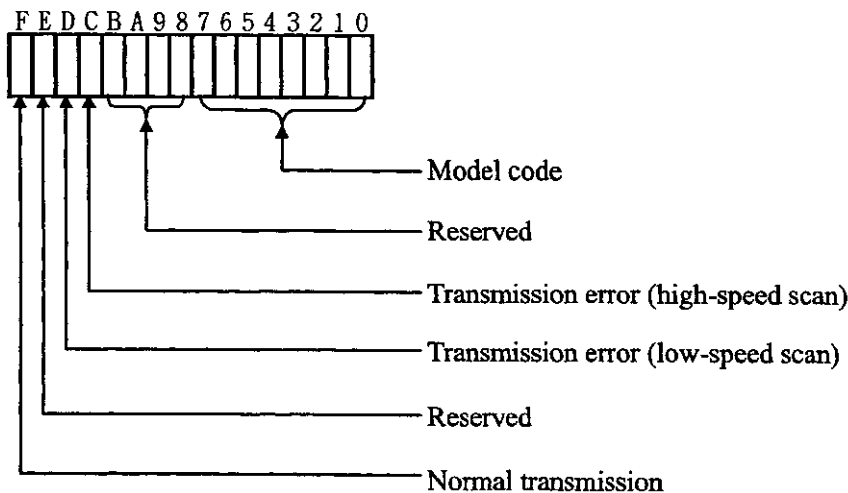

1.2.3 Setting Motion Fixed Parameters

Set the fixed parameters necessary for servo adjustment on the "Fixed parameter" window of CP-717. For details, refer to the Control Pack CP-717 Operation Manual (SIE-C879-17.4, -17.5).

Configuration of the "Fixed parameter" window

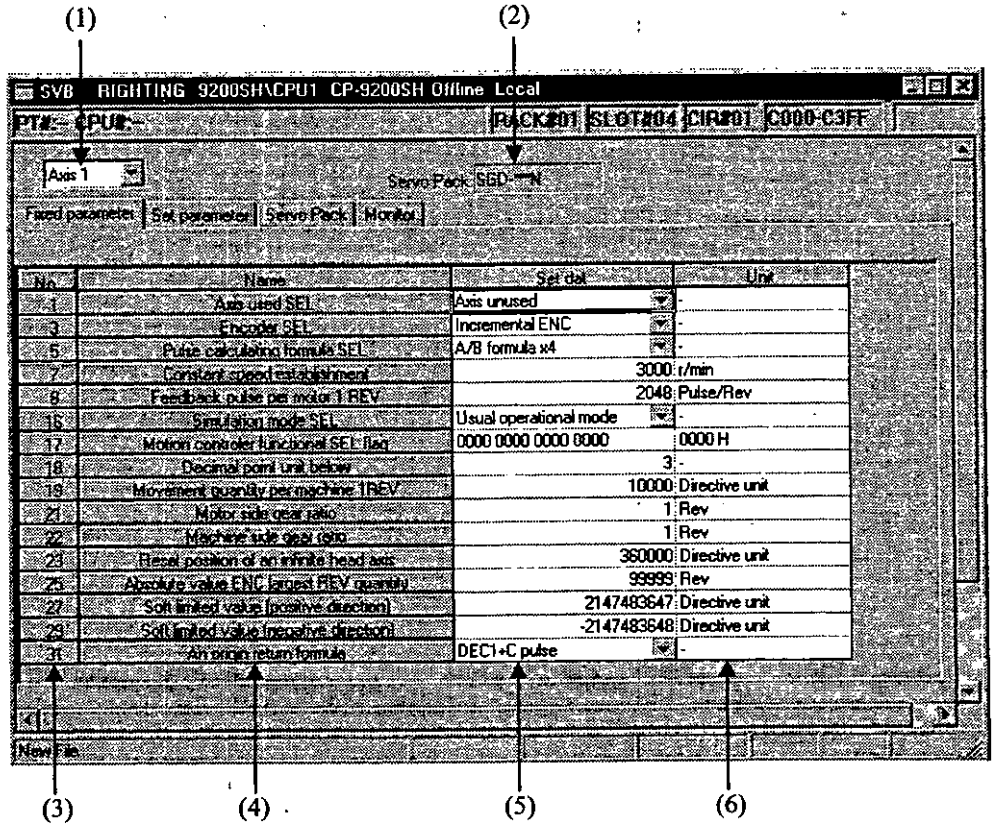

(1) Axis No.

Select the axis No. from axis 1 to axis 4. Fixed parameters should be set in axes.

(2) Servo Pack

The type of SERVOPACK is displayed.

(3) No.

Fixed parameter Nos. are displayed.

(4) Name

Parameter names are displayed.

(5) Set data

Input (select) parameter values. The setting of each parameter is shown in Table 24.3.

(6) Unit

Parameter units are displayed.

Note

When the current value of Bit 0 of motion setting parameter OW□□01 "RUN Command" is ON the motion fixed parameters cannot be saved.

1.2.4 Setting Initial Values of Motion Setting Parameters

Set necessary parameters on the "Set parameter" window of CP-717. The data set here will automatically be set as the initial values of motion setting parameters at the time of turning ON the power of CP-9200SH.

For details, refer to the Control Pack CP-717 Operation Manual (SIE-C879-17.4, -17.5).

Configuration of the "Set parameter" window

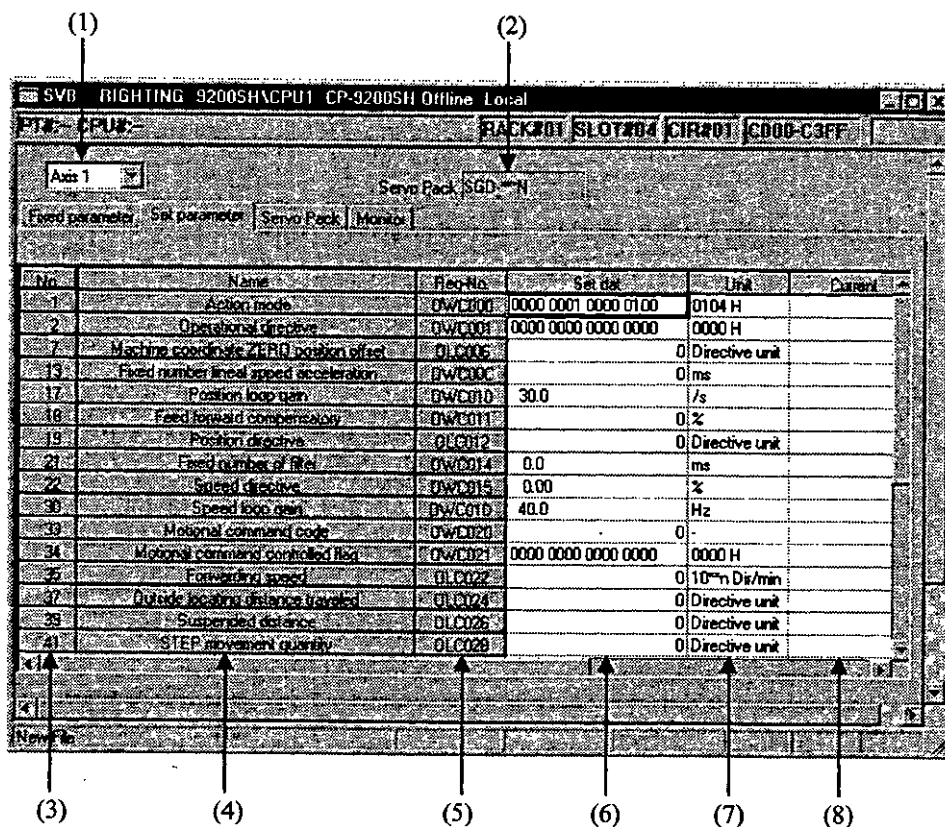

(1) Axis No.

Select the axis No. from axis 1 or axis 2. Parameters should be set in axes.

(2) Servo Pack

The type of SERVOPACK is displayed.

(3) No.

Set parameter Nos. are displayed.

(4) Name

Parameter names are displayed.

(5) Reg-No.

The register Nos. corresponding to the parameter names are displayed.

The register Nos. differ according to the motion No. and axis No. on the current display.

For register Nos., refer to 1.3 Module No. and Motion Parameter Register No.

(6) Set dat

Input (select) parameter values.

(7) Unit

Parameter units are displayed.

(8) Current

The current values of parameters are displayed in the online mode. Nothing is displayed in the offline mode.

1.2.5 Setting SERVOPACK Parameters

Set the parameters necessary for the SERVOPACK.

Configuration of the "Servo Pack" window

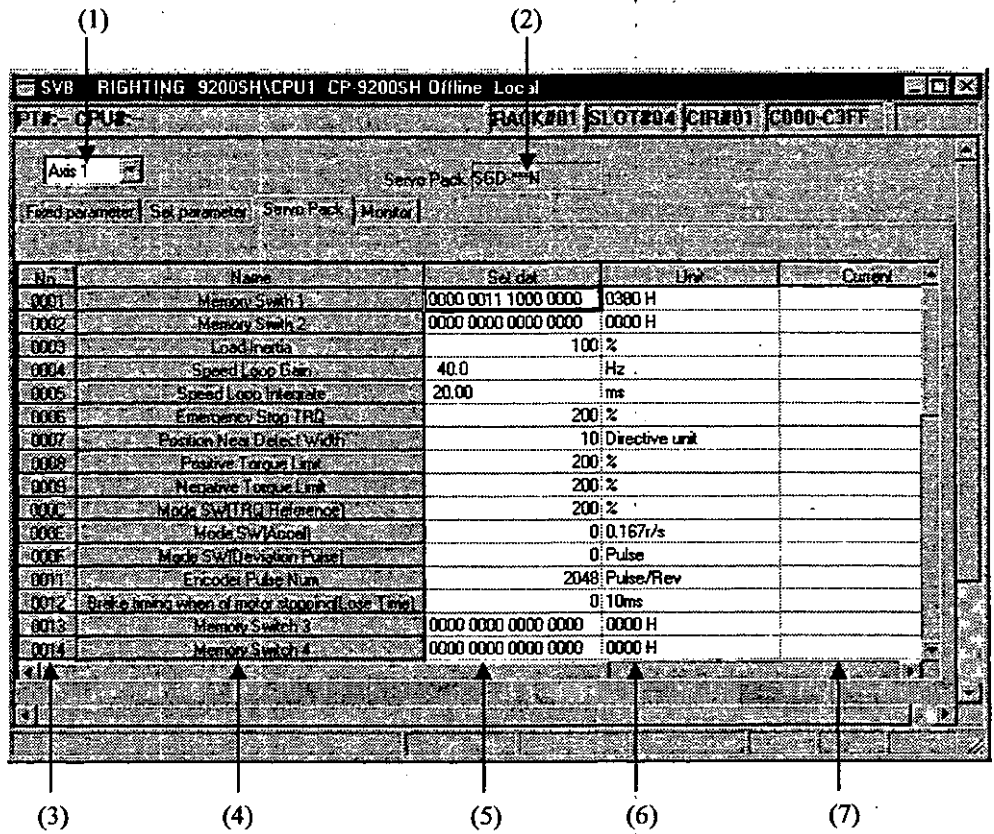

(1) Axis No.

Select the axis No. from axis 1 to axis 4. SERVOPACK parameters should be set in axes.

(2) Servo Pack

The type of SERVOPACK is displayed.

(3) No.

SERVOPACK parameter Nos. are displayed.

(4) Name

Parameter names are displayed.

(5) Set dat

Input (select) parameter values.

(6) Unit

Parameter units are displayed.

(7) Current

The current values of parameters are displayed in the online mode.

Nothing is displayed in the offline mode.

Note

When opening the SERVOPACK window, check that the current value of Bit 0 of the motion setting parameter OW□□20 "Motion Command Code" is NOP (= 0). Opening in other than NOP (= 0) condition gives an error message.

1.2.6 Monitoring Running Status (Control Data)

Monitor data is displayed on the "Monitor" window of CP-717. This window can be used for debugging user programs, tuning the motion control, etc.

On this window, only the current values of motion monitoring parameters are displayed, and the data cannot be changed.

Configuration of the "Monitor" window

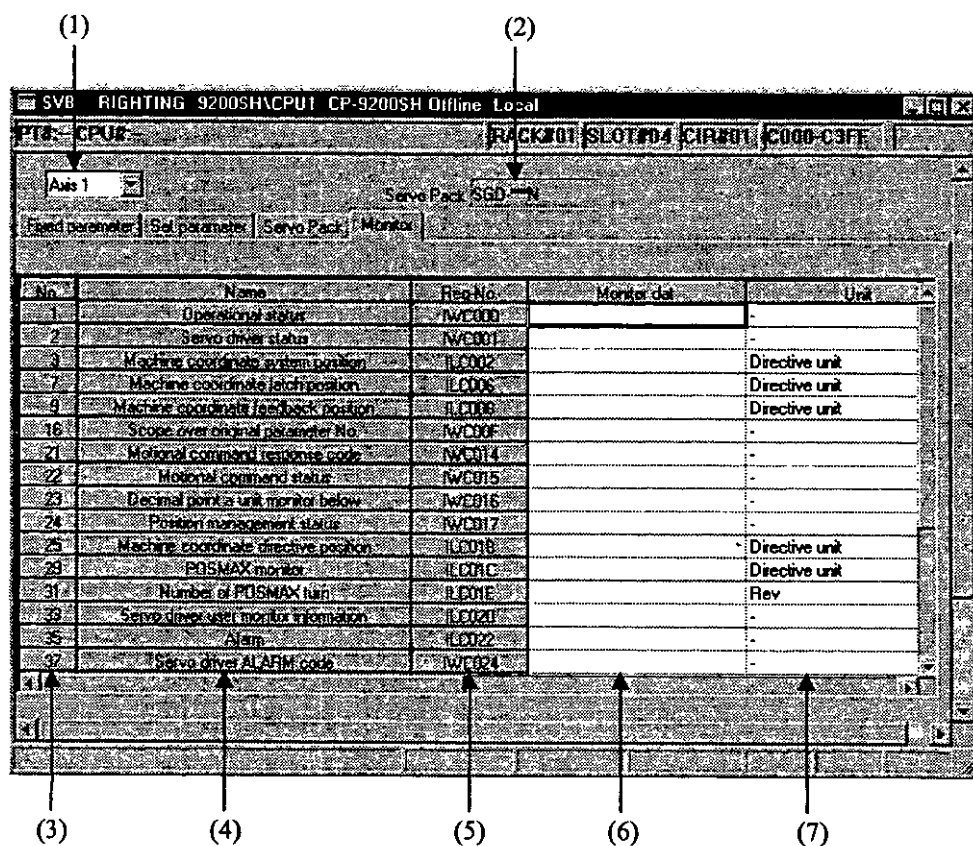

(1) Axis No.

Select the axis No. from axis 1 or axis 2. Motion monitoring parameters are displayed in axes.

(2) Servo Pack

The type of SERVOPACK is displayed.

(3) No.

Motion monitoring parameter Nos. are displayed.

(4) Name

Parameter names are displayed.

(5) Reg-No.

The register Nos. corresponding to the parameter names are displayed.

The register Nos. differ according to the motion No. and axis No. on the current display.

For register Nos., refer to 1.3 Module No. and Motion Parameter Register No.

(6) Monitor dat

The current values of parameters are displayed in the online mode. Nothing is displayed in the offline mode.

(7) Unit

Parameter units are displayed.

1.3 Module No. and Motion Parameter Register No.

The motion parameter register No. (I or O register No.) differs according to the module No. and axis No. (1 to 14).

The motion parameter register No. is given by the following equation.

Motion parameter register No. (IW□□□□ and OW□□□□) = Module No. offset + Axis offset

The module No. offset is as shown below according to the module No.

Module NO.1 = C000	Module NO.2 = C400
Module NO.3 = C800	Module NO.4 = CC00
Module NO.5 = D000	Module NO.6 = D400
Module NO.7 = D800	Module NO.8 = DC00
Module NO.9 = E000	Module NO.10 = E400
Module NO.11 = E800	Module NO.12 = EC00
Module NO.13 = F000	Module NO.14 = F400
Module NO.15 = F800	Module NO.16 = FC00

The axis offset is as shown below according to each axis No.

Axis offset = (Axis No. - 1) × 40 H(64 words)

The contents described above are summarized in Table 1.2.

Table 1.2 Motion Parameter Register No.

Motion module No.	Axis 1	Axis 2	Axis 3	Axis 4	Axis 5	Axis 6	Axis 7	Axis 8	Axis 9	Axis 10	Axis 11	Axis 12	Axis 13	Axis 14
1	C000~ C03F	C040~ C07F	C080~ C0BF	C0C0~ C0FF	C100~ C13F	C140~ C17F	C180~ C1BF	C1C0~ C1FF	C200~ C23F	C240~ C27F	C280~ C2BF	C2C0~ C2FF	C300~ C33F	C340~ C37F
2	C400~ C43F	C440~ C47F	C480~ C4BF	C4C0~ C4FF	C500~ C53F	C540~ C57F	C580~ C5BF	C5C0~ C5FF	C600~ C63F	C640~ C67F	C680~ C6BF	C6C0~ C6FF	C700~ C73F	C740~ C77F
3	C800~ C83F	C840~ C87F	C880~ C8BF	C8C0~ C8FF	C900~ C93F	C940~ C97F	C980~ C9BF	C9C0~ C9FF	CA00~ CA3F	CA40~ CA7F	CA80~ CABF	CAC0~ CAFF	CB00~ CB3F	CB40~ CB7F
4	CC00~ CC3F	CC40~ CC7F	CC80~ CCBF	CCC0~ CCFF	CD00~ CD3F	CD40~ CD7F	CD80~ CDBF	CDC0~ CDFF	CE00~ CE3F	CE40~ CE7F	CE80~ CEBF	CEC0~ CEFF	CF00~ CF3F	CF40~ CF7F
5	D000~ D03F	D040~ D07F	D080~ D0BF	D0C0~ D0FF	D100~ D13F	D140~ D17F	D180~ D1BF	D1C0~ D1FF	D200~ D23F	D240~ D27F	D280~ D2BF	D2C0~ D2FF	D300~ D33F	D340~ D37F
6	D400~ D43F	D440~ D47F	D480~ D4BF	D4C0~ D4FF	D500~ D53F	D540~ D57F	D580~ D5BF	D5C0~ D5FF	D600~ D63F	D640~ D67F	D680~ D6BF	D6C0~ D6FF	D700~ D73F	D740~ D77F
7	D800~ D83F	D840~ D87F	D880~ D8BF	D8C0~ D8FF	D900~ D93F	D940~ D97F	D980~ D9BF	D9C0~ D9FF	DA00~ DA3F	DA40~ DA7F	DA80~ DABF	DAC0~ DAFF	DB00~ DB3F	DB40~ DB7F
8	DC00~ DC3F	DC40~ DC7F	DC80~ DCBF	DCC0~ DCFF	DD00~ DD3F	DD40~ DD7F	DD80~ DDBF	DDC0~ DDFF	DE00~ DE3F	DE40~ DE7F	DE80~ DEBF	DEC0~ DEFF	DF00~ DF3F	DF40~ DF7F
9	E000~ E03F	E040~ E07F	E080~ E0BF	E0C0~ E0FF	E100~ E13F	E140~ E17F	E180~ E1BF	E1C0~ E1FF	E200~ E23F	E240~ E27F	E280~ E2BF	E2C0~ E2FF	E300~ E33F	E340~ E37F
10	E400~ E43F	E440~ E47F	E480~ E4BF	E4C0~ E4FF	E500~ E53F	E540~ E57F	E580~ E5BF	E5C0~ E5FF	E600~ E63F	E640~ E67F	E680~ E6BF	E6C0~ E6FF	E700~ E73F	E740~ E77F
11	E800~ E83F	E840~ E87F	E880~ E8BF	E8C0~ E8FF	E900~ E93F	E940~ E97F	E980~ E9BF	E9C0~ E9FF	EA00~ EA3F	EA40~ EA7F	EA80~ EABF	EAC0~ EAFF	EB00~ EB3F	EB40~ EB7F
12	EC00~ EC3F	EC40~ EC7F	EC80~ ECBF	ECC0~ ECFF	ED00~ ED3F	ED40~ ED7F	ED80~ EDBF	EDC0~ EDFF	EE00~ EE3F	EE40~ EE7F	EE80~ EEBF	EEC0~ EEFF	EF00~ EF3F	EF40~ EF7F
13	F000~ F03F	F040~ F07F	F080~ F0BF	F0C0~ F0FF	F100~ F13F	F140~ F17F	F180~ F1BF	F1C0~ F1FF	F200~ F23F	F240~ F27F	F280~ F2BF	F2C0~ F2FF	F300~ F33F	F340~ F37F
14	F400~ F43F	F440~ F47F	F480~ F4BF	F4C0~ F4FF	F500~ F53F	F540~ F57F	F580~ F5BF	F5C0~ F5FF	F600~ F63F	F640~ F67F	F680~ F6BF	F6C0~ F6FF	F700~ F73F	F740~ F77F
15	F800~ F83F	F840~ F87F	F880~ F8BF	F8C0~ F8FF	F900~ F93F	F940~ F97F	F980~ F9BF	F9C0~ F9FF	FA00~ FA3F	FA40~ FA7F	FA80~ FABF	FAC0~ FAFF	FB00~ FB3F	FB40~ FB7F
16	FC00~ FC3F	FC40~ FC7F	FC80~ FCBF	FCC0~ FCFF	FD00~ FD3F	FD40~ FD7F	FD80~ FDBF	FDC0~ FDFF	FE00~ FE3F	FE40~ FE7F	FE80~ FEBF	FEC0~ FEFF	FF00~ FF3F	FF40~ FF7F

Note

No. of registers with a different module No. are not consecutive.

Those with the same module No. are consecutive between axes No. 1 and 8 and between axes No. 9 and 14, but those between axes No. 8 and 9 are not consecutive.

Therefore, care should be taken if a subscript (i, j) is used on a user program.

(Example 1) Axes No. 1 to 8 with the same module No.:

With IW(OW)C000i , read can be performed normally within the range of $i = 0$ to 511.

With IW(OW)C000i , the register range of module No. 1 between axes No. 1 and 8, that is, the range between IW(OW)C000 and IW(OW)C1FF can be read and written normally.

If $i > 511$, read cannot be performed normally.

(Example 2) Axes No. 9 to 14 with the same module No.:

With IW(OW)C200i , read can be performed normally within the range of $i = 0$ to 383.

With IW(OW)C200 , the register range of module No. 1 between axes No. 9 and 14, that is, the range between IW(OW)C200 and IW(OW)C37F can be read and written normally.

If $i > 383$, read cannot be performed normally.

Be aware that with IW(OW)C200i , register Nos. between axes No. 1 and 8 and from module No. 2 onward cannot be read.

1.4 Outlines of functions

1.4.1 Outlines of motion commands

The motion commands include positioning (POSING), zero point return (ZRET), interpolation (INTERPOLATE), constant speed feed (FEED) and constant step feed (STEP), which can be independently selected on each axis.

Table 1.3 List of motion command functions

Function	Outline
Positioning (POSING)	Positioning is performed at the designated acceleration time constant and at the designated rapid feed speed.
External positioning (EX_POSING)	If a LATCH signal (external positioning signal) is input during positioning operation, the current position counter is latched according to the latch signal, and positioning is performed by moving at an external positioning travel distance from that position.
Zero point return (ZRET)	Positioning is performed by moving at a zero point return travel distance from the ZERO signal.
Interpolation (INTERPOLATE)	Feed is performed by interpolation according to the position data for every high-speed scan issued from the CPU module.
Interpolation with position detection (LATCH)	While feed is performed by interpolation in the same way as the above interpolation (INTERPOLATE), the current position counter is latched according to the LATCH signal, and the latch position converted in the reference unit system is reported.
Constant speed feed (FEED)	Rapid feed is performed in the designated direction at the designated acceleration time constant and at the designated feed speed toward an infinite distance. Using the NOP command decelerates the feed to stop.
Constant step feed (STEP)	Positioning is performed by the designated distance of movement (amount of step movement) in the designated direction at the rapid feed speed according to the designated acceleration time constant.
Zero point setting (ZSET)	The position at a designated distance from the current position can be set as the zero point.
Changing the acceleration time constant (ACC)	Validates the setting value of the linear acceleration time constant.
Changing the filter time constant (SCC)	Validates the setting value of the movement averaging filter or exponential acceleration/deceleration filter time constant.
Changing the filter type (CHG_FILTER)	Validates the setting value of the filter selection.
Changing the speed loop gain (KVS)	Validates the setting value of the speed loop gain.
Changing the position loop gain (KPS)	Validates the setting value of the position loop gain.
Changing the feed forward compensation (KFS)	Validates the setting value of the feed forward compensation.
Reading the user constants of the MECHATROLINK servo (CN_RD)	The user constants of the MECHATROLINK servo are read.

Table 1.3 List of motion command functions (Cont'd)

Function	Outline
Writing the user constants of the MECHATROLINK servo (CN WR)	The user constants of the MECHATROLINK servo are written.
Monitoring the alarm currently arising in the MECHATROLINK servo (ALM MON)	The alarm currently arising in the MECHATROLINK servo is monitored.
Monitoring the alarm history of the MECHATROLINK servo (ALMHIST MON)	The alarm history of the MECHATROLINK servo is monitored.
Clearing the alarm history of the MECHATROLINK servo (ALMHIST CLR)	The alarm history of the MECHATROLINK servo is cleared.

1.5 Hot Swapping

The SVB module is intended to allow hot swapping (removal/insertion under power).

It is necessary to suspend the data updating operation between the CPU module and the module to be replaced because the CPU module is always updating data between mounted modules. Hot swapping is not available when the Servo is ON (the motion setting parameter, "OB • 010" is ON). To assure safety, turn OFF the power before replacing a module.

The method of hot swapping (SVB module)

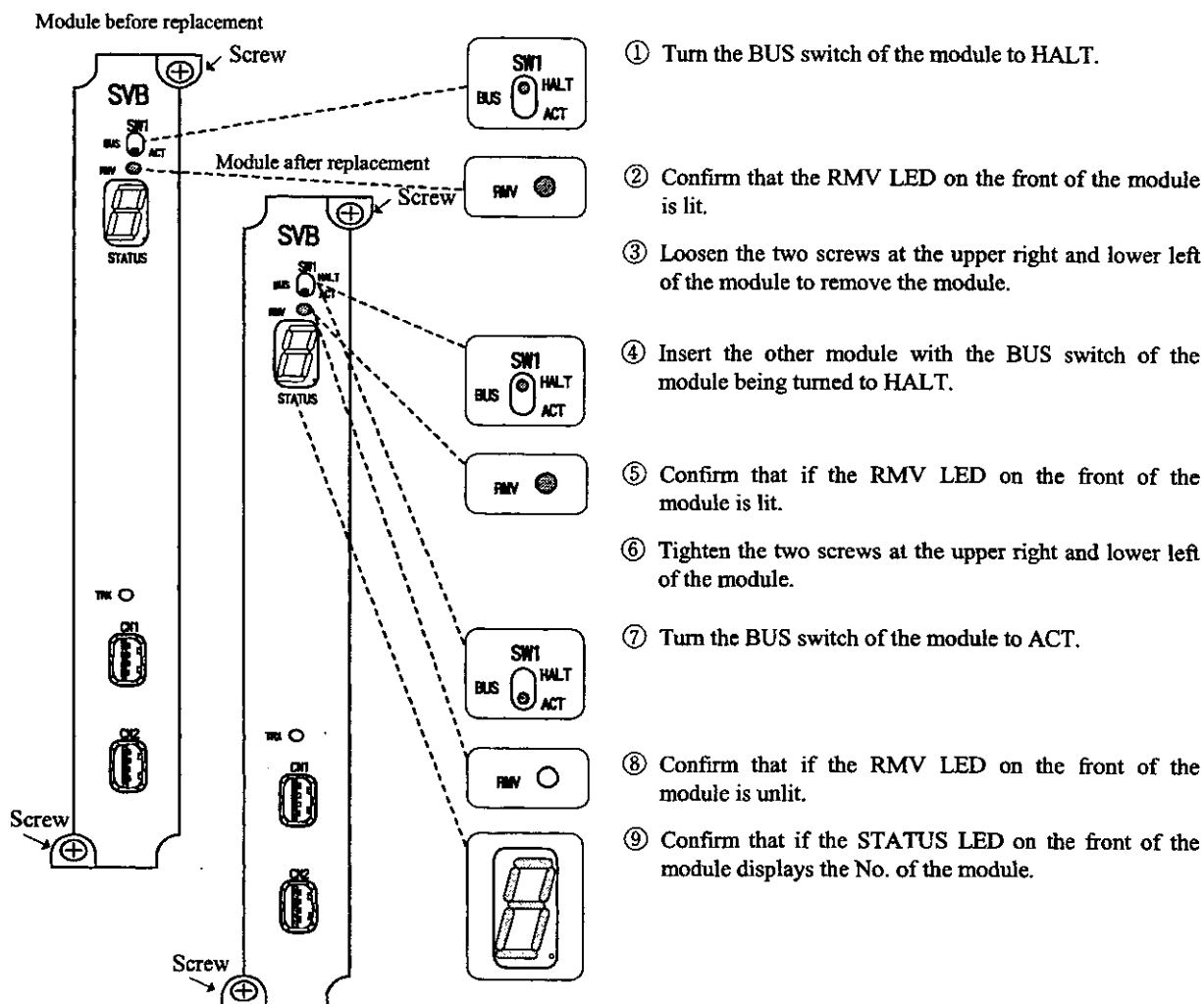

Note

For hot swapping, make sure to turn the BUS switch of the module to be replaced to HALT and confirm that the RMV LED is lit and then remove the module from the mother board.

When the RMV LED is unlit, the CPU module is updating data between each module. For this reason, removing the module when the RMV LED is unlit may result in an error with the data updating of another module, causing a system operation error.

1.6 Precautions on Usage

Pay attention to the following points when using the SVB module.

- (1) The minimum value of the high-speed scan setting time for the SVB module is as mentioned below.

Set the time so as to exceed the minimum value.

- ① When the axis selection (Bit 5 of fixed parameter No.17 "Motion Controller Function Selection Flags") is set to finite-length axis "0":

The minimum value of the high-speed scan setting time = $500 \mu s + (220 \mu s \times \text{number of axes in use})$

Common to the finite-length axis, infinite-length axis and through command mode

- ② When the axis selection (Bit 5 of fixed parameter No.17 "Motion Controller Function Selection Flags") is set to infinite-length axis "1":

The minimum value of the high-speed scan setting time = $500 \mu s + (350 \mu s \times \text{number of axes in use})$

- ③ When the servo driver through command mode selection (Bit 12 of fixed parameter No.17 "Motion Controller Function Selection Flags") is set to through command mode "1":

The minimum value of the high-speed scan setting time = $500 \mu s + (80 \mu s \times \text{number of axes in use})$

(Example)

When 8 axes are set to finite-length axis, 4 axes to infinite-length axis and 2 axes to through command mode:

The minimum value of the high-speed scan setting time
= $500 \mu s + (220 \mu s \times 8) + (350 \mu s \times 4) + (80 \mu s \times 2)$
= $3820 \mu s$ (→ 3.9 ms)

- (2) Do not change the high-speed scan setting value, MECHATROLINK assignment and communication parameters of CPU module during movement (while motion commands such as positioning and zero point return are being issued).
- (3) Once the CPU module configuration definition has been changed, make sure to first turn OFF and then turn ON the power.
- (4) Once the MECHATROLINK assignment or communication parameters has been changed, make sure to first turn OFF and then turn ON the power.

2 BASIC SPECIFICATIONS

This chapter describes the basic specifications of the SVB module.

2 BASIC SPECIFICATIONS

The SVB module can be connected with servos and I/Os by means of MECHATROLINK and with inverters (VS-616G5, VS-676H5) by means of CP-216 transmission, whereby one module can control 14 units in total.

In connection with a MECHATROLINK compatible SERVOPACK, the SVB module has motion functions such as positioning, zero point return, interpolation, constant speed feed and constant step feed, which can be independently selected on each axis. (There is no limitation according to axis No.)

Up to 16 SVB modules can be mounted to one CP-9200SH (module No. = 1 to 16). Be aware that if other motion modules (SVA, PO-01 module) are used, they are included in the 16 modules.

The basic specifications of the SVB module are shown in Table 2.1.

Table 2.1 Basic Specifications of the SVB Module

Item	Specification	
Field bus	MECHATROLINK (high-speed field network) Can be connected with up to 14 stations of servos, I/Os and inverters.	
Slot width	One slot width	
Number of control axes	1 to 14 axes/module	
Motion control functions (in connection with a SERVOPACK)	Control specifications	Position controls: positioning, external positioning, zero point return, interpolation, constant speed feed, constant step feed
	Reference units	mm, deg, inch, pulse
	Minimum reference setting units	1, 0.1, 0.01, 0.001, 0.0001, 0.00001
	Maximum reference value	-2147483648 to +2147483647 (32-bit signed)
	Speed reference units	mm/min, inch/min, deg/min, pulse/min
	Acceleration/deceleration type	Linear, asymmetric, S-curve (Asymmetric acceleration/deceleration is not available for positioning.)
	Override function	0.01 to 327.67% in axes
	Zero point return	4 types: DEC + Phase-C Pulse, ZERO signal, DEC + ZERO signal, Phase-C Pulse Zero point setting function is available.
	Applicable SERVOPACK	SGD-□□AN/SGDB-□□□N
	Encoder	Incremental/Absolute

3 FUNCTIONAL DESCRIPTIONS AND EXAMPLES OF USER PROGRAMS



This chapter describes the main functions and operating methods of the module.

Furthermore, simplified examples of user programs are described. Refer to the examples to prepare your own user programs.

3.1 Setting Basic Motion Parameters

Motion parameters which are important for using motion functions are explained below. Be sure to read through this section before operating this module.

(1) Reference units

The reference units to be input to this module depend on the settings of the following motion fixed parameters.

References are in pulses, mm, deg and inches. The reference units are designated by Bit 0 to 3 of motion fixed parameter No. 17 "Motion Controller Function Selection Flags." Also, the "minimum reference unit" which can be referenced to this module is set by the above unit setting and motion fixed parameter No. 18 "Number of Digits Below Decimal Point."

Table 3.1 Minimum Reference Unit (One Command Unit)

Number of digits below decimal point (Note)	Bit 0 to 3 of motion fixed parameter No. 17 "Motion Controller Function Selection Flags"			
	Pulse (= 0)	mm (= 1)	deg (= 2)	inch (= 3)
0	1 pulse	1 mm	1 deg	1 inch
1	1 pulse	0.1 mm	0.1 deg	0.1 inch
2	1 pulse	0.01 mm	0.01 deg	0.01 inch
3	1 pulse	0.001 mm	0.001 deg	0.001 inch
4	1 pulse	0.0001 mm	0.0001 deg	0.0001 inch
5	1 pulse	0.00001 mm	0.00001 deg	0.00001 inch

(Note) Set the number of digits below decimal point by motion fixed parameter No. 18 "Number of Digits Below Decimal Point."

(2) Electronic gear

In contrast to the reference units to be input to this module, the mechanical movement units are called "output units."

The electronic gear is a function of converting a position or speed unit from the reference unit (mm, deg, inch) to output unit (mm, deg, inch).

In the case where a machine has such a structure that the load side shaft revolves by n when the motor side shaft rotates by m , the "reference unit" can be made equal to the "output unit" by using the electronic gear function.

Set the electronic gear function by the motion fixed parameters shown in Table 3.2. When the unit selection is set to pulse, the electronic gear function is invalid.

Table 3.2 Electronic Gear Parameters

Motion fixed parameter	Name and meaning
Bit 4 of No. 17 "Motion Controller Function Selection Flags"	Electronic gear selection (0: invalid / 1: valid) *This is invalid when the unit selection is set to pulse. Set it to 0 (= invalid).
No. 19 "Travel Distance per Machine Rotation"	Amount of movement per machine rotation *The setting of this parameter is invalid when the electronic gear selection is set to 0 (= invalid).
No. 21 "Servomotor Gear Ratio"	Gear ratio on the motor side. *The setting of this parameter is invalid when the electronic gear selection is set to 0 (= invalid)
No. 22 "Machine Gear Ratio"	Gear ratio on the machine side. *The setting of this parameter is invalid when the electronic gear selection is set to 0 (= invalid)

The meanings and examples of settings of the above parameters are shown below.

Table 3.3 Electronic Gear Parameters/Constants

Motion fixed parameter No.	Name	Description	Initial value		
No.19	Travel Distance per Machine Rotation	<p>• This parameter represents the amount of load movement per rotation on the load axis. Set the value obtained by dividing the amount of load movement by the reference unit.</p> <p style="text-align: center;">Amount of load movement per rotation on the load axis</p> <p>No.19 = $\frac{\text{Reference unit}}$</p> <p>• An example of the amount of load movement is shown below.</p>	10000		
		Travel Distance per Machine Rotation		Loading example	
		P[mm]		Ball screw	 <p>One rotation</p> <p>P = ball screw pitch</p>
		360[°]		Rotary table	 <p>360°</p> <p>One rotation</p>
		πD [mm]		Belt	 <p>One rotation</p> <p>πD</p> <p>D</p>
		<p>• No. 19 setting range: 1 to 2³-1[1 = 1 designated unit]</p> <p>Setting example</p> <p>• Amount of load movement per rotation on the load axis = 12 mm</p> <p>• Reference unit = 0.001 mm</p> <p>In this case,</p> <p style="text-align: center;">No.19 = $\frac{12 \text{ mm}}{0.001 \text{ mm}} = 12000$ is set.</p>			

Table 3.3 Electronic Gear Parameters/Constants (Cont'd)

Motion fixed parameter No.	Name	Description	Initial value
No.21	Servomotor Gear Ratio	<ul style="list-style-type: none"> These parameters are used for setting the gear ratio between the motor and load. The following two values are set for a configuration in which the load shaft will turn n times in response to m turns of the motor shaft. 	1
No.22	Machine Gear Ratio	<p>No.21 = m</p> <p>No.22 = n</p> <ul style="list-style-type: none"> Setting range: 1 to 65535 [rotations] <p>Setting example</p>  <p>In this case,</p> $\text{the reduction gear ratio} = \frac{n}{m} = \frac{3}{7} \times \frac{4}{9} = \frac{4}{21}$ <p>Therefore, set as follows:</p> <p>No.21 = 21</p> <p>No.22 = 4</p>	1

● An example of electronic gear parameter settings (A) ... ball screw

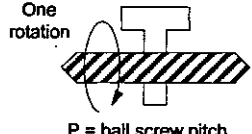
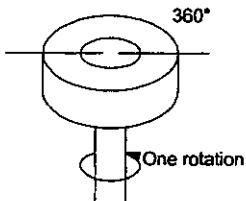
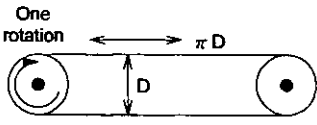
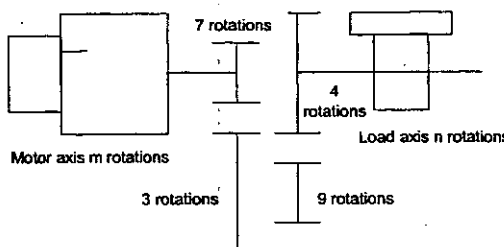
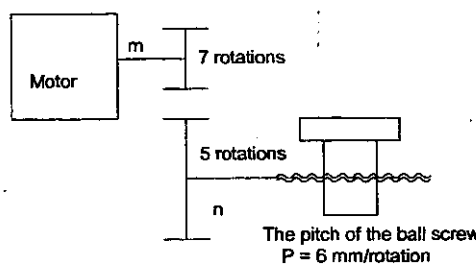

The pitch of the ball screw
P = 6 mm/rotation

In order to make "reference unit" = "output unit" = 0.001 mm in the above mechanical system, set each parameter as follows:

• No.19 = $\frac{6 \text{ mm}}{0.001 \text{ mm}} = \boxed{6000}$

• Reduction ratio = $\frac{n}{m} = \frac{5}{7}$

• No.21 = $\boxed{7}$

• No.22 = $\boxed{5}$

● An example of electronic gear parameter settings (B) ... rotary load

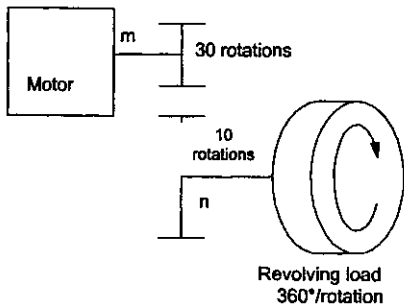

In order to make "input unit" = "output unit" = 0.1° in the above mechanical system, set each parameter as follows:

- No.19 = $\frac{360^\circ}{0.1^\circ} = \boxed{3600}$
- Reduction ratio = $\frac{n}{m} = \frac{10}{30} = \frac{1}{3}$
- No.21 = $\boxed{3}$
- No.22 = $\boxed{1}$

(3) Axis selection

There are two types of position controls: finite-length position control within a specified range such as a reciprocating motion, and infinite-length position control for rotating only in one direction. Furthermore, there are two types of infinite-length position controls: resetting to 0 with one rotation such as a belt conveyor, and rotating only in one direction without resetting even after one rotation. For axis selection, choose which position control to use. Set the axis selection by Bit 5 of motion fixed parameter No. 17 "Motion Controller Function Selection Flags."

Table 3.4 Setting of Axis Selection

Type of position control	Setting of axis selection
Finite-length position control	Finite-length axis (=0)
Infinite-length position control for rotating only in one direction without resetting even after one rotation	Finite-length axis (=0)
Infinite-length position control by resetting with one rotation (Set the reset position by motion fixed parameter No. 23 "Infinite-length axis reset position.")	Infinite-length axis (=1)

(4) Position references

There are two types of position reference settings: direct designation, setting a position reference direct to OL□□12, and indirect designation, setting the No. of the position buffer storing a position reference to OL□□12. Furthermore, there are two types of direct designations: absolute position designation, setting an absolute position to OL□□12, and incremental designation, setting the sum of the previous position reference value (previous value of OL□□12) and the current amount of movement to OL□□12.

In the case of indirect designation, setting the position buffer No., the position stored in the position buffer is regarded as an absolute position.

Parameters related to position references are shown in Table 3.5.

Table 3.5 Position Reference Parameters

Types of Parameter	Parameter No. (Register No.)	Name	Description	Initial Value
Motion Setting Parameter	Bit 12 of OW□□01	Position Reference Value Selection	Set the method of designating the position reference. 0: direct designation Set the position data direct to OL□□12. Designate whether the position data is absolute or incremental by Bit 14 of OW□□01. 1: indirect designation Set the position buffer No. to OL□□12. An absolute position must have been stored in the designated position buffer in advance.	0
	Bit 14 of OW□□01	Position Reference Type	Designate the type of position data. 0: absolute Set an absolute position to OL□□12. 1: incremental Set the sum of the previous value of OL□□12 and the current amount of movement to OL□□12. (Note) This is invalid when the Position Reference Value Selection (Bit 12 of OW□□01) is set to indirect designation (position buffer).	0
	OL□□12	Position Reference Setting	Set the position data. (Note) Setting data differs according to the settings of the Position Reference Value Selection (Bit 12 of OW□□01) and Position Reference Type (Bit 14 of OW□□01).	0

Table 3.6 Position Reference Selection

Position Reference Value Selection (Bit 12 of OW□□01)	Position Reference Type (Bit 14 of OW□□01)	Position Reference Setting (OL□□12)
0 (Direct designation)	0 (Absolute position method)	Set an absolute position. (Example) OL□□12←10000 OL□□12←20000
	1 (Increment addition method)	Set the sum of the previous value of OL□□12 and the current amount of movement (incremental amount). OL□□12← previous OL□□12+ incremental amount of movement (Example) When the previous OL□□12 = 1000 and current amount of movement = 500, OL□□12←1000+500 = 1500
1 (Indirect designation)	0	Set the position buffer No. An absolute position must have been stored in the designated position buffer in advance.

In the case of infinite-length axis, set a new position reference (OL□□12) by adding the current amount of movement (incremental amount) to the previous position reference (OL□□12).

Position Reference (OL□□12) should not be set within the range from 0 to (infinite-length axis res position - 1).

What is the position buffer?

A group of position data for each axis can be stored in the buffer (position buffer) in the SVB module. By designating the "buffer No." as position data (OL□□12), the same operation as by referring an absolute position on a program can be performed. The position buffer has a capacity of 256 points × 14 axes.

Note

The data in the position buffer is erased by turning OFF the power or resetting the master of the CPU module. Therefore, make sure to set the buffer at turning ON the power or before using the position buffer.

◆ **Writing the position buffer data**

Prepare the position buffer in advance using the motion parameters shown in Table 3.7

Table 3.7 Parameters for Preparing the Position Buffer

Name	Register No.	Setting Range	Description
Position Buffer Access No.	OL□□38	1 to 256	Setting of position buffer No.
Position Buffer Write Data	OL□□3A	-2^{31} to $2^{31}-1$	Setting of data to be written to the position buffer
Motion Command Control Flags (MCMDCTRL)	OB□□21E (Bit 14 of OW□□21)	0 or 1	Writing position buffer data 0: No processing 1: Write

◆ **Reading position buffer data**

By using the motion parameters in Table 3.8, data in the position buffer can be read to motion monitoring parameters. This is used for checking data, etc. Note that it takes two scans (H scans) from issuing the read command to setting the motion monitoring parameter (IL□□28) data.

Table 3.8 Parameters for Reading the Position Buffer Data

Name	Register No.	Setting Range	Description
Position Buffer Access No.	OL□□38	1 to 256	Setting of position buffer No.
Motion Command Control Flags (MCMDCTRL)	OB□□21F (Bit 15 of OW□□21)	0 or 1	Reading position buffer data 0: No processing 1: Read
Position Buffer Read Data	IL□□28	-2^{31} to $2^{31}-1$	Data read from the position buffer

◆ **Using the position buffer data as position commands**

By using the motion parameters in Table 3.9, data in the position buffer can be used as position reference values.

Table 3.9 Motion Parameters

Name	Register No.	Setting Range	Description
Position Reference Setting (XREF)	OL□□12	1 to 256	Set the position buffer No. instead of the position reference value.
RUN Command Settings (SVRUNCMD)	OB□□01C (Bit 12 of OW□□01)	0 or 1	Select to use the position buffer 0: Data of XREF(OL□□12) is the position reference value 1: Data of XREF(OL□□12) is the position buffer No.

(5) Position monitoring

Position monitoring parameters are shown in Table 3.10.

Table 3.10 Motion Parameters

Motion Monitoring Parameter No. (register No.)	Name	Description
IL□□02	Calculated Position in Machine Coordinate System (CPOS)	A calculated position in the machine coordinate system which is controlled by this module is reported. Normally, the position data reported to this parameter is the target position for every scan. (Note) If Axis Selection is set to infinite-length axis, the range from 0 to (infinite-length axis reset position - 1) is reported. In the case of infinite-length axis, set a new Position Reference (OL□□12) by adding the current amount of movement (incremental amount) to the previous position reference (OL□□12). Note that the Position Reference (OL□□12) should not be set within the range from 0 to (infinite-length axis reset position - 1).
IL□□08	Machine Coordinate System Feedback Position (APOS)	A feedback position in the machine coordinate system is reported. (Note) If Axis Selection is set to infinite-length axis, the range from 0 to (infinite-length axis reset position - 1) is reported.
IL□□18	Machine Coordinate System Reference Position	The position output to the outside by this module, a reference position on the machine coordinate system, is reported. This data is not updated in the machine lock condition. (No output is made to the outside in the machine lock condition.) When the machine lock function is not used, the position is the same as that of IL□□02.
IL□□2E	Calculated Reference Coordinate System Position	This parameter works when the axis selection is set to infinite-length axis. When set to infinite-length axis, the target position for every scan corresponding to the position reference is reported to this parameter. (Note) When set to finite-length axis, the position is the same as that of IL□□02.

◆ What is the machine coordinate system?

This is a basic coordinate system which is set by executing the zero point return mode: the motion command "Zero Point Return (ZRET)" or the motion command "Zero Point Setting (ZSET)".

This module controls positions by using this machine coordinate system.

(6) Speed references

There are two types of setting of speed references such as rapid feed speed: setting in reference unit, and setting in percentage (%) relative to the rated rotation speed. Speed reference parameters are shown in Table 3.11.

Table 3.11 Motion Parameters

Type of parameter	Parameter No. (Register No.)	Name	Description
Motion Fixed Parameter	No.5	Pulse Counting Mode Selection	Set the pulse counting method and the number of multiplication. 4: A/B method (multiplied by 1) 5: A/B method (multiplied by 2) 6: A/B method (multiplied by 4)
	No.7	Rated Motor Speed Setting	Set the number of rotations for the motor running at the rating (100% speed).
	No.8	Number of Feedback Pulses per Rotation	Set the number of pulses (value before multiplication) per motor rotation.
Motion Setting Parameter	Bit 13 of OW□□01	Speed Reference Value Selection	Designate the feed speed setting unit and the feed speed register No. 0: OL□□22 (unit: 10 ⁿ reference unit/min) is used as the feed speed. 1: OW□□15 (unit: % (1 = 0.001%) relative to the rated rotation speed) is used as the feed speed.
	OW□□15	Speed Reference Setting	This is valid when the Speed Reference Value Selection (Bit 13 of OW□□01) is set to "1." Set the feed speed in percentage (1 = 0.001%) relative to the rated rotation speed. (Note) This is invalid when the Speed Reference Value Selection is set to "0."
	OL□□22	Rapid Feed Speed	This is valid when the Speed Reference Value Selection (Bit 13 of OW□□01) is set to "0." Set the feed speed in reference unit. 1 = 10 ⁿ reference unit/min (n: number of decimal places) The speed differs according to the unit selection as follows: In pulses : 1 = 1000 pulses/min In mm : 1 = 1 mm/min In deg : 1 = 1 deg/min In inches : 1 = 1 inch/min
	OW□□2C	Override	The feed speed setting value can be changed for use. (Note) "Override" means changing and using the setting value of feed speed. Whether the override is valid or invalid is set by Bit 9 "Override Selection" of motion fixed parameter No. 17 "Motion Controller Function Selection Flags." If it is set to invalid, the speed is 100% of the feed speed setting value.

Examples of parameter settings are shown in Table 3.12.

Table 3.12 Examples of Parameter Settings

Types of Parameter	Parameter No. (Register No.)	Name	Description	Initial Value
Motion Fixed Parameter	No.5	Pulse Counting Mode Selection	No. 5 = A/B method (multiplied by 4) No. 7 = 3000 r/min No. 8 = 2048 p/r Therefore, the rated rotation speed = 3000 r/min = 3000 × 2048 × 4 (multiplier) = 24576000 p/min	A/B method (multiplied by 4)
	No.7	Rated Motor Speed Setting		3000
	No.8	Number of Feedback Pulses per Rotation		2048
Motion Setting Parameter	Bit 13 of OW□□01	Speed Reference Value Selection	(1) When the Speed Reference Value Selection is set to "0": ① In pulses: In order to operate the feed speed at 1500 r/min with the above fixed parameter settings, OW□□15 = — (invalid) OL□□22 = $1500(\text{r/min}) \times 2048 \times 4(\text{p/r}) \div 1000 = 12288$ Ow□□2C = 10000(100%) ② In mm: In order to operate the feed speed at 900 mm/min with the above fixed parameter settings on the machine having such a structure that moves 10 mm per rotation, OW□□15 = — (invalid) OL□□22 = 900 OW□□2C = 10000(100%) (2) When the Speed Reference Value Selection is set to "1," in order to operate the feed speed at 1500 r/min with the above, $\text{OW} \square \square 15 = \frac{1500(\text{r/min})}{3000(\text{r/min})} \times 10000 = 5000(50.00\%)$ OW□□22 = — (invalid) OW□□2C = 10000(100%) (3) To halve the operating speed with the above speed reference settings, OW□□2C = 5000(50.00%) (Note) Set Bit 9 "Override Selection" of motion fixed parameter No. 17 to 1 (= valid).	0
	OW□□15	Speed Reference Setting		0
	OL□□22	Rapid Feed Speed		0
	Ow□□2C	Override		100%

3.2 Positioning (POSING)

Positioning is performed at the referenced position with the designated acceleration time constant and at the designated rapid feed speed. The rapid feed speed and position reference value can be changed even during operation. If the changed position reference value cannot secure a deceleration distance or is in the reverse direction, the operation is decelerated to stop, and then positioning is performed again at the position reference value.

Positioning on each axis is performed as follows.

The register Nos. are intended for the first axis of module No. 1. If the module No. and/or axis No. is different, reread the register Nos., referring to 1.3 "Module No. and Motion Parameter Register No." Motion parameters to be used for positioning are marked with "○" in the "Positioning" column under "Motion Command Code" in 5.1.2 "List of Motion Setting Parameters" and 5.1.3 "List of Motion Monitoring Parameters."

[Example]

- ① Set the motion fixed parameters and the initial values of the motion setting parameters that suit your machine.
 - (Note) Make sure to set Bit 7 (Motion Command Use Selection) of motion parameter No. 14 "Additional Function Use Selection" to 1 (= use).
Also, make sure to set Bit 8 (Motion Command Code Validity Selection) of the motion setting parameter "RUN Mode Settings (OW□□00)" to 1 (= valid).
- ② Select the Position Control Mode (PCON) (Bit 2 of OWC000).
- ③ Set the Position Reference Setting (OLC012) and Rapid Feed Speed (OLC022 or OWC015).
Set motion setting parameters to be used for Positioning (POSING) such as the Linear Acceleration Time Constant (OWC00C) and the Filter Time Constant (OWC014), if necessary.
- ④ Turn the Servo ON (RUN) (Bit 0 of OWC001).
- ⑤ Set Positioning (POSING) to the Motion Command Code (OWC020).
- ⑥ By setting Positioning (POSING) to the Motion Command Code, positioning is performed on the axis in accordance with the designated motion parameters.
The feed speed and position reference value can be changed even during positioning operation.
To hold positioning, turn ON HOLD (Bit 1 of OWC021).
Upon completion of holding, HOLDL (Bit 1 of IWC015) is turned ON.
To cancel holding, turn OFF HOLD (Bit 0 of OWC021).
To abort positioning, turn ON ABORT (Bit 1 of OWC021) or set NOP (= 0) to the Motion Command Code.
During abort, BUSY (Bit 0 of IWC015) is turned ON, and upon completion of abort, it is turned OFF.
(Note) If abort is canceled (ABORT is turned OFF) at the time of completion of abort:
 - With the Position Reference Type (Bit 14 of OWC001) absolute (= 0), positioning is restarted toward the Position Reference (OLC012).
 - With the Position Reference Type (Bit 14 of OWC001) incremental (= 1), positioning is kept stopped until a new Position Reference (OLC012) is set.
- ⑦ When the Positioning completion range (OWC00E) is reached after issuing is completed (Bit 2 of IWC015 is turned ON), the Positioning completion signal POSCOMP (Bit D of IWC000) is turned ON.

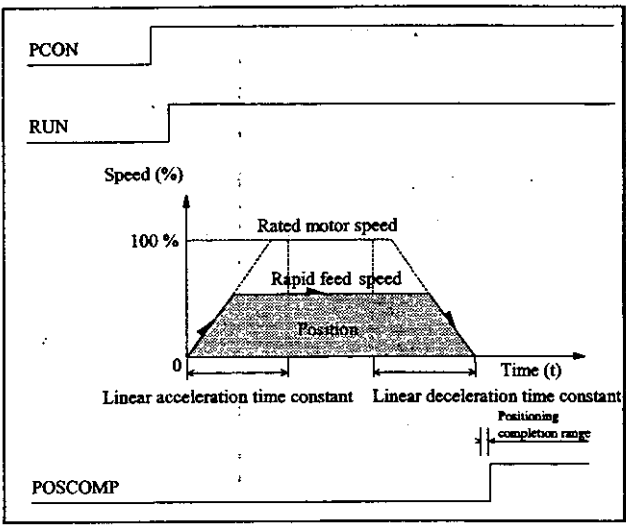
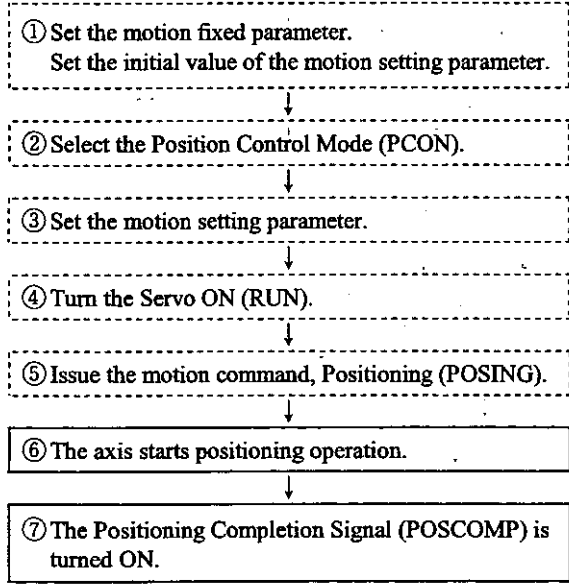

The operation in should be performed by the user.
 The operation in should be executed by the system.

◆ An example of user programs (point-to-point positioning)

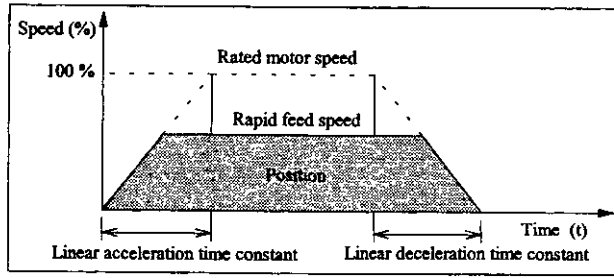

Fig. 3.1 An Example of Positioning Patterns

<Preconditions>

The motion fixed parameters and the initial values of the motion setting parameters are the same as in 5.3 "Examples of Motion Parameter Settings."

<Operating conditions>

In the pattern shown in Fig. 3.1, the operation stops at an absolute position of 10000 pulses.

Position reference: OLC012 = 10000 pulses

In this example, the first axis of module No. 1 is used.

If the module No. and/or axis No. is different, reread the register Nos., referring to 1.3 "Module No. and Motion Parameter Register No."

For details of the registers (OW□□□□) in use, refer to Chapter 5 "Motion Parameters."

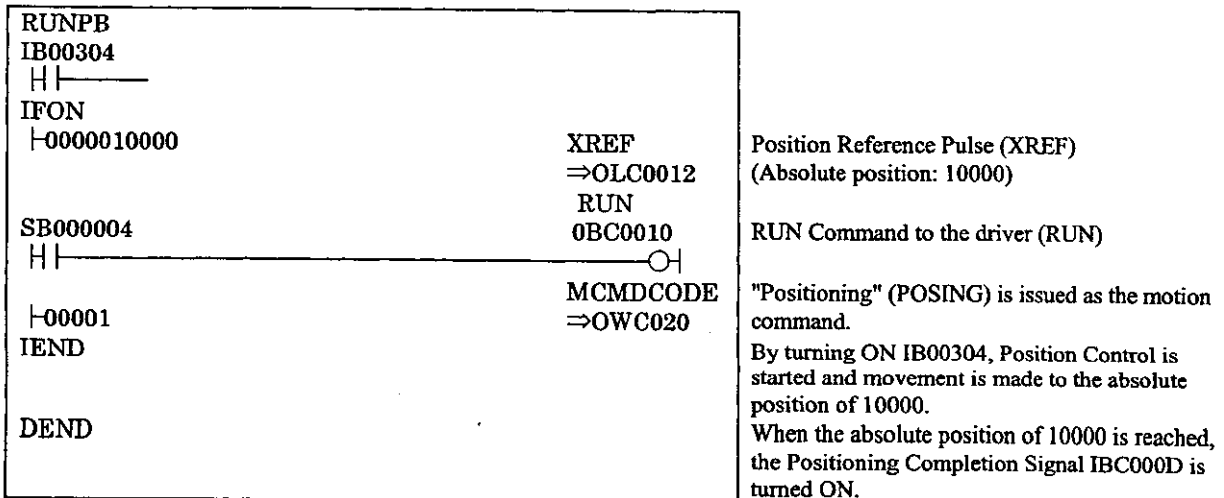

Fig. 3.2 An Example of Positioning Programs (DWG H03)

The example in Fig. 3.2 is simplified, but each register can be freely controlled by user programs.

3.3 External Positioning (EX_POSING)

In the same way as Positioning (POSING), positioning is performed at the referenced position with the designated acceleration time constant and at the designated rapid feed speed. If a LATCH signal (external positioning signal) is input during operation at the feed speed, the current position is latched according to the LATCH signal, and positioning is performed by moving from that position at the external positioning travel distance set by the corresponding parameter. The rapid feed speed and position reference value can be changed even during operation.

If a deceleration distance cannot be secured within the set external positioning travel distance, the operation is decelerated to stop, and then positioning is performed again at the target position.

Until just before the LATCH signal (external positioning signal) is input, the external positioning travel distance can be changed. As a LATCH signal (external positioning signal), a special discrete input (EXM signal) is used.

External positioning on each axis is performed as follows.

The register Nos. are intended for the first axis of module No. 1. If the module No. and/or axis No. is different, reread the register Nos., referring to 1.3 "Module No. and Motion Parameter Register No." Motion parameters to be used for external positioning are marked with "○" in the "External Positioning" column under "Motion Command Code" in 5.1.2 "List of Motion Setting Parameters" and 5.1.3 "List of Motion Monitoring Parameters."

[Example]

- ① Set the motion fixed parameters and the initial values of the motion setting parameters that suit your machine.
(Note) Make sure to set Bit 7 (Motion Command Use Selection) of motion parameter No. 14 "Additional Function Use Selection" to 1 (= use).
Also, make sure to set Bit 8 (Motion Command Code Validity Selection) of the motion setting parameter "RUN Mode Setting (OW□□00)" to 1 (= valid).
- ② Select the Position Control Mode (PCON) (Bit 2 of OWC000).
- ③ Set the Position Reference Setting (OLC012), Rapid Feed Speed (OLC022 or OWC015) and External Positioning Travel Distance (OLC024).
Set motion setting parameters to be used for External Positioning (EX_POSING) such as the Linear Acceleration Time Constant (OWC00C) and the Filter Time Constant (OWC014), if necessary.
- ④ Turn the Servo ON (RUN) (Bit 0 of OWC001).
- ⑤ Set External Positioning (EX_POSING) to the Motion Command Code (OWC020).
- ⑥ By setting External Positioning (EX_POSING) to the Motion Command Code, positioning is performed on the axis in accordance with the designated motion parameters. The rapid feed speed and position reference value can be changed even during positioning operation.
To hold external positioning, turn ON HOLD (Bit 1 of OWC021). Upon completion of holding, HOLDL (Bit 1 of IWC015) is turned ON. To cancel holding, turn OFF HOLD (Bit 1 of OWC021).
To abort positioning, turn ON ABORT (Bit 1 of OWC021) or set NOP (= 0) to the Motion Command Code.
During abort, BUSY (Bit 0 of IWC015) is turned ON, and upon completion of abort, it is turned OFF.
(Note) Even if abort is canceled (ABORT is turned OFF) at the time of completion of abort, positioning is kept stopped regardless of whether the Position Reference Type (Bit 14 of OWC001) is absolute (= 0) or incremental (= 1).
- ⑦ When the Positioning completion range (OWC00E) is reached after issuing is completed (Bit 2 of IWC015 is turned ON), the Positioning completion signal POSCOMP (Bit D of IWC000) is turned ON.
- ⑧ When positioning is completed, cancel the motion command "External Positioning."
(Note) Since the rise of external positioning is detected, once you have executed external positioning, you must set NOP to the motion command and set External Positioning again to the motion command.

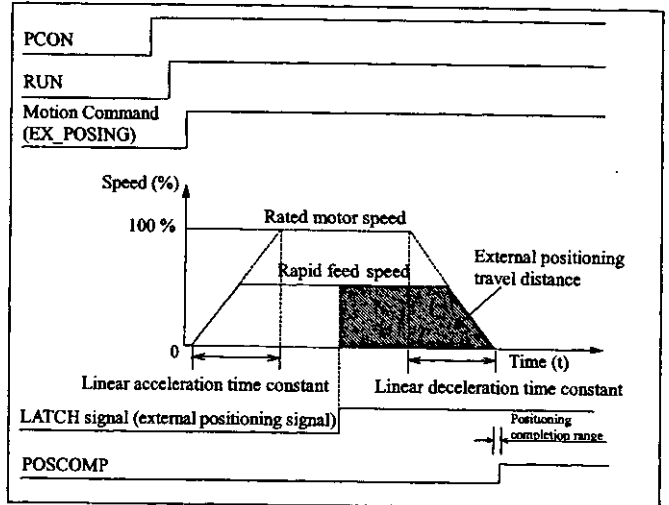
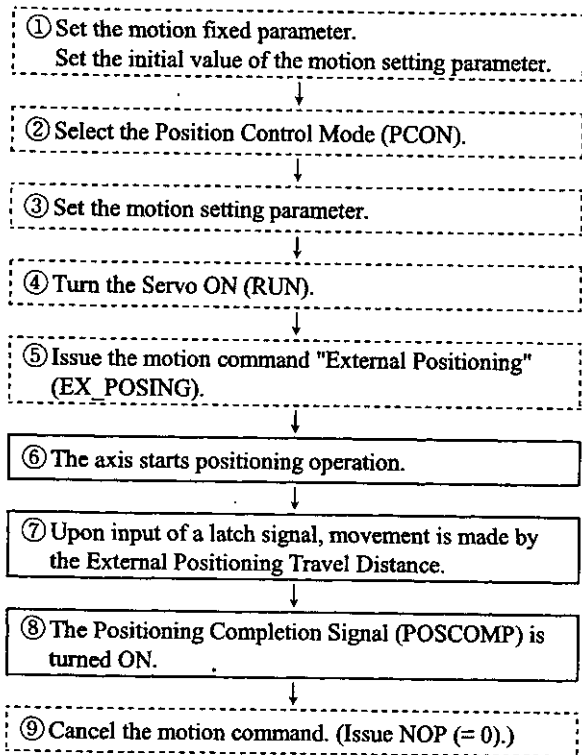

The operation in should be executed by the system.

The operation in should be performed by the user.

◆ An example of user programs (external positioning)

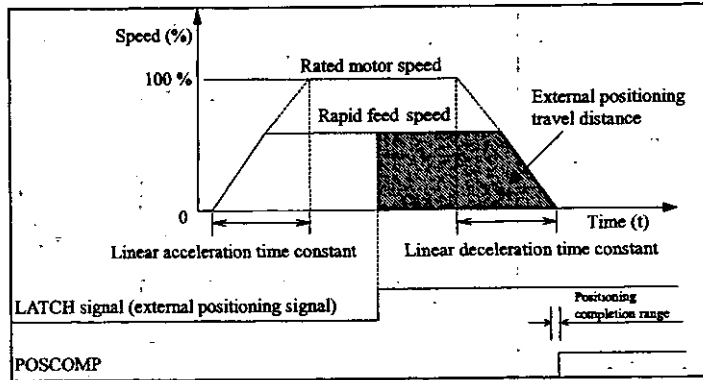

Fig. 3.3 An Example of External Positioning Patterns

<Preconditions>

The motion fixed parameters and the initial values of the motion setting parameters are the same as in 5.3 "Examples of Motion Parameter Settings."

<Operating conditions>

In the pattern shown in Fig. 3.3, the operation stops at an external positioning travel distance of 10000 pulses.

External positioning travel distance: OLC024 = 10000 pulses

In this example, the first axis of module No. 1 is used.

If the module No. and/or axis No. is different, reread the register Nos., referring to 1.3 "Module No. and Motion Parameter Register No."

For the details of the registers (OW□□□□) in use, refer to Chapter 5 "Motion Parameters."

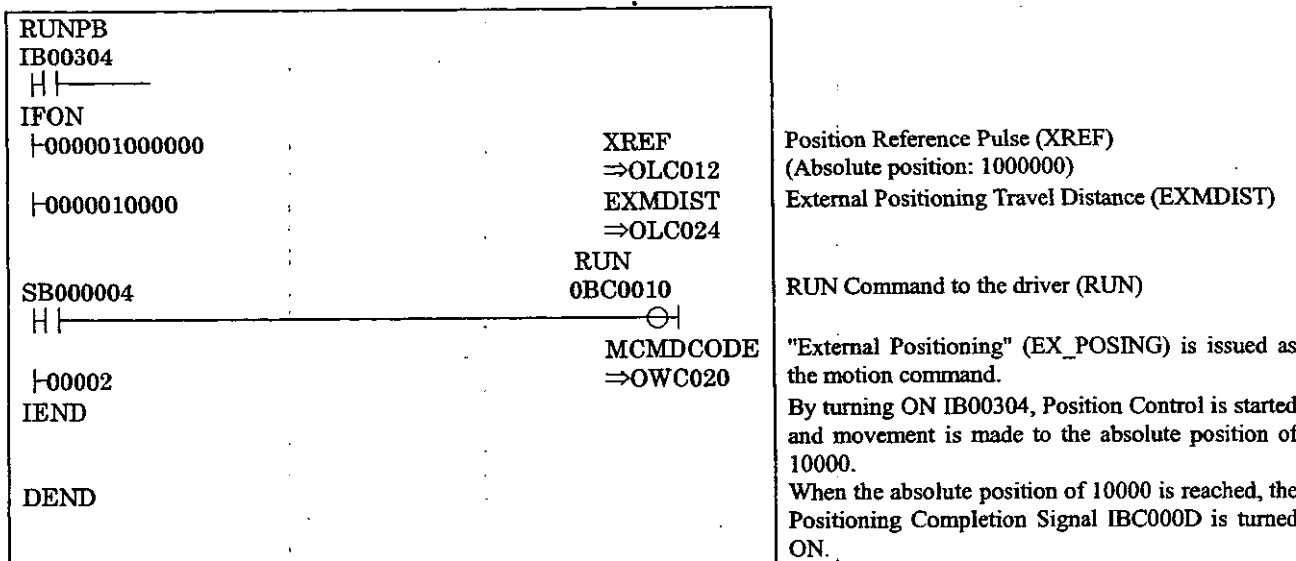

Fig. 3.4 An Example of Positioning Programs (DWG H03)

The example in Fig. 3.4 is simplified, but each register can be freely controlled by user programs

3.4 Zero Point Return (ZRET)

"Zero Point Return" is an operation to return to the zero point in the machine coordinate system. Since the position data of the zero point in the machine coordinate system is erased when the power is cut off, the zero point must be newly decided in the machine coordinate system after power is turned ON. The types of zero point return operations are shown in the table below.

Table 3.13 Types of zero point return (ZRN) operation

Name	Method
DEC + Phase-C Pulse	Three-stage deceleration method by deceleration LS and Phase-C pulse
ZERO Signal	Zero point return method by ZERO signal
DEC + ZERO Signal	Three-stage deceleration method by deceleration LS and ZERO signal
Phase-C Pulse	Zero point return method by Phase-C pulse

3.4.1 DEC + Phase-C Pulse

This method has three speed levels.

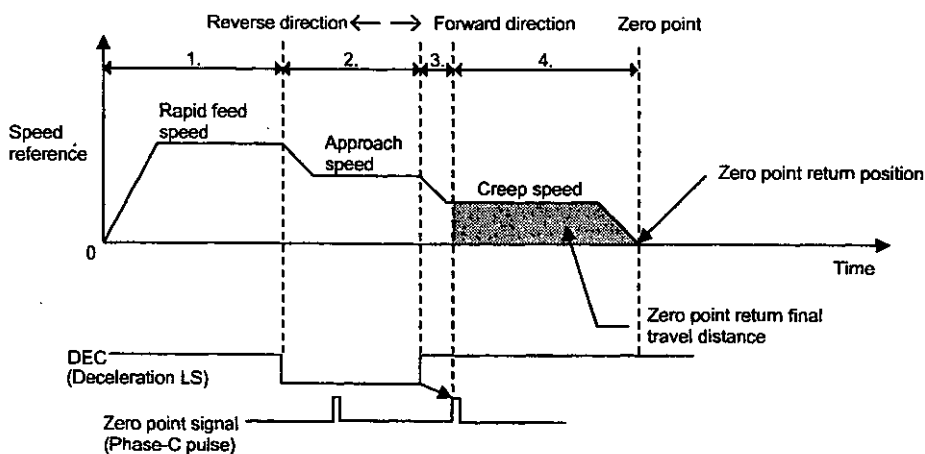

Fig. 3.5 DEC + Phase-C Pulse

- ① Movement is started in the direction designated by the parameter "Zero Point Return Direction." At this time, the speed corresponds to the value designated by the parameter "Rapid Feed Speed."
 - Setting parameter OW□□00 "RUN Mode Setting b9: Zero Point Return Direction "
 - Setting parameter OW□□22 "Rapid Feed Speed"
- ② When the DEC set for deceleration turns ON the deceleration LS, the feed speed is decelerated to the value of the parameter "Approach Speed."
 - SERVOPACK user constant Cn-0022 "Zero Point Approach Speed 1"
- ③ After the DEC is detached from the deceleration LS, the speed is changed to the value of the parameter "Creep Speed" at the first Phase-C position.
 - SERVOPACK user constant Cn-0023 " Zero Point Approach Speed 2"
- ④ The position that is moved from where the Phase-C pulse was detected at the creep speed by the parameter "Zero Point Return Travel Distance" is taken as the zero point in the machine coordinate system.
 - SERVOPACK user constant Cn-0028 "Zero Point Return Final Travel Distance"

3.4.2 ZERO Signal

In place of the Phase-C pulse of the Phase-C pulse method, this method uses the ZERO signal to return to the zero point.

This method uses just the ZERO signal to return to the zero point in machines that are not equipped with deceleration LS and other capabilities.

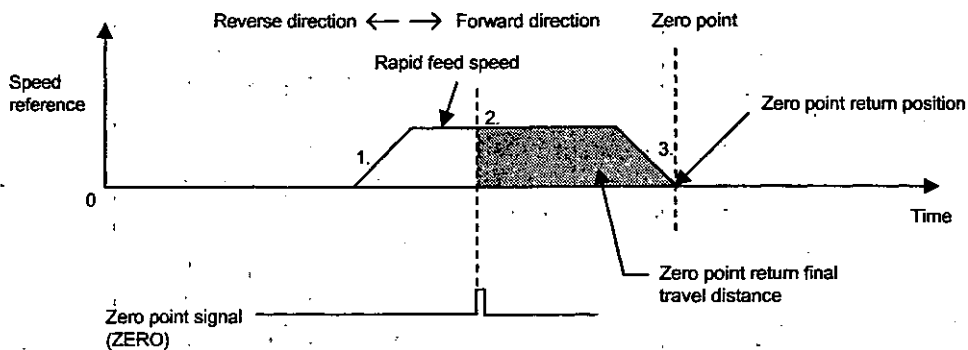

Fig. 3.6 ZERO Signal

- ① Movement is started in the direction designated by the parameter "Zero Point Return Direction." At this time, the speed corresponds to the value designated by the parameter "Rapid Feed Speed."
 - Setting parameter OW□□00 "RUN Mode Setting b9: Zero Point Return Direction"
 - Setting parameter OL□□22 "Rapid Feed Speed"
- ② The position that is moved from where the zero point LS was turned on by the distance set by the parameter "Final Travel Distance" is taken as the zero point on the machine coordinate system.
 - SERVOPACK user constant Cn-0028 "Zero Point Return Final Travel Distance"

3.4.3 DEC + ZERO signal

In place of the Phase-C pulse of the DEC + Phase-C pulse method, this method uses the ZERO signal to return to the zero point.

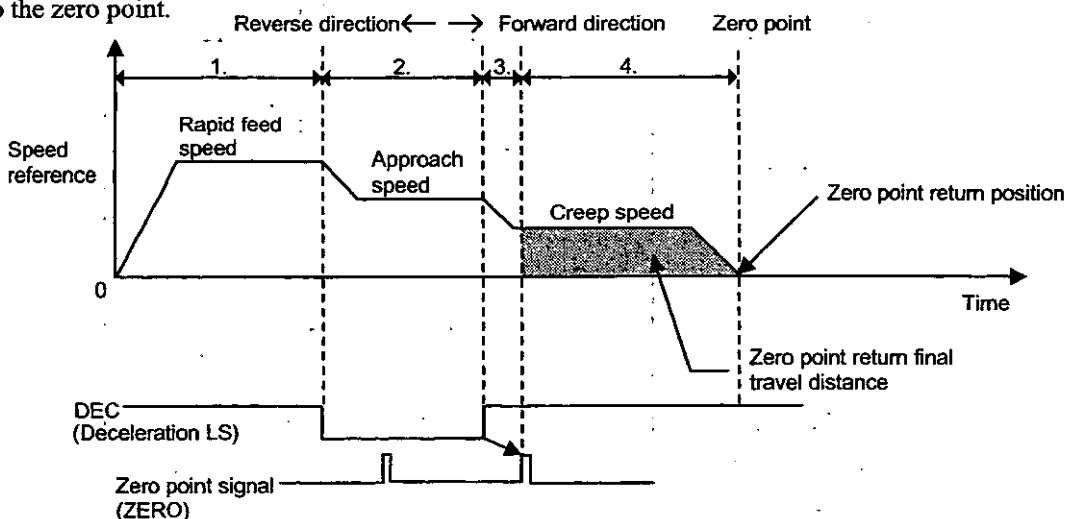

Fig. 3.7 DEC + ZERO Signal

3.4.4 Phase-C Pulse

This method uses just the Phase-C pulse of the Servomotor to return to the zero point in machines that are not equipped with deceleration LS and other capabilities.

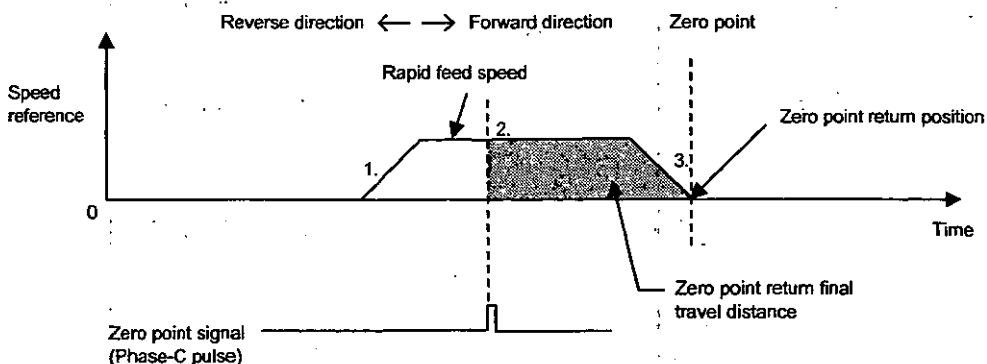

Fig. 3.8 Phase-C Pulse

3.4.5 An Example of Zero Point Return Methods

Zero point return on each axis is performed as follows. DEC + Phase-C Pulse is taken for example. The register Nos. are intended for the first axis of module No. 1. If the module No. and/or axis No. is different, reread the register Nos., referring to 1.3 "Module No. and Motion Parameter Register No." Motion parameters to be used for zero point return are marked with "○" in the "Zero Point Return" column under "Motion Command Code" in 5.1.2 "List of Motion Setting Parameters" and 5.1.3 "List of Motion Monitoring Parameters."

[Example]

- ① Set the motion fixed parameters and the initial values of the motion setting parameters that suit your machine.
 (Note) Make sure to set Bit 7 (Motion Command Use Selection) of motion fixed parameter No. 14 "Additional Function Use Selection" to 1 (= use).
 Make sure to set Bit 8 (Motion Command Code Validity Selection) of the motion setting parameter "RUN Mode Setting (OW□□00)" to 1 (= valid).
 Also, select DEC + Phase-C Pulse for Zero Point Return Method (No. 31 of fixed parameter).
- ② Select the Position Control Mode (PCON) (Bit 2 of OWC000).
- ③ Set the Rapid Feed Speed (OLC022 or OWC015).
 Set motion parameters to be used for Zero Point Return (ZRET) such as the Linear Acceleration Time Constant (OWC00C) and the Zero Point Return Final Travel Distance (OLC02A).
- ④ Turn the Servo ON (RUN) (Bit 0 of OWC001).
- ⑤ Set Zero Point Return (ZRET = 3) to the Motion Command Code (OWC020).
- ⑥ By setting Zero Point Return (ZRET) to the Motion Command Code, movement is made on the axis in the direction designated by the parameter "Zero Point Return Direction." The set values of the motion parameters cannot be changed during zero point return operation. Also, zero point return cannot be held.
 To abort positioning, turn ON ABORT (Bit 1 of OWC021) or set NOP (= 0) to the Motion Command Code.
 During abort, BUSY (Bit 0 of IWC015) is turned ON, and upon completion of abort, it is turned OFF.
 (Note) Even if abort is canceled (ABORT is turned OFF) at the time of completion of abort, positioning is kept stopped.
- ⑦ The speed is decelerated to the approach speed (SERVOPACK user constant Cn-0022 "Zero Point Approach Speed 1") on the falling edge of the dog (deceleration LS) signal.
- ⑧ After the dog (deceleration LS) signal is detached from the deceleration LS, the speed is decelerated to the creep speed (SERVOPACK user constant Cn-0023 "Zero Point Approach Speed 2").
- ⑨ The position moved from the first zero point signal (Phase-C pulse) by the Zero Point Return Final Travel Distance (SERVOPACK user constant Cn-0028 "Zero Point Return Final Travel Distance") after the DEC is detached from the deceleration LS is taken as the zero point in the machine coordinate system.
 A zero point position offset value can also be set. (When 100 is set as a zero point position offset value, the position data is 100.) Set the Zero Point Position Offset Value by the motion setting parameter (OLC006).
- ⑩ When the Positioning completion range (OWC00E) is reached after issuing is completed (Bit 2 of IWC015 is turned ON), the zero point return operation is completed. Upon completion of zero point return operation, the Zero point return completion status ZRNC (Bit 6 of IWC015) is turned ON.
- ⑪ After checking that the Zero point return completion status ZRNC (Bit 6 of IWC015) has been turned ON, set NOP (= 0) to the Motion Command Code (OWC020).

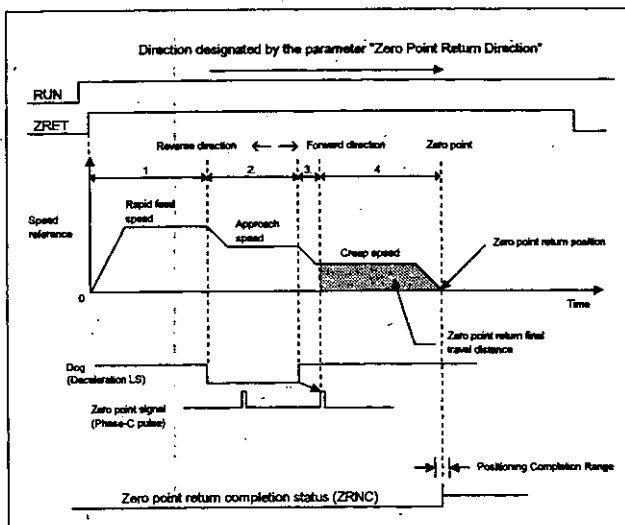
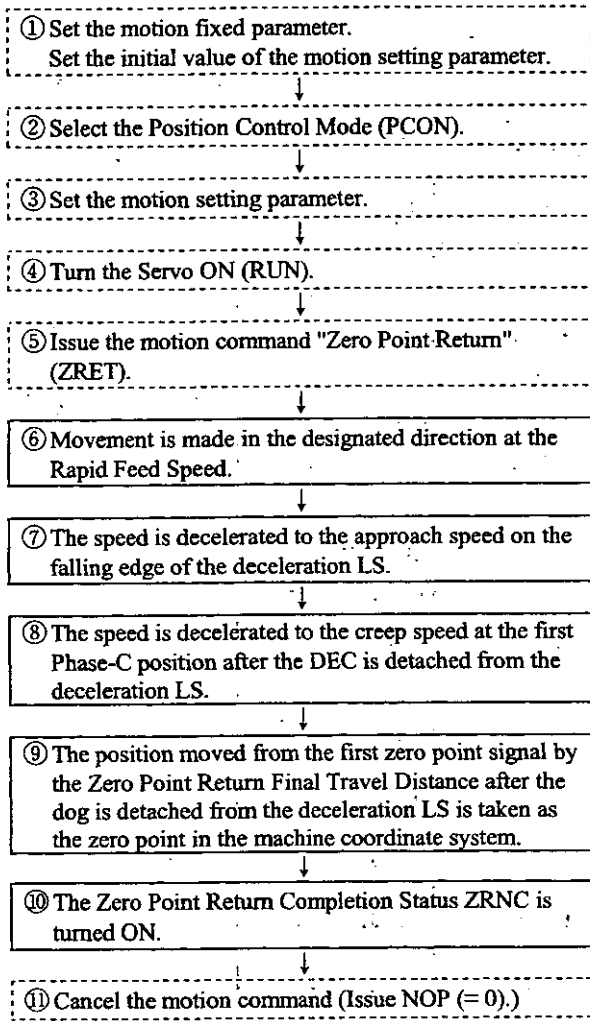

The operation in should be executed by the system.

The operation in should be performed by the user.

◆ An example of user programs (zero point return)

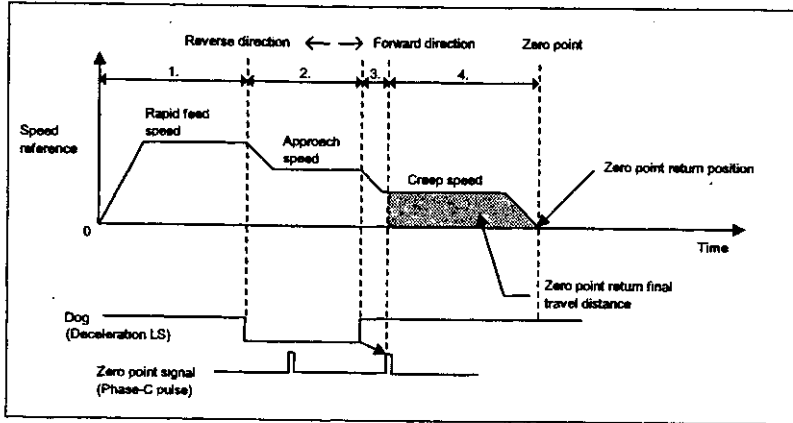

Fig. 3.9 An Example of Zero Point Return Patterns (DEC + Phase-C Pulse)

<Operating Conditions>

In the pattern shown in Fig. 3.9, zero point return is performed.

Zero point return method: DEC + Phase-C Pulse

In this example, the first axis of module No. 1 is used.

If the module No. and/or axis No. is different, reread the register Nos., referring to 1.3 "Module No. and Motion Parameter Register No."

For details of the registers (OW□□□□) in use, refer to Chapter 5 "Motion Parameters."

```

RUNPB
IB00304
H|-----
IFON
|0000005000          RV
                      =>OLC022
                      Rapid Feed Speed (RV)
                      (5000000 pulses/min.)
SB000004             RUN
H|-----             OBC0010
                      MCMDCODE
                      =>OWC020
                      "Zero Point Return" (ZRET) is issued as the motion
                      command.
                      By turning ON IB00304, Zero Point Return is started.
                      Upon completion of zero point return, the Zero Point
                      Return Completion Status (IBC0156) is turned ON.
                      After the Zero Point Return Completion Status
                      (IBC0156) is turned ON, set NOP (= 0) to the motion
                      command.
IEND
MCMDCODE
|IWC014              = 00003
                      ZRNC
                      IBC0156
DB000000             DB000000
H|-----             |-----
IFON
|00000              MCMDCODE
                      =>OWC020
IEND
DEND
    
```

Fig. 3.10 An Example of Zero Point Return Programs (DWG H03)

The example in Fig. 3.10 is simplified, but each register can be freely controlled by user programs.

◆ **Connection of the zero point return signals**

Connect the "Deceleration LS" and "ZERO signal" signals which are used for zero point return to 1CN of the SERVOPACK.

- "Deceleration LS" signal: 1CN Pin 9 Zero point deceleration LS (/DEC)
- "ZERO signal" signal: 1CN Pin 10 External latch input (/EXT)

◆ **Connection of the zero point return signals**

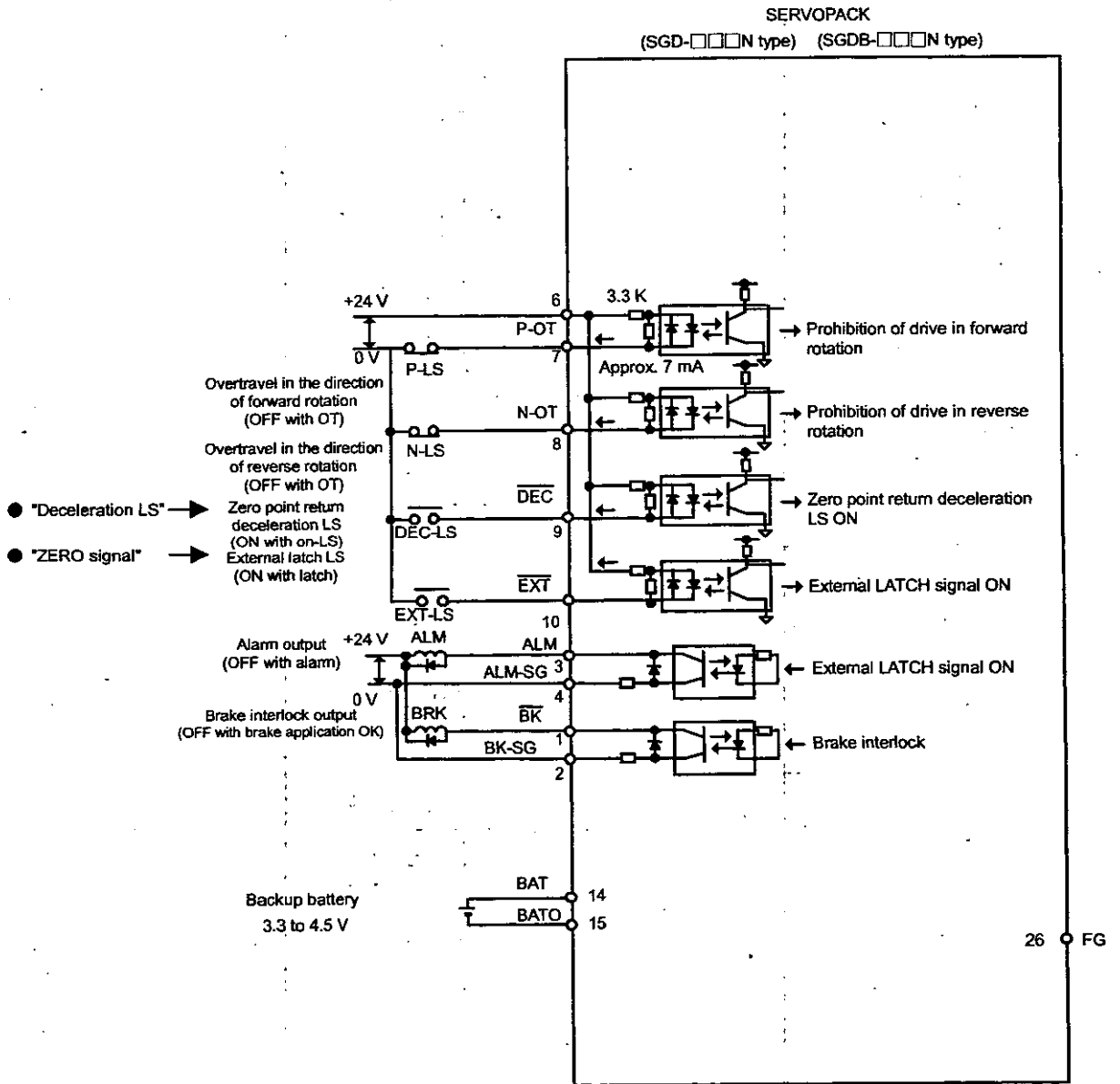

3.5 Interpolation (INTERPOLATE)

Interpolation feed is performed according to the moment-to-moment position data issued from the CPU module.

Interpolation feed on each axis is performed as follows.

The register Nos. are intended for the first axis of module No. 1. If the module No. and/or axis No. is different, reread the register Nos., referring to 1.3 "Module No. and Motion Parameter Register No." Motion parameters to be used for interpolation feed are marked with "○" in the "Interpolation" column under "Motion Command Code" in 5.1.2 "List of Motion Setting Parameters" and 5.1.3 "List of Motion Monitoring Parameters."

[Example]

- ① Set the motion fixed parameters and the initial values of the motion setting parameters that suit your machine.
(Note) Make sure to set Bit 7 (Motion Command Use Selection) of motion fixed parameter No. 14 "Additional Function Use Selection" to 1 (= use).
Also, make sure to set Bit 8 (Motion Command Code Validity Selection) of the motion setting parameter "RUN Mode Setting (OW□□00)" to 1 (= valid).
- ② Select the Position Control Mode (PCON) (Bit 2 of OWC000).
- ③ Set the Position Command (OLC012). Set motion setting parameters to be used for Interpolation (INTERPOLATE) such as the Filter Time Constant (OWC014), if necessary.
- ④ Turn the Servo ON (RUN) (Bit 0 of OWC001).
- ⑤ Set Interpolation (INTERPOLATE) to the Motion Command Code (OWC020).
- ⑥ By setting Interpolation (INTERPOLATE) to the Motion Command Code, interpolation feed is performed on the axis in accordance with the designated motion parameters.
- ⑦ Stop the update of the Position Reference (OLC012).
- ⑧ When the Positioning completion range (OWC00E) is reached after issuing is completed (Bit 2 of IWC015 is turned ON), the Positioning completion signal POSCOMP (Bit D of IWC000) is turned ON.

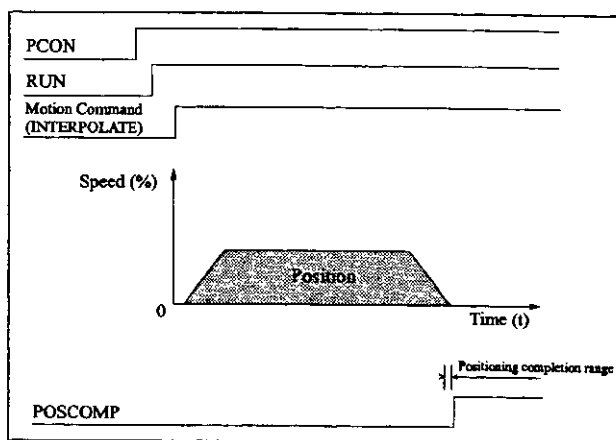
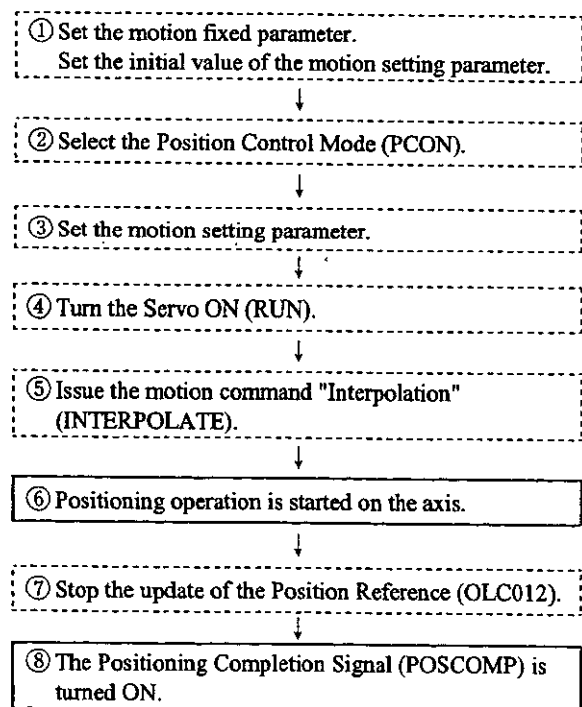

The operation in should be performed by the user.
The operation in should be executed by the system.

3.6 Interpolation with Position Detecting Function (LATCH)

While interpolation feed is performed in the same way as Interpolation (INTERPOLATE), the current position is latched according to the LATCH signal and the latched position converted in the reference unit system is reported.

As the LATCH signal, a special discrete input (EXM signal) is used. For details of interpolation operation refer to 3.5 Interpolation (INTERPOLATE).

(Note) To latch again after latching the current position counter by the LATCH signal, set NOP to the motion command, and then issue the LATCH command.

3.7 Constant Speed Feed (FEED)

Rapid feed is performed toward an infinite distance with the designated acceleration time constant and at the designated rapid feed speed. The rapid feed speed can be changed even during operation. By setting NOP (= 0) to the Motion Command Code (OW□□20), the operation is decelerated to stop.

Constant speed feed on each axis is performed as follows. The register Nos. are intended for the first axis of module No. 1. If the module No. and/or axis No. is different, reread the register Nos., referring to 1.3 "Module No. and Motion Parameter Register No." Motion parameters to be used for constant speed feed are marked with "○" in the "Constant Speed Feed" column under "Motion Command Code" in 5.1.2 "List of Motion Setting Parameters" and 5.1.3 "List of Motion Monitoring Parameters."

[Example]

- ① Set the motion fixed parameters and the initial values of the motion setting parameters that suit your machine.
(Note) Make sure to set Bit 7 (Motion Command Use Selection) of motion fixed parameter No. 14 "Additional Function Use Selection" to 1 (= use).
Also, make sure to set Bit 8 (Motion Command Code Validity Selection) of the motion setting parameter "RUN Mode Setting (OW□□00)" to 1 (= valid).
- ② Select the Position Control Mode (PCON) (Bit 2 of OWC000).
- ③ Set the Rapid Feed Speed (OLC022 or OWC015).
Set motion setting parameters to be used for Constant Speed Feed (FEED) such as the Linear Acceleration Time Constant (OWC00C) and the Filter Time Constant (OWC014), if necessary.
- ④ Turn the Servo ON (RUN) (Bit 0 of OWC001).
- ⑤ Set Constant Speed Feed (FEED) to the Motion Command Code (OWC020).
- ⑥ By Setting Constant Speed Feed (FEED) to the Motion Command Code, rapid feed is performed on the axis in accordance with the designated motion parameters.
Rapid feed cannot be held.
- ⑦ To stop (abort) rapid feed, set NOP (= 0) to the Motion Command Code (OWC020).
- ⑧ When the Positioning completion range (OWC00E) is reached after issuing is completed (Bit 2 of IWC015 is turned ON), the Positioning completion signal POSCOMP (Bit D of IWC000) is turned ON.

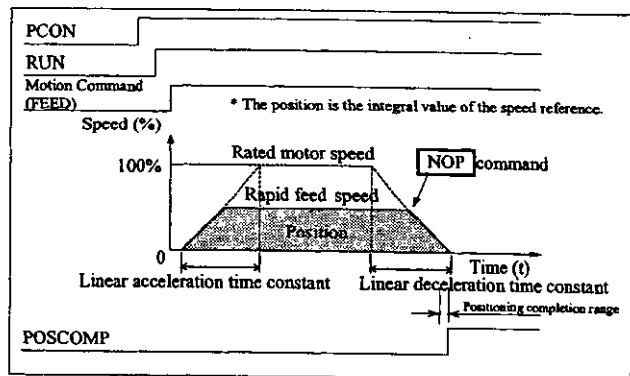
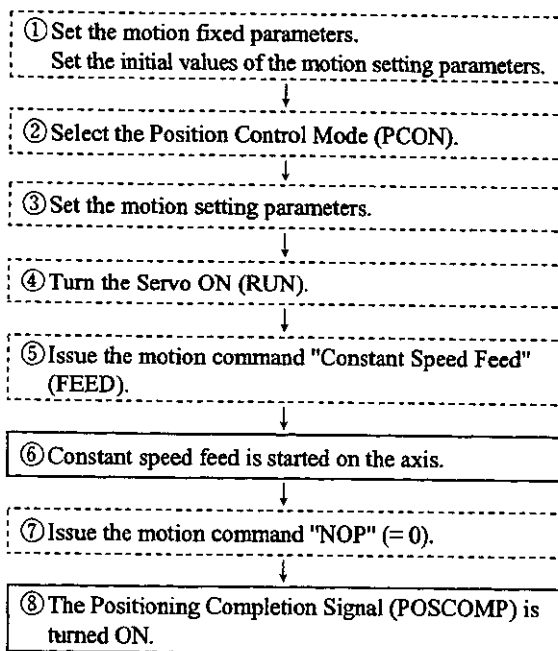

The operation in should be executed by the system.

The operation in should be performed by the user.

◆ An example of user programs (constant speed feed)

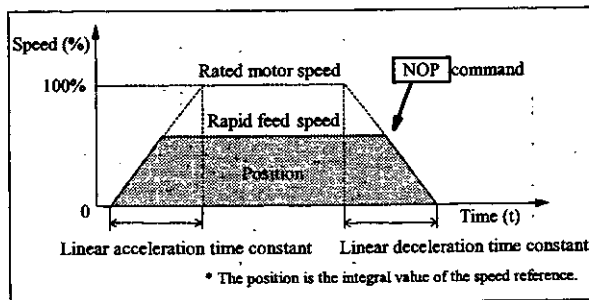

Fig. 3.11 An Example of Constant Speed Feed Patterns

<Preconditions>

The motion fixed parameters and the initial values of the motion setting parameters are the same as in 5.3 "Examples of Motion Parameter Settings."

<Operating conditions>

In the pattern shown in Fig. 3.11, the rapid feed speed = 5000000 pulses/min.

Rapid feed speed: OLC022 = 5000 (1 = 1000 pulses/min)

In this example, the first axis of module No. 1 is used.

If the module No. and/or axis No. is different, reread the register Nos., referring to 1.3 "Module No. and Motion Parameter Register No."

For details of the registers (OW□□□□) in use, refer to Chapter 5 "Motion Parameters."

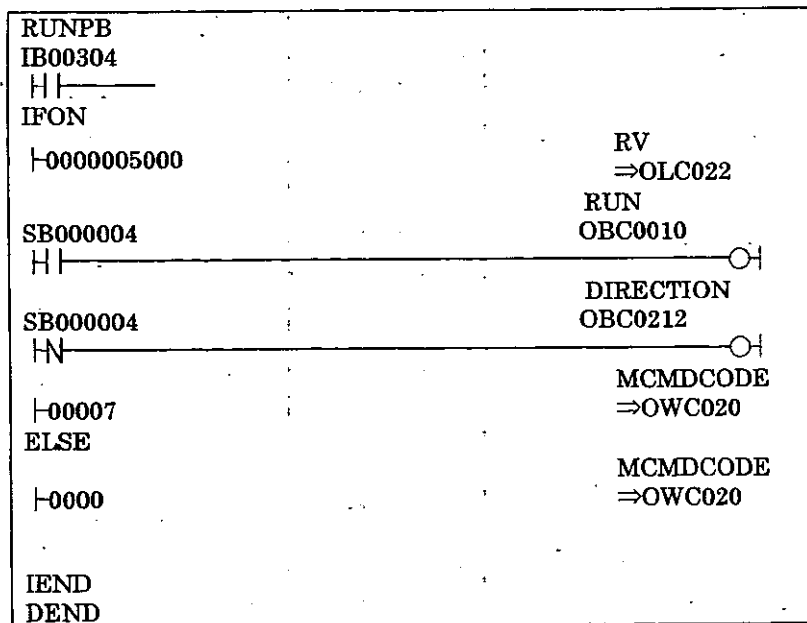

Fig. 3.12 An Example of Constant Speed Feed Programs (DWG H03)

The example in Fig. 3.12 is simplified, but each register can be freely controlled by user program

3.8 Constant Step Feed (STEP)

Positioning is performed in the designated direction, by the designated movement distance (amount of STEP movement), with the designated acceleration time constant, and at the designated rapid feed speed. The rapid feed speed can be changed even during operation. If the movement distance is changed during operation, the new value is reflected at the time of execution of the next Constant Step Feed (STEP).

Constant step feed on each axis is performed as follows. The register Nos. are intended for the first axis of module No. 1. If the module No. and/or axis No. is different, reread the register Nos., referring to 1.3 "Module No. and Motion Parameter Register No." Motion parameters to be used for constant step feed are marked with "○" in the "Constant Step Feed" column under "Motion Command Code" in 5.1.2 "List of Motion Setting Parameters" and 5.1.3 "List of Motion Monitoring Parameters."

[Example]

- ① Set the motion fixed parameters and the initial values of the motion setting parameters that suit your machine.
 (Note) Make sure to set Bit 7 (Motion Command Use Selection) of motion fixed parameter No. 14 "Additional Function Use Selection" to 1 (= use).
 Also, make sure to set Bit 8 (Motion Command Code Validity Selection) of the motion setting parameter "RUN Mode Setting (OW□□00)" to 1 (= valid).
- ② Select the Position Control Mode (PCON) (Bit 2 of OWC000).
- ③ Set the amount of STEP Movement (OLC028) and the Rapid Feed Speed (OLC022 or OWC015).
 Set motion setting parameters to be used for Constant Step Feed (STEP) such as the Linear Acceleration Time Constant (OWC00C) and the Filter Time Constant (OWC014), if necessary.
- ④ Turn the Servo ON (RUN) (Bit 0 of OWC001).
- ⑤ Set Constant Step Feed (STEP) to the Motion Command Code (OWC020).
- ⑥ By setting Constant Step Feed (STEP) to the Motion Command Code, positioning operation is performed on the axis in accordance with the designated motion parameters.
 To hold positioning, turn ON HOLD (Bit 0 of OWC021). Upon completion of holding, HOLDL (Bit 1 of IWC015) is turned ON. To cancel holding, turn OFF HOLD (Bit 0 of OWC021).
 To abort positioning, turn ON ABORT (Bit 1 of OWC021) or set NOP (= 0) to the Motion Command Code.
 During abort, BUSY (Bit 0 of IWC015) is turned ON, and upon completion of abort, it is turned OFF.
 (Note) Even if abort is canceled (ABORT is turned OFF) at the time of completion of abort, positioning is kept stopped.
- ⑦ When the Positioning completion range (OWC00E) is reached after issuing is completed (Bit 2 of IWC015 is turned ON), the Positioning completion signal POSCOMP (Bit D of IWC000) is turned ON.
- ⑧ When positioning is completed, cancel the motion command "Constant Step Feed."
 (Note) Since the rise of constant step feed is detected, once you have executed Constant Step Feed, you must set NOP to the motion command and set Constant Step Feed again to the motion command.

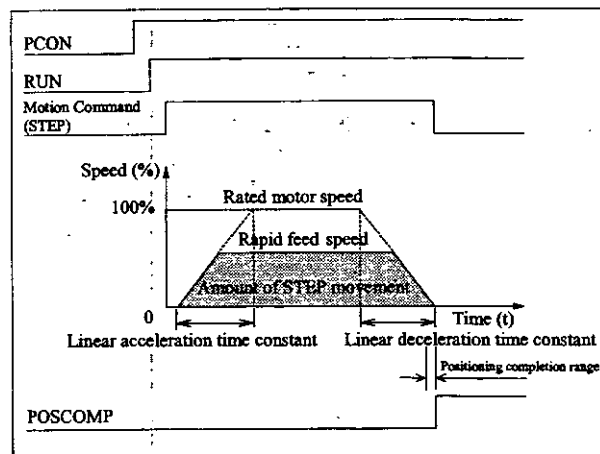
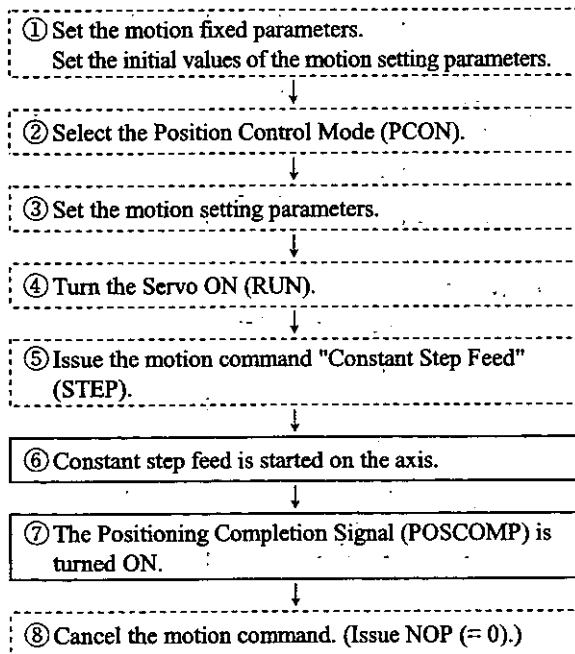

The operation in should be executed by the system.

The operation in should be performed by the user.

◆ An example of user programs (constant step feed)

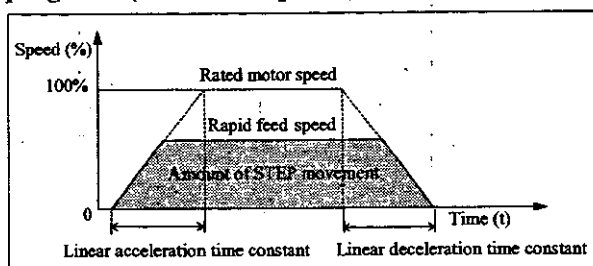

Fig. 3.13 An Example of Constant Step Feed Patterns

<Preconditions>

The motion fixed parameters and the initial values of the motion setting parameters are the same as in 5.3 "Examples of Motion Parameter Settings."

<Operating conditions>

In the pattern shown in Fig. 3.13, the operation stops at the STEP movement amount of 2000 pulses.

Amount of STEP movement: OLC028 = 2000 pulses

In this example, the first axis of module No. 1 is used.

If the module No. and/or axis No. is different, reread the register Nos., referring to 1.3 "Module No. and Motion Parameter Register No."

For details of the registers (OW□□□□) in use, refer to Chapter 5 "Motion Parameters."

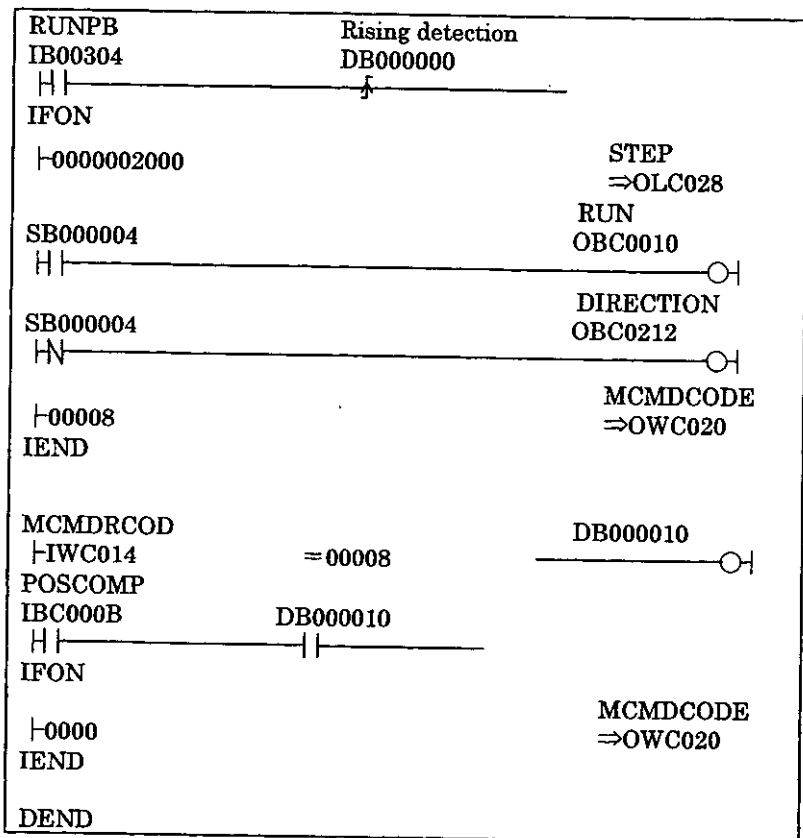

Amount of STEP Movement (STEP)
(2000 pulses)

RUN Command to the driver (RUN)

"Constant Step Feed" (STEP) is issued as the motion command.

By turning ON IB00304, constant step feed is started and movement is made by the STEP movement amount in the forward direction.

Upon completion of movement, the Positioning Completion Signal IBC000D is turned ON.

When movement is completed, clear the motion command (= NOP command) for the next operation.

Fig. 3.14 An Example of Constant Step Feed Programs (DWG H03)

The example in Fig. 3.14 is simplified, but each register can be freely controlled by user programs.

3.9 Zero Point Setting (ZSET)

The position obtained by executing "Zero Point Setting" is taken as the zero point in the machine coordinate system. Therefore, the zero point can be set without zero point return operation.

When using the software limit check, the zero point return operation or "Zero Point Setting" must be executed.

"Zero Point Setting" is performed as follows.

[Example]

- ① Move the machine to the zero point by constant speed feed, constant step feed or manual operation.
 - ② Select the Position Control Mode (PCON) (Bit 2 of OWC000).
(Note) Make sure to set Bit 7 (Motion Command Use Selection) of motion fixed parameter No. "Additional Function Use Selection" to 1 (= use).
Also, make sure to set Bit 8 (Motion Command Code Validity Selection) of the motion setting parameter "RUN Mode Setting (OW□□00)" to 1 (= valid).
 - ③ Set Zero Point Setting "9" to the Motion Command Code (OW□□01).
(Note) The Servo ON (Bit 0 of OW□□01) may be ON or OFF. If motion fixed parameter No. 3 "Encoder Selection" is set to absolute value encoder (= 1) and Bit 5 (Axis selection) of motion fixed parameter No. 17 "Motion Controller Function Selection Flags" is set to "infinite-length axis" (= 1), Zero Point Setting (ZSET) cannot be executed during axial movement.
 - ④ Upon completion of zero point setting, the zero point setting completion (Bit 3 of IW□□1) and Zero point return completion status (Bit 6 of IW□□15) are turned ON.
 - ⑤ When the Zero point setting completion is turned ON, cancel the motion command "Zero Point Setting." (Set NOP (= 0) to the motion command code.)
-

Caution

"Zero Point Setting (ZSET)" is a command for setting the "zero point in the machine coordinate system." Therefore, if an incorrect position is set by "Zero Point Setting", movements in subsequent operations will differ from the actually intended ones. Before running the machine, make sure to confirm that the zero point in the machine coordinate system is correctly set.

Neglecting this check may result in damage to tools due to interference or an accident causing injury or death.

4 I/O AND INVERTER

This chapter describes the I/O and inverter communications of the SVB module.

4.1 I/O and Inverter

The SVB module can perform control transmission and message transmission in connection with I/O modules and inverters as slave equipment.

Control transmission is cyclically executed between the SVB module and slave stations.

Each station's I/O area is assigned by CP-717.

If slave stations are inverters, inverter constants can be written and read and the data can be traced by using the system standard functions.

The system standard functions "ICNS-WR," "ICNS-RD" and "ITRC-RD" are used, respectively.

For message transmission of user data, the system standard functions "MSG-SND" and "MSG-RCV" are used.

There are two types of transmission procedures: MEMOBUS procedure and non-procedure.

The transmission status is output to the corresponding registers as parameters of the "MSG-SND" and "MSG-RCV" functions.

For details of the system standard functions, refer to the "CP-9200SH Programming Manual."

This module can be connected with the following I/Os and inverters.

Table 4.1 Details of Slave Stations

Assignment name	Equipment name
VS-676H5	VS-676H5 (inverter)
VS-676H5T	VS-676H5T (inverter)
VS-616G5	VS-616G5 (inverter)
RIO-01	CP-816 remote I/O
RIO-06	CP-816 remote I/O
ABS_CODER	Absocoder
JEPMC-IO350	Distributed I/O

To connect the above equipment, transmission parameter setting and I/O assignment to each station are necessary.

Double-click "M-LINK" displayed in the SVB slot on the Module Configuration window, and the MECHATROLINK (CERF) setting window appears.

4.2 Setting Transmission Parameters

For communicating with I/Os and inverters, the following transmission parameters must be set.

MECHATROLINK (CERF)	Transmission parameter setting
Master/Slave	Master (fixed)
Own Station Address	0 (fixed)
Message Trust Level	<p>0: A command is sent only once, and the response from the other side is waited indefinitely.</p> <p>1: A command is sent once, and if there is no response in 8 seconds, the command is sent again.</p> <p>2: When sending a command, data are sent twice in succession word by word, and then response from the other side waits indefinitely. The transmission reliability improves but the transmission time increases twofold.</p>
Max Slave ST Number	In combination with the transmission speed and transmission cycle, the following 12 setting patterns of Max Slave ST Number exist. (Refer to Table 4.2.)

Table 4.2 List of Settings of Max Slave ST Number

Max Slave ST Number	Transmission Speed	Transmission Cycle
2	4 Mbps	500 μ s
2	10 Mbps	250 μ s
3	2 Mbps	1 ms
6	4 Mbps	1 ms
6	10 Mbps	500 μ s
7	2 Mbps	2 ms
14	4 Mbps	2 ms
14	10 Mbps	1 ms
15	2 Mbps	4 ms
29	4 Mbps	4 ms
29	10 Mbps	2 ms
30	10 Mbps	4 ms

Note

- Stations by the Max Slave ST Number cannot always be connected. The number of stations which can be connected actually varies within the range of the Max Slave ST Number depending on the connecting slave type and the scan setting time.
(The Max Slave ST Number will never be exceeded.) As a guide, carry out an assignment that meets the two conditions shown in <Precaution 1>.
- After changing the transmission parameters, turn the power of CP-9200SH OFF, and then turn ON again.
- Set the same transmission speed between the master and slave stations.
- Set the transmission parameters to 14 stations, 4 Mbps, and 2 ms when MECHATROLINK SERVOPACKs are also connected.

4.2.1 The Number of Connectable Slave Stations

Assign the I/Os to meet the following conditions.

(1) Obtain the time required for the communication interrupt process as follows:

$$\text{SIO_TIM} = 31(\mu\text{s}) \times \text{number of assigned RIO-01, ABS_CODER and JEPMC-IO350}$$

$$\text{SEQIO_TIM} = 46(\mu\text{s}) \times \text{number of assigned RIO-06}$$

$$\text{INV_TIM} = 46(\mu\text{s}) \times \text{number of assigned inverters}$$

$$\text{INT_TIM} = 25(\mu\text{s}) + \text{SIO_TIM} + \text{SEQIO_TIM} + \text{INV_TIM}$$

INT_TIM : Time required for the communication interrupt (μs)

INT_CYC : Communication cycle
(communication cycle selected by setting Max Slave ST Number)

Set the time required for the communication interrupt as it is less than 90% of the communication cycle. (Make the units of INT_TIM and INT_CYC coincide.)

(Condition 1) $\text{INT_TIM} < \text{INT_CYC} \times 0.9$

(2) Next, obtain the time required for the high-speed scan interrupt process as follows:

$$\text{IOH_TIM} = 90(\mu\text{s}) \times \text{number of H-scan assigned RIO-01, RIO-06, ABS_CODER and JEPMC-IO350}$$

$$\text{IOL_TIM} = 34(\mu\text{s}) \times \text{number of L-scan assigned RIO-01, RIO-06, ABS_CODER and JEPMC-IO350}$$

$$\text{INVH_TIM} = 105(\mu\text{s}) \times \text{number of inverters}$$

$$\text{HSCAN_TIME} = 200(\mu\text{s}) + (15(\mu\text{s}) \times \text{SLV_NUM}) + \text{IOH_TIM} + \text{IOL_TIM} + \text{INVH_TIM}$$

HSCAN_TIM : Time required for the SVB high-speed scan interrupt (μs)

SLV_NUM : Maximum number of slave stations
(number of stations set by Max Slave ST Number)

SCAN_TIME : CPU high-speed scan setting value

Set the sum of the time required for the SVB high-speed scan interrupt and the time required for the communication interrupt to less than 80% of the CPU high-speed scan setting value.

(Make the units of HSCAN_TIM, SCAN_TIM, INT_TIM, INT_CYC coincide.)

If $\text{SCAN_TIME} \div \text{INT_CYC}$ leaves a remainder, add 1 to the quotient.)

(Condition 2) $\text{HSCAN_TIM} + [(\text{SCAN_TIME} \div \text{INT_CYC}) + \text{INT_TIM}] < \text{SCAN_TIME} \times 0.8$

[Example]

Max Slave ST Number: 14 Transmission speed: 4 Mbps Communication cycle: 2 ms

CPU high-speed scan setting: 6 ms

Number of slaves: 3 RIO-01 (L-scan assigned)

6 RIO-06 (H-scan assigned: 4, L-scan assigned: 2)

5 inverters

$$\text{SIO_TIM} = 31(\mu\text{s}) \times 3 = 93$$

$$\text{SEQIO_TIM} = 46(\mu\text{s}) \times 6 = 276$$

$$\text{INV_TIM} = 46(\mu\text{s}) \times 5 = 230$$

$$\text{INT_TIM} = 25(\mu\text{s}) + 93 + 276 + 230 = 624(\mu\text{s})$$

$$624(\mu\text{s}) < 2(\text{ms}) \times 1000 \times 0.9$$

$$624(\mu\text{s}) < 1800(\mu\text{s}) \dots \text{Condition 1}$$

$$\text{IOH_TIM} = 90(\mu\text{s}) \times 4 = 360$$

$$\text{IOL_TIM} = 34(\mu\text{s}) \times 5 = 170$$

$$\text{INVH_TIM} = 105(\mu\text{s}) \times 5 = 525$$

$$\text{HSCAN_TIM} = 200(\mu\text{s}) + (15(\mu\text{s}) \times 14) + 360 + 170 + 525 = 1465(\mu\text{s})$$

$$1465(\mu\text{s}) + [(6(\text{ms}) \div 2(\text{ms})) \times 624(\mu\text{s})] < 6(\text{ms}) \times 1000 \times 0.8$$

$$1465(\mu\text{s}) + (3 \times 624(\mu\text{s})) < 6000(\mu\text{s}) \times 0.8$$

$$3337(\mu\text{s}) < 4800(\mu\text{s}) \dots \text{Condition 2}$$

Since both of condition 1 and 2 are met, this assignment is allowable.

4.3 Setting I/O Assignment

For actually performing control transmission and message transmission with slave equipment, I/O assignment is necessary.

Click "I/O Assignment" on the Transmission Parameters window, and the I/O Assignment window appears.

Configuration of the I/O Assignment window

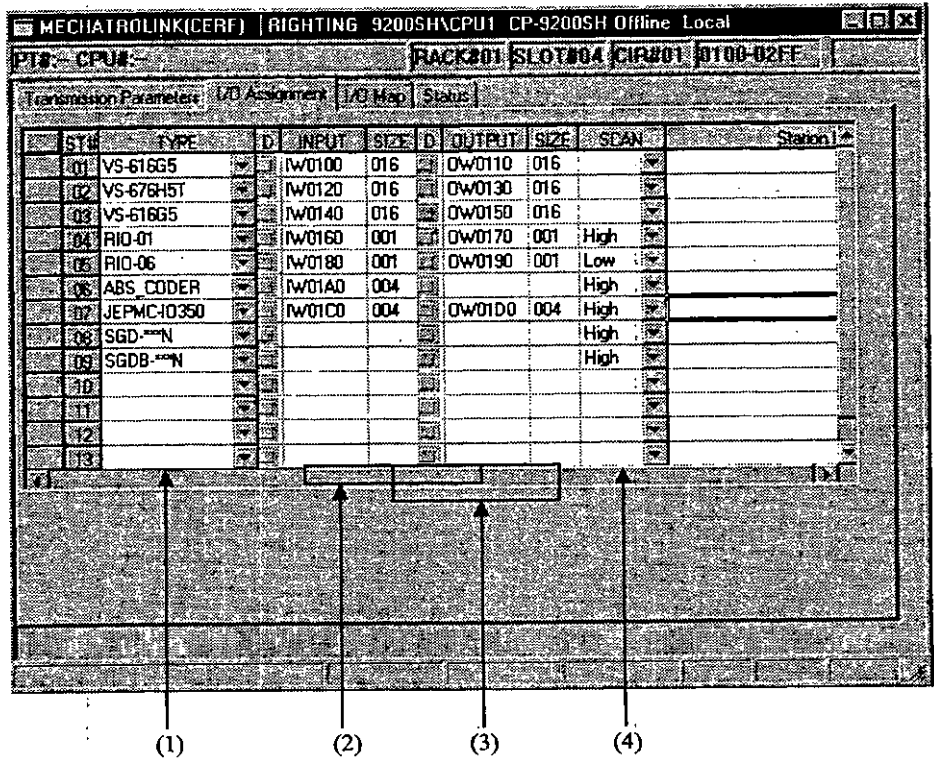

(1) TYPE

Set the connecting equipment names. (For the selectable models, refer to Table 4.3.)

(2) INPUT, OUTPUT

Set the input registers (IW□□□□) and output registers (OW□□□□) within the range between "I/O Start Register" and "I/O End Register" set on the Module Configuration window. (Note) Set the register No. not to overlap between the INPUT and OUTPUT registers.

(3) SIZE

The size is fixed according to the slave equipment. (Refer to Table 4.3.)

(4) SCAN

Set the control data updating cycle for each station. Some slave equipment do not need this setting. (Refer to Table 4.3.)

Table 4.3 Details of the Transmission Parameter Settings

Equipment name	TYPE	SIZE (words)	SCAN	
			High-speed SCAN	Low-speed SCAN
VS-676H5(inverter)	VS-676H5	16	Setting unnecessary	
VS-676H5T	VS-676H5T	16	Setting unnecessary	
VS-616G5	VS-616G5	16	Setting unnecessary	
CP-816 remote I/O (RIO-01)	RIO-01	1	Settable	Settable
CP-816 remote I/O (RIO-06)	RIO-06	1	Settable	Settable
Absocoder	ABS_CODER	4	Settable	Settable
Distributed I/O	JEPMC_IO350	4	Settable	Settable

4.4 Types of Messages

For message transmission, three types of messages can be used: MEMOBUS message, general-purpose message and inverter message.

The relationship between usable messages according to slave equipment is shown in Table 4.4.

Table 4.4 Details of the Usable Messages

Equipment name		MEMOBUS message (MEMOBUS procedure)	General-purpose message (non-procedure)	Inverter message (inverter function)*
VS-676H5 (inverter)	216IF/H5	×	×	○
VS-676H5T (inverter)	216IF/H5	×	×	○
VS-616G5 (inverter)	216IF/G5	×	×	○
	CP-916B	○	○	○
CP-816 remote I/O (RIO-01)		×	×	×
CP-816 remote I/O (RIO-06)		○	×	×
Absocoder		×	×	×
Distributed I/O		×	×	×

* By creating user programs using standard system functions ("ICNS-WR", "ICNS-RD", "ITRC-RD") for the CPU module, inverter constants can be written and read, and trace data can be read.

For details of the system standard functions, refer to the Machine Controller CP-9200SH Programming Manual (SIE-C879-40.3).

4.5 Control Data Configuration

The data configuration which is used for control data transmission with slave equipment is shown below.

(1) RIO-01, RIO-06

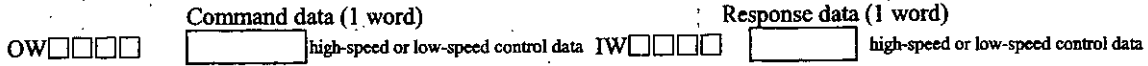

(2) Inverter

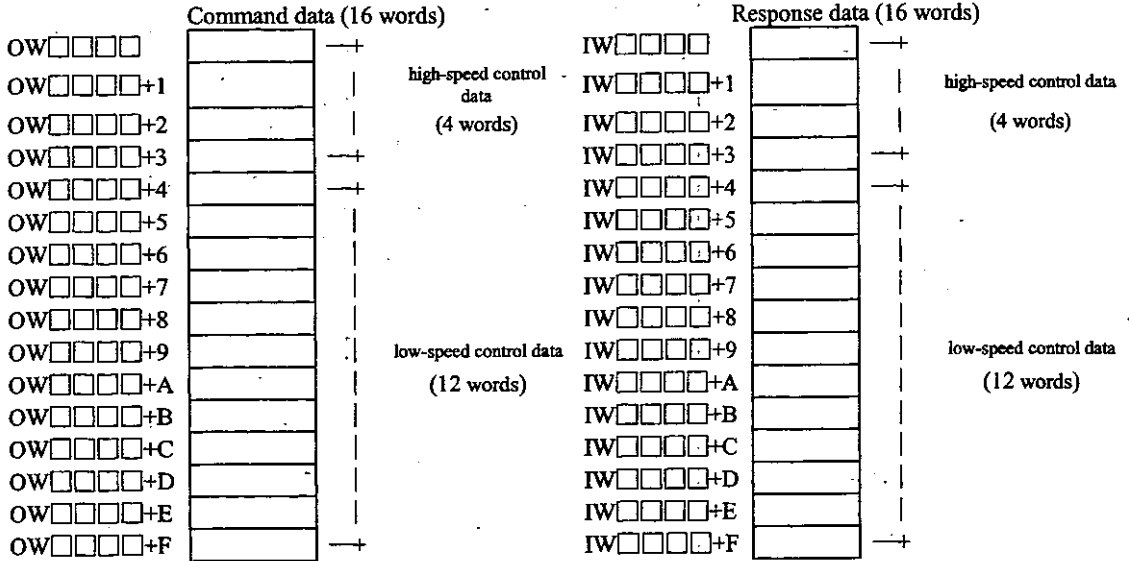

(3) MP930 I/O unit

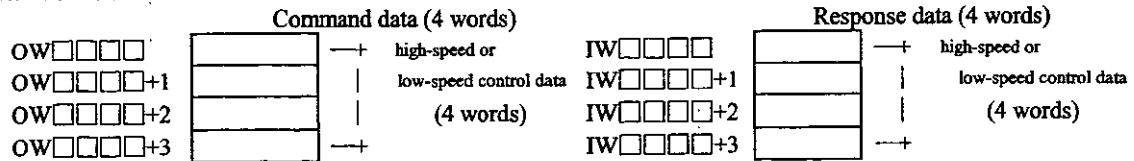

(4) Absocoder

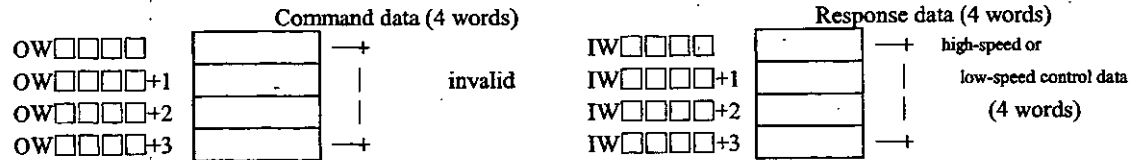

4.6 Control Command/Response Data

■ Control Command Data

Address	H5 (Textiles)	H5 (General)	G5
0010	* RUN signal	* RUN signal	RUN signal
0012	* Freque/ncy reference	* Reference speed	Speed reference
0014	* V/f voltage micro-adjustment	* Torque reference	Torque reference (only for vectors with PG)
0016	* Target frequency (PM)	* Torque compensation	Torque compensation (only for vectors with PG)
0018	Not used.	External magnetic flux reference	Not used.
001A	Inverter Unit AOCH1 output	Inverter Unit AOCH1 output	Inverter Unit AOCH1 output
001C	Inverter Unit AOCH2 output	Inverter Unit AOCH2 output	Inverter Unit AOCH2 output
001E	Inverter Unit DO output	Inverter Unit DO output	Inverter Unit DO output
0020	Option AO-12CH1 output	Option AO-12CH1 output	Not used.
0022	Option AO-12CH2 output	Option AO-12CH2 output	Not used.
0024	Option DO-08 output	Option DO-08 output	Not used.
0026	Not used.	Not used.	Not used.
0028	Not used.	Not used.	Not used.
002A	Not used.	Not used.	Not used.
002C	Not used.	Not used.	Not used.
002E	Not used.	Not used.	Not used.

Note

1. Data marked with an asterisk (*) is refreshed during the high-speed scan (1 ms) at the Inverter (H5) end and consists of 4 successive words from the top.
2. Data marked with an asterisk (*) is synchronized on the high-speed scan on the option board at the option end. All other data is synchronized and refreshed in the low-speed scan.
3. All G5 data is read in 5-ms cycles. Data is refreshed on the high-speed scan at the option end.

■ Run Signals

Bit	H5 (Textiles)	H5 (General)	G5
0	RUN/STOP	RUN/STOP	RUN/STOP
1	Reverse	Reverse	Reverse
2	Base block	Base block	Base block
3	Trace start/stop (1: Stop)	Trace start/stop (1: Stop)	Trace start/stop (1: Stop)
4	External error	External error	External error
5	Error reset	Error reset	Error reset
6	Acceleration-deceleration time change	Acceleration-deceleration time change	0
7	Acceleration-deceleration disabled (hold speed)	Acceleration-deceleration disabled (hold speed)	0
8	Dynamic brake reference	Initial excitation	Dynamic brake reference
9	Integral reset (ASR)	Integral reset (ASR)	Integral reset (ASR)
A	Integral hold (ASR)	Integral hold (ASR)	0
B	Soft starter cancel	Soft starter cancel	0
C	Trace reset (after failure) (1: RST)	Trace reset (after failure) (1: RST)	Trace reset (after failure) (1: RST)
D	0	Servo ON	Servo ON
E	0	Speed/torque control switching	Speed/torque control switching
F	0	0	0

Note

Trace start/stop and trace reset are commands to option boards from the host and are not used by the Inverter Control Section Unit.

■ Control Response Data (16 Words) Inverter → Option

Address	H5 (Textiles)	H5 (General)	G5
0030	* Status signal	* Status signal	Status signal
0032	* Speed feedback	* Speed feedback	Speed feedback
0034	* Main circuit DC voltage	* Torque reference	Torque reference
0036	* Instantaneous power	* Pulse generator counter value for speed detection	Pulse generator counter value for speed detection
0038	Speed reference	Speed reference	Speed reference
003A	Primary frequency reference	Primary frequency reference	Primary frequency reference
003C	Output current	Output current	Output current
003E	Output voltage reference	Output voltage reference	Output voltage reference
0040	Main circuit DC voltage	Main circuit DC voltage	Main circuit DC voltage
0042	Not used.	Torque feedback	Error alarm signal 1
0044	Error alarm signal 1	Error alarm signal 1	Error alarm signal 2
0046	Error alarm signal 2	Error alarm signal 2	Error alarm signal 3
0048	Inverter Unit AI CH3 input	Inverter Unit AI CH3 input	Inverter Unit AI CH3 input
004A	Inverter Unit DI input	Inverter Unit DI input	Inverter Unit DI input
004C	Inverter Unit AI CH1 input	Inverter Unit AI CH1 input	Inverter Unit AI CH1 input
004E	Instant amount of drop	Instant amount of drop	Pulse generator counter CH2 input

Note

1. Data marked with an asterisk (*) is refreshed during the high-speed scan (1 ms) at the Inverter (H5) end and consists of 4 successive words from the top.
2. H5 data marked with an asterisk (*) is synchronized on the high-speed scan on the option board at the option end. All other data is synchronized and read on the low-speed scan.
3. All G5 data is read in 5 ms cycles. Data is refreshed in the high-speed scan at the option end.

■ Status Signals

Bit	H5 (Textiles)	H5 (General)	G5
0	Running	Running	Running
1	Zero speed	Zero speed	Zero speed
2	Reversing	Reversing	Reversing
3	Reset signal inputting	Reset signal inputting	Reset signal inputting
4	Speed match	Speed match	Speed match
5	Inverter preparations completed	Inverter preparations completed	Inverter preparations completed
6	Minor failure	Minor failure	Minor failure
7	Major failure	Major failure	Major failure
8	Reference error	Reference error	0
9	Power outage recovery/power interruption recovery	Local/remote	Local/remote
A	Local/remote	Local/remote	Local/remote
B	Powering up/regenerating	Powering up/regenerating	0
C	Current limiting	Current torque limiting	0
D	Speed limiting	Speed limiting	0
E	0	Servomotor selection (No.1/No.2)	Servomotor selection (No.1/No.2)
F	0	Servo zeroing completed	Servo zeroing completed

4.7 VS-616G5 Inverter Connection Example

This section describes and SVB application example using 216IF/G5 Modules.

4.7.1 Prepared Items and Startup Procedure

■ Prepared Items

Name	Model
Inverters	-
Servomotors	-
216IF/G5 Module	87216-1200□-SOXOY
216IF Transmission Cable	-

■ Startup Procedure

This section describes the startup procedure when Inverters are controlled by a 216IF/G5 Module.

1. Mount and wire the 216IF/G5 card.
2. Set Inverter parameters.
3. Set the SVB MECHATROLINK.
4. Create a ladder logic program.
5. Check operation

4.7.2 216IF/G5 Module Specifications

■ Appearance

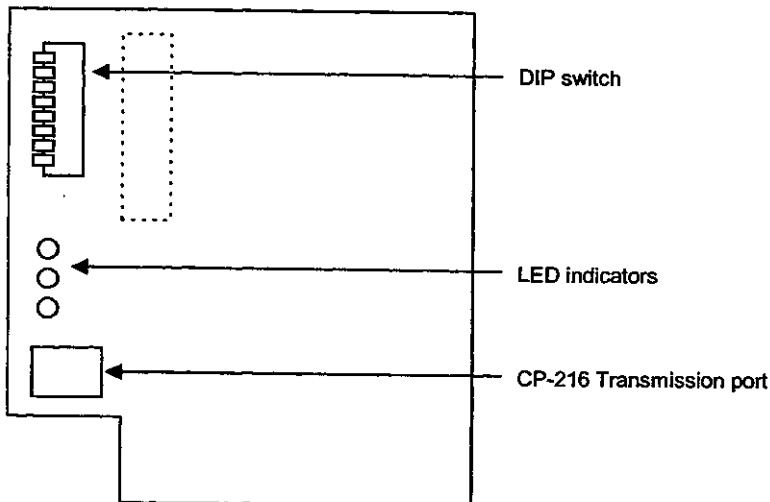

■ LED Indicators

Indicator	Color	Status When Lit
RUN	Green	Normal operation.
ERR	Red	Failure occurred/transmission path disconnected.
TX	Green	Sending/receiving data.

■ **DIP Switch Settings**

Pin Number	Function	Setting	Description			
1	RESET	ON	Hardware reset			
		OFF	Normal operation			
2	Mode Switching	ON	Standard Mode			
		OFF	Expansion Mode			
3	Transmission Speed	Pin 3	Pin 4	Transmission Speed		
4		ON	ON	0.5 Mbps		
		ON	OFF	1 Mbps		
		OFF	ON	2 Mbps		
		OFF	OFF	4 Mbps		
5	Station Address	Pin 5	Pin 6	Pin 7	Pin 8	Station Address
6		OFF	OFF	OFF	ON	1
7		OFF	OFF	ON	OFF	2
8		OFF	OFF	ON	ON	3
		:	:	:	:	:
		ON	ON	ON	OFF	14
		ON	ON	ON	ON	15

Note

1. Set pins 1 to 4 to the settings that are highlighted.
2. Set pins 5 to 8 according to the station address.

IMPORTANT

Be sure to set the pins prior to turning ON the Inverter. The pins cannot be set if the Inverter is ON.

■ Connector

This section describes the model number and pin layout for the connector to the 216IF/G5 Module transmission path.

- Model: MC1.5/2-G-5.83-AU (made by PHOENIX CONTACT co. jp.)
- Pin Layout

Pin No.	Signal Name
1	S* Send/receive signal (-)
2	S Send/receive signal (+)

■ Procedure for Preparing 216IF/G5 Cable

Be sure to use twisted-pair cables with wire sizes AWG#24 to AWG#20 (0.2 to 0.51 mm²) on the connector from the 216IF/G5 to the SVB.

This section describes the procedure used to prepare the cable.

1. Strip the wire of its covering for 6.5 mm from the end.

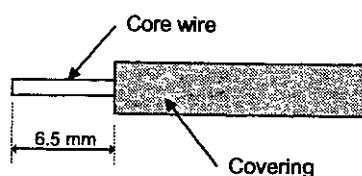

2. Secure the wire to the plug.

Insert the core wire deeply into the plug and tighten the screws to a tightening torque 0.3 to 0.4 N·m.

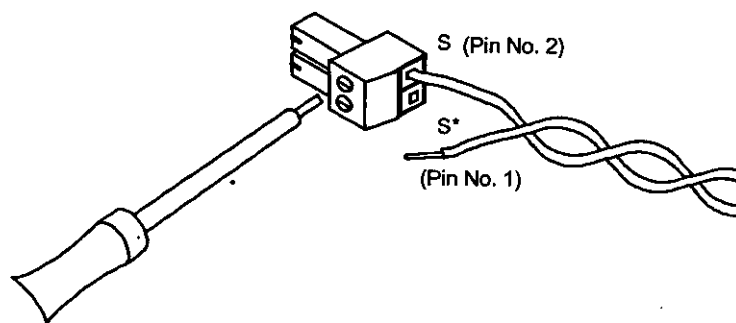

4.7.3 Mounting Procedure

This section describes the procedure used to mount a 216IF/G5 Module.

1. Turn OFF the main circuit power supply of the Inverters and wait at least one minute (at least 3 minutes for Inverters rated 30 kW or higher).
2. Remove the front cover of the Inverters and check to see if the charge indicator is not lit.
3. Check the Option Card mounting locations (A, C and D).
4. Align the Option Card connector with the 2CN connector on the Control PCB and push the spacers into the spacer mounting holes on the card end.

With the spacers in the holes, push until you hear a click.

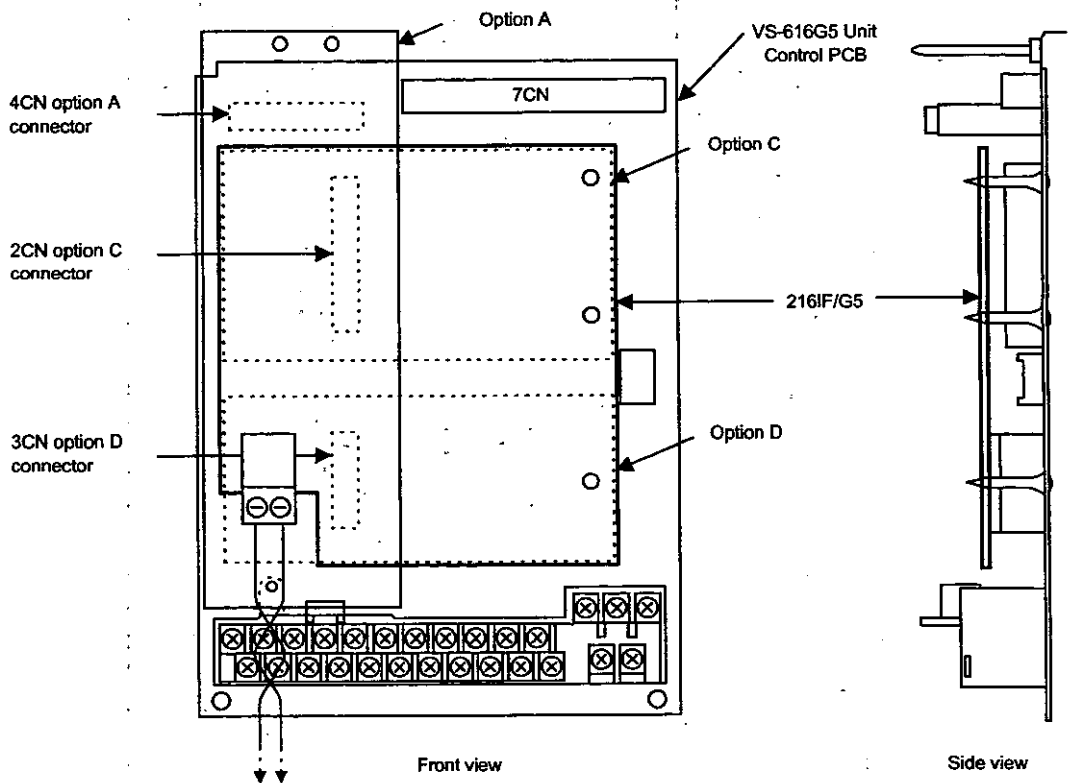
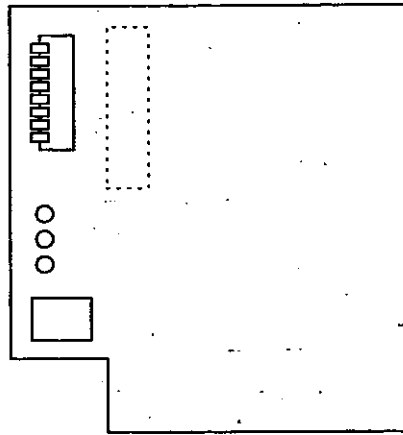

4.7.4 Wiring

This section describes the procedure used to wire the 216IF/G5 Card.

■ 216IF/G5 Card Wiring

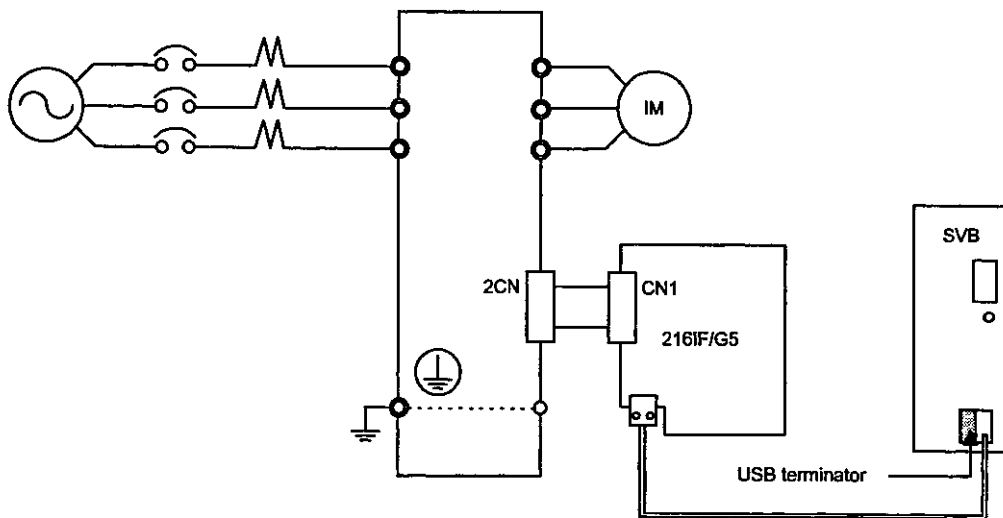

■ Connection with SVB Module

The following figure shows the procedure used to connect multiple VS-616G5 stations to an SVB Module.

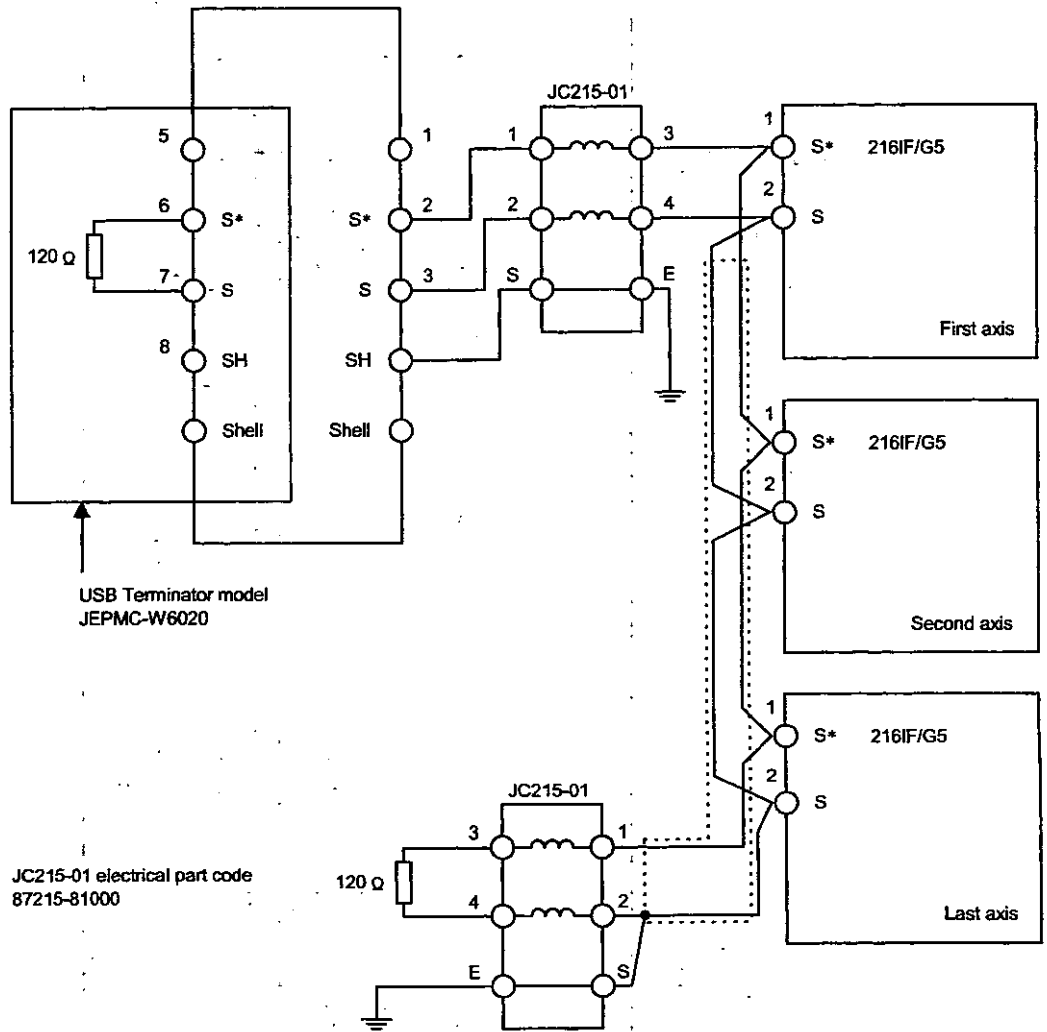

4.7.5 VS-616G5 Constant Settings

Set these constants to control Inverters from a 216IF/G5 Module. The following table shows constants required for lower limit settings.

Constant No.	Description
A1-01	Constant access level
A1-02	Control mode selection
b1-01	Frequency reference selection
b1-02	RUN commnad selection

■ Constant Access Level: A1-01

Setting

Set the level for accessing constants (range that can be set and checked).

Constant No.	Name	Change While Running	Setting Range	Units	Factory Setting	Access Level			
						V/f without PG	V/f with PG	Vector without PG	Vector with PG
A1-01	Constant access level	Possible	0 to 4	-	2 (Q)	Q	Q	Q	Q

Set ADVANCED level (4).

Explanation of Settings

Setting	Name	Description
0	Monitor only	Enables on the drive mode and environmental settings to be checked and set. The setting can be used to prevent constants from being changed. (Write protect function)
1	Check user selected constants only	Enables only user selected constants (maximum of 32) to be checked and set. Set the constants that can be checked and set at A2-01 to A2-32.
2	QUICK-START	Enables only constants (maximum of 25) required to start up the Inverter to be checked and set.
3	BASIC	Enables constants in general use to be checked and set.
4	ADVANCED	Enables all constants to be checked and set.

■ **Control Mode Selection: A1-02**

Setting

Select one of four control modes. The setting will not be initialized when the constants are initialized.

Constant No.	Name	Change While Running	Setting Range	Units	Factory Setting	Access Level			
						V/f without PG	V/f with PG	Vector without PG	Vector with PG
A1-02	Control mode selection	Not possible	0 to 3	-	2 (Vector without PG)	Q	Q	Q	Q

Set 2 for vector control without a pulse generator.

Explanation of Settings

Setting	Control Mode	Description
0	V/f control without a pulse generator	Normal V/f control
1	V/f control with a pulse generator	V/f control using a pulse generator speed control card
2	Vector control without a pulse generator	Vector control based on speed data in the Inverter
3	Vector control with a pulse generator	Vector control using a control card connected to a pulse generator

■ **Frequency Reference Selection: b1-01**

Setting

Select the procedure that will be used to input the frequency reference.

Constant No.	Name	Change While Running	Setting Range	Units	Factory Setting	Access Level			
						V/f without PG	V/f with PG	Vector without PG	Vector with PG
b1-01	Frequency reference selection	Not possible	0 to 3	-	1	Q	Q	Q	Q

Set 3 because the frequency reference will send from the Option Card.

Explanation of Settings

Setting	Description
0	Digital Operator
1	Control circuit terminal (analog input)
2	Transmission
3	Option Card

■ Run Reference Selection: b1-02

Setting

Select the location that will input the run reference.

Constant No.	Name	Change While Running	Setting Range	Units	Factory Setting	Access Level			
						V/f without PG	V/f with PG	Vector without PG	Vector with PG
b1-02	Run reference selection	Not possible	0 to 3	—	1	Q	Q	Q	Q

Set 3 because the frequency reference will be sent from the Option Card.

Explanation of Settings

Setting	Description
0	Digital Operator
1	Control circuit terminal (external terminal)
2	Transmission
3	Option Card

4.7.6 MECHATROLINK Definitions

Click *M-Link* at the SVB slot on the Modules Configuration Window, and click the I/O Assignment Tab in the MECHATROLINK Definition Window to define VS-616G5 as the device that will be connected.

ST#	TYPE	I/O	INPUT	SIZE	O	OUTPUT	SIZE	SCAN	Station
01	VS-616G5		IW0050	016		OW0060	016		
02	SGD-N							High	
03	SGD-N							High	
04	SGD-N							High	
05	SGD-N							High	
06	JEPMC10350		IW0100	004		OW0110	004	High	
07									
08									
09									
10									
11									
12									

4.7.7 Creating a Ladder Logic Program

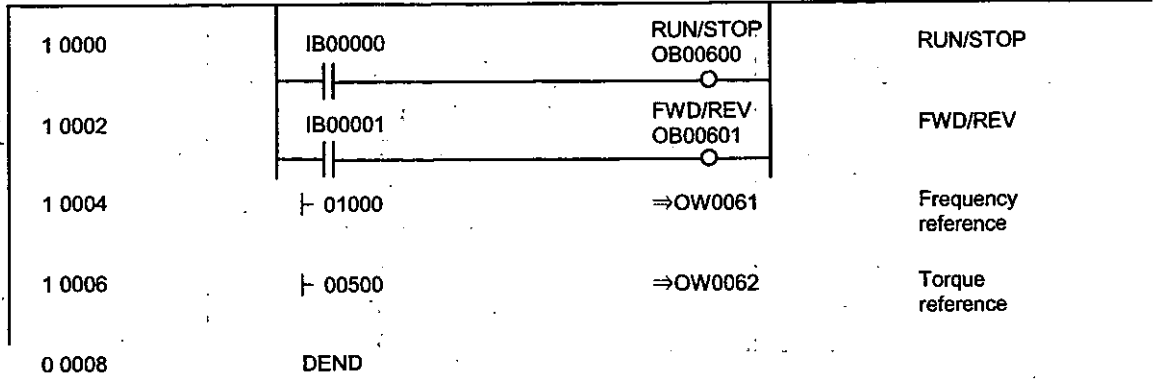

5 MOTION PARAMETERS

This chapter provides a list of motion parameters with explanations and setting examples.

5.1 List of Motion Parameters

Each axis is provided with common parameter specifications. The register Nos. of each axis (axis 1 to 14) are the register Nos. in Tables 5.2 and 5.3 plus axis offset. Each axis offset (axis ofs) is given by (axis No. 1) × 40H (64 words). The "□□" of the register Nos. differs according to the module No. For details, refer to 1.3 "Module No. and Module Parameter Register No."

All settings are automatically set to initial values when power is turned ON. If any data out of the setting range is set, the operation is performed at a value limited within the setting range.

Note

No. of registers with a different module No. are not consecutive.

Register Nos. of the same module No. are consecutive between axes No. 1 and 8 and between axes No. 9 and 14, but those between axes No. 8 and 9 are not consecutive.

Those with the same module No. are consecutive between axes.

Therefore, care should be taken if a subscript (i, j) is used on a user program.

(Example 1)

With $\neg IW(OW)C000i$, read can be performed normally within the range of $i = 0$ to 511.

With $IW(OW)C000i$, the register range of axes No. 1 to 8 of module No. 1, that is, the range between $IW(OW)C000$ and $IW(OW)C1FF$ can be read and written normally.

If $i > 511$, read cannot be performed normally.

Be aware that register Nos. between axes No. 9 and 14 and of module No. 2 and after cannot be read with $\neg IW(OW)C000i$.

(Example 2)

Between axes No. 9 and 14 of the same module No.

With $\neg IW(OW)C200i$, read can be performed normally within the range of $i = 0$ to 383.

With $IW(OW)C200i$, the register range between axes No. 9 and 14 of module No. 1, that is, the range between $IW(OW)C200$ and $IW(OW)C37F$ can be read and written normally.

If $i > 383$, read cannot be performed normally.

Be aware that register Nos. between axes No. 1 and 8 and of module No. 2 and after cannot be read with $\neg IW(OW)C200i$.

5.1.1 List of Motion Fixed Parameters

These parameters will, once set, normally be never changed as long as the configuration or specifications of the machine are not changed. Set them with the "Fixed parameter" tab in the SVB definition window of C717.

Note

Fixed parameters cannot be changed when the current value of Bit 0 of set parameter No. 2 "RU Command Setting (OW□□01) is ON.

Be aware that if any motion fixed parameter is changed, position information, etc., will be initialized.

Table 5.1 List of Motion Fixed Parameters

No.	Name	Setting range/Bit name	Meaning
1	Axis Use Selection (USESEL)	0 or 1 (Initial value = 0)	0: Not used 1: Used
2	Reserved	-	-
3	Encoder Selection (ENCSEL)	0 or 1 (Initial value = 0)	0: Incremental encoder 1: Absolute encoder
4	Reserved	-	-
5	Pulse Counting Mode Selection (PULMODE)	4 to 6 (Initial value = 6)	4: A/B method (multiplied by 1) 5: A/B method (multiplied by 2) 6: A/B method (multiplied by 4)
6	Reserved	-	-
7	Rated Motor Speed Setting (NR)	1 to 32000 (Initial value = 3000)	1=1 r/min
8	Number of Feedback Pulses per Rotation (FBppr)	A multiple of 4 between 4 and 65532 (Initial value = 2048)	1=1 pulse/rev * Set a yet-to-be-multiplied value.
9 13	Reserved	-	-
14	Reserved	-	-
15	Reserved	-	-
16	Simulation Mode Selection (SIMULATE)	0 or 1	0: Normal operation mode 1: Simulation mode
17	Motion Controller Function Selection Flags (SVFUNCSEL)	Bit	
		0 to 3: CMD_UNIT (Initial value = 0)	Reference Unit Selection 0: pulse (electronic gear invalid) 1: mm 2: deg 3: inch
		4: USE_GEAR (Initial value = 0)	Electric Gear Selection 0: Invalid 1: Valid
		5: PMOD_SEL (Initial value = 0)	Axis Selection 0: Finite-length axis 1: Infinite-length axis
		6: Reserved	-
		7: USE_SLIMP (Initial value = 0)	Software Limit (positive direction) Selection 0: Invalid 1: Valid
		8: USE_SLIMN (Initial value = 0)	Software Limit (negative direction) Selection 0: Invalid 1: Valid
		9: USE_OV (Initial value = 0)	Override Selection 0: Invalid 1: Valid
		10/11: Reserved	-
		12: THROUMOD (Initial value = 0)	Servo Driver Transparent Command Mode 0: Invalid 1: Valid
		13/14: Reserved	-
		15: SWGBVF (Initial value = 0)	Interpolation Command Segment Distributing Function 0: Valid 1: Invalid

Table 5.1 List of Motion Fixed Parameters (Cont'd)

No.	Name	Setting range/Bit name	Meaning
18	Number of Digits Below Decimal Point	0 to 5 (Initial value = 3)	Set the number of digits to the right of the decimal point of reference (Example) For the number of digits to the right of the decimal point = 3, mm : One reference unit = 0.001 mm deg : One reference unit = 0.001 deg inch : One reference unit = 0.001 inch This parameter and the Reference Unit Selection (motion fixed parameter No.17.) gives the minimum reference unit. However, the minimum unit of "pulse" is not affected by this parameter.
19	Travel Distance per Machine Rotation (PITCH)	1 to $2^{31}-1$ (Initial value = 10000)	1=1 reference unit
21	Servomotor Gear Ratio (GEAR MOTOR)	1 to 65535 (Initial value = 1)	1=1 rotation
22	Machine Gear Ratio (GEAR MACHINE)	1 to 65535 (Initial value = 1)	1=1 rotation
23	Infinite-length Axis Reset Position (POSMAX)	1 to $2^{31}-1$ (Initial value = 360000)	1=1 reference unit
25	Maximum Number of Absolute Encoder Turns (MAXTURN)	1 to $2^{31}-1$ (Initial value = 99,999)	1=1 rotation
27	Positive Software Limit (SLIMP)	-2^{31} to $2^{31}-1$ (Initial value = $2^{31}-1$)	1=1 reference unit
29	Negative Software Limit (SLIMN)	-2^{31} to $2^{31}-1$ (Initial value = -2^{31})	1=1 reference unit
31	Zero Point Return Method (ZRETSEL)	0 to 3 (Initial value = 0)	0: DEC signal + C signal 1: ZERO signal 2: DEC signal (with switch width) + ZERO signal 3: C pulse
32 38	Reserved	-	-

5.1.2 List of Motion Setting Parameters

These parameters are used for reference to the motion module. At the beginning of high-speed scanning, the parameters are transferred to the motion module in a batch. Motion control can be performed by simply setting the parameters to this register area.

Note

No. of registers with a different module No. are not consecutive.

Register Nos. of the same module No. are consecutive between axes No. 1 and 8 and between axes No. 9 and 14, but those between axes No. 8 and 9 are not consecutive.

Those with the same module No. are consecutive between axes.

Therefore, care should be taken if a subscript (i, j) is used on a user program.

For details, refer to 5.1 List of Motion Parameters.

Table 5.2 List of Motion Setting Parameters

No.	Name	Register No.	Setting range/ Bit name	Meaning	Motion Command Code (OW□□20)								
					Positioning	External positioning	Zero point return	Interpolation	Latch	Constant speed feed	Constant step feed		
1	RUN Mode Settings (RUNMOD)	OW□□00											
		Bit	0	Reserved	Set "0."								
			1	Reserved	Set "0."								
			2	PCON (Initial value = 0)	Position Control Mode		○	○	○	○	○	○	○
			3 to 5	Reserved	Set "0."								
			6	ACR (Initial value = 0)	Alarm Clear 1: Alarm clear inquiry								Always valid
			7	Reserved	Set "0."								
			8	MCDSEL (Initial value = 1)	0: Motion command code (OW□□20) invalid 1: Motion command code (OW□□20) valid * Be sure to set it to "1."								Always valid
			9	ZRNDIR (Initial value = 0)	Set the direction for returning to the zero point. 0: Reverse direction (position pulse in the deceleration direction) 1: Forward direction (position pulse in the acceleration direction)								
			10 to 15	Reserved	Set "0."								

Table 5.2 List of Motion Setting Parameters (Cont'd)

No.	Name	Register No.	Setting range/ Bit name	Meaning	Motion Command Code (OW□□20)							
					Positioning	External positioning	Zero point return	Interpolation	Latch	Constant speed feed	Constant dec feed	
2	RUN Command Settings (SVRUNCMD)	OW□□01	Bit 0	RUN (Initial value = 0)	Servo ON (DO0)	Always valid						
			1 to 11	Reserved	Set "0."	-						
			12	USE_BUF (Initial value = 0)	Position Reference Value Selection 0: Position reference value is OL□□12. 1: Position reference value is position buffer	<input type="checkbox"/>	<input type="checkbox"/>	<input type="checkbox"/>	<input type="checkbox"/>	<input type="checkbox"/>	<input type="checkbox"/>	<input type="checkbox"/>
			13	SPDTYPE (Initial value = 0)	Speed Reference Value Selection 0: OL□□22 is valid for the rapid feed speed. 1: OW□□15 is valid for the rapid feed speed.	<input type="checkbox"/>	<input type="checkbox"/>	<input type="checkbox"/>	<input type="checkbox"/>	<input type="checkbox"/>	<input type="checkbox"/>	<input type="checkbox"/>
			14	XREFTYPE (Initial value = 0)	Position Reference Type 0: Absolute position method for position reference (OL□□12). 1: Incremental addition method for position reference (OL□□12).	<input type="checkbox"/>	<input type="checkbox"/>	<input type="checkbox"/>	<input type="checkbox"/>	<input type="checkbox"/>	<input type="checkbox"/>	<input type="checkbox"/>
			15	Reserved	-	-						
3 6	Reserved	OW□□02 OW□□05	-	Set "0."	-							
7	Machine Coordinate System Zero Point Offset Setting (ABSOFF)	OL□□06	-2^{31} to $2^{31}-1$ (Initial value = 0)	1=1 reference unit (1=1 pulse for the pulse unit)	Always valid							
9 12	Reserved	OW□□08 OW□□0B	-	Set "0."	-							
13	Linear Acceleration Time Constant (NACC)	OW□□0C	0 to 32767 (Initial value = 0)	1=1 ms (300 = 0.300 s)	Valid when OW□□2010							
14 16	Reserved	OW□□0D OW□□0F	-	Set "0."	-							
17	Position Loop Gain Setting (Kp)	OW□□10	0 to 32767 (Initial value = 300)	1=0.1/s (300 = 30.0)	Valid when OW□□2015							
18	Feed Forward Gain Setting (Kf)	OW□□11	0 to 200 (Initial value = 0)	1=1% (10 = 10%)	Valid when OW□□2016							

Table 5.2 List of Motion Setting Parameters (Cont'd)

No.	Name	Register No.	Setting range/ Bit name	Meaning	Motion Command Code (OW□□20)						
					Positioning	External positioning	Zero point return	Interpolation	Latch	Constant speed feed	Constant step feed
19	Position Reference Setting (XREF) or Position Buffer Number	OL□□12	-2^{31} to $2^{31}-1$ (Initial value = 0)	1=1 reference unit (1=1 pulse for the pulse unit) * For Position Reference Value Selection (OB□□01C) = 1, the position buffer No. (1 to 256).	○	○	○	○	○	○	○
21	Filter Time Constant Setting (NNUM)	OW□□14 (Initial value = 0)	0 to 5100 0 to 65535	(1) For Bit 4 to 7 of OW□□21 equal to "2", the S-curve (Movement Averaging) time constant 1=100 us (2) For Bit 4 to 7 of OW□□21 equal to "1", the exponential acceleration/deceleration time constant 1=1 ms	Valid when OW□□20 = 12						
22	Speed Reference Setting (NREF)	OW□□15	0 to 32767 (Initial value = 0)	Valid when the speed reference value selection (OW□□01D) = 1. 1=0.01% (5000=50.00%)	○	○	○	○	○	○	○
23 29	Reserved	OW□□16 OW□□1C	-	Set "0."	-						
30	Speed Loop Gain Setting (Ku)	OW□□1D	1 to 20000 (Initial value = 400)	1=0.1 Hz (400=40.0 Hz)	Valid when OW□□20 = 14						
31	Reserved	OL□□1E	-	Set "0."	-						
33	Motion Command Code (MCMDCODE)	OW□□20	0 to 65535 (Initial value = 0)	0: NOP No reference available 1: POSING Positioning 2: EX_POSING External Positioning 3: ZRET Zero Point Return 4: INTERPOLATE Interpolation 5: ENDOF_INTERPOLATE Final Interpolation Segment (For motion functions) 6: LATCH Interpolation with Position Detection 7: FEED Constant Speed Feed 8: STEP Constant Step Feed 9: ZSET Zero Point Setting 10: ACC Changing the Linear Acceleration/deceleration Time Constant 11: Reserved 12: SCC Changing the Movement Averaging Time Constant	Always valid						

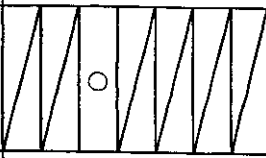
Table 5.2 List of Motion Setting Parameters (Cont'd)

No.	Name	Register No.	Setting range/ Bit name	Meaning	Motion Command Code (OW□□20)							
					Positioning	External positioning	Zero point return	Interpolation	Latch	Constant speed feed	Constant speed feed	
33	Motion Command Code (MCMDCODE)	OW□□20	0 to 65535 (Initial value = 0)	13: CHG_FILTER Changing the Filter Type	Always valid							
				14: KVS Changing the Speed Loop Gain (Kv)								
				15: KPS Changing the Position Loop Gain (Kp)								
				16: KFS Changing the Feed Forward (Kf)								
				17: CN_RD Reading the Servo Driver Cn Constant								
				18: CN_WR Writing the Servo Driver Cn Constant								
				19: ALM_MON Servo Driver Current Alarm Monitor								
				20: ALMHIST_MON Servo Driver Alarm History Monitor								
				21: ALMHIST_CLR Servo Driver Alarm History Clear								
22 to 65535: Reserved												
34	Motion Command Control Flags (MCMDCCTRL)	OW□□21	Bit 0	HOLD (Initial value = 0)	Command Hold	○	○	/	/	○	/	○
			1	ABORT (Initial value = 0)	Command Abort	○	○	○	/	○	○	○
			2	DIRECTION (Initial value = 0)	Direction of Movement 0: Forward 1: Reverse	/	/	/	/	/	○	○
			3	P_PI (Initial value = 0)	Speed Loop P/PI Switch	○	○	○	○	○	○	○
			4 to 7	FITERTYPE (Initial value = 0)	Filter Type Selection 0: No filter available 1: Exponential filter (Exponential acceleration/deceleration) 2: Movement averaging filter (Simple S-curve acceleration/deceleration)	Valid when OW□□20 = 13						
			8 to 13	Reserved	Set "0."	-						
			14	BUF_W (Initial value = 0)	Position Buffer Write 0: No processing 1: Write	Always valid						
			15	BUF_R (Initial value = 0)	Position Buffer Read 0: No processing 1: Read							

Table 5.2 List of Motion Setting Parameters (Cont'd)

No.	Name	Register No.	Setting range/ Bit name	Meaning	Motion Command Code (OW□□20)						
					Positioning	External positioning	Zero point return	Interpolation	Latch	Constant speed feed	Constant step feed
35	Rapid Feed Speed (RV)	OL□□22	0 to $2^{31}-1$ (Initial value = 0)	$1=10^n$ reference unit/min (n: the number of decimal places) For units of pulse : 1=1000 pulse/min For units of mm : 1=1 mm/min For units of deg : 1=1 deg/min For units of inch : 1=1 inch/min	○	○	○	/	/	○	○
37	External Positioning Travel Distance (EXMDST)	OL□□24	-2^{31} to $2^{31}-1$ (Initial value = 0)	The unit is in accordance with that of the SERVOPACK. Refer to the Σ Series SGM□/SGD-□N User's Manual (SIE-S800-26.2).	/	○	/	/	/	/	/
39	Stopping Distance (STOPDIST)	OL□□26	-2^{31} to $2^{31}-1$ (Initial value = 0)	1=1 reference unit Leave the initial value.	/	/	/	○	○	/	/
41	STEP Travel Distance (STEP)	OL□□28	0 to $2^{31}-1$ (Initial value = 0)	1=1 reference unit	/	/	/	/	/	/	○
43	Reserved	OL□□2A	-	Set "0."	/	/	/	/	/	/	/
45	Override (OV)	OW□□2C	0 to 32767 (Initial value = 10000 = 100%)	1=0.01%	○	○	○	/	/	○	○
46	Position Control Flags (POSCTRL)	Bit	0	MLK (Initial value = 0)	Machine Lock Mode Setting 0: OFF 1: ON	Valid when the Distribution Completion (IB□□152) is OFF.					
			1	TPRSREQ (Initial value = 0)	Request for Preset Number of POSMAX Turns 1: Demand ON	Always valid					
			2	ABSLDREQ (Initial value = 0)	ABS System Infinite-length Position Control Data Load Request 1: Demand ON	Valid when OW□□20 = 0					
			3 to 11	Reserved	Set "0."	-					
			12 to 15	USRMONSEL Servo Driver User Monitoring Information Selection	Refer to the Σ Series SGM□/SGD-□N User's Manual (SIE-S800-26.2).	Always valid					
47	Workpiece Coordinate System Offset (OFFSET)	OL□□2E	-2^{31} to $2^{31}-1$ (Initial value = 0)	1=1 reference unit Leave the initial value.	Always valid						
49	Preset Number of POSMAX Turns Data (TURNPRS)	OL□□30	-2^{31} to $2^{31}-1$ (Initial value = 0)	1=1 rotation	Valid when the request to preset the number of POSMAX turns (Bit 1 of OB□□2D) is ON.						
51	Second In-position Width (INPWIDTH)	OW□□32	0 to 65535 (Initial value = 0)	1=1 reference unit (For units of pulse : 1=1 pulse)	Always valid						
52	Zero Point Position Output Width (PSETWIDETH)	OW□□33	0 to 65535 (Initial value = 10)	1=1 reference unit	Always valid after zero point return is completed.						
53	Positioning Completion Check Time (PSETTIME)	OW□□34	0 to 65535 (Initial value = 0)	1=1 ms	Always valid						

Table 5.2 List of Motion Setting Parameters (Cont'd)

No.	Name	Register No.	Setting range/ Bit name	Meaning	Motion Command Code (OW□□20)						
					Positioning	External positioning	Zero point return	Interpolation	Latch	Constant speed feed	Constant decel. feed
54	Servo driver Cn Constant No. (Cn_No)	OW□□35 (Initial value = 0)	Bit0 to 11: Cn constant No. 1 to 4095 Bit12 to 15: Number of words 1 to 2	Refer to the Σ Series SGM□/SGD-□N User's Manual (SIE-S800-26.2).	Valid when OW□□20 = 17 or 18						
	Current Servo Driver Alarm Monitor No.		0 to 9	Refer to the Σ Series SGM□/SGD-□N User's Manual (SIE-S800-26.2).	Valid when OW□□20 = 19						
	Servo Driver Alarm History Monitor No.		0 to 9	Refer to the Σ Series SGM□/SGD-□N User's Manual (SIE-S800-26.2).	Valid when OW□□20 = 20						
55	Cn Constant Change Data (Cn_DAT)	OL□□36	-2^{31} to $2^{31}-1$ (Initial value = 0)	Refer to the Σ Series SGM□/SGD-□N User's Manual (SIE-S800-26.2).	Valid when OW□□20 = 18						
57	Lower-place Two Words of Encoder Position at Shutdown	OL□□38 (Initial value = 0)	-2^{31} to $2^{31}-1$ (Initial value = 0)	Setting data at the ABS system infinite-length position control data load request (1=1 pulse)	Refer to the left column.						
	Position Buffer Access No.		1 to 256 (Initial value = 0)	Position buffer access No. when OB□□21E = 1 or OB□□21F = 1							
59	Upper-place Two Words of Encoder Position at Shutdown	OL□□3A (Initial value = 0)	-2^{31} to $2^{31}-1$	Setting data at the ABS system infinite-length position control data load request (1=1 pulse)	Refer to the left column.						
	Position Buffer Write Data		-2^{31} to $2^{31}-1$	Position buffer write data when OB□□21F = 1							
61	Lower-place Two Words of Pulse Position at Shutdown	OL□□3C	-2^{31} to $2^{31}-1$ (Initial value = 0)	Setting data at the ABS system infinite-length position control data load request (1=1 pulse)	Refer to the left column.						
63	Upper-place Two Words of Pulse Position at Shutdown	OL□□3E	-2^{31} to $2^{31}-1$ (Initial value = 0)	Setting data at the ABS system infinite-length position control data load request (1=1 pulse)	Refer to the left column.						

5.1.3 List of Motion Monitoring Parameters

These parameters are used for the motion module to report. At the beginning of high-speed scanning, they are reported in a batch. Use them for application controls and for debugging user programs.

Note

No. of registers with a different module No. are not consecutive.

Register Nos. of the same module No. are consecutive between axes No. 1 and 8 and between axes No. 9 and 14, but those between axes No. 8 and 9 are not consecutive.

Those with the same module No. are consecutive between axes.

Therefore, care should be taken if a subscript (i, j) is used on a user program.

For details, refer to 5.1 List of Motion Parameters.

Table 5.3 List of Motion Monitoring Parameters

No.	Name	Register No.	Setting range/ Bit name	Meaning	Motion Command Code (OW□□20)						
					Positioning	External positioning	Zero point return	Interpolation	Latch	Constant speed feed	Constant step feed
1	RUN Status (RUNSTS)	IW□□00	Bit 0	Reserved	—	Always valid					
			1	PRMERR	Motion setting parameter setting error						
			2	FPRMERR	Motion fixed parameter setting error						
			3 to 6	Reserved	—						
			7	SVCRDY	Preparation for the running of motion controller is completed.						
			8	SVCRUN	The motion controller is running.						
			9 to 12	Reserved	—						
			13	POSCOMP	Positioning completion signal						
			14	Reserved	—						
			15	Reserved	—						
2	Servo Driver Status (SVSTS)	IW□□01	This is a parameter to monitor the status of the MECHATROLINK servo. For details, refer to the Σ Series SGM□/SGD-□N User's Manual (SIE-S800-26.2). When monitoring this parameter, take communication delay into consideration.		Always valid						
3	Calculated Position in Machine Coordinate System (CPOS)	IL□□02	-2^{31} to $2^{31}-1$	1=1 reference unit For units of pulse, 1=1 pulse. Updating to be performed during machine lock.	Always valid						
5	Reserved	IL□□04	—	—							
7	Machine Coordinate System Latch Position	IL□□06	-2^{31} to $2^{31}-1$	1=1 reference unit For units of pulse, 1=1 pulse.							
9	Machine Coordinate System Feedback Position (APOS)	IL□□08	-2^{31} to $2^{31}-1$	1=1 reference unit For units of pulse, 1=1 pulse.	Always valid						
11 15	Reserved	IW□□0A IW□□0E	—	—							
16	Out of Range Parameter Number (ERNO)	IW□□0F	1 to 64	Motion setting parameter No.	Valid when the parameter setting error (Bit 1 or 2 of IW□□00) is ON.						
			101 to 148	Motion fixed parameter No.+100							
17 20	Reserved	IW□□10 IW□□13	—	—							

Table 5.3 List of Motion Monitoring Parameters (Cont'd)

No.	Name	Register No.	Setting range/ Bit name	Meaning	Motion Command Code (OW□□20)						
					Positioning	External positioning	Zero point return	Interpolation	Latch	Constant speed feed	
21	Motion Command Response Code (MCMDCODE)	IW□□14	0 to 65535	Motion command currently under execution (Details are the same as OW□□20.)	Always valid						
22	Motion Command Status (MCMDSTS)	IW□□15	Bit 0	BUSY	Command execution flag	○	○	○	○	○	○
			1	HOLDL	Command hold completion	○	○	○	○	○	○
			2	DEN	Distribution completion	○	○	○	○	○	○
			3	ZSET	Zero point setting completion	○	○	○	○	○	○
			4	EX_LATCH	External positioning signal latch completion	○	○	○	○	○	○
			5	FAIL	Command error end	○	○	○	○	○	○
			6	ZRNC	Zero point return completion status	○	○	○	○	○	○
			7 to 15	Reserved	-	○	○	○	○	○	○
23	Number of Digits Below Decimal Monitor (DECNUMM)	IW□□16	0 to 5	Set the number of digits to the right of the decimal point of reference (Example) For the number of digits to the right of the decimal point = 3, mm : One reference unit = 0.001 mm deg : One reference unit = 0.001 deg inch : One reference unit = 0.001 inch This parameter and the Reference Unit Selection (motion fixed parameter No.17.) gives the minimum reference unit. However, the minimum unit of "pulse" is not affected by this parameter.	Always valid						
24	Position Control Status (POSSTS)	IW□□17	Bit 0	MLKL	Machine lock ON	○	○	○	○	○	○
			1	ZERO	Zero point position	○	○	○	○	○	○
			2	PSET2	Second INP completion (Interlocked with the issue completion)	○	○	○	○	○	○
			3	ABSLDE	ABS system infinite-length position control data load completion	Valid when ABS system infinite-length position control data load request (OB□□2D2) is ON.					
			4	TPRSE	Preset request for number of POSMAX turns completed	Valid when request for preset number of POSMAX turns (OB□□2D1) is ON.					
			5	GEARM	Electric Gear Selection 0: Invalid 1: Valid	○	○	○	○	○	○
			6	MODSELM	Axis Selection 0: Finite-length axis 1: Infinite-length axis	○	○	○	○	○	○
			7 to 11	Reserved	-	-					
			12 to 15	USRMONLR	Electric Gear Selection 0: Invalid 1: Valid	○	○	○	○	○	○

Table 5.3 List of Motion Monitoring Parameters (Cont'd)

No.	Name	Register No.	Setting range/ Bit name	Meaning	Motion Command Code (OW□□20)					
					Positioning	External positioning	Zero point return	Interpolation	Latch	Constant speed feed
25	Machine Coordinate Reference Position (MPOS)	IL□□18	-2^{31} to $2^{31}-1$	1=1 reference unit For units of pulse, 1=1 pulse. Updating not to be performed during machine lock.	Always valid					
27	Reserved	IL□□1A	-	-	-					
29	POSMAX Monitor (PMAXTURN)	IL□□1C	1 to $2^{31}-1$	1=1 reference unit Set the number of digits to the right of the decimal point of reference (Example) For the number of digits to the right of the decimal point = 3, mm : One reference unit = 0.001 mm deg : One reference unit = 0.001 deg inch : One reference unit = 0.001 inch This parameter and the Reference Unit Selection (motion fixed parameter No.17.) gives the minimum reference unit. However, the minimum unit of "pulse" is not affected by this parameter.	Always valid					
31	Number of POSMAX Turns (PMAXTURN)	IL□□1E	-2^{31} to $2^{31}-1$	1=1 rotation Counted up or down every time the number exceeds POSMAX. (To be initialized to "0" at turning power ON.)	Valid when "infinite-length axis" is selected by fixed parameter No. 17.					
33	Servo Driver User Monitor Information (USRMON)	IL□□20	-2^{31} to $2^{31}-1$	Refer to the servo driver manual.	Always valid					
35	Alarms (ALARM)	IL□□22			Always valid					
		Bit								
		0	SVERROR	SERVOPACK error						
		1	OTF	Positive overtravel						
		2	OTR	Negative overtravel						
		3	SOTF	Positive software limit						
		4	SOTR	Negative software limit						
		5	SVOFF	Servo OFF (The move command is issued when SVCRUN is OFF.)						
		6	TIMEOVER	Positioning time over						
		7	DISTOVER	Positioning travel distance over						
		8	FILTYPER	Filter type change error						
		9	FILTIMERR	Filter time constant change error						
		10	MODERR	Control mode error (The move command has been issued except for the position control mode.)						
		11	ZSETNRDY	Zero point not set						
		12, 13	Reserved	-						
		14	WOT_ERR	Servo driver synchronous communication error						
		15	COM_ERR	Servo driver communication error						
16	SVTIMOVT	Servo driver command timeout error								
17	ABSOVER	ABS encoder count exceeded								
18 to 31	Reserved	-								
37	Servo Driver ALARM Code (SVALARM)	IW□□24	-	Refer to the servo driver manual.	Always valid					
38	Servo Driver I/O Monitor (SVIOMON)	IW□□25	-	Refer to the servo driver manual.	Always valid					
39	Speed Reference Output Monitor (RVMON)	IL□□26	1 to $2^{31}-1$	1=1 reference unit/s (for system use)	Always valid					

Table 5.3 List of Motion Monitoring Parameters (Cont'd)

No.	Name	Register No.	Setting range/ Bit name	Meaning	Motion Command Code (OW□□20)					
					Positioning	External positioning	Zero point return	Interpolation	Latch	Constant speed feed
41	Cn Constant Read Data (CNMON) or Position Buffer Read Data	IL□□28	-2^{31} to $2^{31}-1$	The position buffer data is copied when the position buffer reading (OB□□21F) = 1.						Valid when position buffer reading data OW□□21F = 1
43	Position Reference Output Value Monitor (XREFMON)	IL□□2A	-2^{31} to $2^{31}-1$							Always valid
45	Reserved	IL□□2C	-	-						-
47	Calculated Reference Coordinate System Position (POS)	IL□□2E	-2^{31} to $2^{31}-1$	1=1 reference unit						Always valid
49 - 56	Reserved	IL□□30 IW□□37	-	-						-
57	Lower-place Two Words of Encoder Position at Shutdown	IL□□38	-2^{31} to $2^{31}-1$	These parameters are used for ABS system infinite-length position control. "Encoder position at shutdown" and "Pulse position at shutdown" are called ABS infinite-length position control data.						Valid when "absolute encoder" is selected by motion fixed parameter No. 3 "Encoder Selection"; "infinite-length axis" is selected by motion fixed parameter No. 17 "Motion Controller Function Selection Flags"; and the Zero Point Setting Complete (IB□□153) is ON.
59	Upper-place Two Words of Encoder Position at Shutdown	IL□□3A	-2^{31} to $2^{31}-1$							
61	Lower-place Two Words of Pulse Position at Shutdown	IL□□3C	-2^{31} to $2^{31}-1$							
63	Upper-place Two Words of Pulse Position at Shutdown	IL□□3E	-2^{31} to $2^{31}-1$							

5.2 Details of Motion Parameters

5.2.1 Details of Motion Fixed Parameters

Note

Fixed parameters cannot be changed when the current value of Bit 0 of motion setting parameter No. 2 "RUN Command Setting (OW□□01)" is ON.

Be aware that if any motion fixed parameter is changed, position information, etc., will be initialized.

Table 5.4 Details of Motion Fixed Parameters

No.	Name	Description	Initial value
1	Axis Use Selection (USESEL)	Designate either "not to use (= 0)" or "to use (= 1)" the relevant axis. Selecting "Not used" will result in no control of the axis. And also, the motion monitoring parameters (IW□□00 to IW□□3F) are not updated. However, "0" is stored to the running status (IW□□00). When no axis is used, select "Not used" in order to shorten the processing time. The initial value for this is set to "Not used (= 0)." However, be sure to set the pulse output maximum frequency even when no axis is used.	0 (Not used)
3	Encoder Selection (ENCSEL)	Designate the pulse encoder type: incremental encoder (= 0), absolute encoder (= 1) or absolute encoder of incremental type (= 2). The initial value is "incremental encoder" (= 0).	0 (Incremental encoder)
5	Pulse Counting Mode Selection (PULMODE)	Designate the pulse counting method. There are three pulse counting methods as follows. Designate corresponding to the machine in use (pulse taking method). * A/B pulse method multiplied by 1 (= 4) * A/B pulse method multiplied by 2 (= 5) * A/B pulse method multiplied by 4 (= 6) The initial value is "A/B pulse method multiplied by 4" (= 6).	6(A/B×4)
7	Rated Motor Speed Setting (NR)	Set the number of rotations at the rated (100%) rotation in units of 1 r/min. Set corresponding to the machine in use (motor specifications). The initial value is 3000 r/min.	3000
8	Number of Feedback Pulses per Rotation (FBppr)	Set the number of feedback pulses per motor rotation. Set a multiple of 4 within the range between 4 and 65532 (P/R). Set corresponding to the machine in use (encoder specifications). The initial value is 2048 P/R (= 2048).	2048
16	Simulation Mode Selection (SIMULATE)	Designate the running mode. If "simulation mode" is selected, simulated values are reported to the motion monitoring parameters (position monitor, etc) without actually connecting with the servo driver. Use it for debugging application programs. The initial value is "normal operation mode" (= 0).	0 (Normal operation)

Table 5.4 Details of Motion Fixed Parameters (Cont'd)

No.	Name		Description	Initial value
17	Motion Controller Function Selection Flags (SVFUNCSEL)		Provides function selection such as invalid/valid of a function.	
	Bit	0 to 3	Reference Unit Selection (CMD_UNIT)	0 (Pulse)
			Select the unit of the reference to be input. The units for reference available are pulse, mm, deg, and inch. This unit selection and setting of the motion fixed parameter No.18, "Number of Digits Below Decimal Point" will give a minimum reference unit by which this module can be referenced. Also refer to 3.1 (1) "Reference units."	
		4	Electric Gear Selection (USE_GEAR)	0 (Invalid)
			Select whether or not to use the function of the electronic gear. Refer to 3.1 (2) "Electronic gear," for the electronic gear. This is invalid when the reference unit selection is the pulse (= 0). In this case, set this selection to invalid (= 0).	
		5	Axis Selection (PMOD_SEL)	0 (Finite-length axis)
			Select either the finite-length axis (= 0) or infinite-length axis (= 1). Refer to 3.1 (3) "Axis selection," for the finite-length axis/infinite-length axis.	
		6	Reserved	0
		7	Positive Software Limit Selection (USE_SLIMP)	0 (Invalid)
			Select whether or not to use the function of the positive software limit. Setting this selection to invalid (= 0) will not allow the positive software limit to work. When this bit is set to valid (= 1) and when zero point return has been accomplished (the Zero Point Return Completion Status, IB□□156, of the motion monitoring parameter is "ON"), the software limit function is valid. This selection is invalid when the axis selection (Bit 5 of the Motion Controller Function Selection Flags) is set to the infinite-length axis (= 1). In this case set it to invalid (= 0).	
		8	Negative Software Limit Selection (USE_SLIMN)	0 (Invalid)
			Select whether or not to use the function of the negative software limit. Setting this selection to invalid (= 0) will not allow the negative software limit to work. When this bit is set to valid (= 1) and when zero point return has been accomplished (the Zero Point Return Completion Status, IB□□156, of the motion monitoring parameter is "ON"), the software limit function is valid. This selection is invalid when the axis selection (Bit 5 of the Motion Controller Function Selection Flags) is set to the infinite-length axis (= 1). In this case set it to invalid (= 0).	
		9	Override Selection (USE_OV)	0 (Invalid)
			Select whether or not to use the function of the override function. When set this to invalid (= 0), "Override" is fixed. Also refer to 3.1 (6) "Speed references." (Note) The override means a function to "change to use" the setting of the feed speed.	
		10, 11	Reserved	0
		12	Servo Driver Transparent Command Mode (THROUMOD)	0
			In this mode, the set MECHATROLINK servo command is sent to the SERVOPACK as it is. For MECHATROLINK, refer to the Σ Series SGM□/SGD-□N User's Manual (SIE-S800-26.2), the High-Speed Field Network MECHATROLINK System User's Manual (SIE-S800-26.1), and the High-Speed Field Network MECHATROLINK Servo Command User's Manual (SIE-S800-26.2). Under the MECHATROLINK servo command, command data is sent by using the motion setting parameters from OW□□30 to OW□□37 (16 bytes), and response data is received by using the motion monitoring parameters from IW□□30 to IW□□37 (16 bytes).	
		13, 14	Reserved	0
		15	Interpolation Command Segment Distributing Function	0
			Be sure to set this bit to "valid" (= 0) when using any interpolation-based motion command (INTERPOLATE, ENDOF_INTERPOLATE, or LATCH).	

Table 5.4 Details of Motion Fixed Parameters (Cont'd)

No.	Name	Description	Initial value
18	Digits Below Decimal Point (DECNUM)	Set the number of digits to the right of the decimal point of the reference unit to be input. This setting and the setting of selection for the reference unit (Bit 0 to 3 of the Motion Controller Function Selection Flags) will give a minimum reference unit by which this module can be referenced. Also refer to 3.1 (1) "Reference unit."	3
19	Travel Distance per Machine Rotation (PITCH)	This is a parameter which represents the amount of load movement per rotation of the load axis. Set the value of the amount of load movement divided by the reference unit. Refer to 3.1 (2) "Electronic gear" for details. Setting the Electronic gear selection (Bit 4 of the Motion Controller Function Selection Flags) to invalid will make it invalid. In this case, set the initial value.	10000
21	Servomotor Gear Ratio (GEAR_MOTOR)	This is a parameter to set the gear ratio between the motor and load. Set the gear ratio on the motor side to this parameter in the unit of per rotation. Setting the Electronic gear selection (Bit 4 of the Motion Controller Function Selection Flags) to invalid will make it invalid. In this case, set the initial value.	1
22	Machine Gear Ratio (GEAR_MACHINE)	This is a parameter to set the gear ratio between the motor and load. Set the gear ratio on the load side to this parameter in the unit of per rotation. Setting the Electronic gear selection (Bit 4 of the Motion Controller Function Selection Flags) to invalid will make it invalid. In this case, set the initial value.	1
23	Infinite-length Axis Reset Position (POSMAX)	Setting the axis selection (Bit 5 of the Motion Controller Function Selection Flags) to the infinite-length axis requires the setting of the reset position for per rotation. Setting it to the finite-length axis will make it invalid. In this case, set the initial value. Also refer to 3.1 (3) "Axis selection."	360000
25	Maximum Number of Absolute Encoder Turns (MAXTURN)	When using the absolute encoder, set its maximum amount of turn. Refer to the SERVOPACK manual.	99999
27	Positive Software Limit (SLIMP)	Setting the positive software limit selection (Bit 7 of the Motion Controller Function Selection Flags) is set to valid, set the positive software limit value. Setting it to invalid will make it invalid. In this case, set the initial value. When this bit is set to valid (= 1) and when zero point return has been accomplished (the zero point return completion status, IB□□156, of the motion monitoring parameter is "ON"), the software limit function is valid. This selection is invalid when the axis selection (Bit 5 of the Motion Controller Function Selection Flags) is set to the infinite-length axis (= 1). In this case set it to invalid (= 0).	$2^{31}-1$
29	Negative Software Limit (SLIMN)	Setting the negative software limit selection (Bit 8 of the Motion Controller Function Selection Flags) is set to valid, set the negative software limit value. Setting it to invalid will make it invalid. In this case, set the initial value. When this bit is set to valid (= 1) and when zero point return has been accomplished (the zero point return completion status, IB□□156, of the motion monitoring parameter is "ON"), the software limit function is valid. This selection is invalid when the axis selection (Bit 5 of the Motion Controller Function Selection Flags) is set to the infinite-length axis (= 1). In this case set it to invalid (= 0).	-2^{31}
31	Zero Point Return Method (ZRETSEL)	Set the zero point return method on zero point return. Refer to 3.4, "Zero Point Return" for details.	2(DEC+ZERO signal)
32	Reserved	-	0

5.2.2 Details of Motion Setting Parameters

Note

No. of registers with a different module No. are not consecutive.

Register Nos. of the same module No. are consecutive between axes No. 1 and 8 and between axes No. 9 and 14, but those between axes No. 8 and 9 are not consecutive.

Those with the same module No. are consecutive between axes.

Therefore, care should be taken if a subscript (i, j) is used on a user program.

For details, refer to 5.1 List of Motion Parameters.

Table 5.5 Details of Motion Setting Parameters

No.	Name	Register No.	Setting range/ Bit name	Description	Initial value	
1	RUN Mode Settings (RUNMOD)	OW□□00		Set the running mode such as control mode or alarm reset. The running mode is made up of bits. The configuration of the bits are shown below.		
		Bit	0	Reserved	Set "0."	0
			1	Reserved	Set "0."	0
			2	Position Control Mode (PCON)	Set the position control mode.	1 (Used)
			3 to 5	Reserved	Set "0."	0
			6	Alarm Clear (ACR)	The rise of this bit will clear (= 0) error information. The following items are to be cleared: (1) Motion Setting Parameter Setting Error (Bit 1 of IW □□00 RUN Status) (2) Alarm (II□□22)	0
			7	Reserved	Set "0."	0
			8	Motion Command Code Use Selection (MCDSEL)	Set whether used or not to use the Motion Command Code (OW□□20). Be sure to set "1" for this module.	1 (Used)
			9	Zero Point Return Direction Selection (ZRNDIR)	Set the direction for zero point return on Zero Point Return (DEC + ZERO signal). 0: Returns to zero point in the negative direction (in the direction of position pulses to be reduced). 1: Returns to zero point in the positive direction (in the direction of position pulses to be increased). Also refer to 3.4, "Zero Point Return."	0
			10 to 15	Reserved	Set "0."	0

Table 5.5 Details of Motion Setting Parameters (Cont'd)

No.	Name	Register No.	Setting range/ Bit name	Description	Initial value	
2	RUN Command Settings (SVRUNCMD)	OW□□01		Set the output signal from this module to the pulse motor driver and the running mode necessary for motion control. The RUN command is made up of bits. The configuration of the bits are shown below.	0	
		Bit	0	Servo ON (RUN)	Used for Servo ON signal of the servo driver.	0
			1 to 11	Reserved	Set "0."	0
			12	Position Reference Value Selection (USE_BUF)	Select the reference method for the position reference data. 0: Represents that the position reference data are those of OL□□12. The position reference data is set to OL□□12. 1: Represents that the position reference data are position buffers. The position buffer No. is set to OL□□12. At this time, the position data is required to have been set to the designated position buffer No. Refer to 3.1 (4) "Position references" for details.	0
			13	Speed Reference Value Selection (SPDTYPE)	Select the register No. and unit of speed reference value of the feed speed. 0: Set the rapid feed speed to OL□□22. 1: Set the rapid feed speed to OW□□15. Refer to 3.1 (6) "Speed references" for details.	0
			4	Position Reference Type (XREFTYPE)	Select the data type of the position reference data. 0: The position reference (OL□□12) follows the absolute position method. 1: The position reference (OL□□12) follows the increment addition method. Refer to 3.1 (4) "Position references" for details.	0
15	Reserved	Set "0."	0			
3 6	Reserved	OW□□02 OW□□05	-	Set "0."	0	
7	Machine Coordinate System Zero Point Offset Setting (ABSOFF)	OL□□06	-2^{31} to $2^{31}-1$	The position information can be offset only by means of the setting value of this register. This is valid even during RUN, however, use it when RUN is OFF. This register accommodates data which constitutes the position control performed by this module. Any incorrect setting to this register will affect subsequent movement operation so that care must be taken when used. Be sure to check whether correct data have been set or not before running. Failure to check it may lead to tool damage due to interference and possible accidents.	0	
9 12	Reserved	OW□□08 OW□□0B	-	Set "0."	0	
13	Linear Acceleration Time Constant (NACC)	OW□□0C	0 to 32767	Set the linear acceleration time. Set the acceleration time to reach from 0 % to 100 % (the rated rotation speed). The data set here is reflected in the SERVOPACK Cn constant "Second Linear Acceleration/deceleration Time Constant (Cn-0020)" when the Motion Command Code (OW□□20) = 10.	0	
14 16	Reserved	OW□□0D OW□□0F	-	Set "0."	0	

Table 5.5 Details of Motion Setting Parameters (Cont'd)

No.	Name	Register No.	Setting range/ Bit name	Description	Initial value
17	Position Loop Gain Setting (Kp)	OW□□10	0 to 5000	<p>Set the position loop gain in the servo system. Position loop gain is needed to set response performance for the servo system. The following are setting guidelines.</p>  <p>Set an appropriate value for the machine rigidity, inertia, and type of Servomotor. The data set here is reflected in the SERVOPACK Cn constant "Position Loop Gain (Cn-001A)" when the Motion Command Code (OW□□20) = 15.</p>	300(30.0)
18	Feed Forward Gain Setting (Kf)	OW□□11	0 to 200	<p>Reduces positioning time by applying feed forward control. Reference position and actual position error decrease with higher settings.</p>  <p>The data set here is reflected on the SERVOPACK Cn constant "Feed Forward Gain (Cn-001D)" when the Motion Command Code (OW□□20) = 16.</p>	0
19	Position Reference Setting (XREF) or Position Buffer Number	OL□□12	-2^{31} to $2^{31}-1$	<p>Set the position reference value. Care should be taken because the setting data will bear a different meaning according to the Position Reference Value Selection (OB□□00C) and Position Reference Type (OB□□00E). Refer to 3.1 (4) "Position references."</p>	0
21	Filter Time Constant (NNUM)	OW□□14	<p>(1) When the movement averaging filter is used, 0 to 5100 (0 = 1 = without filter). (2) Exponential acceleration/deceleration 0 to 65535</p>	<p>Set the time constant to use the movement averaging filter or the exponential acceleration/deceleration filter. Set the type of the filter by the Filter Type Selection (Bit 4 to 7 of OW□□21). The data set here is reflected in the following when the Motion Command Code (OW□□20) = 12. (i) SERVOPACK Cn constant "Average move time (Cn-0026)" when bit 4 to 7 of OW□□21 = 2 (movement averaging filter). (ii) SERVOPACK Cn constant "Exponential acceleration/deceleration time constant (Cn-002E)" when bit 4 to 7 of OW□□21=1 (exponential filter).</p>	0
22	Speed Reference Setting (NREF)	OW□□15	0 to 32767	<p>When the Speed Reference Value Selection (OB□□01D) is set to "1", set the rapid feed speed in the unit of 0.01% (the proportion against the rated rotation speed). Also refer to 3.1 (6) "Speed references."</p>	0
23 29	Reserved	OW□□16 OW□□1C	-	Set "0."	0
30	Speed Loop Gain Setting (Kv)	OW□□1D	1 to 20000	<p>Set the proportional gain of the speed loop. The data set here is reflected in the SERVOPACK Cn constant "Speed loop gain (Cn-0004)" when the Motion Command Code (OW□□20) = 14.</p>	400
31	Reserved	OL□□1E	-	Set "0."	0

Table 5.5 Details of Motion Setting Parameters (Cont'd)

No.	Name	Register No.	Setting range/ Bit name	Description	Initial value	
33	Motion Command Code (MCMDCODE)	OW□□20	0 to 65535	Set the motion function (such as move command) to be used. The motion functions available are Positioning (POSING), External positioning (EX_POSING), Zero point return (ZRET), Interpolation (INTERPOLATE), Constant speed feed (FEED), and Constant step feed (STEP). The final interpolation segment (ENDOF_INTERPOLATE) is intended for motion functions which are not needed. Setting the move command by this register when SVCRN (IB□□008) is "OFF" will result in an alarm. Refer to 3.2, "Positioning" through 3.9, "Zero Point Setting" for details.	0	
34	Motion Command Control Flags (MCMCTRL)	OW□□21	Set a supplementary function of the motion command.		0	
			Bit 0	Command Hold (HOLD)	Valid when the motion command (OW□□20) is at the positioning and constant step feed. When this bit is turned ON during the axis movement, the axis is decelerated to stop. On completing the suspension, the hold completion (IB□□151) is turned "ON." When this bit is turned back to "OFF" in this condition, the suspension is released to restart the positioning operation. Refer to the relevant item of each motion function for suspension.	0
			1	Command Abort (ABORT)	Valid when the motion command (OW□□20) is at the Positioning, Zero point return, and Constant step feed. When this bit is turned ON during the axis movement, the axis is decelerated to stop BUSY (IB□□150) is turned "ON" during abort and turned "OFF" at the time of completing abort. Refer to the relevant item of each motion function for abort. To abort the constant speed feed, set the motion command to NOP to allow for the same function.	0
			2	Direction of Movement (DIRECTION)	Valid when the motion command (OW□□20) is at Constant speed feed and Constant step feed. Designate the direction of movement. 0: Forward direction 1: Reverse direction	0
			3	Speed Loop P/PI Switch (P_PI)	Designate the Speed loop control method 0: PI control 1: P control	0
			4 to 7	Filter Type Selection (FILTERTYPE)	Set the type of the acceleration/deceleration filter. 0: No filter available 1: Exponential acceleration/deceleration filter 2: Movement averaging filter Setting "1" or "2" will make the filter time constant (OW□□14) valid. The data set here is valid when the motion command code (OW□□20) = 13.	0
			8 to 11	Reserved	Set "0."	0

Table 5.5 Details of Motion Setting Parameters (Cont'd)

No.	Name	Register No.	Setting range/ Bit name	Description	Initial value	
34	Motion Command Control Flags (MCMCTRL)	Bit	14	Position Buffer Write (BUF_W)	By turning ON this bit, the data set to the Position Buffer Write Data (OL□□3A) is stored in the position buffer set by the position buffer access No. (OL□□38) as absolute position data. Also refer to 3.1 (4) "Position references."	0
			15	Position Buffer Read (BUF_R)	By turning ON this bit, the data set by the Position Buffer Access No. (OL□□38) is read and stored in the Position Buffer Read Data (OL□□28). Use it for checking the position stored in the position buffer. It should be noted that it takes 2 scans from the issue of the read command (this bit is turned "ON") until the data is stored at the Position Buffer Read Data (OL□□28). Also refer to 3.1 (4) "Position references."	0
35	Rapid Feed Speed (RV)	OL□□22	0 to $2^{31}-1$	When the Speed Reference Value Selection (OB□□01D) is set to "0", this bit allows for setting the rapid feed speed in 10n reference unit / min (n: the number of digits below decimal point). For each setting unit, For units of pulse : 1=1000 pulse/min For units of mm : 1=1 mm/min For units of deg : 1=1 deg/min For units of inch : 1=1 inch/min	0	
37	External Positioning Travel Distance (EXMDIST)	OL□□24	-2^{31} to $2^{31}-1$	Set the stopping distance after input of the LATCH signal (external positioning signal) in the External positioning (EX_POSING) mode. The unit should correspond to that of the SERVOPACK.	0	
39	Stopping Distance (STOPDIST)	OL□□26	-2^{31} to $2^{31}-1$	This parameter is used by the system. Do not use it.	0	
41	STEP Travel Distance (STEP)	OL□□28	0 to $2^{31}-1$	Valid when the motion command (OW□□20) is at the constant step feed. Set the amount of movement in the 1 reference unit. Refer to 3.1 (1) "Reference unit" for the reference unit.	0	
43	Reserved	OL□□2A	—	Set "0."	0	
45	Override (OV)	OW□□2C	0 to 32767	An override value is set when the Override Selection (Bit 9 of the Motion Controller Function Selection Flags) of the motion fixed parameter is set to "Valid." "Override" means changing and using the setting value of feed speed. For example, the speed reference setting is multiplied (100 % = 1.0) by the value set by this register to take this result as the speed reference.	10000	

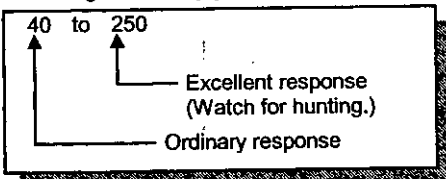
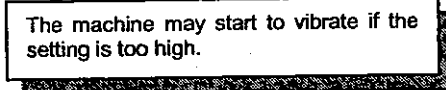
Table 5.5 Details of Motion Setting Parameters (Cont'd)

No.	Name	Register No.	Setting range/ Bit name	Description	Initial value																																	
46	Position Control Flags (POSCTRL)	OW□□2D		Selects a function related to the position information controlled by this module. Made up of bits. The bit configuration is as shown below.																																		
		Bit	0	Machine Lock Mode Setting (MLK)	The motion command is executed as usual and the Calculated Position in Machine Coordinate System (IL□□02) is updated, however, this is a mode where the actual control axis is locked and disabled to move. This bit becomes valid after the completion of issuing (IB□□152 is turned "ON") when it is changed.	0																																
			1	Request for Preset Number of POSMAX Turns (TPRSREQ)	Turning "ON" this bit will allow for presetting the number of POSMAX turns (IL□□1E) using the data set by the Preset Number of POSMAX Turns Data (OL□□30). Use this bit to reset to "0."	0																																
			2	ABS System Infinite-length Position Control Data Load Request (ABSLDREQ)	This is valid when the motion fixed parameter "Encoder selection" is set to "absolute encoder" (= 1) and the motion fixed parameter "Axis selection" (Bit 5 of the Motion Controller Function Selection Flags) is set to "infinite-length axis" (= 1). By turning ON this bit, the position information that is controlled by this module is updated according to the data set to the Encoder Position at Shutdown (OL□□38, OL□□3A) and the Pulse Position at Shutdown (OL□□3C, OL□□3E).	0																																
			3 to 11	Reserved	Set "0."	0																																
			12 to 15	Servo Driver User Monitoring Information Selection (USRMONSEL)	By designating this parameter, the following position information in the MECHATROLINK servo can be monitored. The information is monitored to IL□□20.																																	
					<table border="1"> <thead> <tr> <th>Code</th> <th>Description</th> </tr> </thead> <tbody> <tr> <td>0</td> <td>Reference position on the reference coordinate system</td> </tr> <tr> <td>1</td> <td>Machine reference position in the machine coordinate system</td> </tr> <tr> <td>2</td> <td>Position error</td> </tr> <tr> <td>3</td> <td>Feedback position in the machine coordinate system</td> </tr> <tr> <td>4</td> <td>Counter latch position in the machine coordinate system</td> </tr> <tr> <td>5</td> <td>Internal reference position in the reference coordinate system</td> </tr> <tr> <td>6</td> <td>Internal reference position in the reference coordinate system</td> </tr> <tr> <td>7</td> <td>-</td> </tr> <tr> <td>8</td> <td>Feedback speed</td> </tr> <tr> <td>9</td> <td>Reference speed</td> </tr> <tr> <td>A</td> <td>Final target reference position</td> </tr> <tr> <td>B</td> <td>Torque reference</td> </tr> <tr> <td>C</td> <td>-</td> </tr> <tr> <td>D</td> <td>-</td> </tr> <tr> <td>E</td> <td>Optional monitor 1</td> </tr> <tr> <td>F</td> <td>Optional monitor 2</td> </tr> </tbody> </table>	Code	Description	0	Reference position on the reference coordinate system	1	Machine reference position in the machine coordinate system	2	Position error	3	Feedback position in the machine coordinate system	4	Counter latch position in the machine coordinate system	5	Internal reference position in the reference coordinate system	6	Internal reference position in the reference coordinate system	7	-	8	Feedback speed	9	Reference speed	A	Final target reference position	B	Torque reference	C	-	D	-	E	Optional monitor 1	F
Code	Description																																					
0	Reference position on the reference coordinate system																																					
1	Machine reference position in the machine coordinate system																																					
2	Position error																																					
3	Feedback position in the machine coordinate system																																					
4	Counter latch position in the machine coordinate system																																					
5	Internal reference position in the reference coordinate system																																					
6	Internal reference position in the reference coordinate system																																					
7	-																																					
8	Feedback speed																																					
9	Reference speed																																					
A	Final target reference position																																					
B	Torque reference																																					
C	-																																					
D	-																																					
E	Optional monitor 1																																					
F	Optional monitor 2																																					

Table 5.5 Details of Motion Setting Parameters (Cont'd)

No.	Name	Register No.	Setting range/ Bit name	Description	Initial value
47	Workpiece Coordinate System Offset (OFFSET)	OL□□2E	-2^{31} to $2^{31}-1$	Set "0" as the initial value.	0
49	Preset Number of POSMAX Turns Data (TURNPRS)	OL□□30	-2^{31} to $2^{31}-1$	Turning "ON" the preset request for the Number of POSMAX Turns (OB□□2D1) allows for presetting the Number of POSMAX Turns (IL□□1E) using the data set by this register. Used also for resetting to "0."	0
51	Second In-position Width (INPWIDTH)	OW□□32	0 to 65535	Set the range where the second INP completion (Bit 2 of IW□□17) is turned ON. When issuing is completed (IB□□152 is ON) and $0 \leq$ current position (IL□□08)-reference position on the machine coordinate system (IL□□08) \leq second in-position width (OW□□32), the second INP completion (IB□□172) is turned ON.	0
52	Zero Point Position Output Width (PRETWIDTH)	OW□□33	0 to 65535	Set the range of zero point position. When $0 \leq$ set position in the machine coordinate system (IL□□18) \leq zero point position output width and the zero point return status (IB□□156) is ON, the zero point position (IB□□171) is turned ON.	10
53	Positioning Completion Check Time (PSETTIMB)	OW□□34	0 to 65535	Set the threshold value to detect the positioning time over (Bit 6 of IL□□22) (1=1 ms). After issuing is completed (Bit 2 of IW□□15 is turned ON), if the positioning completion signal (Bit 13 of IW□□00) is not turned ON even with this range exceeded, the alarm "Positioning time over" is given. If "0" is set, this check is not performed. Set "0" if detection of the positioning time over is not wanted.	0
54	Servo Driver Cn Constant No. (Cn_NO) or Current Servo Driver Alarm Monitor No. or Servo Driver Alarm History Monitor No.	OW□□35	0 to 65535	There are three ways to use as follows: (1) Servo driver Cn constant No. (Cn_NO) This is valid when the motion command (OW□□20) is CN_RD (= 17) or CN_WR (= 18). Bit 0 to 11: Cn constant No. Bit 12 to 15: number of words (2) Servo driver current alarm monitor No. designation This is valid when the motion command (OW□□20) is ALM_MON (= 19). Designate within the range between 0 and 5. The alarm code of the designated monitor No. is monitored to IW□□24. (3) Servo driver alarm history monitor No. designation This is valid when the motion command (OW□□20) is ALMHIST_MON (= 20). Designate within the range between 0 and 9. The alarm code of the designated monitor No. is monitored to IW□□24.	0
55	Cn Constant Change Data	OL□□36	-2^{31} to $2^{31}-1$	This is valid when the motion command (OW□□20) is CN_WR (= 18).	0

Table 5.5 Details of Motion Setting Parameters (Cont'd)

No.	Name	Register No.	Setting range/ Bit name	Description	Initial value
57	Lower-place Two Words of Encoder Position at Shutdown or Position Buffer Access No.	OL□□38	-2^{31} to $2^{31}-1$	<p>Be aware that there are two ways to use as follows:</p> <p>(1) Lower-place Two Words of Encoder Position at Shutdown This is valid when the motion fixed parameter "Encoder selection" is set to "absolute encoder" (=1) and the motion fixed parameter "Axis selection" (Bit 5 of the Motion Controller Function Selection Flags) is set to "infinite-length axis" (=1). When the request to load the ABS System Infinite-length Position Control Data Load Request (Bit 2 of OW□□2D) is ON, the data set to this parameter is handled as the Lower-place Two Words of Encoder Position at Shutdown.</p> <p>(2) Position Buffer Access No. Set the No. of the position buffer to be accessed when the Position Buffer Write (Bit 14 of OW□□21) is ON or when the Position Buffer Read (Bit 15 of OW□□21) is ON.</p>	0
59	Upper-place Two Words of Encoder Position at Shutdown or Position Buffer Write Data	OL□□3A	-2^{31} to $2^{31}-1$	<p>Be aware that there are two ways to use as follows:</p> <p>(1) Upper-place Two Words of Encoder Position at Shutdown This is valid when the motion fixed parameter "Encoder selection" is set to "absolute encoder" (=1) and the motion fixed parameter "Axis Selection" (Bit 5 of the Motion Controller Function Selection Flags) is set to "infinite-length axis" (=1). When the ABS System Infinite-length Position Control Data Load Request (Bit 2 of OW□□2D) is ON, the data set to this parameter is handled as the Upper-place Two Words of Encoder Position at Shutdown.</p> <p>(2) Position Buffer Write Data When the Position Buffer Write (Bit 14 of OW□□21) is ON, the data set to this parameter is written in the position buffer designated by OL□□38 as absolute position data.</p>	0
61	Lower-place Two Words of Pulse Position at Shutdown	OL□□3C	-2^{31} to $2^{31}-1$	<p>This is valid when the motion fixed parameter "Encoder selection" is set to "absolute encoder" (=1) and the motion fixed parameter "Axis Selection" (Bit 5 of the Motion Controller Function Selection Flags) is set to "infinite-length axis" (=1). When the ABS System Infinite-length Position Control Data Load Request (Bit 2 of OW□□2D) is ON, the data set to this parameter is handled as the Lower-place Two Words of Pulse Position at Shutdown.</p>	0
63	Higher-place Two Words of Pulse Position at Shutdown	OL□□3E	-2^{31} to $2^{31}-1$	<p>This is valid when the motion fixed parameter "Encoder selection" is set to "absolute encoder" (=1) and the motion fixed parameter "Axis Selection" (Bit 5 of the Motion Controller Function Selection Flags) is set to "infinite-length axis" (=1). When the ABS System Infinite-length Position Control Data Load Request (Bit 2 of OW□□2D) is ON, the data set to this parameter is handled as the Upper-place Two Words of Pulse Position at Shutdown.</p>	0

5.2.3 Details of Motion Monitoring Parameters

Note

No. of registers with a different module No. are not consecutive.

Register Nos. of the same module No. are consecutive between axes No. 1 and 8 and between axes

No. 9 and 14, but those between axes No. 8 and 9 are not consecutive.

Those with the same module No. are consecutive between axes.

Therefore, care should be taken if a subscript (i, j) is used on a user program.

For details, refer to 5.1 List of Motion Parameters.

Table 5.6 Details of Motion Monitoring Parameters

No.	Name	Register No.	Setting range/ Bit name	Description	
1	RUN Status (RUNSTS)	IW□□00		Reports the running status of the module. Made up of bits. The bit configuration is shown below.	
		Bit	0	Reserved	-
			1	Motion Setting Parameter Setting Error (PRMERR)	In setting the motion setting parameters (OW□□00 to OW□□3F), this bit is turned ON when setting is performed beyond the setting range. The latest motion setting parameter No. which has caused the range over error is reported to the range over occurrence parameter No. (IW□□0F).
			2	Motion Fixed Parameter Setting Error (FPRMERR)	In setting the motion fixed parameters (OW□□00 to OW□□3F), this bit is turned ON when setting is performed beyond the setting range. The latest motion fixed parameter No. which has caused the range over error is reported to the range over occurrence parameter No. (IW□□0F). This bit is automatically turned OFF when a proper motion fixed parameter is set from CP-717.
			3 to 6	Reserved	-
			7	Motion Controller RUN Ready (SVCRDY)	The module is turned ON at the completion of running preparation. This bit is turned "OFF" (1) when a serious failure has occurred, (2) when the axis has been selected for no use (motion fixed parameter setting), (3) when an error has occurred in a motion fixed parameter setting, and (4) while the motion fixed parameter is being changed.
			8	Motion Controller RUN (SVCRUN)	This bit is turned "ON" when the above SVCRDY (IB□□007) is "ON" in the position control mode (OB□□002 is "ON") and the Servo-ON (OB□□010) is "ON" (at the rise). When an alarm is on with this bit "ON", the axis will not move even when a motion command is issued. In this case, clear the alarm and then set the motion command to NOP to reset the motion command.
			9 to 12	Reserved	-
			13	Positioning Completion Signal (POSCOMP)	This bit is turned "ON" on completion of positioning.
			14, 15	Reserved	-

Table 5.6 Details of Motion Monitoring Parameters (Cont'd)

No.	Name	Register No.	Setting range/ Bit name	Description
2	Servo Driver Status (SVSTS)	IW□□01	0 to 65535	Monitors the status of the MECHATROLINK servo. For details, refer to the Σ Series SGM□/SGD-□N User's Manual (SIE-S800-26.2). When monitoring this parameter, take delays in communication into consideration.
3	Calculated Position in Machine Coordinate System (CPOS)	OL□□02	-2^{31} to $2^{31}-1$	The Calculated position in the reference coordinate system which the module controls is reported. The position data to be reported to this register becomes usually the target position for every scan. Also refer to 3.1 (5) "Position monitoring."
5	Reserved	IL□□04	-	-
7	Machine Coordinate System Latch Position (LPOS)	IL□□06	-2^{31} to $2^{31}-1$	The latch position in the machine coordinate system that is controlled by this module is reported. This is updated upon completion of latch by execution of external positioning or interpolation with the position detecting function.
9	Machine Coordinate System Feedback Position (LPOS)	IL□□08	-2^{31} to $2^{31}-1$	The feedback position in the machine coordinate system that is controlled by this module is reported.
11 15	Reserved	IW□□0A IW□□0E	-	-
16	Out of Range Parameter Number (ERNO)	IW□□0F	(1) For the motion setting parameter 1 to 64 (2) For the motion fixed parameter 101 to 148	In the setting of the motion setting parameters (OW□□00 to OW□□3F) or motion fixed parameters, the latest parameter No. which has been set beyond the setting range is reported. When a setting range over error has been detected in the setting of the motion setting parameters (OW□□00 to OW□□3F), 1 to 64 is reported as parameter No. When range over error has been detected in the setting of the motion fixed parameters, the motion fixed parameter No. added by 100 (101 to 148) is reported as a parameter No. For example, when a setting range over error has been detected in setting the linear acceleration time constant (OW□□0C), 00013 is to be reported. When a setting range over error has been detected in the number of rated rotation (a motion fixed parameter), 00107 is to be reported. (Note) This is valid when the motion setting parameter setting error (IB□□001), or motion fixed parameter setting error (IB□□002) occurs. * For the causes of error occurrence, refer to the section of supplementary explanation.
17 20	Reserved	IW□□10 IW□□13	-	-
21	Motion Command Response Code (MCMDCODE)	IW□□14	0 to 65535	The motion command (OW□□20) under execution is reported. Refer to OW□□20 for motion commands.
22	Motion Command Status (MCM DSTS)	IW□□15	Reports the execution status of the motion command (OW□□20). Made up of bits. The bit configuration is as shown below.	
		Bit	0	Command Execution Flag (BUSY) Reports the status of the motion command. 0: Ready (Accomplished) 1: BUSY (under processing) This bit is used in particular as status during suspension.
			1	Command Hold Completion (HOLDL) Turned "ON" when suspension has been finished. Refer to each motion function for the suspension function.
			2	Distribution Completion (DEN) Turned "ON" when the issue of movement amount has been completed.
			3	Zero Point Setting Completion (ZSET) Turned "ON" when the Zero point setting (ZSET) is issued to the motion command (OW□□20) and completed.

Table 5.6 Details of Motion Monitoring Parameters (Cont'd)

No.	Name	Register No.	Setting range/ Bit name	Description	
22	Motion Command Status (MCMDSTS)	Bit	4	External Positioning Signal Latch Completion (EX_LATCH)	This bit is turned on upon completion of latching the external signal input when External positioning (EX_POSING) is set to the motion command (OW□□20). This bit is also turned on upon completion of latching the external signal input when interpolation with position detecting function (LATCH) is set to the motion command (OW□□20).
			5	Command Error End (FAIL)	Turned "ON" when an alarm has been given for a reason during the execution of move command (positioning, constant speed feed, etc.). Running is not allowed when this bit is "ON." When this bit is "ON", turn the motion command (OW□□20) to "NOP" temporarily.
			6	Zero Point Return Completion (ZRNC)	Turned "ON" at the time of completion of zero point return or zero point setting. Turned "OFF" at the start of zero point return.
			7 to 15	Reserved	-
23	Number of Digits Below Decimal Monitor (DECNUMM)	IW□□16	0 to 5	The motion fixed parameter No.18, "Number of Digits Below Decimal Point", is reported.	
24	Position Control Status (POSSTS)	Bit	IW□□17		Reports the status related to the position controlled by the module. Made up of bits. The bit configuration is shown below.
			0	Machine Lock ON (MLKL)	Turned "ON" under the condition of machine lock. When this bit is "ON", the output of a command pulse is not performed. Consequently, the actual control axis is locked and held stopped.
			1	Zero Point Position (ZERO)	This bit is turned "ON" when the zero point return is in completion (IB□□156 is "ON") and $0 \leq \text{Machine coordinate reference position (IL□□18)} \leq \text{Zero point position output width (OW□□33)}$.
			2	Second INP Completion (PSET2)	This bit is turned "ON" on completion of issue (IB□□152) is ON and when $ \text{Current position (IL□□08)} - \text{Machine coordinate system position (IL□□18)} \leq \text{Second in-position width (OW□□32)}$.
			3	ABS System Infinite-length Position Control Data Load Completion (ABSLDE)	This is valid when the motion fixed parameter "Encoder selection" is set to "absolute encoder" (= 1) and the motion fixed parameter "Axis selection" (Bit 5 of the Motion Controller Function Selection Flags) is set to "infinite-length axis" (= 1). The bit is turned on upon completion of loading when the ABS System Infinite-length Position Control Data Load Request (OB□□2D2) is ON. The bit is turned OFF by turning OFF the ABS System Infinite-length Position Control Data Load Request (OB□□2D2).
			4	Preset request for number of POSMAX turns completed (TPRSE)	This is valid when the motion fixed parameter "Axis selection" (Bit 5 of the Motion Controller Function Selection Flags) is set to "infinite-length axis" (= 1). This bit is ON after the preset completed when request for preset number of POSMAX turns (OB□□2D1) is ON. This bit is OFF when request for preset number of POSMAX turns (OB□□2D1) is OFF.
			5	Electronic Gear Selection (GEARM)	Data of the motion fixed parameter No.17, Bit 4 "Electronic Gear Selection" is to be reported.
			6	Axis Selection (MODSELM)	Data of the motion fixed parameter No.17, Bit 5 "Axis Selection" is to be reported.
			7 to 11	Reserved	-
			12 to 15	Servo Driver User Monitoring Information Selection Response (USRMONSELR)	The type of monitor information of the value stored in IL□□20 stored.
25	Machine Coordinate Reference Position (MPOS)	IL□□18	-2^{31} to $2^{31}-1$	The reference position in the machine coordinate system that is controlled by this module is reported. This data is not updated when the machine lock condition (IB□□17) is ON. Also refer to 3.1 (5) "Position monitoring."	
27	Reserved	IL□□1A	-	-	

Table 5.6 Details of Motion Monitoring Parameters (Cont'd)

No.	Name	Register No.	Setting range/ Bit name	Description	
29	POS MAX Monitor (PMAXTURN)	IL□□1C	1 to $2^{31}-1$	The motion fixed parameter No.23, "Infinite-length axis reset position (POS MAX)" is to be reported.	
31	Number of POS MAX Turns (PMAXTURN)	IL□□1E	-2^{31} to $2^{31}-1$	Valid when the axis selection of the motion fixed parameter (Bit 5 of the Motion Controller Function Selection Flags) is set to the infinite-length axis (= 1). This bit moves up /down each time the motion fixed parameter No.23, "Infinite-length Axis Reset Position (POS MAX)" is exceeded. Can be preset by the Preset Number of POS MAX Turns Data of the motion setting parameter (OL□□30) or by the Request for Preset Number of POS MAX Turns (OB□□2D1).	
33	Servo Driver User Monitor Information (USRMON)	IL□□20	-2^{31} to $2^{31}-1$	Monitor information of the MECHATROLINK servo selected by Bit 12 to 15 of OW□□2D is stored.	
35	Alarms (ALARM)	IL□□22		Alarm information is reported. Running is not allowed except for the register being "0." The rise of the alarm clear (OB□□006) clears this register to "0." Made up of bits. The bit configuration is shown below.	
		Bit	0	SERVOPACK Error (SVERROR)	A SERVOPACK alarm is detected. For details of the alarm, refer to IW□□24.
			1	Positive Overtravel (OTF)	Overtravel in the positive direction is detected by the SERVOPACK. (ROT signal ON)
			2	Negative Overtravel (OTR)	Overtravel in the negative direction is detected by the SERVOPACK. (N-OT signal ON)
			3	Positive Software Limit (SOFT)	When the axis selection of the motion fixed parameter is at the finite-length axis, when the positive software limit of the motion fixed parameter is selected to be valid, and at the completion status of zero point return (IB□□156 is "ON"), (1) when the motion command (OW□□20) is at interpolation, when the machine coordinate command position (IL□□18) + stopping distance (OL□□26) \geq Positive software limit value (the motion fixed parameter No.27), this bit is turned "ON." (2) when the motion command (OW□□20) is at positioning, constant speed feed, or constant step feed, and the machine coordinate command position (IL□□18) \geq Positive software limit value (the motion fixed parameter No.27), this bit is turned "ON."
			4	Negative Software Limit (SOTR)	When the axis selection of the motion fixed parameter is at the finite-length axis, when the negative software limit of the motion fixed parameter is selected to be valid, and at the completion status of zero point return (IB□□156 is "ON"), (1) when the motion command (OW□□20) is at interpolation, when the machine coordinate command position (IL□□18) + stopping distance (OL□□26) \geq Negative software limit value (the motion fixed parameter No.27), this bit is turned "ON." (2) when the motion command (OW□□20) is at positioning, constant speed feed, or constant step feed, and the machine coordinate command position (IL□□18) \leq Negative software limit value (the motion fixed parameter No.29), this bit is turned "ON."
		5	Servo OFF (SVOFF)	At the position control mode (when OB□□002 is "ON") and when the Servo-ON (OB□□010) is turned "OFF", setting the move command (positioning or constant speed feed, etc.) to the motion command (OW□□20) will cause this bit to be turned "ON."	

Table 5.6 Details of Motion Monitoring Parameters (Cont'd)

No.	Name	Register No.	Setting range/ Bit name	Description	
35	Alarms (ALARM)	Bit	6	Positioning Time Over (TIMEOVER)	After issuing is completed, positioning is not completed within the time set by OW□□34 "Positioning completion check time."
			7	Positioning Travel Distance Over (DISTOVER)	A movement order exceeding the limit value of the amount of positioning movement is given.
			8	Filter Type Change Error (FILTYPERR)	The filter type is changed with issuing incomplete.
			9	Filter Time Constant Change Error (FILTIMERR)	The filter time constant is changed with issuing incomplete.
			10	Control Mode Error (MODERR)	This bit is turned "ON" when the move command (positioning or constant speed feed, etc.) is set to the motion command (OW□□20) in a mode other than the position control mode (OB□□002 is "OFF").
			11	Zero Point Not Set (ZSET_NRDY)	A movement order is given with the zero point unset.
			12, 13	Reserved	-
			14	Servo Driver Synchronous Communication Error (WDT_NRDY)	A synchronous communication error of the MECHATROLINK servo is detected.
			15	Servo Driver Communication Error (COM_ERR)	A communication error of the MECHATROLINK servo is detected twice in succession.
			16	Servo Driver Command Timeout Error (SVTIMOUT)	The command of the MECHATROLINK servo is not completed within the specified time.
			17	ABS Encoder Count Exceeded (ABSOVER)	The amount of absolute encoder turn is beyond the range that can be handled by SVB.
		18 to 31	Reserved	-	
37	Servo Driver ALAM Code (SVALARM)	IW□□24	-	Monitors the alarm code generated in the MECHATROLINK servo. Refer to the Σ Series SGM□/SGD-□N User's Manual (SIE-S800-26.2).	
38	Servo Driver I/O Monitor (SVIOMON)	Bit	0	P-OT	Forward rotation overtravel input
			1	N-OT	Reverse rotation overtravel input
			2	DEC	Deceleration LS input
			3	PA	Encoder Phase-A input
			4	PB	Encoder Phase-B input
			5	PC	Encoder Phase-C input
			6	Not used	-
			7	Not used	-
			8	Not used	-
			9	BRK	Brake condition output
			10 to 15	Not used	-
39	Speed Reference Output Monitor (RVMON)	IL□□26	-2 ³¹ to 2 ³¹ -1	System use parameter	
41	Cn Constant Read Data or Position Buffer Read Data	IL□□28	-2 ³¹ to 2 ³¹ -1	There are two meanings as follows: (1) when the position buffer read of the motion setting parameter (O□□21F) is "ON", the position data is read out from the position buffer designated by the position buffer access No. (OL□□38) to be stored in this register. It should be noted that it takes 2 scans from turning "ON" the position buffer read command (OB□□21F) until the data is stored at this register. (2) The values of the Cn constants read out from the SERVOPACK are stored when the Motion Command Code (OW□□20) is CN RD (= 17).	

Table 5.6 Details of Motion Monitoring Parameters (Cont'd)

No.	Name	Register No.	Setting range/ Bit name	Description
43	Position Reference Output Value Monitor (XREFMON)	IL□□2A	-2^{31} to $2^{31}-1$	System use parameter Position command data output to the servo driver is stored. This bit is "0" under the machine lock condition (IB□□170 is "ON").
45	Reserved	IL□□2C	-	-
47	Calculated Reference Coordinate System Position (POS)	IL□□2E	-2^{31} to $2^{31}-1$	Selecting the infinite-length axis (= 1) at the motion fixed parameter "Axis selection" (Bit 5 of the Motion Controller Function Selection Flags) gives a sense to this bit. The target position at each scan for the infinite-length axis is reported. Also refer to 3.1 (5) "Position monitoring."
49 56	Reserved	IW□□30 IW□□37	-	-
57	Lower-place Two Words of Encoder Position at Shutdown (eposmL)	IL□□38	-2^{31} to $2^{31}-1$	This is valid when the motion fixed parameter "Encoder selection" is set to "absolute encoder" (= 1) and the motion fixed parameter "Axis selection" (Bit 5 of the Motion Controller Function Selection Flags) is set to "infinite-length axis" (= 1). The lower-place two words of the encoder position are reported.
59	Upper-place Two Words of Encoder Position at Shutdown (eposmH)	IL□□3A	-2^{31} to $2^{31}-1$	This is valid when the motion fixed parameter "Encoder selection" is set to "absolute encoder" (= 1) and the motion fixed parameter "Axis selection" (Bit 5 of the Motion Controller Function Selection Flags) is set to "infinite-length axis" (= 1). The upper-place two words of the encoder position are reported.
61	Lower-place Two Words of Pulse Position at Shutdown (aposmL)	IL□□3C	-2^{31} to $2^{31}-1$	This is valid when the motion fixed parameter "Encoder selection" is set to "absolute encoder" (= 1) and the motion fixed parameter "Axis selection" (Bit 5 of the Motion Controller Function Selection Flags) is set to "infinite-length axis" (= 1). The lower-place two words of the pulse position are reported.
63	Upper-place Two Words of Pulse Position at Shutdown (aposmH)	IL□□3E	-2^{31} to $2^{31}-1$	This is valid when the motion fixed parameter "Encoder selection" is set to "absolute encoder" (= 1) and the motion fixed parameter "Axis selection" (Bit 5 of the Motion Controller Function Selection Flags) is set to "infinite-length axis" (= 1). The upper-place two words of the pulse position are reported.

[Supplementary explanation]

1. Causes of error occurrence in fixed parameter/setting parameter setting

(1) Fixed parameter setting errors

IW□□OF	Cause of error occurrence
101	A value other than 0 and 1 is set to "Axis Use Selection."
103	A value other than 0 to 2 is set to "Encoder Selection."
105	A value other than 4 to 6 is set to "Pulse Counting Mode Selection."
107	A value other than 1 to 32000 is set to "Rated Motor Speed Setting."
108	"Number of feedback pulses per motor rotation" is not a multiple of 4 within the range between 4 and 65535.
116	A value other than 0 and 1 is set to "Simulation Mode Selection."
117	<ul style="list-style-type: none"> A value other than 0 to 3 is set to "Reference Unit Selection" of the "Motion Controller Function Selection Flags." "Axis Selection" of the "Motion Controller Function Selection Flags" is set to "infinite-length axis" when a 15-bit or more absolute value encoder is used.
118	<ul style="list-style-type: none"> A value other than 0 to 5 is set to "Number of Digits Below Decimal Point." The result of the calculation of "Gear ratio (motor side) × Number of feedback pulses per motor rotation × multiplier × 10⁽ⁿ⁻¹⁾" exceeds 2³¹-1.
119	A value other than 1 to 2 ³¹ -1 is set to "Travel Distance per Machine Rotation."
121	<ul style="list-style-type: none"> A value other than 1 to 65535 is set to "Servomotor Gear Ratio." The result of the calculation of "Servomotor gear ratio × Number of feedback pulses per motor rotation × multiplier" exceeds 2³¹-1.
122	<ul style="list-style-type: none"> A value other than 1 to 65535 is set to "Machine Gear Ratio." The calculation results of the "Machine gear ratio × Travel distance per machine rotation" exceeds 2³¹-1.
123	A value other than 1 to 2 ³¹ -1 is set to "Infinite-length Axis Reset Position."
125	A value other than 1 to 2 ³¹ -1 is set to "Maximum Number of Absolute Encoder Turns."
131	A value other than 0 to 3 is set to "Zero Point Return Method."

(2) Setting parameter setting errors

IW□□OF	Cause of error occurrence
2	A position buffer is used when the position reference method = incremental.
13	A negative value is set to "Linear Acceleration/deceleration Time Constant."
17	A value other than 1 to 5000 is set to "Position Loop Gain Setting."
18	A value other than 0 to 100 is set to "Feed Forward Gain Setting."
19	A value other than 1 to 256 is set to "Position Reference Setting" when a position buffer is used.
21	A value other than 0 to 5100 is set to "Filter Time Constant" when the filter selection = movement averaging filter.
22	<ul style="list-style-type: none"> A negative value is set to "Speed Reference Designation." An overflow is caused when the "Rapid Feed Speed" is converted to the command speed for the MECHATROLINK servo.
30	A value other than 1 to 20000 is set to "Speed Loop Gain Setting."
33	An incorrect command is set to "Motion Command Code."
34	A value other than 0 to 2 is set to "Filter Type Selection."
35	<ul style="list-style-type: none"> A negative value is set to "Rapid Feed Speed." An overflow is caused when the "Rapid Feed Speed" is converted to the command speed for the MECHATROLINK servo.
41	<ul style="list-style-type: none"> A value other than 0 to 2³¹-1 is set to "STEP Travel Distance." An amount of movement exceeding the limit value of the amount of incremental movement is set to "STEP Travel Distance" when the electronic gear is valid.
45	<ul style="list-style-type: none"> A negative value is set to "Override." An overflow is caused during override operation.
55	<ul style="list-style-type: none"> A value other than 1 to 4095 is set to "User constant Cn" when the motion command CN_RD/CN_WR is executed. A value other than 1 and 2 is set to "Number of words" when the motion command CN_RD/CN_WR is executed. A value other than 0 to 9 is set when the motion command ALM_MON is executed. A value other than 0 to 9 is set when the motion command ALMHIST_MON is executed.

5.3 Examples of Motion Parameter Settings

5.3.1 Examples of Motion Fixed Parameter Settings

Refer to Table 5.1 "List of Motion Fixed Parameters."

Table 5.7 Examples of Motion Fixed Parameter Settings

No.	Name	Setting range/Bit name	Description	Setting (examples)
1	Axis Use Selection (USESEL)	0 or 1 (Initial value = 0)	0: Not used 1: Used	1
2	Reserved	-	-	-
3	Encoder Selection (ENCSEL)	0 or 1 (Initial value = 0)	0: Incremental encoder 1: Absolute encoder	0
4	Reserved	-	-	-
5	Pulse Counting Mode Selection (PULMODE)	4 to 6 (Initial value = 6)	4: A/B method (multiplied by 1) 5: A/B method (multiplied by 2) 6: A/B method (multiplied by 4)	6
6	Reserved	-	-	-
7	Rated Motor Speed Setting (NR)	1 to 32000 (Initial value = 3000)	1=1 r/min	3000
8	Number of Feedback Pulses per Rotation (FBppr)	A multiple of 4 between 4 and 65532 (Initial value = 2048)	1=1 pulse/rev * Set a yet-to-be-multiplied value.	2048
9 15	Reserved	-	-	-
16	Simulation Mode Selection (SIMULATE)	0 or 1	0: Normal operation mode 1: Simulation mode	0
17	Motion Controller Function Selection Flags (SVFUNCSEL)	Bit		
		0 to 3: CMD_UNIT (Initial value = 0)	Reference Unit Selection 0: pulse (electronic gear invalid) 1: mm 2: deg 3: inch	0
		4: USE_GEAR (Initial value = 0)	Electric Gear Selection 0: Invalid 1: Valid	0
		5: PMOD_SEL (Initial value = 0)	Axis Selection 0: Finite-length axis 1: Infinite-length axis	0
		6: Reserved	-	-
		7: USE_SLIMP (Initial value = 0)	Positive Software Limit Selection 0: Invalid 1: Valid	0
		8: USE_SLIMN (Initial value = 0)	Negative Software Limit Selection 0: Invalid 1: Valid	0
		9: USE_OV (Initial value = 0)	Override Selection 0: Invalid 1: Valid	0
		10/11: Reserved	-	-
		12: THROUMOD (Initial value = 0)	Servo Driver Transparent Command Mode 0: Invalid 1: Valid	0
13/14: Reserved	-	-		
15: SWGBVF (Initial value = 0)	Interpolation Command Segment Distributing Function 0: Valid 1: Invalid	0		

Table 5.7 Examples of Motion Fixed Parameter Settings (Cont'd)

No.	Name	Setting range/Bit name	Description	Setting (examples)
18	Number of Digits Below Decimal Point	0 to 5 (Initial value = 3)	Set the number of digits to the right of the decimal point of reference (Example) For the number of digits to the right of the decimal point = 3, mm : One reference unit = 0.001 mm deg : One reference unit = 0.001 deg inch : One reference unit = 0.001 inch This parameter and the reference unit selection (See the motion fixed parameter No.17.) gives the minimum reference unit. However, the minimum unit of "pulse" is not affected by this parameter.	3
19	Travel Distance per Machine Rotation (PITCH)	1 to $2^{31}-1$ (Initial value = 10000)	1=1 reference unit	10000
21	Servomotor Gear Ratio (GEAR MOTOR)	1 to 65535 (Initial value = 1)	1=1 rotation	1
22	Machine Gear Ratio (GEAR MACHINE)	1 to 65535 (Initial value = 1)	1=1 rotation	1
23	Infinite-length Axis Reset Position (POS MAX)	1 to $2^{31}-1$ (Initial value = 360000)	1=1 reference unit	360000
25	Maximum Number of Absolute Encoder Turns (MAXTURN)	1 to $2^{31}-1$ (Initial value = 99,999)	1=1 rotation	99999
27	Positive Software Limit (SLIMP)	-2^{31} to $2^{31}-1$ (Initial value = $2^{31}-1$)	1=1 reference unit	$2^{31}-1$
29	Negative Software Limit (SLIMN)	-2^{31} to $2^{31}-1$ (Initial value = -2^{31})	1=1 reference unit	-2^{31}
31	Zero Point Return Method (ZRETSEL)	0 to 3 (Initial value = 0)	0: DEC1 signal + C signal 1: ZERO signal 2: DEC1 signal (with switch width)+ZERO signal 3: C pulse	0
32	Reserved			

5.3.2 Examples of Motion Setting Parameter Settings

These are used for commanding the motion control module. At the beginning of high-speed scanning, they are transferred to the motion control module in a batch.

Motion control can be performed by simply setting the parameters in this register area.

Table 5.8 Examples of Motion Setting Parameter Settings

No.	Name	Register No.	Setting range/ Bit name	Description	Setting (examples)						
					Positioning	External positioning	Zero point return	Interpolation	Latch	Constant speed feed	Constant step feed
1	RUN Mode Settings (RUNMOD)	OW□□00				0104H					
		Bit	0	Reserved	Set "0."	0					
			1	Reserved	Set "0."	0					
			2	PCON (Initial value = 0)	Position Control Mode	1					
			3 to 5	Reserved	Set "0."	0					
			6	ACR (Initial value = 0)	Alarm Clear 1: Alarm clear inquiry	0					
			7	Reserved	Set "0."	0					
			8	MCDSEL (Initial value = 1)	0: Motion command code (OW□□20) invalid 1: Motion command code (OW□□20) valid * Be sure to set it to "1."	1					
			9	ZRNDIR (Initial value = 0)	Set "0."	0					
	10 to 15	Reserved	Set "0."	0							
2	RUN Command settings (SVRUNCMD)	OW□□01				0001H					
		Bit	0	RUN (Initial value = 0)	Servo ON (DO0)	1					
			1 to 11	Reserved	Set "0."	0					
			12	USE_BUF (Initial value = 0)	Position Reference Value Selection 0: Position reference value is OL□□12. 1: Position reference value is position buffer	0					
			13	SPDTYPE (Initial value = 0)	Speed Reference Value Selection 0: OL□□22 is valid for the rapid feed speed. 1: OW□□15 is valid for the rapid feed speed.	0					
			14	XREFTYPE (Initial value = 0)	Position Reference Type 0: Absolute position method for position reference (OL□□12). 1: Incremental addition method for position reference (OL□□12).	0					
15	Reserved	Set "0."	0								
3 6	Reserved	OW□□02 OW□□05	-	Set "0."	0						

Table 5.8 Examples of Motion Setting Parameter Settings (Cont'd)

No.	Name	Register No.	Setting range/ Bit name	Description	Setting (examples)						
					Positioning	External positioning	Zero point return	Interpolation	Latch	Constant speed feed	Constant step feed
7	Machine Coordinate System Zero Point Offset Setting (ABSOFF)	OL□□06	-2^{31} to $2^{31}-1$ (Initial value = 0)	1=1 reference unit (1=1 pulse for the pulse unit)	0						
9 12	Reserved	OW□□08 OW□□0B	—	Set "0."	0						
13	Linear Acceleration Time Constant (NACC)	OW□□0C	0 to 32767 (Initial value = 0)	1=1 ms (300 = 0.300 s)	500	500	500		500	500	
14 16	Reserved	OW□□0D OW□□0F	—	Set "0."	0						
17	Position Loop Gain Setting (Kp)	OW□□10	0 to 32767 (Initial value = 300)	1=0.1 /s (300 = 30.0)	300						
18	Feed Forward Gain Setting (Kf)	OW□□11	0 to 200 (Initial value = 0)	1=1% (10 = 10%)	0						
19	Position Reference Setting (XREF) or Position Buffer Number	OL□□12	-2^{31} to $2^{31}-1$ (Initial value = 0)	1=1 reference unit (1=1 pulse for the pulse unit) * For position reference value selection (OB□□01C) = 1, the position buffer No. (1 to 256).	1000	1000		20	20		
21	Filter Time Constant Setting (NNUM)	OW□□14 (Initial value = 0)	0 to 5100	(1) For Bit 4 to 7 of OW□□21 equal to "2," the S-curve (Movement Averaging) time constant 1=100 us	0						
0 to 65535			(2) For Bit 4 to 7 of OW□□21 equal to "1," the exponential acceleration/deceleration time constant 1=1 ms								
22	Speed Reference Setting (NREF)	OW□□15	0 to 32767 (Initial value = 0)	Valid when the speed reference value selection (OW□□01D) = 1. 1=0.01% (5000 = 50.00%)	0						
23 29	Reserved	OW□□16 OW□□1C	—	Set "0."	0						
30	Speed Loop Gain Setting (Ku)	OW□□1D	1 to 20000 (Initial value = 400)	1=0.1Hz (400 = 40.0Hz)	400						
31	Reserved	OL□□1E	—	Set "0."	0						

Table 5.8 Examples of Motion Setting Parameter Settings (Cont'd)

No.	Name	Register No.	Setting range/ Bit name	Description	Setting (examples)							
					Positioning	External positioning	Zero point return	Interpolation	Latch	Constant speed feed	Constant step feed	
33	Motion Command Code (MCMDCODE)	OW□□20	0 to 65535 (Initial value = 0)	0: NOP No reference available	1	2	3	4	6	7	8	
				1: POSING Positioning								
				2: EX_POSING External positioning								
				3: ZRET Zero point return								
				4: INTERPOLATE Interpolation								
				5: ENDOF_INTERPOLATE Final Interpolation segment (For motion functions)								
				6: LATCH Interpolation with position detection								
				7: FEED Constant speed feed								
				8: STEP Constant step feed								
				9: ZSET Zero point setting								
				10: ACC Changing the linear acceleration/deceleration time constant								
				11: Reserved								
				12: SCC Changing the movement averaging time constant								
				13: CHG_FILTER Changing the filter type								
				14: KVS Changing the speed loop gain (Kv)								
				15: KPS Changing the position loop gain (Kp)								
				16: KFS Changing the feed forward (Kf)								
				17: CN_RD Reading the servo driver Cn constant								
				18: CN_WR Writing the servo driver Cn constant								
				19: ALM_MON Servo driver current alarm monitor								
				20: ALMHIST_MON Servo driver alarm history monitor								
				21: ALMHIST_CLR Servo driver alarm history clear								
22 to 65535: Reserved												

Table 5.8 Examples of Motion Setting Parameter Settings (Cont'd)

No.	Name	Register No.	Setting range/ Bit name	Description	Setting (examples)						
					Positioning	External positioning	Zero point return	Interpolation	Latch	Constant speed feed	
34	Motion Command Control Flags (MCMDCTRL)	OW□□21				0000H					
		Bit	0	HOLD (Initial value = 0)	Command Hold	0					
			1	ABORT (Initial value = 0)	Command Abort	0					
			2	DIRECTION (Initial value = 0)	Direction of Movement 0: Forward 1: Reverse	0					
			3	P_PI (Initial value = 0)	Speed Loop P/PI Switch	0					
			4 to 7	FITERTYPE (Initial value = 0)	Filter Type Selection 0: No filter available 1: Exponential filter (Exponential acceleration/deceleration) 2: Movement averaging filter (Simple S-curve acceleration/deceleration)	0					
			8 to 13	Reserved	Set "0."	0					
			14	BUF_W (Initial value = 0)	Position Buffer Write 0: No processing 1: Write	0					
	15	BUF_R (Initial value = 0)	Position Buffer Read 0: No processing 1: Read	0							
35	Rapid Feed Speed (RV)	OL□□22	0 to 2 ³¹ -1 (Initial value = 0)	1=10 ⁿ reference unit/min (n: the number of decimal places) For units of pulse : 1=1000 pulse/min For units of mm : 1=1 mm/min For units of deg : 1=1 deg/min For units of inch : 1=1 inch/min							
37	External Positioning Travel Distance (EXMDST)	OL□□24	-2 ³¹ to 2 ³¹ -1 (Initial value = 0)	The unit is in accordance with that of the SERVOPACK. Refer to the Σ Series SGM□/SGD-□N User's Manual (SIE-S800-26.2).							
39	Stopping Distance (STOPDIST)	OL□□26	-2 ³¹ to 2 ³¹ -1 (Initial value = 0)	1=1 reference unit Leave the initial value.	0						
41	STEP Travel Distance (STEP)	OL□□28	0 to 2 ³¹ -1 (Initial value = 0)	1=1 reference unit							
43	Reserved	OL□□2A	-	Set "0."	0						
45	Override (OV)	OW□□2C	0 to 32767 (Initial value = 10000 = 100%)	1=0.01%							

Table 5.8 Examples of Motion Setting Parameter Settings (Cont'd)

No.	Name	Register No.	Setting range/ Bit name	Description	Setting (examples)						
					Positioning	External positioning	Zero point return	Interpolation	Latch	Constant speed feed	Constant step feed
46	Position Control Flags (POSCTRL)	OW□□2D				0000H					
		Bit	0	MLK (Initial value = 0)	Machine Lock Mode Setting 0: OFF 1: ON	0					
			1	TPRSREQ (Initial value = 0)	Request for Preset Number of POSMAX Turns 1: Demand ON	0					
			2	ABSLDREQ (Initial value = 0)	ABS System Infinite-length Position Control Data Load Request 1: Demand ON	0					
			3 to 11	Reserved	Set "0."	0					
		12 to 15	USRMONSEL Servo Driver User Monitoring Information Selection	Refer to the Σ Series SGM□/SGD-□N User's Manual (SIE-S800-26.2).	0						
47	Workpiece Coordinate System Offset (OFFSET)	OL□□2E	-2^{31} to $2^{31}-1$ (Initial value = 0)	1=1 reference unit Leave the initial value.	0						
49	Preset Number of POSMAX Turns Data (TURNPRS)	OL□□30	-2^{31} to $2^{31}-1$ (Initial value = 0)	1=1 rotation	0						
51	Second In-position Width (INPWIDTH)	OW□□32	0 to 65535 (Initial value = 0)	1=1 reference unit (For units of pulse : 1=1 pulse)	0						
52	Zero Point Position Output Width (PSETWIDETH)	OW□□33	0 to 65535 (Initial value = 10)	1=1 reference unit	10						
53	Positioning Completion Check Time (PSETTIME)	OW□□34	0 to 65535 (Initial value = 0)	1=1 ms	0						
54	Servo driver Cn Constant No. (Cn_No)	OW□□35 (Initial value = 0)	Bit0 to 11: Cn constant No. 1 to 4095 Bit12 to 15: Number of words 1 to 2	Refer to the Σ Series SGM□/SGD-□N User's Manual (SIE-S800-26.2).	0						
	0 to 9		Refer to the Σ Series SGM□/SGD-□N User's Manual (SIE-S800-26.2).								
	0 to 9		Refer to the Σ Series SGM□/SGD-□N User's Manual (SIE-S800-26.2).								
55	Cn Constant Change Data (Cn DAT)	OL□□36	-2^{31} to $2^{31}-1$ (Initial value = 0)	Refer to the Σ Series SGM□/SGD-□N User's Manual (SIE-S800-26.2).	0						

Table 5.8 Examples of Motion Setting Parameter Settings (Cont'd)

No.	Name	Register No.	Setting range/ Bit name	Description	Setting (examples)					
					Positioning	External positioning	Zero point return	Interpolation	Latch	Constant speed feed
57	Lower-place Two Words of Encoder Position at Shutdown	OL□□38 (Initial value = 0)	-2^{31} to $2^{31}-1$ (Initial value = 0)	Setting data at the ABS system infinite-length position control data load request (1=1 pulse)	0					
	Position Buffer Access No.		1 to 256 (Initial value = 0)	Position buffer access No. when OB□□21E = 1 or OB□□21F = 1	0					
59	Upper-place Two Words of Encoder Position at Shutdown	OL□□3A (Initial value = 0)	-2^{31} to $2^{31}-1$	Setting data at the ABS system infinite-length position control data load request (1=1 pulse)	0					
	Position Buffer Write Data		-2^{31} to $2^{31}-1$	Position buffer write data when OB□□21F = 1	0					
61	Lower-place Two Words of Pulse Position at Shutdown	OL□□3C (Initial value = 0)	-2^{31} to $2^{31}-1$	Setting data at the ABS system infinite-length position control data load request (1=1 pulse)	0					
63	Upper-place Two Words of Pulse Position at Shutdown	OL□□3E (Initial value = 0)	-2^{31} to $2^{31}-1$	Setting data at the ABS system infinite-length position control data load request (1=1 pulse)	0					

- (Note) 1. The above are settings of examples. Set appropriate values that suit your machine.
 2. The diagonally lined boxes show areas not used in motion function. Set corresponding initial values.

5.4 User Constants of MECHATROLINK Servo SGD-□□□N

◆ List of user constants

No.	Name	Size	Unit	Range	Initial value
Cn-0001	Memory switch 1	2	Bit	—	0380H
Cn-0002	Memory switch 2	2	Bit	—	0000H
Cn-0003	Load inertia	2	%	0 to 65535	100
Cn-0004	Speed loop gain	2	0.1Hz	1 to 20000	400
Cn-0005	Speed loop integration time constant	2	0.01 ms	100 to 65535	2000
Cn-0006	Emergency stop torque	2	%	0 to MAX	MAX
Cn-0007	Positioning proximity detection width	2	reference unit	0 to 10000	10
Cn-0008	Positive torque limit	2	%	0 to MAX	MAX
Cn-0009	Negative torque limit	2	%	0 to MAX	MAX
Cn-000A	System reserved	2	—	—	0
Cn-000B	System reserved	2	—	—	0000H
Cn-000C	Mode SW (torque reference)	2	%	0 to 32767	200
Cn-000D	Mode SW (speed reference)	2	r/min	0 to 32767	0
Cn-000E	Mode SW (acceleration)	2	0.167 r/s ²	0 to 3000	0
Cn-000F	Mode SW (error pulse)	2	pulse	0 to 10000	0
Cn-0010	System reserved	2	—	—	0000H
Cn-0011	Number of encoder pulses	2	P/R	513 to 32767	2048
Cn-0012	Brake timing for servomotor stop (delay time from the reference to SVOFF)	2	10 ms	0 to 50	0
Cn-0013	Memory switch 3	2	Bit	—	0000H
Cn-0014	Memory switch 4	2	Bit	—	0000H
Cn-0015	Brake timing with servomotor running (reference output speed)	2	r/min	0 to MAX	100
Cn-0016	Brake timing with servomotor running (waiting time from SVOFF to reference)	2	10 ms	10 to 100	50
Cn-0017	Torque reference filter time constant	2	μs	0 to 25000	400
Cn-0018	Torque reference filter time constant (secondary)	2	μs	0 to 25000	0
Cn-0019	System reserved	2	—	—	0000H
Cn-001A	Position loop gain	2	0.01 /s	1 to 50000	4000
Cn-001B	Positioning completion width	2	reference unit	0 to 250	7
Cn-001C	Bias	2	100 reference unit/s	0 to MAX	0
Cn-001D	Feed forward gain	2	%	0 to 100	0
Cn-001E	Position error overflow range	2	reference unit	1 to 65535	65535
Cn-001F	First level linear acceleration/deceleration time constant	2	1000 reference unit/s ²	0 to 65535	0

◆ List of user constants (Cont'd)

No.	Name	Size	Unit	Range	Initial value
Cn-0020	Second level linear acceleration/deceleration time constant	2	1000 reference unit/s ²	0 to 65535	100
Cn-0021	Acceleration/deceleration constant changeover speed	2	100 reference unit/s	0 to 65535	0
Cn-0022	Zero point return approach speed 1	2	100 reference unit/s	0 to 65535	50
Cn-0023	Zero point return approach speed 2	2	100 reference unit/s	0 to 65535	5
Cn-0024	Electronic gear B (numerator)	2	—	1 to 32768	4
Cn-0025	Electronic gear A (denominator)	2	—	1 to 32768	1
Cn-0026	Average move time	2	100 μ s	0 to 5100	0
Cn-0027	Feed forward reference filter	2	μ s	0 to 64000	0
Cn-0028	Final travel distance for zero point return	4	reference unit	-2147483648 to 2147483647	1000
Cn-002A	Zero point position range	2	reference unit	0 to 65535	10
Cn-002B	Final travel distance to external positioning	4	reference unit	-2147483648 to 2147483647	100
Cn-002D	Exponential acceleration speed bias	2	reference unit/s	0 to 32767	0
Cn-002E	Exponential acceleration time constant	2	100 μ s	0 to 5100	0
Cn-002F	Positive software limit	4	reference unit	-2147483648 to 2147483647	8192 \times 99999
Cn-0031	Negative software limit	4	reference unit	-2147483648 to 2147483647	-8192 \times 99999
Cn-0033	Absolute encoder zero point position offset	4	reference unit	-2147483648 to 2147483647	0
Cn-0035	Speed loop compensation constant	2	—	—	0000H
Cn-0036	System reserved	2	—	—	0000H
Cn-0037	Motor selection	2	—	—	0000H
Cn-0038	PG power supply voltage change	2	—	52000 to 58000	52500
Cn-0039	System reserved	2	—	—	0000H
Cn-003A	System reserved	2	—	—	0000H
Cn-003B	System reserved	2	—	—	0000H
Cn-003C	System reserved	2	—	—	0000H
Cn-003D	System reserved	2	—	—	0000H
Cn-003E	System reserved	2	—	—	0000H
Cn-003F	System reserved	2	—	—	0000H

IMPORTANT

1. The maximum values shown in the tables differ according to the SERVOPACK capacity. Refer to the relevant SERVOPACK manuals for details on user constants.
2. Cn-35, Cn-37, and Cn-38 can be set only for SGDB-□N SERVOPACKs. They are not displayed on the parameter window for SGD-□□□N SERVOPACKs.
3. The user constants reserved by the system are not displayed on the parameter window.

◆ **Details of the memory switch bits**

The details of each memory switch bit (bit type user constants) out of the SERVOPACK user constants are as follows:

1. Cn-0001: Memory switch 1

Cn-0001: The details of the memory switch 1 bits are given below.

Bit	Name	Description	Initial value
0	SV_ON mask	0: SV_ON/SV_OFF valid 1: Always SV_ON	0
1	SENS_ON mask	0: SENS_ON/SENS_OFF valid 1: Always SENS_ON	0
2	P-OT mask	0: P-OT signal valid 1: P-OT signal masked (always invalid)	0
3	N-OT mask	0: N-OT signal valid 1: N-OT signal masked (always invalid)	0
4	—	—	0
5	Power outage mask	0: Servo alarm after recovery from power outage 1: Power outage masked (no servo alarm with power outage recovery)	0
6	Base block power outage prevention method	0: Dynamic brake (DB) stop 1: Free-run stop	0
7	Status after DB stop	0: Releasing DB 1: Not releasing DB	1
8	Operation with OT stop	0: The stopping method is in accordance with the bit 6 setting. 1: The operation is decelerated to stop at the emergency stop torque.	1
9	Operation after deceleration to stop at OT emergency stop torque	0: Servo OFF after deceleration to stop 1: Zero clamp after deceleration to stop	1
A	Position error with servo OFF	0: Clearing the position error 1: Holding the position error	0
B	Mode switch function	0: Mode switch function available (in accordance with bits C and D) 1: Mode switch function not available	0
C	Mode switch selection	00: Mode switch selection (internal torque reference) 01: Unused (Do not set.)	0
D		10: Mode switch selection (acceleration) 11: Mode switch selection (error pulse)	0
E	Encoder selection	0: Incremental encoder 1: Absolute encoder	0
F	—	—	0

Note

Never change the initial value of the bit named "—."

2. Cn-0002: Memory switch 2

Cn-0002: The details of the memory switch 2 bits are given below.

Bit	Name	Description	Initial value
0	Reverse rotation mode	0: Normal rotation is in the CCW direction. 1: Normal rotation is in the CW direction.	0
1	Zero point error detection mask	0: Zero point error detection is performed (only when the absolute encoder is used). 1: Zero point error detection is masked (not performed).	0
2	—	—	0
3	—	—	0
4	—	—	0
5	—	—	0
6	Software limit check by reference target	0: Check is not performed. 1: Check is performed.	0
7	—	—	0
8	Servomotor selection	0: SGM 1: SGMP	0
9	—	—	0
A	—	—	0
B	—	—	0
C	—	—	0
D	—	—	0
E	—	—	0
F	—	—	0

Note

Never change the initial value of the bit named "—."

3. Cn-0003: Memory switch 3

Cn-0003: The details of the memory switch 3 bits are given below.

Bit	Name	Description	Initial value
0	—	—	0
1	—	—	0
2	—	—	0
3	—	—	0
4	—	—	0
5	—	—	0
6	—	—	0
7	—	—	0
8	—	—	0
9	—	—	0
A	System use*	—	0
B	System use*	—	0
C	—	—	0
D	—	—	0
E	—	—	—
F	—	—	—

* For details, refer to 7.3.3 in the Σ Series SGM□/SGD-□N User's Manual (SIE-S800-26.2).

||
Note

Never change the initial value of the bit named "—."

4. Cn-0004: Memory switch 4

Cn-0004: The details of the memory switch 4 bits are given below.

Bit	Name	Description	Initial value
0	—	—	0
1	Zero point return direction	0: Direction of forward rotation 1: Direction of reverse rotation	0
2	P-SOT mask	0: P-SOT valid 1: P-SOT invalid	0
3	N-SOT mask	0: N-SOT valid 1: N-SOT invalid	0
4	—	—	0
5	—	—	0
6	—	—	0
7	—	—	0
8	—	—	0
9	Brake operation	0: Operation at the command BRK_ON/BRK_OFF 1: Operation by the SERVOPACK (BRK_ON/BRK_OFF invalid)	0
A	P-OT signal	0: Positive logic 1: Negative logic	0
B	N-OT signal	0: Positive logic 1: Negative logic	0
C	DEC signal	0: Positive logic 1: Negative logic	0
D	—	—	0
E	—	—	0
F	—	—	0

* For details, refer to 7.3.3 in the Σ Series SGM□/SGD-□N User's Manual (SIE-S800-26.2).

Note

- (1) Never change the initial value of the bit named "—."
- (2) Set both bit 2 and bit 3 of the user constant "Cn-0004" of the SERVOPACK to "1" to invalidate P-SOT and N-SOT.

5. Cn-37: Cn-0037: Motor selection

Group	SERVOPACK	Motor	Motor No. (Cn-0037 Setting)
05	SGDB-05AN	SGMG-03A□B	171
		SGMG-05A□A	142
		SGMP-04A	126
		SGM-04A	106
10	SGDB-10AN	SGMG-06A□B	172
		SGMG-09A□A	143
		SGMG-09A□B	173
		SGMS-10A□A	163
		SGMP-08A	127
		SGM-08A	107
15	SGDB-15AN	SGMG-13A□A	144
		SGMG-12A□B	174
		SGMS-15A□A	164
		SGMP-15A	128
20	SGDB-20AN	SGMG-20A□A	145
		SGMG-20A□B	175
		SGMS-20A□A	165
30	SGDB-30AN	SGMG-30A□A	146
		SGMG-30A□B	176
		SGMS-30A□A	166
		SGMS-22A□A	155
50	SGDB-50AN	SGMG-44A□A	147
		SGMG-44A□B	177
		SGMS-40A□A	167
		SGMD-32A□A	156
		SGMS-50A□A	168
		SGMD-40A□A	157
60	SGDB-60AN	SGMG-55A□A	148
		SGMG-60A□B	178
75	SGDB-75AN	SGMG-75A□A	149
1A	SGDB-1AAN	SGMG-1AA□A	140
1E	SGDB-1EAN	SGMG-1EA□A	150

The motor to be used can be changed using the Cn-0037 user constant if it belongs to the same group.

◆ **Relationship between the user constants of the SERVOPACK and SVB parameters**

Since some parameters of the SVB controller and user constants of the SERVOPACK have the same meaning, you must be careful in using them.

1. List of parameters that require attention

The parameters that have the same meaning and require attention at the time of use are listed below.

SVB	SERVOPACK
OW□□10: Position Loop Gain Setting	Cn-001A: Position loop gain
OW□□11: Feed Forward Gain Setting	Cn-001D: Feed forward gain
OW□□1D: Speed Loop Gain Setting	Cn-0004: Speed loop gain
OW□□0C: Linear Acceleration Time Constant	Cn-0020: Second level linear acceleration time constant
OW□□14: Filter Time Constant Setting	Cn-0026: Average move time Cn-002E: Exponential acceleration time constant
Fixed parameter 3: Encoder Selection	Cn-0001 bE: Encoder selection
Fixed parameter 8: Number of Feedback Pulses per Rotation	Cn-0011: Number of encoder pulses
Fixed parameter 21: Servomotor Gear Ratio	Cn-0024: Electronic gear ratio (numerator)
Fixed parameter 22: Machine Gear Ratio	Cn-0025: Electronic gear ratio (denominator)
Fixed parameter 17 b7: Positive Software Limit Selection	Cn-000B b2: P-SOT mask
Fixed parameter 17 b8: Negative Software Limit Selection	Cn-000B b3: N-SOT mask
Fixed parameter 27: Positive Software Limit	Cn-002F: Positive software limit
Fixed parameter 29: Negative Software Limit	Cn-0031: Negative software limit
OW□□33: Zero Point Position Output Width	Cn-002A: Zero point position range

2. Parameters that can be rewritten by the SVB motion command code

The parameters whose setting values on the SVB side can be written in the SERVOPACK side by using the motion command code are as follows:

Parameter name	SVB	SERVOPACK
Second Level Linear Acceleration/deceleration Time Constant	OW□□0C	Cn-0020
Average Move Filter	OW□□14	Cn-0026
Exponential Acceleration Speed	OW□□14	Cn-002E
Speed Loop Gain Setting	OW□□1D	Cn-0004
Position Loop Gain Setting	OW□□10	Cn-001A
Feed Forward Gain	OW□□11	Cn-001D

To change the parameters, the procedure given below must be followed.

- An example of procedures for writing "Position loop gain" by motion program.

[Example]

Construct the following procedure by user program.

- ① Check that the motion command OW□□20 is "0" (NOP).
- ② Wait one scan.
- ③ Position loop gain: Store the setting value in OW□□10.
- ④ Set 15 (KPS command) to the motion command OW□□20.
- ⑤ Wait until the command response reaches 15 (KPS command).
- ⑥ Set "0" (NOP) to the motion command OW□□20.

3. Parameters that must coincide on the SVB side and on the SERVOPACK side

Motion control cannot be performed normally unless they coincide.

Parameter name	SVB	SERVOPACK
Encoder Selection	Fixed parameter 3	Cn-0001 bE
Number of Feedback Pulses per Rotation	Fixed parameter 8	Cn-0011

4. Parameters that must be used on either the SVB side or SERVOPACK side

Motion control cannot be performed normally if the parameters on both sides are used.

Parameter name	SVB	SERVOPACK
Electronic Gear Ratio (Numerator)	Fixed parameter 5 Fixed parameter 8 Fixed parameter 21	Cn-0024
Electronic Gear Ratio (Denominator)	Fixed parameter 19 Fixed parameter 22	Cn-0025

Note

Normally, do not use the gear ratio on the SERVOPACK side. Set "1" to Cn-0024 and Cn-0025 at the time of setup.

5. Parameters that are not used on the SERVOPACK side

Motion control cannot be performed normally if the parameters on both sides are used.

Parameter name	SVB	SERVOPACK
P-SOT Mask	Fixed parameter 17 b7	Cn-000B b2
N-SOT Mask	Fixed parameter 17 b8	Cn-000B b3
Positive Software Limit	Fixed parameter 27	Cn-002F
Negative Software Limit	Fixed parameter 29	Cn-0031

Note

Be sure to mask P-SOT and N-SOT on the SERVOPACK side. Set "1" to Cn-000B b2 and b3 at the time of setup.

6. Similar but different parameters

Parameter name	SERVOPACK
Zero Point Position Output Width: OW <input type="checkbox"/> <input type="checkbox"/> 33	Zero point position range: Cn-002A

As a parameter for zero point position output, that of SVB is used.

6 ABSOLUTE VALUE DETECTION

This chapter describes the absolute value detection system using an absolute encoder.

Be sure to read before using a motor equipped with an absolute encoder.

6.1 Mechanism of the absolute value detecting function

This section describes the absolute value detecting function equipped in SVB.

6.1.1 Outline of the function

The absolute value detection system is a function by which a machine coordinate system is automatically detected by detecting the machine position even with the power OFF so that automatic operation can be performed immediately after turning ON the power without performing zero point return.

The features of the absolute value detection system are as follows:

- The zero point return operation does not need to be performed after turning on the power.
- The stored stroke limit function is valid immediately after turning on the power.
- The zero point dog and overtravel limit switches are unnecessary.

For this function, one of the following three running systems can be selected by parameter setting.

- ① Running in the incremental detection system using an incremental encoder.
- ② Running in the absolute value detection system using an absolute encoder.
- ③ Running in the incremental detection system using an absolute encoder.

6.1.2 Mechanism of the absolute position detection

◆ Explanation of basic terms

As a grounding, basic terms that will be used in this chapter are explained below.

(1) Absolute encoder

The absolute position is detected on a semi-closed loop by using the absolute encoder mounted on the motor as a rule. The detector consists of an encoder to detect the absolute position within one rotation and a counter to count the number of rotations.

(2) Absolute value data

The absolute value data stored in the encoder consists of the number of rotations from the absolute reference position (P) and the position within one rotation of the motor (PO). When the power of the device is turned on, the absolute value data is read as serial data.

After that, movements are made in the same way as a normal incremental encoder.

◆ **Transition of the absolute value detection system**

The status transition chart of the absolute value detection system is shown below.

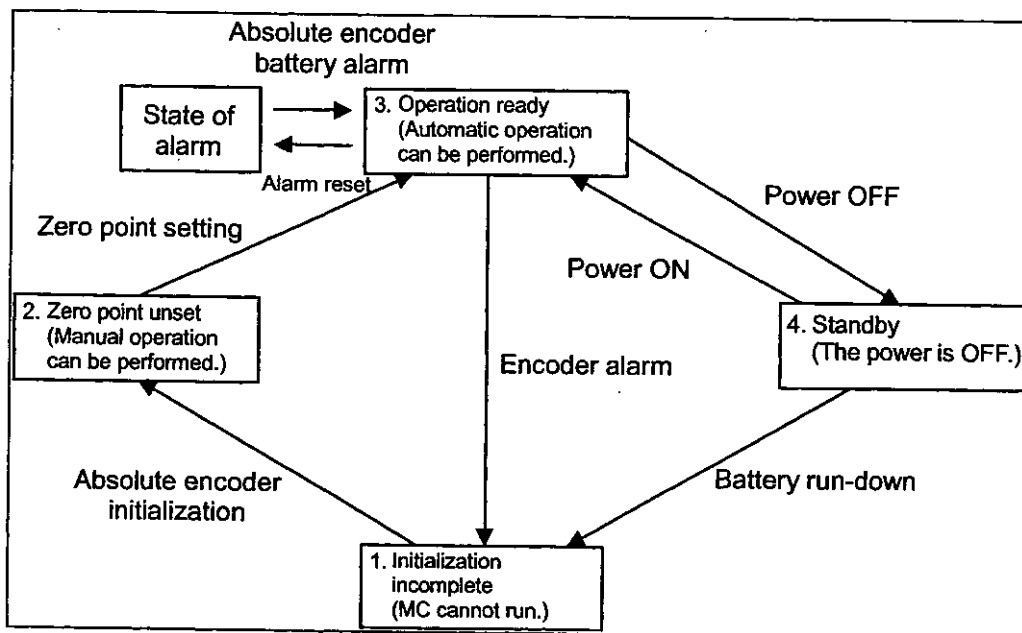

Fig. 6.1 Status Transition Chart of the Absolute Value Detection System

Each status is as follows:

① Initialization incomplete

In this state, the operation of the absolute encoder cannot be guaranteed.

This alarm is given when the backup power of the absolute encoder is totally discharged or when the absolute encoder is used for the first time. In this case, the absolute encoder must be initialized.

In this state, zero point setting cannot be executed.

② Zero point unset

In this state, zero point setting to determine the zero point on the machine coordinate system is undone. This alarm is given when the power of the system is turned on. In this case, reset the alarm and then execute zero point setting. Axial movements that can be made in the zero point unset condition are manual operations of JOG and STEP.

③ Operation ready

In this state, zero point setting is completed and the absolute value detecting function works so that normal operation can be performed.

④ Standby

In this state, machine movements are detected even with the power OFF. Data changes due to turn of the absolute encoder are updated.

At this time, the battery is the power source of the absolute encoder.

6.2 Start-up of the absolute value detecting function

This section describes the procedure for starting up the absolute value detection system.

6.2.1 Procedure for starting up the system

To start up the absolute value detection system, the peripheral equipment such as the SERVOPACK and servomotor must also be checked.

For starting up the absolute value detection system, the procedure given below must be followed.

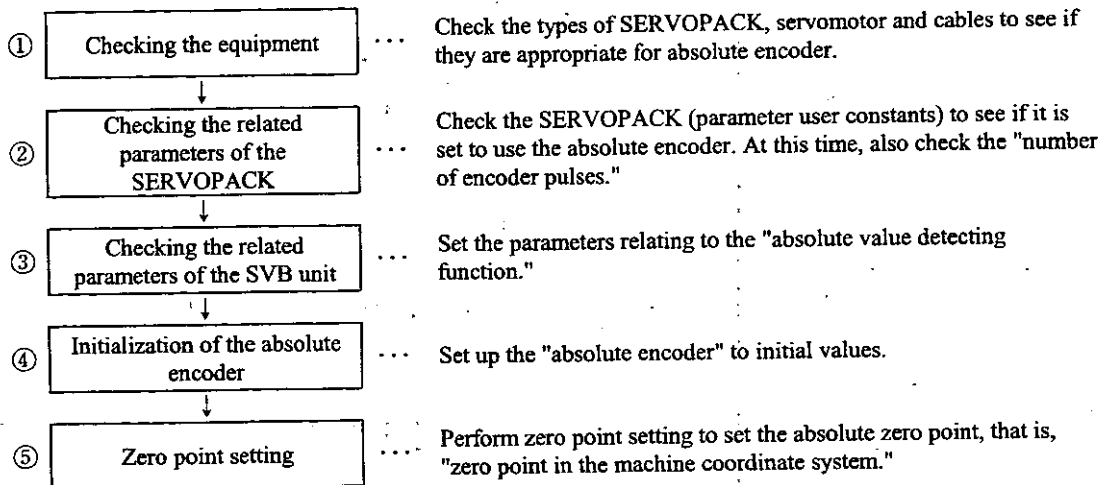

Correctly performing the operations from ① through ⑤ establishes the "operation ready" condition that the absolute value detection system works normally.

In the following cases, execute the procedure for starting up the absolute value detection system.

- ① When starting up the absolute value detection system for the first time.
- ② When the servomotor has been changed.
- ③ When an absolute value encoder-related alarm is given.

6.2.2 Setting the related parameters

Out of the various parameters of the SVB unit, the absolute value detection parameters are explained.

Prior to starting up the absolute value detection system, set the following related parameters.

Table 6.1 Parameters of the SVB Unit

Parameter No.	Name	Setting range	Unit	Initial value
Fixed parameter 3	Encoder Selection	0: Incremental encoder 1: Absolute encoder	—	0
Fixed parameter 8	Number of Feedback Pulses per Rotation	A multiple of 4 within the range between 4 and 65535	1=1 pulse	2048
Fixed parameter 17 b5:	Axis Selection	0: Finite-length axis 1: Infinite-length axis	—	0
Fixed parameter 23	Infinite-length Axis Reset Position	1 to $2^{31}-1$	1=1 reference unit	36000
Fixed parameter 25	Maximum Number of Absolute Encoder Turns	1 to $2^{31}-1$	1=1 rotation	9999
Setting parameter 7 (OL□□06)	Machine Coordinate System Zero Point Offset Setting	-2 to $2^{31}-1$	1=1 reference unit	0

Table 6.2 User Constants of the SERVOPACK

User constant	Name	Setting range	Unit	Initial value
Cn-0001bE	Encoder Selection	0: Incremental encoder 1: Absolute encoder	-	0
Cn-0011	Number of Encoder Pulses	513 to 32767	P/R	2048

(1) Setting of the encoder selection

On the axis to perform absolute value detection, set both fixed parameter 3 of the SVB unit and user constant Cn-0001 bE of the SERVOPACK to "absolute encoder."

The absolute value detection system can be set on each axis. Incremental position detection axes and absolute position detection axes can be mixed in the system.

(2) Setting of the number of encoder pulses

Set the number of pulses of the absolute encoder in use to fixed parameter 8 of the SVB unit and user constant Cn-0011 of the SERVOPACK.

- SVB fixed parameter 8
- SERVOPACK user constant Cn-0011

(Note) Be sure to set the same value to both.

(3) Axis selection

Set whether or not there are movement limits on the control axis.

(4) Infinite-length axis reset position

Set the cycle of the infinite-length axis in the reference unit. This parameter is valid when the absolute encoder is used and the infinite-length axis is selected.

(5) Maximum number of the absolute encoder turns

According to the difference in pulse terms between the value on the machine coordinate system stored upon power OFF and the value in the machine coordinate system at the next power ON, the "maximum number of the absolute encoder turns exceeded" error is given.

(6) Machine coordinate system zero point offset setting

This is a parameter to determine the zero point in the machine coordinate system. The meaning of this parameter differs according to the type of encoder in use and the finite-length/infinite-length axis selection.

Finite-length axis	INC axis	Parameter (OL□□06) ABSOFF is always valid.
	ABS axis	Parameter (OL□□06) ABSOFF is always valid.
Infinite-length axis	INC axis	Parameter (OL□□06) ABSOFF is always valid.
	ABS axis	Valid only during zero point setting (because it is used for definition of the "ABS system infinite-length position control data.")

1. On an ABS finite-length axis

The setting parameter (OL□□06) "Machine Coordinate System Zero Point Offset Setting" is always valid. By simply changing the "Setting of the position offset of the zero point," the zero point in the machine coordinate system can be changed. Therefore, zero point setting operation does not need to be performed on the ABS finite-length axis.

2. On an ABS infinite-length axis

The setting parameter (OL□□06) "Machine Coordinate System Zero Point Offset Setting" is valid only during zero point setting operation.

During zero point setting operation, the regularly electronic-gear converted value of the setting of the position offset of the zero point is taken as the current position in the machine coordinate system.

Set the desired position to the setting parameter (OL□□06) "Machine Coordinate System Zero Point Offset Setting."

6.2.3 Initialization of the absolute encoder

In the following cases, initialize the absolute encoder.

- ① When starting up the absolute value detection system for the first time.
- ② To initialize the number of rotations from the absolute reference position of the absolute encoder to "0."
- ③ When the motor is left for more than four days with the battery disconnected from the absolute encoder.
- ④ When an alarm occurs.

◆ Initialization of the absolute encoder (12-bit)

Initialize the absolute encoder (12-bit type) as follows:

- ① Regularly connect the SERVOPACK, servomotor and CP-9200SH.
- ② Reset the "absolute value data" in the encoder.
 - (a) Disconnect the connector on the encoder side.
 - (b) Short-circuit the connector pins (13) and (14) on the encoder side for one to two seconds.
 - (c) Remove the short-circuit lead, and securely reinsert the connector in position.

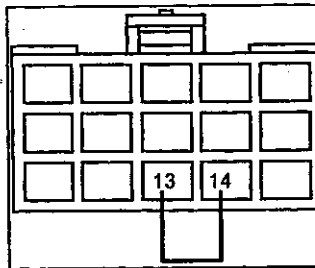

Fig. 6.2 Initialization of the Absolute Encoder

- ③ Put back the cables in the regular wiring, and connect the battery for the encoder.
- ④ Turn on the system power.

If the absolute encoder alarm is given, start again from operation ①. If no alarm is given, initialization of the absolute encoder is completed.

◆ **Initialization of the absolute encoder (15-bit)**

Initialize the absolute encoder (15-bit type) as follows:

- ① Turn off the power of the SERVOPACK and SVB.
- ② Discharge the large-capacity condenser in the encoder by one of the following methods.
 - A. By using the connector on the encoder side
 - (a) Disconnect the connector on the SERVOPACK side.
 - (b) Short-circuit the connector pins (10) and (13) on the encoder side.
 - (c) Leave the short circuit for two minutes or more.
 - (d) Remove the short-circuit lead, and securely reinsert the connector in position.
 - B. By using the connector on the SERVOPACK side
 - (a) Disconnect the connector on the encoder side.
 - (b) Short-circuit the connector pins (R) and (S) on the encoder side.
 - (c) Leave the short circuit for two minutes or more.
 - (d) Remove the short-circuit lead, and securely reinsert the connector in position.
- ③ Put back the cables in the regular wiring, and connect the battery for the encoder.
- ④ Turn ON the system power.

If the absolute encoder alarm is given, start again from operation ①. If no alarm is given, the initialization of the absolute encoder is completed.

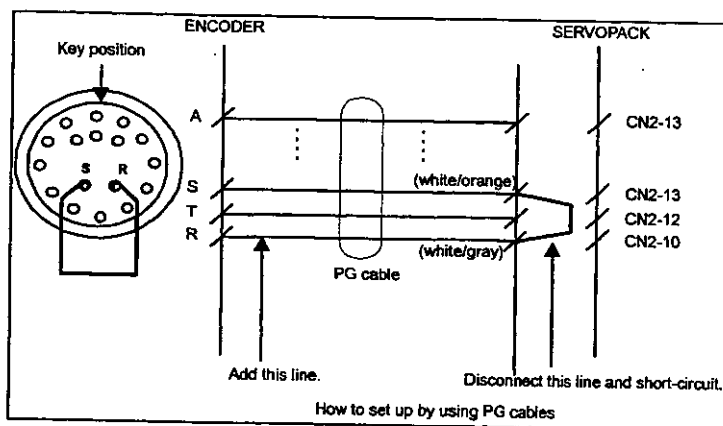
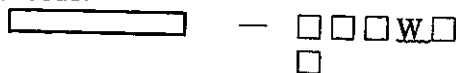

Fig. 6.3 Initialization of the Absolute Encoder

[Supplement]

■ The type of absolute encoder-equipped servomotor is as follows:

(1) 12-bit encoder



(2) 15-bit encoder

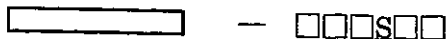

6.3 How to use the absolute encoder

This section describes the precautions for using the absolute encoder and how to set the zero point. Use the absolute encoder differs according to the finite-length/infinite-length axis selection.

6.3.1 Using on a finite-length axis

◆ Outline

The absolute encoder stores the amount of turn from the encoder zero point in the internal battery back-up memory. Due to this, the zero point on the coordinate system can be obtained without performing zero point return operation after starting up the system. After starting up the system, movements are made in the same way as an incremental encoder.

However, since the "amount of turn from the encoder zero point" is controlled only within the range of ± 99999 turns, if ± 99999 turns are exceeded, the amount of turn is reset to "0". If the power of the system is turned on again in this state, the position that is controlled by SV becomes different from that controlled before.

Use the absolute encoder within the range of ± 99999 turns on a finite-length axis, having movement limits.

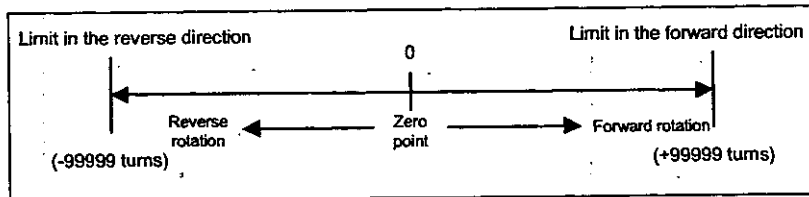

Fig. 6.4 Details of a Finite-Length Axis

Therefore, pay attention to the following points when using the absolute encoder on a finite-length axis.

- Be sure to initialize the encoder before zero point setting.
- For absolute encoder, use within the range of ± 99999 turns.

(Note) The conditions of the actual machine's movement range differ according to the parameters such as gear ratio.

◆ Position control when using on a finite-length axis

When using on a finite-length axis, initialize the position upon turning on the power as follows:

$$\text{Current position in machine coordinate system} = \frac{\text{Encoder position when the servo power is on} + \text{setting parameter (OL}\square\square 06) \text{ "Zero Point Position Offset"}}{*}$$

* Multi-turn data \times number of encoder pulses + initial incremental amount

On a finite-length axis, the setting parameter (OL $\square\square$ 06) "Zero point position offset" is always valid.

Therefore, the current position on the machine coordinate system can be changed (the zero point can be set) at any time.

The meaning of the setting parameter (OL $\square\square$ 06) differs according to the finite-length/infinite-length axis selection.

(1) Finite-length

By setting $-(IL□□02) + OL□□06$ to $OL□□06$, the current position on the machine coordinate system is set to "0".

[Example]

When $IL□□02=10000$, and $OL□□06 = 100$,

To set the current position in the machine coordinate system to "0" upon execution of "zero point setting":

$$-(10000) + 100 = -9900$$

Set -9900 to $OL□□06$.

$IL□□02$: Monitoring the calculated position on the machine coordinate system

(2) Infinite-length

By setting the desired position to $OL□□06$ and performing "zero point setting," the current position on the machine coordinate system is set at the set value.

[Example]

To set the current position in the machine coordinate system to "0" upon execution of "zero point setting":

Set "0" to $OL□□06$.

 **CAUTION**

Do not change the "Zero Point Position Offset ($OL□□06$)" while the machine is running on a finite-length axis.

Doing so may cause damage to the machine or an accident.

◆ Procedure for zero point setting on a finite-length axis

By performing "zero point setting" after the initialization of the absolute encoder, the zero point in the machine coordinate system is set and a machine coordinate system is created.

Procedure for "zero point setting" on a finite-length axis is shown below.

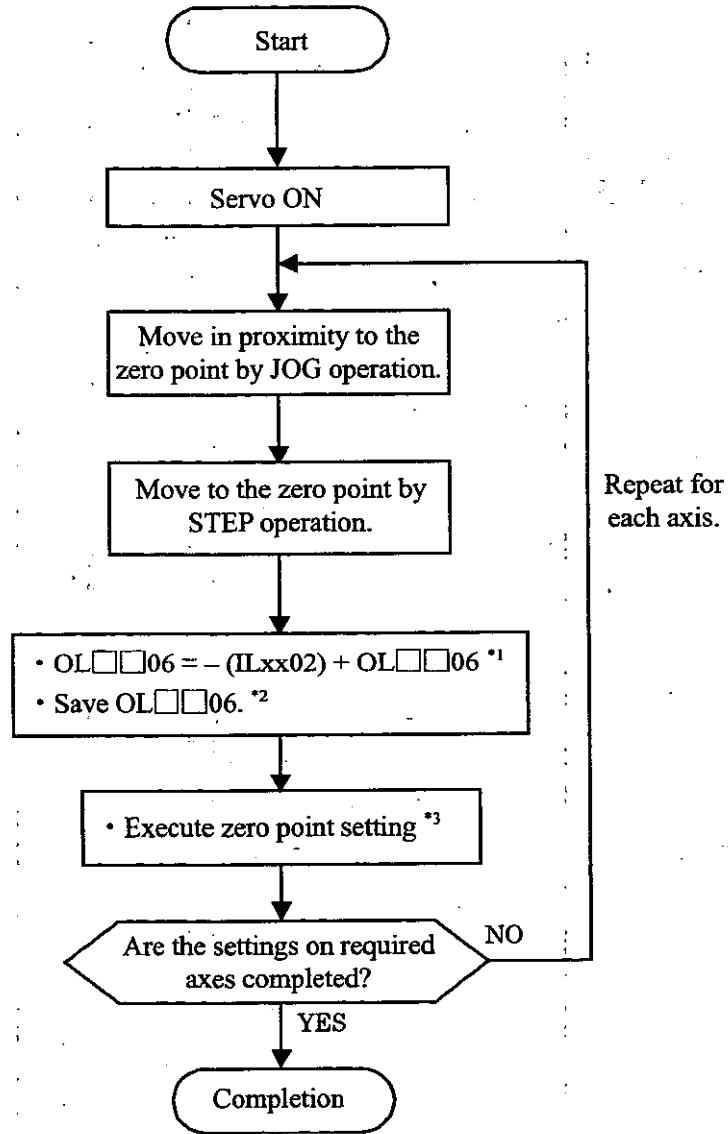

Fig. 6.5 Procedure for Zero Point Setting on a Finite-Length Axis

- *1. The value of OL□□06 must be saved at the same time as it is set.
- *2. For saving OL□□06, refer to the "Supplement" shown below.
- *3. Execute by the "ZSET" command.

[Supplement]

■ There are two methods of saving the "Zero Point Position Offset (OL□□06)" as follows:

(1) Saving in the M register by ladder program

Calculate [- (monitoring the calculated position on the machine coordinate system) + setting of the position offset of the zero point], store it in OL□□06 and save it in the M register at the same time.

Upon turning on the power again or turning on the servo power, store the data saved in the M register in the setting parameter (OL□□06) "Zero Point Position Offset."

< Ladder program required for a finite-length axis ABS system finite-length axis (axis 1) >

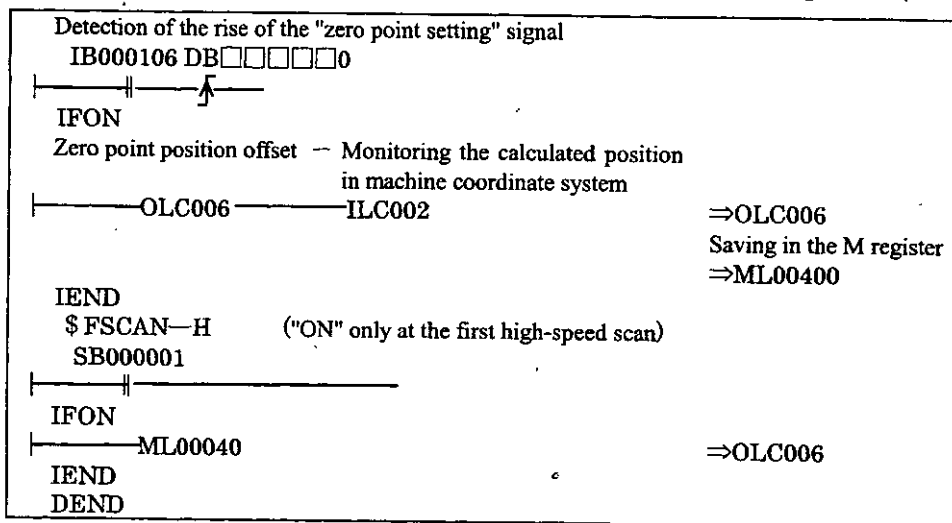

Fig. 6.6 An Example of Zero Point Setting Offset

(2) Saving the setting value of the "Zero Point Position Offset (OL□□06)" on the parameter window of CP-717

By setting the value (current value) of the "Zero Point Position Offset (OL□□06)" after execution of "zero point setting" as a setting value and saving it, the set value is saved in the controller. Upon turning ON the power again, the saved value of the "Zero Point Position Offset (OL□□06)" is automatically stored.

6.3.2 When using on an infinite-length axis

◆ Outline

Infinite-length positioning is a function of automatically updating the machine position, program position (absolute value on the program coordinate system) and the current value at regular intervals according to the values of the fixed parameters. By the infinite-length axis positioning function, repeated positioning in the same direction can be performed.

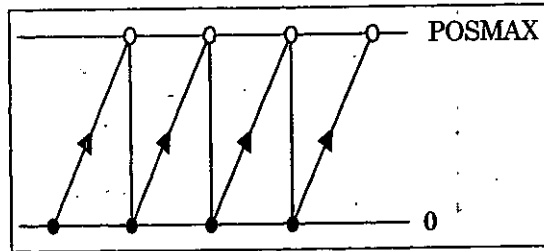

Fig. 6.7 Amount of Turn from the Encoder Zero Point

By setting Bit 5 "Finite-length/infinite-length Axis Selection" of fixed parameter No. 17=infinite-length axis, the following position information is automatically updated in the cycle set by fixed parameter No. 23 "Infinite-length axis reset position (POS MAX)."

Parameter No.	Name
IL□□02	Calculated position in machine coordinate system (CPOS)
IL□□06	Latch position in machine coordinate system (LPOS)
IL□□08	Feedback position in machine coordinate system (APOS)
IL□□18	Machine coordinate reference position (MPOS)

However, since the "amount of turn from the encoder zero point" is controlled only within a range of ± 99999 turns, the absolute encoder as it is cannot be applied to the infinite-length axis as described above.

This problem can be solved by the following method.

◆ Position control when using on an infinite-length axis

Upon turning ON the power of the system again, obtain the pulse position from the relative encoder position by the following expression, using the positions that are controlled by SVB.

To begin with, always save the "pulse position" and "encoder position" in the battery back-up memory as a pair of information pieces. Using the information as "Pulse position at shutdown" and "Encoder position at shutdown," respectively, at the next power ON, obtain the pulse position from the relative encoder position by the following expression.

$$\text{Pulse position} = \text{pulse position at shutdown} + \frac{(\text{encoder position} - \text{encoder position at shutdown})}{*}$$

* This means the amount of movement while the power is OFF (relative encoder position).

【Supplement】

■ The meanings of the terms in use are as follows:

· Encoder position: position information of the absolute encoder

(Multi-turn data × number of encoder pulses + initial incremental pulse)

· Pulse position: position information that is controlled by SVB, which is converted in pulses

■ Only 12-bit type absolute encoders can be used on infinite-length axes. If a 15-bit type is set, the "fixed parameter setting error" is given.

◆ Procedure for zero point setting on an infinite-length axis

Execute the motion command "ZSET" (zero point setting).

The system fixes "Pulse position at shutdown," "Encoder position at shutdown" and all other position information by zero point setting operation.

Procedure for "zero point setting" on an infinite-length axis is shown below.

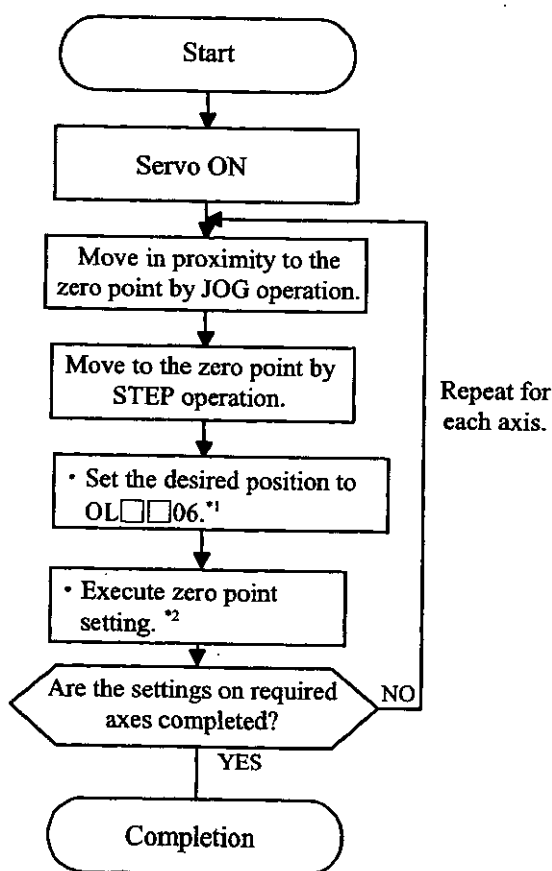

Fig. 6.8 Procedure for Zero Point Setting on an Infinite-Length Axis

*1. On an infinite-length axis, the setting parameter "Zero Point Position Offset (OL□□06)" is valid only when the "ZSET" command is executed.

Therefore, it is not necessary to save OL□□06 in the M register.

On an infinite-length axis, set the desired coordinate value to the "Point Position Offset (OL□□06)."

(Example) To set the currently stopped position to the zero point "0" in the machine coordinate system:

0	→	OL □ □
06		

*2. Execute by the "ZSET" command.

◆ **Creating a ladder program for infinite-length axis position control**

For using the absolute encoder on an infinite-length axis, a special ladder program is required for absolute infinite-length position control upon normal running and turning ON the system power again.

(1) Normal running

① Checking the zero point setting completion status

Check that the monitor parameter "Zero Point Setting Completion (Bit 3 of IW□□15)" is ON. If ON, perform operation ②.

If OFF, "Pulse position at shutdown," "Encoder position at shutdown" and all other position information are not fixed. In this case, execute the "operation to be performed upon turning ON the system power again" to set up the position information again, or execute the motion command "ZSET" (zero point setting) to newly fix the position data.

② Saving "Pulse position at shutdown" and "Encoder position at shutdown"

Save the following monitor parameters in the battery back-up M register at high-speed scanning timing by your ladder program.

Monitor parameter "Encoder position at shutdown" (all 4 words of IL□□38 and IL□□3A)
Monitor parameter "Pulse position at shutdown" (all 4 words of IL□□3C and IL□□3E)

The M register in which the above monitor parameters should be saved must have the following configuration.

MW□□□□□	Bit0	Toggle buffer validity flag (0=invalid, 1=valid)	
	Bit1	Toggle buffer selection flag (0=buffer 0, 1=buffer 1)	
	Bit2	Position information re-setup request flag (0=completion, 1=request)	
MW□□□□□+1	Unused		
ML□□□□□+2	Buffer 0	Monitor parameter "Encoder position at shutdown"	Lower-place 2 words (IL□□38)
ML□□□□□+4			Upper-place 2 words (IL□□3A)
ML□□□□□+6		Monitor parameter "Pulse position at shutdown"	Lower-place 2 words (IL□□3C)
ML□□□□□+8			Upper-place 2 words (IL□□3E)
ML□□□□□+10	Buffer 1	Monitor parameter "Encoder position at shutdown"	Lower-place 2 words (IL□□38)
ML□□□□□+12			Upper-place 2 words (IL□□3A)
ML□□□□□+14		Monitor parameter "Pulse position at shutdown"	Lower-place 2 words (IL□□3C)
ML□□□□□+16			Upper-place 2 words (IL□□3E)

(Note) Two buffers are required to save "Encoder position at shutdown" and "Pulse position at shutdown" because the 4 word position data may not be fixed before ending if the power is cut off during execution of high-speed scanning.

Store the values in the buffers in accordance with the following flow.

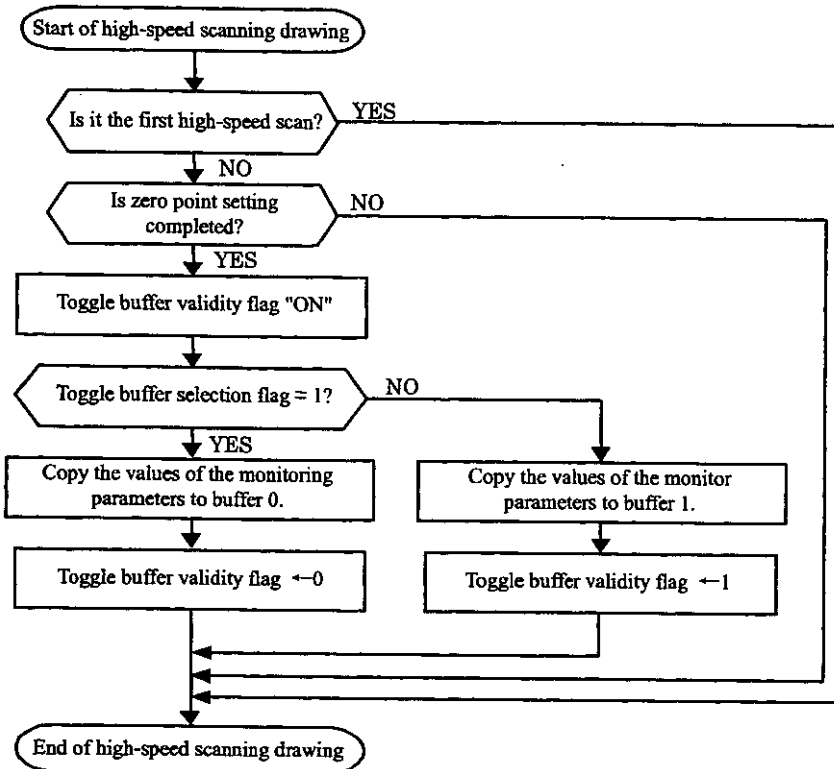

Fig. 6.9 Procedure for Storing the Values in the Buffers (Flow Chart)

An example of programming the flow in Fig. 6.9 (ladder program) is shown in Fig. 6.10.

The first axis of module No. 1 is used. If the module No. and/or the axis No. is different, rewrite the motion parameter register No.

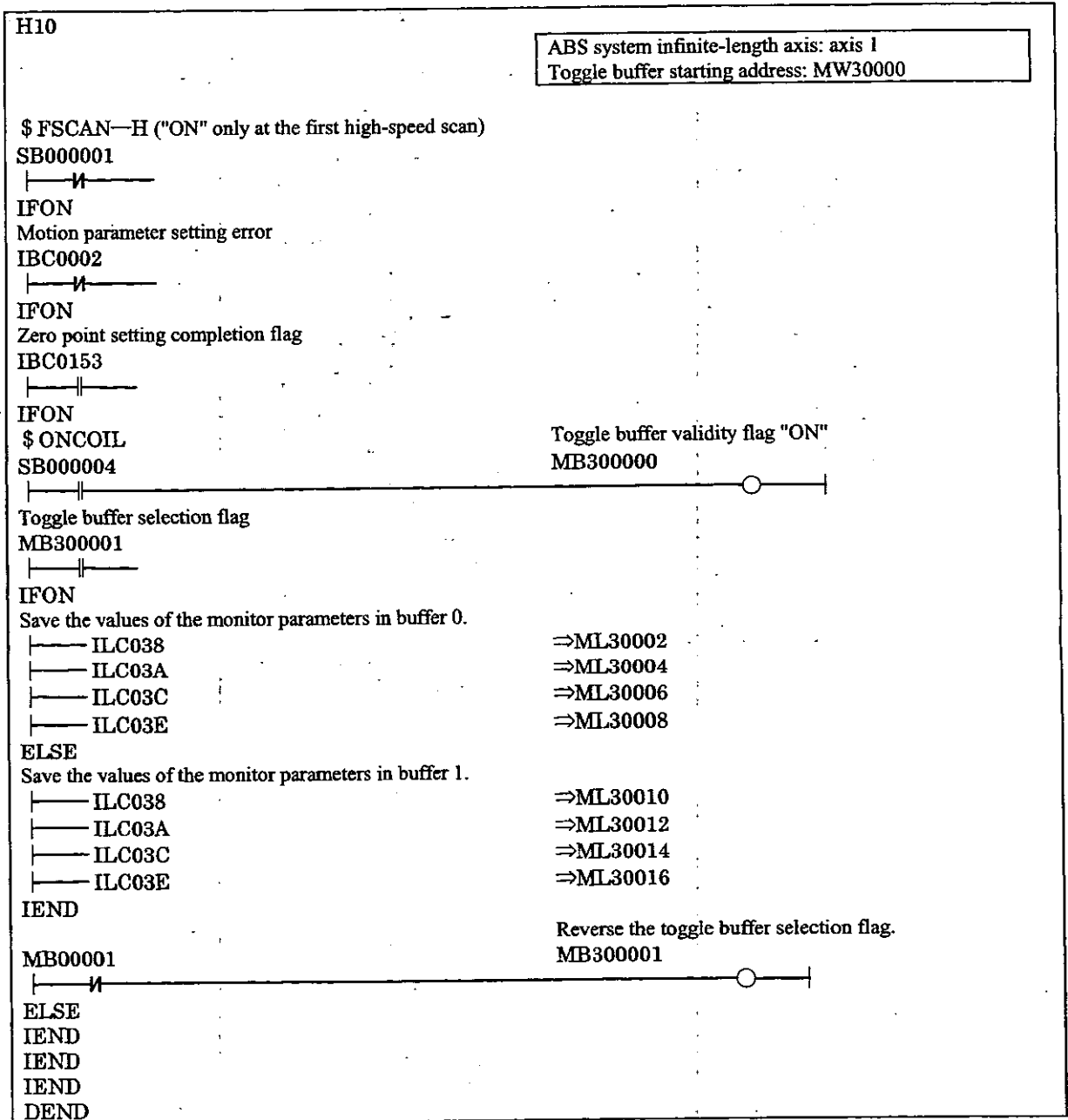

Fig. 6.10 Procedure for Storing the Values in the Buffers (Ladder Program)

- (2) Operation to be performed upon turning ON the system power again (including turning ON the servo power again)

Re-setup the position data at the high-speed scan timing by the ladder program as follows. Perform this operation when turning ON the system power again or turning ON the servo power again.

- ① Storing "Pulse position at shutdown" and "Encoder position at shutdown" to setting parameters
Store "Pulse position at shutdown" and "Encoder position at shutdown" having been saved in the M register to the following setting parameters.

Setting parameter "Encoder position at shutdown (all 4 words of OL□□38 and OL□□3A)"
Setting parameter "Pulse position at shutdown (all 4 words of OL□□3C and OL□□3E)"

At this time, store the data in the buffer selected by the toggle buffer selection flag.

- ② Operation of the "ABS system infinite-length position control data load request"
Turn "OFF"→"ON"→"OFF" the setting parameter "ABS system infinite-length position control data load request (Bit 2 of OW□□2D)." By this operation, all position data is fixed. Also, the monitor parameter "Zero Point Setting Completion (Bit 3 of IW□□15)" turns "ON" and the following monitor parameters become valid.

Monitoring parameter "Encoder position at shutdown (all 4 words of IL□□38 and IL□□3A)"
Monitoring parameter "Pulse position at shutdown (all 4 words of IL□□3C and IL□□3E)"

The system creates position information by the following expression upon "ABS system infinite-length position control data load request."

$\text{Pulse position} = \text{pulse position at shutdown} +$ $\frac{(\text{encoder position} - \text{encoder position at shutdown})}{*}$

- * This means the amount of movement while the power is OFF.

In the flow shown in Fig. 6.11, the position data is re-setup by turning ON the position data re-setup request.

Re-setup the position data in accordance with the following flow.

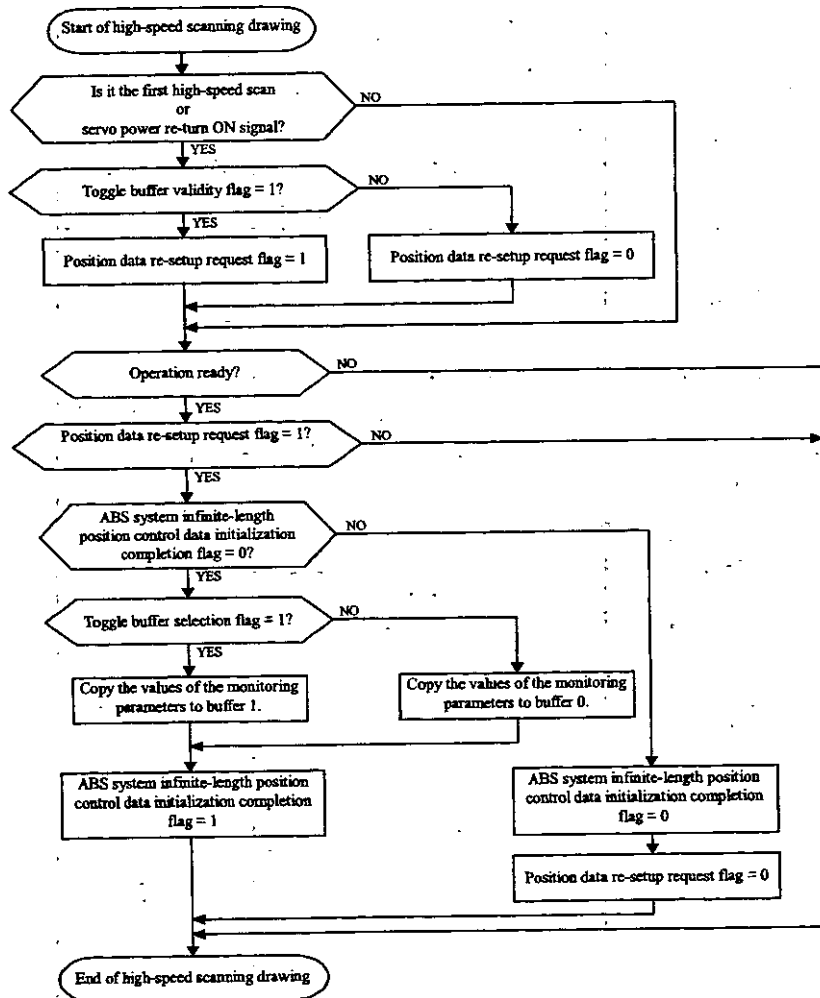
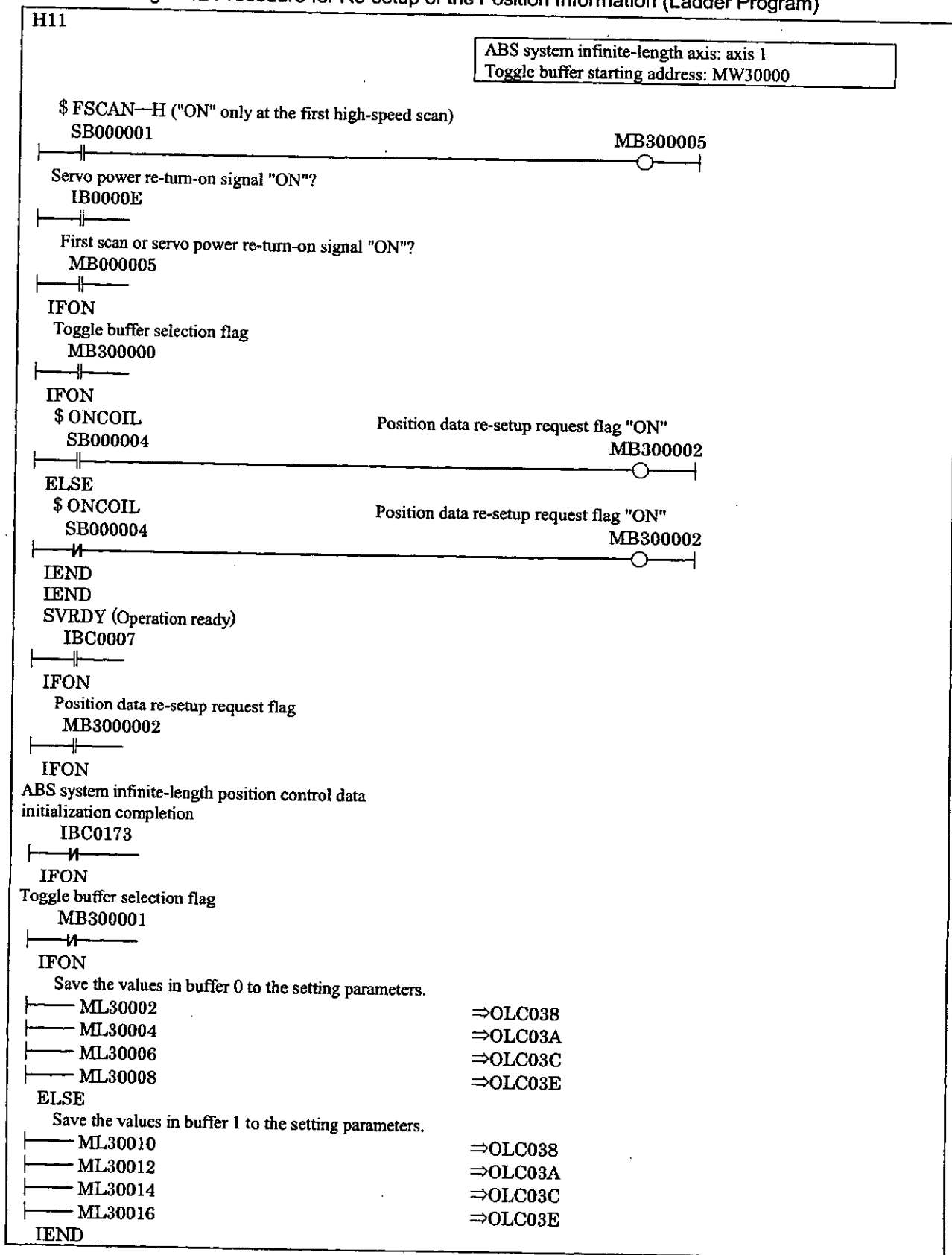

Fig. 6.11 Procedure for Re-setup of the Position Data (Flow Chart)

An example of programming the flow in Fig. 6.11 (ladder program) is shown below.

The first axis of module No. 1 is used. If the module No. and/or the axis No. is different, rewrite the motion parameter register No.

Fig. 6.12 Procedure for Re-setup of the Position Information (Ladder Program)



(continued)

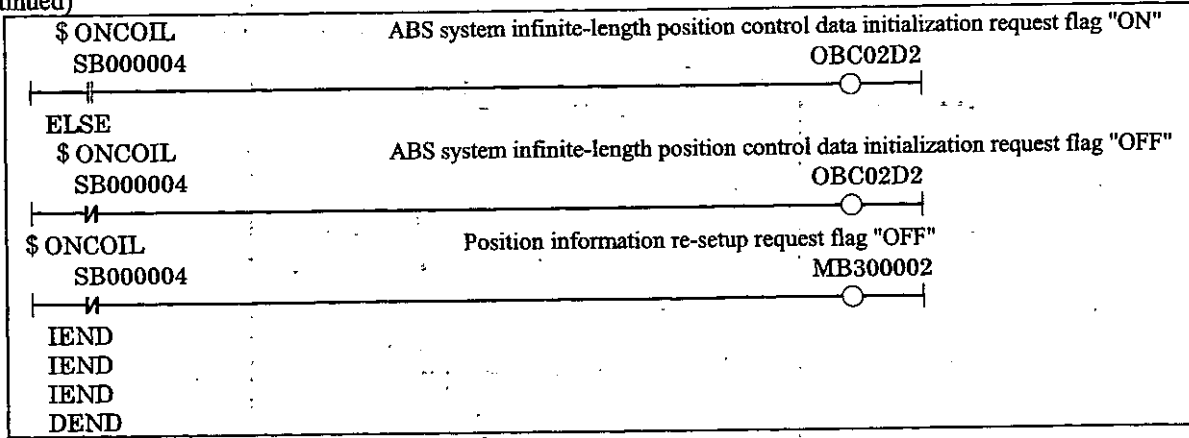

[Supplement]

The order of execution of ladder programs H10 and H11 necessary for using the absolute encoder on infinite-length axis has no restriction.

7 THROUGH COMMAND MODE

This chapter describes the through command mode.

7.1 Through command mode

In the through command mode, users can give MECHATROLINK servo commands directly.

The through command mode is valid when Bit 12 of fixed parameter No. 17 "Motion Controller Function Selection Flags" is set to "through command mode = 1."

At MECHATROLINK servo commands, command data is sent by using the motion setting parameters from OW□□30 to OW□□37 (16 bytes), and response data is received by using the motion setting parameters from IW□□30 to IW□□37 (16 bytes).

* For details of the MECHATROLINK commands, refer to the following manuals.

- High-speed Field Network MECHATROLINK System User's Manual (S1E-S800-26.1)
- High-speed Field Network MECHATROLINK Servo Command User's Manual (S1E-S800-26.2)
- Σ Series SGM□/SGD-□N User's Manual (S1E-S800-26.2)
- Σ Series SGM□/SGDB-□N User's Manual (S1EZ-S800-26.4)

7.2 Motion parameters to be used when the through command mode is selected

When the through command mode is selected, only the following motion parameters are valid. The other motion parameters cannot be used.

7.2.1 Motion fixed parameter

Bit 15 of fixed parameter No. 17 "Motion Controller Function Selection Flags"

: Interpolation command segment distributing function invalid selection

7.2.2 Motion setting parameters

Bit 6 of OW□□00 : Alarm clear

OW□□30 to OW□□37 : MECHATROLINK servo command data (16 bytes)

7.2.3 Motion monitoring parameters

Bit 2 of IW□□00 : Motion fixed parameter setting error

Bit 7 of IW□□00 : The motion controller RUN ready.

IW□□0F : Out of range parameter number

IL□□06 : Machine coordinate system latch position (LPOS)

IW□□30 to IW□□37 : MECHATROLINK servo command response data (16 bytes)

7.3 Unusable MECHATROLINK commands

Since connection control is performed by the system, do not use the following MECHATROLINK commands unless otherwise intended.

- Connection request command (CONNECT)
- Disconnection request command (DISCONNECT)
- Synchronization request command (SYNC_SET)
- Equipment setup request command (CONFIG)
- Sensor "ON" command (SENS_ON)
- Sensor "OFF" command (SENS_OFF)

7.4 Processes that are performed by the system on MECHATROLINK communications

7.4.1 Connection control

When the system power is turned on, the system automatically performs the process from connection to synchronization with the MECHATROLINK servo to establish MECHATROLINK communication phase 3 (synchronous communications).

At alarm clear, the system automatically clears the MECHATROLINK servo alarm, and returns the MECHATROLINK communication phase to phase 3 (synchronous communications).

7.4.2 Watchdog timer process

In the WDT field of the 16th byte (command data/response data) of the MECHATROLINK servo command, the system automatically creates sending data and detects errors.

Upon error detection, the MECHATROLINK communication phase is brought to phase 2 (asynchronous communications) or phase 4 (communication stop), and "The motion controller is ready for operation" (Bit 7 of the motion monitoring parameter "Running status") is brought to "The motion controller is not ready for operation = 0."

7.4.3 Interpolation issuing segment distribution

With the interpolation issuing segment distributing function invalid selection (Bit 15 of fixed parameter No. 17 "Motion controller function selection flags") = valid "0", when the issue of the interpolation segment at each high-speed scan is uniform, such a process whereby the issue of the interpolation segment in each MECHATROLINK communication cycle is uniform is performed.

7.5 Precautions

(1) Take the MECHATROLINK communication delay into consideration.

Pay attention to the MECHATROLINK servo command response data delay due to the MECHATROLINK communication delay.

For example, even if the motion command "POSING" or the like is given in the axial stop condition, the issue completion status is not turned "OFF" immediately.

Refer to the MECHATROLINK servo command response data after a lapse of the number of scans shown below.

- ① When the high-speed scan setting time < 6 ms,
Waiting number of scans = $12 \text{ ms} \div \text{high-speed scan setting time} + 1$... Raise the fraction
- ② When $6 \text{ ms} \leq \text{high-speed scan setting time} \leq 12 \text{ ms}$,
Waiting number of scans = $12 \text{ ms} \div \text{high-speed scan setting time} + 2$... Raise the fraction
- ③ When the high-speed scan setting time > 12 ms,
Waiting number of scans = 2 scan

(2) Be aware that the high-speed scanning cycle and the MECHATROLINK communication cycle are asynchronous.

When using interpolation-related MECHATROLINK servo commands (= INTERPOLATION LATCH), be sure to set the interpolation issuing segment distributing function invalid select (Bit 15 of fixed parameter No. 17 "Motion Controller Function Selection Flags") to valid = 0.

If set to "invalid," the issue of the interpolation segment in each MECHATROLINK communication cycle is not uniform even if the issue of the interpolation segment at each high-speed scan is uniform, resulting in irregularities in speed wave form.

(3) Pay attention to the conditions to open the MECHATROLINK servo user constant screen CP-717.

The user constant screen can be opened only when the MECHATROLINK servo command is NOP. The user constant screen cannot be opened when another command is executed.

MACHINE CONTROLLER CP-9200SH/SVB MOTION CONTROLLER USER'S MANUAL

TOKYO OFFICE

New Pier Takeshiba South Tower, 1-16-1, Kaigan, Minatoku, Tokyo 105-6891 Japan
Phone 81-3-5402-4511 Fax 81-3-5402-4580

YASKAWA ELECTRIC AMERICA, INC.

2121 Norman Drive South, Waukegan, IL 60085, U.S.A.
Phone 1-847-887-7000 Fax 1-847-887-7370

MOTOMAN INC. HEADQUARTERS

805 Liberty Lane West Carrollton, OH 45449, U.S.A.
Phone 1-937-847-6200 Fax 1-937-847-6277

YASKAWA ELÉTRICO DO BRASIL COMÉRCIO LTDA.

Avenida Fagundes Filho, 620 Bairro Saude-Sao Paulo-SP, Brazil CEP: 04304-000
Phone 55-11-5071-2552 Fax 55-11-5581-8795

YASKAWA ELECTRIC EUROPE GmbH

Am Kronberger Hang 2, 65824 Schwalbach, Germany
Phone 49-6196-569-300 Fax 49-6196-888-301

Motoman Robotics Europe AB

Box 504 S38525 Torsås, Sweden
Phone 46-486-48800 Fax 46-486-41410

Motoman Robotec GmbH

Kammerfeldstraße 1, 85391 Allershausen, Germany
Phone 49-8166-900 Fax 49-8166-9039

YASKAWA ELECTRIC UK LTD.

1 Hunt Hill Orchardton Woods Cumbernauld, G68 9LF, United Kingdom
Phone 44-1236-735000 Fax 44-1236-458182

YASKAWA ELECTRIC KOREA CORPORATION

Kipa Bldg #1201, 35-4 Youido-dong, Yeongdeungpo-Ku, Seoul 150-010, Korea
Phone 82-2-784-7844 Fax 82-2-784-8495

YASKAWA ELECTRIC (SINGAPORE) PTE. LTD.

151 Lorong Chuan, #04-01, New Tech Park Singapore 556741, Singapore
Phone 65-282-3003 Fax 65-289-3003

YASKAWA ELECTRIC (SHANGHAI) CO., LTD.

4F No.18 Aona Road, Waigaoqiao Free Trade Zone, Pudong New Area, Shanghai 200131, China
Phone 86-21-5866-3470 Fax 86-21-5866-3869

YATEC ENGINEERING CORPORATION

Shen Hsiang Tang Sung Chiang Building 10F 146 Sung Chiang Road, Taipei, Taiwan
Phone 886-2-2563-0010 Fax 886-2-2567-4677

YASKAWA ELECTRIC (HK) COMPANY LIMITED

Rm. 2909-10, Hong Kong Plaza, 186-191 Connaught Road West, Hong Kong
Phone 852-2803-2385 Fax 852-2547-5773

BEIJING OFFICE

Room No. 301 Office Building of Beijing International Club, 21
Jianguomenwai Avenue, Beijing 100020, China
Phone 86-10-6532-1850 Fax 86-10-6532-1851

TAIPEI OFFICE

Shen Hsiang Tang Sung Chiang Building 10F 146 Sung Chiang Road, Taipei, Taiwan
Phone 886-2-2563-0010 Fax 886-2-2567-4677

SHANGHAI YASKAWA-TONGJI M & E CO., LTD.

27 Hui He Road Shanghai China 200437
Phone 86-21-6531-4242 Fax 86-21-6553-6060

BEIJING YASKAWA BEIKE AUTOMATION ENGINEERING CO., LTD.

30 Xue Yuan Road, Haidian, Beijing P.R. China Post Code: 100083
Phone 86-10-6233-2782 Fax 86-10-6232-1536

SHOUGANG MOTOMAN ROBOT CO., LTD.

7, Yongchang-North Street, Beijing Economic Technological Investment & Development Area,
Beijing 100076, P.R. China
Phone 86-10-6788-0551 Fax 86-10-6788-2878



YASKAWA ELECTRIC CORPORATION