

Machine Controller MP3000 Series

Message Communications USER'S MANUAL

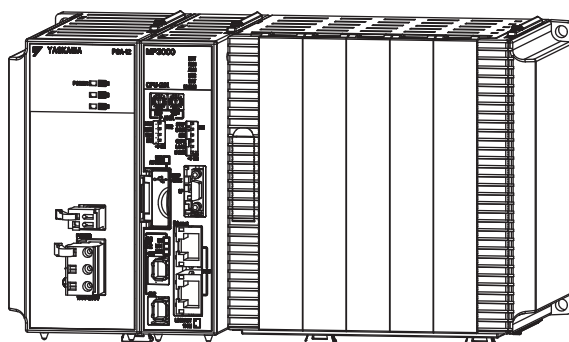
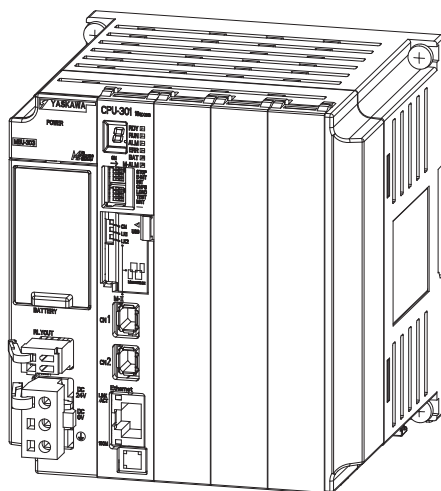

Overview	1
MEMOBUS Message Communications Method	2
No-Protocol Communications Method	3
Using Ethernet Communications	4
Using Serial Communications	5
Appendix	6

Copyright © 2020 YASKAWA ELECTRIC CORPORATION

All rights reserved. No part of this publication may be reproduced, stored in a retrieval system, or transmitted, in any form, or by any means, mechanical, electronic, photocopying, recording, or otherwise, without the prior written permission of Yaskawa. No patent liability is assumed with respect to the use of the information contained herein. Moreover, because Yaskawa is constantly striving to improve its high-quality products, the information contained in this manual is subject to change without notice. Every precaution has been taken in the preparation of this manual. Nevertheless, Yaskawa assumes no responsibility for errors or omissions. Neither is any liability assumed for damages resulting from the use of the information contained in this publication.

About this Manual

This manual describes the outline and communications connection methods for the message communications that are used with an MP3000-series Machine Controller.

Read this manual carefully to ensure the correct usage of the Machine Controller and apply the Machine Controller to control your manufacturing system.

Keep this manual in a safe place so that it can be referred to whenever necessary.

Using this Manual

◆ Basic Terms

Unless otherwise specified, the following definitions are used:

- MP3000: A MP3200 or MP3300 Machine Controller
- MPE720: The Engineering Tool or a personal computer running the Engineering Tool
- PLC: A Programmable Logic Controller
- SND function: MSG-SND or MSG-SNDE function
- RCV function: MSG-RCV or MSG-RCVE function

◆ Notation Rules for This Manual

- In this manual, the operation of MPE720 is described using screen captures of MPE720 version 7.
- This manual was written under the assumption that message communications is performed using the MP3200 and MP3300.
- The illustrations and screen captures used in this manual show either the MP3200 or MP3300. Substitute the appropriate content for your controller as you read this manual.

◆ Copyrights

- DeviceNet is a registered trademark of the ODVA (Open DeviceNet Vendor Association, Inc.).
- PROFIBUS is a trademark of the PROFIBUS User Organization.
- Ethernet is a registered trademark of the Xerox Corporation.
- Microsoft, Windows, Windows NT, and Internet Explorer are trademarks or registered trademarks of the Microsoft Corporation.
- MECHATROLINK is a trademark of the MECHATROLINK Members Association.
- Other product names and company names are the trademarks or registered trademarks of the respective company. "TM" and the ® mark do not appear with product or company names in this manual.

◆ Visual Aids

The following aids are used to indicate certain types of information for easier reference.



Indicates precautions or restrictions that must be observed.
Indicates alarm displays and other precautions that will not result in machine damage.



Indicates definitions of difficult terms or terms that have not been previously explained in this manual.

Example

Indicates operating or setting examples.

Information

Indicates supplemental information to deepen understanding or useful information.

Related Manuals

The following table lists the related manuals. Refer to these manuals as required. Be aware of all product specifications and restrictions to product application before you attempt to use any product.

Category	Manual Name	Manual Number	Contents
Basic functionality	Machine Controller MP3000 Series Machine Controller System Setup Manual	SIEP C880725 00	Describes the functions of the MP3000-series Machine Controllers and the procedures that are required to use the Machine Controller, from installation and connections to settings, programming, trial operation, and debugging.
	Machine Controller MP3000 Series MP3200/MP3300 Troubleshooting Manual	SIEP C880725 01	Describes troubleshooting an MP3000-series Machine Controller.
	Machine Controller MP3000 Series MP3200 Product Manual	SIEP C880725 10	Describes the specifications and system configuration of the Basic Units in an MP3000-series Machine Controller and the functions of the CPU Unit.
	Machine Controller MP3000 Series MP3300 Product Manual	SIEP C880725 21	Describes the specifications and system configuration of an MP3000-series MP3300 Machine Controller and the functions of the CPU Module.
Communications functionality	Machine Controller MP2000 Series Communication Module User's Manual	SIEP C880700 04	Provides information on the Communications Modules that can be connected to an MP2000-series Machine Controller and describes the communications methods.
	Machine Controller MP3000 Series Communications User's Manual	SIEP C880725 12	Describes the specifications, system configuration, and communications connection methods for the Ethernet communications that are used with an MP3000-series Machine Controller.
Programming	Machine Controller MP3000 Series Ladder Programming Manual	SIEP C880725 13	Describes the ladder programming specifications and instructions of MP3000-series Machine Controller.
Engineering Tool	MPE720 Version 7 System Integrated Engineering Tool for MP2000/MP3000 Series Machine Controller User's Manual	SIEP C880761 03	Describes how to operate MPE720 version 7.

Safety Precautions

◆ Safety Information

To prevent personal injury and equipment damage in advance, the following signal words are used to indicate safety precautions in this document. The signal words are used to classify the hazards and the degree of damage or injury that may occur if a product is used incorrectly. Information marked as shown below is important for safety. Always read this information and heed the precautions that are provided.



DANGER

- Indicates precautions that, if not heeded, are likely to result in loss of life, serious injury, or fire.



WARNING

- Indicates precautions that, if not heeded, could result in loss of life, serious injury, or fire.



CAUTION

- Indicates precautions that, if not heeded, could result in relatively serious or minor injury, or in fire.

NOTICE

- Indicates precautions that, if not heeded, could result in property damage.

◆ General Precautions

WARNING

- The installation must be suitable and it must be performed only by an experienced technician.
There is a risk of electrical shock or injury.
- Before connecting the machine and starting operation, make sure that an emergency stop procedure has been provided and is working correctly.
There is a risk of injury.
- Do not approach the machine after a momentary interruption to the power supply. When power is restored, the product and the device connected to it may start operation suddenly. Provide safety measures in advance to ensure human safety when operation restarts.
There is a risk of injury.
- Do not touch anything inside the product.
There is a risk of electrical shock.
- Do not remove the front cover, cables, connector, or options while power is being supplied.
There is a risk of electrical shock, malfunction, or damage.
- Do not damage, pull on, apply excessive force to, place heavy objects on, or pinch the cables.
There is a risk of electrical shock, operational failure of the product, or burning.
- Do not attempt to modify the product in any way.
There is a risk of injury or device damage.

◆ Storage and Transportation

CAUTION

- Do not store the product in any of the following locations.
 - Locations that are subject to direct sunlight
 - Locations that are subject to ambient temperatures that exceed the storage conditions
 - Locations that are subject to ambient humidity that exceeds the storage conditions
 - Locations that are subject to rapid temperature changes and condensation
 - Locations that are subject to corrosive or inflammable gas
 - Locations that are subject to excessive dust, dirt, salt, or metallic powder
 - Locations that are subject to water, oil, or chemicals
 - Locations that are subject to vibration or shockThere is a risk of fire, electrical shock, or device damage.
- Hold onto the main body of the product when transporting it.
Holding the cables or connectors may damage them or result in injury.
- Do not overload the product during transportation. (Follow all instructions.)
There is a risk of injury or an accident.
- Never subject the product to an atmosphere containing halogen (fluorine, chlorine, bromine, or iodine) during transportation.
There is a risk of malfunction or damage.
- If disinfectants or insecticides must be used to treat packing materials such as wooden frames, pallets, or plywood, the packing materials must be treated before the product is packaged, and methods other than fumigation must be used.
Example: Heat treatment, where materials are kiln-dried to a core temperature of 56°C for 30 minutes or more.
If the electronic products, which include stand-alone products and products installed in machines, are packed with fumigated wooden materials, the electrical components may be greatly damaged by the gases or fumes resulting from the fumigation process. In particular, disinfectants containing halogen, which includes chlorine, fluorine, bromine, or iodine can contribute to the erosion of the capacitors.

◆ Installation



CAUTION

- **Do not install the product in any of the following locations.**
 - Locations that are subject to direct sunlight
 - Locations that are subject to ambient temperatures that exceed the operating conditions
 - Locations that are subject to ambient humidity that exceeds the operating conditions
 - Locations that are subject to rapid temperature changes and condensation
 - Locations that are subject to corrosive or inflammable gas
 - Locations that are subject to excessive dust, dirt, salt, or metallic powder
 - Locations that are subject to water, oil, or chemicals
 - Locations that are subject to vibration or shockThere is a risk of fire, electrical shock, or device damage.
- **Never install the product in an atmosphere containing halogen (fluorine, chlorine, bromine, or iodine).**
There is a risk of malfunction or damage.
- **Do not step on the product or place heavy objects on the product.**
There is a risk of injury or an accident.
- **Do not block the air exhaust ports on the product. Do not allow foreign objects to enter the product.**
There is a risk of internal element deterioration, malfunction, or fire.
- **Always mount the product in the specified orientation.**
There is a risk of malfunction.
- **Leave the specified amount of space between the product, and the interior surface of the control panel and other devices.**
There is a risk of fire or malfunction.
- **Do not subject the product to strong shock.**
There is a risk of malfunction.
- **Suitable battery installation must be performed and it must be performed only by an experienced technician.**
There is a risk of electrical shock, injury, or device damage.
- **Do not touch the electrodes when installing the Battery.**
Static electricity may damage the electrodes.

◆ Wiring

CAUTION

- Check the wiring to be sure it has been performed correctly.
There is a risk of motor run-away, injury, or accidents.
- Always use a power supply of the specified voltage.
There is a risk of fire or accident.
- In places with poor power supply conditions, ensure that the input power is supplied within the specified voltage range.
There is a risk of device damage.
- Install breakers and other safety measures to provide protection against shorts in external wiring.
There is a risk of fire.
- Provide sufficient shielding when using the product in the following locations.
 - Locations that are subject to noise, such as from static electricity
 - Locations that are subject to strong electromagnetic or magnetic fields
 - Locations that are subject to radiation
 - Locations that are near power linesThere is a risk of device damage.
- Configure the circuits to turn ON the power supply to the CPU Unit/CPU Module before the 24-V I/O power supply. Refer to the following manuals for details on circuits.
 MP3000 Series MP3200 CPU Unit Instructions (Manual No.: TOBP C880725 16)
MP3000 Series MP3300 CPU Module Instructions (Manual No.: TOBP C880725 23)
If the power supply to the CPU Unit/CPU Module is turned ON after the external power supply, e.g., the 24-V I/O power supply, the outputs from the CPU Unit/CPU Module may momentarily turn ON when the power supply to the CPU Unit/CPU Module turns ON. This can result in unexpected operation that may cause injury or device damage.
- Provide emergency stop circuits, interlock circuits, limit circuits, and any other required safety measures in control circuits outside of the product.
There is a risk of injury or device damage.
- If you use MECHATROLINK I/O Modules, use the establishment of MECHATROLINK communications as an interlock output condition.
There is a risk of device damage.
- Connect the Battery with the correct polarity.
There is a risk of battery damage or explosion.
- Select the I/O signal wires for external wiring to connect the product to external devices based on the following criteria:
 - Mechanical strength
 - Noise interference
 - Wiring distance
 - Signal voltage
- Separate the I/O signal cables for control circuits from the power cables both inside and outside the control panel to reduce the influence of noise from the power cables.
If the I/O signal lines and power lines are not separated properly, malfunction may occur.

Example of Separated Cables

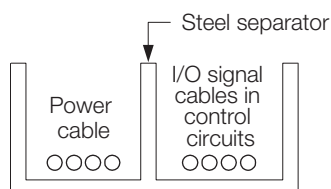

◆ Operation

CAUTION

- Follow the procedures and instructions in the user's manuals for the relevant products to perform normal operation and trial operation.
Operating mistakes while the Servomotor and machine are connected may damage the machine or even cause accidents resulting in injury or death.
- Implement interlock signals and other safety circuits external to the product to ensure safety in the overall system even if the following conditions occur.
 - Product failure or errors caused by external factors
 - Shutdown of operation due to product detection of an error in self-diagnosis and the subsequent turning OFF or holding of output signals
 - Holding of the ON or OFF status of outputs from the product due to fusing or burning of output relays or damage to output transistors
 - Voltage drops from overloads or short-circuits in the 24-V output from the product and the subsequent inability to output signals
 - Unexpected outputs due to errors in the power supply, I/O, or memory that cannot be detected by the product through self-diagnosis.There is a risk of injury, device damage, or burning.

◆ Maintenance and Inspection

CAUTION

- Do not attempt to disassemble or repair the product.
There is a risk of electrical shock, injury, or device damage.
- Do not change any wiring while power is being supplied.
There is a risk of electrical shock, injury, or device damage.
- Suitable battery replacement must be performed and it must be performed only by an experienced technician.
There is a risk of electrical shock, injury, or device damage.
- Do not forget to perform the following tasks when you replace the CPU Unit/CPU Module:
 - Back up all programs and parameters from the CPU Unit/CPU Module that is being replaced.
 - Transfer all saved programs and parameters to the new CPU Unit/CPU Module.If you operate the CPU Unit/CPU Module without transferring this data, unexpected operation may occur. There is a risk of injury or device damage.
- Do not touch the heat sink on the CPU Unit/CPU Module while the power supply is turned ON or for a sufficient period of time after the power supply is turned OFF.
The heat sink may be very hot, and there is a risk of burn injury.

◆ Disposal

- Dispose of the product as general industrial waste.
- Observe all local laws and ordinances when you dispose of used Batteries.

◆ Other General Precautions

- The products shown in the illustrations in this manual are sometimes shown without covers or protective guards. Always replace the cover or protective guard as specified first, and then operate the products in accordance with the manual.
- The illustrations that are presented in this manual are typical examples and may not match the product you received.
- If the manual must be ordered due to loss or damage, inform your nearest Yaskawa representative or one of the offices listed on the back of this manual.

Warranty

◆ Details of Warranty

■ Warranty Period

The warranty period for a product that was purchased (hereinafter called “delivered product”) is one year from the time of delivery to the location specified by the customer or 18 months from the time of shipment from the Yaskawa factory, whichever is sooner.

■ Warranty Scope

Yaskawa shall replace or repair a defective product free of charge if a defect attributable to Yaskawa occurs during the warranty period above. This warranty does not cover defects caused by the delivered product reaching the end of its service life and replacement of parts that require replacement or that have a limited service life.

This warranty does not cover failures that result from any of the following causes.

- Improper handling, abuse, or use in unsuitable conditions or in environments not described in product catalogs or manuals, or in any separately agreed-upon specifications
- Causes not attributable to the delivered product itself
- Modifications or repairs not performed by Yaskawa
- Abuse of the delivered product in a manner in which it was not originally intended
- Causes that were not foreseeable with the scientific and technological understanding at the time of shipment from Yaskawa
- Events for which Yaskawa is not responsible, such as natural or human-made disasters

◆ Limitations of Liability

- Yaskawa shall in no event be responsible for any damage or loss of opportunity to the customer that arises due to failure of the delivered product.
- Yaskawa shall not be responsible for any programs (including parameter settings) or the results of program execution of the programs provided by the user or by a third party for use with programmable Yaskawa products.
- The information described in product catalogs or manuals is provided for the purpose of the customer purchasing the appropriate product for the intended application. The use thereof does not guarantee that there are no infringements of intellectual property rights or other proprietary rights of Yaskawa or third parties, nor does it construe a license.
- Yaskawa shall not be responsible for any damage arising from infringements of intellectual property rights or other proprietary rights of third parties as a result of using the information described in catalogs or manuals.

◆ Suitability for Use

- It is the customer's responsibility to confirm conformity with any standards, codes, or regulations that apply if the Yaskawa product is used in combination with any other products.
- The customer must confirm that the Yaskawa product is suitable for the systems, machines, and equipment used by the customer.
- Consult with Yaskawa to determine whether use in the following applications is acceptable. If use in the application is acceptable, use the product with extra allowance in ratings and specifications, and provide safety measures to minimize hazards in the event of failure.
 - Outdoor use, use involving potential chemical contamination or electrical interference, or use in conditions or environments not described in product catalogs or manuals
 - Nuclear energy control systems, combustion systems, railroad systems, aviation systems, vehicle systems, medical equipment, amusement machines, and installations subject to separate industry or government regulations
 - Systems, machines, and equipment that may present a risk to life or property
 - Systems that require a high degree of reliability, such as systems that supply gas, water, or electricity, or systems that operate continuously 24 hours a day
 - Other systems that require a similar high degree of safety
- Never use the product for an application involving serious risk to life or property without first ensuring that the system is designed to secure the required level of safety with risk warnings and redundancy, and that the Yaskawa product is properly rated and installed.
- The circuit examples and other application examples described in product catalogs and manuals are for reference. Check the functionality and safety of the actual devices and equipment to be used before using the product.
- Read and understand all use prohibitions and precautions, and operate the Yaskawa product correctly to prevent accidental harm to third parties.

◆ Specifications Change

The names, specifications, appearance, and accessories of products in product catalogs and manuals may be changed at any time based on improvements and other reasons. The next editions of the revised catalogs or manuals will be published with updated code numbers. Consult with your Yaskawa representative to confirm the actual specifications before purchasing a product.

Contents

About this Manual	iii
Using this Manual	iii
Related Manuals	iv
Safety Precautions	v
Warranty	x

1

Overview

1.1	Message Communications Overview	1-2
1.2	MEMOBUS Message Communications Method	1-3
1.2.1	Protocols Implemented in MP-series Controllers	1-3
1.2.2	Communications Methods	1-5
1.3	No-Protocol Communications Method	1-6
1.3.1	Protocols in No-Protocol Communications	1-6
1.3.2	Communications Methods	1-6
1.4	Selecting a Communications Method for the Remote Device . .	1-7
1.4.1	For Ethernet Communications	1-7
1.4.2	For Serial Communications	1-7
1.5	Relationship between Communications Devices and Communications Modules . .	1-8

2

MEMOBUS Message Communications Method

2.1	Automatic Reception	2-2
2.1.1	Execution Timing of Automatic Reception	2-2
2.2	I/O Message Communications	2-3
2.3	Message Functions	2-4
2.3.1	MSG-SNDE Function	2-5
2.3.2	MSG-RCVE Function	2-20
2.3.3	MSG-SND Function	2-34
2.3.4	MSG-RCV Function	2-42

3

No-Protocol Communications Method

3.1	No-Protocol Communications	3-2
3.1.1	For Ethernet Communications	3-2
3.1.2	For Serial Communications	3-5
3.2	Message Functions Related to No-Protocol Communications. .	3-6
3.2.1	MSG-SNDE Function	3-6
3.2.2	MSG-RCVE Function	3-8
3.2.3	MSG-SND Function	3-11

3.2.4	MSG-RCV Function	3-15
-------	----------------------------	------

3.3 No-Protocol FD Communications 3-19

3.3.1	Specification	3-19
3.3.2	Protocol Operation	3-20
3.3.3	Processing of a Received Data Error	3-20
3.3.4	Precautions When Using No-Protocol FD Communications.	3-21

3.4 Message Functions Related to No-Protocol FD Communications . . 3-22

3.4.1	MSG-SNDE Function.	3-22
3.4.2	MSG-RCVE Function.	3-23
3.4.3	MSG-SND Function.	3-26
3.4.4	MSG-RCV Function.	3-29

4 Using Ethernet Communications

4.1 Communications with MP-series Controllers. 4-3

4.1.1	Using Automatic Reception with the MP3000 as a Slave.	4-3
4.1.2	Using the MSG-RCVE Function with the MP3000 as a Slave.	4-13
4.1.3	Using I/O Message Communications with the MP3000 as the Master.	4-23
4.1.4	Using the MSG-SNDE Function with the MP3000 as the Master	4-31
4.1.5	Message Functions	4-39

4.2 Communications with a Touch Panel 4-48

4.2.1	Using Automatic Reception with the MP3000 as a Slave.	4-48
-------	---	------

4.3 Communications with a Mitsubishi PLC (A-compatible 1E Frame Protocol) . . 4-55

4.3.1	Using Automatic Reception with the MP3000 as a Slave.	4-55
4.3.2	Using I/O Message Communications with the MP3000 as the Master.	4-59
4.3.3	Using the MSG-SNDE Function with the MP3000 as the Master	4-64
4.3.4	Message Functions	4-70

4.4 Communications with a Mitsubishi PLC (QnA-compatible 3E Frame Protocol) . . 4-84

4.4.1	Using I/O Message Communications with the MP3000 as the Master.	4-84
4.4.2	Using the MSG-SNDE Function with the MP3000 as the Master	4-90
4.4.3	Message Functions	4-101

4.5 Communications with an OMRON PLC (FINS Communications Service). . 4-117

4.5.1	Using Automatic Reception with the MP3000 as a Slave.	4-117
4.5.2	Using the MSG-RCVE Function with the MP3000 as a Slave.	4-125
4.5.3	Using I/O Message Communications with the MP3000 as the Master.	4-134
4.5.4	Using the MSG-SNDE Function with the MP3000 as the Master	4-140
4.5.5	Routing	4-149
4.5.6	Message Functions	4-151

4.6 Communications with a KOYO PLC (MODBUS/TCP Protocol) . . 4-164

4.6.1	Using Automatic Reception with the MP3000 as a Slave.	4-164
4.6.2	Using I/O Message Communications with the MP3000 as the Master.	4-169
4.6.3	Using the MSG-SNDE Function with the MP3000 as the Master	4-173
4.6.4	Message Functions	4-179

4.7 Communications with a JTEKT PLC (TOYOPUC Protocol) . . 4-188

4.7.1	Using Automatic Reception with the MP3000 as a Slave.	4-188
4.7.2	Using the MSG-RCVE Function with the MP3000 as a Slave.	4-196
4.7.3	Using the MSG-SNDE Function with the MP3000 as the Master	4-205
4.7.4	Message Functions	4-214

4.8	No-Protocol Communications	4-225
4.8.1	Using the MSG-SNDE and MSG-RCVE Functions with the MP3000 as the Master	4-225

5

Using Serial Communications

5.1	MEMOBUS Protocol	5-3
5.1.1	Using Automatic Reception with the MP3000 as a Slave	5-3
5.1.2	Using the MSG-RCVE Function with the MP3000 as a Slave	5-9
5.1.3	Using the MSG-SNDE Function with the MP3000 as the Master	5-16
5.1.4	Message Functions	5-22
5.2	A-Compatible 1C Frame Protocol	5-30
5.2.1	Using the MSG-SNDE Function with the MP3000 as the Master	5-30
5.2.2	Message Functions	5-36
5.3	OMRON Protocol	5-41
5.3.1	Using the MSG-SNDE Function with the MP3000 as the Master	5-41
5.3.2	Message Functions	5-46
5.4	No-Protocol Communications	5-51
5.4.1	Using the MSG-SNDE and MSG-RCVE Functions with the MP3000 as the Master	5-51
5.5	No-Protocol FD Communications	5-57
5.5.1	Using the MSG-SNDE and MSG-RCVE Functions with the MP3000 as the Master	5-57

6

Appendix

6.1	Communications Specifications	6-2
6.1.1	Ethernet Communications Specifications	6-2
6.1.2	Serial Communications Specifications	6-4
6.2	Communications Buffer Channels	6-5
6.3	Using Message Functions	6-7
6.3.1	Function Codes	6-7
6.3.2	Using Function Codes	6-8
6.4	Details on Protocols	6-25
6.4.1	Extended MEMOBUS protocol	6-25
6.4.2	MEMOBUS Protocol	6-48
6.4.3	No-Protocol Communications	6-55

Index

Revision History

Overview

1

This chapter provides an overview of message communications.

1.1	Message Communications Overview	1-2
1.2	MEMOBUS Message Communications Method . .	1-3
1.2.1	Protocols Implemented in MP-series Controllers	1-3
1.2.2	Communications Methods	1-5
1.3	No-Protocol Communications Method	1-6
1.3.1	Protocols in No-Protocol Communications	1-6
1.3.2	Communications Methods	1-6
1.4	Selecting a Communications Method for the Remote Device . .	1-7
1.4.1	For Ethernet Communications	1-7
1.4.2	For Serial Communications	1-7
1.5	Relationship between Communications Devices and Communications Modules . .	1-8

1.1 Message Communications Overview

A controller can perform communications and exchange data with other controllers and peripheral devices by using message communications. Ethernet and serial communications are available as the communications paths.

There are two types of message communications: the MEMOBUS message communications method and no-protocol communications method.

An overview of each of these communications methods is shown below.

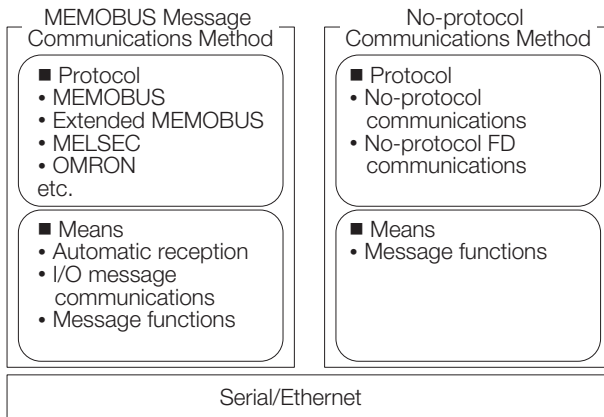

Description		References for MEMOBUS Message Communications	References for No-Protocol Communications
Overview		1.2 MEMOBUS Message Communications Method on page 1-3	1.3 No-Protocol Communications Method on page 1-6
Details	Automatic Reception	2.1 Automatic Reception on page 2-2	–
	I/O Message Communications	2.2 I/O Message Communications on page 2-3	–
	Message Functions	2.3 Message Functions on page 2-4	–
	No-Protocol	–	3.1 No-Protocol Communications on page 3-2
	No-Protocol FD	–	3.3 No-Protocol FD Communications on page 3-19

1.2 MEMOBUS Message Communications Method

The MEMOBUS message communications method refers to the method that performs communications using the protocols that are implemented in MP-series Controllers.

A program for performing communications may also not be required with this method. Even if a program is required, communications is performed according to the implemented protocols, so the user does not need to build communications rules into the program.

1.2.1 Protocols Implemented in MP-series Controllers

The following protocols are implemented in MP-series Controllers.

- MEMOBUS
- Extended MEMOBUS
- MELSEC A-compatible 1E frame
- MELSEC A-compatible 1C frame
- MELSEC QnA-compatible 3E frame
- OMRON FINS
- OMRON host link C mode
- TOYOPUC
- MODBUS/TCP

MEMOBUS Protocol

Use the MEMOBUS protocol to perform message communications with a remote device that implements this protocol.

If automatic reception is used when the MP3000 is the slave, the MP3000 does not require a communications program. However, the remote device requires a communications program.

If I/O message communications is used when the MP3000 is the master, the MP3000 does not require a communications program. However, this method allows the use of only M registers in the remote device and communications with only one slave.

Message communications can be performed with the remote device without these restrictions if you create a communications program on the MP3000.

Extended MEMOBUS protocol

Use the Extended MEMOBUS protocol to perform message communications with a remote device that implements this protocol.

If automatic reception is used when the MP3000 is the slave, the MP3000 does not require a communications program. However, the remote device requires a communications program.

If I/O message communications is used when the MP3000 is the master, the MP3000 does not require a communications program. However, this method allows the use of only M and G registers in the remote device and communications with only one slave.

Message communications can be performed with the remote device without these restrictions if you create a communications program on the MP3000.

MELSEC A-Compatible 1E Frame (MC Protocol)

Use the MELSEC A-compatible 1E frame protocol when performing Ethernet communications between the MP3000 and a Mitsubishi Q/A-series PLC.

If I/O message communications is used when the MP3000 is the master, the a communications program is not required on the MELSEC Q-series, but a communications program is required on the MELSEC A-series.

Message communications can also be performed with the MELSEC (Q/A) if you create a communications program on the MP3000.

If automatic reception is used when the MP3000 is the slave, the MP3000 does not require a communications program.

MELSEC A-Compatible 1C Frame (MC Protocol)

Use the MELSEC A-compatible 1C frame protocol when performing serial communications between the MP3000 and a Mitsubishi Q/A-series PLC.

When the MP3000 is the master, the MP3000 requires a communications program. The MELSEC (Q/A) does not require a communications program. However, the A-series also requires a communications setup program.

If automatic reception is used when the MP3000 is the slave, the MP3000 does not require a communications program.

MELSEC QnA-Compatible 3E Frame (MC Protocol)

Use the MELSEC QnA-compatible 3E frame protocol when performing Ethernet communications (MC protocol communications) between the MP3000 and a Mitsubishi Q/QnA-series PLC.

If I/O message communications is used when the MP3000 is the master, the MP3000 and MELSEC (Q/QnA) do not require a communications program.

Message communications can also be performed with the MELSEC (Q/QnA) if you create a communications program on the MP3000. In this case, the MELSEC (Q/QnA) does not require a communications program.

Select MELSEC A-compatible 1E frame when performing random access buffer communications or fixed buffer communications with the Q/QnA-series.

If automatic reception is used when the MP3000 is the slave, the MP3000 does not require a communications program.

OMRON FINS Protocol

Use the OMRON FINS protocol when performing Ethernet communications between the MP3000 and an OMRON PLC.

If automatic reception is used when the MP3000 is the slave, the MP3000 does not require a communications program. However, the OMRON PLC requires a communications program.

If I/O message communications is used when the MP3000 is the master, the MP3000 and OMRON PLC do not require a communications program.

Message communications can also be performed with the OMRON PLC if you create a communications program on the MP3000. In this case, the OMRON PLC does not require a communications program.

OMRON Host Link C Mode

Use the OMRON host link C mode protocol when performing serial communications between the MP3000 and an OMRON PLC.

If automatic reception is used when the MP3000 is the slave, the MP3000 does not require a communications program. However, the OMRON PLC requires a communications program.

When the MP3000 is the master, the MP3000 and OMRON PLC require a communications program.

TOYOPUC Protocol

Use the TOYOPUC protocol when performing Ethernet communications between the MP3000 and a JTEK TOYOPUC PLC.

If automatic reception is used when the MP3000 is the slave, the MP3000 does not require a communications program. However, the JTEK TOYOPUC PLC requires a communications program.

I/O message communications cannot be used due to restrictions on registers.

When the MP3000 is the master, the MP3000 and JTEK TOYOPUC PLC require a communications program.

MODBUS/TCP Protocol

The MODBUS/TCP protocol performs communications with MODBUS/RTU messages over an Ethernet TCP/IP network.

Use the MODBUS/TCP protocol to perform Ethernet communications with a remote device that implements this protocol.

If automatic reception is used when the MP3000 is the slave, the MP3000 does not require a communications program.

If I/O message communications is used when the MP3000 is the master, the MP3000 does not require a program for communications. However, this method allows the use of only M registers in the remote device and communications with only one slave. Message communications can be performed with the remote device without these restrictions if you create a communications program on the MP3000.

1.2.2 Communications Methods

The MP3000 performs communications (exchanges messages) according to protocols described in the previous section. The following three methods are available as methods for performing communications with a remote device.

- **Automatic Reception**
Use this method when performing communications with a remote device and the MP3000 functions as the slave.
- **I/O Message Communications**
Use this method when performing communications with a remote device and the MP3000 functions as the master.
- **Message Functions**
Use the message functions when the MP3000 requires a communications program. The SND functions (MSG-SND and MSG-SNDE) are message functions used to send messages, and the RCV functions (MSG-RCV and MSG-RCVE) are message functions used to receive messages.
Use the SND functions when performing communications and the MP3000 functions as the master.
Use the RCV functions when performing communications and the MP3000 functions as the slave.

1.3 No-Protocol Communications Method

The no-protocol communications method refers to the method that performs communications using a protocol that is not implemented in MP-series Controllers.

With this communications method, the user must build the communications protocol for the remote device in the ladder program.

1.3.1 Protocols in No-Protocol Communications

The protocol used in no-protocol communications is the protocol of the remote device.

There are two types of no-protocol communications, no-protocol (half duplex) and no-protocol FD (full duplex). These types serve to control the physical layer.

No-Protocol

No-protocol communications is half-duplex communications. Sending and receiving cannot be processed simultaneously.

No-Protocol FD

No-protocol FD communications is full-duplex communications. Sending and receiving can be executed simultaneously.

1.3.2 Communications Methods

In no-protocol communications, the message functions are used to communicate with the remote device.

The SND functions (MSG-SND and MSG-SNDE) are message functions used to send messages, and the RCV functions (MSG-RCV and MSG-RCVE) are message functions used to receive messages.

Use the SND functions when sending data from the MP3000.

Use the RCV functions when receiving data on the MP3000.

1.4 Selecting a Communications Method for the Remote Device

1.4.1 For Ethernet Communications

MP3000 Usage	Communications Method	Remote Device	Protocol	Method
Used as master	MEMOBUS message	MP2000 / MP3000	Extended MEMOBUS	<ul style="list-style-type: none"> I/O message communications MSG-SND□
		Other manufacturer's PLC	MELSEC (A-compatible 1E) MELSEC (QnA-compatible 3E) OMRON (FINS) MODBUS/TCP	<ul style="list-style-type: none"> I/O message communications MSG-SND□
	No-protocol	Device with unique protocol	Unique protocol	<ul style="list-style-type: none"> MSG-SND□ (no-protocol) Combine with MSG-RCV□ if there is a response from the remote device.
Used as slave	MEMOBUS message	MP2000 / MP3000	Extended MEMOBUS	<ul style="list-style-type: none"> Automatic reception MSG-RCV□
		Other manufacturer's PLC Touch panel	MELSEC (A-compatible 1E) MELSEC (QnA-compatible 3E) OMRON (FINS) MODBUS/TCP	<ul style="list-style-type: none"> Automatic reception MSG-RCV□
	No-protocol	Device with unique protocol	Unique protocol	<ul style="list-style-type: none"> MSG-RCV□ (no-protocol) Combine with MSG-SND□ if a response for the remote device is required.

1.4.2 For Serial Communications

MP3000 Usage	Communications Method	Remote Device	Protocol	Method
Used as master	MEMOBUS message	MP2000 / MP3000	MEMOBUS	<ul style="list-style-type: none"> MSG-SND□
		Other manufacturer's PLC	MELSEC (special protocol format 1) OMRON (host link mode)	<ul style="list-style-type: none"> MSG-SND□
	No-protocol	Device with unique protocol	Unique protocol	<ul style="list-style-type: none"> MSG-SND□ (no-protocol) Combine with MSG-RCV□ if there is a response from the remote device.
Used as slave	MEMOBUS message	MP2000 / MP3000	MEMOBUS	<ul style="list-style-type: none"> MSG-RCV□
		Other manufacturer's PLC Touch panel	MELSEC (special protocol format 1) OMRON (host link mode)	<ul style="list-style-type: none"> MSG-RCV□
	No-protocol	Device with unique protocol	Unique protocol	<ul style="list-style-type: none"> MSG-RCV□ (no-protocol) Combine with MSG-SND□ if a response for the remote device is required.

1.5 Relationship between Communications Devices and Communications Modules

The following table shows the relationship between communications devices and communications modules.

The abbreviation for the communications device indicates the name of the Function Module that supports Ethernet or serial communications.

Communications Standard	Communications Device (Code)	Communications Module	Product Model	Connector Name
Ethernet	Ethernet (218IFD)	CPU-301 (16 axes)	JAPMC-CP3301-1-E	Ethernet
		CPU-301 (32 axes)	JAPMC-CP3301-2-E	
		CPU-302 (16 axes)	JAPMC-CP3302-1-E	
		CPU-302 (32 axes)	JAPMC-CP3302-2-E	
		CPU-201	JEPMC-CP3201-E	
		CPU-202	JEPMC-CP3202-E	
	Ethernet (218IF)	218IF-01	JAPMC-CM2300-E	10Base-T
Ethernet (218IFB)	218IF-02	JAPMC-CM2302-E	Ethernet	
Serial	RS232-C/422/485 (217IF)	215AIF-01 MPLINK	JAPMC-CM2360-E	CN2
		215AIF-01 CP-215	JAPMC-CM2361	
		217IF-01	JAPMC-CM2310-E	PORT, RS422/485
		218IF-01	JAPMC-CM2300-E	PORT
		218IF-02	JAPMC-CM2302-E	
		260IF-01	JAPMC-CM2320-E	
		261IF-01	JAPMC-CM2330-E	

MEMOBUS

Message Communications Method

2

The MP3000 implements a number of well known protocols as standard. Use these implemented protocols and the MP3000 can communicate with a remote device without a communications program by using automatic reception and I/O message communications. If a communications program is required, the MP3000 can exchange data with a remote device simply by using the message functions in the appropriate sequence.

2.1	Automatic Reception	2-2
2.1.1	Execution Timing of Automatic Reception	2-2
2.2	I/O Message Communications	2-3
2.3	Message Functions	2-4
2.3.1	MSG-SNDE Function	2-5
2.3.2	MSG-RCVE Function	2-20
2.3.3	MSG-SND Function	2-34
2.3.4	MSG-RCV Function	2-42

2.1 Automatic Reception

Automatic reception allows message communications without using message receive functions (RCV functions) in the ladder program when the MP3000 functions as the slave station. This function cannot be used with the no-protocol communications method (no-protocol or no-protocol FD).

To use automatic reception, it must be configured in the detail definition settings of the Module Configuration Definition Tab Page.

The following table shows the Communication Modules that can use automatic reception.

Module Name	Communications Port	Automatic Reception	Number of Connections
218IF-01	PORT (RS-232C)	Supported	1
	10Base-T (218IF)	Not supported	–
218IF-02	PORT (RS-232C)	Supported	1
	Ethernet (218IFB)	Not supported	–
217IF-01	PORT (RS-232C)	Supported	1
	RS422 / 485	Supported	1
260IF-01	PORT (RS-232C)	Supported	1
	DeviceNet	Not supported	–
261IF-01	PORT (RS-232C)	Supported	1
	PROFIBUS	Not supported	–
215AIF-01	CN1 (CP-215)	Not supported	–
	CN2 (RS-232C)	Supported	1
CPU-301 (16 axes) CPU-301 (32 axes) CPU-302 (16 axes) CPU-302 (32 axes) CPU-201 CPU-202	Ethernet (218IFD)	Supported	10

Automatic reception is enabled by default on ports that can use automatic reception.

Refer to the “Communications Settings” section in each chapter for how to enable and disable automatic reception.

- Information** In addition to automatic reception, RCV functions are also available as a communications method when using the MP3000 as a slave.
The following lists the merits and demerits of RCV functions:
- Merits
- Offsets and writing ranges can be changed within the ladder program range.
 - The communications processing results and communications status can be monitored during debugging.
 - Messages can be received faster than in the low-speed scan.
- Demerits
- You must create a ladder program.
 - Scan execution time increases.

2.1.1 Execution Timing of Automatic Reception

The priority for processing of automatic reception is higher than the low-speed scan and lower than the high-speed scan. For this reason, if there is no free time in the high-speed scan processing time, response processing for automatic reception may be delayed. Additionally, if there is no free time in the low-speed scan processing time, the execution time for low-speed scan processing may increase.

2.2

I/O Message Communications

With I/O message communications, the MP3000 functions as the master device and communicates with PLCs and devices from other manufacturers.

Configure the I/O message settings in the detail definition settings of the Module Configuration Definition Tab Page only and messages can be sent without using send message functions (SND functions) in the ladder program.

Data is exchanged with the remote device using O and I registers.

A maximum of two channels (two connections) are allowed.

The following table shows the Communication Modules that can use I/O message communications.

Module Name	Communications Port	I/O Message Communications	Number of Connections
218IF-01	PORT (RS-232C)	Not supported	–
	10Base-T (218IF)	Not supported	–
218IF-02	PORT (RS-232C)	Not supported	–
	Ethernet (218IFB)	Not supported	–
217IF-01	PORT (RS-232C)	Not supported	–
	RS422 / 485	Not supported	–
260IF-01	PORT (RS-232C)	Not supported	–
	DeviceNet	Not supported	–
261IF-01	PORT (RS-232C)	Not supported	–
	PROFIBUS	Not supported	–
215AIF-01	CN1 (CP-215)	Not supported	–
	CN2 (RS-232C)	Not supported	–
CPU-301 (16 axes) CPU-301 (32 axes) CPU-302 (16 axes) CPU-302 (32 axes) CPU-201 CPU-202	Ethernet (218IFD)	Supported	2



Important

- I/O message communications is one-to-one communications.
When using Communications protocol type: Extended MEMOBUS to communicate with an MP-series Controller, you can only read and write hold registers.
When communicating with multiple remote devices or when you need to perform any operations other than reading and writing to hold registers, such as reading the states of coils and input relays, and changing the states of coils, use the send message functions (SND functions).
- In I/O message communications, a message is transmitted from separate ports if registers are both read and written. Therefore, the connected remote device must have two connections to receive both messages. (Excluding the OMRON FINS protocol.)
Changes made to the communications or connection parameters will become effective only after the changes have been saved to flash memory and the power supply has been cycled.
- The read data and write data in I/O message communications is updated by the I/O service of the high-speed scan or low-speed scan. Updates are performed asynchronously with Ethernet communications. Due to differences between the scan cycle and the cycle of message communications on the communications path, all of the output data may not be sent to the Ethernet communications path or all of the received data may not be reflected in the input data.

2.3 Message Functions

Use the message functions when the MP3000 requires a communications program.

The MSG-SNDE and MSG-RCVE functions have been newly added to the MP3000 in addition to the MSG-SND and MSG-RCV functions.

The MSG-SND and MSG-RCV functions are available for backward compatibility so that MP2000-series communications programs can be used without modifications.

The MSG-SNDE and MSG-RCVE functions support the extended registers in the MP3000 and access (R/W) to those extended registers.

The following table shows the message functions and applicable registers.

Register Name	MSG-SNDE and MSG-RCVE Instructions		MSG-SND and MSG-RCV Instructions	
	Register Range	Access	Register Range	Access
System Registers	SW00000 to SW65534	RW	–	–
Data Registers	GW000000 to GW2097151	RW	–	–
Output Registers	OW00000 to OW27FFF	RW	–	–
Hold Registers	MW0000000 to MW1048575	RW	MW000000 to MW0065534	RW
Input Registers	IW00000 to IW27FFF	R	IW00000 to IW0FFFF	R

Note: R: Read-only, RW: Readable/Writable

2.3.1 MSG-SNDE Function

This function is the same as the MSG-SND function, but it supports the extended registers in the MP3000 and access (R/W) to those extended registers.

Inputs and Outputs for the MSG-SNDE Function

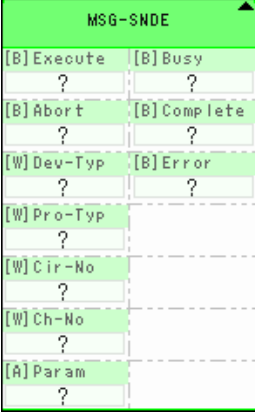
Function Name	MSG-SNDE			
Function	Sends a message to a remote station on the specified circuit of the communications device type. This function can be used with various protocols.			
Function Definition				
I/O Definitions	No.	Name	I/O Designation	Meaning
Input Items	1	Execute	B-VAL	Executes the transmission.
	2	Abort	B-VAL	Forces the transmission to end.
	3	Dev-Typ	I-REG	Communications device type RS232C/422/485 (217IF) = 5, Ethernet (218IF) = 6, Ethernet (218IFB, 218IFD) = 16
	4	Pro-Typ	I-REG	Communications protocol MEMOBUS = 1, No-protocol communications 1 = 2, No-protocol communications 2 = 3
	5	Cir-No	I-REG	Circuit number RS232C/422/485 (217IF) = 1 to 16, Ethernet (218IF) = 1 to 8, Ethernet (218IFB, 218IFD) = 1 to 8
	6	Ch-No	I-REG	Communications buffer channel number RS232C/422/485 (217IF) = 1, Ethernet (218IF) = 1 to 10, Ethernet (218IFB, 218IFD) = 1 to 10
	7	Param	Address Input	First address of parameter list (MA, DA)
Output Items	1	Busy	B-VAL	Processing.
	2	Complete	B-VAL	Process completed.
	3	Error	B-VAL	Error occurred.

◆ Execute

Specify the bit to use to execute the message transmission.

When the Execute Bit turns ON, the message will be sent.

Information Keep the Execute Bit ON until the Complete or Error Bit turns ON. To send another message, turn OFF the Execute Bit for at least one scan and then turn it ON again.

◆ **Abort**

Specify the bit to use to abort the message transmission.

When the Abort Bit turns ON, the message transmission will be stopped unconditionally. The Abort Bit takes precedence over the Execute Bit.

◆ **Dev-Typ (Communications Device Type)**

Specify the type code of the communications device.

Communications Device	Type Code
RS232C/422/485 (217IF)	5
Ethernet (218IF)	6
Ethernet (218IFB, 218IFD)	16

◆ **Pro-Typ (Communications Protocol)**

Specify the type code of the communications protocol.

Type Code	Communications Protocols	Remarks
1	MEMOBUS	Select this type code when using the MEMOBUS message communications method. MEMOBUS is automatically converted to the various communications protocols inside the 218IFD.
2	No-protocol communications 1 (unit: words)	This type code is not used with the MEMOBUS message communications method.
3	No-protocol communications 2 (unit: bytes)	This type code is not used with the MEMOBUS message communications method.

◆ **Cir-No (Circuit Number)**

Specify the circuit number for the communications device.

Specify the same circuit number as displayed in the MPE720 Module Configuration Definition Tab Page.

02 218IFD		----		Circuit No1	1	----	<input type="checkbox"/> Input <input type="checkbox"/> OutPut	0000 - 07FF[H]	2048
03 SVC32		----		Circuit No1	1	8000 - 87FF[H]	<input type="checkbox"/> Input <input type="checkbox"/> OutPut	0800 - 0BFF[H]	1024
04 SVR32		----		Circuit No3	1	9000 - 97FF[H]	----- -----	-----	-----

The following table gives the valid circuit numbers.

Communications Device	Valid Circuit Numbers
RS232C/422/485 (217IF)	1 to 16
Ethernet (218IF)	1 to 8
Ethernet (218IFB, 218IFD)	1 to 8

◆ **Ch-No (Communications Buffer Channel Number)**

Specify the channel number of the communications buffer.

You can specify any channel number provided it is within the valid range.

Information When executing more than one function at the same time, do not use the same channel number for the same connection. You can use the same channel number as long as multiple functions are not executed at the same time.

The following table gives the valid channel numbers.

Communications Device	Valid Channel Numbers
RS232C/422/485 (217IF)	1
Ethernet (218IF)	1 to 10
Ethernet (218IFB, 218IFD)	1 to 10

If the communications device is the 218IFD, there are 10 channels of communications buffers available for both transmission and reception. Therefore, 10 connections may be used for sending and receiving at the same time by using channels 1 to 10.

Information There must be as many MSG-SNDE or MSG-RCVE functions as the number of connections used at the same time.

◆ Param (First Address of Parameter List)

Specify the first address of the parameter list.

A total of 29 words starting from the specified first word are automatically used for the parameter list. The parameter list is used by inputting function codes and relevant parameter data. It is also where the process results and status are output.

Example A parameter list with the first address set to DA00000 is shown below.

Registers	Parameter List
F 0
DW00000	PARAM00
DW00001	PARAM01
DW00002	PARAM02
DW00003	PARAM03
DW00004	PARAM04
DW00005	PARAM05
DW00006	PARAM06
DW00007	PARAM07
⋮	⋮
DW00023	PARAM23
DW00024	PARAM24
DW00025	PARAM25
DW00026	PARAM26
DW00027	PARAM27
DW00028	PARAM28

◆ Busy

Specify the bit that shows that the message transmission is in progress.

The Busy Bit is ON while a message transmission or abort is in progress.

Keep the Execute Bit or Abort Bit turned ON while the Busy Bit is ON.

◆ Complete

Specify the bit that shows when the message transmission has been completed.

The Complete Bit turns ON only for one scan when message transmission or forced abort processing has been completed normally.

◆ Error

Specify the bit that shows if an error occurred when sending the message. When an error occurs, the Error Bit will turn ON only for one scan.

The following diagrams show timing charts for the bit I/O items in the MSG-SNDE function.

• Normal Execution

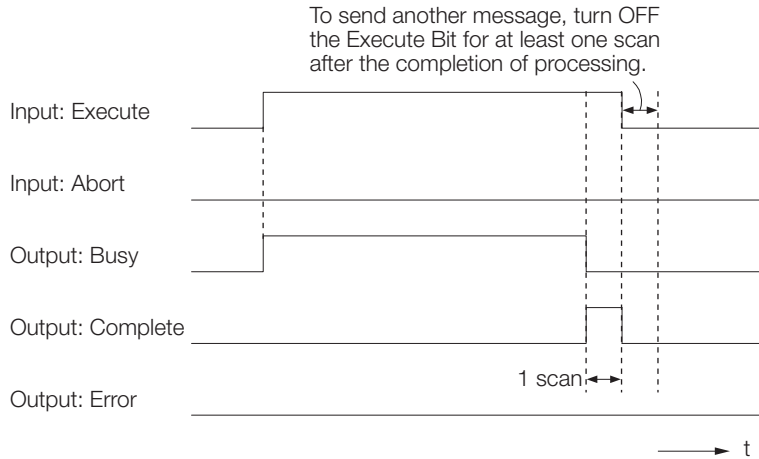

• When Execution Is Aborted

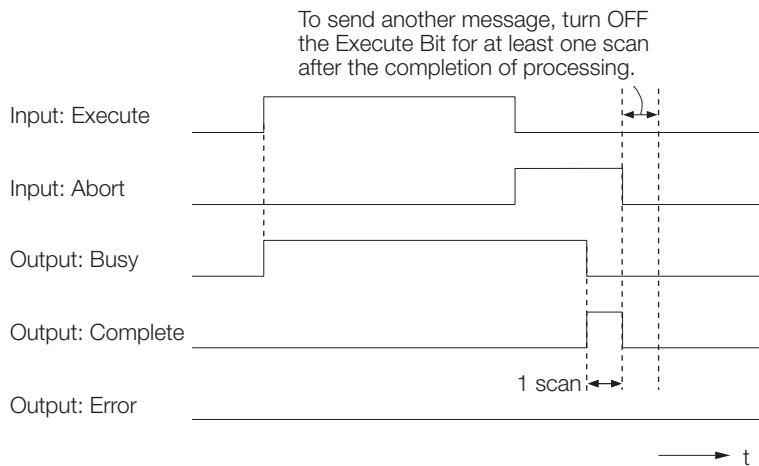

• Execution When an Error Occurs

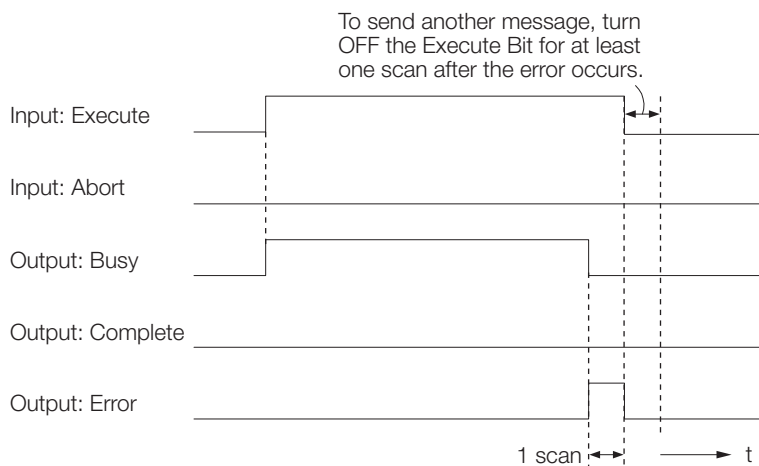

MSG-SNDE Function Parameters

The following table describes the contents of the addresses specified by the PARAM input parameter to the MSG-SNDE function.

No.	I/O	Meaning	Description	
00	Out-puts	Processing Result	Gives the processing status.	
01		Status	Gives the status of the current function.	
02		Detail Error Code, Lower Word*	The content that is given depends on the communications medium.	
03		Detail Error Code, Upper Word*		
04		Status 1*		
05		Status 2*		
06		Status 3*		
07		Status 4*		
08		Status 5*		
09		Status 6		
10	Inputs	Connection Number	Specifies the remote station.	
11		Option	Optional function. The content depends on the communications medium or protocol.	
12		Function Code	Sets the function code for the function associated with reading or writing.	
13		Reserved for system.	–	
14		Remote Station Data Address, Lower Word	Sets the data address to read/write at the remote station. (Use word addresses for registers, bit addresses for relays or coils.)	
15		Remote Station Data Address, Upper Word		
16		Remote Station Register Type	Sets the register type to read/write at the remote station.	
17		Data Size	Sets the size of the data to read/write. (Use word sizes for registers, bit sizes for relays or coils.)	
18		Remote CPU Module Number	Sets the CPU number at the remote station.	
19		Reserved for system.	–	
20		Local Station Data Address, Lower Word	Sets the data address to store read/write data in the local station. (Use word addresses for registers, bit addresses for relays or coils.)	
21		Local Station Data Address, Upper Word		
22		Local Station Register Type	Sets the register type of the read/write data to store in the local station.	
23		Reserved for system.	–	
24		–	For system use	–
25			Reserved for system.	–
26			Reserved for system.	–
27			Reserved for system.	–
28	Reserved for system.		–	

* The content for Status No. 2 to No. 8 functions on the 218IFD only.

◆ Processing Result (PARAM00)

This parameter gives the processing result.

Processing Result Value	Meaning
00□□ hex	Busy
10□□ hex	Complete
8y□□ hex	Error

Note: The lower byte is used for system analysis.

Refer to the following section for details on errors.

 ◆ Detail Error Code (PARAM02 and PARAM03) on page 2-11

◆ **Status (PARAM01)**

This parameter gives the status of the communications device.

The following figure shows the bit assignments and it is followed by a detailed description of each assignment.

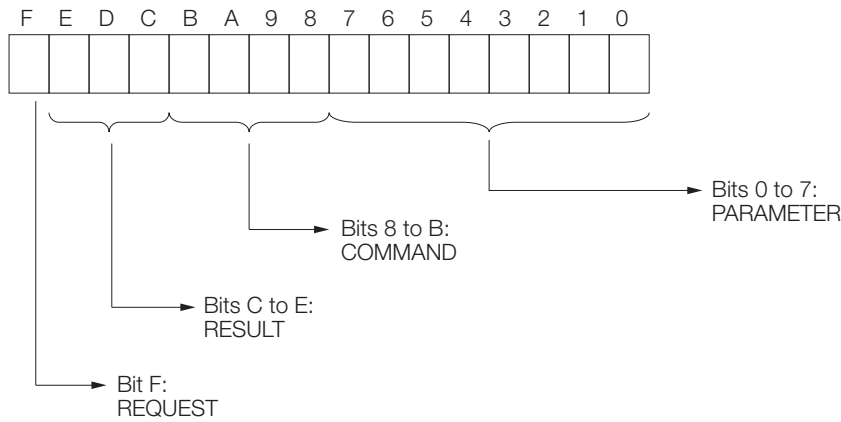

■ **REQUEST**

This bit gives the status of the processing request for the MSG-SNDE function.

Bit Status	Meaning
1	Processing is being requested.
0	Processing request has ended.

■ **RESULT**

These bits give the execution result of the MSG-SNDE function.

Code	Abbreviation	Meaning
0	CONN_NG	The message send failed or connection ended with an error in Ethernet communications.
1	SEND_OK	The message was sent normally.
2	REC_OK	The message was received normally.
3	ABORT_OK	The request to abort execution was completed.
4	FMT_NG	A parameter formatting error occurred.
5	SEQ_NG	A command sequence error occurred.
6	RESET_NG	A reset occurred.
7	REC_NG	A data reception error (error detected in the lower-layer program) occurred.

■ **COMMAND**

These bits indicate the processing command of the MSG-SNDE function.

Code	Abbreviation	Meaning
1	U_SEND	General-purpose message transmission (for no-protocol communications)
2	U_REC	General-purpose message reception (for no-protocol communications)
3	ABORT	Forced abort
8	M_SEND	MEMOBUS command transmission: Completed when response is received.
9	M_REC*	MEMOBUS command reception
C	MR_SEND*	MEMOBUS response transmission

* MR_SEND is executed after M_REC is executed.

■ PARAMETER

When RESULT = 4 (FMT_NG: parameter formatting error), these bits will indicate an error code from the following table. For any other value, the bits will contain the connection number.

RESULT	Code (Hex)	Meaning
When RESULT = 4 (FMT_NG: Parameter Formatting Error)	00	No error
	01	Connection number out of range
	02	Watchdog error for MEMOBUS response
	03	Error in number of retries setting
	04	Error in cyclic area setting
	05	CPU number error
	06	Data address error
	07	Data size error
	08	Function code error
Others	□□	Connection number

◆ Detail Error Code (PARAM02 and PARAM03)

These parameters give the detail error code.

Processing Result Value (PARAM00)	Detail Error Code	Error Description	Description
81□□ hex	1	Function code error	An unused function code was sent or received. Check PARAM12 (Function Code).
82□□ hex	2	Address setting error	The setting of one or more of the following parameters is out of range. Check the settings. PARAM14 and PARAM15 (Remote Station Data Address) PARAM20 and PARAM21 (Local Station Data Address)
83□□ hex	3	Data size error	The data size for sending or receiving is out of range. Check PARAM17 (Data Size).
84□□ hex	4	Circuit number setting error	The circuit number is out of range. Check the circuit number (Cir-No) in the MSG-SNDE function.
85□□ hex	5	Channel number setting error	The channel number for the communications buffer is out of range. Check the communications buffer channel number (Ch-No) in the MSG-SNDE function.
86□□ hex	6	Connection number error	The connection number is out of range. Check PARAM10 (Connection Number).
88□□ hex	7	Data reception error	An error response was received from the communications device. Check the connections to the device. Also check to see if the remote device is ready to communicate.
	8	Data sending error	
	10 hex	Connection error	
89□□ hex	9	Device select error	A device that cannot be used was selected. Check the communications device type (Dev-Typ) in the MSG-SNDE function.
8A□□ hex	0 to FF	Remote node error	A node error response was returned from the remote station. Check the error code and remove the cause.
C0□□ hex	40 hex	Register type error	The register type for the remote station is out of range. Check PARAM16 (Remote Station Register Type).
C1□□ hex	41 hex	Data type error	The data type is out of range. Check the address table at the remote station. (This error occurs when using function code 434D hex or 434E hex.)
C2□□ hex	42 hex	Local station register type error	The register type for the local station is out of range. Check PARAM22 (Local Station Register Type).

◆ Status 1 (PARAM04)

This parameter gives status information.

The status content depends on the communications medium of each Communications Module. If 218IFD is specified for the communications device, this parameter represents the communications status. The values in the following table are obtained from the parameter. This parameter can be used only if the communications device is 218IFD.

Status 1 Value	Meaning	Description
1	IDLE	The connection is idle.
2	WAIT	The connection is waiting to be made.
3	CONNECT	The connection is established.
–	–	–

Note: The status is updated when the function is executed in each scan.

◆ Status 2 (PARAM05)

This parameter gives information on the most recent error.

This parameter can be used only if the communications device is 218IFD.

Status 2 Value	Meaning	Description
0	No error	Normal
1	Socket creation error	A socket could not be created.
2	Local port number error	Setting error in local station port number
3	Changing socket attribute error	A system error occurred while setting the socket attribute.
4	Connection error	M-SND: The remote station rejected an attempt to open a TCP connection.
5	Connection error	M-RCV: An error occurred while passively opening a TCP connection.
6	System error	A socket polling error occurred while receiving data.
7	TCP data send error	The remote station does not exist.
8	UDP data send error	The data send request command was sent to a socket that does not exist.
9	TCP data receive error	A disconnection request was received from the remote station.
10	UDP data receive error	A data receive request was executed for a socket that does not exist.
11	Changing socket option error	A system error occurred while changing the socket options.
12	Data conversion error	Error in protocol conversion

Note: The status is updated when the function is executed in each scan.

◆ Status 3 (PARAM06)

This parameter gives the value of the send pass counter.

This parameter can be used only if the communications device is 218IFD.

Status 3 Value	Meaning	Description
0 to 65535	Send count	Counts the number of times a message was sent.

Note: The status is updated when the function is executed in each scan.

◆ Status 4 (PARAM07)

This parameter gives the value of the receive pass counter.

This parameter can be used only if the communications device is 218IFD.

Status 4 Value	Meaning	Description
0 to 65535	Receive count	Counts the number of times a message was received.

Note: The status is updated when the function is executed in each scan.

◆ Status 5 (PARAM08)

This parameter gives the value of the error counter.

This parameter can be used only if the communications device is 218IFD.

Status 5 Value	Meaning	Description
0 to 65535	Error count	Counts the number of errors that occurred during message processing.

Note: The status is updated when the function is executed in each scan.

◆ Status 6 (PARAM09)

This parameter gives status information about the Communications Module.

The status information depends on the communications medium.

The status information is updated when the function is executed in each scan.

◆ Connection Number (PARAM10)

Specify the remote station.

If the communications device is Ethernet, enter the connection number.

If the communications device is a serial device, enter the remote station number.

The setting range is given in the following table.

Communications Device	Connection Number	Description
Serial (217IF)	0	Sends the message to all stations (broadcast).
	1 to 254	Sends the message to the remote station set by the specified station number.
Ethernet (218IF, 218IFB, 218IFD)	1 to 20	Sends the message to the remote station set by the specified connection number.

Note: Enter the same connection number as displayed in the Detail Definition Dialog Box for communications device in the MPE720.

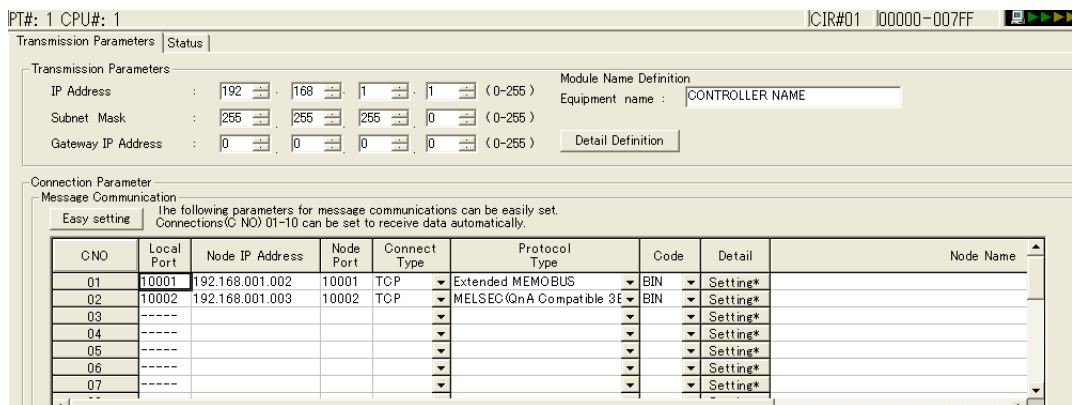

◆ Options (PARAM11)

Set the communications medium or protocol-specific function.

◆ Function Code (PARAM12)

Set the function code to send.

You can use the functions that are registered to the function codes.

Function codes that can be used depend on the communications medium or protocol.

Function Code	Target Data Type	Function	Registers When Acting as the Master	
			Send Registers	Receive Registers
00 hex	–	Not used	M	M
01 hex	B	Reads the states of coils.		
02 hex	B	Reads the states of input relays.		
03 hex	W	Reads the contents of hold registers.		
04 hex	W	Reads the contents of input registers.		
05 hex	B	Changes the state of a single coil.		
06 hex	W	Writes to a single hold register.		
07 hex	–	Not used		
08 hex	–	Performs a loopback test.		
09 hex	W	Reads the contents of hold registers (extended).		
0A hex	W	Reads the contents of input registers (extended).		
0B hex	W	Writes to hold registers (extended).		
0C hex	–	Not used		
0D hex	W	Reads the contents of non-consecutive hold registers (extended).		
0E hex	W	Writes the contents of non-consecutive hold registers (extended).		
0F hex	B	Changes the states of multiple coils.		
10 hex	W	Writes to multiple hold registers.		
4341 hex	B	Reads the states of bits.	S, M, G, I, or O	M or G
4345 hex	B	Changes the state of a single bit.		
4346 hex	W	Writes to a single register.		
4349 hex	W	Reads the contents of registers.		
434B hex	W	Writes to multiple registers.		
434D hex	W	Reads the contents of non-consecutive registers.		
434E hex	W	Writes the contents of non-consecutive registers.		
434F hex	B	Changes the states of multiple bits.		

Note: B: Bit data, W: Integer data

◆ Reserved for System (PARAM13)

This parameter is used by the system.

Information Do not change the value of PARAM13 from a user program or by any other means.

◆ Remote Station Data Address (PARAM14 and PARAM15)

Set the first address for data in the remote station.

Enter the first address as a decimal or hexadecimal number.

Example If the first address is MW01000, enter “1000” (decimal) or “3E8” (hexadecimal).

Function Code	Target Data Type	Function	Data Address Setting Range
00 hex	–	Not used	Disabled.
01 hex	B	Reads the states of coils. ^{*1}	0 to 65535 (0 to FFFF hex)
02 hex	B	Reads the states of input relays. ^{*1}	0 to 65535 (0 to FFFF hex)
03 hex	W	Reads the contents of hold registers. ^{*2}	0 to 65534 (0 to FFFE hex)
04 hex	W	Reads the contents of input registers. ^{*2}	0 to 65535 (0 to FFFF hex)
05 hex	B	Changes the state of a single coil. ^{*1}	0 to 65535 (0 to FFFF hex)
06 hex	W	Writes to a single hold register. ^{*2}	0 to 65534 (0 to FFFE hex)
07 hex	–	Not used	Disabled.
08 hex	–	Performs a loopback test.	Disabled.
09 hex	W	Reads the contents of hold registers (extended). ^{*2}	0 to 65534 (0 to FFFE hex)
0A hex	W	Reads the contents of input registers (extended). ^{*2}	0 to 65535 (0 to FFFF hex)
0B hex	W	Writes to hold registers (extended). ^{*2}	0 to 65534 (0 to FFFE hex)
0C hex	–	Not used	Disabled.
0D hex	W	Reads the contents of non-consecutive hold registers (extended). ^{*3}	0 to 65534 (0 to FFFE hex)
0E hex	W	Writes the contents of non-consecutive hold registers (extended). ^{*3}	0 to 65534 (0 to FFFE hex)
0F hex	B	Changes the states of multiple coils. ^{*1}	0 to 65535 (0 to FFFF hex)
10 hex	W	Writes to multiple hold registers. ^{*2}	0 to 65534 (0 to FFFE hex)
4341 hex	B	Reads the states of bits. ^{*1}	0 to 4294967295 (0 to FFFFFFFF hex) Adjust the address to the remote device's address range.
4345 hex	B	Changes the state of a single bit. ^{*1}	
4346 hex	W	Writes to a single register. ^{*2}	
4349 hex	W	Reads the contents of registers. ^{*2}	
434B hex	W	Writes to multiple registers. ^{*2}	
434D hex	W	Reads the contents of non-consecutive registers. ^{*3}	
434E hex	W	Writes the contents of non-consecutive registers. ^{*3}	
434F hex	B	Changes the states of multiple bits. ^{*1}	

*1. Coil or input relay read/write requests: Enter the address of the first bit of the data.

*2. Continuous register read/write requests: Enter the address of the first word of the data.

*3. Non-consecutive register read/write requests: Enter the address of the first M register of the address table.

◆ Remote Station Register Type (PARAM16)

Set the register type in the remote station. This parameter is valid when using function codes 43□□ hex.

Enter the register type as a decimal or hexadecimal number.

Register Type Value	Type	Remarks
0	M	Sets the target data type to MB for bits and MW for words.
1	G	Sets the target data type to GB for bits and GW for words.
2	I	Sets the target data type to IB for bits and IW for words.
3	O	Sets the target data type to OB for bits and OW for words.
4	S	Sets the target data type to SB for bits and SW for words.
5 or higher	–	Not used

The register types that can be used depend on whether you are reading or writing.

The following table lists the combinations of register types.

Function Code	Applicable Register Types
01, 02, 03, 04, 05, 06, 09, 0A, 0B, 0D, 0E, 0F, 10, 31, 32, or 33 hex	The data type is not valid. The remote station register is determined by the function code.
4341 or 4349 hex	The contents of the M, G, I, O, and S registers in the remote station can be read.
4345, 4346, 434B, or 434F hex	The contents of the M, G, O, and S registers in the remote station can be written.
434D hex*	The address table at the remote station can be stored in M and G registers in the local station.
434E hex*	The address table at the remote station can be stored in M and G registers in the local station.
No-protocol communications (No function code)	The data type is not valid. The remote station writes to the M registers.

* The address table at the remote station is stored in registers in the local station. The contents of the M, G, I, O, and S registers in the remote station can be read by specifying the register type in the address table at the remote station.

◆ Data Size (PARAM17)

Set the data size for the read/write request as the number of bits or words.

Be sure that the last data address that is determined by the offset, data address, and data size does not exceed the valid data address range.

The range that is allowed for the data size depends on the function code and data area.

Function Code	Target Data Type	Function	Data Size Setting Range
00 hex	–	Not used	Disabled.
01 hex	B	Reads the states of coils.	1 to 2000
02 hex	B	Reads the states of input relays.	1 to 2000
03 hex	W	Reads the contents of hold registers.	1 to 125
04 hex	W	Reads the contents of input registers	1 to 125
05 hex	B	Changes the state of a single coil.	Disabled.
06 hex	W	Writes to a single hold register.	Disabled.
07 hex	–	Not used	Disabled.
08 hex	–	Performs a loopback test.	Disabled.
09 hex	W	Reads the contents of hold registers (extended).	1 to 2044 (BIN) 1 to 1020 (ASCII)
0A hex	W	Reads the contents of input registers (extended).	1 to 2044 (BIN) 1 to 1020 (ASCII)
0B hex	W	Writes to hold registers (extended).	1 to 2043 (BIN) 1 to 1019 (ASCII)

Continued on next page.

Continued from previous page.

Function Code	Target Data Type	Function	Data Size Setting Range
0C hex	–	Not used	Disabled.
0D hex	W	Reads the contents of non-consecutive hold registers (extended).	1 to 2044 (BIN) 1 to 1020 (ASCII)
0E hex	W	Writes the contents of non-consecutive hold registers (extended).	1 to 1022 (BIN) 1 to 510 (ASCII)
0F hex	B	Changes the states of multiple coils.	1 to 800
10 hex	W	Writes to multiple hold registers.	1 to 100
4341 hex	B	Reads the states of bits.	1 to 32704
4345 hex	B	Changes the state of a single bit.	Disabled.
4346 hex	W	Writes to a single register.	Disabled.
4349 hex	W	Reads the contents of registers.	1 to 2044
434B hex	W	Writes to multiple registers.	1 to 2041
434D hex	W	Reads the contents of non-consecutive registers.	1 to 681
434E hex	W	Writes the contents of non-consecutive registers.	1 to 511
434F hex	B	Changes the states of multiple bits.	1 to 32640

Note: 1. The data sizes in the table are in decimal notation.

2. B: Bit data, W: Integer data

◆ Remote CPU Module Number (PARAM18)

Set the CPU Module number at the remote station.

Specify 1 if the remote device is an MP2000/MP3000-series Controller.

If the remote device is a Yaskawa Controller that is not part of the MP2000/MP3000-series and it is comprised of multiple CPU Modules, specify the destination CPU Module number.

For all other devices, specify 0.

◆ Reserved for System (PARAM19)

This parameter is used by the system.

Information Do not change the value of PARAM19 from a user program or by any other means.

◆ Local Station Data Address (PARAM20 and PARAM21)

Set the address of the read data destination or write data source in the MP3000.

The address is set as the word offset from address 0.

Function Code	Target Data Type	Function	Data Address Setting Range
00 hex	–	Not used	0 to 4294967295 (0 to FFFFFFFF hex) Specify the address within the address range of the registers specified in Local Station Register Type (PARAM22).
01 hex	B	Reads the states of coils.* ¹	
02 hex	B	Reads the states of input relays.* ¹	
03 hex	W	Reads the contents of hold registers.* ²	
04 hex	W	Reads the contents of input registers.* ²	
05 hex	B	Changes the state of a single coil.* ¹	
06 hex	W	Writes to a single hold register.* ²	
07 hex	–	Not used	
08 hex	–	Performs a loopback test.	
09 hex	W	Reads the contents of hold registers (extended).* ²	
0A hex	W	Reads the contents of input registers (extended).* ²	
0B hex	W	Writes to hold registers (extended).* ²	
0C hex	–	Not used	
0D hex	W	Reads the contents of non-consecutive hold registers (extended).* ³	
0E hex	W	Writes the contents of non-consecutive hold registers (extended).* ³	
0F hex	B	Changes the states of multiple coils.* ¹	
10 hex	W	Writes to multiple hold registers.* ²	
31 hex	W	Fixed buffer communications* ²	
32 hex	W	Random access buffer communications (read)* ²	
33 hex	W	Random access buffer communications (write)* ²	
4341 hex	B	Reads the states of bits.* ¹	
4345 hex	B	Changes the state of a single bit.* ¹	
4346 hex	W	Writes to a single register.* ²	
4349 hex	W	Reads the contents of registers.* ²	
434B hex	W	Writes to multiple registers.* ²	
434D hex	W	Reads the contents of non-consecutive registers.* ⁴	
434E hex	W	Writes the contents of non-consecutive registers.* ⁵	
434F hex	B	Changes the states of multiple bits.* ¹	

*1. Coil or input relay read/write requests: Enter the address of the first bit of the data.

*2. Continuous register read/write requests: Enter the address of the first word of the data.

*3. Non-consecutive register read/write requests: Enter the offset address of the local station storage destination.

*4. Non-consecutive register read: Enter the address of the first word of the local station storage destination.

*5. Non-consecutive register write: Enter the first address of the local station address table that contains the storage destination of the write data.

◆ Local Station Register Type (PARAM22)

Set the register type of the read data destination or write data source in the MP3000.

Register Type Value	Type	Remarks
0	M	Sets the target data type to MB for bits and MW for words.
1	G	Sets the target data type to GB for bits and GW for words.
2	I	Sets the target data type to IB for bits and IW for words.
3	O	Sets the target data type to OB for bits and OW for words.
4	S	Sets the target data type to SB for bits and SW for words.
5 or higher	–	Not used for the Extended MEMOBUS protocol.

The register types that can be used depend on whether you are reading or writing.

The following table lists the combinations of register types.

Function Code	Applicable Register Types
01, 02, 03, 04, 09, or 0A hex	The data that was read can be stored in M, G, and O registers in the local station.
05, 06, 0B, 0F, or 10 hex	The data stored in M, G, I, O, and S registers in the local station can be read and written to the remote station.
0D hex	The local station data type is not valid. The read data is stored in M registers.
0E hex	The local station data type is not valid. The data stored in M registers can be read and written to the remote station.
4341 or 4349 hex	The data that was read can be stored in M, G, and O registers in the local station.
4345, 4346, 434B, or 434F hex	The data stored in M, G, I, O, and S registers in the local station can be read and written to the remote station.
434D hex	The data that was read can be stored in M and G registers in the local station.
434E hex*	The data address table to write can be stored in M and G registers in the local station.
No-protocol communications (No function code)	The data stored in M, G, I, O, and S registers in the local station can be read and written to the remote station.

* You can store the write data address table in registers in the local station. The data stored in the M, G, I, O, and S registers in the local station can be read from or written to the remote station by specifying the register type in the write data address table.

◆ Reserved for System (PARAM23)

This parameter is used by the system.

Information Do not change the value of PARAM23 from a user program or by any other means.

◆ Reserved for System (PARAM24)

This parameter is used by the system. It contains the channel number of the communications buffer that is currently in use.

Information A user program must set PARAM24 to 0 on the first scan after startup. Thereafter, do not change the value of PARAM24 from a user program or by any other means. PARAM24 will be used by the system.

◆ Reserved for System (PARAM25 to PARAM28)

These parameters are used by the system.

Information Do not change the value of PARAM25 to PARAM28 from a user program or by any other means.

2.3.2 MSG-RCVE Function

This function is the same as the MSG-RCV function, but it supports the extended registers in the MP3000 and access (R/W) to those extended registers.

Inputs and Outputs for the MSG-RCVE Function

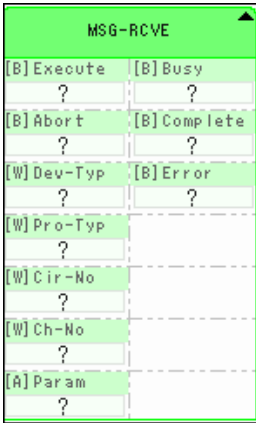
Function Name	MSG-RCVE			
Function	Receives a message from a remote station on the specified circuit of the communications device type. This function can be used with various protocols.			
Function Definition				
I/O Definitions	No.	Name	I/O Designation	Meaning
Input Items	1	Execute	B-VAL	Executes the reception.
	2	Abort	B-VAL	Forces the reception to end.
	3	Dev-Typ	I-REG	Communications device type RS232C/422/485 (217IF) = 5, Ethernet (218IF) = 6, Ethernet (218IFB, 218IFD) = 16
	4	Pro-Typ	I-REG	Communications protocol MEMOBUS = 1, No-protocol communications 1 = 2, No-protocol communications 2 = 3
	5	Cir-No	I-REG	Circuit number RS232C/422/485 (217IF) = 1 to 16, Ethernet (218IF) = 1 to 8, Ethernet (218IFB, 218IFD) = 1 to 8
	6	Ch-No	I-REG	Communications buffer channel number RS232C/422/485 (217IF) = 1, Ethernet (218IF) = 1 to 10, Ethernet (218IFB, 218IFD) = 1 to 10
	7	Param	Address input	First address of parameter list (MA, DA)
Output Items	1	Busy	B-VAL	Processing.
	2	Complete	B-VAL	Process completed.
	3	Error	B-VAL	Error occurred.

◆ Execute

Specify the bit to use to execute the message reception.

When the Execute Bit turns ON, the message will be received.

◆ Abort

Specify the bit to use to abort the message reception.

When the Abort Bit turns ON, the message reception will be stopped unconditionally. The Abort Bit takes precedence over the Execute Bit.

◆ Dev-Typ (Communications Device Type)

Specify the type code of the communications device.

Device	Type Code
RS232C/422/485 (217IF)	5
Ethernet (218IF)	6
Ethernet (218IFB, 218IFD)	16

◆ Pro-Typ (Communications Protocol)

Specify the type code of the communications protocol.

Type Code	Communications Protocols	Remarks
1	MEMOBUS	Select this type code when using the MEMOBUS message communications method. MEMOBUS is automatically converted to the various communications protocols inside the 218IFD.
2	No-protocol communications 1 (unit: words)	This type code is not used with the MEMOBUS message communications method.
3	No-protocol communications 2 (unit: bytes)	This type code is not used with the MEMOBUS message communications method.

◆ Cir-No (Circuit Number)

Specify the circuit number for the communications device.

Specify the same circuit number as displayed in the MPE720 Module Configuration Definition Tab Page.

02 218IFD		----		Circuit No1	1	----	<input type="checkbox"/> Input <input type="checkbox"/> OutPut	0000 - 07FF[H]	2048
03 SVC32		----		Circuit No1	1	8000 - 87FF[H]	<input type="checkbox"/> Input <input type="checkbox"/> OutPut	0800 - 0BFF[H]	1024
04 SVR32		----		Circuit No3	1	9000 - 97FF[H]	----- -----	-----	-----

The following table gives the valid circuit numbers.

Communications Device	Valid Circuit Numbers
RS232C/422/485 (217IF)	1 to 16
Ethernet (218IF)	1 to 8
Ethernet (218IFB, 218IFD)	1 to 8

◆ **Ch-No (Communications Buffer Channel Number)**

Specify the channel number of the communications buffer.

You can specify any channel number provided it is within the valid range.

Information When executing more than one function at the same time, do not use the same channel number for the same connection. You can use the same channel number as long as multiple functions are not executed at the same time.

The following table gives the valid channel numbers.

Communications Device	Valid Channel Numbers
RS232C/422/485 (217IF)	1
Ethernet (218IF)	1 to 10
Ethernet (218IFB, 218IFD)	1 to 10

If the communications device is the 218IFD, there are 10 channels of communications buffers available for both transmission and reception. Therefore, 10 connections may be used for sending and receiving at the same time by using channels 1 to 10.

Information There must be as many MSG-RCVE or MSG-SNDE functions as the number of connections used at the same time.

◆ **Param (First Address of Parameter List)**

Specify the first address of the parameter list.

A total of 52 words starting from the specified first word are automatically used for the parameter list. The parameter list is used by inputting the connection number and relevant parameter data. It is also where the process results and status are output.

Example A parameter list with the first address set to DA00000 is shown below.

Registers	Parameter List
	F 0
DW00000	PARAM00
DW00001	PARAM01
DW00002	PARAM02
DW00003	PARAM03
DW00004	PARAM04
DW00005	PARAM05
DW00006	PARAM06
DW00007	PARAM07
⋮	⋮
DW00046	PARAM46
DW00047	PARAM47
DW00048	PARAM48
DW00049	PARAM49
DW00050	PARAM50
DW00051	PARAM51

◆ **Busy**

Specify the bit that shows that the message reception is in progress.

The Busy Bit is ON while a message reception or abort is in progress.

Keep the Execute Bit or Abort Bit turned ON while the Busy Bit is ON.

◆ **Complete**

Specify the bit that shows when the message reception has been completed.

The Complete Bit turns ON only for one scan when message reception or forced abort processing has been completed normally.

◆ **Error**

Specify the bit that shows if an error occurred when receiving the message.

When an error occurs, the Error Bit will turn ON only for one scan.

The following diagrams show timing charts for the bit I/O items in the MSG-RCVE function.

• Normal Execution

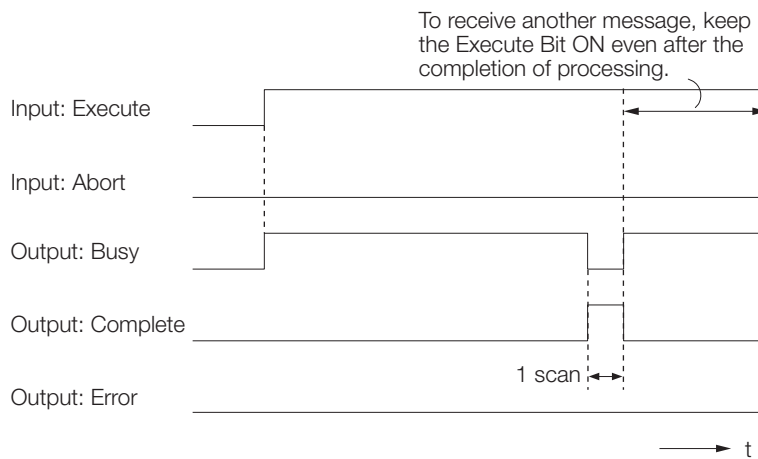

• When Execution Is Aborted

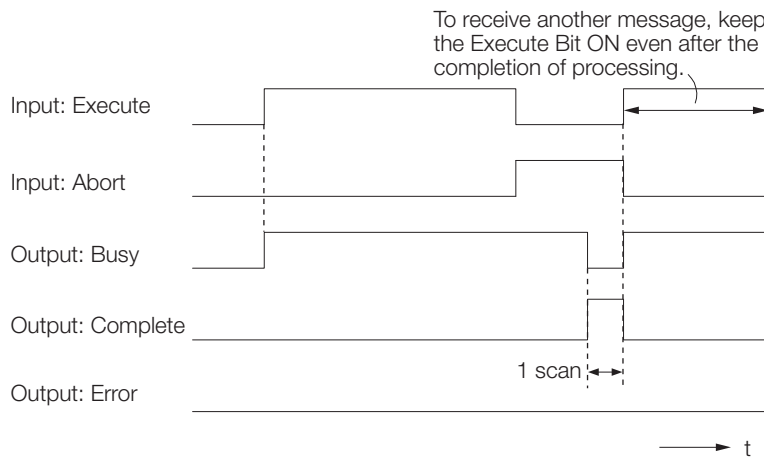

• Execution When an Error Occurs

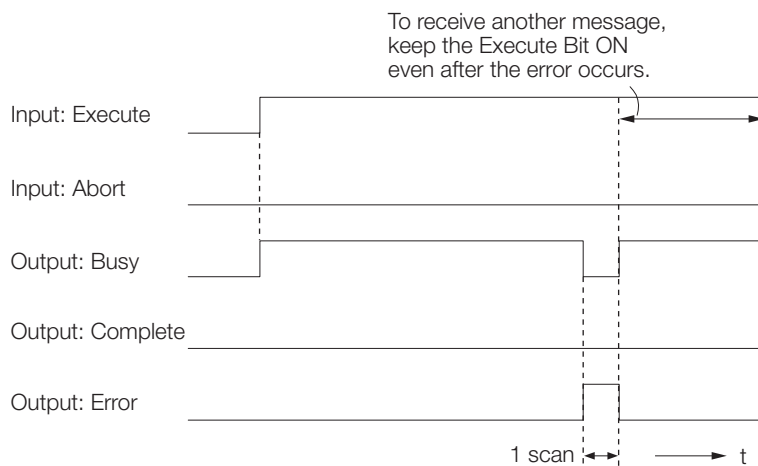

MSG-RCVE Function Parameters

The following table describes the contents of the addresses specified by the PARAM input parameter to the MSG-RCVE function.

No.	I/O	Meaning	Description
00	Out-puts	Processing Result	Gives the processing status.
01		Status	Gives the status of the current function.
02		Detail Error Code, Lower Word	The content that is given depends on the communications medium.
03		Detail Error Code, Upper Word	
04		Status 1	
05		Status 2	
06		Status 3	
07		Status 4	
08		Status 5	
09		Status 6	
10	I/O	Connection Number	Specifies the remote station.
11		Option	Optional function. The content depends on the communications medium or protocol.
12	Out-puts	Function Code	Gives the function associated with reading or writing that was received from the remote station as the function code.
13	I/O	Reserved for system.	–
14	Out-puts	Data Address, Lower Word	Gives the first address of the data that was requested by the remote station.
15		Data Address, Upper Word	
16		Register Type	Gives the register type that was requested by the remote station.
17		Data Size	Gives the data size that was requested by the remote station.
18		Remote CPU Module Number	Not used
19	I/O	Reserved for system.	–
20	Inputs	Coil Offset, Lower Word	Sets the offset word address for a coil (MB).
21		Coil Offset, Upper Word	
22		Input Relay Offset, Lower Word	Sets the offset word address for an input relay (IB).
23		Input Relay Offset, Upper Word	
24		Input Register Offset, Lower Word	Sets the offset word address for an input register (IW).
25		Input Register Offset, Upper Word	
26		Hold Register Offset, Lower Word	Sets the offset word address for a hold register (MW).
27		Hold Register Offset, Upper Word	
28		Data Relay Offset, Lower Word	Sets the offset word address for a data relay (GB).
29		Data Relay Offset, Upper Word	
30		Data Register Offset, Lower Word	Sets the offset word address for a data register (GW).
31		Data Register Offset, Upper Word	
32		Output Coil Offset, Lower Word	Sets the offset word address for an output coil (OB).
33		Output Coil Offset, Upper Word	
34		Output Register Offset, Lower Word	Sets the offset address for an output register (OW).
35		Output Register Offset, Upper Word	
36		M Register Writing Range LO, Lower Word	Sets the first address of the writing range for hold register coils.
37		M Register Writing Range LO, Upper Word	
38		M Register Writing Range HI, Lower Word	Sets the last address of the writing range for hold register coils.
39	M Register Writing Range HI, Upper Word		

Continued on next page.

Continued from previous page.

No.	I/O	Meaning	Description
40	Inputs	G Register Writing Range LO, Lower Word	Sets the first address of the writing range for data register data relays.
41		G Register Writing Range LO, Upper Word	
42		G Register Writing Range HI, Lower Word	Sets the last address of the writing range for data register data relays.
43		G Register Writing Range HI, Upper Word	
44		O Register Writing Range LO, Lower Word	Sets the first address of the writing range for output registers.
45		O Register Writing Range LO, Upper Word	
46		O Register Writing Range HI, Lower Word	Sets the last address of the writing range for output registers.
47		O Register Writing Range HI, Upper Word	
48	-	For system use	-
49	-	Reserved for system.	-
50	-	Reserved for system.	-
51	-	Reserved for system.	-

◆ Processing Result (PARAM00)

This parameter gives the processing result.

Processing Result Value	Meaning
00□□ hex	Busy
10□□ hex	Complete
8y□□ hex	Error

Note: The lower byte is used for system analysis.

Refer to the following section for details on errors.

🔗 ◆ Detail Error Code (PARAM02 and PARAM03) on page 2-27

◆ Status (PARAM01)

This parameter gives the status of the communications device.

The following figure shows the bit assignments and it is followed by a detailed description of each assignment.

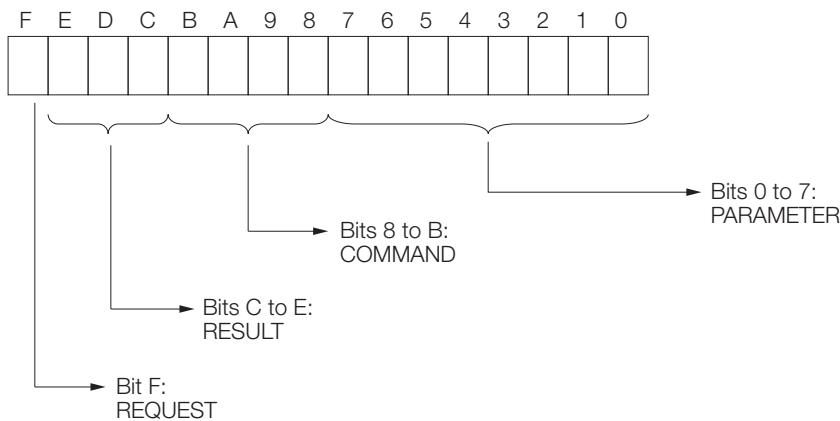

■ REQUEST

This bit gives the status of the processing request for the MSG-RCVE function.

Bit Status	Meaning
1	Processing is being requested.
0	Processing request has ended.

■ RESULT

These bits give the execution result of the MSG-RCVE function.

Code	Abbreviation	Meaning
0	CONN_NG	The message send failed or connection ended with an error in Ethernet communications.
1	SEND_OK	The message was sent normally.
2	REC_OK	The message was received normally.
3	ABORT_OK	The request to abort execution was completed.
4	FMT_NG	A parameter formatting error occurred.
5	SEQ_NG	A command sequence error occurred.
6	RESET_NG	A reset occurred.
7	REC_NG	A data reception error (error detected in the lower-layer program) occurred.

■ COMMAND

These bits indicate the processing command of the MSG-RCVE function.

Code (Hex)	Abbreviation	Meaning
1	U_SEND	General-purpose message transmission (for no-protocol communications)
2	U_REC	General-purpose message reception (for no-protocol communications)
3	ABORT	Forced abort
8	M_SEND	MEMOBUS command transmission: Completed when response is received.
9	M_REC*	MEMOBUS command reception
C	MR_SEND*	MEMOBUS response transmission

* MR_SEND is executed after M_REC is executed.

■ PARAMETER

When RESULT = 4 (FMT_NG: parameter formatting error), these bits will indicate an error code from the following table. For any other value, the bits will contain the connection number.

RESULT	Code (Hex)	Meaning
When RESULT = 4 (FMT_NG: Parameter Formatting Error)	00	No error
	01	Connection number out of range
	02	Watchdog error for MEMOBUS response
	03	Error in number of retries setting
	04	Error in cyclic area setting
	05	CPU number error
	06	Data address error
	07	Data size error
	08	Function code error
Others	□□	Connection number

◆ Detail Error Code (PARAM02 and PARAM03)

These parameters give the detail error code.

Processing Result Value (PARAM00)	Detail Error Code	Error Description	Description
81□□ hex	1	Function code error	An unused function code was received. Check the function code of the remote station
82□□ hex	2	Address setting error	The setting of one or more of the following parameters is out of range. Check the settings. PARAM14 and PARAM15 (Data Address) PARAM20 and PARAM21 (Coil Offset) PARAM26 and PARAM27 (Hold Register Offset)
83□□ hex	3	Data size error	The data size for receiving is out of range. Check the data size at the remote station.
84□□ hex	4	Circuit number setting error	The circuit number is out of range. Check the circuit number (Cir-No) in the MSG-RCVE function.
85□□ hex	5	Channel number setting error	The channel number for the communications buffer is out of range. Check the communications buffer channel number (Ch-No) in the MSG-RCVE function.
86□□ hex	6	Connection number error	The connection number is out of range. Check PARAM10 (Connection Number).
88□□ hex	7	Data reception error	An error response was received from the communications device. Check the connections to the device. Also check to see if the remote device is ready to communicate.
	8	Data sending error	
	10 hex	Connection error	
89□□ hex	9	Device select error	A device that cannot be used was selected. Check the communications device type (Dev-Typ) in the MSG-RCVE function.
C0□□ hex	40 hex	Register type error	The register type specified by the sending node is out of range. Check the remote station register type setting at the sending node.
C1□□ hex	41 hex	Data type error	The data type is out of range. Check the remote station address table at the sending node. (This error occurs when using function code 434D hex or 434E hex.)

◆ Status 1 (PARAM04)

This parameter gives status information.

This parameter can be used only if the communications device is 218IFD.

Status 1 Value	Meaning	Description
1	IDLE	The connection is idle.
2	WAIT	The connection is waiting to be made.
3	CONNECT	The connection is established.
-	-	-

◆ Status 2 (PARAM05)

This parameter gives information on the most recent error.

This parameter can be used only if the communications device is 218IFD.

Status 2 Value	Meaning	Description
0	No error	Normal
1	Socket creation error	A socket could not be created.
2	Local port number error	Setting error in local station port number
3	Changing socket attribute error	A system error occurred while setting the socket attribute.
4	Connection error	M-SND: The remote station rejected an attempt to open a TCP connection.
5	Connection error	M-RCV: An error occurred while passively opening a TCP connection.
6	System error	A socket polling error occurred while receiving data.
7	TCP data send error	The remote station does not exist.
8	UDP data send error	The data send request command was sent to a socket that does not exist.
9	TCP data receive error	A disconnection request was received from the remote station.
10	UDP data receive error	A data receive request was executed for a socket that does not exist.
11	Changing socket option error	A system error occurred while changing the socket options.
12	Data conversion error	Error in protocol conversion

◆ Status 3 (PARAM06)

This parameter gives the value of the send pass counter.

This parameter can be used only if the communications device is 218IFD.

Status 3 Value	Meaning	Description
0 to 65535	Send count	Counts the number of times a message was sent.

◆ Status 4 (PARAM07)

This parameter gives the value of the receive pass counter.

This parameter can be used only if the communications device is 218IFD.

Status 4 Value	Meaning	Description
0 to 65535	Receive count	Counts the number of times a message was received.

◆ Status 5 (PARAM08)

This parameter gives the value of the error counter.

This parameter can be used only if the communications device is 218IFD.

Status 5 Value	Meaning	Description
0 to 65535	Error count	Counts the number of errors that occurred during message processing.

◆ Status 6 (PARAM09)

This parameter gives status information about the Communications Module.

The status content depends on the communications medium. This parameter cannot be used with the 218IFD communications device.

◆ Connection Number (PARAM10)

Specify the remote station.

If the communications device is the Ethernet, enter the connection number.

If the communications device is a serial device, the station number is output.

The valid setting range is given in the following table.

Communications Device	Connection Number	Remarks
Serial (217IF)	0 to 63	Gives the remote station number specified by the source.
Ethernet (218IF, 218IFB, 218IFD)	1 to 20	Receives the message from the remote station set by the specified connection number.

Note: Enter the same connection number as displayed in the Detail Definition Dialog Box for communications device in the MPE720.

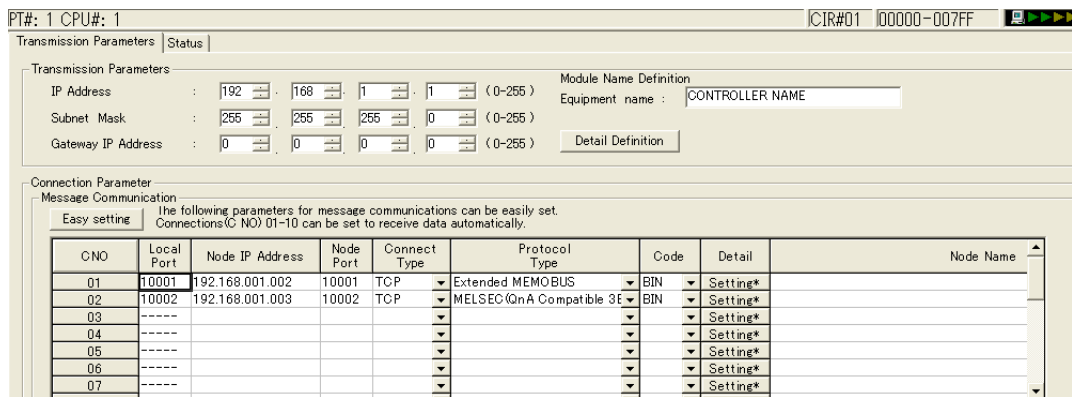

◆ Options (PARAM11)

Set the communications medium or protocol-specific function.

◆ Function Code (PARAM12)

This parameter gives the function code that was received.

Function Code	Target Data Type	Function	Registers When Acting as the Master	
			Send Registers	Receive Registers
00 hex	-	Not used		
01 hex	B	Reads the states of coils.		
02 hex	B	Reads the states of input relays.		
03 hex	W	Reads the contents of hold registers.		
04 hex	W	Reads the contents of input registers.		
05 hex	B	Changes the state of a single coil.		
06 hex	W	Writes to a single hold register.		
07 hex	-	Not used		
08 hex	-	Performs a loopback test.		
09 hex	W	Reads the contents of hold registers (extended).	M	M
0A hex	W	Reads the contents of input registers (extended).		
0B hex	W	Writes to hold registers (extended).		
0C hex	-	Not used		
0D hex	W	Reads the contents of non-consecutive hold registers (extended).		
0E hex	W	Writes the contents of non-consecutive hold registers (extended).		
0F hex	B	Changes the states of multiple coils.		
10 hex	W	Writes to multiple hold registers.		

Continued on next page.

Continued from previous page.

Function Code	Target Data Type	Function	Registers When Acting as the Master	
			Send Registers	Receive Registers
4341 hex	B	Reads the states of bits.	S, M, G, I, or O	M or G
4345 hex	B	Changes the state of a single bit.		
4346 hex	W	Writes to a single register.		
4349 hex	W	Reads the contents of registers.		
434B hex	W	Writes to multiple registers.		
434D hex	W	Reads the contents of non-consecutive registers.		
434E hex	W	Writes the contents of non-consecutive registers.		
434F hex	B	Changes the states of multiple bits.		

Note: B: Bit data, W: Integer data

◆ Reserved for System (PARAM13)

This parameter is used by the system.

Information Do not change the value of PARAM13 from a user program or by any other means.

◆ Data Address (PARAM14 and PARAM15)

These parameters give the data address that was requested by the remote station.

For function codes 01 to 10 hex, the requested address is the word size address indicated only by PARAM14. If the function code is 43□□hex, the requested address is the long-word size address given by PARAM14 and PARAM15.

Function Code	Target Data Type	Function	Data Address Request Range
00 hex	–	Not used	Disabled.
01 hex	B	Reads the states of coils. *1	0 to 65535 (0 to FFFF hex)
02 hex	B	Reads the states of input relays. *1	0 to 65535 (0 to FFFF hex)
03 hex	W	Reads the contents of hold registers. *2	0 to 65534 (0 to FFFE hex)
04 hex	W	Reads the contents of input registers. *2	0 to 65535 (0 to FFFF hex)
05 hex	B	Changes the state of a single coil. *1	0 to 65535 (0 to FFFF hex)
06 hex	W	Writes to a single hold register. *2	0 to 65534 (0 to FFFE hex)
07 hex	–	Not used	Disabled.
08 hex	–	Performs a loopback test.	Disabled.
09 hex	W	Reads the contents of hold registers (extended). *2	0 to 65534 (0 to FFFE hex)
0A hex	W	Reads the contents of input registers (extended). *2	0 to 65535 (0 to FFFF hex)
0B hex	W	Writes to hold registers (extended). *2	0 to 65534 (0 to FFFE hex)
0C hex	–	Not used	Disabled.
0D hex	W	Reads the contents of non-consecutive hold registers (extended). *3	0 to 65534 (0 to FFFE hex)
0E hex	W	Writes the contents of non-consecutive hold registers (extended). *3	0 to 65534 (0 to FFFE hex)
0F hex	B	Changes the states of multiple coils. *1	0 to 65535 (0 to FFFF hex)
10 hex	W	Writes to multiple hold registers. *2	0 to 65534 (0 to FFFE hex)

Continued on next page.

Continued from previous page.

Function Code	Target Data Type	Function	Data Address Request Range
4341 hex	B	Reads the states of bits. *1	0 to 4294967295 (0 to FFFFFFFF hex) Adjust the address to the remote device's address range.
4345 hex	B	Changes the state of a single bit. *1	
4346 hex	W	Writes to a single register. *2	
4349 hex	W	Reads the contents of registers. *2	
434B hex	W	Writes to multiple registers. *2	
434D hex	W	Reads the contents of non-consecutive registers. *3	
434E hex	W	Writes the contents of non-consecutive registers. *3	
434F hex	B	Changes the states of multiple bits. *1	

*1. Coil or input relay read/write requests: Enter the address of the first bit of the data.

*2. Continuous register read/write requests: Enter the address of the first word of the data.

*3. Non-consecutive register read/write requests: Enter the address of the first M register of the address table.

◆ Register Type (PARAM16)

This parameter gives the register type that was requested by the remote station.

This parameter is valid when using function codes 43□□hex only. The target register type is defined for each function code from 01 to 10 hex.

Register Type Value	Type	Remarks
0	M	Sets the target data type to MB for bits and MW for words.
1	G	Sets the target data type to GB for bits and GW for words.
2	I	Sets the target data type to IB for bits and IW for words.
3	O	Sets the target data type to OB for bits and OW for words.
4	S	Sets the target data type to SB for bits and SW for words.
5 or higher	–	Not used for the Extended MEMOBUS protocol.

◆ Data Size (PARAM17)

This parameter gives the data size as the number of bits or words for read/write requests from the remote station.

◆ Remote CPU Module Number (PARAM18)

This parameter gives 1 if the remote device is an MP2000/MP3000-series device.

This parameter indicates the remote CPU Module number if the remote device is a Yaskawa Controller that is not a part of the MP2000/MP3000-series and it is comprised of multiple CPU Modules.

A 0 will be given for all other devices.

◆ Reserved for System (PARAM19)

This parameter is used by the system.

Information Do not change the value of PARAM19 from a user program or by any other means.

◆ Coil Offset (PARAM20 and PARAM21)

Set the offset for the data address in the MP3000.

The MP3000 will offset the address back by the number of words specified by the offset. The data address cannot be offset in the forward direction.

The Coil Offset parameter is used when the function code is 01, 05, 0F, 4341, 4345, or 434F hex. The address is offset by the long-word offset in PARAM20 and PARAM21.

◆ **Input Relay Offset (PARAM22 and PARAM23)**

Set the offset for the data address in the MP3000.

The MP3000 will offset the address back by the number of words specified by the offset. The data address cannot be offset in the forward direction.

The Input Relay Offset parameter is used when the function code is 02 or 4341 hex. The address is offset by the long-word offset in PARAM22 and PARAM23.

◆ **Input Register Offset (PARAM24 and PARAM25)**

Set the offset for the data address in the MP3000.

The MP3000 will offset the address back by the number of words specified by the offset. The data address cannot be offset in the forward direction.

The Input Register Offset parameter is used when the function code is 04, 0A, 4346, 4349, 434D, or 434E hex. The address is offset by the long-word offset in PARAM24 and PARAM25.

◆ **Hold Register Offset (PARAM26 and PARAM27)**

Set the offset for the data address in the MP3000.

The MP3000 will offset the address back by the number of words specified by the offset. The data address cannot be offset in the forward direction.

The Hold Register Offset parameter is used when the function code is 03, 06, 09, 0B, 0D, 0E, 10, 4346, 4349, 434B, 434D, or 434E hex. The address is offset by the long-word offset in PARAM26 and PARAM27.

◆ **Data Relay Offset (PARAM28 and PARAM29)**

Set the offset for the data address in the MP3000.

The MP3000 will offset the address back by the number of words specified by the offset. The data address cannot be offset in the forward direction.

The Data Relay Offset parameter is used when the function code is 4341, 4345, or 434F hex. The address is offset by the long-word offset in PARAM28 and PARAM29.

◆ **Data Register Offset (PARAM30 and PARAM31)**

Set the offset for the data address in the MP3000.

The MP3000 will offset the address back by the number of words specified by the offset. The data address cannot be offset in the forward direction.

The Data Register Offset parameter is used when the function code is 4346, 4349, 434B, 434D, or 434E hex. The address is offset by the long-word offset in PARAM30 and PARAM31.

◆ **Output Coil Offset (PARAM32 and PARAM33)**

Set the offset for the data address in the MP3000.

The MP3000 will offset the address back by the number of words specified by the offset. The data address cannot be offset in the forward direction.

The Output Coil Offset parameter is used when the function code is 4341, 4345, or 434F hex. The address is offset by the long-word offset in PARAM32 and PARAM33.

◆ **Output Register Offset (PARAM34 and PARAM35)**

Set the offset for the data address in the MP3000.

The MP3000 will offset the address back by the number of words specified by the offset. The data address cannot be offset in the forward direction.

The Output Register Offset parameter is used when the function code is 4346, 4349, 434B, 434D, or 434E hex. The address is offset by the long-word offset in PARAM34 and PARAM35.

◆ M Register Writing Range LO (PARAM36 and PARAM37)

Set the lower limit of the allowable address range for write requests from the remote station. An error will occur if the write request is outside this allowable range.

Specify the writing range with word addresses.

◆ M Register Writing Range HI (PARAM38 and PARAM39)

Set the upper limit of the allowable address range for write requests from the remote station. An error will occur if the write request is outside this allowable range.

Specify the writing range with word addresses.

Set the writing range so that it satisfies the following condition:

$0 \leq \text{M register writing range LO} \leq \text{M register writing range HI} \leq \text{Maximum M register address}$

Example Use the following settings to set the allowable writing range of M register addresses to MW0001000 to MW0001999:

```
PARAM36 = 03E8 hex (1000)
PARAM37 = 0000 hex (0000)
PARAM38 = 07CF hex (1999)
PARAM39 = 0000 hex (0000)
```

The MP3000 will return an error if a write request is received for addresses outside the range from MW01000 to MW01999, and will not perform the writing operation.

◆ G Register Writing Range LO (PARAM40 and PARAM41)

Set the lower limit of the allowable address range for write requests from the remote station. An error will occur if the write request is outside this allowable range.

Specify the writing range with word addresses.

◆ G Register Writing Range HI (PARAM42 and PARAM43)

Set the upper limit of the allowable address range for write requests from the remote station. An error will occur if the write request is outside this allowable range.

Specify the writing range with word addresses.

Set the writing range so that it satisfies the following condition:

$0 \leq \text{G register writing range LO} \leq \text{G register writing range HI} \leq \text{Maximum G register address}$

Example Use the following settings to set the allowable writing range of G register addresses to GW120000 to GW136000:

```
PARAM40 = D4C0 hex (lower word for 120000)
PARAM42 = 0001 hex (upper word for 120000)
PARAM41 = 1340 hex (lower word for 136000)
PARAM43 = 0002 hex (upper word for 136000)
```

The MP3000 will return an error if a write request is received for addresses outside the range from GW0120000 to GW0136000, and will not perform the writing operation.

◆ O Register Writing Range LO (PARAM44 and PARAM45)

Set the lower limit of the allowable address range for write requests from the remote station. An error will occur if the write request is outside this allowable range.

Specify the writing range with word addresses.

◆ **O Register Writing Range HI (PARAM46 and PARAM47)**

Set the upper limit of the allowable address range for write requests from the remote station. An error will occur if the write request is outside this allowable range.

Specify the writing range with word addresses.

Set the writing range so that it satisfies the following condition:

$0 \leq \text{O register writing range LO} \leq \text{O register writing range HI} \leq \text{Maximum O register address}$

Example Use the following settings to set the allowable writing range of O register addresses to OW00100 to OW27FFF:

PARAM44 = 0100 hex (lower word for 00100)
PARAM46 = 0000 hex (upper word for 00100)
PARAM45 = 7FFF hex (lower word for 17FFF)
PARAM47 = 0001 hex (upper word for 17FFF)

The MP3000 will return an error if a write request is received for addresses outside the range from OW00100 to OW17FFF, and will not perform the writing operation.

◆ **For System Use (PARAM48)**

This parameter is used by the system. It contains the channel number of the communications buffer that is currently in use.

Information A user program must set PARAM48 to 0 on the first scan after startup. Thereafter, do not change the value of PARAM48 from a user program or by any other means. PARAM24 will be used by the system.

◆ **Reserved for System (PARAM49 to PARAM51)**

These parameters are used by the system.

Information Do not change the value of PARAM49 to PARAM51 from a user program or by any other means.

2.3.3 MSG-SND Function

Inputs and Outputs for the MSG-SND Function

The inputs and outputs for the MSG-SND function are the same as the inputs and outputs for the MSG-SNDE function.

Refer to the following section for more information.

 *Inputs and Outputs for the MSG-SNDE Function on page 2-5*

MSG-SND Function Parameters

The following table describes the contents of the addresses specified by the PARAM input parameter to the MSG-SND function.

No.	I/O	Meaning	Description
00	Outputs	Processing Result	Gives the processing status.
01		Status	Gives the status of the current function.
02	Inputs	Remote Station Number	Specifies the remote station.
03		Option	Sets to a unique value for each communications device.
04		Function Code	Sets the function code to send.
05		Data Address	Sets the first address of the data.
06		Data Size	Sets the data size for the read/write request.
07		Remote CPU Module Number	Sets the CPU Module number at the remote station.
08		Coil Offset	Sets the offset word address for a coil.
09		Input Relay Offset	Sets the offset word address for an input relay.
10		Input Register Offset	Sets the offset word address for an input register.
11		Hold Register Offset	Sets the offset word address for a hold register.
12	-	Reserved for system 1	-
13 to 16		Reserved for system 2	-

◆ Processing Result (PARAM00)

This parameter gives the processing result.

Processing Result Value	Meaning
00□□ hex	Busy
10□□ hex	Complete
8y□□ hex	Error

Note: The lower byte is used for system analysis.

When an error occurs, refer to the following details on errors and perform troubleshooting.

Error	Meaning	Description
80□□ hex	-	Reserved for system.
81□□ hex	Function code error	An unused function code was sent or received. Check PARAM04 (Function Code).
82□□ hex	Address setting error	The setting of one or more of the following parameters is out of range. Check the settings. PARAM05 (Data Address) PARAM08 (Coil Offset) PARAM09 (Input Relay Offset) PARAM10 (Input Register Offset) PARAM11 (Hold Register Offset)
83□□ hex	Data size error	The data size for sending or receiving is out of range. Check PARAM06 (Data Size).
84□□ hex	Circuit number setting error	The circuit number is out of range. Check the circuit number (Cir-No) in the MSG-SND function.
85□□ hex	Channel number setting error	The channel number for the communications buffer is out of range. Check the communications buffer channel number (Ch-No) in the MSG-SND function.
86□□ hex	Connection number error	The connection number is out of range. Check PARAM02 (Connection Number).
87□□ hex	-	-
88□□ hex	Communications device error	An error response was returned from the communications device. Check the connections to the device. Also check to see if the remote device is ready to communicate.
89□□ hex	Device select error	A device that cannot be used was selected. Check the communications device type (Dev-Typ) in the MSG-SND function.

◆ Status (PARAM01)

This parameter gives the status of the communications device.

The following figure shows the bit assignments and it is followed by a detailed description of each assignment.

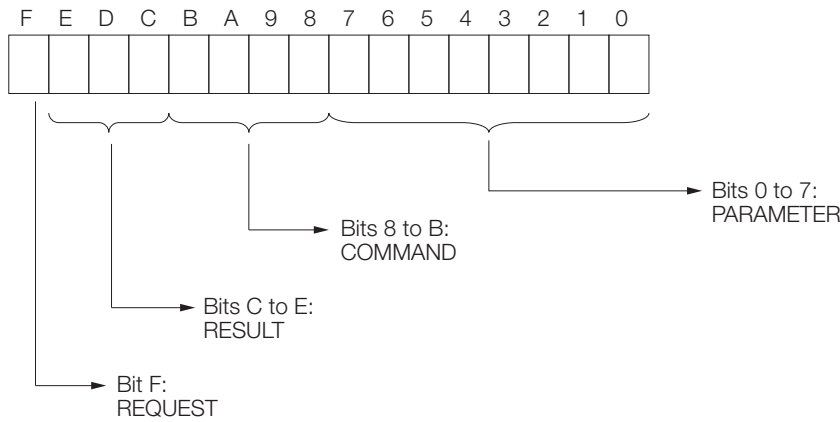

■ REQUEST

This bit gives the status of the processing request for the MSG-SND function.

Bit Status	Meaning
1	Processing is being requested.
0	Processing request has ended.

■ RESULT

These bits give the execution result of the MSG-SND function.

Code	Abbreviation	Meaning
0	CONN_NG	The message send failed or connection ended with an error in Ethernet communications.
1	SEND_OK	The message was sent normally.
2	REC_OK	The message was received normally.
3	ABORT_OK	The request to abort execution was completed.
4	FMT_NG	A parameter formatting error occurred.
5	SEQ_NG or INIT_NG	A command sequence error occurred.
6	RESET_NG or O_RING_NG	A reset occurred.
7	REC_NG	A data reception error (error detected in the lower-layer program) occurred.

■ COMMAND

These bits indicate the processing command of the MSG-SND function.

Code (Hex)	Abbreviation	Meaning
1	U_SEND	General-purpose message transmission (for no-protocol communications)
2	U_REC	General-purpose message reception (for no-protocol communications)
3	ABORT	Forced abort
8	M_SEND	MEMOBUS command transmission: Completed when response is received.
9	M_REC	MEMOBUS command reception: Completed when response is sent.
C	MR_SEND	MEMOBUS response transmission

■ PARAMETER

When RESULT = 4 (FMT_NG: parameter formatting error), these bits will indicate an error code from the following table. For any other value, the bits will contain the connection number.

RESULT	Code	Meaning
When RESULT = 4 (FMT_NG: Parameter Formatting Error)	00	No error
	01	Connection number out of range
	02	Watchdog error for MEMOBUS response
	03	Error in number of retries setting
	04	Error in cyclic area setting
	05	CPU number error
	06	Data address error
	07	Data size error
08	Function code error	
Others	□□	Connection number

◆ Connection Number (PARAM02)

Specify the remote station.

If the communications device is Ethernet, enter the connection number.

If the communications device is a serial device, enter the remote station number.

The setting range is given in the following table.

Communications Device	Connection Number	Description
Serial (217IF)	0	Sends the message to all stations (broadcast).
	1 to 254	Sends the message to the remote station set by the specified station number.
Ethernet (218IF, 218IFB, 218IFD)	1 to 20	Sends the message to the remote station set by the specified connection number.

Note: Enter the same connection number as displayed in the Detail Definition Dialog Box for communications device in the MPE720.

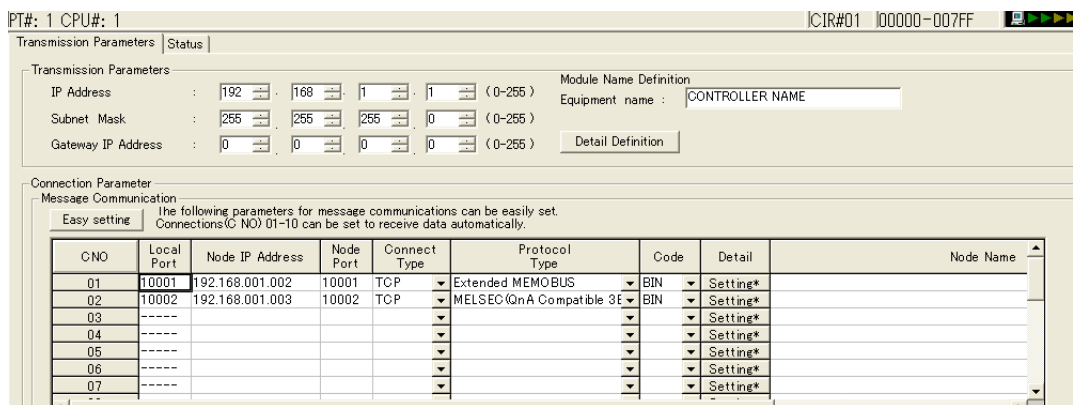

◆ Options (PARAM03)

Set to a unique value for each communications device.

◆ Function Code (PARAM04)

Set the function code to send.

You can use the functions (e.g., read state of coils and input relays and write to hold registers) that are registered to the function codes by specifying that code.

Function Code	Target Data Type	Function
00 hex	–	Not used
01 hex	B	Reads the states of coils.
02 hex	B	Reads the states of input relays.
03 hex	W	Reads the contents of hold registers.
04 hex	W	Reads the contents of input registers.
05 hex	B	Changes the state of a single coil.
06 hex	W	Writes to a single hold register.
07 hex	–	Not used
08 hex	–	Performs a loopback test.
09 hex	W	Reads the contents of hold registers (extended).
0A hex	W	Reads the contents of input registers (extended).
0B hex	W	Writes to hold registers (extended).
0C hex	–	Not used
0D hex	W	Reads the contents of non-consecutive hold registers (extended).
0E hex	W	Writes the contents of non-consecutive hold registers (extended).
0F hex	B	Changes the states of multiple coils.
10 hex	W	Writes to multiple hold registers.

Note: 1. B: Bit data, W: Word data

2. Send and receive registers when acting as the master are MW (MB) only.

3. Coils, hold registers, input relays, and input registers are the respective targets when acting as the slave.

◆ Data Address (PARAM05)

Set the first address of the data.

Enter the first address as a decimal or hexadecimal number.

If the first address is MW01000, enter “1000” (decimal) or “3E8” (hexadecimal).

The range that is allowed for the data address depends on the function code.

The following table lists the setting ranges of data addresses when using MEMOBUS or Extended MEMOBUS as the protocol type.

Function Code	Target Data Type	Function	Data Address Setting Range	
			Ethernet (2181F)	Ethernet (2181FB)
00 hex	–	Not used	Disabled.	
01 hex	B	Reads the states of coils.* ¹	0 to 65535 (0 to FFFF hex)	
02 hex	B	Reads the states of input relays.* ¹	0 to 65535 (0 to FFFF hex)	
03 hex	W	Reads the contents of hold registers.* ²	0 to 65534 (0 to FFFE hex)	
04 hex	W	Reads the contents of input registers.* ²	0 to 32767 (0 to 7FFF hex)	0 to 65535 (0 to FFFF hex)
05 hex	B	Changes the state of a single coil.* ¹	0 to 65535 (0 to FFFF hex)	
06 hex	W	Writes to a single hold register.* ²	0 to 65534 (0 to FFFE hex)	
07 hex	–	Not used	Disabled.	
08 hex	–	Performs a loopback test.	Disabled.	
09 hex	W	Reads the contents of hold registers (extended).	0 to 65534 (0 to FFFE hex)	
0A hex	W	Reads the contents of input registers (extended).	0 to 32767 (0 to 7FFF hex)	0 to 65535 (0 to FFFF hex)
0B hex	W	Writes to hold registers (extended).	0 to 65534 (0 to FFFE hex)	

Continued on next page.

Continued from previous page.

Function Code	Target Data Type	Function	Data Address Setting Range	
			Ethernet (2181F)	Ethernet (2181FB)
0C hex	–	Not used	Disabled.	
0D hex	W	Reads the contents of non-consecutive hold registers (extended). ^{*3}	0 to 65534 (0 to FFFE hex)	
0E hex	W	Writes the contents of non-consecutive hold registers (extended). ^{*3}	0 to 65534 (0 to FFFE hex)	
0F hex	B	Changes the states of multiple coils. ^{*1}	0 to 65535 (0 to FFFF hex)	
10 hex	W	Writes to multiple hold registers. ^{*2}	0 to 65534 (0 to FFFE hex)	

- *1. Coil or relay read/write requests: Enter the address of the first bit of the data.
- *2. Continuous register read/write requests: Enter the address of the first word of the data.
- *3. Read/write request for discontinuous registers: Set the leading M register number of the address table.

Information Address Table

An address table specifies indirect addressing for discontinuous data. The M register specified by PARAM05 (data address) specifies the start of the address table and PARAM06 (data size) specifies the size of the address table.

When reading data, set data addresses 1 to n to the address to be read at the remote station. The read data will be stored in the local station according to data addresses 1 to n.

When writing data, the data stored in data addresses 1 to n at the local station will be read and then written to data addresses 1 to n at the remote station.

The contents of an address table used to read/write discontinuous registers is illustrated below.

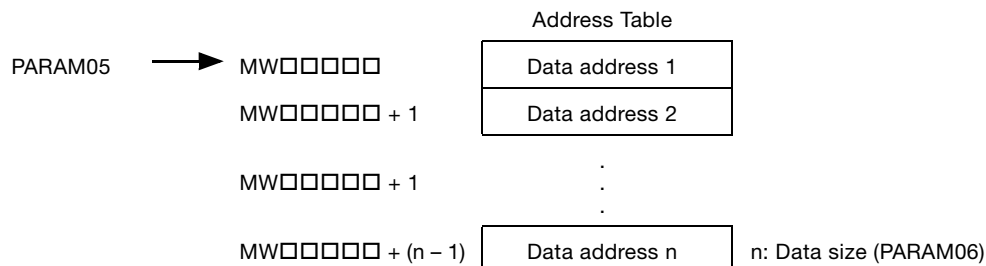

◆ Data Size (PARAM06)

Set the data size for the read/write request as the number of bits or words.

Be sure that the last data address that is determined by the offset, data address, and data size does not exceed the valid data address range.

The range that is allowed for the data size depends on the function code and communications device.

The following table lists the setting ranges of data sizes when using MEMOBUS or Extended MEMOBUS as the protocol type.

Function Code	Target Data Type	Function	Data Size Setting Range Ethernet (218IFB)
00 hex	–	Not used	Disabled.
01 hex	B	Reads the states of coils. *1	1 to 2000
02 hex	B	Reads the states of input relays. *1	1 to 2000
03 hex	W	Reads the contents of hold registers. *2	1 to 125
04 hex	W	Reads the contents of input registers. *2	1 to 125
05 hex	B	Changes the state of a single coil. *1	Disabled.
06 hex	W	Writes to a single hold register. *2	Disabled.
07 hex	–	Not used	Disabled.
08 hex	–	Performs a loopback test.	Disabled.
09 hex	W	Reads the contents of hold registers (extended). *2	1 to 2044 (BIN) 1 to 1020 (ASCII)
0A hex	W	Reads the contents of input registers (extended). *2	1 to 2044 (BIN) 1 to 1020 (ASCII)
0B hex	W	Writes to hold registers (extended). *2	1 to 2043 (BIN) 1 to 1019 (ASCII)
0C hex	–	Not used	Disabled.
0D hex	W	Reads the contents of non-consecutive hold registers (extended). *2	1 to 2044 (BIN) 1 to 1020 (ASCII)
0E hex	W	Writes the contents of non-consecutive hold registers (extended). *2	1 to 1022 (BIN) 1 to 510 (ASCII)
0F hex	B	Changes the states of multiple coils. *1	1 to 800
10 hex	W	Writes to multiple hold registers. *2	1 to 100

*1. Set the number of bits.

*2. Set the number of words.

Note: The data sizes in the table are in decimal notation.

◆ Remote CPU Module Number (PARAM07)

Set the CPU Module number at the remote station.

Specify 1 if the remote device is an MP2000/MP3000-series Controller.

If the remote device is a Yaskawa Controller that is not part of the MP2000/MP3000-series and it is comprised of multiple CPU Modules, specify the destination CPU Module number.

For all other devices, specify 0.

◆ Offsets (PARAM08 to PARAM11)

Set the offsets of the addresses of the read data destination or write data source on the sending node.

The sending node will offset the address back by the number of words specified by the offset.

Information A negative value cannot be set as the offset value.

Offset parameters are provided for each of the target data types.

The following table lists the offset parameters.

Offset Parameters

Parameters	Meaning	Description
PARAM08	Coil Offset	Sets the offset word address for a coil.
PARAM09	Input Relay Offset	Sets the offset word address for an input relay.
PARAM10	Input Register Offset	Sets the offset word address for an input register.
PARAM11	Hold Register Offset	Sets the offset word address for a hold register.

The offset parameters that can be used depend on the function code.

The following table lists the valid parameters for each function code.

Applicable Offset Parameters by Function Code

Function Code	Function	Applicable Offset Parameter	Protocol Type	
			Extended MEMOBUS	MEMOBUS
01 hex	Reads the states of coils.	PARAM08	○	○
02 hex	Reads the states of input relays.	PARAM09	○	○
03 hex	Reads the contents of hold registers.	PARAM11	○	○
04 hex	Reads the contents of input registers	PARAM10	○	○
05 hex	Changes the state of a single coil.	PARAM08	○	○
06 hex	Writes to a single hold register.	PARAM11	○	○
09 hex	Reads the contents of hold registers (extended).	PARAM11	○	×
0A hex	Reads the contents of input registers (extended).	PARAM10	○	×
0B hex	Writes to hold registers (extended).	PARAM11	○	×
0D hex	Reads the contents of non-consecutive hold registers (extended).	PARAM11	○	×
0E hex	Writes the contents of non-consecutive hold registers (extended).	PARAM11	○	×
0F hex	Changes the states of multiple coils.	PARAM08	○	○
10 hex	Writes to multiple hold registers.	PARAM11	○	○

Note: ○: Settable, ×: Not settable

◆ Reserved for System 1 (PARAM12)

This parameter is used by the system. It contains the channel number of the communications buffer that is currently in use.

A user program must set PARAM12 to 0 on the first scan after startup. Thereafter, do not change the value of PARAM12 from a user program or by any other means. PARAM12 will be used by the system.

◆ Reserved for System 2 (PARAM13 to PARAM16)

These parameters are used by the system. Do not change the values of PARAM13 to PARAM16 from a user program or by any other means.

2.3.4 MSG-RCV Function

Inputs and Outputs for the MSG-RCV Function

The inputs and outputs for the MSG-RCV function are the same as the inputs and outputs for the MSG-RCVE function.

Refer to the following section for more information.

 *Inputs and Outputs for the MSG-RCVE Function on page 2-20*

MSG-RCV Function Parameters

◆ Parameter List for Serial Communications (217IF)

“Param” for the MSG-RCV function is a parameter list structure consisting of 17 words. The value of “Param” itself is the first address of the parameter list (MA or DA).

The parameter list is used by inputting connection numbers, function codes, and relevant parameter data. It is also where the process results and status are output.

The following table describes the contents of the addresses specified by the PARAM input parameter to the MSG-RCV function.

No.	I/O	Meaning	Description
00	Outputs	Processing Result	Gives the processing status.
01		Status	Gives the status of the communications device.
02	I/O	Connection Number	Gives the connection number of the destination.
03	Outputs	Option	Gives a unique value for each communications device.
04		Function Code	Gives the function code that was requested from the sending node.
05		Data Address	Gives the first address of the data that was requested from the sending node.
06		Data Size	Gets the read/write data size that was requested from the sending node.
07		Remote CPU Module Number	Gets the remote CPU Module number.
08	Inputs	Coil Offset	Sets the offset word address for a coil.
09		Input Relay Offset	Sets the offset word address for an input relay.
10		Input Register Offset	Sets the offset word address for an input register.
11		Hold Register Offset	Sets the offset word address for a hold register.
12		Writing Range LO	Sets the first address of the writing range.
13	Writing Range HI	Sets the last address of the writing range.	
14	-	Reserved for system 1	-
15, 16		Reserved for system 2	-

◆ Processing Result (PARAM00)

This parameter gives the processing result.

Processing Result Value	Meaning
00□□ hex	Busy
10□□ hex	Complete
8y□□ hex	Error

Note: The lower byte is used for system analysis.

When an error occurs, refer to the following details on errors and perform troubleshooting.

Error	Meaning	Description
80□□ hex	–	Reserved for system.
81□□ hex	Function code error	An unused function code was received. Check the function code of the source.
82□□ hex	Address setting error	The setting of one or more of the following parameters is out of range. Check the settings. Data Address (Request from Sending Node) PARAM08 (Coil Offset) PARAM09 (Input Relay Offset) PARAM10 (Input Register Offset) PARAM11 (Hold Register Offset)
83□□ hex	Data size error	The data size for sending or receiving is out of range. Check PARAM06 (Data Size).
84□□ hex	Circuit number setting error	The circuit number is out of range. Check the circuit number (Cir-No) in the MSG-RCV function.
85□□ hex	Channel number setting error	The channel number for the communications buffer is out of range. Check the communications buffer channel number (Ch-No) in the MSG-RCV function.
86□□ hex	Connection number error	The connection number is out of range. Check PARAM02 (Connection Number).
87□□ hex	–	Reserved for system.
88□□ hex	Communications device error	An error response was returned from the communications device. Check the connections to the device. Also check to see if the remote device is ready to communicate.
89□□ hex	Device select error	A device that cannot be used was selected. Check the communications device type (Dev-Typ) in the MSG-RCV function.

◆ Status (PARAM01)

This parameter gives the status of the communications device.

The following figure shows the bit assignments and it is followed by a detailed description of each assignment.

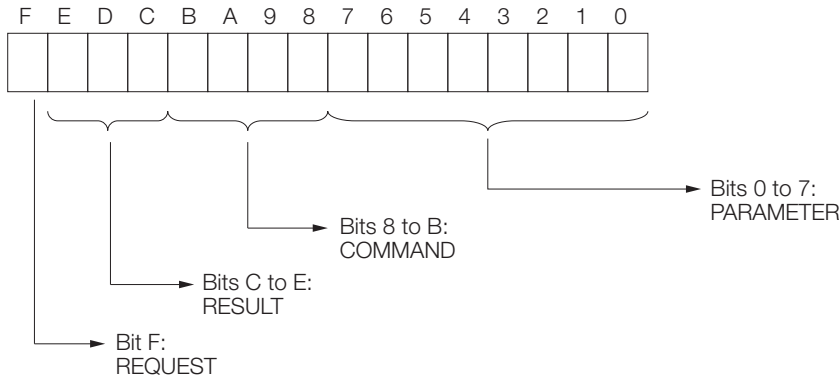

■ REQUEST

This bit gives the status of the processing request for the MSG-RCV function.

Bit Status	Meaning
1	Processing is being requested.
0	Processing request has ended.

■ RESULT

These bits give the execution result of the MSG-RCV function.

Code	Abbreviation	Meaning
0	CONN_NG	The message send failed or connection ended with an error in Ethernet communications.
1	SEND_OK	The message was sent normally.
2	REC_OK	The message was received normally.
3	ABORT_OK	The request to abort execution was completed.
4	FMT_NG	A parameter formatting error occurred.
5	SEQ_NG	A command sequence error occurred.
6	RESET_NG	A reset occurred.
7	REC_NG	A data reception error (error detected in the lower-layer program) occurred.

■ COMMAND

These bits indicate the processing command of the MSG-RCV function.

Code (Hex)	Abbreviation	Meaning
1	U_SEND	General-purpose message transmission (for no-protocol communications)
2	U_REC	General-purpose message reception (for no-protocol communications)
3	ABORT	Forced abort
8	M_SEND	MEMOBUS command transmission: Completed when response is received.
9	M_REC*	MEMOBUS command reception
C	MR_SEND*	MEMOBUS response transmission

* MR_SEND is executed after M_REC is executed.

■ PARAMETER

When RESULT = 4 (FMT_NG: parameter formatting error), these bits will indicate an error code from the following table. For any other value, the bits will contain the connection number.

RESULT	Code	Meaning
When RESULT = 4 (FMT_NG: Parameter Formatting Error)	00	No error
	01	Connection number out of range
	02	Watchdog error for MEMOBUS response
	03	Error in number of retries setting
	04	Error in cyclic area setting
	05	CPU number error
	06	Data address error
	07	Data size error
Others	□□	Connection number

◆ Connection Number (PARAM02)

Specify the remote station.

If the communications device is the Ethernet, enter the connection number.

If the communications device is a serial device, the station number is output.

The valid setting range is given in the following table.

Communications Device	Connection Number	Remarks
Serial (217IF)	0 to 63	Gives the remote station number specified by the source.
Ethernet (218IF, 218IFB, 218IFD)	1 to 20	Receives the message from the remote station set by the specified connection number.

Note: Enter the same connection number as displayed in the Detail Definition Dialog Box for communications device in the MPE720.

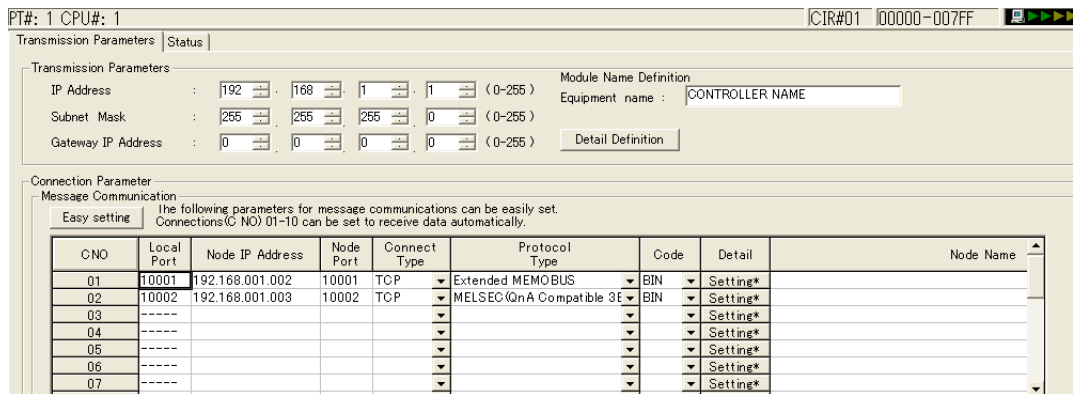

◆ Options (PARAM03)

Gives a unique value for each communications device.

◆ Function Code (PARAM04)

This parameter gives the function code that was received.

Function Code	Target Data Type	Function
00 hex	–	Not used
01 hex	B	Reads the states of coils.
02 hex	B	Reads the states of input relays.
03 hex	W	Reads the contents of hold registers.
04 hex	W	Reads the contents of input registers.
05 hex	B	Changes the state of a single coil.
06 hex	W	Writes to a single hold register.
07 hex	–	Not used
08 hex	–	Performs a loopback test.
09 hex	W	Reads the contents of hold registers (extended).
0A hex	W	Reads the contents of input registers (extended).
0B hex	W	Writes to hold registers (extended).
0C hex	–	Not used
0D hex	W	Reads the contents of non-consecutive hold registers (extended).
0E hex	W	Writes the contents of non-consecutive hold registers (extended).
0F hex	B	Changes the states of multiple coils.
10 hex	W	Writes to multiple hold registers.

Note: 1. B: Bit data, W: Word data

2. Send and receive registers when acting as the master are MW (MB) only.

3. Coils, hold registers, input relays, and input registers are the respective targets when acting as the slave.

◆ Data Address (PARAM05)

This parameter gives the address of the data that was requested from the sending node.

◆ Data Size (PARAM06)

This parameter gives the read or write data size (number of bits or words) that was requested from the sending node.

◆ Remote CPU Module Number (PARAM07)

This parameter gives 1 if the remote device is an MP2000/MP3000-series Controller.

This parameter indicates the remote CPU Module number if the remote device is a Yaskawa Controller that is not a part of the MP2000/MP3000-series and it is comprised of multiple CPU Modules.

A 0 will be given for all other devices.

◆ Offsets (PARAM08 to PARAM11)

Set the offsets for the data addresses in the receiving node.

The receiving node will offset the address back by the number of words specified by the offset.

A negative value cannot be set as the offset value.

Offset parameters are provided for each of the target data types.

The following table lists the offset parameters.

Offset Parameters

Parameters	Meaning	Description
PARAM08	Coil Offset	Sets the offset word address for a coil.
PARAM09	Input Relay Offset	Sets the offset word address for an input relay.
PARAM10	Input Register Offset	Sets the offset word address for an input register.
PARAM11	Hold Register Offset	Sets the offset word address for a hold register.

The offset parameters that can be used depend on the function code.

The following table lists the valid parameters for each function code.

Applicable Offset Parameters by Function Code

Function Code	Function	Applicable Offset Parameter
01 hex	Reads the states of coils.	PARAM08
02 hex	Reads the states of input relays.	PARAM09
03 hex	Reads the contents of hold registers.	PARAM11
04 hex	Reads the contents of input registers.	PARAM10
05 hex	Changes the state of a single coil.	PARAM08
06 hex	Writes to a single hold register.	PARAM11
09 hex	Reads the contents of hold registers (extended).	PARAM11
0A hex	Reads the contents of input registers (extended).	PARAM10
0B hex	Writes to hold registers (extended).	PARAM11
0D hex	Reads the contents of non-consecutive hold registers (extended).	PARAM11
0E hex	Writes the contents of non-consecutive hold registers (extended).	PARAM11
0F hex	Changes the states of multiple coils.	PARAM08
10 hex	Writes to multiple hold registers.	PARAM11

◆ Writing Range (PARAM12, PARAM13)

Set the allowable writing address range for write requests from the sending node. An error will occur if the write request is outside this allowable range.

Specify the writing range (PARAM12, PARAM13) with word addresses.

The data storage destination for writing requests from the sending node with the MSG-RCV function is entirely M registers.

The writing range parameters allow you to specify the range of M registers that messages are allowed to write to. The following table lists the writing range parameters.

Parameters	Meaning	Description
PARAM12	Writing Range LO	First address of the writing range
PARAM13	Writing Range HI	Last address of the writing range

Set the writing range so that it satisfies the following condition:

$$0 \leq \text{Writing range LO} \leq \text{Writing range HI} \leq \text{Maximum M register address}$$

The writing range applies when using the following function codes.

- 05 hex (Changes the state of a single coil.)
- 06 hex (Writes to a single hold register.)
- 0B hex (Writes to hold registers (extended).)
- 0E hex (Writes the contents of non-consecutive hold registers (extended).)
- 0F hex (Changes the states of multiple coils.)
- 10 hex (Writes to multiple hold registers.)

Example Use the following settings to set the allowable writing range of M register addresses to 1000 to 1999:

PARAM12 = 1000
PARAM13 = 1999

The receiving node will output an error if a write request is received for addresses outside the range from MW01000 to MW01999, and it will not perform the writing operation.

◆ Reserved for System 1 (PARAM14)

This parameter is used by the system. It contains the channel number of the communications buffer that is currently in use.

A user program must set PARAM14 to 0 on the first scan after startup. Thereafter, do not change the value of PARAM14 from a user program or by any other means. PARAM14 will be used by the system.

◆ Reserved for System 2 (PARAM15, PARAM16)

These parameters are used by the system. Do not change the values of PARAM15 and PARAM16 from a user program or by any other means.

No-Protocol Communications Method

3

The no-protocol communications method refers to the method that performs communications using a protocol that is not implemented in MP-series Controllers. With this communications method, the user must build the communications protocol for the remote device in the ladder program. There are two types of no-protocol communications, no-protocol (half duplex) and no-protocol FD (full duplex). These types serve to control the physical layer. This chapter describes details on no-protocol and no-protocol FD communications.

3.1	No-Protocol Communications	3-2
3.1.1	For Ethernet Communications	3-2
3.1.2	For Serial Communications	3-5
3.2	Message Functions Related to No-Protocol Communications . .	3-6
3.2.1	MSG-SNDE Function	3-6
3.2.2	MSG-RCVE Function	3-8
3.2.3	MSG-SND Function	3-11
3.2.4	MSG-RCV Function	3-15
3.3	No-Protocol FD Communications	3-19
3.3.1	Specification	3-19
3.3.2	Protocol Operation	3-20
3.3.3	Processing of a Received Data Error	3-20
3.3.4	Precautions When Using No-Protocol FD Communications	3-21
3.4	Message Functions Related to No-Protocol FD Communications . .	3-22
3.4.1	MSG-SNDE Function	3-22
3.4.2	MSG-RCVE Function	3-23
3.4.3	MSG-SND Function	3-26
3.4.4	MSG-RCV Function	3-29

3.1 No-Protocol Communications

No-protocol communications is half-duplex communications. Sending and receiving cannot be processed simultaneously.

3.1.1 For Ethernet Communications

Specification

The following table lists the specifications for no-protocol communications.

Item	Meaning
Message Channels	10 (for both the SND and RCV functions)
Maximum Send Size	218IF = 510 words 218IF□ = 2046 words
Maximum Receive Size	218IF = 510 words 218IF□ = 2046 words
Receive Buffers	218IF: Single buffer only 218IF□: Single buffer/multiple buffers
Processing When a Data Error Occurs	The entire message is discarded.
Data Error Detection and Reporting	None

Protocol Operation

When No-Protocol is used for the 218IF□, you can select a single buffer or multiple buffers (20 buffers).

Message Structure

When no-protocol communications is set as the communications protocol, application data is handled as a general-purpose message. When sending and receiving data, each message consists of two fields: a header and the application data field.

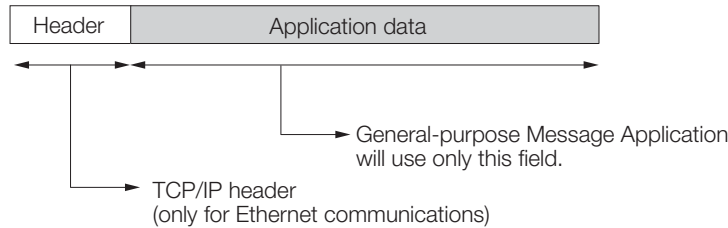

The header is for TCP/IP and UDP/IP connections and is used only for Ethernet communications. User programs do not need to be aware of this header because it is automatically appended and removed in the 218IF or 218F□.

The application data field can be formatted as required by the application. The application data field has the following message structure.

Communications Protocol	Code	Supported Communications Method	Reference
No-protocol	BIN	217IF, 218IF, 218IF□	☞ <i>General-purpose Binary Mode</i> on page 3-3
No-protocol	ASCII	218IF, 218IF□	☞ <i>General-purpose ASCII Mode</i> on page 3-3

- Note: 1. Ethernet communications will use either binary or ASCII data based on the code setting in the connection parameters.
 2. For 217IF communications, the communications mode is None (equivalent to BIN).

The difference compared to using the general-purpose messaging mode with the Extended MEMOBUS protocol is that the 218 header is not appended before the application data.

◆ **General-purpose Message Commands**

General-purpose message commands can be set as required by the application.

◆ **General-purpose Binary Mode**

In no-protocol communications, the values of the MW hold registers in the Machine Controller are sent and received in the application data field.

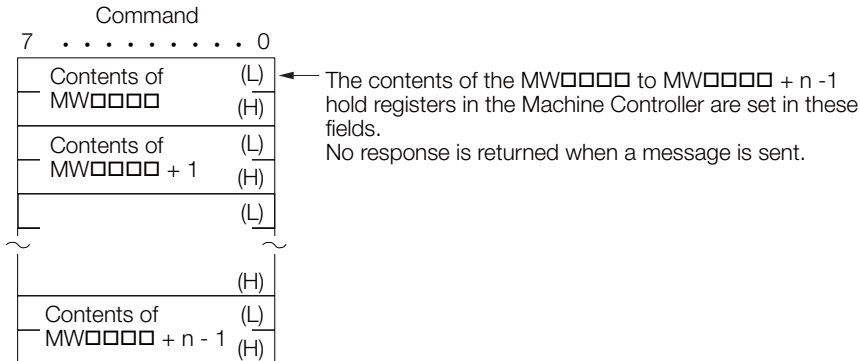

◆ **General-purpose ASCII Mode**

In ASCII Mode, binary data is converted to ASCII before being sent or received.

The following diagram illustrates the conversion from binary to ASCII. As shown in the example, 8-bit data is converted into two 7-bit ASCII characters.

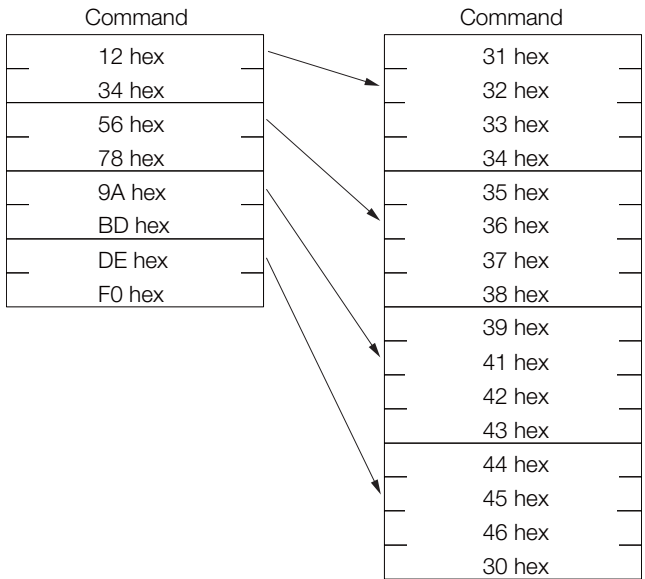

◆ Operation of the Single Buffer

With single buffer, the latest data is always obtained with the RCV function when data is received from the remote device in no-protocol communications.

For UDP communications, the latest data is obtained in units of packets. For TCP communications, there is no concept of packets. For this reason, what portion of the data is obtained from the data that was continuously sent depends on the timing.

The data in the receive buffer is discarded if the data is not obtained with the RCV function within five to 10 seconds.

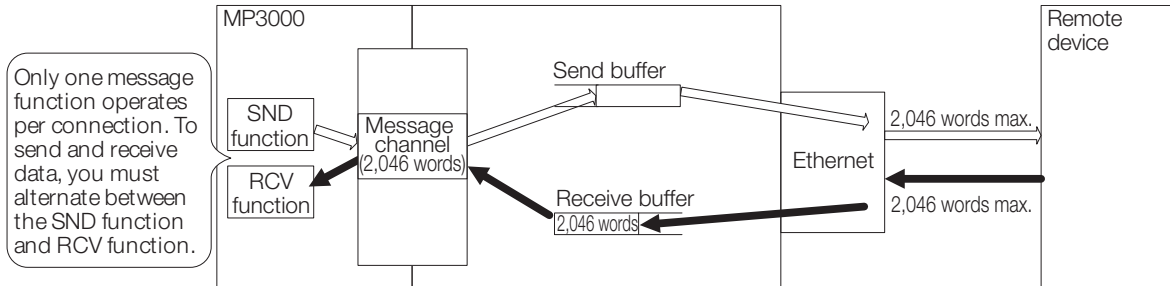

Note: For the 218IF Module, locations indicated as 2046 words are actually 510 words.

◆ Operation of Multiple Buffers

For multiple buffers, data can be held in up to 20 receive buffers when data is received from the remote device in no-protocol communications. The received data that is held is obtained with the RCV function in order of oldest data first. When the receive buffer area is full, the data received after that point in time is discarded. Data can be received again when buffers in the receive buffers area are emptied.

The data in the receive buffers is discarded in order of oldest data first if the data is not obtained with the RCV function within five to 10 seconds.

For UDP communications, 20 items of data can be held in units of packets. For TCP communications, 20 items of data can be held in units of data that are obtained from the TCP protocol stack in the 218IF□. In TCP communications, there is no concept of packets. For this reason, data that was continuously sent may be split or multiple items of data may be received as a group (depending on factors such as the interval of received data and the timing of processing in the 218IF□). Therefore, the data may need to be split or assembled in the user application after it is obtained with the RCV function.

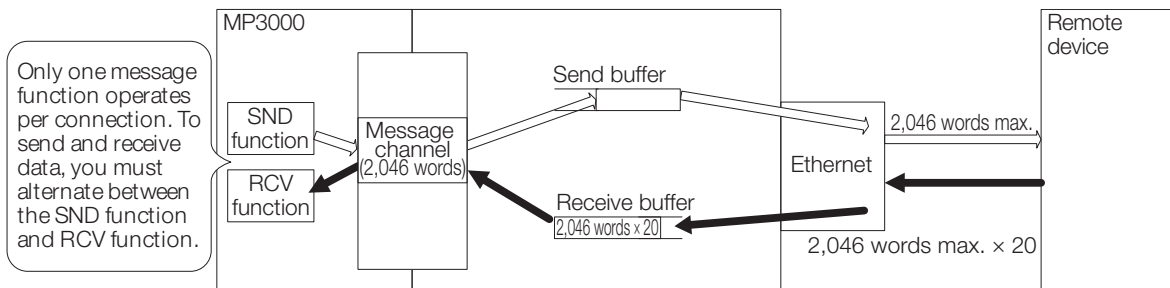

3.1.2 For Serial Communications

Specification

The following table lists the specifications for no-protocol communications.

Item	Meaning
Serial Communications	Half-duplex communications
Message Channels	1 (for both the SND and RCV functions)
Maximum Send Size	508 bytes
Maximum Receive Size	508 bytes
Receive Buffers	One only
Processing When a Data Error Occurs	The entire message is discarded.
Data Error Detection and Reporting	None

Processing of a Received Data Error

The following diagram shows the processing of a received data error for no-protocol communications in serial communications.

In no-protocol communications, if there is an error in even one byte in one message (the group of data up to when the watchdog timer times out), all of the data in the message is discarded (this is also the same for communications using a protocol such as MEMOBUS).

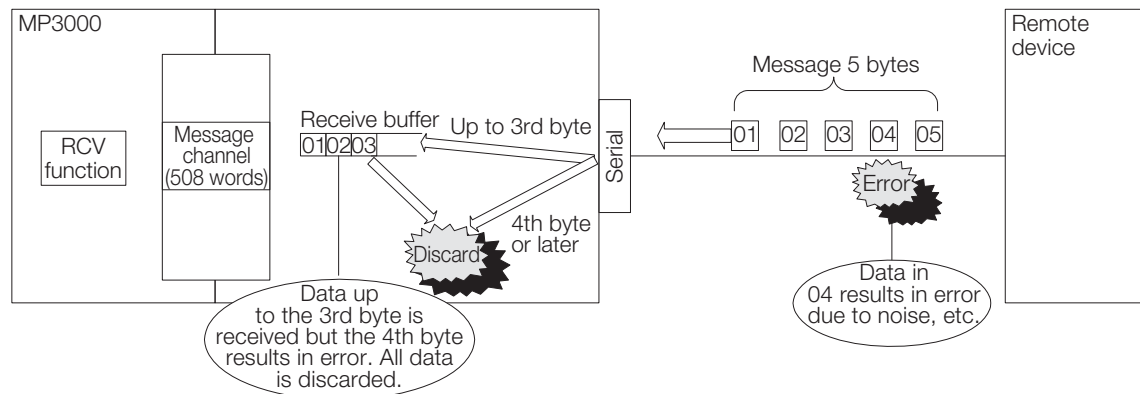

Protocol Operation

The following diagram shows the operation of no-protocol communications in serial communications.

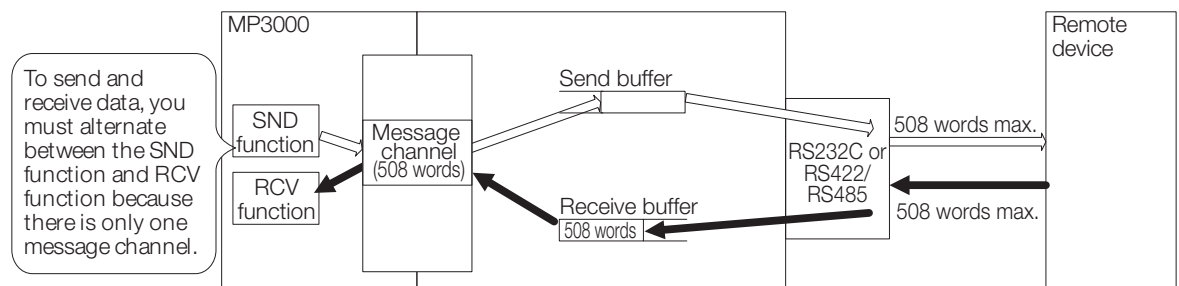

3.2 Message Functions Related to No-Protocol Communications

For the no-protocol communications method, a communications program is required to exchange data with a remote device. In addition to the communications program, a ladder program must also be created to assemble messages to send and to interpret received messages based on the protocol.

3.2.1 MSG-SNDE Function

Inputs and Outputs for the MSG-SNDE Function

Refer to the following section for more information on inputs and outputs.

 *Inputs and Outputs for the MSG-SNDE Function on page 2-5*

MSG-SNDE Function Parameters

The following table describes the contents of the addresses specified by the PARAM input parameter to the MSG-SNDE function.

No.	I/O	Meaning	Description
00	Out-puts	Processing Result	Gives the processing status.
01		Status*	Gives the status of the current function.
02		Detail Error Code, Lower Word*	Gives the details of an error.
03		Detail Error Code, Upper Word*	
04		Status 1*	Gives the communications status.
05		Status 2*	Gives status information on the most recent error.
06		Status 3*	Gives the information of the send pass counter.
07		Status 4*	Gives the information of the receive pass counter.
08		Status 5*	Gives the information of the error counter.
09		Status 6	Reserved for system.
10	Inputs	Connection Number	Sets the connection number used to determine the remote station. (For Ethernet only)
11		Option	Not used in no-protocol communications.
12		Function Code	Not used in no-protocol communications.
13		Reserved for system.	–
14		Remote Station Data Address, Lower Word	Not used in no-protocol communications.
15		Remote Station Data Address, Upper Word	
16		Remote Station Register Type	Not used in no-protocol communications.
17		Data Size	Sets the size of the send data. No-protocol communications 1: Number of words No-protocol communications 2: Number of bytes
18		Remote CPU Module Number	Not used in no-protocol communications.
19		Reserved for system.	–
20		Local Station Data Address, Lower Word	Sets the data address to store the send data in the local station.
21		Local Station Data Address, Upper Word	
22		Local Station Register Type	Sets the register type of the send data to store in the local station.
23		Reserved for system.	–

Continued on next page.

Continued from previous page.

No.	I/O	Meaning	Description
24	-	For system use	-
25		Reserved for system.	-
26		Reserved for system.	-
27		Reserved for system.	-
28		Reserved for system.	-

* The content for Status No. 2 to No. 8 functions on the 2181FD only.

◆ Processing Result (PARAM00) to Status 6 (PARAM09)

Refer to the following section.

MSG-SNDE Function Parameters on page 3-6

◆ Connection Number (PARAM10)

Specify the remote station.

If the communications device is the Ethernet, enter the connection number.

If the communications device is a serial device, this parameter is not used.

The setting range is given in the following table.

Communications Device	Connection Number	Description
Ethernet (2181F, 2181FB, 2181FD)	1 to 20	Specifies the remote station to which to send the message.

Note: Enter the same connection number as displayed in the 2181F, 2181FB, or 2181FD Detail Definition Dialog Box in the MPE720.

The screenshot shows the 'Transmission Parameters' dialog box. At the top, it displays 'PT#: -- CPU#: --' and 'CIR#01 00000-007FF'. The 'Transmission Parameters' section includes fields for IP Address (192.168.1.1), Subnet Mask (255.255.255.0), and Gateway IP Address (0.0.0.0). A 'Module Name Definition' section shows 'Equipment name: CONTROLLER NAME'. Below this is the 'Connection Parameter' section, which includes a table for 'Message Communication'.

CNO	Local Port	Node IP Address	Node Port	Connect Type	Protocol Type	Code	Detail	Node
01	05000	192.168.001.002	05001	UDP	None	BIN	Setting*	
02	----						Setting*	
03	----						Setting*	
04	----						Setting*	
05	----						Setting*	
06	----						Setting*	
07	----						Setting*	

◆ Data Size (PARAM17)

Set the size of the data to send as the number of words or bytes.

◆ Local Station Data Address (PARAM20 and PARAM21)

Set the address of where the send data is stored in the MP3000.

The address is set as the word offset from address 0.

◆ Local Station Register Type (PARAM22)

Set the register type of where the send data is stored in the MP3000.

Register Type Value	Type	Remarks
0	M	Sets MW for both no-protocol communications 1 and 2.
1	G	Sets GW for both no-protocol communications 1 and 2.
2	I	Sets IW for both no-protocol communications 1 and 2.
3	O	Sets OW for both no-protocol communications 1 and 2.
4	S	Sets SW for both no-protocol communications 1 and 2.
5 or higher	–	Not used in no-protocol communications.

3.2.2 MSG-RCVE Function

Inputs and Outputs for the MSG-RCVE Function

Refer to the following section for more information on inputs and outputs.

 2.3.2 MSG-RCVE Function on page 2-20

MSG-RCVE Function Parameters

The following table describes the contents of the addresses specified by the PARAM input parameter to the MSG-RCVE function.

No.	I/O	Meaning	Description
00	Outputs	Processing Result	Gives the processing status.
01		Status	Gives the status of the current function.
02		Detail Error Code, Lower Word*	Gives the details of an error.
03			
04		Status 1*	Gives the communications status.
05		Status 2*	Gives status information on the most recent error.
06		Status 3*	Gives the information of the send pass counter.
07		Status 4*	Gives the information of the receive pass counter.
08		Status 5*	Gives the information of the error counter.
09		Status 6	Reserved for system.
10	I/O	Connection Number	Sets the connection number used to determine the remote station. (For Ethernet only)
11		Option	Not used in no-protocol communications.
12	Output	Function Code	Not used in no-protocol communications.
13	I/O	Reserved for system.	–
14	Outputs	Data Address, Lower Word	Not used in no-protocol communications.
15		Data Address, Upper Word	Not used in no-protocol communications.
16		Register Type	Not used in no-protocol communications.
17		Data Size	Gives the data size that was received from the remote station. No-protocol communications 1: Number of words No-protocol communications 2: Number of bytes
18		Remote CPU Module Number	Not used in no-protocol communications.
19	I/O	Reserved for system.	–

Continued on next page.

Continued from previous page.

No.	I/O	Meaning	Description	
20	Inputs	Coil Offset, Lower Word	Not used in no-protocol communications.	
21		Coil Offset, Upper Word		
22		Input Relay Offset, Lower Word	Not used in no-protocol communications.	
23		Input Relay Offset, Upper Word		
24		Input Register Offset, Lower Word	Not used in no-protocol communications.	
25		Input Register Offset, Upper Word		
26		Hold Register Offset, Lower Word	Not used in no-protocol communications.	
27		Hold Register Offset, Upper Word		
28		Data Relay Offset, Lower Word	Not used in no-protocol communications.	
29		Data Relay Offset, Upper Word		
30		Data Register Offset, Lower Word	Not used in no-protocol communications.	
31		Data Register Offset, Upper Word		
32		Output Coil Offset, Lower Word	Not used in no-protocol communications.	
33		Output Coil Offset, Upper Word		
34		Output Register Offset, Lower Word	Not used in no-protocol communications.	
35		Output Register Offset, Upper Word		
36		M Register Writing Range LO, Lower Word	Sets the first address of the M registers in which to save the data that was received from the remote station.	
37		M Register Writing Range LO, Upper Word		
38		M Register Writing Range HI, Lower Word		
39		M Register Writing Range HI, Upper Word		
40		G Register Writing Range LO, Lower Word	Not used in no-protocol communications.	
41		G Register Writing Range LO, Upper Word		
42		G Register Writing Range HI, Lower Word	Not used in no-protocol communications.	
43		G Register Writing Range HI, Upper Word		
44		O Register Writing Range LO, Lower Word	Not used in no-protocol communications.	
45		O Register Writing Range LO, Upper Word		
46		O Register Writing Range HI, Lower Word	Not used in no-protocol communications.	
47		O Register Writing Range HI, Upper Word		
48		-	For system use	-
49			Reserved for system.	-
50			Reserved for system.	-
51			Reserved for system.	-

* The content for Status No. 2 to No. 8 functions on the 218IFD only.

◆ Processing Result (PARAM00) to Status 6 (PARAM09)

Refer to the following section.

 MSG-RCVE Function Parameters on page 3-8

◆ Connection Number (PARAM10)

Specify the remote station.

If the communications device is the Ethernet, enter the connection number.

If the communications device is a serial device, this parameter is not used.

The setting range is given in the following table.

Communications Device	Connection Number	Description
Ethernet (218IF, 218IFB, 218IFD)	1 to 20	Receives the message from the remote station set by the specified connection number.

Note: Enter the same connection number as displayed in the 218IF, 218IFB, or 218IFD Detail Definition Dialog Box in the MPE720.

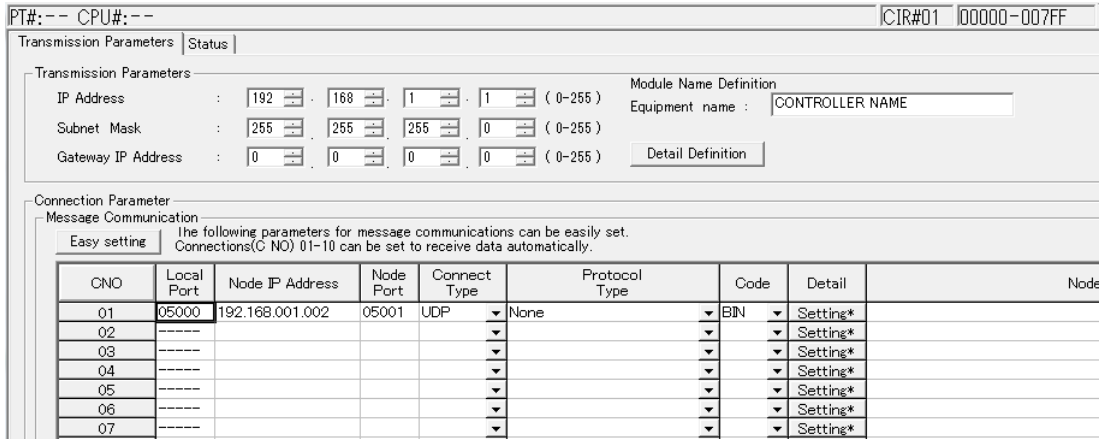

◆ Data Size (PARAM17)

This parameter gives the size of the data that was received as the number of words or bytes.

◆ M Register Writing Range LO (PARAM36 and PARAM37)

Set the first address in which to save the data to be received from the remote station.

◆ M Register Writing Range HI (PARAM38 and PARAM39)

Set the last address in which to save the data to be received from the remote station.

Received data that exceeds the last address is discarded.

Set the writing range so that it satisfies the following condition:

$0 \leq \text{M register writing range LO} \leq \text{M register writing range HI} \leq \text{Maximum M register address}$

3.2.3 MSG-SND Function

Inputs and Outputs for the MSG-SND Function

The inputs and outputs for the MSG-SND function are the same as the inputs and outputs for the MSG-SNDE function.

Refer to the following section for more information.

 *Inputs and Outputs for the MSG-SNDE Function on page 2-5*

MSG-SND Function Parameters

No.	I/O	Meaning	Description
00	Outputs	Processing Result	Gives the processing status.
01		Status	Gives the status of the communications device.
02	Inputs	Connection Number	Sets the connection number used to determine the remote station. (For Ethernet only)
03		Option	Not used in no-protocol communications.
04		Function Code	Not used in no-protocol communications.
05		Data Address	Sets the first address of the data.
06		Data Size	Sets the size of the send data.
07		Remote CPU Module Number	Not used in no-protocol communications.
08		Coil Offset	Not used in no-protocol communications.
09		Input Relay Offset	Not used in no-protocol communications.
10		Input Register Offset	Not used in no-protocol communications.
11		Hold Register Offset	Sets the offset word address for a hold register.
12	System	Reserved for system 1	Not used in no-protocol communications.
13 to 16		Reserved for system 2	Not used in no-protocol communications.

◆ Processing Result (PARAM00)

The upper byte gives the processing result. The lower byte is used for system analysis.

Processing Result Value	Meaning
00□□ hex	Busy
10□□ hex	Complete
8y□□ hex	Error

When an error occurs, refer to the following details on errors and perform troubleshooting.

Error	Meaning	Description
80□□ hex	–	Reserved for system.
81□□ hex	–	–
82□□ hex	Address setting error	The setting of one or more of the following parameters is out of range. Check the settings. PARAM05 (Data Address) PARAM11 (Hold Register Offset)
83□□ hex	Data size error	The data size for sending or receiving is out of range. Check PARAM06 (Data Size).
84□□ hex	Circuit number setting error	The circuit number is out of range. Check the circuit number (Cir-No) in the MSG-SND function.
85□□ hex	Channel number setting error	The channel number for the communications buffer is out of range. Check the communications buffer channel number (Ch-No) in the MSG-SND function.
86□□ hex	–	–
87□□ hex	–	Reserved for system.

Continued on next page.

Continued from previous page.

Error	Meaning	Description
88□□ hex	Communications device error	An error response was returned from the communications device. Check the connections to the device. Also check to see if the remote device is ready to communicate.
89□□ hex	Device select error	A device that cannot be used was selected. Check the communications device type (Dev-Typ) in the MSG-SND function.

◆ Status (PARAM01)

This parameter gives the status of the communications device.

The following figure shows the bit assignments and it is followed by a detailed description of each assignment.

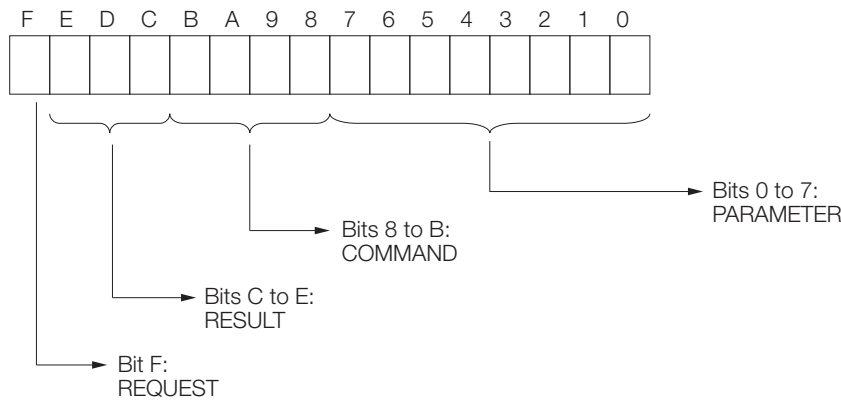

■ REQUEST

This bit gives the status of the processing request for the MSG-SND function.

Bit Status	Meaning
1	Processing is being requested.
0	Processing request has ended.

■ RESULT

These bits give the execution result of the MSG-SND function.

Code	Abbreviation	Meaning
1	SEND_OK	The message was sent normally.
2	REC_OK	The message was received normally.
3	ABORT_OK	The request to abort execution was completed.
4	FMT_NG	A parameter formatting error occurred.
5	SEQ_NG	A command sequence error occurred.
6	RESET_NG	A reset occurred.
7	REC_NG	A data reception error (error detected in the lower-layer program) occurred.

■ COMMAND

These bits indicate the processing command of the MSG-SND function.

Code (Hex)	Abbreviation	Meaning
1	U_SEND	General-purpose message transmission
2	U_REC	General-purpose message reception
3	ABORT	Forced abort
8	M_SEND	MEMOBUS command transmission: Completed when response is received. (for the MEMOBUS protocol)
9	M_REC	MEMOBUS command transmission: Completed when response is sent. (for the MEMOBUS protocol)
C	MR_SEND	MEMOBUS response transmission (for the MEMOBUS protocol)

■ PARAMETER

When RESULT = 4 (FMT_NG: parameter formatting error), these bits will indicate an error code from the following table.

RESULT	Code	Meaning
When RESULT = 4 (FMT_NG: Parameter Formatting Error)	00	No error
	01	Station address out of range
	02	Watchdog error for MEMOBUS response (for the MEMOBUS protocol)
	03	Error in number of retries setting
	04	Error in cyclic area setting
	05	CPU number error
	06	Data address error
	07	Data size error
	08	Function code error (for the MEMOBUS protocol)

◆ Connection Number (PARAM02)

Specify the remote station.

If the communications device is the Ethernet, enter the connection number.

If the communications device is a serial device, this parameter is not used.

The setting range is given in the following table.

Communications Device	Connection Number	Description
Ethernet (218IF, 218IFB, 218IFD)	1 to 20	Specifies the remote station to which to send the message.

Note: Enter the same connection number as displayed in the 218IF, 218IFB, or 218IFD Detail Definition Dialog Box in the MPE720.

The screenshot shows the MPE720 configuration interface. At the top, it displays 'PT#: -- CPU#: --' and 'CIR#01 0000-007FF'. Below this, there are two main sections: 'Transmission Parameters' and 'Connection Parameter'.

The 'Transmission Parameters' section includes fields for IP Address (192.168.1.1), Subnet Mask (255.255.255.0), and Gateway IP Address (0.0.0.0). It also has a 'Module Name Definition' section with 'Equipment name' set to 'CONTROLLER NAME' and a 'Detail Definition' button.

The 'Connection Parameter' section includes a table for 'Message Communication' with the following data:

CNO	Local Port	Node IP Address	Node Port	Connect Type	Protocol Type	Code	Detail	Node
01	05000	192.168.001.002	05001	UDP	None	BIN	Setting*	
02	----						Setting*	
03	----						Setting*	
04	----						Setting*	
05	----						Setting*	
06	----						Setting*	
07	----						Setting*	

◆ Data Address (PARAM05)

Set the first address of the data.

Enter the first address as a decimal or hexadecimal number.

Information If the first address is MW01000, enter "1000" (decimal) or "3E8" (hexadecimal).

The following table lists the setting ranges of data addresses.

Data Address Setting Range (No-Protocol Communications)

No-Protocol Communications Type	Target Data Type	Function	Data Address Setting Range
No-protocol communications 1	W	Sends data in units of words.	0 to 65534 (0 to FFFE hex)
No-protocol communications 2	B	Sends data in units of bytes.*	0 to 65534 (0 to FFFE hex)

* The unit for setting addresses is words.

◆ Data Size (PARAM06)

Set the size of the data for the write request as the number of words or bytes.

Be sure that the last data address that is determined by the offset, data address, and data size does not exceed the valid data address range.

The range that is allowed for the data size depends on the function code and communications device.

Data Size Setting Range (No-Protocol Communications)

No-Protocol Communications Type	Target Data Type	Function	Data Address Setting Range	
			Ethernet	Serial Communications
No-protocol communications 1	W	Sends data in units of words.	218IF: 1 to 510	1 to 254
			218IFB, 218IFD: 1 to 2046	
No-protocol communications 2	B	Sends data in units of bytes.	218IF: 1 to 1020	1 to 508
			218IFB, 218IFD: 1 to 4092	

Note: The data sizes in the table are in decimal notation.

◆ Register Offset (PARAM11)

Set the offset for the address of the write data source on the sending node.

The sending node will offset the address back by the number of words specified by the offset.

Note: A negative value cannot be set as the offset value.

Example To offset the register address by 1000 words:
PARAM11 = 1000

◆ Reserved for System 1 (PARAM12)

This parameter is used by the system. It contains the channel number of the communications buffer that is currently in use.

Information A user program must set PARAM12 to 0 on the first scan after startup. Thereafter, do not change the value of PARAM12 from a user program or by any other means. PARAM12 will be used by the system.

◆ Reserved for System 2 (PARAM13 to PARAM16)

These parameters are used by the system. Do not change the values of PARAM13 to PARAM16 from a user program or by any other means.

3.2.4 MSG-RCV Function

Inputs and Outputs for the MSG-RCV Function

The inputs and outputs for the MSG-RCV function are the same as the inputs and outputs for the MSG-RCVE function.

Refer to the following section for more information.

 *Inputs and Outputs for the MSG-RCVE Function on page 2-20*

MSG-RCV Function Parameters

No-protocol communications stores the received data in M registers as is without performing protocol conversion. This allows data to be received using any protocol matched to the other device.

No.	I/O	Meaning	Description
00	Outputs	Processing Result	Gives the processing status.
01		Status	Gives the status of the communications device.
02	I/O	Connection Number	Gives the connection number of the destination. (Only for Ethernet)
03	Outputs	Option	Not used in no-protocol communications.
04		Function Code	Not used in no-protocol communications.
05		Data Address	Not used in no-protocol communications.
06		Data Size	Gives the data size that was received from the remote station.
07		Remote CPU Module Number	Not used in no-protocol communications.
08	Inputs	Coil Offset	Not used in no-protocol communications.
09		Input Relay Offset	Not used in no-protocol communications.
10		Input Register Offset	Not used in no-protocol communications.
11		Hold Register Offset	Not used in no-protocol communications.
12		Writing Range LO	Sets the first address of the writing range.
13		Writing Range HI	Sets the last address of the writing range.
14	System	Reserved for system 1	Not used in no-protocol communications.
15, 16		Reserved for system 2	Not used in no-protocol communications.

◆ Processing Result (PARAM00)

This parameter gives the processing result.

Processing Result Value	Meaning
00□□ hex	Busy
10□□ hex	Complete
8y□□ hex	Error

When an error occurs, refer to the following details on errors and perform troubleshooting.

Error	Meaning	Description
80□□ hex	–	Reserved for system.
81□□ hex	–	–
82□□ hex	Address setting error	The setting of one or more of the following parameters is out of range. Check the settings. PARAM12 (Register Offset)
83□□ hex	Data size error	The data size for receiving is out of range. Check the data size of the sending node.
84□□ hex	Circuit number setting error	The circuit number is out of range. Check the circuit number (Cir-No) in the MSG-RCV function.
85□□ hex	Channel number setting error	The channel number for the communications buffer is out of range. Check the communications buffer channel number (Ch-No) in the MSG-RCV function.
86□□ hex	–	–
87□□ hex	–	Reserved for system.
88□□ hex	Communications device error	An error response was returned from the communications device. Check the connections to the device. Also check to see if the remote device is ready to communicate.
89□□ hex	Device select error	A device that cannot be used was selected. Check the communications device type (Dev-Typ) in the MSG-RCV function.

◆ Status (PARAM01)

This parameter gives the status of the communications device.

The following figure shows the bit assignments and it is followed by a detailed description of each assignment.

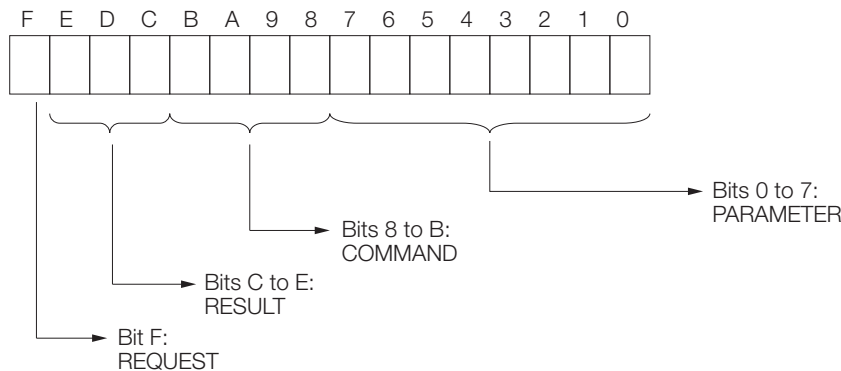

■ REQUEST

This bit gives the status of the processing request for the MSG-RCV function.

Bit Status	Meaning
1	Processing is being requested.
0	Processing request has ended.

■ RESULT

These bits give the execution result of the MSG-RCV function.

Code	Abbreviation	Meaning
1	SEND_OK	The message was sent normally.
2	REC_OK	The message was received normally.
3	ABORT_OK	The request to abort execution was completed.
4	FMT_NG	A parameter formatting error occurred.
5	SEQ_NG	A command sequence error occurred.
6	RESET_NG	A reset occurred.
7	REC_NG	A data reception error (error detected in the lower-layer program) occurred.

■ COMMAND

These bits indicate the processing command of the MSG-RCV function.

Code (Hex)	Abbreviation	Meaning
1	U_SEND	General-purpose message transmission (for no-protocol communications)
2	U_REC	General-purpose message reception (for no-protocol communications)
3	ABORT	Forced abort
8	M_SEND	MEMOBUS command transmission: Completed when response is received.
9	M_REC*	MEMOBUS command reception
C	MR_SEND*	MEMOBUS response transmission

* MR_SEND is executed after M_REC is executed.

■ PARAMETER

When RESULT = 4 (FMT_NG: parameter formatting error), these bits will indicate an error code from the following table.

RESULT	Code	Meaning
When RESULT = 4 (FMT_NG: Parameter Formatting Error)	00	No error
	01	Connection number out of range
	02	Watchdog error for MEMOBUS response
	03	Error in number of retries setting
	04	Error in cyclic area setting
	05	CPU number error
	06	Data address error
	07	Data size error
Others	08	Function code error
	□□	Connection number

◆ Connection Number (PARAM02)

Specify the remote station.

If the communications device is Ethernet, enter the connection number.

If the communications device is a serial device, this parameter is not used.

The setting range is given in the following table.

Communications Device	Connection Number	Description
Ethernet (218IF, 218IFB, 218IFD)	1 to 20	Receives the message from the remote station set by the specified connection number.

Note: Enter the same connection number as displayed in the 218IF, 218IFB, or 218IFD Detail Definition Dialog Box in the MPE720.

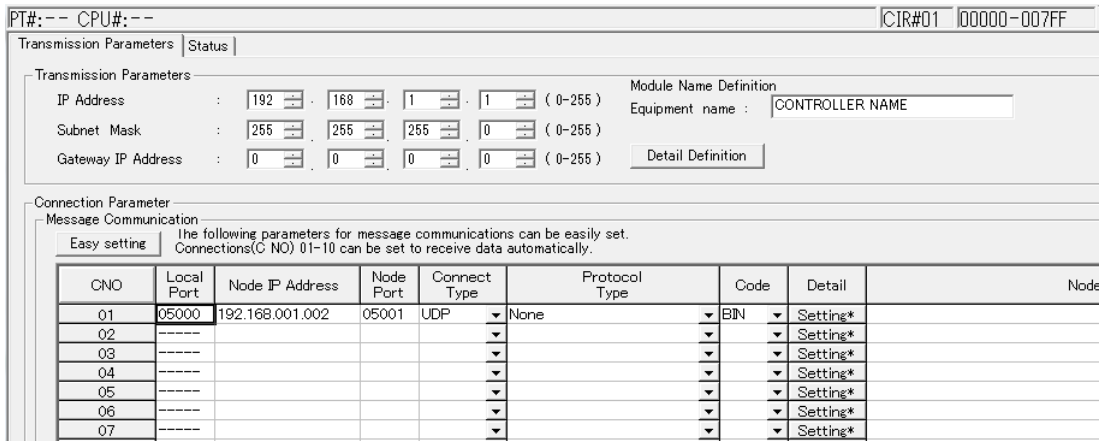

◆ Data Size (PARAM06)

This parameter gives the size of the data that was requested from the sending node.

The number of words is given for no-protocol communications 1.

The number of bytes is given for no-protocol communications 2.

◆ Writing Range (PARAM12 and PARAM13)

For no-protocol communications, the received consecutive data is stored in M registers.

An error will occur if a request was made to write a value that does not correspond to PARAM12 (Write Range LO) to PARAM13 (Write Range HI).

Set the writing range so that it satisfies the following condition:

$$0 \leq \text{Writing range} \leq \text{Maximum M register address}$$

Example Use the following settings to set the allowable writing range of M register addresses to MW01000 to MW01999:
 PARAM12 = 1000
 PARAM13 = 1999

◆ Reserved for System 1 (PARAM14)

This parameter is used by the system. It contains the channel number of the communications buffer that is currently in use.

Information A user program must set PARAM14 to 0 on the first scan after startup. Thereafter, do not change the value of PARAM14 from a user program or by any other means. PARAM14 will be used by the system.

◆ Reserved for System 2 (PARAM15 and PARAM16)

These parameters are used by the system. Do not change the values of PARAM15 and PARAM16 from a user program or by any other means.

3.3 No-Protocol FD Communications

No-protocol FD communications is full-duplex communications. Sending and receiving is performed independently.

Only serial communications can be used for no-protocol FD communications.

When using RS-422/485, use a four-wire cable.

3.3.1 Specification

Item	Meaning
Serial Communications Method	Full-duplex communications
Message Channels	2 (1 for the SND function and 1 for the RCV function)
Maximum Send Size	508 bytes
Maximum Receive Size	10160 bytes
Receive Buffers	508 bytes x 20 buffers
Processing When a Data Error Occurs	Only the byte data with the error is discarded.
Data Error Detection and Reporting	Errors reported to the RCV function.



Important

Software Versions That Support No-Protocol FD Communications

The software versions that support no-protocol FD communications are listed below. Check the software version before using no-protocol FD communications.

- 217IF-01 Module: Ver. 02.00 and higher
- 218IF-01 Module: Not supported
- 218IF-02 Module: Not supported
- 260IF-01 Module: Not supported
- 261IF-01 Module: Not supported
- MPE720: Ver. 6.37 and higher or Ver. 7.24 and higher

You can check the system software version of the Communications Module by looking for the "V.**.***" sticker attached to the board in the Communications Module.

3.3.2 Protocol Operation

With no-protocol FD communications, you can use full-duplex communications by executing the SND function and RCV function at the same time. A maximum of 10,160 bytes of continuous data can also be received.

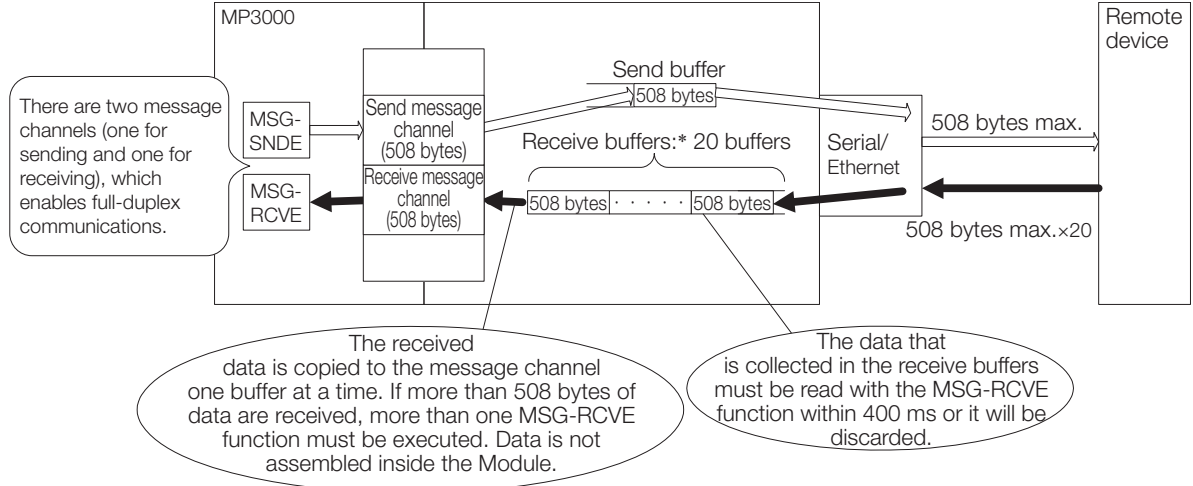

- * Receive buffer storage rules for received data
- The segmentation of received data is monitored by time. When the time interval set for the watchdog timer (a communications parameter for the 2171F) runs out, the data received up to that point is stored in the receive buffers as one message.
 - If the received data is 508 bytes or less, the received data is stored using one receive buffer. For example, even if the received data is determined to be a one byte message, that one byte is stored using one entire receive buffer.
 - If the received data is 509 bytes or more, the continuous data is received and stored in receive buffers in 508-byte chunks as long as there are free receive buffers (up to 20 buffers).

3.3.3 Processing of a Received Data Error

The following diagram shows the processing of a received data error for no-protocol FD communications in serial communications.

The concept of one message in no-protocol FD communications is the same as in no-protocol communications. However, when an error occurs, only the byte that caused the error is discarded, and the normal data is held in the receive buffers as is. Information is passed to a parameter in the RCV function to provide notification of data with errors inside the received message.

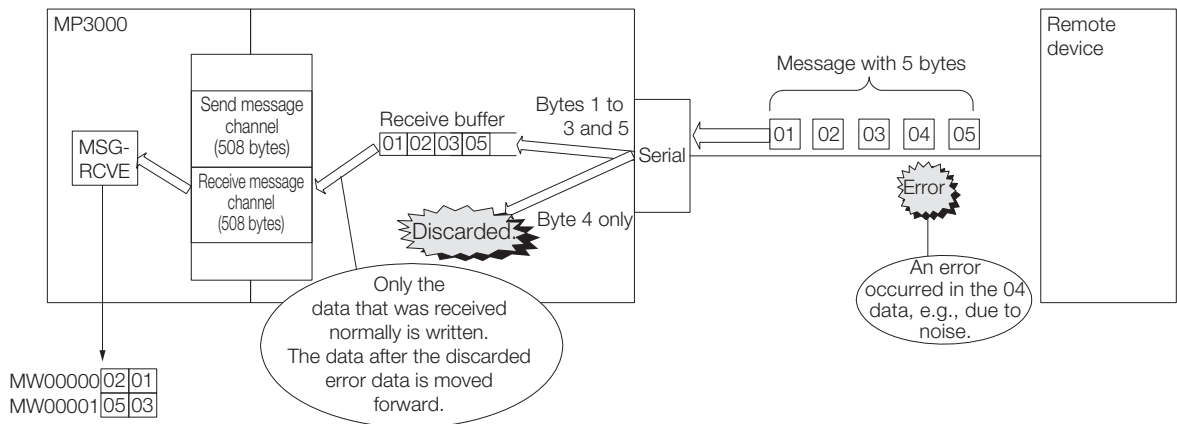

3.3.4 Precautions When Using No-Protocol FD Communications

The channel numbers in the functions must always be set correctly. Set Ch-No (channel number) in the SND function to 1, and set Ch-No (channel number) in the RCV function to 2.

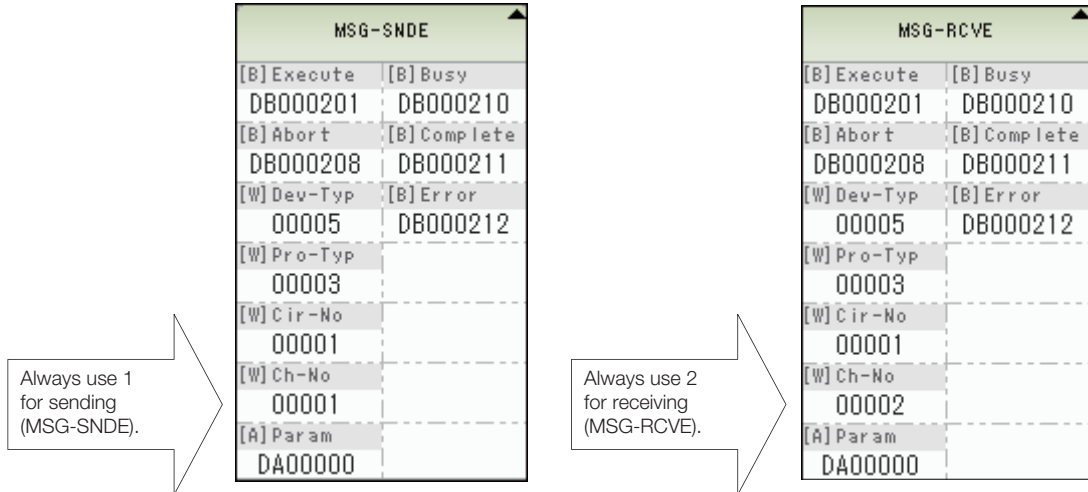

3.4 Message Functions Related to No-Protocol FD Communications

3.4.1 MSG-SNDE Function

Inputs and Outputs for the MSG-SNDE Function

Refer to the following section for more information on inputs and outputs.

 2.3.1 MSG-SNDE Function on page 2-5

MSG-SNDE Function Parameters

The following table describes the contents of the addresses specified by the PARAM input parameter to the MSG-SNDE function.

No.	I/O	Meaning	Description
00	Outputs	Processing Result	Gives the processing status.
01		Status*	Gives the status of the current function.
02		Detail Error Code, Lower Word	Not used
03		Detail Error Code, Upper Word	
04		Status 1	Not used
05		Status 2	Not used
06		Status 3	Not used
07		Status 4	Not used
08		Status 5	Not used
09		Status 6	Reserved for system.
10	Inputs	Remote Station Number	Not used in no-protocol FD communications.
11		Option	Not used in no-protocol FD communications.
12		Function Code	Not used in no-protocol FD communications.
13		Reserved for system.	–
14		Remote Station Data Address, Lower Word	Not used in no-protocol FD communications.
15		Remote Station Data Address, Upper Word	
16		Remote Station Register Type	Not used in no-protocol FD communications.
17		Data Size	Sets the size of the send data.
18		Remote CPU Module Number	Not used in no-protocol FD communications.
19		Reserved for system.	–
20		Local Station Data Address, Lower Word	Sets the data address to store the send data in the local station.
21		Local Station Data Address, Upper Word	
22		Local Station Register Type	Sets the register type of the send data to store in the local station.
23		Reserved for system.	–
24	–	For system use	–
25		Reserved for system.	–
26		Reserved for system.	–
27		Reserved for system.	–
28		Reserved for system.	–

◆ Data Size (PARAM17)

Set the size of the data to send as the number of words or bytes.

◆ **Local Station Data Address (PARAM20 and PARAM21)**

Set the address of where the send data is stored in the MP3000.

The address is set as the word offset from address 0.

◆ **Local Station Register Type (PARAM22)**

Set the register type of where the send data is stored in the MP3000.

Register Type Value	Type	Remarks
0	M	Sets MW.
1	G	Sets GW.
2	I	Sets IW.
3	O	Sets OW.
4	S	Sets SW.
5 or higher	-	Not used in no-protocol communications.

3.4.2 MSG-RCVE Function

Inputs and Outputs for the MSG-RCVE Function

Refer to the following section for more information on inputs and outputs.

 2.3.2 MSG-RCVE Function on page 2-20

MSG-RCVE Function Parameters

The following table describes the contents of the addresses specified by the PARAM input parameter to the MSG-RCVE function.

No.	I/O	Meaning	Description
00	Outputs	Processing Result	Gives the processing status.
01		Status	Gives the status of the current function.
02		Detail Error Code, Lower Word	Not used
03			
04		Status 1	Not used
05		Status 2	Not used
06		Status 3	Not used
07		Status 4	Not used
08		Status 5	Not used
09		Status 6	Reserved for system.
10	Output	Remote Station Number	Not used in no-protocol FD communications.
11	I/O	Option	Gives the receive status when there is an error.
12	Output	Function Code	Not used in no-protocol FD communications.
13	I/O	Reserved for system.	-
14	Outputs	Data Address, Lower Word	Not used in no-protocol FD communications.
15		Data Address, Upper Word	Not used in no-protocol FD communications.
16		Register Type	Not used in no-protocol FD communications.
17		Data Size	Gives the data size that was received from the remote station. No-protocol communications 1: Number of words No-protocol communications 2: Number of bytes
18		Remote CPU Module Number	Not used in no-protocol FD communications.
19	I/O	Reserved for system.	-

Continued on next page.

3.4 Message Functions Related to No-Protocol FD Communications

3.4.2 MSG-RCVE Function

Continued from previous page.

No.	I/O	Meaning	Description	
20	Inputs	Coil Offset, Lower Word	Not used in no-protocol FD communications.	
21		Coil Offset, Upper Word		
22		Input Relay Offset, Lower Word	Not used in no-protocol FD communications.	
23		Input Relay Offset, Upper Word		
24		Input Register Offset, Lower Word	Not used in no-protocol FD communications.	
25		Input Register Offset, Upper Word		
26		Hold Register Offset, Lower Word	Not used in no-protocol FD communications.	
27		Hold Register Offset, Upper Word		
28		Data Relay Offset, Lower Word	Not used in no-protocol FD communications.	
29		Data Relay Offset, Upper Word		
30		Data Register Offset, Lower Word	Not used in no-protocol FD communications.	
31		Data Register Offset, Upper Word		
32		Output Coil Offset, Lower Word	Not used in no-protocol FD communications.	
33		Output Coil Offset, Upper Word		
34		Output Register Offset, Lower Word	Not used in no-protocol FD communications.	
35		Output Register Offset, Upper Word		
36		M Register Writing Range LO, Lower Word	Sets the first address of the M registers in which to save the data that was received from the remote station.	
37		M Register Writing Range LO, Upper Word		
38		M Register Writing Range HI, Lower Word		
39		M Register Writing Range HI, Upper Word		
40		G Register Writing Range LO, Lower Word	Not used in no-protocol FD communications.	
41		G Register Writing Range LO, Upper Word		
42		G Register Writing Range HI, Lower Word	Not used in no-protocol FD communications.	
43		G Register Writing Range HI, Upper Word		
44		O Register Writing Range LO, Lower Word	Not used in no-protocol FD communications.	
45		O Register Writing Range LO, Upper Word		
46		O Register Writing Range HI, Lower Word	Not used in no-protocol FD communications.	
47		O Register Writing Range HI, Upper Word		
48		-	For system use	-
49		-	Reserved for system.	-
50		-	Reserved for system.	-
51		-	Reserved for system.	-

◆ Option (PARAM11)

This parameter gives the receive status when there is an error.

This parameter is used only if No-Protocol FD is selected in the communications protocol in the 217IF Detail Definition Dialog Box. This parameter cannot be used if No-Protocol is selected.

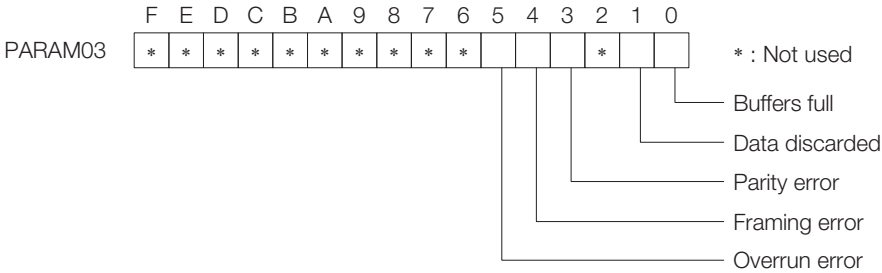

Bit	Name	Meaning	Description
Bit 0	Buffers full	This bit is turned ON when 20 receive buffers were fully used and data could not be received. 0: No buffer overflow 1: Buffer overflow occurred	There was data that could not be received because the buffers were filled before the data that was currently read.
Bit 1	Data discarded	This bit is turned ON when data was discarded by the system because data could not be obtained with the MSG-RCV function in a 400-ms period from when the data was received. 0: No discarded data due to timeout 1: Data was discarded due to timeout	There was data that was discarded due to a timeout before the data that was currently read.
Bit 3	Parity error	This bit is turned ON when a parity error occurs. 0: No parity error 1: Parity error occurred	There was data that could not be received due to a parity error in the data that was currently read.
Bit 4	Framing error	This bit is turned ON when a framing error occurs. 0: No framing error 1: Framing error occurred	There was data that could not be received due to a framing error in the data that was currently read.
Bit 5	Overrun error	This bit is turned ON when an overrun error occurs. 0: No overrun error 1: Overrun error occurred	There was data that could not be received due to an overrun error in the data that was currently read.

◆ Data Size (PARAM17)

This parameter gives the size of the data that was received as the number of words or bytes.

◆ M Register Writing Range LO (PARAM36 and PARAM37)

Set the first address in which to save the data to be received from the remote station.

◆ M Register Writing Range HI (PARAM38 and PARAM39)

Set the last address in which to save the data to be received from the remote station.

Received data that exceeds the last address is discarded.

Set the writing range so that it satisfies the following condition:

$$0 \leq \text{M register writing range LO} \leq \text{M register writing range HI} \leq \text{Maximum M register address}$$

3.4.3 MSG-SND Function

Inputs and Outputs for the MSG-SND Function

The inputs and outputs for the MSG-SND function are the same as the inputs and outputs for the MSG-SNDE function.

Refer to the following section for more information.

 *Inputs and Outputs for the MSG-SNDE Function on page 2-5*

MSG-SND Function Parameters

No.	I/O	Meaning	Description
00	Outputs	Processing Result	Gives the processing status.
01		Status	Gives the status of the communications device.
02	Inputs	Remote Station Number	Not used in no-protocol FD communications.
03		Option	Not used in no-protocol FD communications.
04		Function Code	Not used in no-protocol FD communications.
05		Data Address	Sets the first address of the data.
06		Data Size	Sets the data size for the write request.
07		Remote CPU Module Number	Not used in no-protocol FD communications.
08		Coil Offset	Not used in no-protocol FD communications.
09		Input Relay Offset	Not used in no-protocol FD communications.
10		Input Register Offset	Not used in no-protocol FD communications.
11		Hold Register Offset	Sets the offset word address for a hold register.
12	System	Reserved for system 1	Not used in no-protocol FD communications.
13 to 16		Reserved for system 2	Not used in no-protocol FD communications.

◆ Processing Result (PARAM00)

The upper byte gives the processing result. The lower byte is used for system analysis.

Processing Result Value	Meaning
00□□ hex	Busy
10□□ hex	Complete
8y□□ hex	Error

When an error occurs, refer to the following details on errors and perform troubleshooting.

Error	Meaning	Description
80□□ hex	–	Reserved for system.
81□□ hex	–	–
82□□ hex	Address setting error	The setting of one or more of the following parameters is out of range. Check the settings. PARAM05 (Data Address) PARAM11 (Hold Register Offset)
83□□ hex	Data size error	The data size for sending or receiving is out of range. Check PARAM06 (Data Size).
84□□ hex	Circuit number setting error	The circuit number is out of range. Check the circuit number (Cir-No) in the MSG-SND function.
85□□ hex	Channel number setting error	The channel number for the communications buffer is out of range. Check the communications buffer channel number (Ch-No) in the MSG-SND function.
86□□ hex	–	–
87□□ hex	–	Reserved for system.

Continued on next page.

Continued from previous page.

Error	Meaning	Description
88□□ hex	Communications device error	An error response was returned from the communications device. Check the connections to the device. Also check to see if the remote device is ready to communicate.
89□□ hex	Device select error	A device that cannot be used was selected. Check the communications device type (Dev-Typ) in the MSG-SND function.

◆ Status (PARAM01)

This parameter gives the status of the communications device.

The following figure shows the bit assignments and it is followed by a detailed description of each assignment.

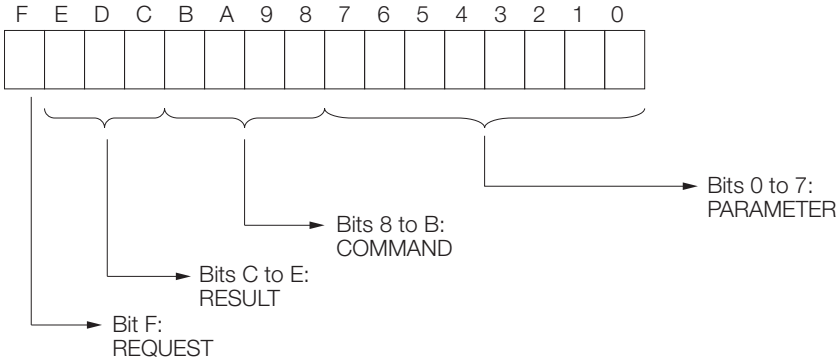

■ REQUEST

This bit gives the status of the processing request for the MSG-SND function.

Bit Status	Meaning
1	Processing is being requested.
0	Processing request has ended.

■ RESULT

These bits give the execution result of the MSG-SND function.

Code	Abbreviation	Meaning
1	SEND_OK	The message was sent normally.
2	REC_OK	The message was received normally.
3	ABORT_OK	The request to abort execution was completed.
4	FMT_NG	A parameter formatting error occurred.
5	SEQ_NG	A command sequence error occurred.
6	RESET_NG	A reset occurred.
7	REC_NG	A data reception error (error detected in the lower-layer program) occurred.

■ COMMAND

These bits indicate the processing command of the MSG-SND function. The processing that was executed depends on the command.

Code (Hex)	Abbreviation	Meaning
1	U_SEND	General-purpose message transmission
2	U_REC	General-purpose message reception
3	ABORT	Forced abort
8	M_SEND	MEMOBUS command transmission: Completed when response is received. (for the MEMOBUS protocol)
9	M_REC	MEMOBUS command transmission: Completed when response is sent. (for the MEMOBUS protocol)
C	MR_SEND	MEMOBUS response transmission (for the MEMOBUS protocol)

■ **PARAMETER**

When RESULT = 4 (FMT_NG: parameter formatting error), these bits will indicate an error code from the following table.

RESULT	Code	Meaning
When RESULT = 4 (FMT_NG: Parameter Formatting Error)	00	No error
	01	Station address out of range
	02	Watchdog error for MEMOBUS response (for the MEMOBUS protocol)
	03	Error in number of retries setting
	04	Error in cyclic area setting
	05	CPU number error
	06	Data address error
	07	Data size error
	08	Function code error (for the MEMOBUS protocol)

◆ **Data Address (PARAM05)**

Set the first address of the data.

Enter the first address as a decimal or hexadecimal number.

Information If the first address is MW01000, enter “1000” (decimal) or “3E8” (hexadecimal).

The following table lists the setting ranges of data addresses.

No-Protocol Communications Type	Target Data Type	Function	Data Address Setting Range
No-protocol communications 1	W	Sends data in units of words.	0 to 65534 (0 to FFFE hex)
No-protocol communications 2	B	Sends data in units of bytes.*	0 to 65534 (0 to FFFE hex)

* The unit for setting addresses is words.

◆ **Data Size (PARAM06)**

Set the size of the data for the write request as the number of words or bytes.

Be sure that the last data address that is determined by the offset, data address, and data size does not exceed the valid data address range.

The range that is allowed for the data size depends on the function code and communications device.

No-Protocol Communications Type	Target Data Type	Function	Data Address Setting Range
No-protocol communications 1	W	Sends data in units of words.	1 to 254
No-protocol communications 2	B	Sends data in units of bytes.	1 to 508

Note: The data sizes in the table are in decimal notation.

◆ **Register Offset (PARAM11)**

Set the offset for the address of the write data source on the sending node.

The sending node will offset the address back by the number of words specified by the offset.

Note: A negative value cannot be set as the offset value.

Example To offset the register address by 1000 words:
PARAM11 = 1000

◆ **Reserved for System 1 (PARAM12)**

This parameter is used by the system. It contains the channel number of the communications buffer that is currently in use.

Information A user program must set PARAM12 to 0 on the first scan after startup. Thereafter, do not change the value of PARAM12 from a user program or by any other means. PARAM12 will be used by the system.

◆ **Reserved for System 2 (PARAM13 to PARAM16)**

These parameters are used by the system. Do not change the values of PARAM13 to PARAM16 from a user program or by any other means.

3.4.4 MSG-RCV Function

Inputs and Outputs for the MSG-RCV Function

The inputs and outputs for the MSG-RCV function are the same as the inputs and outputs for the MSG-RCVE function.

Refer to the following section for more information.

 *Inputs and Outputs for the MSG-RCVE Function on page 2-20*

MSG-RCV Function Parameters

No-protocol communications stores the received data in M registers as is without performing protocol conversion.

This allows data to be received using any protocol matched to the other device.

No.	I/O	Meaning	Description
00	Outputs	Processing Result	Gives the processing status.
01		Status	Gives the status of the communications device.
02		Remote Station Number	Not used in no-protocol FD communications.
03		Option	Gives the receive status when there is an error.
04		Function Code	Not used in no-protocol FD communications.
05		Data Address	Not used in no-protocol FD communications.
06		Data Size	Gives the data size that was received from the remote station.
07		Remote CPU Module Number	Not used in no-protocol FD communications.
08	Inputs	Coil Offset	Not used in no-protocol FD communications.
09		Input Relay Offset	Not used in no-protocol FD communications.
10		Input Register Offset	Not used in no-protocol FD communications.
11		Hold Register Offset	Not used in no-protocol FD communications.
12		Writing Range LO	Sets the first address of the writing range.
13		Writing Range HI	Sets the last address of the writing range.
14	System	Reserved for system 1	Not used in no-protocol FD communications.
15, 16		Reserved for system 2	Not used in no-protocol FD communications.

◆ **Processing Result (PARAM00)**

This parameter gives the processing result.

Processing Result Value	Meaning
00□□ hex	Busy
10□□ hex	Complete
8y□□ hex	Error

When an error occurs, refer to the following details on errors and perform troubleshooting.

Error	Meaning	Description
80□□ hex	–	Reserved for system.
81□□ hex	–	–
82□□ hex	Address setting error	The setting of one or more of the following parameters is out of range. Check the settings. PARAM12 (Register Offset)
83□□ hex	Data size error	The data size for receiving is out of range. Check the data size of the sending node.
84□□ hex	Circuit number setting error	The circuit number is out of range. Check the circuit number (Cir-No) in the MSG-RCV function.
85□□ hex	Channel number setting error	The channel number for the communications buffer is out of range. Check the communications buffer channel number (Ch-No) in the MSG-RCV function.
86□□ hex	–	–
87□□ hex	–	Reserved for system.
88□□ hex	Communications device error	An error response was returned from the communications device. Check the connections to the device. Also check to see if the remote device is ready to communicate.
89□□ hex	Device select error	A device that cannot be used was selected. Check the communications device type (Dev-Typ) in the MSG-RCV function.

◆ Status (PARAM01)

This parameter gives the status of the communications device.

The following figure shows the bit assignments and it is followed by a detailed description of each assignment.

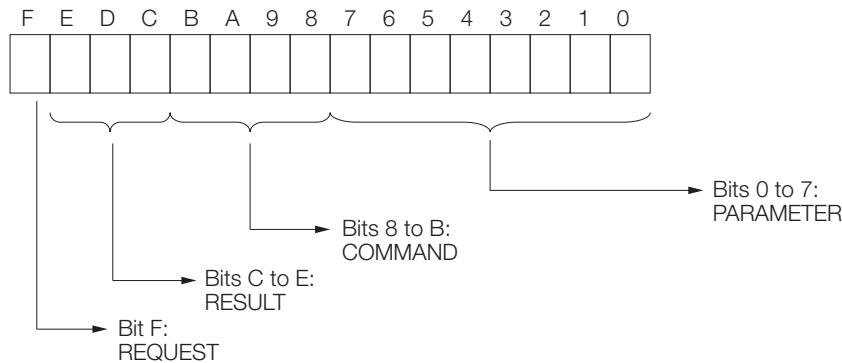

■ REQUEST

This bit gives the status of the processing request for the MSG-RCV function.

Bit Status	Meaning
1	Processing is being requested.
0	Processing request has ended.

■ RESULT

These bits give the execution result of the MSG-RCV function.

Code	Abbreviation	Meaning
1	SEND_OK	The message was sent normally.
2	REC_OK	The message was received normally.
3	ABORT_OK	The request to abort execution was completed.
4	FMT_NG	A parameter formatting error occurred.
5	SEQ_NG	A command sequence error occurred.
6	RESET_NG	A reset occurred.
7	REC_NG	A data reception error (error detected in the lower-layer program) occurred.

■ **COMMAND**

These bits indicate the processing command of the MSG-RCV function.

Code (Hex)	Abbreviation	Meaning
1	U_SEND	General-purpose message transmission
2	U_REC	General-purpose message reception
3	ABORT	Forced abort
8	M_SEND	MEMOBUS command transmission: Completed when response is received. (for the MEMOBUS protocol)
9	M_REC	MEMOBUS command transmission: Completed when response is sent. (for the MEMOBUS protocol)
C	MR_SEND	MEMOBUS response transmission (for the MEMOBUS protocol)

■ **PARAMETER**

When RESULT = 4 (FMT_NG: parameter formatting error), these bits will indicate an error code from the following table.

RESULT	Code	Meaning
When RESULT = 4 (FMT_NG: Parameter Formatting Error)	00	No error
	01	Connection number out of range
	02	Watchdog error for MEMOBUS response (for the MEMOBUS protocol)
	03	Error in number of retries setting
	04	Error in cyclic area setting
	05	CPU number error
	06	Data address error
	07	Data size error
	08	Function code error (for the MEMOBUS protocol)

◆ **Options (PARAM03)**

This parameter gives the receive status when there is an error.

This parameter is used only if No-Protocol FD is selected in the communications protocol in the 2171F Detail Definition Dialog Box. This parameter cannot be used if No-Protocol is selected.

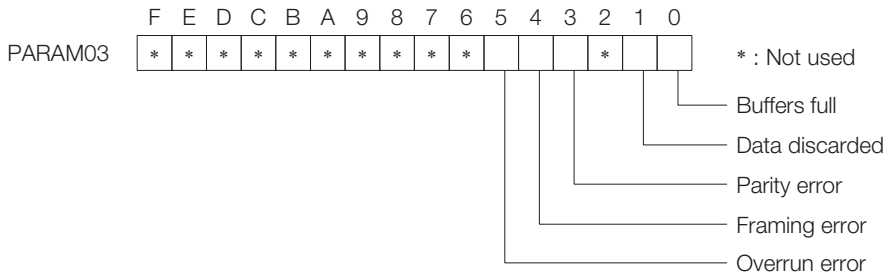

Bit	Name	Meaning	Description
Bit 0	Buffers full	This bit is turned ON when 20 receive buffers were fully used and data could not be received. 0: No buffer overflow 1: Buffer overflow occurred	There was data that could not be received because the buffers were filled before the data that was currently read.
Bit 1	Data discarded	This bit is turned ON when data was discarded by the system because data could not be obtained with the MSG-RCV function in a 400-ms period from when the data was received. 0: No discarded data due to timeout 1: Data was discarded due to timeout	There was data that was discarded due to a timeout before the data that was currently read.

Continued on next page.

Continued from previous page.

Bit	Name	Meaning	Description
Bit 3	Parity error	This bit is turned ON when a parity error occurs. 0: No parity error 1: Parity error occurred	There was data that could not be received due to a parity error in the data that was currently read.
Bit 4	Framing error	This bit is turned ON when a framing error occurs. 0: No framing error 1: Framing error occurred	There was data that could not be received due to a framing error in the data that was currently read.
Bit 5	Overrun error	This bit is turned ON when an overrun error occurs. 0: No overrun error 1: Overrun error occurred	There was data that could not be received due to an overrun error in the data that was currently read.

◆ Data Size (PARAM06)

This parameter gives the size of the received data.

The number of words is given for no-protocol communications 1.

The number of bytes is given for no-protocol communications 2.

◆ Writing Range (PARAM12 and PARAM13)

For no-protocol communications, the received consecutive data is stored in M registers.

An error will occur if a request was made to write a value that does not correspond to PARAM12 (Write Range LO) to PARAM13 (Write Range HI).

Specify the writing range (PARAM12 and PARAM13) with word addresses.

Set the writing range so that it satisfies the following condition:

$0 \leq \text{Writing range} \leq \text{Maximum M register address}$

Example Use the following settings to set the allowable writing range of M register addresses to MW01000 to MW01999:
PARAM12 = 1000
PARAM13 = 1999

◆ Reserved for System 1 (PARAM14)

This parameter is used by the system. It contains the channel number of the communications buffer that is currently in use.

Information A user program must set PARAM14 to 0 on the first scan after startup. Thereafter, do not change the value of PARAM14 from a user program or by any other means. PARAM14 will be used by the system.

◆ Reserved for System 2 (PARAM15 and PARAM16)

These parameters are used by the system. Do not change the values of PARAM15 and PARAM16 from a user program or by any other means.

Using Ethernet Communications

4

This chapter describes the operating methods for performing Ethernet communications with controllers from various manufacturers using the MEMOBUS message communications method or the no-protocol communications method.

4.1 Communications with MP-series Controllers . . 4-3

- 4.1.1 Using Automatic Reception with the MP3000 as a Slave 4-3
- 4.1.2 Using the MSG-RCVE Function with the MP3000 as a Slave 4-13
- 4.1.3 Using I/O Message Communications with the MP3000 as the Master 4-23
- 4.1.4 Using the MSG-SNDE Function with the MP3000 as the Master 4-31
- 4.1.5 Message Functions 4-39

4.2 Communications with a Touch Panel 4-48

- 4.2.1 Using Automatic Reception with the MP3000 as a Slave 4-48

4.3 Communications with a Mitsubishi PLC (A-compatible 1E Frame Protocol) . . 4-55

- 4.3.1 Using Automatic Reception with the MP3000 as a Slave 4-55
- 4.3.2 Using I/O Message Communications with the MP3000 as the Master 4-59
- 4.3.3 Using the MSG-SNDE Function with the MP3000 as the Master 4-64
- 4.3.4 Message Functions 4-70

4.4	Communications with a Mitsubishi PLC (QnA-compatible 3E Frame Protocol) . . .	4-84
4.4.1	Using I/O Message Communications with the MP3000 as the Master	4-84
4.4.2	Using the MSG-SNDE Function with the MP3000 as the Master	4-90
4.4.3	Message Functions	4-101
4.5	Communications with an OMRON PLC (FINS Communications Service) . . .	4-117
4.5.1	Using Automatic Reception with the MP3000 as a Slave	4-117
4.5.2	Using the MSG-RCVE Function with the MP3000 as a Slave	4-125
4.5.3	Using I/O Message Communications with the MP3000 as the Master	4-134
4.5.4	Using the MSG-SNDE Function with the MP3000 as the Master	4-140
4.5.5	Routing	4-149
4.5.6	Message Functions	4-151
4.6	Communications with a KOYO PLC (MODBUS/TCP Protocol) . . .	4-164
4.6.1	Using Automatic Reception with the MP3000 as a Slave	4-164
4.6.2	Using I/O Message Communications with the MP3000 as the Master	4-169
4.6.3	Using the MSG-SNDE Function with the MP3000 as the Master	4-173
4.6.4	Message Functions	4-179
4.7	Communications with a JTEKT PLC (TOYOPUC Protocol) . . .	4-188
4.7.1	Using Automatic Reception with the MP3000 as a Slave	4-188
4.7.2	Using the MSG-RCVE Function with the MP3000 as a Slave	4-196
4.7.3	Using the MSG-SNDE Function with the MP3000 as the Master	4-205
4.7.4	Message Functions	4-214
4.8	No-Protocol Communications	4-225
4.8.1	Using the MSG-SNDE and MSG-RCVE Functions with the MP3000 as the Master	4-225

4.1**Communications with MP-series Controllers**

When using Ethernet communications between the MP3000 and other MP-series Controllers, use the Extended MEMOBUS protocol as the communications protocol. The Extended MEMOBUS protocol allows the master to read and write the slave registers.

This section describes communications when the MP3000 acts as a slave and as the master. When the MP3000 acts as a slave, communications can take place using automatic reception or using the MSG-RCVE function.

When the MP3000 acts as the master, communications can take place using I/O message communications or the MSG-SNDE function.

4.1.1**Using Automatic Reception with the MP3000 as a Slave**

This section describes how to communicate with the MP2300 by using automatic reception.

Setting Example

The following figure illustrates how the contents of the MW00000 to MW00099 hold registers in the MP2300 master are written to the MW00000 to MW00099 hold registers in the MP3000 slave.

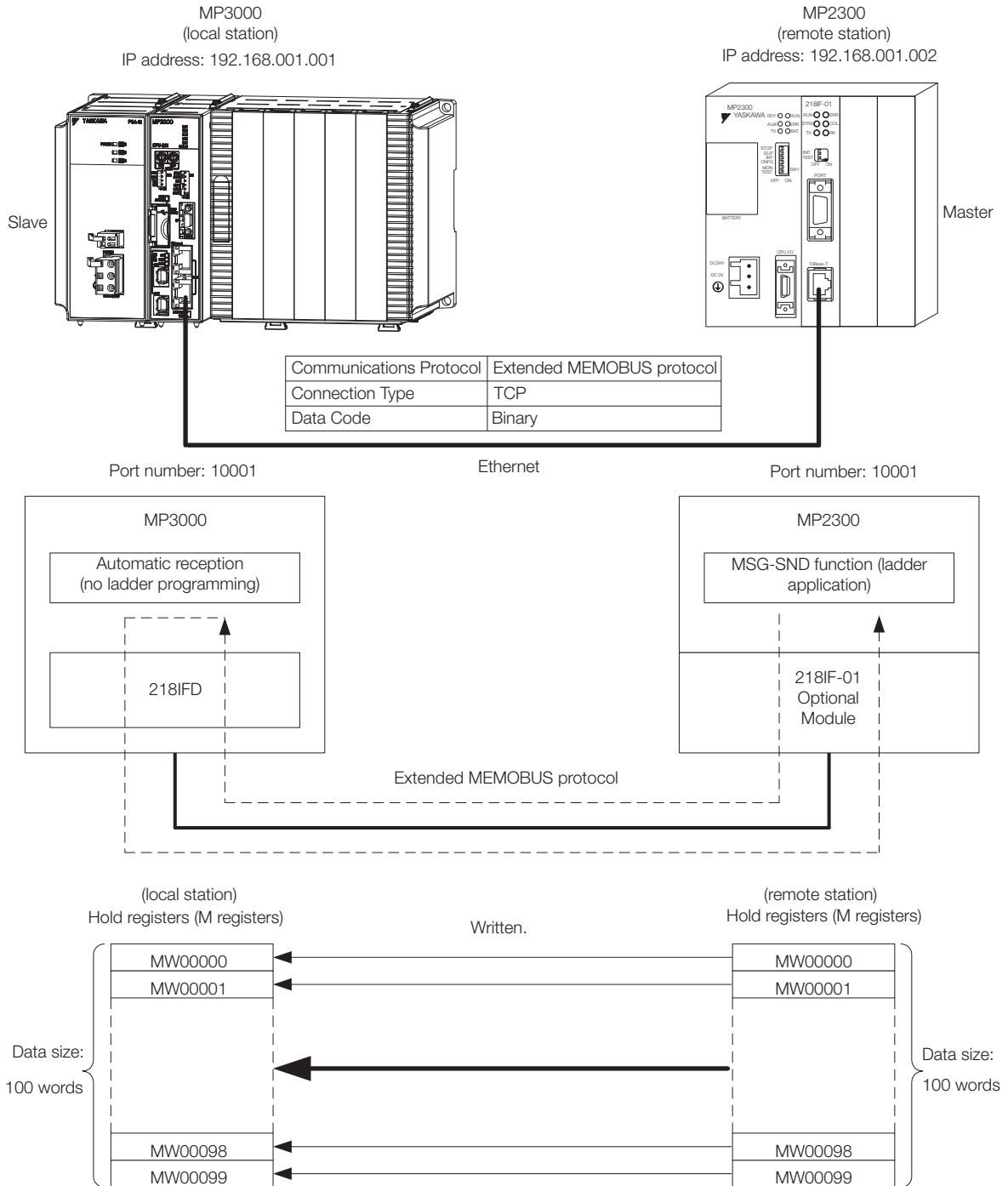

MP3000 Setup

Use the following procedure to set up the MP3000.

Information If the communications parameters (IP address and subnet mask) have already been set, skip to step 3.

1. Double-click the cell for 218IFD in the Module Configuration Definition Tab Page.

Module	Function Module/Slave	Status	Circuit No./AxisAddress		Motion Register	Register(Input/Output)		
			Start	cupied circ		Disabled	Start - End	Size
01 [CPU-302(32axes)] - ---								
800-NEW 10 00 CPU302(32)-----	01 CPU	---	---	---	---			
	02 218IFD	---	品	Circuit No1	1	<input type="checkbox"/> Input <input type="checkbox"/> OutPut	0000 - 07FF[H]	2048
	03 SVC32	---	品	Circuit No1	1	<input type="checkbox"/> Input <input type="checkbox"/> OutPut	0800 - 0BFF[H]	1024
	04 SVR32	---	品	Circuit No3	1			
	05 M-EXECUTOR	---						
	06 -- UNDEFINED --							
	07 -- UNDEFINED --							
01 -- UNDEFINED --[-----]								
02 -- UNDEFINED --[-----]								
03 -- UNDEFINED --								
02 -- UNDEFINED --								
02 -- UNDEFINED --								
03 -- UNDEFINED --								
04 -- UNDEFINED --								

The 218IFD Detail Definition Dialog Box will be displayed.

2. Set the communications parameters.

- ① In the [IP Address] Boxes, enter the following address: 192.168.001.001.
- ② In the [Subnet Mask Boxes], enter the following mask: 255.255.255.000.
- ③ In the [Gateway IP Address] Boxes, enter the following address: 000.000.000.000.

3. Click the [Easy setting] Button in the [Message Communication] Area in the [Connection Parameter] Area.

CNO	Local Port	Node IP Address	Node Port	Connect Type	Protocol Type	Code	Detail
01	----						Setting*
02	----						Setting*
03	----						Setting*
04	----						Setting*
05	----						Setting*
06	----						Setting*
07	----						Setting*

The Message Communication Easy Setting Dialog Box will be displayed.

4. Set the connection parameters.

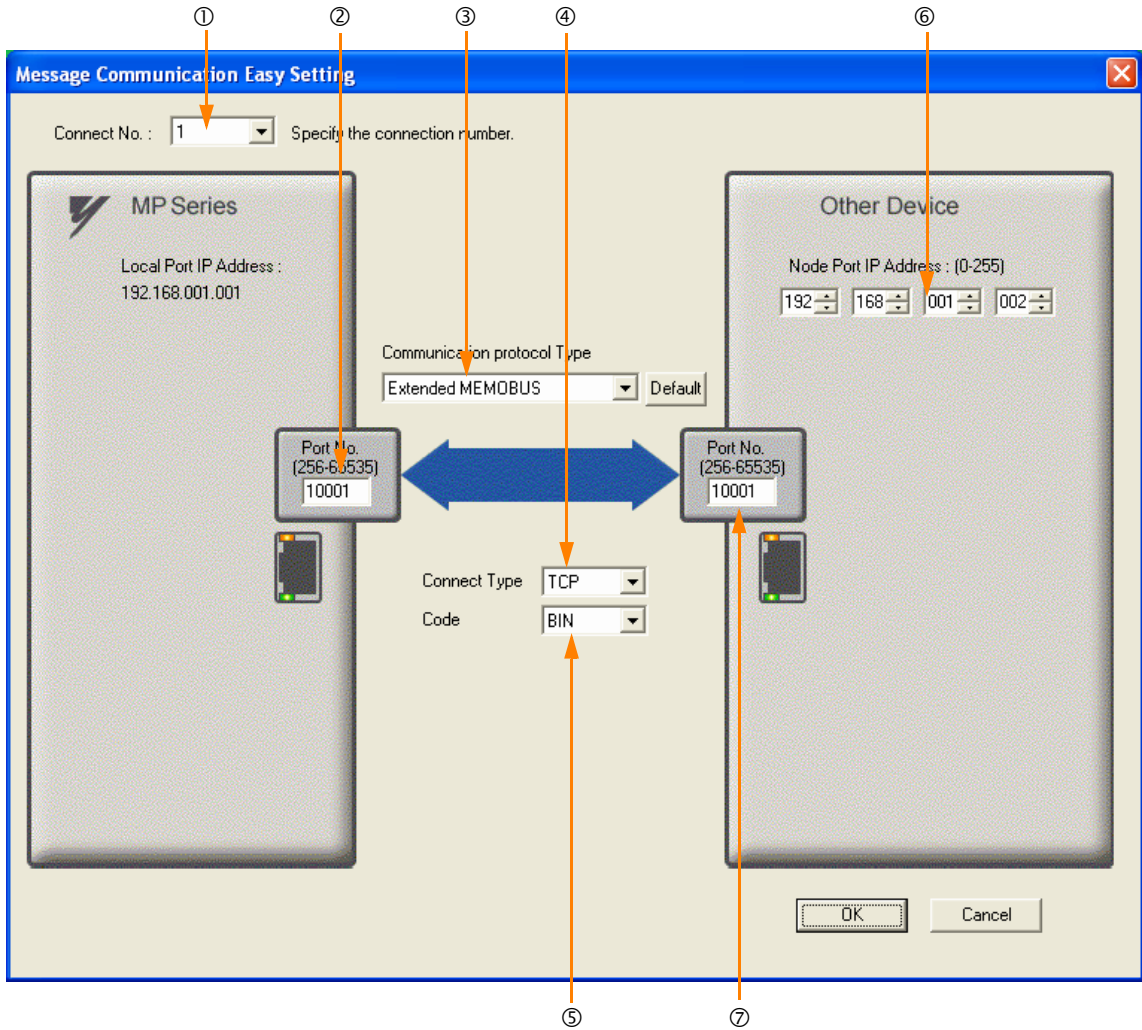

- ① Select [1] in the [Connect No.] Box.
- ② Enter "10001" in the [Port No.] Box for the MP-series Controller.
- ③ Select [Extended MEMOBUS] in the [Communications Protocol Type] Box, and then click the [Default] Button.
- ④ Select [TCP] in the [Connect Type] Box.
- ⑤ Select [BIN] in the [Code] Box.
- ⑥ Enter the following address in the [Node Port IP Address] Boxes for the other device:
192.168.001.002.
- ⑦ Enter "10001" in the [Port No.] Box for the other device.

5. Click the [OK] Button.

6. Click the [Yes] Button in the Transmission Parameters Confirmation Dialog Box.

Note: If parameters have already been set for the same connection number and you click the [Yes] Button in the Transmission Parameters Confirmation Dialog Box, the settings will be overwritten by the parameters that are set in the Message Communications Easy Setting Dialog Box.

7. Check the settings and double-click the [Setting] Button in the [Detail] Column.

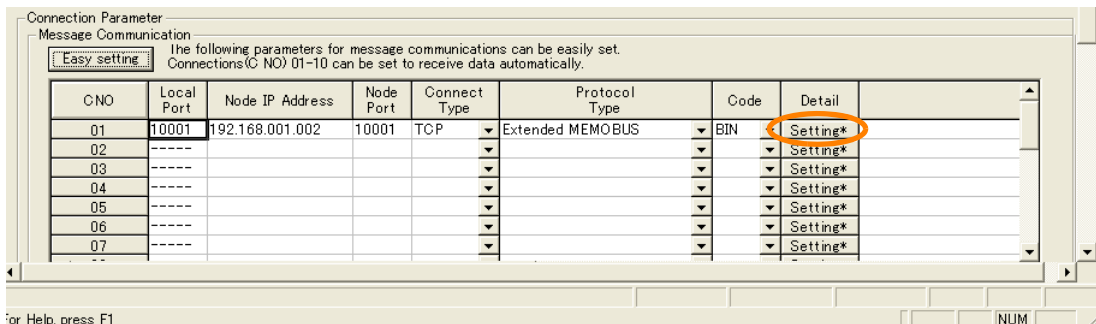

8. Select the [Enable] Option in the Automatically Reception Tab Page and then click the [OK] Button.

Detail Setting

Automatically Reception

Disable Unable to automated reception, when the protocol type is no control sequence.

Enable

Transmission Buffer Channel: 1

Slave I/F Register Settings	Head REG
Readout of Input Relay	IW00000
Readout of Input Register	IW00000
Readout / Write-in of Coil	MW00000
Readout / Write-in of Hold Register	MW00000
Readout / Write-in of Data Relay	GW00000
Readout / Write-in of Data Register	GW00000
Readout / Write-in of Output Coil	OW00000
Readout / Write-in of Output Register	OW00000
Write - in width of Coil/Hold Register	LO: MW00000 HI: MW1048575
Write - in width of Data Relay/Register	LO: GW00000 HI: GW2097151
Write - in width of Output Coil/Register	LO: OW00000 HI: OW17FFF

Automatic input processing delay time: 0 ms (0-100)

The influence on a low-speed scanning can be adjusted according to this parameter.
[Attention] It is not in the setting of the communication period of an automatic reception.

OK Cancel

Note: Disable automatic reception for any connection for which message functions (MSG-SNDE and MSG-RCVE) are used. If message functions are used while automatic reception is enabled, the communications will not function properly.

9. Save the data to flash memory.

Note: Changes made to the communications or connection parameters will become effective only after the changes have been saved to flash memory and the power supply has been cycled.

This concludes the settings for using the MP3000 as a slave.

◆ Setting Up the Remote Device (MP2300)

Use the following procedure to set up the MP2300.

Information If the communications parameters (IP address and subnet mask) have already been set, skip to step 3.

1. Double-click the cell for [218IF] in the [Function Module/Slave] Area of the Module Configuration Definition Tab Page.

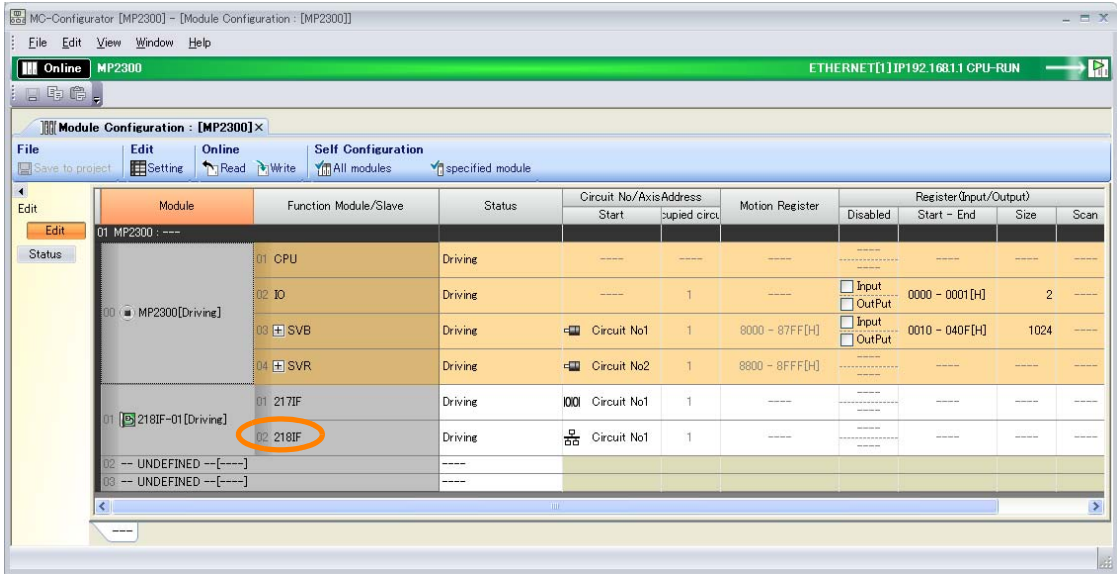

The 218IF Detail Definition Dialog Box will be displayed.

2. Set the communications parameters.

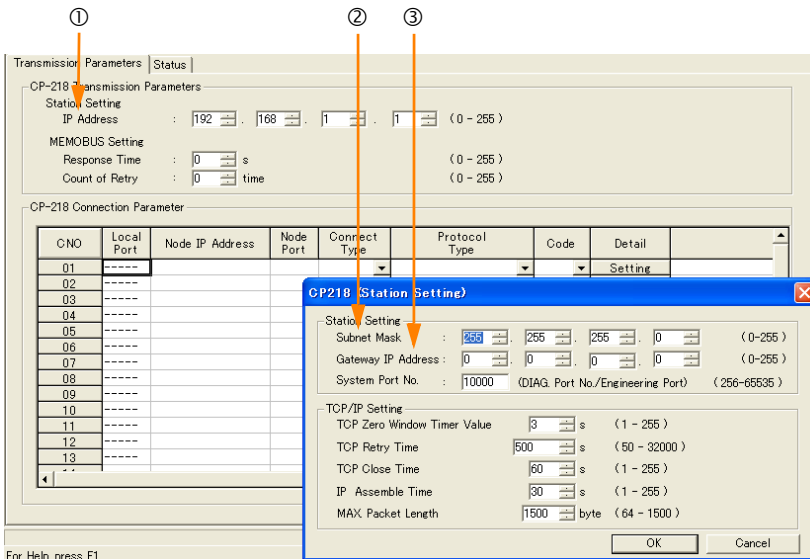

- ① In the [IP Address] Boxes, enter the following address: 192.168.001.002.
- ② In the [Subnet Mask] Boxes, enter the following mask: 255.255.255.000.
- ③ In the [Gateway IP Address] Boxes, enter the following address: 000.000.000.000.

3. Set the connection parameters.

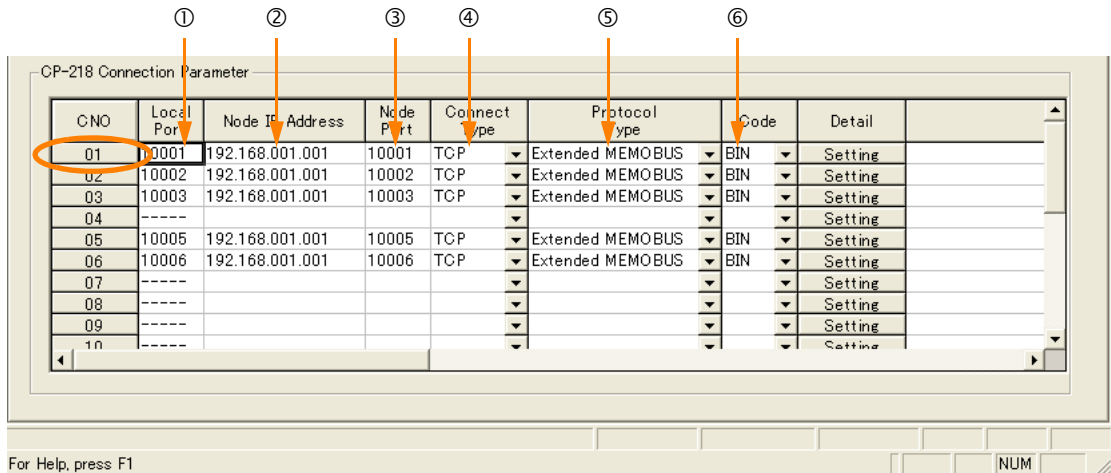

- ① Enter "10001" in the [Local Port] Box.
- ② Enter the following address in the [Node IP Address] Boxes: 192.168.001.001.
- ③ Enter "10001" in the [Node Port] Box.
- ④ Select [TCP] in the [Connect Type] Box.
- ⑤ Select [Extended MEMOBUS] in the [Protocol Type] Box.
- ⑥ Select [BIN] in the [Code] Box.

Note: Changes made to the communications or connection parameters will become effective only after the changes have been saved to flash memory and the power supply has been cycled.

4.1 Communications with MP-series Controllers

4.1.1 Using Automatic Reception with the MP3000 as a Slave

4. Create a ladder program for the MSG-SND function.

A ladder program example is shown below.

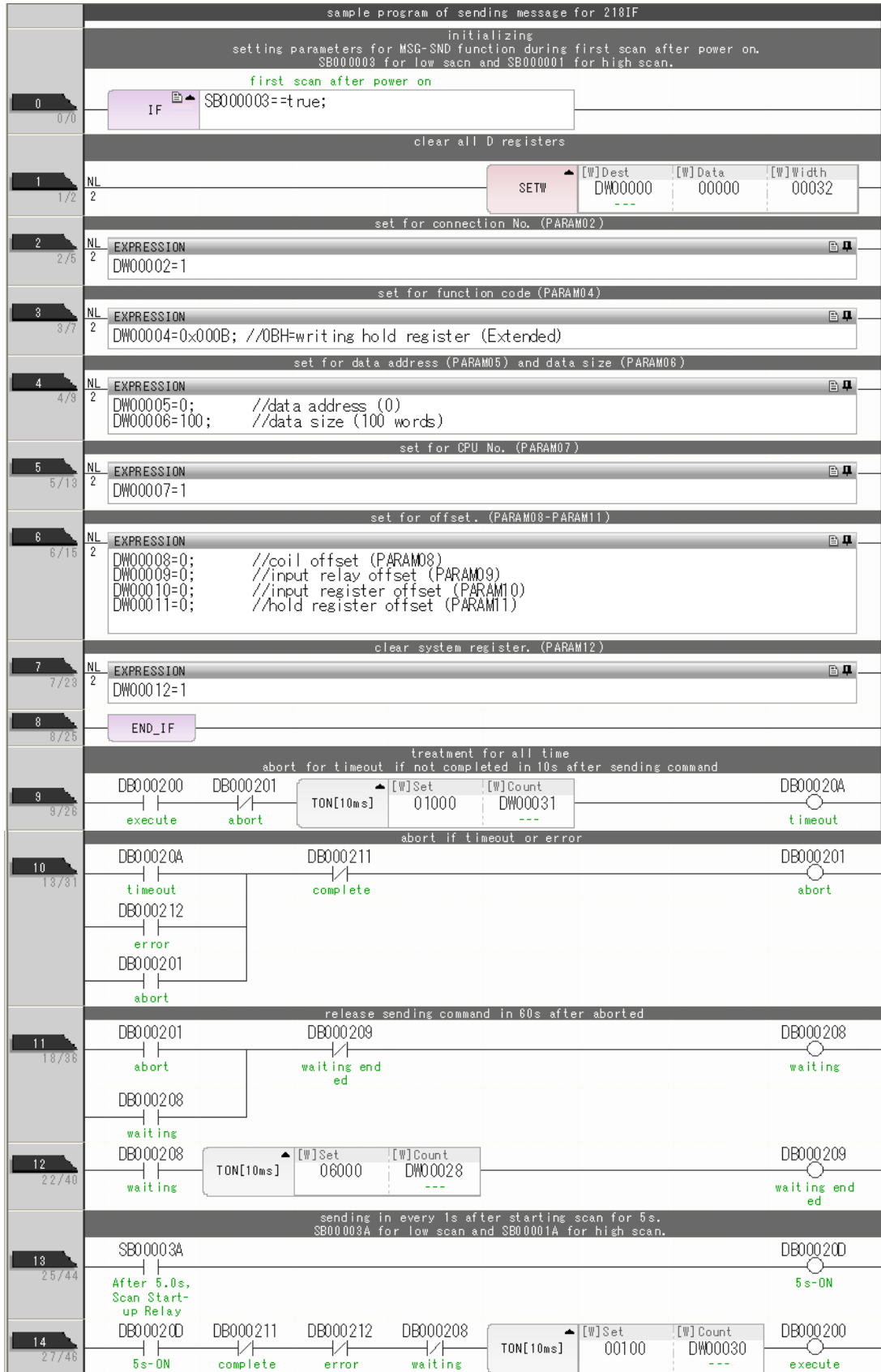

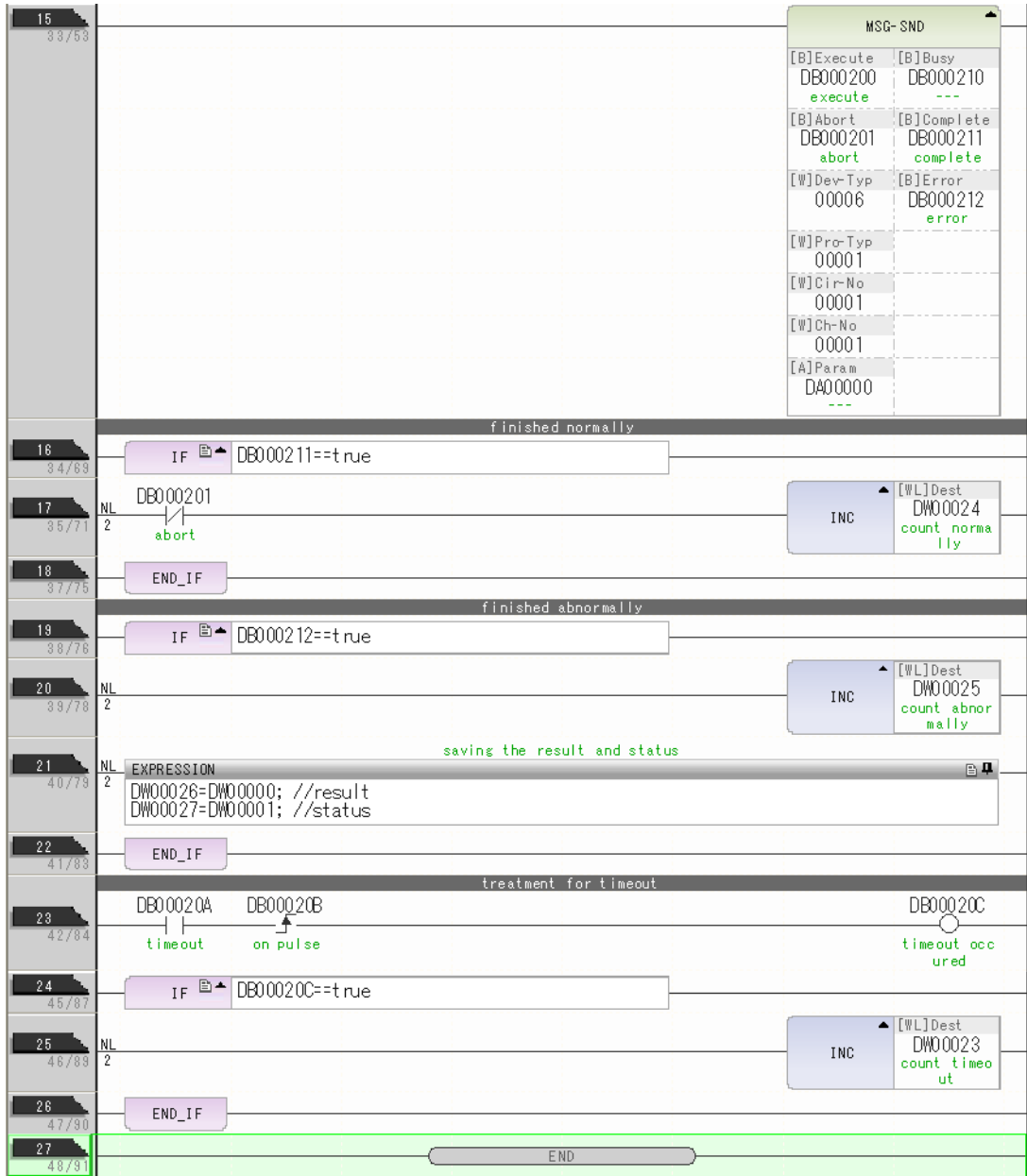

5. Save the data to flash memory.
 This concludes the setup.

◆ Starting Communications

1. Turn ON the power to the MP3000 to start receiving messages.
The system will automatically start the message reception operation. No further operation is required.
2. Turn ON the Execute Bit (e.g., DB000200) for the MSG-SND function in the MP2300 to start sending messages.
The ladder program example is designed to send a message every second after five seconds have elapsed from when the low-speed scan (or high-speed scan) starts.
To change the message transmission interval, change the timer value ①.

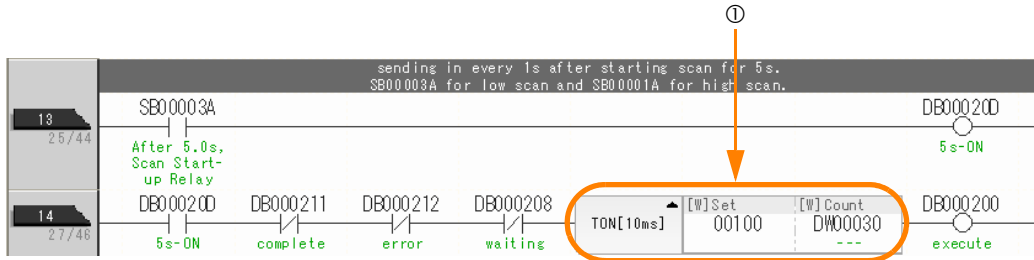

4.1.2 Using the MSG-RCVE Function with the MP3000 as a Slave

You can use the MSG-RCVE function together with automatic reception by maintaining a separate connection.

This section describes how to communicate with the MP2300 by using the MSG-RCVE function.

Setting Example

The following figure illustrates how the contents of the MW00100 to MW00199 hold registers in the MP2300 master are written to the MW00100 to MW00199 hold registers in the MP3000 slave.

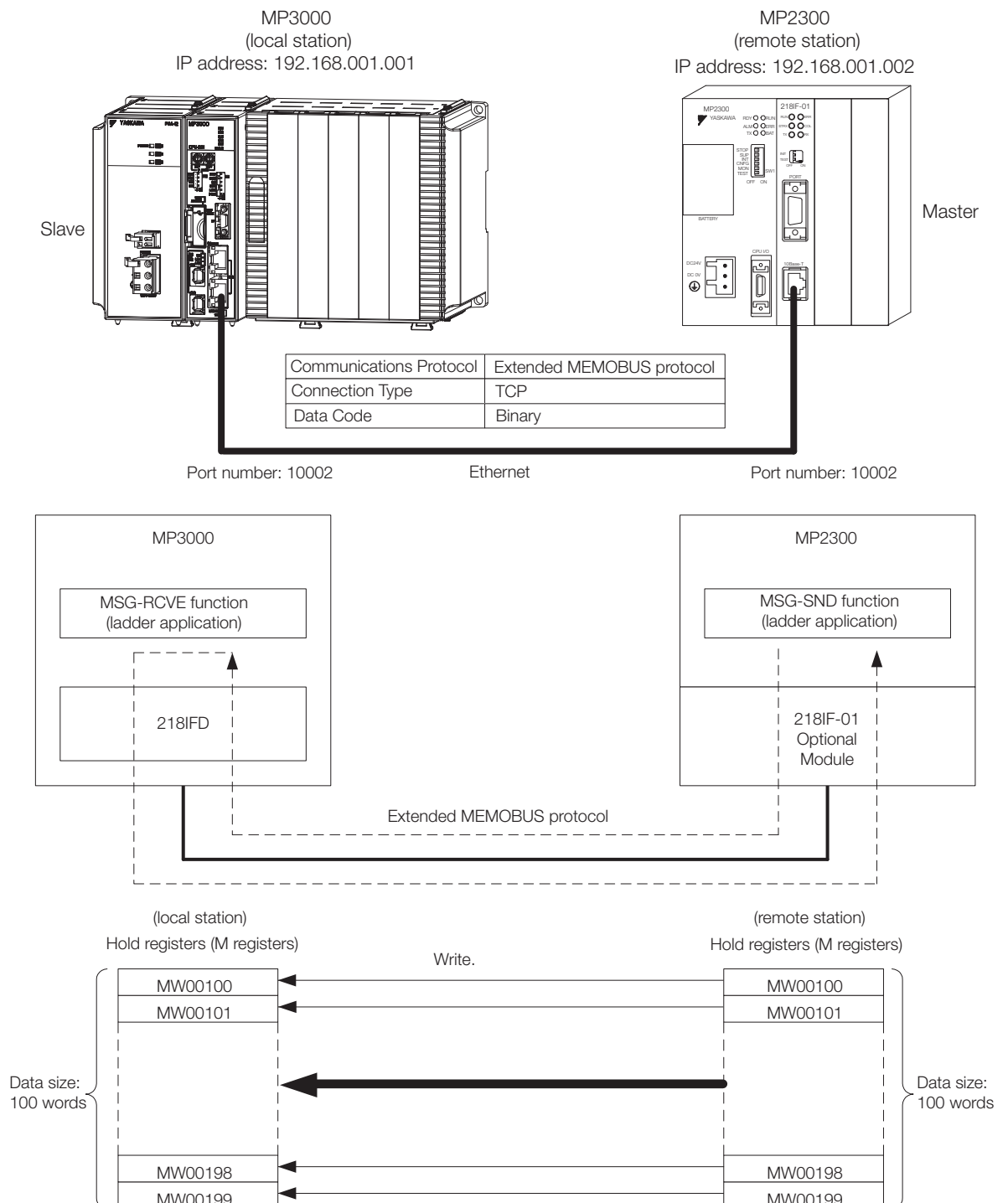

MP3000 Setup

Use the following procedure to set up the MP3000.

Information If the communications parameters (IP address and subnet mask) have already been set, skip to step 3.

1. Double-click the cell for 218IFD in the Module Configuration Definition Tab Page.

Module	Function Module/Slave	Status	Circuit No./AxisAddress		Motion Register	Register(Input/Output)		
			Start	cupied circ.		Disabled	Start - End	Size
01 [CPU-302(32axes)] : ---	01 CPU	----	----	----	----	-----	-----	----
800-NEW I/O	02 218IFD	----	□ Circuit No 1	1	----	Input Output	0000 - 07FF[H]	2048
	03 SVC32	----	■ Circuit No 1	1	8000 - 87FF[H]	Input Output	0800 - 0BFF[H]	1024
	04 SVR32	----	■ Circuit No 3	1	9000 - 97FF[H]	-----	-----	----
	05 M-EXECUTOR	----	----	----	----	-----	0C00 - 0C3F[H]	64
	06 -- UNDEFINED --	----	----	----	----	-----	-----	----
07 -- UNDEFINED --	----	----	----	----	-----	-----	----	
01 -- UNDEFINED -- [-----]	----	----	----	----	-----	-----	----	
02 -- UNDEFINED -- [-----]	----	----	----	----	-----	-----	----	
03 -- UNDEFINED --	----	----	----	----	-----	-----	----	
02 -- UNDEFINED --	----	----	----	----	-----	-----	----	
02 -- UNDEFINED --	----	----	----	----	-----	-----	----	
03 -- UNDEFINED --	----	----	----	----	-----	-----	----	
04 -- UNDEFINED --	----	----	----	----	-----	-----	----	

The 218IFD Detail Definition Dialog Box will be displayed.

2. Set the communications parameters.

Transmission Parameters | Status

Transmission Parameters

IP Address : 192 . 168 . 1 . 1 (0-255)

Subnet Mask : 255 . 255 . 255 . 0 (0-255)

Gateway IP Address : 0 . 0 . 0 . 0 (0-255)

Module Name Definition
Equipment name : CONTROLLER NAME

Detail Definition

- ① In the [IP Address] Boxes, enter the following address: 192.168.001.001.
- ② In the [Subnet Mask] Boxes, enter the following mask: 255.255.255.000.
- ③ In the [Gateway IP Address] Boxes, enter the following address: 000.000.000.000.

3. Click the [Easy setting] Button in the [Message Communication] Area in the [Connection Parameter] Area.

Connection Parameter

Message Communication

The following parameters for message communications can be easily set.
Connections(C NO) 01-10 can be set to receive data automatically.

Easy setting

CNO	Local Port	Node IP Address	Node Port	Connect Type	Protocol Type	Code	Detail
01	----						Setting*
02	----						Setting*
03	----						Setting*
04	----						Setting*
05	----						Setting*
06	----						Setting*
07	----						Setting*

The Message Communication Easy Setting Dialog Box will be displayed.

4. Set the connection parameters.

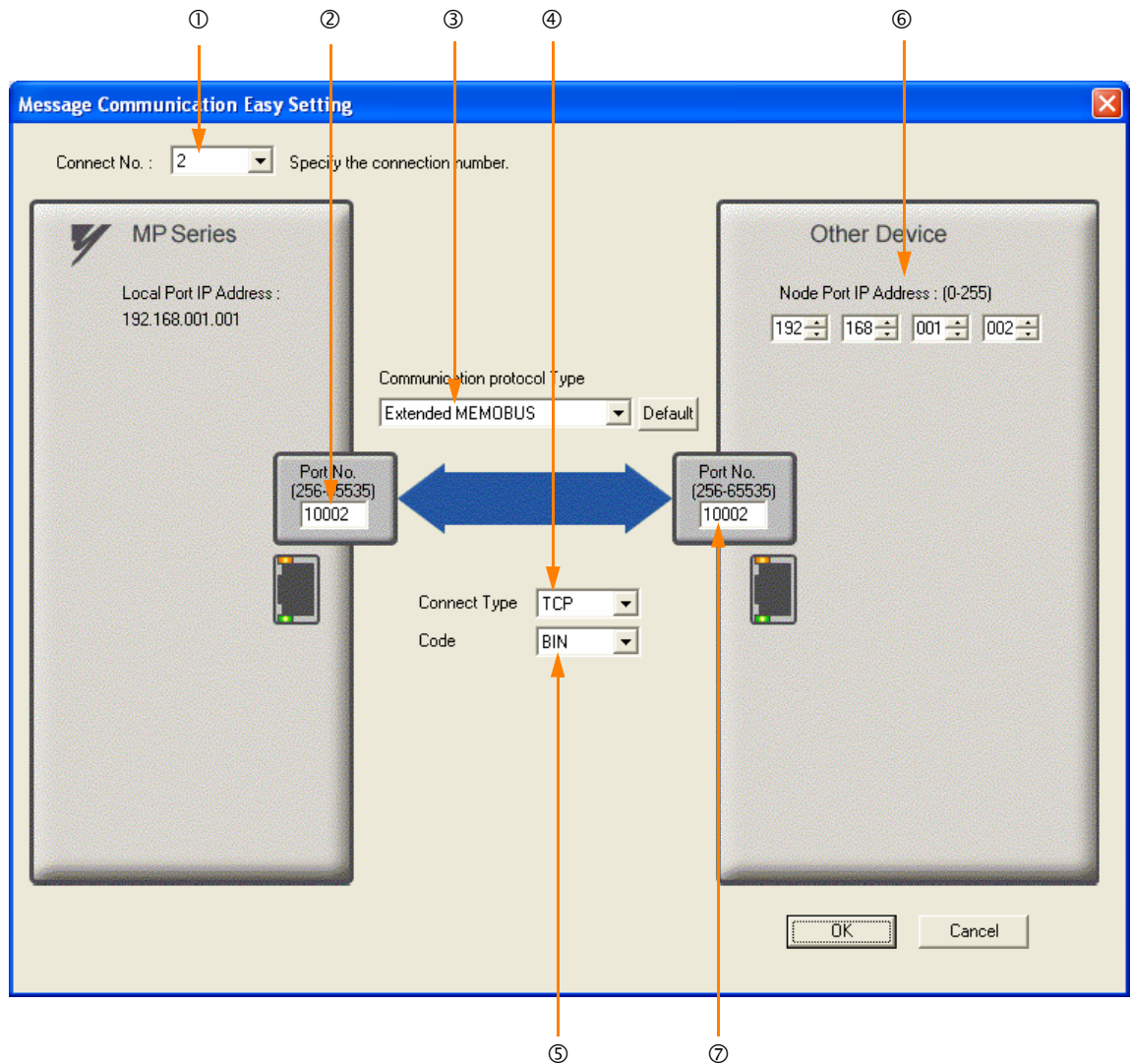

- ① Select [2] in the [Connect No.] Box.
- ② Enter "10002" in the [Port No.] Box for the MP-series Controller.
- ③ Select [Extended MEMOBUS] in the [Communications Protocol Type] Box, and then click the [Default] Button.
- ④ Select [TCP] in the [Connect Type] Box.
- ⑤ Select [BIN] in the [Code] Box.
- ⑥ Enter the following address in the [Node Port IP Address] Boxes for the other device:
192.168.001.002.
- ⑦ Enter "10002" in the [Port No.] Box for the other device.

Note: Disable automatic reception for any connection for which message functions (MSG-SNDE and MSG-RCVE) are used. If message functions are used while automatic reception is enabled, the communications will not function properly.

5. Click the [OK] Button.

6. Click the [Yes] Button in the Transmission Parameters Confirmation Dialog Box.

Note: If parameters have already been set for the same connection number and you click the [Yes] Button in the Transmission Parameters Confirmation Dialog Box, the settings will be overwritten by the parameters that are set in the Message Communications Easy Setting Dialog Box.

7. Check the settings and double-click the [Setting] Button in the [Detail] Column.

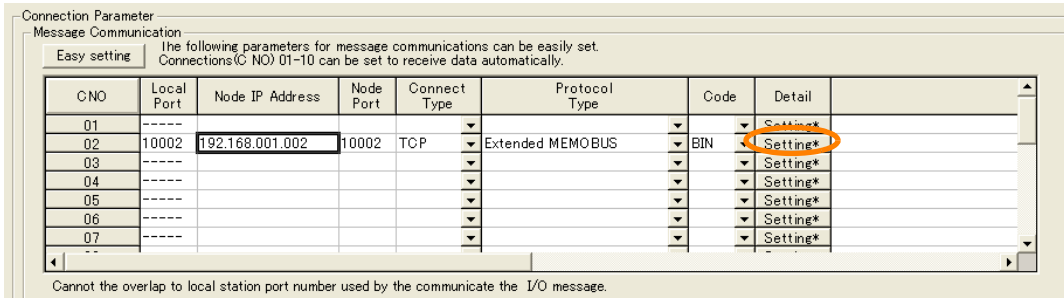

8. Select the [Disable] Option in the Automatically Reception Tab Page and then click the [OK] Button.

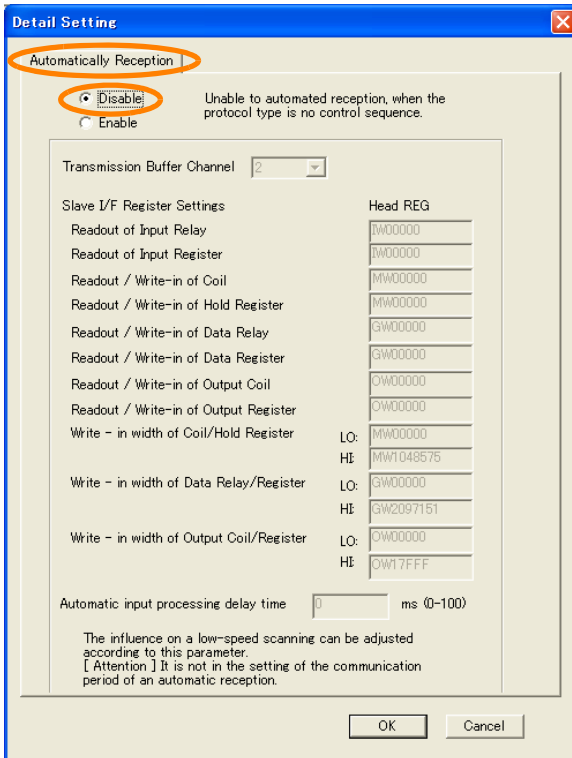

Note: Changes made to the communications or connection parameters will become effective only after the changes have been saved to flash memory and the power supply has been cycled.

9. Create a ladder program for the MSG-RCVE function.

A ladder program example is shown below.

```

    ■ Initializing
    setting parameters for MSG-RCVE function during first scan after power on.
    S8000003 for low scan and S8000001 for high scan.

    0 0/2 IF 'After Low Scan Start, Only 1 Scan ON' == 'TRUE'
        LowScan.FirstScan == TRUE;

    1 1/2 NL
        clear all 0 registers

    2 2/2 NL
        set for connection No. (PARAM10)
        EXPRESSION
        'DW00110'=2
        DW00110=2; //using connection 2

    3 3/2 NL
        set for offset (PARAM20 to PARAM35)
        EXPRESSION
        'DW00120'=0
        DW00120=0; //coil offset MB low (0)
        'DW00121'=0
        DW00121=0; //coil offset MB high (0)
        'DW00122'=0
        DW00122=0; //input relay offset IB low (0)
        'DW00123'=0
        DW00123=0; //input relay offset IB high (0)
        'DW00124'=0
        DW00124=0; //input register offset IW low (0)
        'DW00125'=0
        DW00125=0; //input register offset IW high (0)
        'DW00126'=0
        DW00126=0; //hold register offset MW low (0)
        'DW00127'=0
        DW00127=0; //hold register offset MW high (0)
        'DW00128'=0
        DW00128=0; //data relay offset GB low (0)
        'DW00129'=0
        DW00129=0; //data relay offset GB high (0)
        'DW00130'=0
        DW00130=0; //data register offset GW low (0)
        'DW00131'=0
        DW00131=0; //data register offset GW high (0)
        'DW00132'=0
        DW00132=0; //output coil offset OB low (0)
        'DW00133'=0
        DW00133=0; //output coil offset OB high (0)
        'DW00134'=0
        DW00134=0; //output register offset OW low (0)
        'DW00135'=0
        DW00135=0; //output register offset OW high (0)

    4 4/2 NL
        M writing range (PARAM36 to PARAM39)
        EXPRESSION
        'DW00136'=0x000
        DW00136=0x000; //M writing range LO low
        'DW00137'=0x000
        DW00137=0x000; //M writing range LO high
        'DW00138'=0xFFFF
        DW00138=0xFFFF; //M writing range HI low
        'DW00139'=0x000F
        DW00139=0x000F; //M writing range HI high

    5 5/2 NL
        G writing range (PARAM40 to PARAM43)
        EXPRESSION
        'DW00140'=0x000
        DW00140=0x000; //G writing range LO low
        'DW00141'=0x000
        DW00141=0x000; //G writing range LO high
        'DW00142'=0xFFFF
        DW00142=0xFFFF; //G writing range HI low
        'DW00143'=0x001F
        DW00143=0x001F; //G writing range HI high

    6 6/2 NL
        O writing range (PARAM44 to PARAM47)
        EXPRESSION
        'DW00144'=0x000
        DW00144=0x000; //O writing range LO low
        'DW00145'=0x000
        DW00145=0x000; //O writing range LO high
        'DW00146'=0x7FFF
        DW00146=0x7FFF; //O writing range HI low
        'DW00147'=0x0001
        DW00147=0x0001; //O writing range HI high

    7 7/2 NL
        END_IF

    ■ treatment for all time
    receiving command created.

    8 8/2 OnCoil S8000004 DB000201 Always ON
        abort

    9 11/2 DB000200 execute

    MSG-RCVE
    [B] Execute DB000200 execute
    [B] Busy DB000210 busy
    [B] Abort DB000201 abort
    [B] Complete DB000211 complete
    [W] Dev-Typ 00016
    [B] Error DB000212 error
    [W] Pro-Typ 00001
    [W] Ctr-No 00001
    [W] Ch-No 00001
    [A] Param DA00100
    ---
    
```

4.1 Communications with MP-series Controllers

4.1.2 Using the MSG-RCVE Function with the MP3000 as a Slave

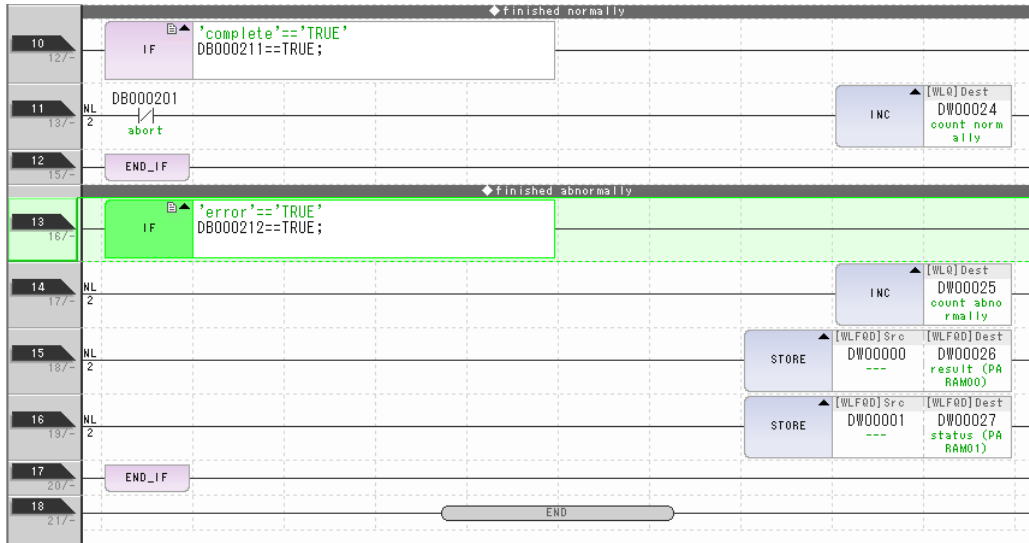

10. Save the data to flash memory.

This concludes the settings for using the MP3000 as a slave.

◆ Setting Up the Remote Device (MP2300)

Use the following procedure to set up the MP2300.

Information If the communications parameters (IP address and subnet mask) have already been set, skip to step 3.

1. Double-click the cell for [218IF] in the [Function Module/Slave] Area of the Module Configuration Definition Tab Page.

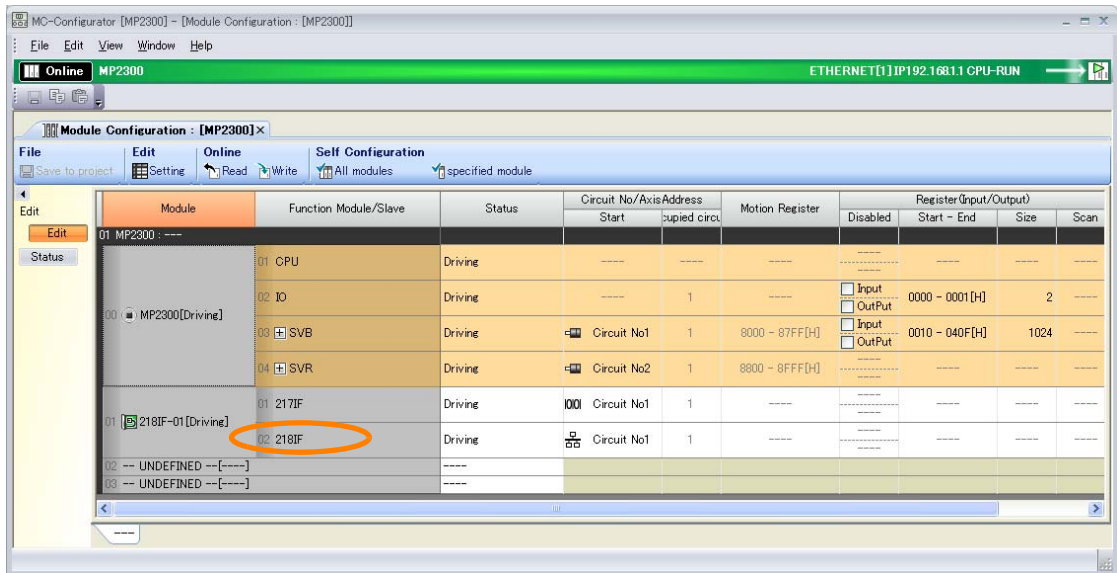

The 218IF Detail Definition Dialog Box will be displayed.

2. Set the communications parameters.

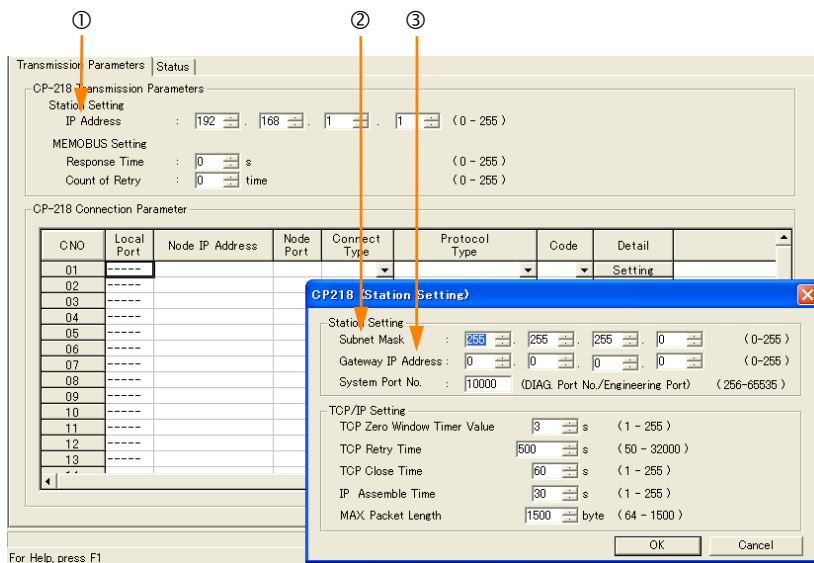

- ① In the [IP Address] Boxes, enter the following address: 192.168.001.002.
- ② In the [Subnet Mask] Boxes, enter the following mask: 255.255.255.000.
- ③ In the [Gateway IP Address] Boxes, enter the following address: 000.000.000.000.

3. Set the connection parameters.

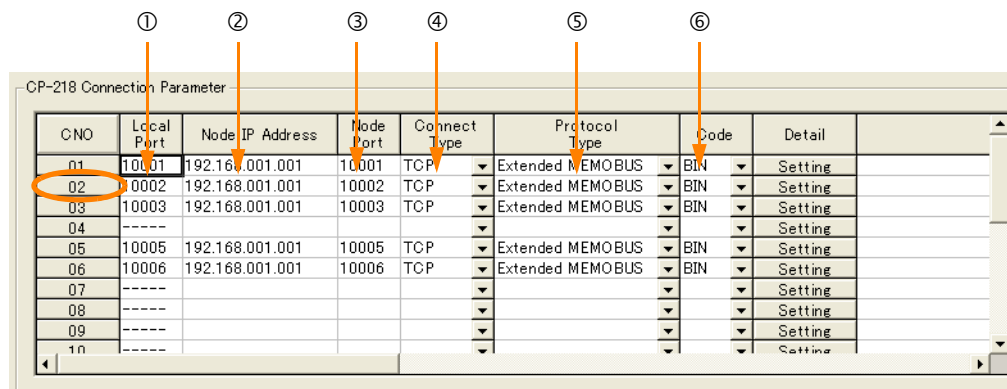

- ① Enter "10002" in the [Local Port] Box.
- ② Enter the following address in the [Node IP Address] Boxes: 192.168.001.001.
- ③ Enter "10002" in the [Node Port] Box.
- ④ Select [TCP] in the [Connect Type] Box.
- ⑤ Select [Extended MEMOBUS] in the [Protocol Type] Box.
- ⑥ Select [BIN] in the [Code] Box.

Note: Changes made to the communications or connection parameters will become effective only after the changes have been saved to flash memory and the power supply has been cycled.

4. Create a ladder program for the MSG-SND function.

A ladder program example is shown below.

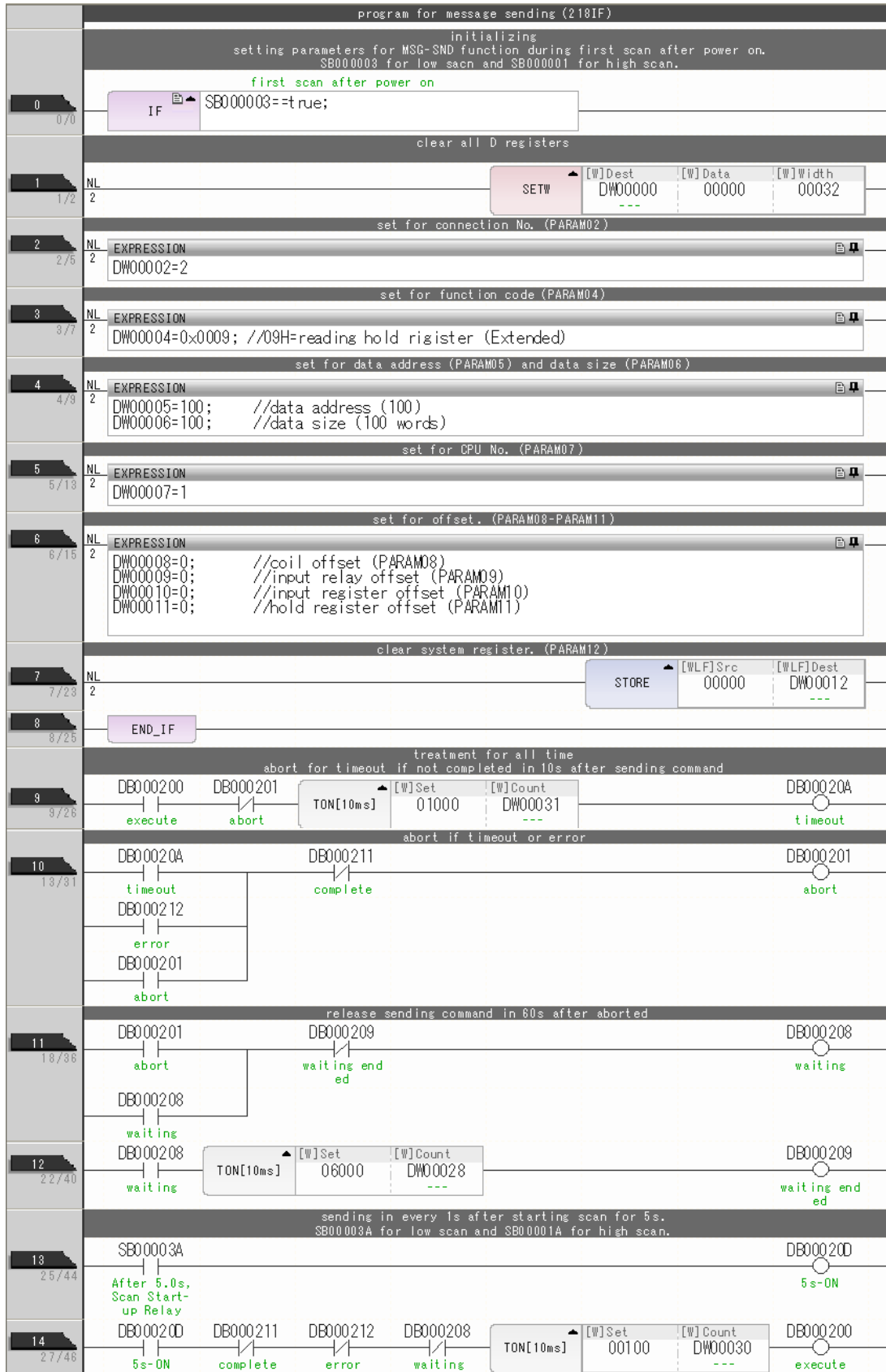

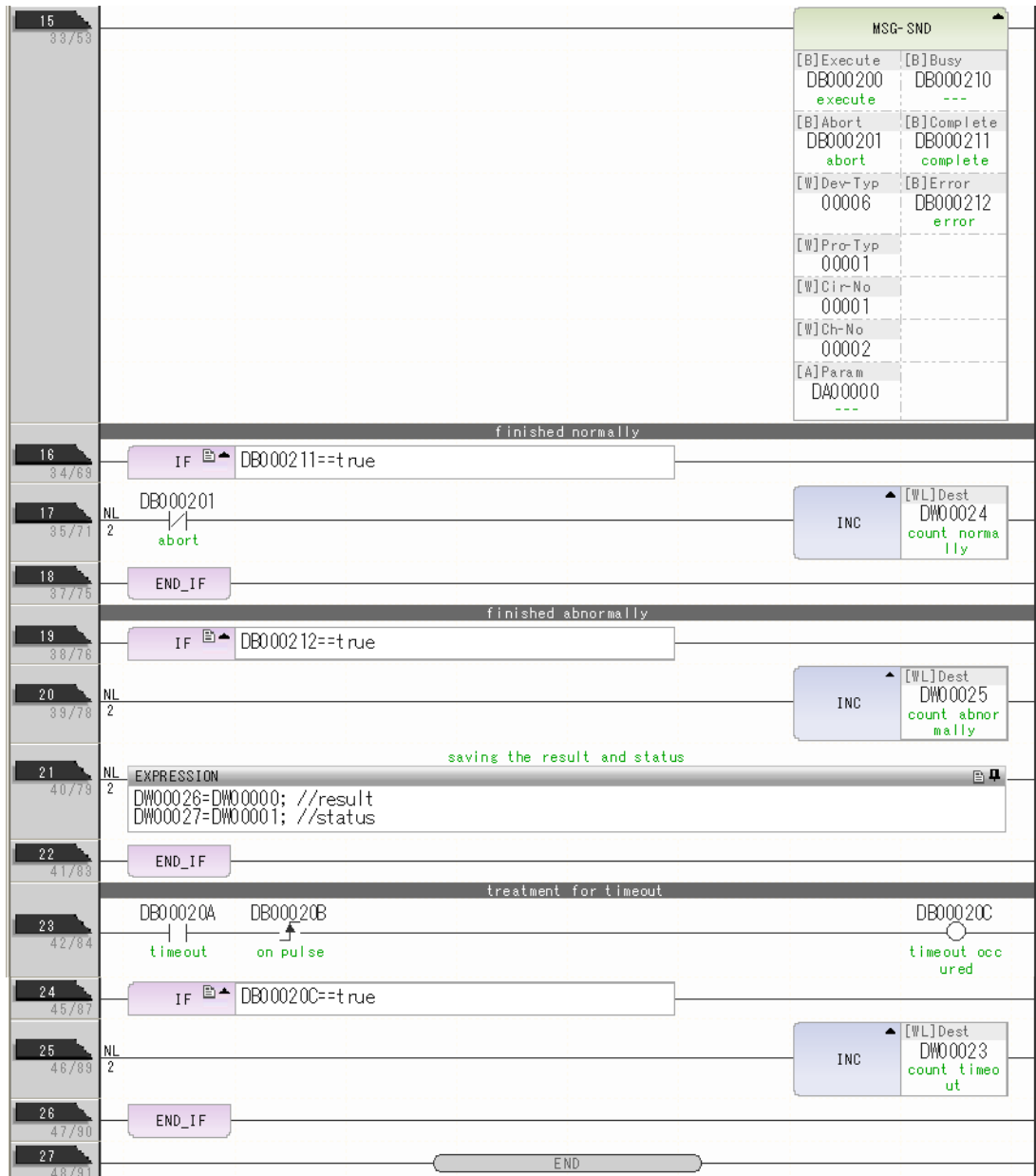

5. Save the data to flash memory.
This concludes the setup.

◆ Starting Communications

1. Turn ON the power to the MP3000 to start receiving messages.

In the ladder program example, message reception starts immediately after the system starts. No further operation is required.

2. Turn ON the Execute Bit (e.g., DB000200) for the MSG-SND function in the MP2300 to start sending messages.

The ladder program example is designed to send a message every second after five seconds have elapsed from when the low-speed scan (or high-speed scan) starts.

To change the message transmission interval, change the timer value ①.

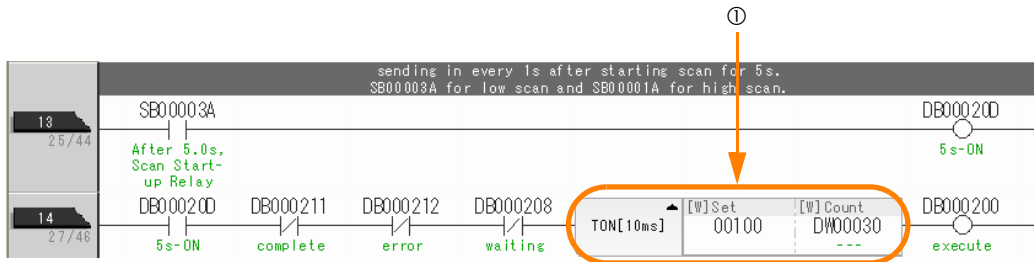

4.1.3 Using I/O Message Communications with the MP3000 as the Master

This section describes how to communicate with the MP2310 by using I/O message communications.

Setting Example

The following figure illustrates how the contents of the MW00200 to MW00299 hold registers in the MP2310 slave are read to the IW0000 to IW0063 input registers in the MP3000 master and how the contents of the OW0064 to OW00C7 output registers in the MP3000 master are written to the MW00300 to MW00399 hold registers in the MP2310 slave.

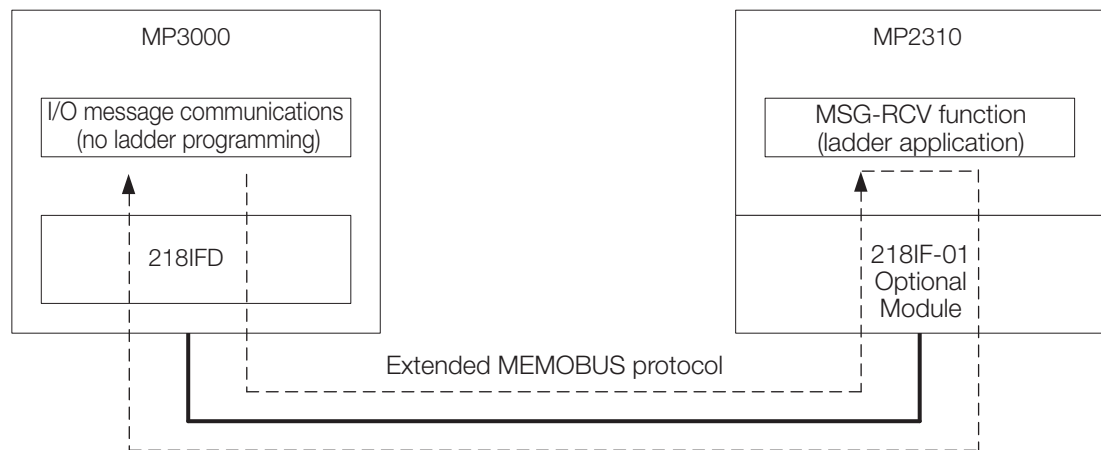
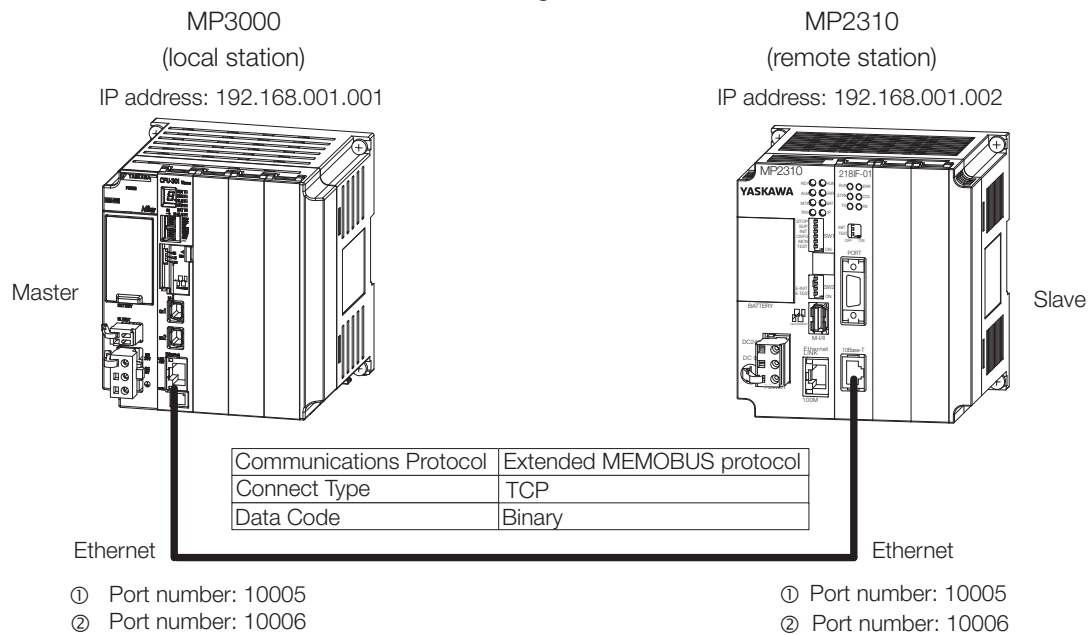

- Note:
1. I/O message communications use one-to-one communications.
 2. When using the Extended MEMOBUS protocol to communicate with an MP-series Controller, you can only read and write hold registers.
 3. When communicating with multiple remote devices or when you need to perform any operations other than reading or writing to hold registers, use the Send Message function (MSG-SNDE).

4.1 Communications with MP-series Controllers

4.1.3 Using I/O Message Communications with the MP3000 as the Master

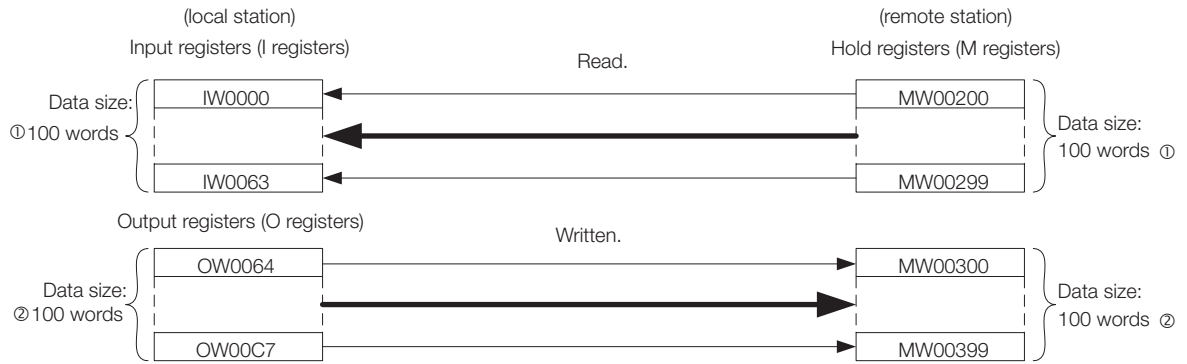

◆ MP3000 Setup

Use the following procedure to set up the MP3000.

Information If the communications parameters (IP address and subnet mask) have already been set, skip to step 3.

1. Double-click the cell for 218IFD in the Module Configuration Definition Tab Page.

Module	Function Module/Slave	Status	Circuit No/Axis Address		Motion Register	Register (Input/Output)			
			Start	cupied circ.		Disabled	Start - End	Size	
01 [CPU-302(32axes)] : ---	01 CPU	---	---	---	---				
00 CPU302(32)[-----]	02 218IFD	---	□	Circuit No1	1	---	Input Output	0000 - 07FF[H]	2048
	03 SVC32	---	■	Circuit No1	1	8000 - 87FF[H]	Input Output	0800 - 0BFF[H]	1024
	04 SVR32	---	■	Circuit No3	1	9000 - 97FF[H]			
	05 M-EXECUTOR	---	---	---	---	---		0C00 - 0C3F[H]	64
	06 -- UNDEFINED --	---	---	---	---	---			
	07 -- UNDEFINED --	---	---	---	---	---			
	01 -- UNDEFINED -- [-----]	---	---	---	---	---			
02 -- UNDEFINED -- [-----]	---	---	---	---	---				
03 -- UNDEFINED --	---	---	---	---	---				
02 -- UNDEFINED --	---	---	---	---	---				
02 -- UNDEFINED --	---	---	---	---	---				
03 -- UNDEFINED --	---	---	---	---	---				
04 -- UNDEFINED --	---	---	---	---	---				

The 218IFD Detail Definition Dialog Box will be displayed.

2. Set the communications parameters.

- ① In the [IP Address] Boxes, enter the following address: 192.168.001.001.
- ② In the [Subnet Mask] Boxes, enter the following mask: 255.255.255.000.
- ③ In the [Gateway IP Address] Boxes, enter the following address: 000.000.000.000.

3. Select the [Enable] Option in the [I/O Message Communication] Area of the [Connection Parameter] Area.

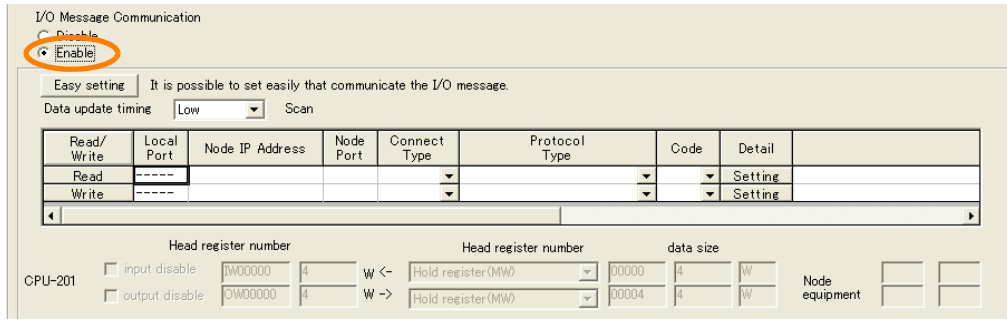

4. Click the [Easy setting] Button.
The Message Communication Easy Setting Dialog Box will be displayed.
5. Set the connection parameters.

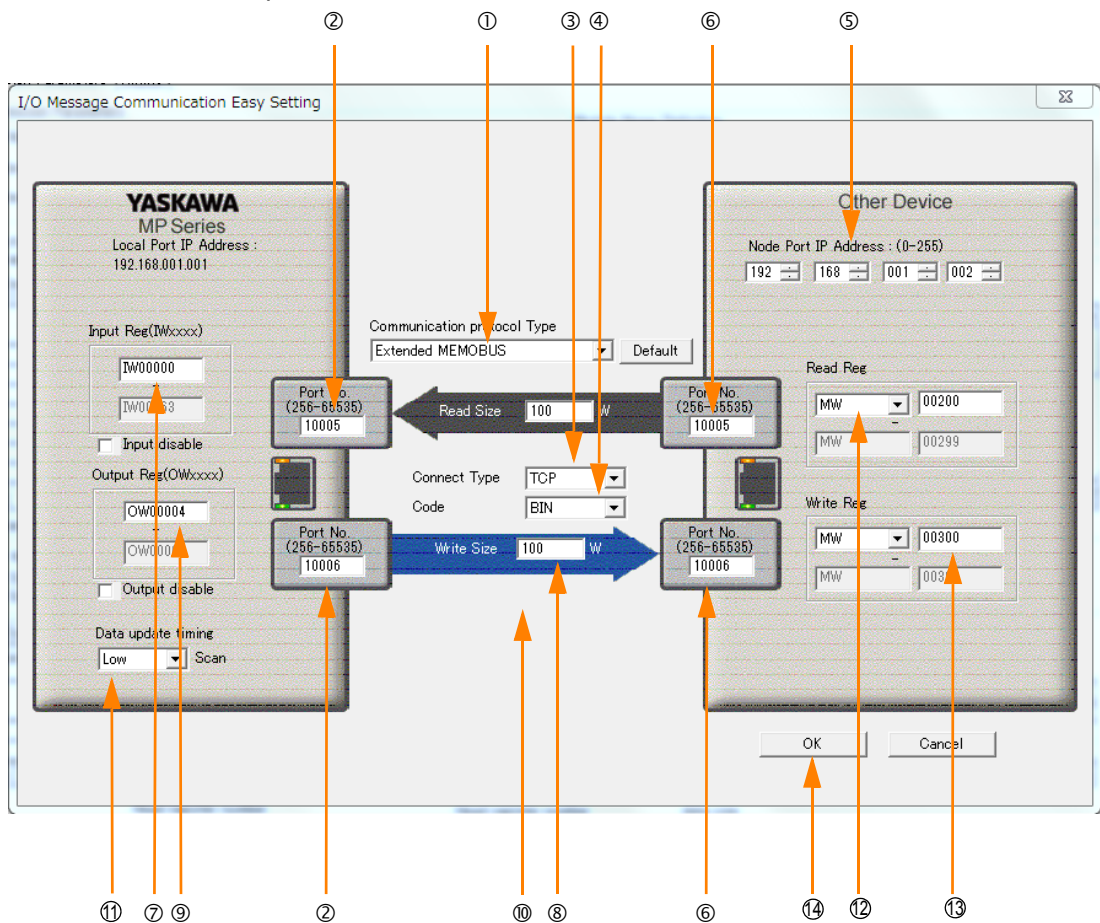

- ① Select [Extended MEMOBUS] in the [Communications Protocol Type] Box, and then click the [Default] Button.

Note: If you select the Extended MEMOBUS communications protocol, you will be able to read and write only hold registers (MW).

- ② Enter "10005" and "10006" in the [Port No.] Box for the MP-series Controller.
- ③ Select [TCP] in the [Connect Type] Box.
- ④ Select [BIN] in the [Code] Box.
- ⑤ Enter the following address in the [Node Port IP Address] Boxes for the other device: 192.168.001.002.
- ⑥ Enter "10005" and "10006" in the [Port No.] Boxes for the other devices.

Note: In I/O message communications, a message is transmitted from each port for which a register read/write is initiated. Therefore, for this example, the connected remote device must support a message reception function to receive two messages.

- ⑦ Enter "IW0000" in the [Input Reg] Box as the read data destination.
- ⑧ Enter "100" in the [Read Size] Box as the size of data to read.

4.1.3 Using I/O Message Communications with the MP3000 as the Master

- ⑨ Enter "OW0064" in the [Output Reg] Box as the write data destination.
- ⑩ Enter "100" in the [Write Size] Box as the size of data to write.
- ⑪ Select [Low] in the [Data update timing] Box as the timing to update input and output data between the CPU Function Module and 218IFD.

Note: The data update timing is the timing at which the CPU Function Module and 218IFD exchange data. Communications with the remote device are performed asynchronously. The data update timing therefore does not necessarily mean that the messages are sent to the remote device.

- ⑫ Enter "MW00200" in the [Read Reg] Box as the register type and first address to read from on the remote device.
- ⑬ Enter "MW00300" in the [Write Reg] Box as the register type and first address to write to on the remote device.

6. Click the [OK] Button.

7. Click the [Yes] Button in the Transmission Parameters Confirmation Dialog Box.

Note: If parameters have already been set for the same connection number and you click the [Yes] Button in the Transmission Parameters Confirmation Dialog Box, the settings will be overwritten by the parameters that are set in the Message Communication Easy Setting Dialog Box.

8. Check the settings.

I/O Message Communication

Disable
 Enable

Easy setting It is possible to set easily that communicate the I/O message.

Data update timing Low Scan

Read/Write	Local Port	Node IP Address	Node Port	Connect Type	Protocol Type	Code	Detail
Read	10005	192.168.001.002	10005	TCP	Extended MEMOBUS	BIN	Setting
Write	10006	192.168.001.002	10006	TCP	Extended MEMOBUS	BIN	Setting

Head register number Head register number data size

CPU-201

input disable MW00000 100 W <- Hold register (MW) 00200 100 W

output disable OW00064 100 W -> Hold register (MW) 00300 100 W

Node equipment

9. Save the data to flash memory.

Note: Changes made to the communications or connection parameters will become effective only after the changes have been saved to flash memory and the power supply has been cycled.

This concludes the settings for using the MP3000 as the master.

◆ Setting Up the Remote Device (MP2310)

Use the following procedure to set up the MP2310.

Information If the communications parameters (IP address and subnet mask) have already been set, skip to step 3.

1. Double-click the cell for [218IF] in the [Function Module/Slave] Area of the Module Configuration Definition Tab Page.

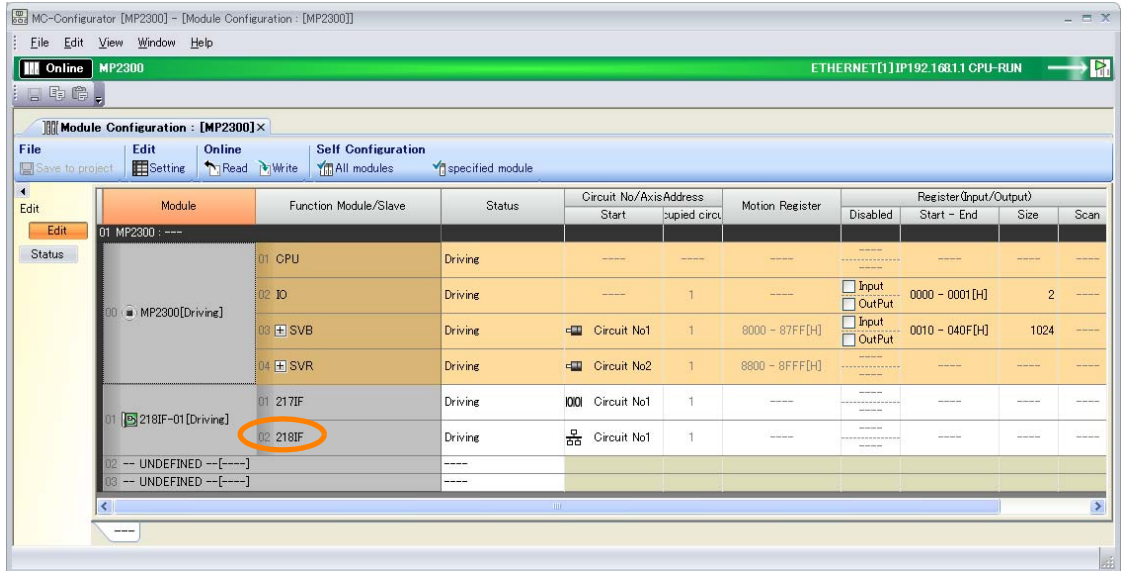

The 218IF Detail Definition Dialog Box will be displayed.

2. Set the communications parameters.

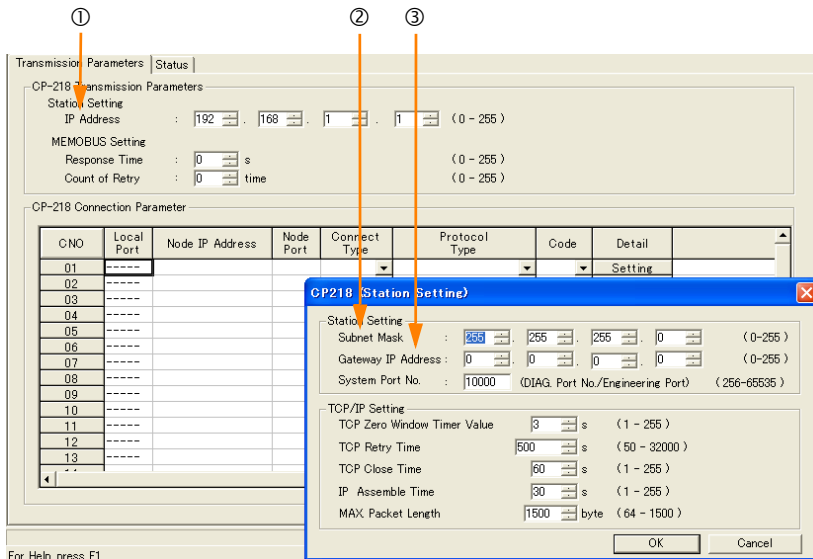

- ① In the [IP Address] Boxes, enter the following address: 192.168.001.002.
- ② In the [Subnet Mask] Boxes, enter the following mask: 255.255.255.000.
- ③ In the [Gateway IP Address] Boxes, enter the following address: 000.000.000.000.

3. Set the connection parameters.

CNO	Local Port	Node IP Address	Node Port	Connect Type	Protocol Type	Code	Detail
01	10001	192.168.001.001	10001	TCP	Extended MEMOBUS	BIN	Setting
02	10002	192.168.001.001	10002	TCP	Extended MEMOBUS	BIN	Setting
03	10003	192.168.001.001	10003	TCP	Extended MEMOBUS	BIN	Setting
04	-----	-----	-----	-----	-----	-----	Setting
05	10005	192.168.001.001	10005	TCP	Extended MEMOBUS	BIN	Setting
06	10006	192.168.001.001	10006	TCP	Extended MEMOBUS	BIN	Setting
07	-----	-----	-----	-----	-----	-----	Setting
08	-----	-----	-----	-----	-----	-----	Setting
09	-----	-----	-----	-----	-----	-----	Setting
10	-----	-----	-----	-----	-----	-----	Setting

- ① Enter "10005" and "10006" in the [Local Port] Boxes.
- ② Enter the following address in the [Node IP Address] Boxes: 192.168.001.001.
- ③ Enter "10005" and "10006" in the [Node Port] Boxes.
- ④ Select [TCP] in the [Connect Type] Box.
- ⑤ Select [Extended MEMOBUS] in the [Protocol Type] Box.
- ⑥ Select [BIN] in the [Code] Box.

Note: Changes made to the communications or connection parameters will become effective only after the changes have been saved to flash memory and the power supply has been cycled.

4. Create a ladder program for the MSG-RCV function.

A ladder program example is shown below.

This ladder program example is for receiving the read request. Ladder programming for receiving the write request is required separately.

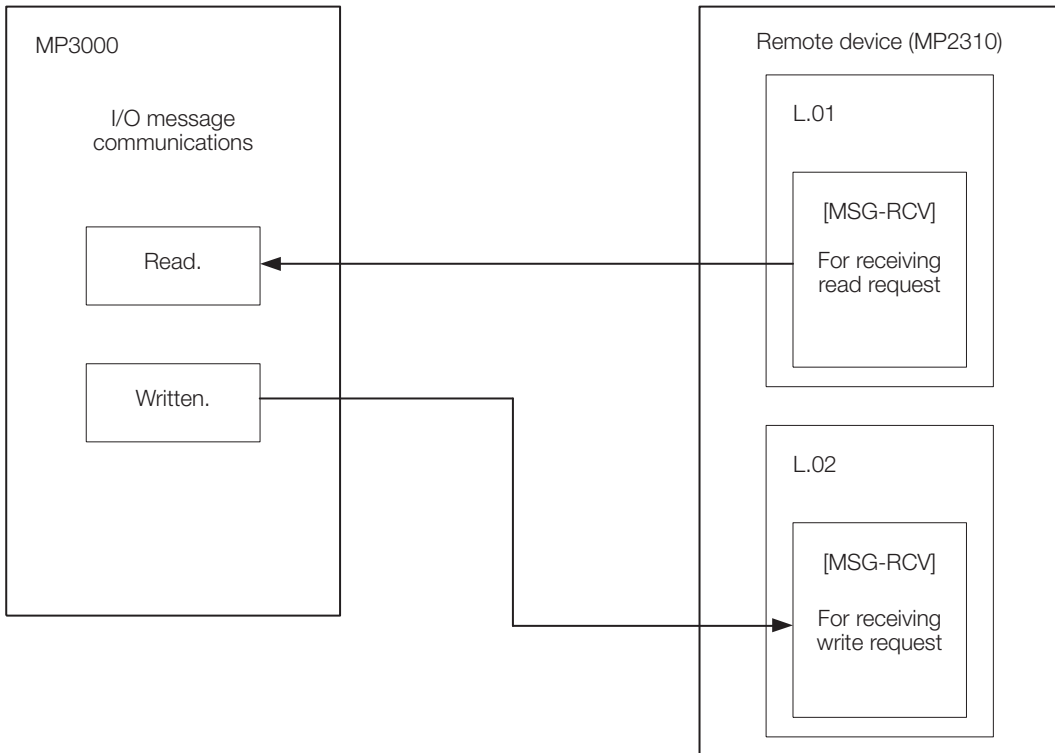

4.1.3 Using I/O Message Communications with the MP3000 as the Master

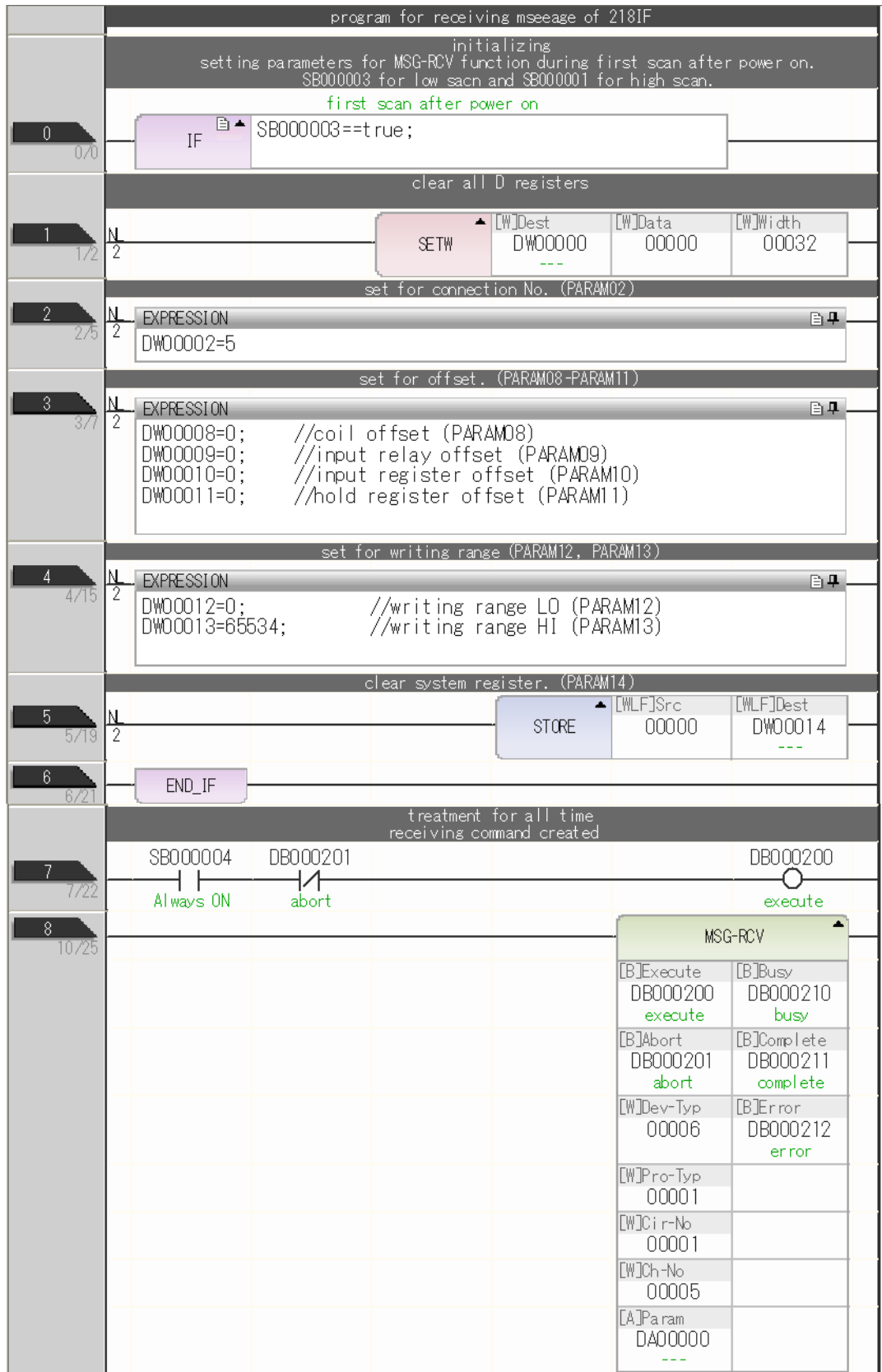

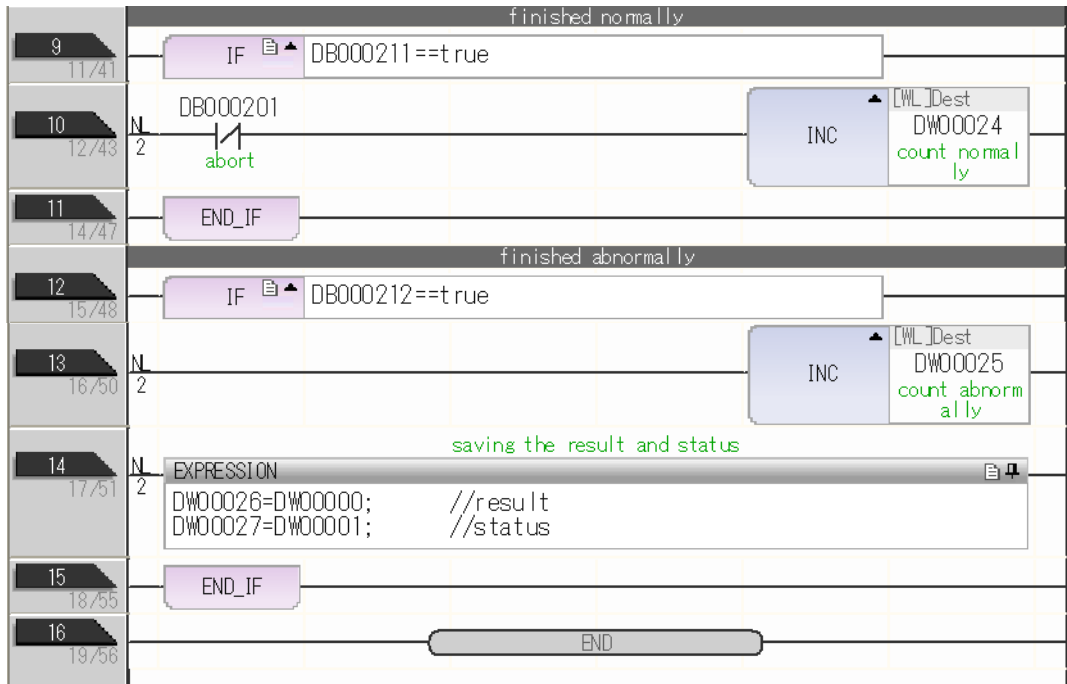

5. Save the data to flash memory.

This concludes the setup.

◆ **Starting Communications**

- 1. Turn ON the power to the MP2310 to start receiving messages.**
 In the ladder program example, message reception starts immediately after the system starts. No further operation is required.
- 2. Turn ON the power to the MP3000 to send the messages.**
 The system will automatically start the message transmission operation. No further operation is required.

4.1.4 Using the MSG-SNDE Function with the MP3000 as the Master

In I/O message communications, operations can be performed only on hold registers (M registers). No other register types are supported. Additionally, this protocol supports communications with only one slave.

To communicate with two or more slaves, you must use the MSG-SNDE function. You can use the MSG-SNDE function together with I/O message communications by maintaining a separate connection.

This section describes how to communicate with the MP2310 by using the MSG-SNDE function.

Setting Example

The following figure illustrates how the contents of the MW00400 to MW00499 hold registers in the MP2310 slave are read into the MW00400 to MW00499 hold registers in the MP3000 master.

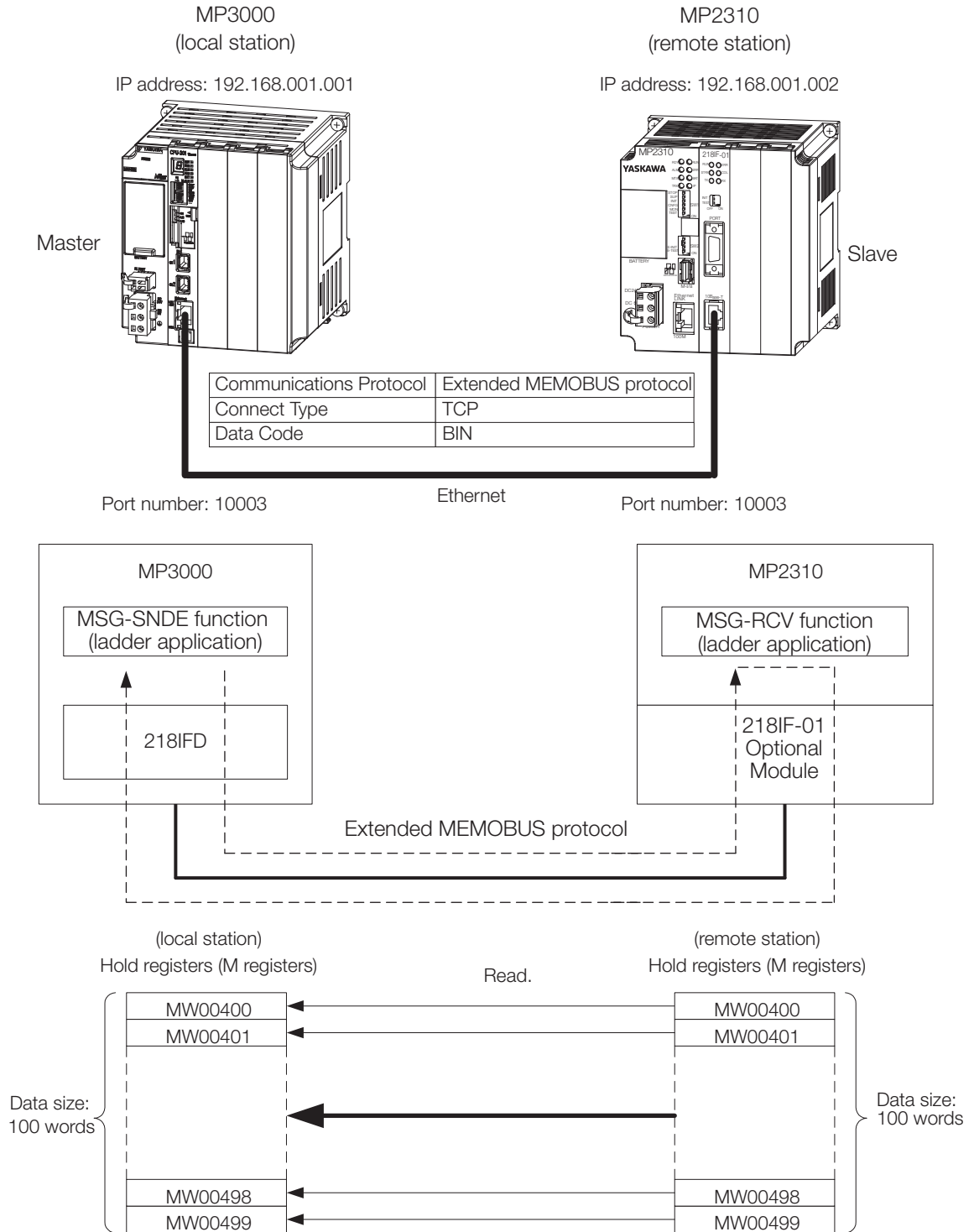

◆ MP3000 Setup

Use the following procedure to set up the MP3000.

Information If the communications parameters (IP address and subnet mask) have already been set, skip to step 3.

1. Double-click the cell for 218IFD in the Module Configuration Definition Tab Page.

Module	Function Module/Slave	Status	Circuit No./AxisAddress		Motion Register	Register(Input/Output)		
			Start	cupied circ		Disabled	Start - End	Size
01 [CPU-302(32axes)] : ---								
00 CPU302(32) [---]	01 CPU	---						
	02 218IFD	---	0	Circuit No1	1		Input Output	0000 - 07FF[H] 2048
	03 SVC32	---	1	Circuit No1	1	8000 - 87FF[H]	Input Output	0800 - 0BFF[H] 1024
	04 SVR32	---	1	Circuit No3	1	9000 - 97FF[H]		
	05 M-EXECUTOR	---						0C00 - 0C3F[H] 64
	06 -- UNDEFINED --	---						
	07 -- UNDEFINED --	---						
01 -- UNDEFINED -- [---]								
02 -- UNDEFINED -- [---]								
03 -- UNDEFINED --								
02 -- UNDEFINED --								
02 -- UNDEFINED --								
03 -- UNDEFINED --								
04 -- UNDEFINED --								

The 218IFD Detail Definition Dialog Box will be displayed.

2. Set the communications parameters.

Transmission Parameters: Status

Transmission Parameters

IP Address : 192 . 168 . 1 . 1 (0-255)

Subnet Mask : 255 . 255 . 255 . 0 (0-255)

Gateway IP Address : 0 . 0 . 0 . 0 (0-255)

Module Name Definition
Equipment name : CONTROLLER NAME

Detail Definition

- ① In the [IP Address] Boxes, enter the following address: 192.168.001.001.
- ② In the [Subnet Mask] Boxes, enter the following mask: 255.255.255.000.
- ③ In the [Gateway IP Address] Boxes, enter the following address: 000.000.000.000.

3. Click the [Easy setting] Button in the [Message Communication] Area in the [Connection Parameter] Area.

Connection Parameter

Message Communication

Easy setting The following parameters for message communications can be easily set. Connections(C NO) 01-10 can be set to receive data automatically.

CNO	Local Port	Node IP Address	Node Port	Connect Type	Protocol Type	Code	Detail
01	---						Setting*
02	---						Setting*
03	---						Setting*
04	---						Setting*
05	---						Setting*
06	---						Setting*
07	---						Setting*

The Message Communication Easy Setting Dialog Box will be displayed.

4. Set the connection parameters.

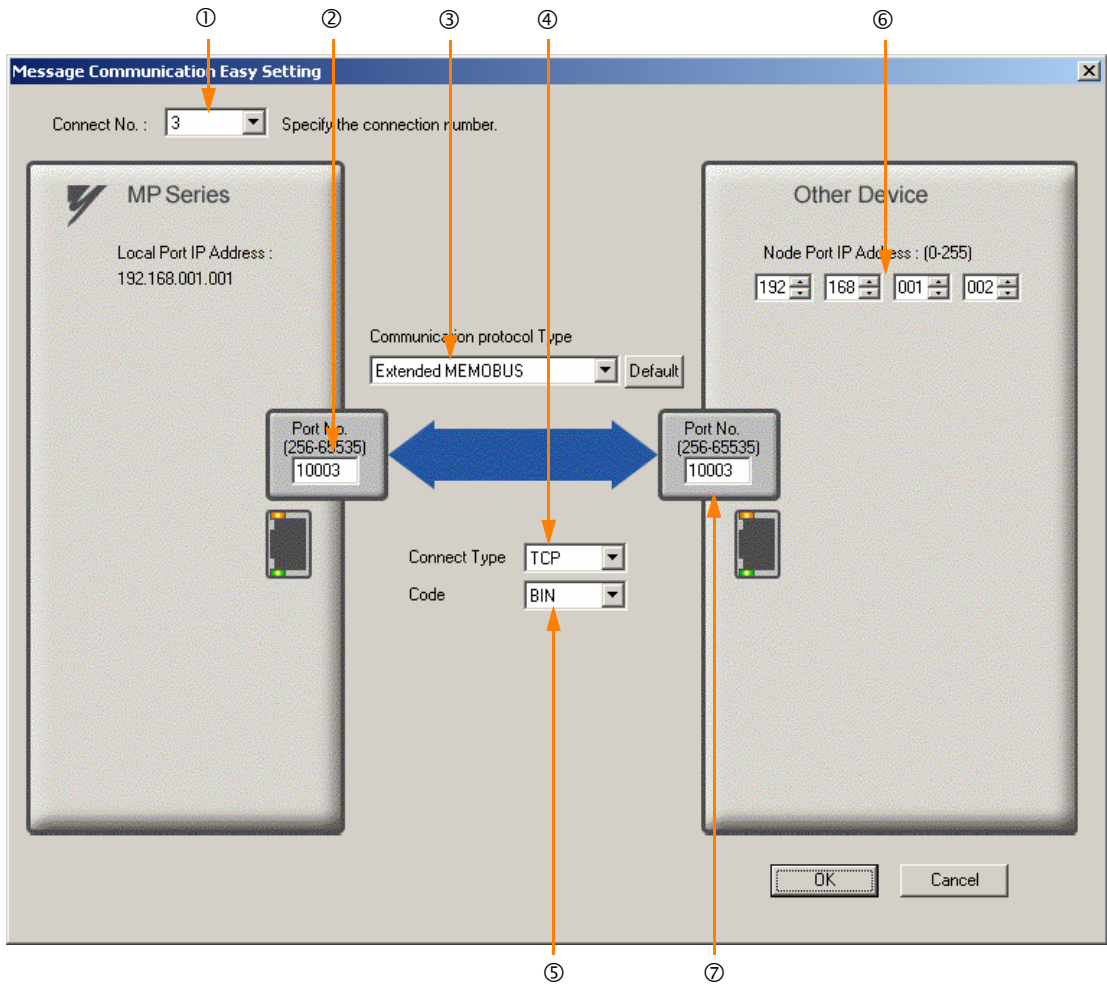

- ① Select [3] in the [Connect No.] Box.
- ② Enter "10003" in the [Port No.] Box for the MP-series Controller.
- ③ Select [Extended MEMOBUS] in the [Communications Protocol Type] Box, and then click the [Default] Button.
- ④ Select [TCP] in the [Connect Type] Box.
- ⑤ Select [BIN] in the [Code] Box.
- ⑥ Enter the following address in the [Node Port IP Address] Boxes for the other device:
192.168.001.002.
- ⑦ Enter "10003" in the [Port No.] Box for the other device.

Note: Disable automatic reception for any connection for which message functions (MSG-SNDE and MSG-RCVE) are used. If message functions are used while automatic reception is enabled, the communications will not function properly.

5. Click the [OK] Button.

6. Click the [Yes] Button in the Transmission Parameters Confirmation Dialog Box.

Note: If parameters have already been set for the same connection number and you click the [Yes] Button in the Transmission Parameters Confirmation Dialog Box, the settings will be overwritten by the parameters that are set in the Message Communications Easy Setting Dialog Box.

7. Check the settings.

Connection Parameter
Message Communication

Easy setting The following parameters for message communications can be easily set. Connections(C NO) 01-10 can be set to receive data automatically.

CNO	Local Port	Node IP Address	Node Port	Connect Type	Protocol Type	Code	Detail
01	-----						Setting*
02	-----						Setting*
03	10003	192.168.001.002	10003	TCP	Extended MEMOBUS	BIN	Setting*
04	-----						Setting*
05	-----						Setting*
06	-----						Setting*
07	-----						Setting*

Cannot the overlap to local station port number used by the communicate the I/O message.

Note: Changes made to the communications or connection parameters will become effective only after the changes have been saved to flash memory and the power supply has been cycled.

8. Create a ladder program for the MSG-SNDE function.

A ladder program example is shown below.

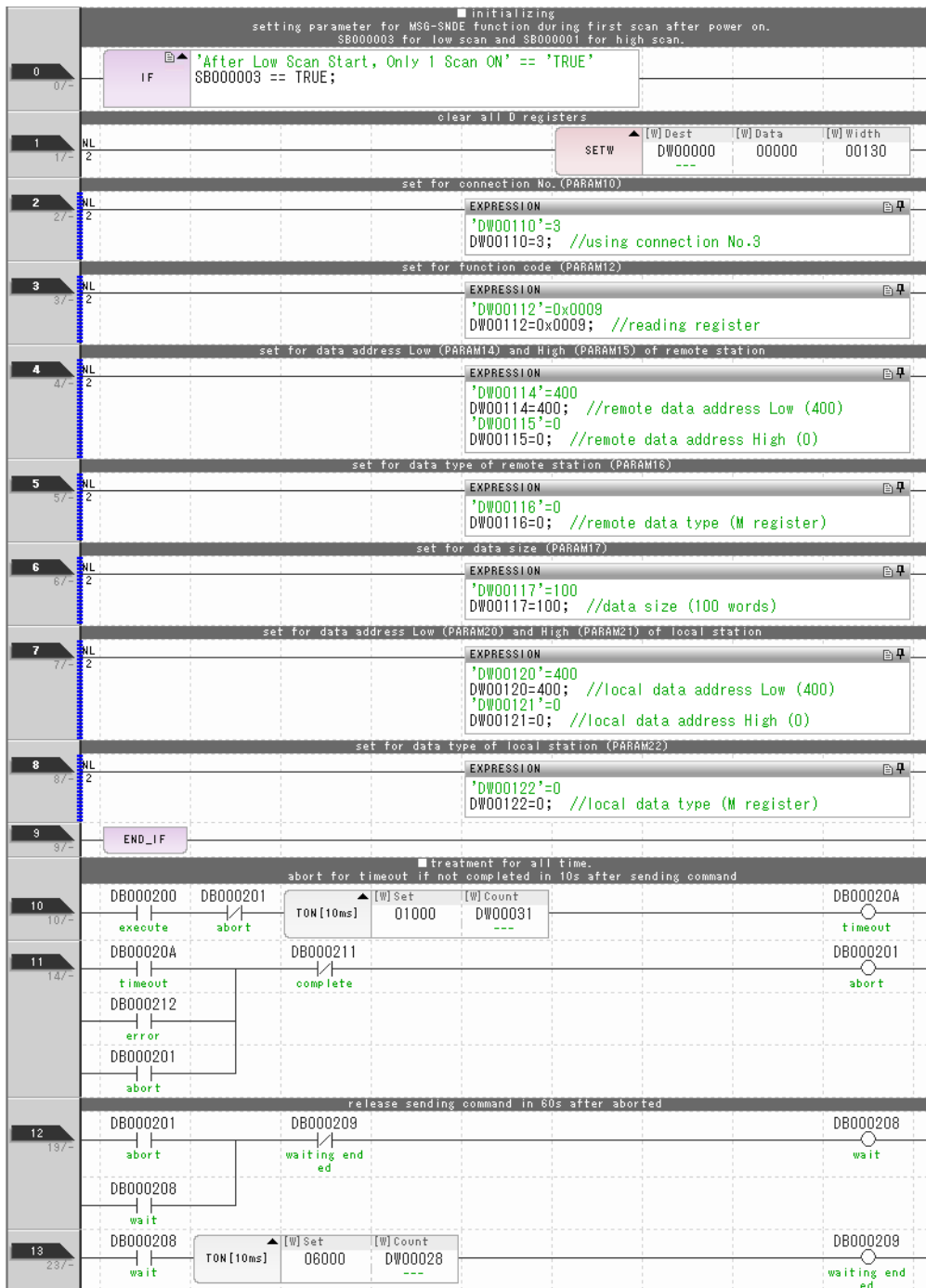

4.1 Communications with MP-series Controllers

4.1.4 Using the MSG-SNDE Function with the MP3000 as the Master

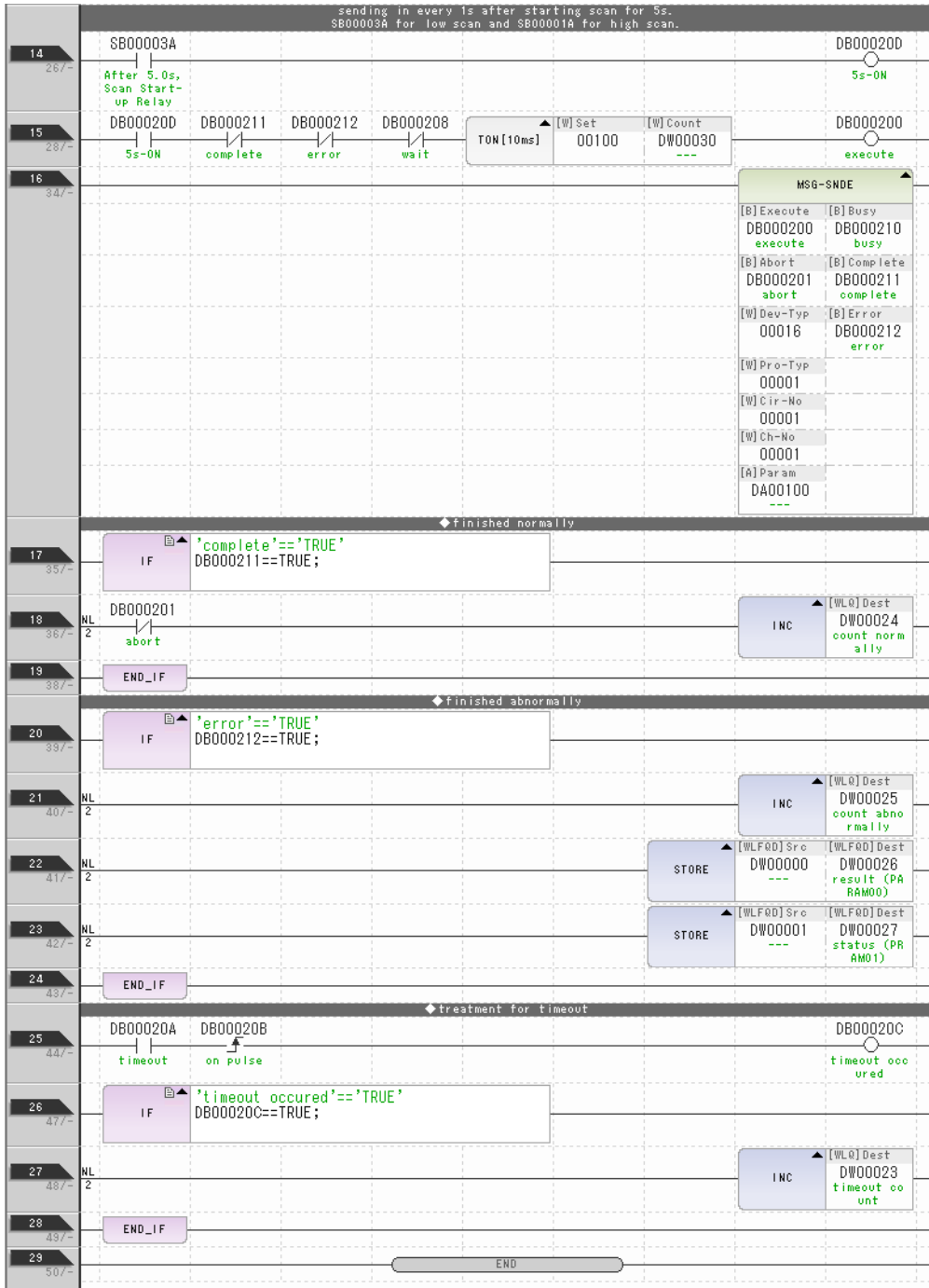

9. Save the data to flash memory.

This concludes the settings for using the MP3000 as the master.

◆ Setting Up the Remote Device (MP2310)

Use the following procedure to set up the MP2310.

Information If the communications parameters (IP address and subnet mask) have already been set, skip to step 3.

1. Double-click the cell for [218IF] in the [Function Module/Slave] Area of the Module Configuration Definition Tab Page.

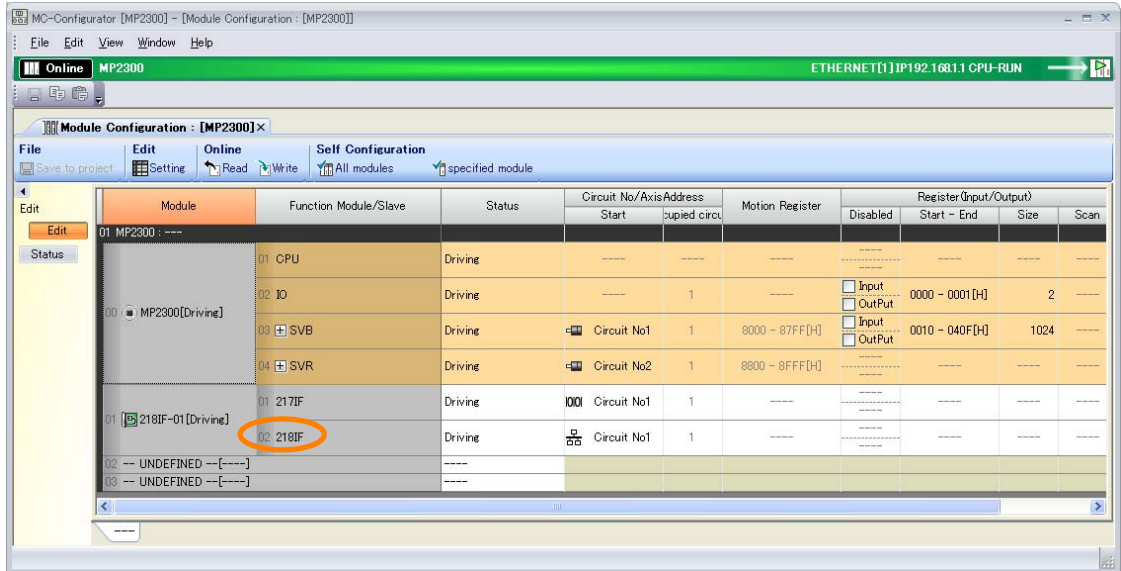

The 218IF Detail Definition Dialog Box will be displayed.

2. Set the communications parameters.

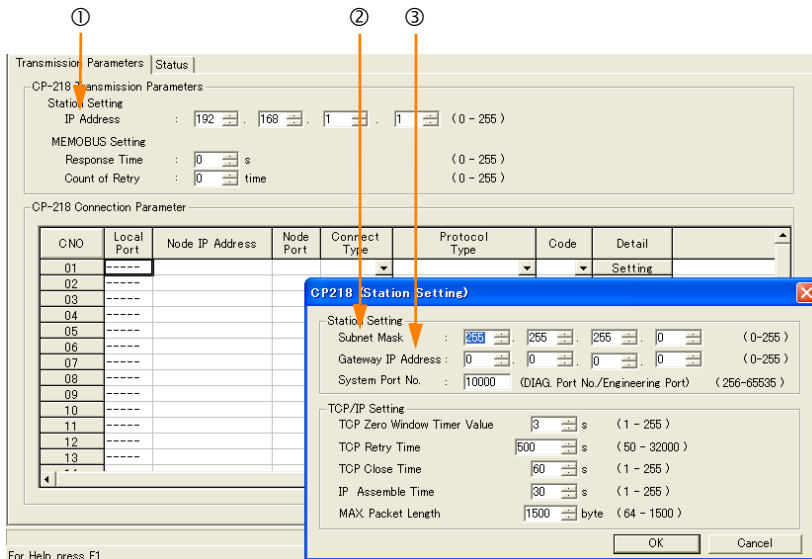

- ① In the [IP Address] Boxes, enter the following address: 192.168.001.002.
- ② In the [Subnet Mask] Boxes, enter the following mask: 255.255.255.000.
- ③ In the [Gateway IP Address] Boxes, enter the following address: 000.000.000.000.

3. Set the connection parameters.

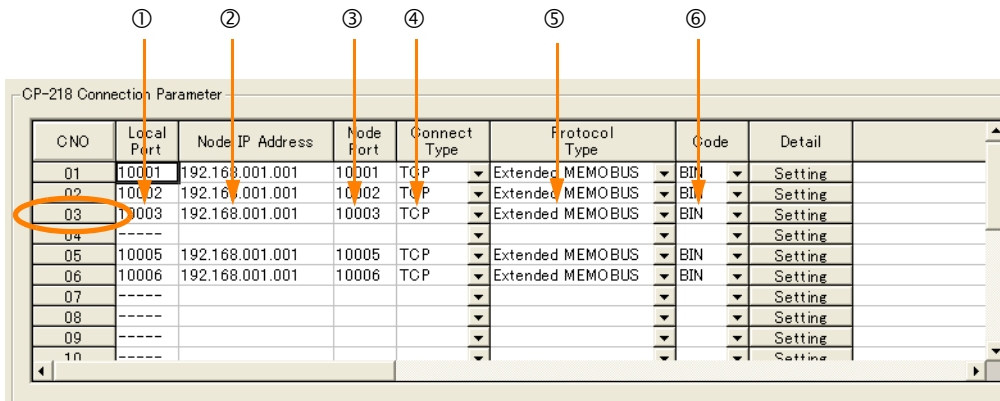

- ① Enter "10003" in the [Local Port] Box.
- ② Enter the following address in the [Node IP Address] Boxes: 192.168.001.001.
- ③ Enter "10003" in the [Node Port] Box.
- ④ Select [TCP] in the [Connect Type] Box.
- ⑤ Select [Extended MEMOBUS] in the [Protocol Type] Box.
- ⑥ Select [BIN] in the [Code] Box.

Note: Changes made to the communications or connection parameters will become effective only after the changes have been saved to flash memory and the power supply has been cycled.

4. Create a ladder program for the MSG-RCV function.

Refer to the following section for a ladder program example.

The sample uses a different communications buffer channel and connection number.

📖 ◆ *Setting Up the Remote Device (MP2310) on page 4-27*

5. Save the data to flash memory.

This concludes the setup.

◆ Starting Communications

1. Turn ON the power to the MP2310 to start receiving messages.

In the ladder program example, message reception starts immediately after the system starts. No further operation is required.

2. Turn ON the Execute Bit (e.g., DB000200) for the MSG-SNDE function in the MP3000 to start sending messages.

The ladder program example is designed to send a message every second after five seconds have elapsed from when the low-speed scan (or high-speed scan) starts.

To change the message transmission interval, change the timer value ①.

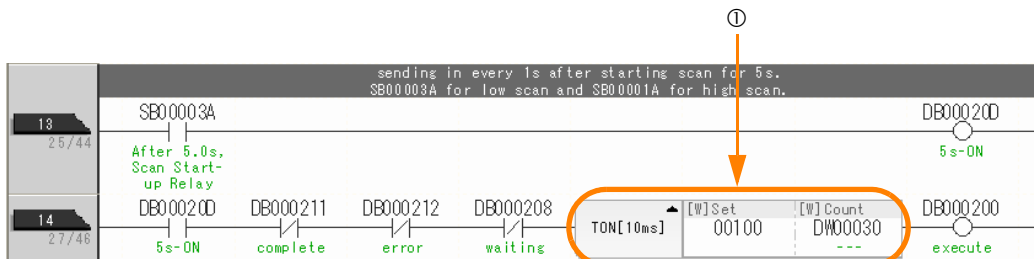

4.1.5 Message Functions

The message functions are used in user communications applications for the Extended MEMO-BUS protocol. You can send and receive message data by setting the necessary input items and parameters for the message functions.

Inputs and Outputs for the MSG-SNDE Function

I/O Definitions	No.	Name	I/O Designation	Meaning	Description
Input Items	1	Execute	B-VAL	Executes the transmission.	Specify the bit to use to execute the message transmission. When the Execute Bit turns ON, the message will be sent. Keep the Execute Bit ON until the Complete or Error Bit turns ON. To send another message, turn OFF the Execute Bit for at least one scan and then turn it ON again.
	2	Abort	B-VAL	Forces the transmission to end.	Specify the bit to use to abort the message transmission. When the Abort Bit turns ON, the message transmission will be stopped unconditionally. The Abort Bit takes precedence over the Execute Bit.
	3	Dev-Typ	I-REG	Communications device type	Specify the type code of the communications device. 218IFB, 218IFD = 16
	4	Pro-Typ	I-REG	Communications protocol	Specify the type code of the communications protocol. 1: MEMOBUS Select this protocol when using the Extended MEMOBUS protocol. MEMOBUS is automatically converted to Extended MEMOBUS inside the 218IFD. 2: No-protocol communications 1 (unit: words) Not used for the Extended MEMOBUS protocol. 3: No-protocol communications 2 (unit: bytes) Not used for the Extended MEMOBUS protocol.
	5	Cir-No	I-REG	Circuit number	Specify the circuit number for the communications device. Specify the same circuit number as displayed in the MPE720 Module Configuration Definition Tab Page. 218IFB, 218IFD = 1 to 8
	6	Ch-No	I-REG	Communications buffer channel number	Specify the channel number of the communications buffer. You can specify any channel number provided it is within the valid range. When executing more than one function at the same time, do not use the same channel number for the same connection. You can use the same channel number as long as multiple functions are not executed at the same time. 218IFB, 218IFD = 1 to 10
	7	Param	Address Inputs	Parameter list first address (MA, DA)	Specify the first address of the parameter list. A total of 29 words starting from the specified first word are automatically used for the parameter list. The parameter list is used by inputting function codes and relevant parameter data. It is also where the process results and status are output.









Continued on next page.

Continued from previous page.

I/O Definitions	No.	Name	I/O Designation	Meaning	Description
Output Items	1	Busy	B-VAL	Processing.	Specify the bit that shows that the message transmission is in progress. The Busy Bit is ON while a message transmission or abort is in progress. Keep the Execute Bit or Abort Bit turned ON while the Busy Bit is ON.
	2	Complete	B-VAL	Process completed.	Specify the bit that shows when the message transmission has been completed. The Complete Bit turns ON only for one scan when message transmission or forced abort processing has been completed normally.
	3	Error	B-VAL	Error occurred.	Specify the bit that shows if an error occurred when sending the message. When an error occurs, the Error Bit will turn ON only for one scan. Refer to the following section for an example of a timing chart for when an error occurs.  ◆ Error on page 2-8













MSG-SNDE Function Parameters

The following table describes the contents of the addresses specified by the PARAM input parameter to the MSG-SNDE function.

No.	I/O	Meaning	Description	Reference Page
00	Out-puts	Processing Result	Gives the processing status.	 ◆ Processing Result (PARAM00) on page 2-9
01		Status	Gives the status of the current function.	 ◆ Status (PARAM01) on page 2-10
02		Detail Error Code, Lower Word	Gives the details of an error.	 ◆ Detail Error Code (PARAM02 and PARAM03) on page 2-11
03				
04		Status 1	Gives the communications status.	 ◆ Status 1 (PARAM04) on page 2-12
05		Status 2	Gives status information on the most recent error.	 ◆ Status 2 (PARAM05) on page 2-12
06		Status 3	Gives the information of the send pass counter.	 ◆ Status 3 (PARAM06) on page 2-12
07		Status 4	Gives the information of the receive pass counter.	 ◆ Status 4 (PARAM07) on page 2-12
08		Status 5	Gives the information of the error counter.	 ◆ Status 5 (PARAM08) on page 2-13
09	Status 6	Not used for the Extended MEMOBUS protocol.	-	

Continued on next page.

Continued from previous page.

No.	I/O	Meaning	Description	Reference Page
10	Inputs	Connection Number	Sets the connection number used to determine the remote station.	 ◆ <i>Connection Number (PARAM10)</i> on page 2-13
11		Option	Not used for the Extended MEMOBUS protocol.	—
12		Function Code	Sets the code of the function in the Extended MEMOBUS protocol.	 ◆ <i>Function Code (PARAM12)</i> on page 4-42
13		Reserved for system.	This parameter is used by the system. Do not change the value of this parameter from a user program or by any other means.	 ◆ <i>Reserved for System (PARAM13)</i> on page 2-14
14		Remote Station Data Address, Lower Word	Sets the data address to read/write at the remote station. (Use word addresses for registers, bit addresses for relays or coils.)	 ◆ <i>Remote Station Data Address (PARAM14 and PARAM15)</i> on page 2-15
15		Remote Station Data Address, Upper Word		
16		Remote Station Register Type	Sets the register type to read/write at the remote station.	 ◆ <i>Remote Station Register Type (PARAM16)</i> on page 4-43
17		Data size	Sets the size of the data to read/write. (Use word sizes for registers, bit sizes for relays or coils.)	 ◆ <i>Data Size (PARAM17)</i> on page 2-16
18		Remote CPU Module Number	Sets the CPU number at the remote station.	 ◆ <i>Remote CPU Module Number (PARAM18)</i> on page 2-17
19		Reserved for system.	This parameter is used by the system. Do not change the value of this parameter from a user program or by any other means.	 ◆ <i>Reserved for System (PARAM19)</i> on page 2-17
20		Local Station Data Address, Lower Word	Sets the data address to store read/write data in the local station. (Use word addresses for registers, bit addresses for relays or coils.)	 ◆ <i>Local Station Data Address (PARAM20 and PARAM21)</i> on page 2-18
21		Local Station Data Address, Upper Word		
22		Local Station Register Type	Sets the register type of the read/write data to store in the local station.	 ◆ <i>Local Station Register Type (PARAM22)</i> on page 2-19
23		Reserved for system.	This parameter is used by the system. Do not change the value of this parameter from a user program or by any other means.	 ◆ <i>Reserved for System (PARAM23)</i> on page 2-19
24	—	For system use	This parameter is used by the system. It contains the channel number of the communications buffer that is currently in use. A user program must set this parameter to 0 on the first scan after startup. Thereafter, do not change the value of this parameter from a user program or by any other means because it will be used by the system.	 ◆ <i>Reserved for System (PARAM24)</i> on page 2-19
25		Reserved for system.	These parameters are used by the system. Do not change the value of these parameters from a user program or by any other means.	 ◆ <i>Reserved for System (PARAM25 to PARAM28)</i> on page 2-19
26		Reserved for system.		
27		Reserved for system.		
28	Reserved for system.			

◆ **Function Code (PARAM12)**

Set the function code to send.

You can use the functions that are registered to the function codes.

Function Code	Target Data Type	Function	Registers When Acting as the Master	
			Send Registers	Receive Registers
00 hex	–	Not used for the Extended MEMOBUS protocol.	M	M
01 hex	B	Reads the states of coils.		
02 hex	B	Reads the states of input relays.		
03 hex	W	Reads the contents of hold registers.		
04 hex	W	Reads the contents of input registers.		
05 hex	B	Changes the state of a single coil.		
06 hex	W	Writes to a single hold register.		
07 hex	–	Not used for the Extended MEMOBUS protocol.		
08 hex	–	Performs a loopback test.		
09 hex	W	Reads the contents of hold registers (extended).		
0A hex	W	Reads the contents of input registers (extended).		
0B hex	W	Writes to hold registers (extended).		
0C hex	–	Not used for the Extended MEMOBUS protocol.		
0D hex	W	Reads the contents of non-consecutive hold registers (extended).		
0E hex	W	Writes the contents of non-consecutive hold registers (extended).		
0F hex	B	Changes the states of multiple coils.		
10 hex	W	Writes to multiple hold registers.		
4341 hex	B	Reads the states of bits.		
4345 hex	B	Changes the state of a single bit.		
4346 hex	W	Writes to a single register.		
4349 hex	W	Reads the contents of registers.		
434B hex	W	Writes to multiple registers.		
434D hex	W	Reads the contents of non-consecutive registers.		
434E hex	W	Writes the contents of non-consecutive registers.		
434F hex	B	Changes the states of multiple bits.		

Note: B: Bit data, W: Integer data

◆ Remote Station Register Type (PARAM16)

Set the register type in the remote station. This parameter is valid when using function codes 43□□ hex.

Enter the register type as a decimal or hexadecimal number.

Register Type Value	Type	Remarks
0	M	Sets the target data type to MB for bits and MW for words.
1	G	Sets the target data type to GB for bits and GW for words.
2	I	Sets the target data type to IB for bits and IW for words.
3	O	Sets the target data type to OB for bits and OW for words.
4	S	Sets the target data type to SB for bits and SW for words.
5 or higher	–	Not used for the Extended MEMOBUS protocol.

The register types that can be used depend on whether you are reading or writing.

The following table lists the combinations of register types.

Function Code	Applicable Register Types
4341 or 4349 hex	M, G, I, O, or S
4345, 4346, 434B, or 434F hex	M, G, O, or S
434D hex*	M or G
434E hex*	M or G

* The address table at the remote station is stored in registers in the local station. The contents of the M, G, I, O, and S registers in the remote station can be read by specifying the register type in the address table at the remote station.

For more information on remote station address tables, refer to the following sections.

 *Function Code: 434D Hex on page 6-17*



 *Function Code: 434E Hex on page 6-19*

Inputs and Outputs for the MSG-RCVE Function

I/O Definitions	No.	Name	I/O Designation	Meaning	Description
Input Items	1	Execute	B-VAL	Executes the transmission.	Specify the bit to use to execute the message transmission. When the Execute Bit turns ON, the message will be sent. Keep the Execute Bit ON until the Complete or Error Bit turns ON. To send another message, turn OFF the Execute Bit for at least one scan and then turn it ON again.
	2	Abort	B-VAL	Forces the transmission to end.	Specify the bit to use to abort the message transmission. When the Abort Bit turns ON, the message transmission will be stopped unconditionally. The Abort Bit takes precedence over the Execute Bit.
	3	Dev-Typ	I-REG	Communications device type	Specify the type code of the communications device. 218IFB, 218IFD = 16
	4	Pro-Typ	I-REG	Communications protocol	Specify the type code of the communications protocol. 1: MEMOBUS Select this protocol when using the Extended MEMOBUS protocol. MEMOBUS is automatically converted to Extended MEMOBUS inside the 218IFD. 2: No-protocol communications 1 (unit: words) Not used for the Extended MEMOBUS protocol. 3: No-protocol communications 2 (unit: bytes) Not used for the Extended MEMOBUS protocol.
	5	Cir-No	I-REG	Circuit number	Specify the circuit number for the communications device. Specify the same circuit number as displayed in the MPE720 Module Configuration Definition Tab Page. 218IFB, 218IFD = 1 to 8
	6	Ch-No	I-REG	Communications buffer channel number	Specify the channel number of the communications buffer. You can specify any channel number provided it is within the valid range. When executing more than one function at the same time, do not use the same channel number for the same connection. You can use the same channel number as long as multiple functions are not executed at the same time. 218IFB, 218IFD = 1 to 10
	7	Param	Address Inputs	Parameter list first address (MA, DA)	Specify the first address of the parameter list. A total of 52 words starting from the specified first word are automatically used for the parameter list. The parameter list is used by inputting function codes and relevant parameter data. It is also where the process results and status are output.























Continued on next page.

Continued from previous page.

I/O Definitions	No.	Name	I/O Designation	Meaning	Description
Output Items	1	Busy	B-VAL	Processing.	Specify the bit that shows that the message transmission is in progress. The Busy Bit is ON while a message transmission or abort is in progress. Keep the Execute Bit or Abort Bit turned ON while the Busy Bit is ON.
	2	Complete	B-VAL	Process completed.	Specify the bit that shows when the message transmission has been completed. The Complete Bit turns ON only for one scan when message transmission or forced abort processing has been completed normally.
	3	Error	B-VAL	Error occurred.	Specify the bit that shows if an error occurred when sending the message. When an error occurs, the Error Bit will turn ON only for one scan. Refer to the following section for an example of a timing chart for when an error occurs.   Error on page 2-23















MSG-RCVE Function Parameters

The following table describes the contents of the addresses specified by the PARAM input parameter to the MSG-RCVE function.

No.	I/O	Meaning	Description	Reference Page
00	Out-puts	Processing Result	Gives the processing status.	  Processing Result (PARAM00) on page 2-25
01		Status	Gives the status of the current function.	  Status (PARAM01) on page 2-25
02		Detail Error Code, Lower Word	Gives the details of an error.	  Detail Error Code (PARAM02 and PARAM03) on page 2-27
03				
04		Status 1	Gives the communications status.	  Status 1 (PARAM04) on page 2-27
05		Status 2	Gives status information on the most recent error.	  Status 2 (PARAM05) on page 2-28
06		Status 3	Gives the information of the send pass counter.	  Status 3 (PARAM06) on page 2-28
07		Status 4	Gives the information of the receive pass counter.	  Status 4 (PARAM07) on page 2-28
08		Status 5	Gives the information of the error counter.	  Status 5 (PARAM08) on page 2-28
09		Status 6	Not used for the Extended MEMOBUS protocol.	—
10	Input	Connection Number	Sets the connection number used to determine the remote station.	  Connection Number (PARAM10) on page 2-29
11	I/O	Option	Not used for the Extended MEMOBUS protocol.	—
12	Output	Function Code	Gives the function associated with reading or writing that was received from the remote station as the function code.	  Function Code (PARAM12) on page 2-29
13	I/O	Reserved for system.	This parameter is used by the system. Do not change the value of this parameter from a user program or by any other means.	  Reserved for System (PARAM13) on page 2-30







Continued on next page.

Continued from previous page.

No.	I/O	Meaning	Description	Reference Page
14	Out-puts	Data Address, Lower Word	Gives the first address of the data that was requested by the remote station.	 ◆ Data Address (PARAM14 and PARAM15) on page 2-30
15		Data Address, Upper Word		
16		Register Types	Gives the register type that was requested by the remote station.	 ◆ Register Type (PARAM16) on page 2-31
17		Data Size	Gives the data size that was requested by the remote station.	 ◆ Data Size (PARAM17) on page 2-31
18		Remote CPU Module Number	Not used for the Extended MEMOBUS protocol.	 ◆ Remote CPU Module Number (PARAM18) on page 2-31
19	I/O	Reserved for system.	This parameter is used by the system. Do not change the value of this parameter from a user program or by any other means.	 ◆ Reserved for System (PARAM19) on page 2-31
20	Inputs	Coil Offset Lower Word	Sets the offset word address for a coil (MB).	 ◆ Coil Offset (PARAM20 and PARAM21) on page 2-31
21		Coil Offset Upper Word		
22		Input Relay Offset, Lower Word	Sets the offset word address for an input relay (IB).	 ◆ Input Relay Offset (PARAM22 and PARAM23) on page 2-32
23		Input Relay Offset, Upper Word		
24		Input Register Offset, Lower Word	Sets the offset word address for an input register (IW).	 ◆ Input Register Offset (PARAM24 and PARAM25) on page 2-32
25		Input Register Offset, Upper Word		
26		Hold Register Offset, Lower Word	Sets the offset word address for a hold register (MW).	 ◆ Hold Register Offset (PARAM26 and PARAM27) on page 2-32
27		Hold Register Offset, Upper Word		
28		Data Relay Offset, Lower Word	Sets the offset word address for a data relay (GB).	 ◆ Data Relay Offset (PARAM28 and PARAM29) on page 2-32
29		Data Relay Offset, Upper Word		
30		Data Register Offset, Lower Word	Sets the offset word address for a data register (GW).	 ◆ Data Register Offset (PARAM30 and PARAM31) on page 2-32
31		Data Register Offset, Upper Word		
32		Output Coil Offset, Lower Word	Sets the offset word address for an output coil (OB).	 ◆ Output Coil Offset (PARAM32 and PARAM33) on page 2-32
33		Output Coil Offset, Upper Word		
34		Output Register Offset, Lower Word	Sets the offset address for an output register (OW).	 ◆ Output Register Offset (PARAM34 and PARAM35) on page 2-32
35	Output Register Offset, Upper Word			
36	M Register Writing Range LO, Lower Word	Sets the first address of the writing range for hold register coils.	 ◆ M Register Writing Range LO (PARAM36 and PARAM37) on page 2-33	
37	M Register Writing Range LO, Upper Word			

Continued on next page.

Continued from previous page.

No.	I/O	Meaning	Description	Reference Page
38	Inputs	M register Writing Range HI, Lower Word	Sets the last address of the writing range for hold register coils.	 ◆ M Register Writing Range HI (PARAM38 and PARAM39) on page 2-33
39		M Register Writing Range HI, Upper Word		
40		G register Writing Range LO, Lower Word	Sets the first address of the writing range for data register data relays.	 ◆ G Register Writing Range LO (PARAM40 and PARAM41) on page 2-33
41		G Register Writing Range LO, Upper Word		
42		G Register Writing Range HI, Lower Word	Sets the last address of the writing range for data register data relays.	 ◆ G Register Writing Range HI (PARAM42 and PARAM43) on page 2-33
43		G Register Writing Range HI, Upper Word		
44		O Register Writing Range LO, Lower Word	Sets the first address of the writing range for output registers.	 ◆ O Register Writing Range LO (PARAM44 and PARAM45) on page 2-33
45		O Register Writing Range LO, Upper Word		
46		O Register Writing Range HI, Lower Word	Sets the last address of the writing range for output registers.	 ◆ O Register Writing Range HI (PARAM46 and PARAM47) on page 2-34
47		O Register Writing Range HI, Upper Word		
48	-	For system use	This parameter is used by the system. It contains the channel number of the communications buffer that is currently in use. A user program must set this parameter to 0 on the first scan after startup. Thereafter, do not change the value of this parameter from a user program or by any other means because it will be used by the system.	 ◆ For System Use (PARAM48) on page 2-34
49	-	Reserved for system.	These parameters are used by the system. Do not change the value of these parameters from a user program or by any other means.	 ◆ Reserved for System (PARAM49 to PARAM51) on page 2-34
50	-	Reserved for system.		
51	-	Reserved for system.		

4.2 Communications with a Touch Panel

When using Ethernet communications between the MP3000 and a Touch Panel from Schneider Electric, use the Extended MEMOBUS protocol as the communications protocol. The Extended MEMOBUS protocol allows the master to read and write the slave registers.

This section describes communications when the MP3000 acts as a slave.

4.2.1 Using Automatic Reception with the MP3000 as a Slave

This section describes how to communicate with a Touch Panel from Schneider Electric by using automatic reception.

Note: You can also use the MSG-RCVE function to communicate. For information on the communications settings for using the MSG-RCVE function, refer to the following section.

MP3000 Setup on page 4-5

Setting Example

The following figure illustrates how the contents of the MW00100 hold register in the MP3000 slave is displayed on the Touch Panel, and written from the Touch Panel to the same register.

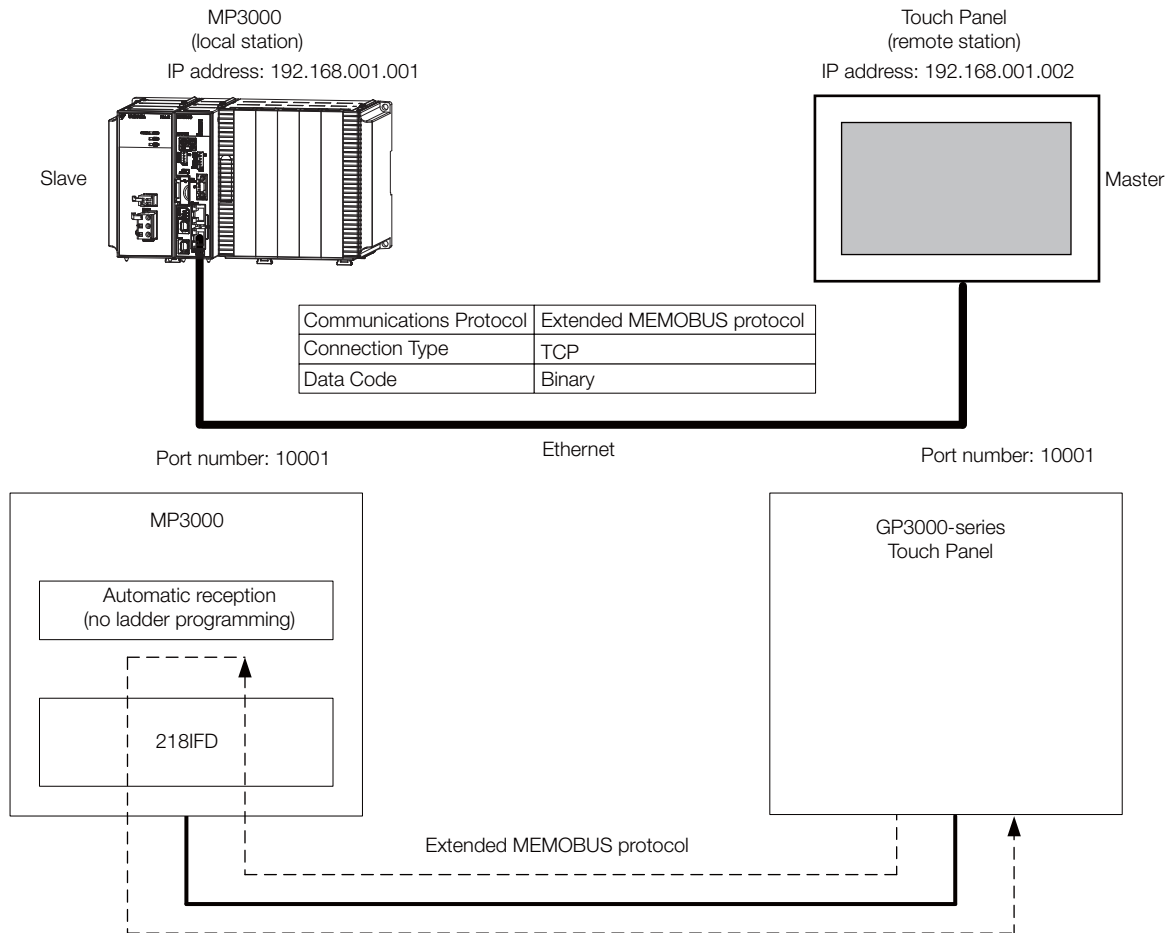

Note: You can also use the MSG-RCVE function to communicate. For information on the communications settings for using the MSG-RCVE function, refer to the following section.

MP3000 Setup on page 4-5

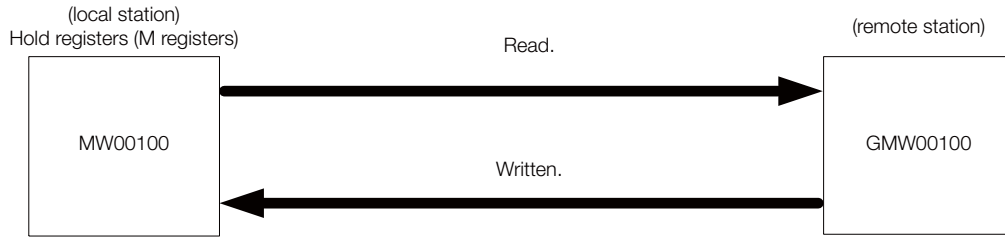

MP3000 Setup

Use the following procedure to set up the MP3000.

Information If the communications parameters (IP address and subnet mask) have already been set, skip to step 3.

1. Double-click the cell for 218IFD in the Module Configuration Definition Tab Page.

Module	Function Module/Slave	Status	Circuit No./AxisAddress		Motion Register	Register(Input/Output)		
			Start	cupied circui		Disabled	Start - End	Size
01 [CPU-302(32axes)] - ---								
808-NEW 10 00 CPU302(32)[-----]	01 CPU							
	02 218IFD		□	Circuit No1	1	<input type="checkbox"/> Input <input type="checkbox"/> OutPut	0000 - 07FF[H]	2048
	03 SVC32		■	Circuit No1	1	<input type="checkbox"/> Input <input type="checkbox"/> OutPut	0800 - 0BFF[H]	1024
	04 SVR32		■	Circuit No3	1			
	05 M-EXECUTOR							
06 -- UNDEFINED --								
07 -- UNDEFINED --								
01 -- UNDEFINED --[-----]								
02 -- UNDEFINED --[-----]								
03 -- UNDEFINED --								
02 -- UNDEFINED --								
02 -- UNDEFINED --								
03 -- UNDEFINED --								
04 -- UNDEFINED --								

The 218IFD Detail Definition Dialog Box will be displayed.

2. Set the communications parameters.

- ① In the [IP Address] Boxes, enter the following address: 192.168.001.001.
- ② In the [Subnet Mask] Boxes, enter the following mask: 255.255.255.000.
- ③ In the [Gateway IP Address] Boxes, enter the following address: 000.000.000.000.

3. Click the [Easy setting] Button in the [Message Communication] Area in the [Connection Parameter] Area.

CNO	Local Port	Node IP Address	Node Port	Connect Type	Protocol Type	Code	Detail
01	-----						Setting*
02	-----						Setting*
03	-----						Setting*
04	-----						Setting*
05	-----						Setting*
06	-----						Setting*
07	-----						Setting*

The Message Communications Easy Setting Dialog Box will be displayed.

4. Set the connection parameters.

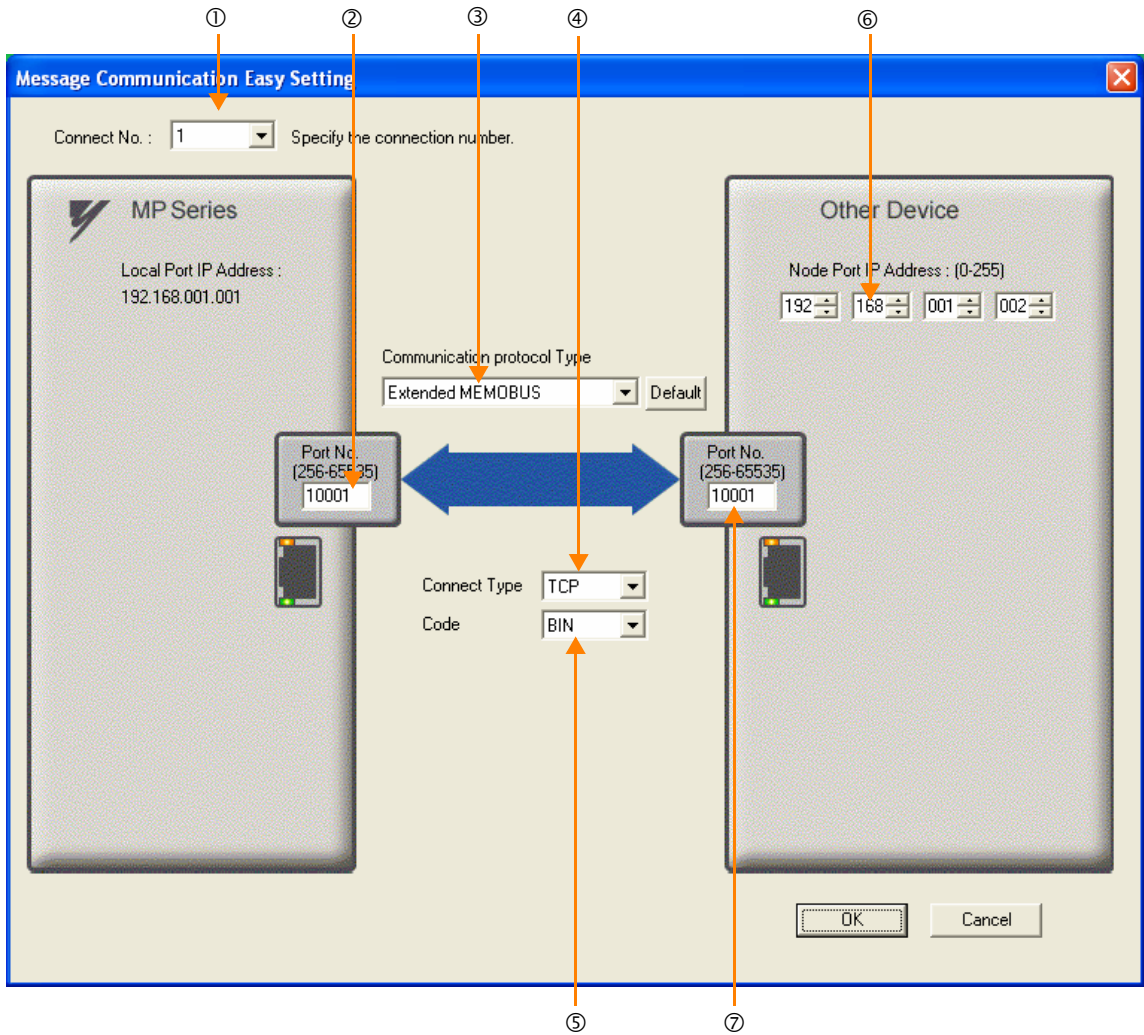

- ① Select [1] in the [Connect No.] Box.
- ② Enter "10001" in the [Port No.] Box for the MP-series Controller.
- ③ Select [Extended MEMOBUS] in the [Communications Protocol Type] Box, and then click the [Default] Button.
- ④ Select [TCP] in the [Connect Type] Box.
- ⑤ Select [BIN] in the [Code] Box.
- ⑥ Enter the following address in the [Node Port IP Address] Boxes for the other device: 192.168.001.002.
- ⑦ Enter "10001" in the [Port No.] Box for the other device.

5. Click the [OK] Button.

6. Click the [Yes] Button in the Transmission Parameters Confirmation Dialog Box.

Note: If parameters have already been set for the same connection number and you click the [Yes] Button in the Transmission Parameters Confirmation Dialog Box, the settings will be overwritten by the parameters that are set in the Message Communications Easy Setting Dialog Box.

7. Check the settings and double-click the [Setting] Button in the [Detail] Column.

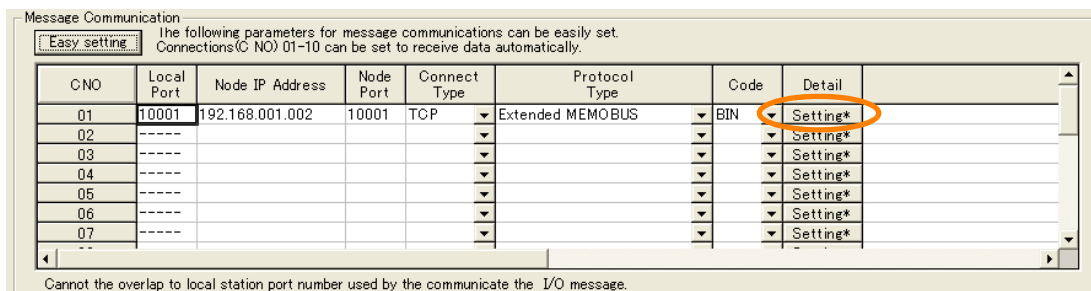

8. Select the [Enable] Option in the Automatically Reception Tab Page and then click the [OK] Button.

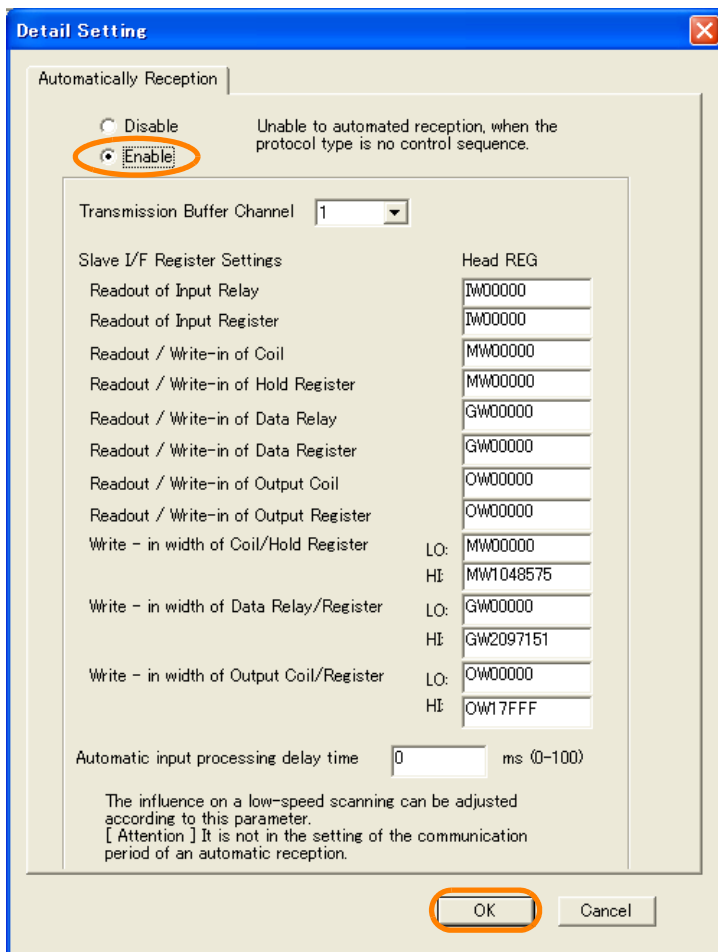

Note: Disable automatic reception for any connection for which message functions (MSG-SNDE and MSG-RCVE) are used. If message functions are used while automatic reception is enabled, the communications will not function properly.

9. Save the data to flash memory.

Note: Changes made to the communications or connection parameters will become effective only after the changes have been saved to flash memory and the power supply has been cycled.

This concludes the settings for using the MP3000 as a slave.

◆ **Setting Up the Touch Panel**

This section describes the procedures to perform in GP-Pro EX to connect the MP3000 to a GP3000-series Touch Panel from Schneider Electric, and it provides a screen creation example.

Information The GP3000-series and GP-Pro EX are manufactured by Schneider Electric. Contact Schneider Electric for further information.

■ **GP-Pro EX Setup**

1. Start GP-Pro EX.
2. Create a project.
3. Specify the Display Unit. Set the actual model that will be used for the Display Unit. This procedure is described for the AGP-3600T.

Series	GP3000 Series
	AGP33** Series
Model	AGP-3600T
Orientation	Landscape

4. Specify the device or PLC connected.

Manufacturer	YASKAWA Electric Corporation
Series	MEMOBUS Ethernet

5. Specify the connection method.

Port	Ethernet (TCP)
------	----------------

6. Select [Device/PLC] under [Peripheral Settings] on the System Settings Sidebar to display the Connected Equipment Setting Tab Page.

7. Specify the communications settings.

Port Number	10001
Timeout	3 (sec)
Retry	0
Wait to Send	00 (ms)

- Port Numbers
- If you disable the automatic assignment option by clearing the selection of the Auto Check Box next to the Port No. Box on the Communication Setting Dialog Box, the port number for the GP3000-series Touch Panel will be set to the user-specified setting.
- If you enable the automatic assignment option by selecting the Auto Check Box next to the Port No. Box on the Communication Setting Dialog Box, the port number for the GP3000-series Touch Panel will be assigned each time the connection is made.

If the automatic assignment option is selected, set the connection to the Unpassive Open Mode in the 218IFD Detail Definition Dialog Box in the MPE720.

The following table shows the relationship of the settings in GP-Pro EX and MPE720.

MPE720 setting \ GP-Pro EX Setup	Unpassive Open Mode	Fixed Value Setting
Automatic assignment enabled.	Yes	No
Automatic assignment disabled.	Yes	Yes

Note: Yes: Connection allowed, No: Connection not allowed

- Setting the MP3000 to Unpassive Open Mode

If the remote station's address is set to 000.000.000.000 and the remote station's port number is set to 0, the connection is set to the Unpassive Open Mode.

Transmission Parameters | Status |

Transmission Parameters

IP Address : 192 . 168 . 1 . 1 (0-255) Module Name Definition
 Subnet Mask : 255 . 255 . 255 . 0 (0-255) Equipment name : CONTROLLER NAME
 Gateway IP Address : 0 . 0 . 0 . 0 (0-255) Detail Definition

Connection Parameter

Message Communication
 Easy setting the following parameters for message communications can be easily set.
 Connections(C NO) 01-10 can be set to receive data automatically.

CNO	Local Port	Node IP Address	Node Port	Connect Type	Protocol Type	Code	Detail
01	10001	000.000.000.000	00000	TCP	Extended MEMOBUS	BIN	Setting*
02	-----						Setting*
03	-----						Setting*
04	-----						Setting*
05	-----						Setting*
06	-----						Setting*
07	-----						Setting*

Cannot the overlap to local station port number used by the communicate the I/O message.

8. Click the [Settings] Button for PLC1 in the [Device-Specific Settings] Area to display the Individual Device Settings Dialog Box.

9. Specify the device or PLC connected.

The Individual Device Settings Dialog Box is used to specify the MP3000 to connect to. Set the IP address, port number, and data code to the same values set in the 218IFD Detail Definition Dialog Box for the MP3000.

IP address	192.168.001.001
Port Number	10001
Data Code	BINARY

- 218IFD Detail Definition Dialog Box

Transmission Parameters | Status |

Transmission Parameters

IP Address : 192 . 168 . 1 . 1 (0-255) Module Name Definition
 Subnet Mask : 255 . 255 . 255 . 0 (0-255) Equipment name : CONTROLLER NAME
 Gateway IP Address : 0 . 0 . 0 . 0 (0-255) Detail Definition

Connection Parameter

Message Communication
 Easy setting the following parameters for message communications can be easily set.
 Connections(C NO) 01-10 can be set to receive data automatically.

CNO	Local Port	Node IP Address	Node Port	Connect Type	Protocol Type	Code	Detail
01	10001	2.168.001.002	10001	TCP	Extended MEMOBUS	BIN	Setting*
02	-----						Setting*
03	-----						Setting*
04	-----						Setting*
05	-----						Setting*
06	-----						Setting*
07	-----						Setting*

Cannot the overlap to local station port number used by the communicate the I/O message.

- Note:
- Specify an IP address that is not in use by any other device on the same network.
 - The IP address for the MP3000 will be automatically set to 192.168.1.1. Check with your network administrator for unused IP addresses.
 - Place the GP3000-series Touch Panel in offline mode when setting the IP address. Contact Schneider Electric for further information.

This concludes the setup for the touch panel.

Create a screen and transfer the project to the touch panel as necessary.

■ Screen Creation Example

1. Create a base screen.
2. From the tool bar, select [Data Display] and place the object on the screen.

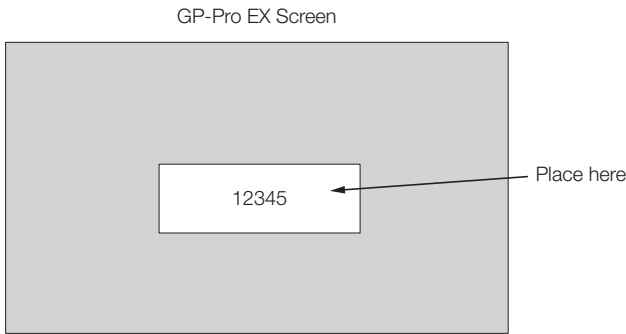

3. Double-click the [Data Display] placed on the screen.

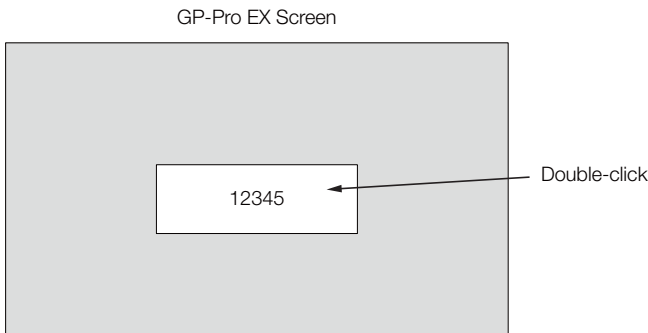

4. Enter the following settings in the Data Display Dialog Box and click the [OK] Button.

Display Data	Numeric Display
Monitor Word Address	GMW00100

- The following table shows the relationship between the address display in GP-Pro EX and registers in the MP3000.

Device	Address Display in GP-Pro EX	Registers in MP3000
Coils as bits	GMB□□□□□□	MB□□□□□□
Coils as words	GMW□□□□□□	MW□□□□□□
Input relays as bits	GIB□□□□□□	IB□□□□□□
Input relays as words	GIW□□□□□□	IW□□□□□□

◆ Starting Communications

1. Turn ON the power to the MP3000 to start receiving messages.
The system will automatically start the message reception operation. No further operation is required.
2. Start the GP3000-series Touch Panel to display the main screen.
Communications with the MP3000 will start after the touch panel operating system starts.
Note: Contact Schneider Electric for further information.

4.3 Communications with a Mitsubishi PLC (A-compatible 1E Frame Protocol)

When using Ethernet communications between the MP3000 and a Mitsubishi Q/A-series PLC, use the A-compatible 1E Frame protocol as the communications protocol. The A-compatible 1E Frame protocol allows the master to read and write the contents of slave registers.

This section describes communications when the MP3000 acts as a slave and as the master.

4.3.1 Using Automatic Reception with the MP3000 as a Slave

This section describes how to perform serial communications with a Mitsubishi PLC by using automatic reception.

Setting Example

The following figure illustrates how the contents of the D00201 to D00300 data registers in the Mitsubishi PLC master are written to the MW00000 to MW00099 hold registers in the MP3000 slave.

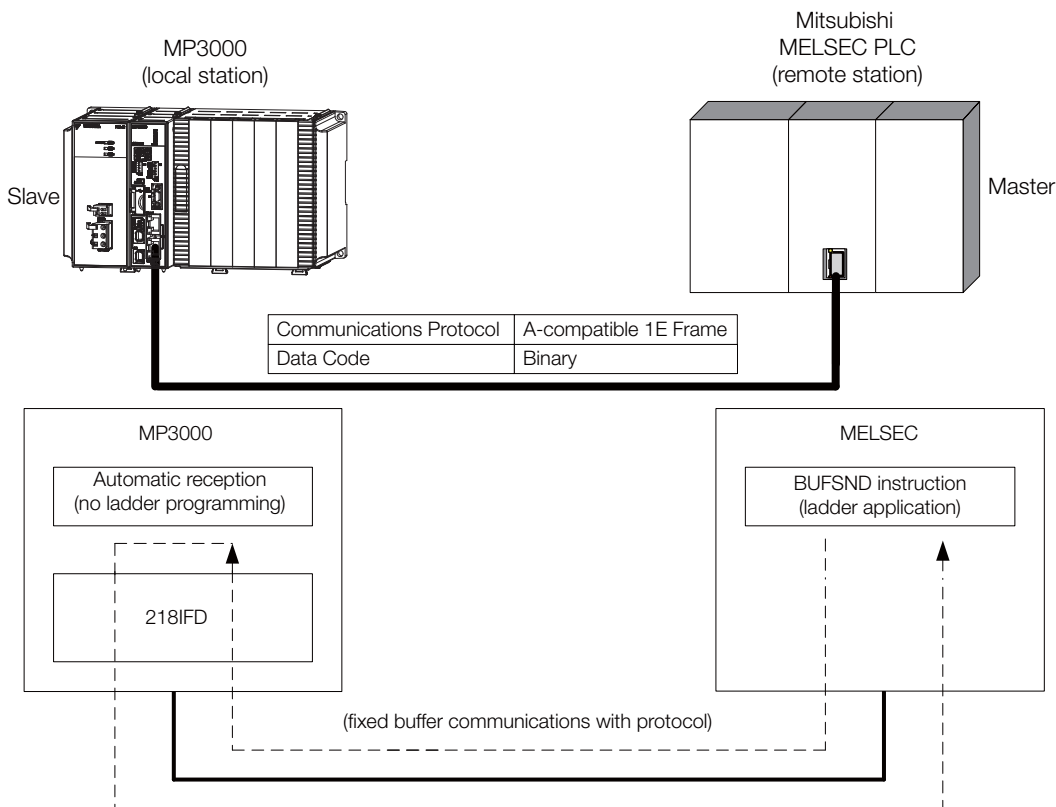

Note: When using the A-compatible 1E Frame protocol to communicate with a Mitsubishi PLC, the PLC can read from and write to hold registers in the MP3000 by using fixed buffer communications. Due to the specifications of the A-compatible 1E Frame protocol, inter-CPU Module communications and random-access communications cannot be used if the MP3000 is acting as a slave.

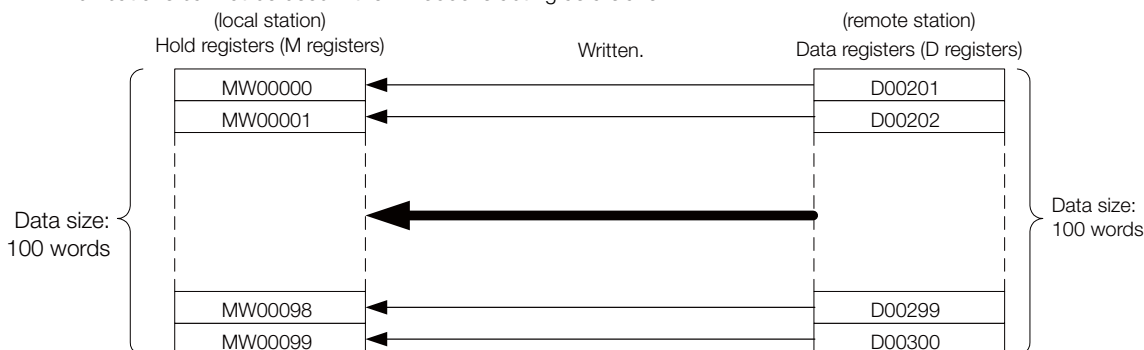

MP3000 Setup

Use the following procedure to set up the MP3000.

Information If the communications parameters (IP address and subnet mask) have already been set, skip to step 3.

1. Double-click the cell for 218IFD in the Module Configuration Definition Tab Page.

Module	Function Module/Slave	Status	Circuit No./Axis Address		Motion Register	Register(Input/Output)			
			Start	cupied circ.		Disabled	Start - End	Size	
01 [CPU-302(32axes)] : ---	01 CPU	----	----	----	----	-----	-----	----	
800-NEW I/O	02 218IFD	----	□	Circuit No 1	1	-----	Input Output	0000 - 07FF[H]	2048
	03 ⊕ SVC32	----	□	Circuit No 1	1	8000 - 87FF[H]	Input Output	0800 - 0BFF[H]	1024
	04 ⊕ SVR32	----	□	Circuit No 3	1	9000 - 97FF[H]	-----	-----	----
	05 M-EXECUTOR	----	----	----	----	----	-----	0C00 - 0C3F[H]	64
	06 -- UNDEFINED --	----	----	----	----	----	-----	-----	----
07 -- UNDEFINED --	----	----	----	----	----	-----	-----	----	
01 -- UNDEFINED --	----	----	----	----	----	-----	-----	----	
02 -- UNDEFINED --	----	----	----	----	----	-----	-----	----	
03 -- UNDEFINED --	----	----	----	----	----	-----	-----	----	
04 -- UNDEFINED --	----	----	----	----	----	-----	-----	----	

The 218IFD Detail Definition Dialog Box will be displayed.

2. Set the communications parameters.

- ① In the [IP Address] Boxes, enter the following address: 192.168.001.001.
- ② In the [Subnet Mask] Boxes, enter the following mask: 255.255.255.000.
- ③ In the [Gateway IP Address] Boxes, enter the following address: 000.000.000.000.

3. Click the [Easy setting] Button in the [Message Communication] Area in the [Connection Parameter] Area.

CNO	Local Port	Node IP Address	Node Port	Connect Type	Protocol Type	Code	Detail
01	----						Setting*
02	----						Setting*
03	----						Setting*
04	----						Setting*
05	----						Setting*
06	----						Setting*
07	----						Setting*

The Message Communication Easy Setting Dialog Box will be displayed.

4. Set the connection parameters.

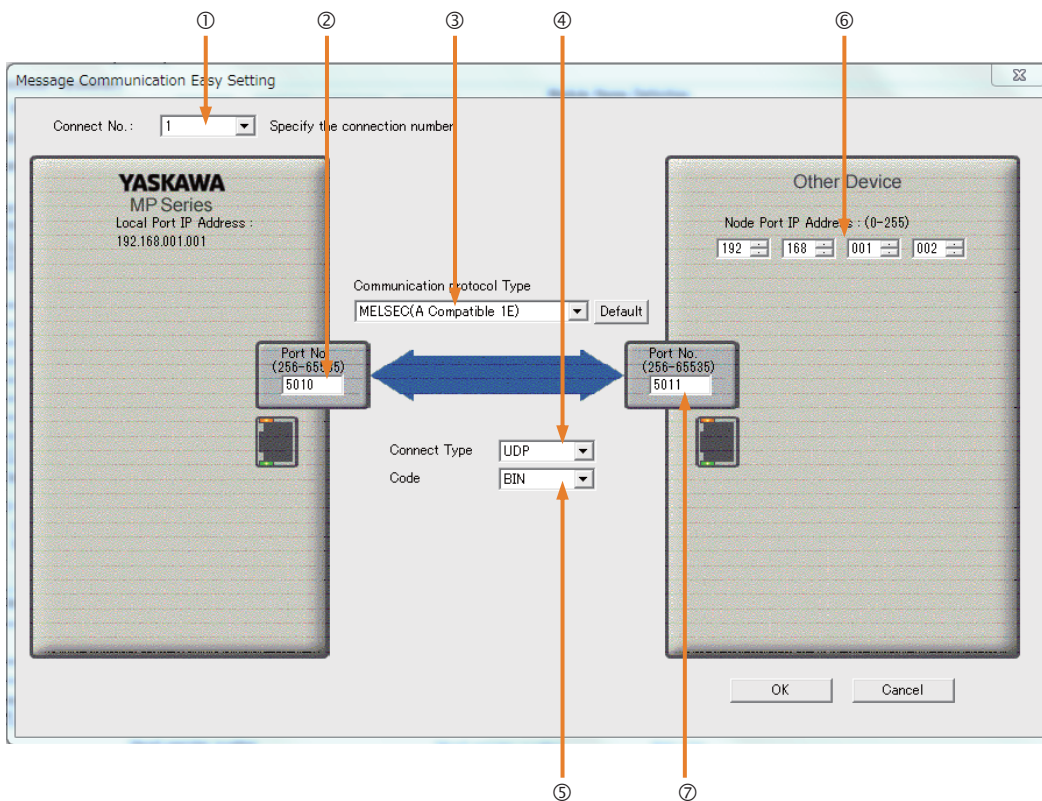

- ① Select [1] in the [Connect No.] Box.
- ② Enter "5010" in the [Port No.] Box for the MP-series Controller.
- ③ Select [MELSEC (A-compatible 1E)] in the [Communication Protocol Type] Box.
- ④ Select [UDP] in the [Connect Type] Box.
- ⑤ Select [BIN] in the [Code] Box.
- ⑥ Enter the following address in the [Node Port IP Address] Boxes for the other device: 192.168.001.002.
- ⑦ Enter "5011" in the [Port No.] Box for the other device.

Note: Disable automatic reception for any connection for which message functions (MSG-SNDE) are used. If message functions are used while automatic reception is enabled, the communications will not function properly.

5. Click the [OK] Button.

6. Click the [Yes] Button in the Transmission Parameters Confirmation Dialog Box.

Note: If parameters have already been set for the same connection number and you click the [Yes] Button in the Transmission Parameters Confirmation Dialog Box, the settings will be overwritten by the parameters that are set in the Message Communications Easy Setting Dialog Box.

7. Check the settings and double-click the [Setting] Button in the [Detail] Column.

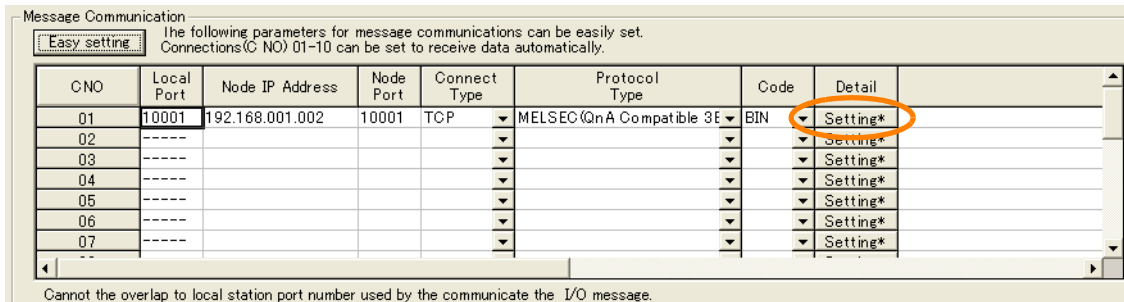

8. Select the [Enable] Option on the Automatically Reception Tab Page.

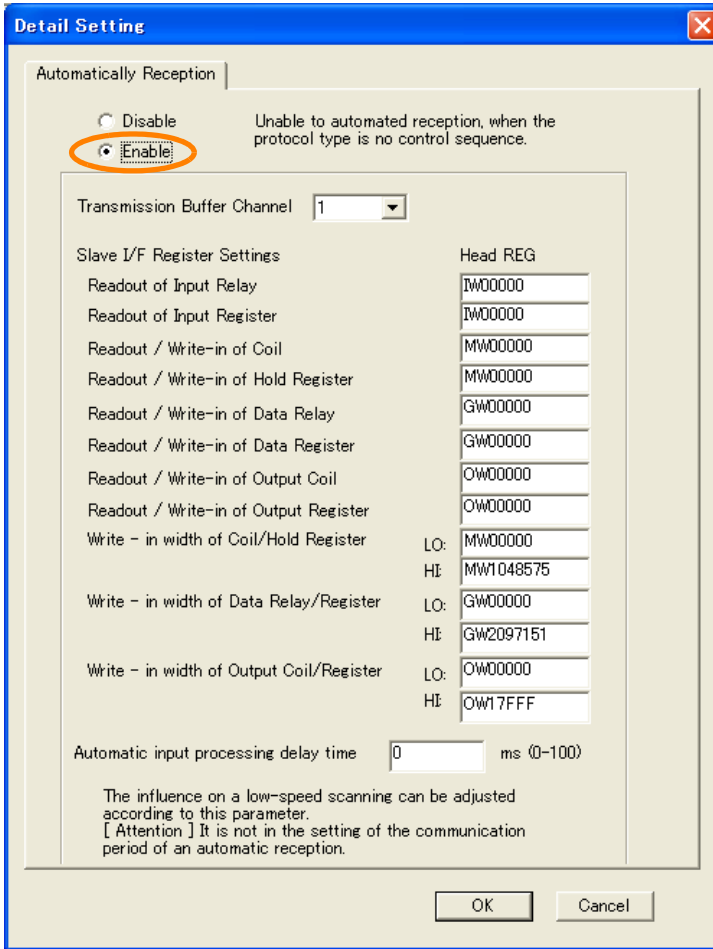

Note: Changes made to the communications or connection parameters will become effective only after the changes have been saved to flash memory and the power supply has been cycled.

◆ Setting Up the Remote Device (Mitsubishi PLC)

MELSEC devices are manufactured by Mitsubishi Electric Corporation. Contact Mitsubishi Electric Corporation for further information on configuring MELSEC devices.

◆ Starting Communications

1. Turn ON the power to the MP3000 to start receiving messages.
The system will automatically start the message reception operation. No further operation is required.
2. Use an OPEN instruction in the MELSEC PLC to establish a connection with the MP3000, then use a BUFSD instruction to send messages.
When the Mitsubishi PLC starts sending messages, communications with the MP3000 will start.

4.3.2 Using I/O Message Communications with the MP3000 as the Master

This section describes how to perform inter-CPU Module communications with a Mitsubishi Q/A-series PLC by using I/O message communications.

Setting Example

The following figure illustrates how the contents of the D00000 to D00099 data registers in the Mitsubishi Q/A-series PLC slave can be read into the IW0000 to IW0063 input registers in the MP3000 master and how the contents of the OW0064 to OW00C7 output registers in the MP3000 master are written to the D00100 to D00199 data registers in the Mitsubishi Q/A-series PLC slave.

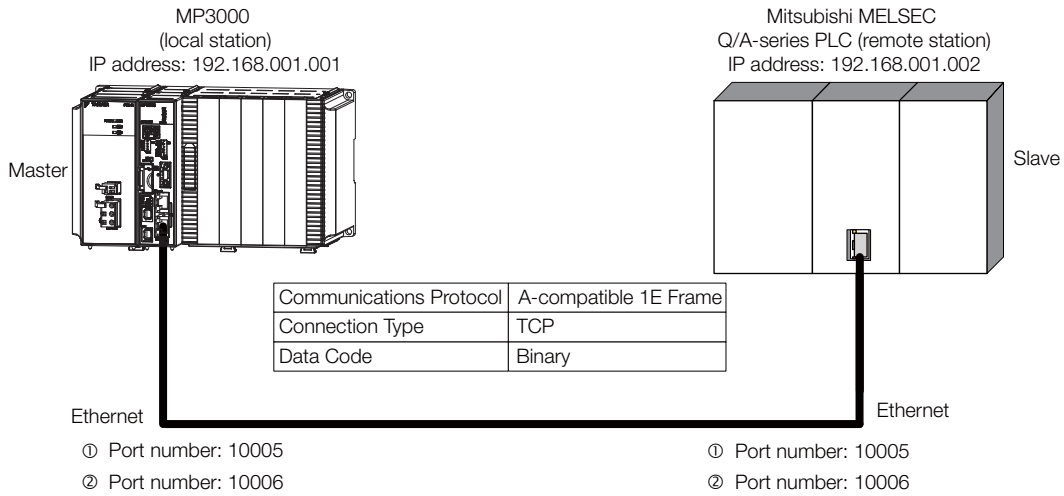

Note: The above figure is described using the same port numbers to make the communications connections easier to understand. It is acceptable to set different port numbers when making the actual communications connections.

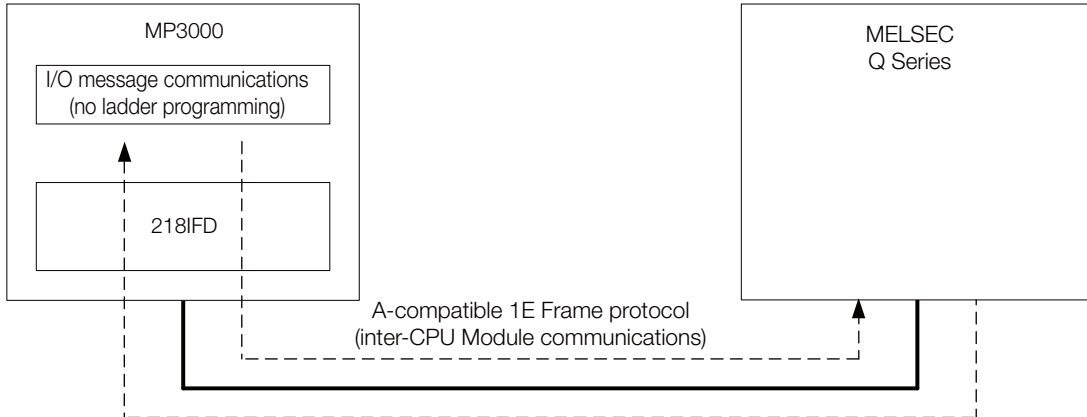

- Note:
- I/O message communications use one-to-one communications.
 - When using the A-compatible 1E Frame protocol to communicate with a Mitsubishi Q/A-series PLC, the PLC can read from and write to the following registers by using inter-CPU Module communications.
 - Bit device registers: X, Y (read-only), M, B
 - Word device registers: D, W, R
 A bit device register is read or written in units of 16-bit words.
 - Use the MSG-SNDE function if you need to read from or write to registers other than those listed above, to use fixed or random access buffer communications, or to communicate with multiple remote devices.

4.3.2 Using I/O Message Communications with the MP3000 as the Master

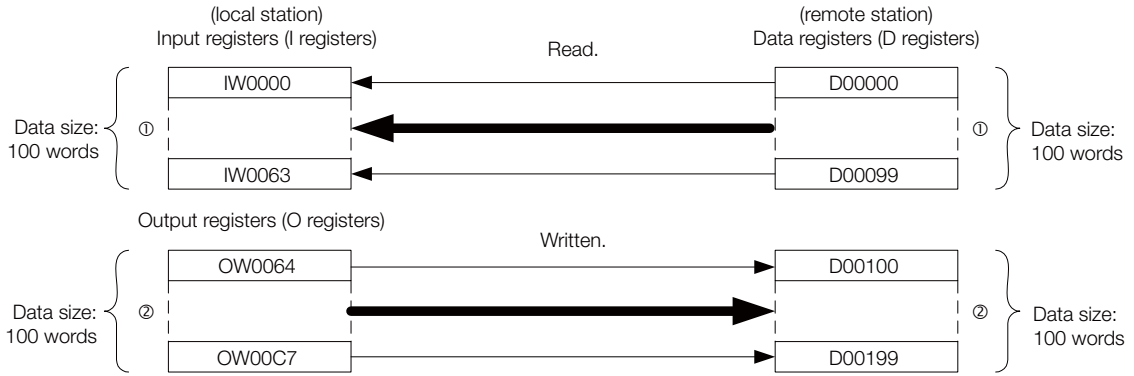

MP3000 Setup

Use the following procedure to set up the MP3000.

Information If the communications parameters (IP address and subnet mask) have already been set, skip to step 3.

1. Double-click the cell for 218IFD in the Module Configuration Definition Tab Page.

Module	Function Module/Slave	Status	Circuit No./AxisAddress		Motion Register	Register(Input/Output)		
			Start	cupied circ.		Disabled	Start - End	Size
01 [CPU-302(32axes)] : ---	01 CPU	---	---	---	---	---	---	---
01 [MODULE-303]	02 218IFD	---	品 Circuit No1	1	---	<input type="checkbox"/> Input <input type="checkbox"/> OutPut	0000 - 07FF[H]	2048
	03 SVC32	---	品 Circuit No1	1	8000 - 87FF[H]	<input type="checkbox"/> Input <input type="checkbox"/> OutPut	0800 - 0BFF[H]	1024
	04 SVR32	---	品 Circuit No3	1	9000 - 97FF[H]	---	---	---
	05 M-EXECUTOR	---	---	---	---	---	0C00 - 0C3F[H]	64
	06 -- UNDEFINED --	---	---	---	---	---	---	---
07 -- UNDEFINED --	---	---	---	---	---	---	---	---
01 -- UNDEFINED -- [-----]	---	---	---	---	---	---	---	---
02 -- UNDEFINED -- [-----]	---	---	---	---	---	---	---	---
03 -- UNDEFINED --	---	---	---	---	---	---	---	---
04 -- UNDEFINED --	---	---	---	---	---	---	---	---

The 218IFD Detail Definition Dialog Box will be displayed.

2. Set the communications parameters.

- ① In the [IP Address] Boxes, enter the following address: 192.168.001.001.
- ② In the [Subnet Mask] Boxes, enter the following mask: 255.255.255.000.
- ③ In the [Gateway IP Address] Boxes, enter the following address: 000.000.000.000.

3. Select the [Enable] Option in the [I/O Message Communication] Area of the [Connection Parameter] Area.

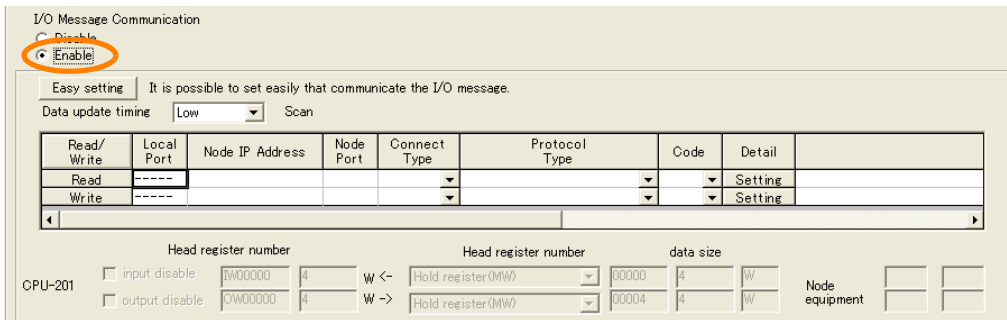

The Message Communication Easy Setting Dialog Box will be displayed.

4. Click the [Easy setting] Button.
5. Set the connection parameters.

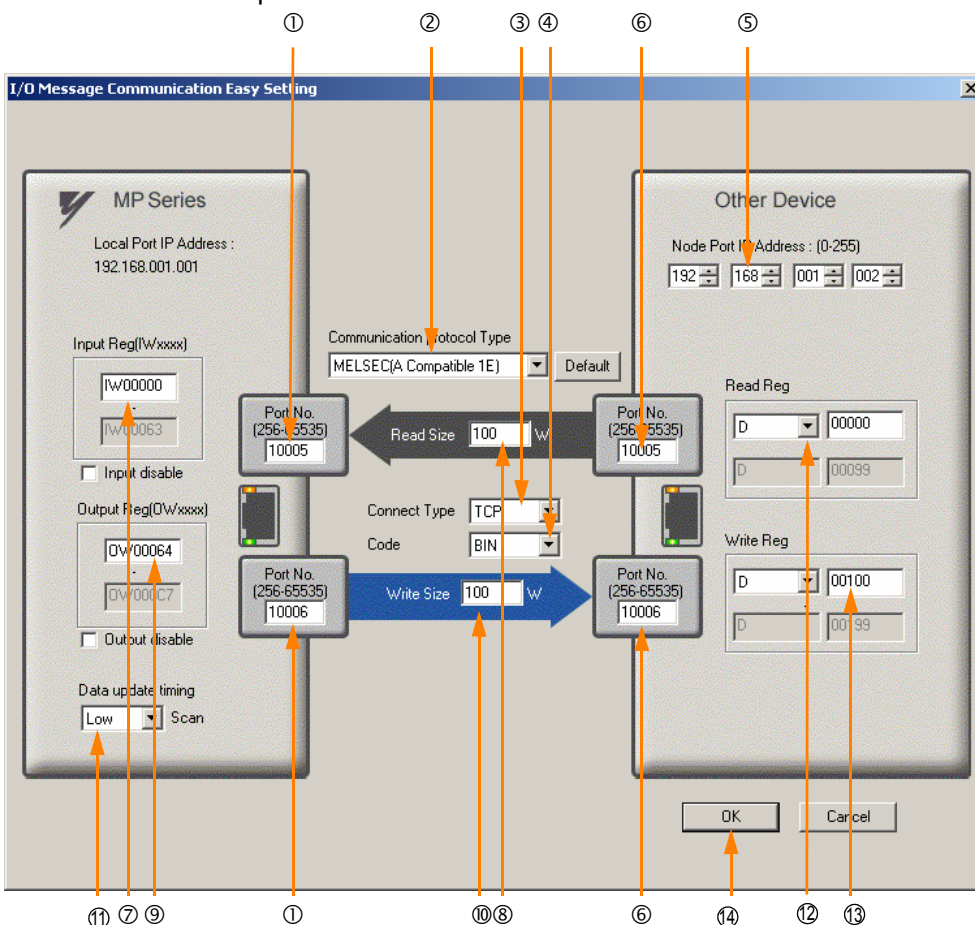

- ① Enter "10005" and "10006" in the [Port No.] Box for the MP-series Controller.
- ② Select [MELSEC (A-compatible 1E)] in the [Communication Protocol Type] Box, and then click the [Default] Button.

Note: If you are using the MELSEC (A-compatible 1E) communications protocol, the read and write register type will be set to D (word device) registers by default.

- ③ Select [TCP] in the [Connect Type] Box.
- ④ Select [BIN] in the [Code] Box.
- ⑤ Enter the following address in the [Node Port IP Address] Boxes for the other device: 192.168.001.002.
- ⑥ Enter "10005" and "10006" in the [Port No.] Boxes for the other devices.

Note: In I/O message communications, a message is transmitted from each port for which a register read/write is initiated. Therefore, for this example, the connected remote device must support a message reception function to receive two messages.

- ⑦ Enter "IW0000" in the [Input Reg] Box as the read data destination.
- ⑧ Enter "100" in the [Read Size] Box as the size of data to read.

4.3.2 Using I/O Message Communications with the MP3000 as the Master

- ⑨ Enter "OW0064" in the [Output Reg] Box as the write data destination.
- ⑩ Enter "100" in the [Write Size] Box as the size of data to write.
- ⑪ Select [Low] in the [Data update timing] Box as the timing to update I/O data between the CPU Function Module and 218IFD.

Note: The data update timing is the timing at which the CPU Function Module and 218IFD exchange data. Communications with the remote device are performed asynchronously. The data update timing therefore does not necessarily mean that the messages are sent to the remote device.

- ⑫ Enter "D00000" in the [Read Reg] Box as the register type and first address to read from on the remote device.
- ⑬ Enter "D00100" in the [Write Reg] Box as the register type and first address to write to on the remote device.

6. Click the [OK] Button.

7. Click the [Yes] Button in the Transmission Parameters Confirmation Dialog Box.

Note: If parameters have already been set for the same connection number and you click the [Yes] Button in the Transmission Parameters Confirmation Dialog Box, the settings will be overwritten by the parameters that are set in the Message Communication Easy Setting Dialog Box.

8. Check the settings.

I/O Message Communication

Disable
 Enable

Easy setting It is possible to set easily that communicate the I/O message.

Data update timing: Low Scan

Read/Write	Local Port	Node IP Address	Node Port	Connect Type	Protocol Type	Code	Detail
Read	10005	192.168.001.002	10005	TCP	MELSEC(A Compatible 1E)	BIN	Setting
Write	10006	192.168.001.002	10006	TCP	MELSEC(A Compatible 1E)	BIN	Setting

Head register number Head register number data size

CPU-201 input disable JWD0000 100 W <- Data register(D) 00000 100 W

output disable OW00004 100 W -> Data register(D) 00100 100 W

Node equipment

9. Save the data to flash memory.

Note: Changes made to the communications or connection parameters will become effective only after the changes have been saved to flash memory and the power supply has been cycled.

This concludes the settings for using the MP3000 as the master.

◆ Setting Up the Remote Device (Mitsubishi Q/A-series PLC)

MELSEC devices are manufactured by Mitsubishi Electric Corporation.

Contact Mitsubishi Electric Corporation for further information on configuring MELSEC devices.

When using a MELSEC A-series Ethernet module (AJ71E71), you must create an initialization ladder program that sets the IP address and port number. Refer to "Communicating With Other Nodes" in the MELSEC manual and create a ladder program for initialization processing.

When using a MELSEC Q-series Ethernet module (QJ71E71-100), set the IP address and port number on the Ethernet Settings Window.

The following table lists the parameters for the MELSEC PLC.

Parameter	Setting (Connection Number 1)	Setting (Connection Number 2)
Protocol	TCP	TCP
Open system	Full passive	Full passive
Local station port No.	2715 hex (10005)	2716 hex (10006)
Destination IP address	192.168.1.1	192.168.1.1
Destination port No.	2715 hex (10005)	2716 hex (10006)

This concludes the setup.

◆ Starting Communications

- 1. Start receiving messages on the Mitsubishi Q/A-series PLC.**
The system will automatically start the message reception operation. No further operation is required.
- 2. Turn ON the power to the MP3000 to start transmitting messages.**
The system will automatically start the message transmission operation. No further operation is required.

4.3.3 Using the MSG-SNDE Function with the MP3000 as the Master

This section describes how to communicate with a Mitsubishi Q/A-series PLC by using the MSG-SNDE function.

Setting Example

The following figure illustrates how the contents of 64 words of data (D) registers (D00000 to D00063) in the CPU Unit of Mitsubishi Q/A-series PLC slave are read and then written to the MW10000 to MW10063 hold registers in the MP3000 master.

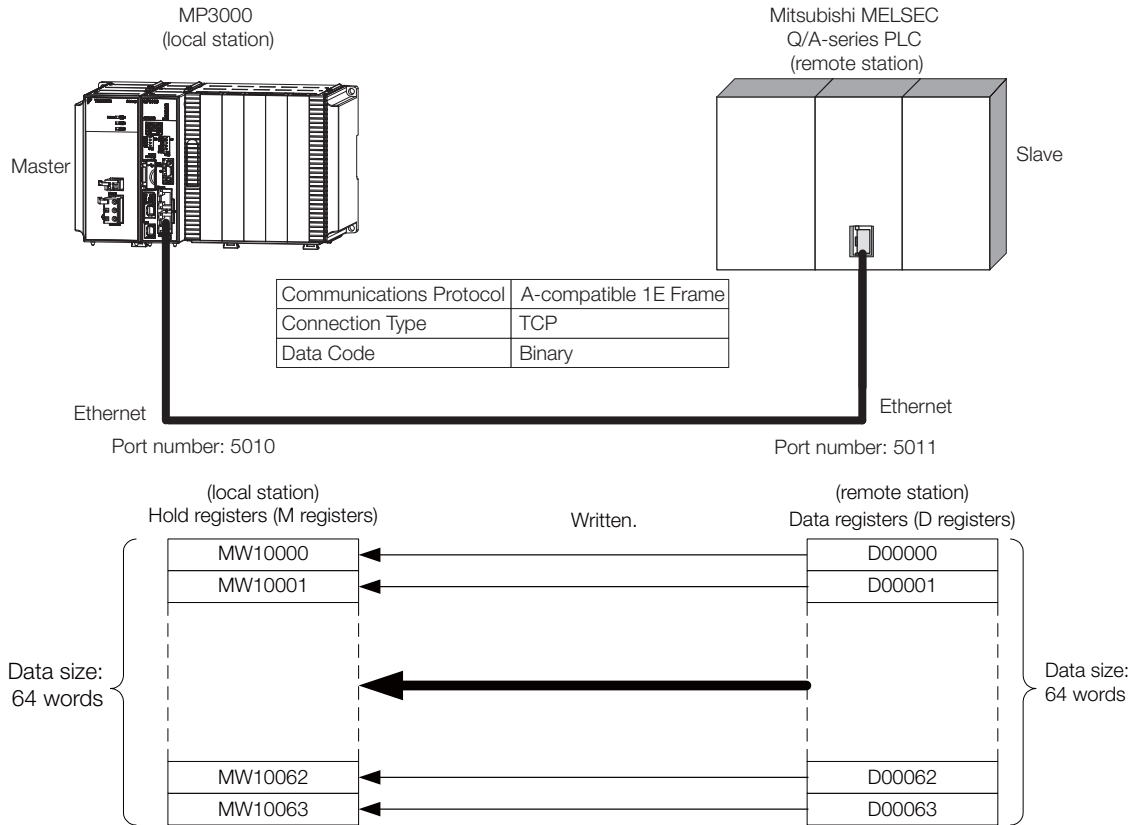

◆ MP3000 Setup

Use the following procedure to set up the MP3000.

Information If the communications parameters (IP address and subnet mask) have already been set, skip to step 3.

1. Double-click the cell for 218IFD in the Module Configuration Definition Tab Page.

Module	Function Module/Slave	Status	Circuit No./AxisAddress		Motion Register	Register(Input/Output)		
			Start	cupied circ		Disabled	Start - End	Size
01 [CPU-302(32axes)] : ---								
01 CPU302(32) [---]	01 CPU	---						
	02 218IFD	---	0	Circuit No1	1		Input Output	0000 - 07FF[H] 2048
	03 + SVC32	---	1	Circuit No1	1	8000 - 87FF[H]		
	04 + SVR32	---	1	Circuit No3	1	9000 - 97FF[H]		
	05 M-EXECUTOR	---						0C00 - 0C3F[H] 64
	06 -- UNDEFINED --	---						
	07 -- UNDEFINED --	---						
01 -- UNDEFINED -- [---]								
02 -- UNDEFINED -- [---]								
03 -- UNDEFINED -- [---]								
02 -- UNDEFINED --								
02 -- UNDEFINED --								
03 -- UNDEFINED --								
04 -- UNDEFINED --								

The 218IFD Detail Definition Dialog Box will be displayed.

2. Set the communications parameters.

Transmission Parameters: Status

Transmission Parameters

IP Address : 192 . 168 . 1 . 1 (0-255)

Subnet Mask : 255 . 255 . 255 . 0 (0-255)

Gateway IP Address : 0 . 0 . 0 . 0 (0-255)

Module Name Definition
Equipment name : CONTROLLER NAME

Detail Definition

- ① In the [IP Address] Boxes, enter the following address: 192.168.001.001.
- ② In the [Subnet Mask] Boxes, enter the following mask: 255.255.255.000.
- ③ In the [Gateway IP Address] Boxes, enter the following address: 000.000.000.000.

3. Click the [Easy setting] Button in the [Message Communication] Area in the [Connection Parameter] Area.

Connection Parameter

Message Communication

Easy setting

The following parameters for message communications can be easily set.
Connections(C NO) 01-10 can be set to receive data automatically.

CNO	Local Port	Node IP Address	Node Port	Connect Type	Protocol Type	Code	Detail
01	----						Setting*
02	----						Setting*
03	----						Setting*
04	----						Setting*
05	----						Setting*
06	----						Setting*
07	----						Setting*

The Message Communication Easy Setting Dialog Box will be displayed.

4. Set the connection parameters.

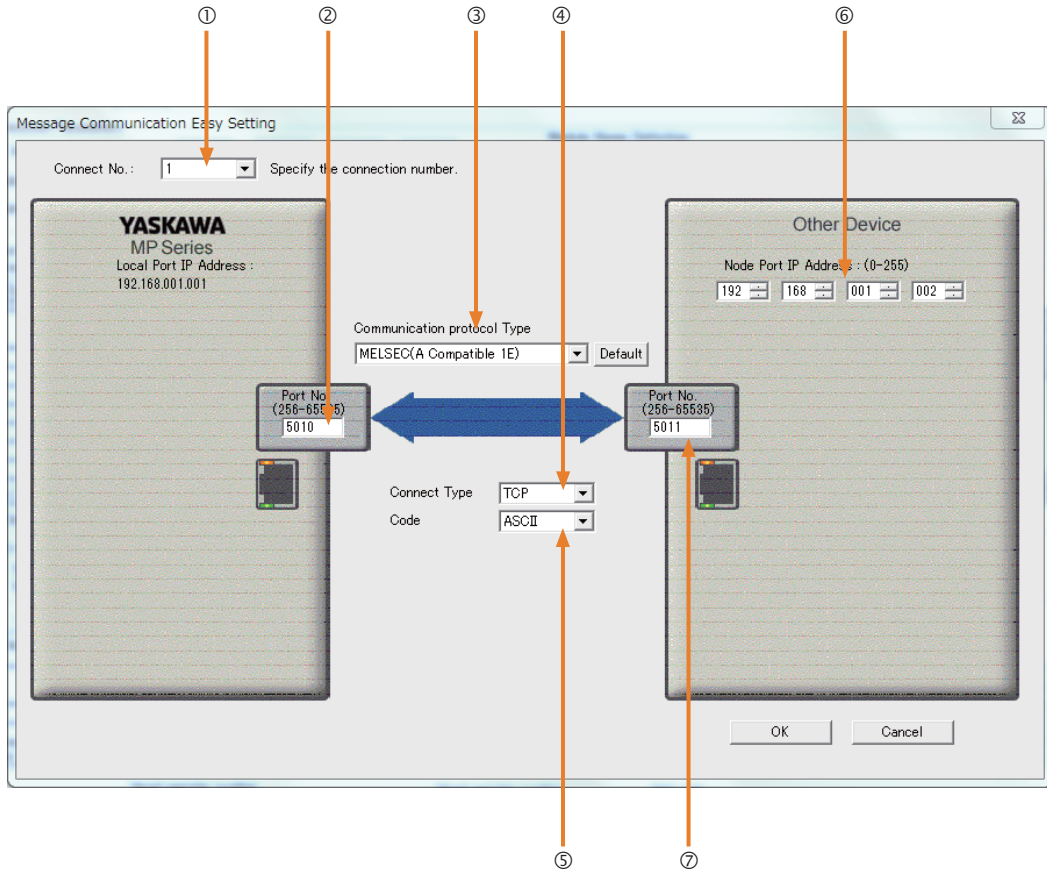

- ① Select [1] in the [Connect No.] Box.
- ② Enter "5010" in the [Port No.] Box for the MP-series Controller.
- ③ Select [MELSEC (A-compatible 1E)] in the [Communication Protocol Type] Box.
- ④ Select [UDP] in the [Connect Type] Box.
- ⑤ Select [ASCII] in the [Code] Box.
- ⑥ Enter the following address in the [Node Port IP Address] Boxes for the other device:
192.168.001.002.
- ⑦ Enter "5011" in the [Port No.] Box for the other device.

Note: Disable automatic reception for any connection for which message functions (MSG-SNDE) are used. If message functions are used while automatic reception is enabled, the communications will not function properly.

5. Click the [OK] Button.

6. Click the [Yes] Button in the Transmission Parameters Confirmation Dialog Box.

Note: If parameters have already been set for the same connection number and you click the [Yes] Button in the Transmission Parameters Confirmation Dialog Box, the settings will be overwritten by the parameters that are set in the Message Communications Easy Setting Dialog Box.

7. Check the settings and double-click the [Setting] Button in the [Detail] Column.

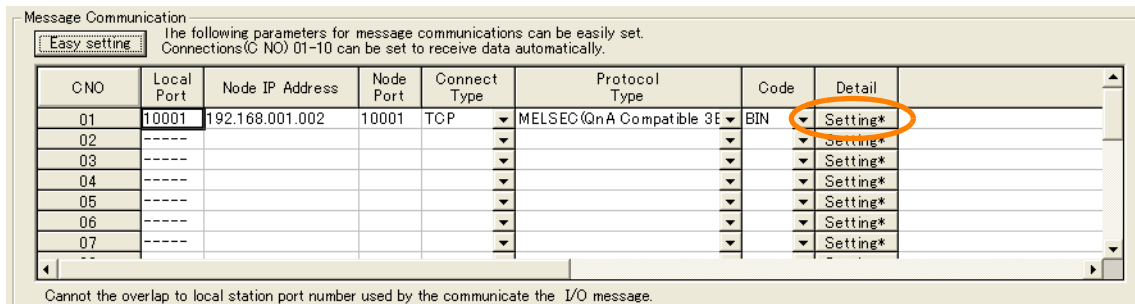

8. Click the [Disable] Option on the Automatically Reception Tab Page.

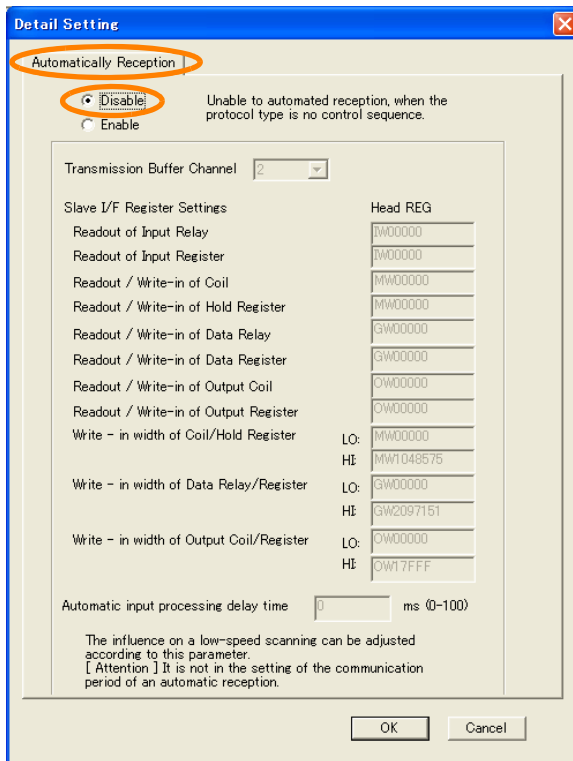

Note: Changes made to the communications or connection parameters will become effective only after the changes have been saved to flash memory and the power supply has been cycled.

9. Create a ladder program for the MSG-SNDE function.

A ladder program example is shown below.

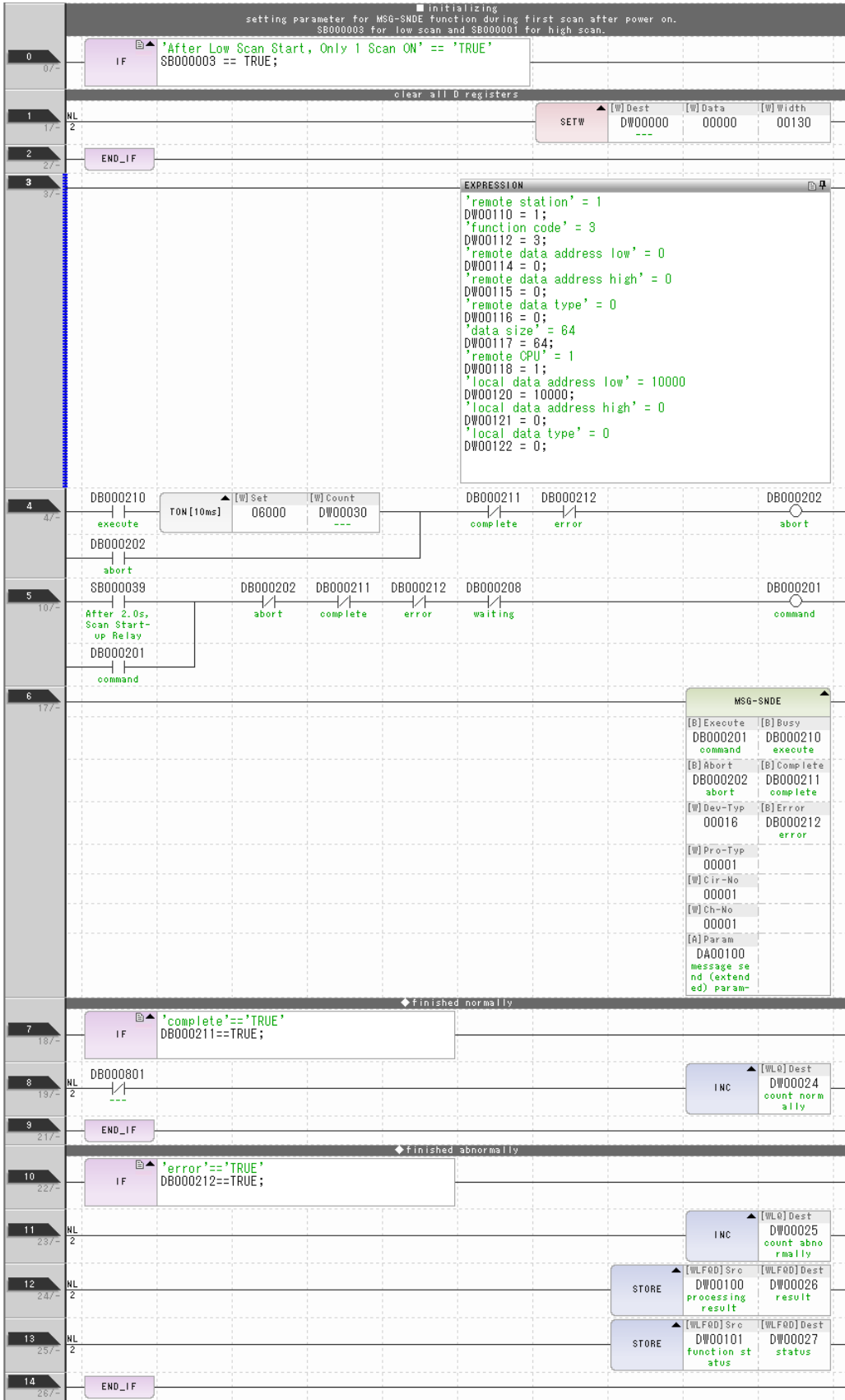

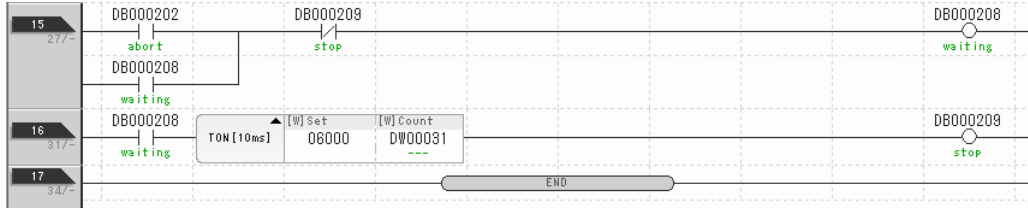

10. Save the data to flash memory.

This concludes the settings for using the MP3000 as the master.

◆ Setting Up the Remote Device (Mitsubishi Q/A-series PLC)

When using a MELSEC A-series Ethernet module (AJ71E71), you must create an initialization ladder program that sets the IP address and port number. Refer to “Communicating With Other Nodes” in the MELSEC manual and create a ladder program for initialization processing.

When using a MELSEC Q-series Ethernet module (QJ71E71-100), set the IP address and port number on the Ethernet Settings Window.

To perform communications in ASCII mode, set the communications data code setting in the Ethernet operation settings to [ASCII Code Communications].

Information MELSEC devices are manufactured by Mitsubishi Electric Corporation. Contact Mitsubishi Electric Corporation for further information on configuring MELSEC devices.

Table 4.1 Open Settings Example

Parameter	Description
Protocol	UDP
Open system	Full passive
Local station port No.	1393 hex (5011)
Destination IP address	192.168.1.1
Destination port No.	1392 hex (5010)

◆ Starting Communications

Use the following procedure to read the data in the data registers in the CPU Unit of the Mitsubishi Q/A-series PLC from the hold registers in the MP3000.

- 1. Start receiving messages on the Mitsubishi Q/A-series PLC.**
The system will automatically start the message reception operation. No further operation is required.
- 2. Turn ON the power to the MP3000 to start transmitting messages.**
The ladder program example is designed to turn ON the Execute Bit (DB000200) in the message send function after six seconds has elapsed from when the low-speed scan (or high-speed scan) starts. Thereafter, the message send function is executed every second by alternating the Execute Bit (DB000200) between OFF and ON each time the message send function completes execution normally or with an error.

Note: The MP3000 will establish the TCP connection when it starts execution of the MSG-SNDE function.

SB00003A:
Turns ON 5 seconds after start.

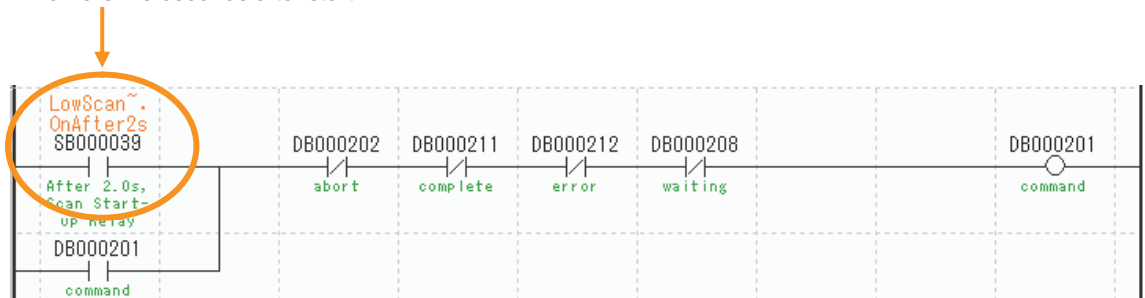

4.3.4 Message Functions

The message functions are used in user communications applications for the A-compatible 1E Frame protocol. You can send and receive message data by setting the necessary input items and parameters for the message functions. Message communications using the A-compatible 1E Frame protocol can be carried out with the same settings used for MEMOBUS messages.

Inputs and Outputs for the MSG-SNDE Function

I/O Definitions	No.	Name	I/O Designation	Meaning	Description
Input Items	1	Execute	B-VAL	Executes the transmission.	Specify the bit to use to execute the message transmission. When the Execute Bit turns ON, the message will be sent. Keep the Execute Bit ON until the Complete or Error Bit turns ON. To send another message, turn OFF the Execute Bit for at least one scan and then turn it ON again.
	2	Abort	B-VAL	Forces the transmission to end.	Specify the bit to use to abort the message transmission. When the Abort Bit turns ON, the message transmission will be stopped unconditionally. The Abort Bit takes precedence over the Execute Bit.
	3	Dev-Typ	I-REG	Communications device type	Specify the type code of the communications device. 218IFB, 218IFD = 16, 218IF = 6
	4	Pro-Typ	I-REG	Communications protocol	Specify the type code of the communications protocol. 1: MEMOBUS Select this protocol when using the A-compatible 1E Frame protocol. MEMOBUS is automatically converted to the A-compatible 1E Frame protocol inside the 218IFD. 2: No-protocol communications 1 (unit: words) Not used for the A-compatible 1E frame protocol. 3: No-protocol communications 2 (unit: bytes) Not used for the A-compatible 1E frame protocol.
	5	Cir-No	I-REG	Circuit number	Specify the circuit number for the communications device. Specify the same circuit number as displayed in the MPE720 Module Configuration Definition Tab Page. 218IFB, 218IFD = 1 to 8, 218IF = 1 to 8
	6	Ch-No	I-REG	Communications buffer channel number	Specify the channel number of the communications buffer. You can specify any channel number provided it is within the valid range. When executing more than one function at the same time, do not use the same channel number for the same connection. You can use the same channel number as long as multiple functions are not executed at the same time. 218IFB, 218IFD = 1 to 10, 218IF = 1 to 10
	7	Param	Address Inputs	Parameter list first address (MA, DA)	Specify the first address of the parameter list. A total of 29 words starting from the specified first word are automatically used for the parameter list. The parameter list is used by inputting function codes and relevant parameter data. It is also where the process results and status are output.









Continued on next page.

Continued from previous page.

I/O Definitions	No.	Name	I/O Designation	Meaning	Description
Output Items	1	Busy	B-VAL	Processing.	Specify the bit that shows that the message transmission is in progress. The Busy Bit is ON while a message transmission or abort is in progress. Keep the Execute Bit or Abort Bit turned ON while the Busy Bit is ON.
	2	Complete	B-VAL	Process completed.	Specify the bit that shows when the message transmission has been completed. The Complete Bit turns ON only for one scan when message transmission or forced abort processing has been completed normally.
	3	Error	B-VAL	Error occurred.	Specify the bit that shows if an error occurred when sending the message. When an error occurs, the Error Bit will turn ON only for one scan. Refer to the following section for an example of a timing chart for when an error occurs.  ◆ Error on page 2-8

MSG-SNDE Function Parameters

The following table describes the contents of the addresses specified by the PARAM input parameter to the MSG-SNDE function.

No.	I/O	Meaning	Description	Reference Page
00	Outputs	Processing Result	Gives the processing status.	 ◆ Processing Result (PARAM00) on page 2-9
01		Status	Gives the status of the current function.	 ◆ Status (PARAM01) on page 2-10
02		Detail Error Code, Lower Word	Gives the details of an error.	 ◆ Detail Error Code (PARAM02 and PARAM03) on page 4-73
03				
04		Status 1	Gives the communications status.	 ◆ Status 1 (PARAM04) on page 2-12
05		Status 2	Gives status information on the most recent error.	 ◆ Status 2 (PARAM05) on page 2-12
06		Status 3	Gives the information of the send pass counter.	 ◆ Status 3 (PARAM06) on page 2-12
07		Status 4	Gives the information of the receive pass counter.	 ◆ Status 4 (PARAM07) on page 2-12
08		Status 5	Gives the information of the error counter.	 ◆ Status 5 (PARAM08) on page 2-13
09	Status 6	Not used for the A-compatible 1E Frame protocol.	—	

Continued on next page.

Continued from previous page.

No.	I/O	Meaning	Description	Reference Page
10	Inputs	Connection Number	Sets the connection number used to determine the remote station.	◆ <i>Connection Number (PARAM10)</i> on page 2-13
11		Option	Not used for the A-compatible 1E Frame protocol.	—
12		Function Code	Sets the code of the function in the A-compatible 1E Frame protocol.	◆ <i>Function Code (PARAM12)</i> on page 4-73
13		Reserved for system.	This parameter is used by the system. Do not change the value of this parameter from a user program or by any other means.	◆ <i>Reserved for System (PARAM13)</i> on page 2-14
14		Remote Station Data Address, Lower Word	Sets the data address to read/write at the remote station. (Use word addresses for registers, bit addresses for relays or coils.)	◆ <i>Remote Station Data Address (PARAM14 and PARAM15)</i> on page 4-74
15		Remote Station Data Address, Upper Word		
16		Remote Station Register Type	Not used for the A-compatible 1E Frame protocol.	◆ <i>Remote Station Register Type (PARAM16)</i> on page 4-43
17		Data Size	Sets the size of the data to read/write. (Use word sizes for registers, bit sizes for relays or coils.)	◆ <i>Data Size (PARAM17)</i> on page 4-75
18		Remote CPU Module Number	Not used for the A-compatible 1E Frame protocol.	◆ <i>Remote CPU Module Number (PARAM18)</i> on page 2-17
19		Reserved for system.	This parameter is used by the system. Do not change the value of this parameter from a user program or by any other means.	◆ <i>Reserved for System (PARAM19)</i> on page 2-17
20		Local Station Data Address, Lower Word	Sets the data address to store read/write data in the local station. (Use word addresses for registers, bit addresses for relays or coils.)	◆ <i>Local Station Data Address (PARAM20 and PARAM21)</i> on page 2-18
21		Local Station Data Address, Upper Word		
22		Local Station Register Type	Sets the register type of the read/write data to store in the local station.	◆ <i>Local Station Register Type (PARAM22)</i> on page 4-76
23	Reserved for system.	This parameter is used by the system. Do not change the value of this parameter from a user program or by any other means.	◆ <i>Reserved for System (PARAM23)</i> on page 2-19	
24	—	For system use	This parameter is used by the system. It contains the channel number of the communications buffer that is currently in use. A user program must set this parameter to 0 on the first scan after startup. Thereafter, do not change the value of this parameter from a user program or by any other means because it will be used by the system.	◆ <i>Reserved for System (PARAM24)</i> on page 2-19
25		Reserved for system.	These parameters are used by the system. Do not change the value of these parameters from a user program or by any other means.	◆ <i>Reserved for System (PARAM25 to PARAM28)</i> on page 2-19
26		Reserved for system.		
27		Reserved for system.		
28		Reserved for system.		

◆ Detail Error Code (PARAM02 and PARAM03)

These parameters give the detail error code.

Processing Result Value (PARAM00)	Detail Error Code	Meaning	Description
81□□ hex	1	Function code error	An unused function code was sent or received. Check PARAM12 (Function Code).
82□□ hex	2	Address setting error	The setting of one or more of the following parameters is out of range. Check the settings. PARAM14 and PARAM15 (Remote Station Data Address) PARAM20 and PARAM21 (Local Station Data Address)
83□□ hex	3	Data size error	The data size for sending or receiving is out of range. Check PARAM17 (Data Size).
84□□ hex	4	Circuit number setting error	The circuit number is out of range. Check the circuit number (Cir-No) in the MSG-SNDE function.
85□□ hex	5	Channel number setting error	The channel number for the communications buffer is out of range. Check the communications buffer channel number (Ch-No) in the MSG-SNDE function.
86□□ hex	6	Connection number error	The connection number is out of range. Check PARAM10 (Connection Number).
88□□ hex	8	Communications device error	An error response was received from the communications device. Check the connections to the device. Also check to see if the remote device is ready to communicate.
89□□ hex	9	Device select error	A device that cannot be used was selected. Check the communications device type (Dev-Typ) in the MSG-SNDE function.
C245 hex	–	Local station register type error	The register type for the local station is out of range. Check PARAM22 (Local Station Register Type).
8072 hex to FF72 hex		Remote device error*	An error response was received from the remote station. Check the error code and remove the cause.

* An error response received from the remote device will be formatted in PARAM00 (Processing Result) as follows.
Processing Result (PARAM00): □□72 hex (where □□ is the error code)

□□ contains the sum of the completion code sent from the Mitsubishi PLC and 80 hex.

Refer to the following manual for details on completion codes.

📖 Ethernet Unit Manual from Mitsubishi Electric Corporation

◆ Function Code (PARAM12)

Set the function code to send.

You can use the functions that are registered to the function codes.

Function Code	MELSEC Common Instructions for ACPUs	Target Data Type	Function
01 or 02 hex	00 hex	B	Reads bit devices in units of one point.
03, 04, 09, or 0A hex	01 hex	W	Reads word devices in units of one point.
05 or 0F hex	02 hex	B	Writes bit devices in units of one point.
06, 0B, or 10 hex	03 hex	W	Writes word devices in units of one point.
08 hex	16 hex	–	Performs a loopback test.
0E hex	05 hex	B	Sets/resets word devices in units of one point by specifying a device number.
31 hex	60 hex	W	Writes to a fixed buffer in units of one word.
32 hex	61 hex	W	Reads from the random access buffer in units of one word.
33 hex	62 hex	W	Writes to the random access buffer in units of one word.

Note: 1. B: Bit data, W: Integer data

2. AnCPU special instructions cannot be used. Use the ACPUs common instructions to access the AnCPU. The extended file registers in the AnCPU cannot be accessed either.

◆ Remote Station Data Address (PARAM14 and PARAM15)

Set the first address for data in the remote station.

Enter the first address as a decimal or hexadecimal number.

Example If the first address is MW01000, enter “1000” (decimal) or “3E8” (hexadecimal).

The applicable function codes and valid range of data addresses depend on the device type and device range of the Mitsubishi Q/A-series PLC.

Table 4.2 Bit Device Conversion Table

Device	Common Instructions for ACPU's Device Range	Notation	Function Code	Data Address Setting Range	Corresponding Register Addresses
X	X0000 to X07FF	Hexadecimal	02 hex: Input relays	0 to 2047	MB000000 to MB00127F
Y	Y0000 to Y07FF	Hexadecimal	01 and 0F hex: Coils	0 to 2047	MB000000 to MB00127F
M	M0000 to M2047	Decimal	01, 05, and 0F hex: Coils	2048 to 4095	MB001280 to MB00255F
M	M9000 to M9255	Decimal	01, 05, and 0F hex: Coils	4096 to 4351	MB002560 to MB00271F
B	B0000 to B03FF	Hexadecimal	01, 05, and 0F hex: Coils	4352 to 5375	MB002720 to MB00335F
F	F0000 to F0255	Decimal	01, 05, and 0F hex: Coils	5376 to 5631	MB003360 to MB00351F
TS	TS000 to TS255	Decimal	02 hex: Input relays	2048 to 2303	MB001280 to MB00143F
TC	TC000 to TC255	Decimal	02 hex: Input relays	2304 to 2559	MB001440 to MB00159F
CS	CS000 to CS255	Decimal	02 hex: Input relays	2560 to 2815	MB001660 to MB00175F
CC	CC000 to CC255	Decimal	02 hex: Input relays	2816 to 3071	MB001760 to MB00191F
M	M2048 to M8191	Decimal	01, 05, and 0F hex: Coils	8192 to 14335	MB005120 to MB00895F

Table 4.3 Word Device Conversion Table

Device	Common Instructions for ACPU's Device Range	Notation	Function Code	Data Address Setting Range	Corresponding Register Addresses
TN	TN000 to TN255	Decimal	04 and 0A hex: Input registers	0 to 255	MW00000 to MW00255
CN	CN000 to CN255	Decimal	04 and 0A hex: Input registers	256 to 511	MW00256 to MW00511
D	D0000 to D1023	Decimal	03, 06, 09, 0B, 0E, and 10 hex: Hold registers	0 to 1023	MW00000 to MW01023
D (Special)	D9000 to D9255	Decimal	03, 06, 09, 0B, 0E, and 10 hex: Hold registers	1024 to 1279	MW01024 to MW01279
W	W0000 to W03FF	Hexadecimal	03, 06, 09, 0B, 0E, and 10 hex: Hold registers	1280 to 2303	MW01280 to MW02303
R	R0000 to R8191	Decimal	03, 06, 09, 0B, 0E, and 10 hex: Hold registers	2304 to 10495	MW02304 to MW10495
D	D1024 to D6143	Decimal	03, 06, 09, 0B, 0E, and 10 hex: Hold registers	10496 to 15615	MW10496 to MW15615

Note: 1. Even if addresses are within the given device range, they may exceed the range of the device area depending on the model of the Mitsubishi Q/A-series PLC.

Refer to the following manual for details.

 Programmable Controller Manual from Mitsubishi Electric Corporation

2. The corresponding register address in the MP3000 can be adjusted by using the offset setting of the MSG-SNDE function.

◆ Data Size (PARAM17)

Set the data size for the read/write request as the number of bits or words.

Be sure that the last data address that is determined by the offset, data address, and data size does not exceed the valid data address range.

The range that is allowed for the data size depends on the function code and data area.

Function Code	MELSEC Common Instructions for ACPUs	Function	Data size Setting Range
01 or 02 hex	00 hex	Reads bit devices in units of one point.	1 to 256 points
03, 04, 09, or 0A hex	01 hex	Reads word devices in units of one point.	1 to 256 points
05 or 0F hex	02 hex	Writes bit devices in units of one point.	1 to 256 points
06, 0B, or 10 hex	03 hex	Writes word devices in units of one point.	1 to 256 points
08 hex	16 hex	Performs a loopback test.	–
0E hex	05 hex	Sets/resets word devices in units of one point by specifying a device number.	1 to 40 points
31 hex	60 hex	Writes to a fixed buffer in units of one word.	See the following table.
32 hex	61 hex	Reads from the random access buffer in units of one word.	
33 hex	62 hex	Writes to the random access buffer in units of one word.	

■ For the 218IFB and 218IFD

Function	Connect Type	Code	Data Size Setting Range
Writes to a fixed buffer in units of one word.	TCP	BIN	1 to 727 words
		ASCII	1 to 362 words
	UDP	BIN	1 to 1017 words
		ASCII	1 to 508 words
Reads from the random access buffer in units of one word.	TCP	BIN	1 to 728 words
		ASCII	1 to 363 words
	UDP	BIN	1 to 1017 words
		ASCII	1 to 508 words
Writes to the random access buffer in units of one word.	TCP	BIN	1 to 726 words
		ASCII	1 to 361 words
	UDP	BIN	1 to 1017 words
		ASCII	1 to 508 words

Note: When communicating with TCP, the data size limit is the maximum size of data that can be sent in a single segment.

A segment is the unit for data transfer in TCP and is determined by the MTU (maximum transfer unit). The data size setting ranges given above are for an MTU of 1,500 bytes.

■ For the 218IF

Function	Connection Type	Code	Data Size Setting Range
Fixed	TCP	BIN	1 to 507 words
		ASCII	1 to 362 words
	UDP	BIN	1 to 507 words
		ASCII	1 to 507 words
Random read	TCP	BIN	1 to 508 words
		ASCII	1 to 363 words
	UDP	BIN	1 to 508 words
		ASCII	1 to 508 words
Random write	TCP	BIN	1 to 507 words
		ASCII	1 to 361 words
	UDP	BIN	1 to 507 words
		ASCII	1 to 507 words

◆ Local Station Register Type (PARAM22)

Set the register type of the read data destination or write data source in the MP3000.

Register Type Value	Type	Remarks
0	M	Sets the target data type to MB for bits and MW for words.
1	G	Sets the target data type to GB for bits and GW for words.
2	I	Sets the target data type to IB for bits and IW for words.
3	O	Sets the target data type to OB for bits and OW for words.
4	S	Sets the target data type to SB for bits and SW for words.
5 or higher	–	Not used for the A-compatible 1E Frame protocol.

The register types that can be used depend on whether you are reading or writing.

The following table lists the combinations of register types.

Function Code	Applicable Register Types
01, 02, 03, 04, 09, 0A, or 32 hex	M, G, or O
05, 06, 0B, 0F, 10, 31, or 33 hex	M, G, I, O, or S
0E hex	M

Inputs and Outputs for the MSG-RCVE Function

I/O Definitions	No.	Name	I/O Designation	Meaning	Description
Input Items	1	Execute	B-VAL	Executes the transmission.	Specify the bit to use to execute the message transmission. When the Execute Bit turns ON, the message will be sent. Keep the Execute Bit ON until the Complete or Error Bit turns ON. To send another message, turn OFF the Execute Bit for at least one scan and then turn it ON again.
	2	Abort	B-VAL	Forces the transmission to end.	Specify the bit to use to abort the message transmission. When the Abort Bit turns ON, the message transmission will be stopped unconditionally. The Abort Bit takes precedence over the Execute Bit.
	3	Dev-Typ	I-REG	Communications device type	Specify the type code of the communications device. 218IFB, 218IFD = 16, 218IF = 6
	4	Pro-Typ	I-REG	Communications protocol	Specify the type code of the communications protocol. 1: MEMOBUS Select this protocol when using the A-compatible 1E Frame protocol. MEMOBUS is automatically converted to the A-compatible 1E Frame protocol inside the 218IFD. 2: No-protocol communications 1 (unit: words) Not used for the A-compatible 1E frame protocol. 3: No-protocol communications 2 (unit: bytes) Not used for the A-compatible 1E frame protocol.
	5	Cir-No	I-REG	Circuit number	Specify the circuit number for the communications device. Specify the same circuit number as displayed in the MPE720 Module Configuration Definition Tab Page. 218IFB, 218IFD, 218IF = 1 to 8
	6	Ch-No	I-REG	Communications buffer channel number	Specify the channel number of the communications buffer. You can specify any channel number provided it is within the valid range. When executing more than one function at the same time, do not use the same channel number for the same connection. You can use the same channel number as long as multiple functions are not executed at the same time. 218IFB, 218IFD, 218IF = 1 to 10
	7	Param	Address Inputs	Parameter list first address (MA, DA)	Specify the first address of the parameter list. A total of 52 words starting from the specified first word are automatically used for the parameter list. The parameter list is used by inputting function codes and relevant parameter data. It is also where the process results and status are output.











Continued on next page.

Continued from previous page.

I/O Definitions	No.	Name	I/O Designation	Meaning	Description
Output Items	1	Busy	B-VAL	Processing.	Specify the bit that shows that the message transmission is in progress. The Busy Bit is ON while a message transmission or abort is in progress. Keep the Execute Bit or Abort Bit turned ON while the Busy Bit is ON.
	2	Complete	B-VAL	Process completed.	Specify the bit that shows when the message transmission has been completed. The Complete Bit turns ON only for one scan when message transmission or forced abort processing has been completed normally.
	3	Error	B-VAL	Error occurred.	Specify the bit that shows if an error occurred when sending the message. When an error occurs, the Error Bit will turn ON only for one scan. Refer to the following section for an example of a timing chart for when an error occurs.  ◆ Error on page 2-23









MSG-RCVE Function Parameters

The following table describes the contents of the addresses specified by the PARAM input parameter to the MSG-RCVE function.

No.	I/O	Meaning	Description	Reference Page
00	Out-puts	Processing Result	Gives the processing status.	 ◆ Processing Result (PARAM00) on page 2-25
01		Status	Gives the status of the current function.	 ◆ Status (PARAM01) on page 2-25
02		Detail Error Code, Lower Word	Gives the details of an error.	 ◆ Detail Error Code (PARAM02 and PARAM03) on page 4-81
03				
04		Status 1	Gives the communications status.	 ◆ Status 1 (PARAM04) on page 2-27
05		Status 2	Gives status information on the most recent error.	 ◆ Status 2 (PARAM05) on page 2-28
06		Status 3	Gives the information of the send pass counter.	 ◆ Status 3 (PARAM06) on page 2-28
07		Status 4	Gives the information of the receive pass counter.	 ◆ Status 4 (PARAM07) on page 2-28
08		Status 5	Gives the information of the error counter.	 ◆ Status 5 (PARAM08) on page 2-28
09	Status 6	Not used for the A-compatible 1E Frame protocol.	—	
10	Input	Connection Number	Sets the connection number used to determine the remote station.	 ◆ Connection Number (PARAM10) on page 2-29
11	I/O	Option	Not used for the A-compatible 1E Frame protocol.	—
12	Output	Function Code	Gives the function code requested by the remote station.	 ◆ Function Code (PARAM12) on page 4-81
13	I/O	Reserved for system.	This parameter is used by the system. Do not change the value of this parameter from a user program or by any other means.	 ◆ Reserved for System (PARAM13) on page 2-30

Continued on next page.

Continued from previous page.



No.	I/O	Meaning	Description	Reference Page
14	Out-puts	Data Address, Lower Word	Gives the first address of the data that was requested by the remote station.	 ◆ <i>Data Address (PARAM14 and PARAM15) on page 2-30</i>
15		Data Address, Upper Word		
16		Register Types	Not used for the A-compatible 1E Frame protocol.	–
17		Data Size	Gives the data size that was requested by the remote station.	 ◆ <i>Data Size (PARAM17) on page 2-31</i>
18		Remote CPU Module Number	Not used for the A-compatible 1E Frame protocol.	–
19	I/O	Reserved for system.	This parameter is used by the system. Do not change the value of this parameter from a user program or by any other means.	 ◆ <i>Reserved for System (PARAM19) on page 2-31</i>
20	Inputs	Coil Offset, Lower Word	Sets the offset word address for a coil (MB).	 ◆ <i>Offsets (PARAM20 to PARAM27) on page 4-82</i>
21		Coil Offset, Upper Word		
22		Input Relay Offset, Lower Word	Sets the offset word address for an input relay (IB).	 ◆ <i>Offsets (PARAM20 to PARAM27) on page 4-82</i>
23		Input Relay Offset, Upper Word		
24		Input Register Offset, Lower Word	Sets the offset word address for an input register (IW).	 ◆ <i>Offsets (PARAM20 to PARAM27) on page 4-82</i>
25		Input Register Offset, Upper Word		
26		Hold Register Offset, Lower Word	Sets the offset word address for a hold register (MW).	 ◆ <i>Offsets (PARAM20 to PARAM27) on page 4-82</i>
27		Hold Register Offset, Upper Word		
28		Data Relay Offset, Lower Word	Not used for the A-compatible 1E Frame protocol.	–
29		Data Relay Offset, Upper Word		
30		Data Register Offset, Lower Word	Not used for the A-compatible 1E Frame protocol.	–
31		Data Register Offset, Upper Word		
32		Output Coil Offset, Lower Word	Not used for the A-compatible 1E Frame protocol.	–
33		Output Coil Offset, Upper Word		
34		Output Register Offset, Lower Word	Not used for the A-compatible 1E Frame protocol.	–
35		Output Register Offset, Upper Word		
36		M Register Writing Range LO, Lower Word	Sets the first address of the writing range for hold register coils.	 ◆ <i>M Register Writing Range (PARAM36 to PARAM39) on page 4-83</i>
37		M Register Writing Range LO, Upper Word		
38		M register Writing Range HI, Lower Word	Sets the last address of the writing range for hold register coils.	 ◆ <i>M Register Writing Range (PARAM36 to PARAM39) on page 4-83</i>
39	M Register Writing Range HI, Upper Word			

Continued on next page.

4.3 Communications with a Mitsubishi PLC (A-compatible 1E Frame Protocol)

4.3.4 Message Functions

Continued from previous page.

No.	I/O	Meaning	Description	Reference Page
40	Inputs	G register Writing Range LO, Lower Word	Not used for the A-compatible 1E Frame protocol.	-
41		G Register Writing Range LO, Upper Word		
42		G Register Writing Range HI, Lower Word	Not used for the A-compatible 1E Frame protocol.	-
43		G Register Writing Range HI, Upper Word		
44		O Register Writing Range LO, Lower Word	Not used for the A-compatible 1E Frame protocol.	-
45		O Register Writing Range LO, Upper Word		
46		O Register Writing Range HI, Lower Word	Not used for the A-compatible 1E Frame protocol.	-
47		O Register Writing Range HI, Upper Word		
48	-	For system use	This parameter contains the channel number of the communications buffer that is currently in use. A user program must set this parameter to 0 on the first scan after startup. Thereafter, do not change the value of this parameter from a user program or by any other means because it will be used by the system.	 ◆ For System Use (PARAM48) on page 2-34
49	-	Reserved for system.	These parameters are used by the system. Do not change the value of these parameters from a user program or by any other means.	 ◆ Reserved for System (PARAM49 to PARAM51) on page 2-34
50	-	Reserved for system.		
51	-	Reserved for system.		

◆ Detail Error Code (PARAM02 and PARAM03)

These parameters give the detail error code.

Processing Result Value (PARAM00)	Detail Error Code	Error Description	Description
81□□ hex	1	Function code error	An unused function code was received. Check the function code of the remote station.
82□□ hex	2	Address setting error	The setting of one or more of the following parameters is out of range. Check the settings. PARAM14 and PARAM15 (Data Address) PARAM20 and PARAM21 (Coil Offset) PARAM26 and PARAM27 (Hold Register Offset)
83□□ hex	3	Data size error	The data size for receiving is out of range. Check the data size at the remote station.
84□□ hex	4	Circuit number setting error	The circuit number is out of range. Check the circuit number (Cir-No) in the MSG-RCVE function.
85□□ hex	5	Channel number setting error	The channel number for the communications buffer is out of range. Check the communications buffer channel number (Ch-No) in the MSG-RCVE function.
86□□ hex	6	Connection number error	The connection number is out of range. Check PARAM10 (Connection Number).
88□□ hex	8	Communications device error	An error response was received from the communications device. Check the connections to the device. Also check to see if the remote device is ready to communicate.
89□□ hex	9	Device select error	A device that cannot be used was selected. Check the communications device type (Dev-Typ) in the MSG-RCVE function.

◆ Function Code (PARAM12)

This parameter gives the function code that was received.

Function Code	MELSEC Common Instructions for ACPUs	Target Data Type	Function
01 or 02 hex	00 hex	B	Reads bit devices in units of one point.
03, 04, 09, or 0A hex	01 hex	W	Reads word devices in units of one point.
05 or 0F hex	02 hex	B	Writes bit devices in units of one point.
06, 0B, or 10 hex	03 hex	W	Writes word devices in units of one point.
08 hex	16 hex	–	Performs a loopback test.
0E hex	05 hex	B	Sets/resets word devices in units of one point by specifying a device number.
31 hex	60 hex	W	Writes to a fixed buffer in units of one word.
32 hex	61 hex	W	Reads from the random access buffer in units of one word.
33 hex	62 hex	W	Writes to the random access buffer in units of one word.

Note: 1. B: Bit data, W: Integer data

2. AnCPU special instructions cannot be used. Use the ACPUs common instructions to access the AnCPU. The extended file registers in the AnCPU cannot be accessed either.

◆ Offsets (PARAM20 to PARAM27)

Set the offset for the data address in the MP3000.

The MP3000 will offset the address by the number of words specified by the offset.

Note: An offset cannot be a negative value.

Offset parameters are provided for each of the target register types.

The following table lists the offset parameters.

Parameters	Meaning	Description
PARAM20 and 21	Coil Offset	Sets the offset to the word address for a coil.
PARAM22 and 23	Input Relay Offset	Sets the offset to the word address for an input relay.
PARAM24 and 25	Input Register Offset	Sets the offset to the word address for an input register.
PARAM26 and 27	Hold Register Offset	Sets the offset to the word address for a hold register.

The offset parameters that can be used depend on the function code.

The following table lists the valid parameters for each function code.

Function Code	Function	Applicable Offset Parameters
01 hex	Reads the states of coils.	PARAM20 and 21
02 hex	Reads the states of input relays.	PARAM22 and 23
03 hex	Reads the contents of hold registers.	PARAM26 and 27
04 hex	Reads the contents of input registers.	PARAM24 and 25
05 hex	Changes the state of a single coil.	PARAM20 and 21
06 hex	Writes to a single hold register.	PARAM26 and 27
09 hex	Reads the contents of hold registers (extended).	PARAM26 and 27
0A hex	Reads the contents of input registers (extended).	PARAM24 and 25
0B hex	Writes to hold registers (extended).	PARAM26 and 27
0D hex	Reads the contents of non-consecutive hold registers (extended).	PARAM26 and 27
0E hex	Writes the contents of non-consecutive hold registers (extended).	PARAM26 and 27
0F hex	Changes the states of multiple coils.	PARAM20 and 21
10 hex	Writes to multiple hold registers.	PARAM26 and 27
31 hex	Writes to the fixed buffer.	PARAM26 and 27
32 hex	Reads from the random access buffer.	Cannot be received.
33 hex	Writes to the random access buffer.	PARAM26 and 27

◆ M Register Writing Range (PARAM36 to PARAM39)

Set the allowable address range for write requests from the remote station. An error will occur if the write request is outside this allowable range.

Specify the M Register Writing Range (PARAM36 to PARAM39) with word addresses.

Note: 1. M registers are always used as the destination in the MP3000 for data write requests from the remote station.

2. The writing range parameters allow you to specify the range of M registers that messages are allowed to write to.

The following table lists the writing range parameters.

Parameters	Meaning	Description
PARAM36 and 37	M Register Writing Range LO	First address of the writing range
PARAM38 and 39	M Register Writing Range HI	Last address of the writing range

Set the writing range so that it satisfies the following condition:

$$0 \leq \text{M register writing range LO} \leq \text{M register writing range HI} \leq \text{Maximum M register address}$$

The writing range applies when using the following function codes.

05 hex: Changes the state of a single coil.

06 hex: Writes to a single hold register.

0B hex: Writes to hold registers (extended).

0E hex: Writes to non-consecutive hold registers (extended).

0F hex: Changes the states of multiple coils.

10 hex: Writes to multiple hold registers.

31 hex: Writes to the fixed buffer.

33 hex: Writes to the random access buffer.

Example Use the following settings to set the allowable writing range of M register addresses to MW0001000 to MW0001999:

```
PARAM36 = 03E8 hex (1000)
PARAM37 = 0000 hex (0000)
PARAM38 = 07CF hex (1999)
PARAM39 = 0000 hex (0000)
```

The MP3000 will return an error if a write request is received for addresses outside the range from MW01000 to MW01999, and will not perform the writing operation.

4.4 Communications with a Mitsubishi PLC (QnA-compatible 3E Frame Protocol)

When using Ethernet communications between the MP3000 and a Mitsubishi Q/QnA-series PLC, use the MC protocol (QnA-compatible 3E Frame protocol) as the communications protocol. The QnA-compatible 3E Frame protocol allows the master to read and write the contents of slave registers.

This section describes communications when the MP3000 acts as the master. When the MP3000 acts as the master, communications can take place using I/O message communications or the MSG-SNDE function.

The communications modules which can perform communications with a Mitsubishi Q/QnA-series PLC are 218IFD and 218IFB.

4.4.1 Using I/O Message Communications with the MP3000 as the Master

This section describes how to perform communications with a Mitsubishi Q/QnA-series PLC by using I/O message communications.

QnA-compatible 3E Frame Commands

The commands that are used with I/O message communications on the MP3000 are given below.

Function	QnA-compatible 3E Frame (Hex)		Meaning
	Command	Subcommand	
Batch read from the device memory	0401	0000	Reads bit devices in units of 16 points.
			Reads word devices in units of one point.
Batch write to the device memory	1401	0000	Writes bit devices in units of 16 points.
			Writes word devices in units of one point.

Device Memory and Corresponding Registers in the MP3000

The following tables show the relationship between registers in the MP3000 and device memory in the Mitsubishi Q/QnA-series PLC. Use device addresses within the ranges listed in the tables below according to the conditions of the Mitsubishi Q/QnA-series PLC slave.

When reading data from or writing data to the I/O memory in the Mitsubishi Q/QnA-series PLC, the read or write commands are automatically generated by assigning I/O registers to the MP3000.

- **Reading**

Set the input registers in the MP3000 as follows:

- Set the first address of the IW registers and the size of the read data that is to be stored in the MP3000.
- Set the address of the first register of the device memory to read from in the remote device.

- **Writing**

Set the output register in the MP3000 as follows:

- Set the first address of the OW registers and the size of the data in the MP3000 to be written to the I/O memory in the Mitsubishi Q/QnA-series PLC.
- Set the first register address in the remote device of the device memory to be written to.

Table 4.4 Bit Device Conversion Table

Device Name	Data Range		
	Notation	Mitsubishi PLC	MP3000
Input Relays	Hexadecimal	X000000 to X001FFF	Read: IW0000 to IW7FFF hex Write: OW0000 to OW7FFF hex
Output Relays	Hexadecimal	Y000000 to Y001FFF	
Internal Relays	Decimal	M000000 to M008191	
Latch Relays	Decimal	L000000 to L008191	
Step Relays	Decimal	S000000 to S008191	
Link Relays	Hexadecimal	B000000 to B001FFF	
Link Special Relays	Decimal	SM000000 to SM002047	

Table 4.5 Word Device Conversion Table

Device Name	Data Range		
	Notation	Mitsubishi PLC	MP3000
Data Registers	Decimal	D000000 to D012287	Read: IW0000 to IW7FFF hex Write: OW0000 to OW7FFF hex
Link Registers	Hexadecimal	W000000 to W001FFF	
Link Special Registers	Decimal	SD000000 to SD002047	
File Registers	Hexadecimal	ZR000000 to ZR007FFF*	

* Access file registers by using the notation for accessing continuous file registers: ZR for ASCII data and B0 hex for binary data. The normal access notation (R* for ASCII data and AF hex for binary data) cannot be used.

Transfer Size

The following table lists the size of data that can be transferred using I/O message communications. Use the data size within the ranges listed in the following table according to the conditions of the Mitsubishi Q/QnA-series PLC slave.

QnA-compatible 3E Frame (Hex)		Meaning	Data Size
Command	Subcommand		
0401	0000	Reads bit devices in units of 16 points.	16 to 4096 points (256 words)
		Reads word devices in units of one point.	1 to 256 points
1401	0000	Writes bit devices in units of 16 points.	16 to 4096 points (256 words)
		Writes word devices in units of one point.	1 to 256 points

Setting Example

The following figure illustrates how the contents of the D02000 to D02099 data (D) registers in the CPU Unit of Mitsubishi Q/QnA-series PLC slave are read into the IW0100 to IW0163 input registers in the MP3000 master.

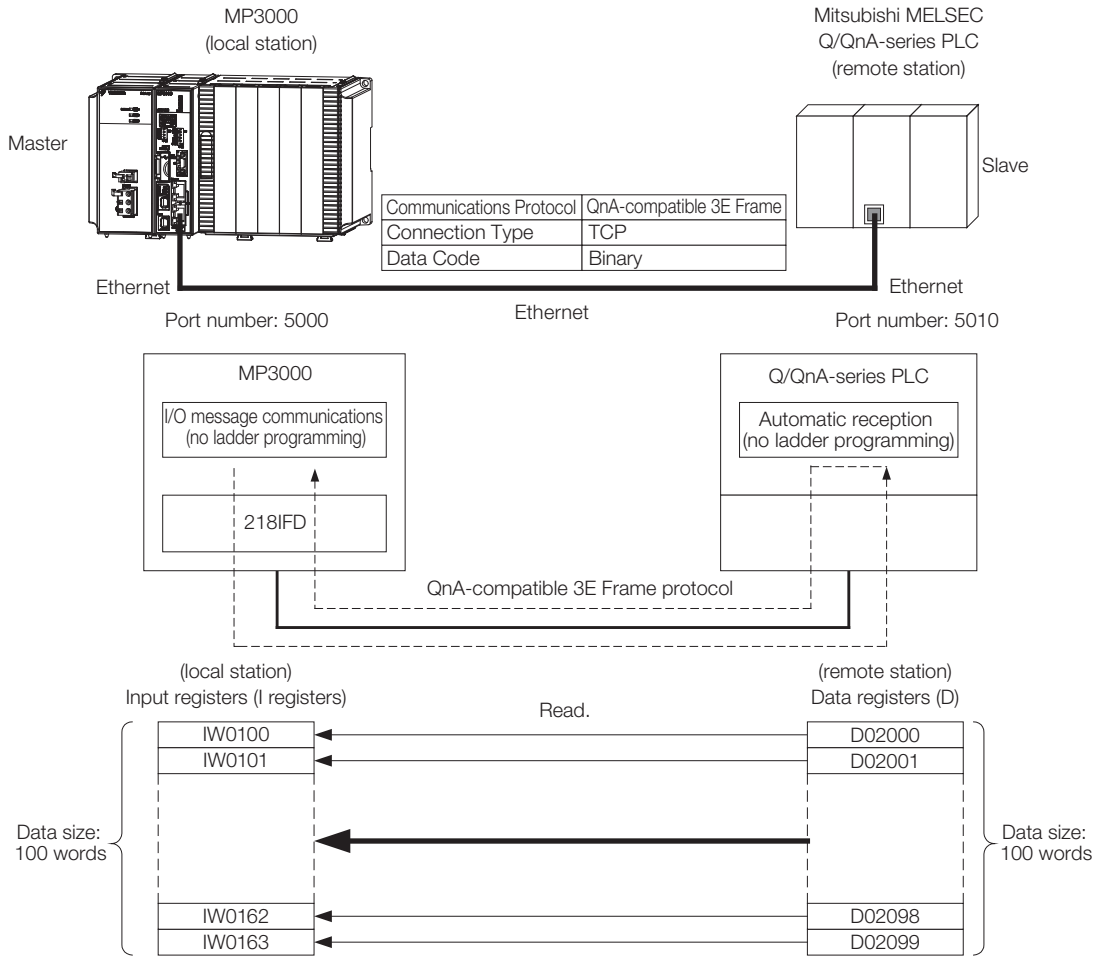

◆ MP3000 Setup

Use the following procedure to set up the MP3000.

Information If the communications parameters (IP address and subnet mask) have already been set, skip to step 3.

1. Double-click the cell for 218IFD in the Module Configuration Definition Tab Page.

Module	Function Module/Slave	Status	Circuit No./Axis Address		Motion Register	Register(Input/Output)		
			Start	cupied circ.		Disabled	Start - End	Size
01 [CPU-302(32axes)] : ---								
800-NEW I/O	01 CPU	---						
	02 218IFD	---	□	Circuit No1	1		Input Output	0000 - 07FF[H] 2048
	03 SVC32	---	□	Circuit No1	1	8000 - 87FF[H]	Input Output	0800 - 0BFF[H] 1024
	04 SVR32	---	□	Circuit No3	1	9000 - 97FF[H]		
	05 M-EXECUTOR	---						0C00 - 0C3F[H] 64
06 -- UNDEFINED --								
07 -- UNDEFINED --								
01 -- UNDEFINED -- [-----]								
02 -- UNDEFINED -- [-----]								
03 -- UNDEFINED --								
02 -- UNDEFINED --								
02 -- UNDEFINED --								
03 -- UNDEFINED --								
04 -- UNDEFINED --								

The 218IFD Detail Definition Dialog Box will be displayed.

2. Set the communications parameters.

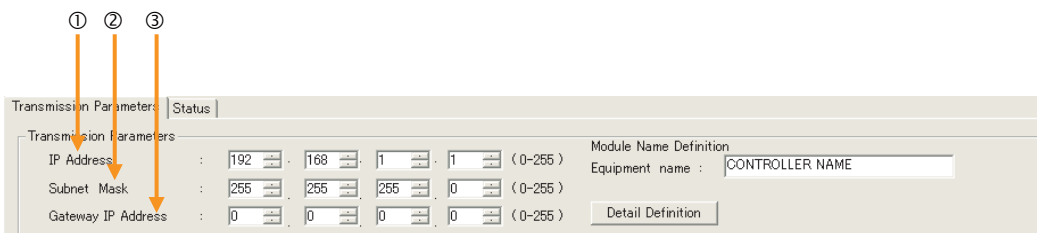

- ① In the [IP Address] Boxes, enter the following address: 192.168.001.001.
- ② In the [Subnet Mask] Boxes, enter the following mask: 255.255.255.000.
- ③ In the [Gateway IP Address] Boxes, enter the following address: 000.000.000.000.

3. Select the [Enable] Option in the [I/O Message Communication] Area of the [Connection Parameter] Area.

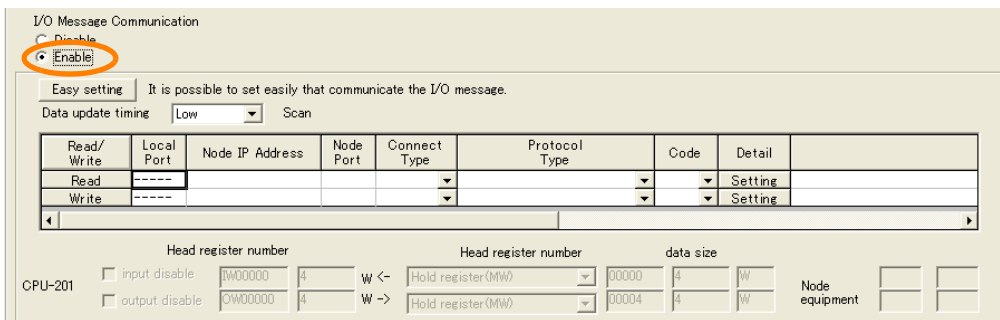

4. Set the connection parameters.

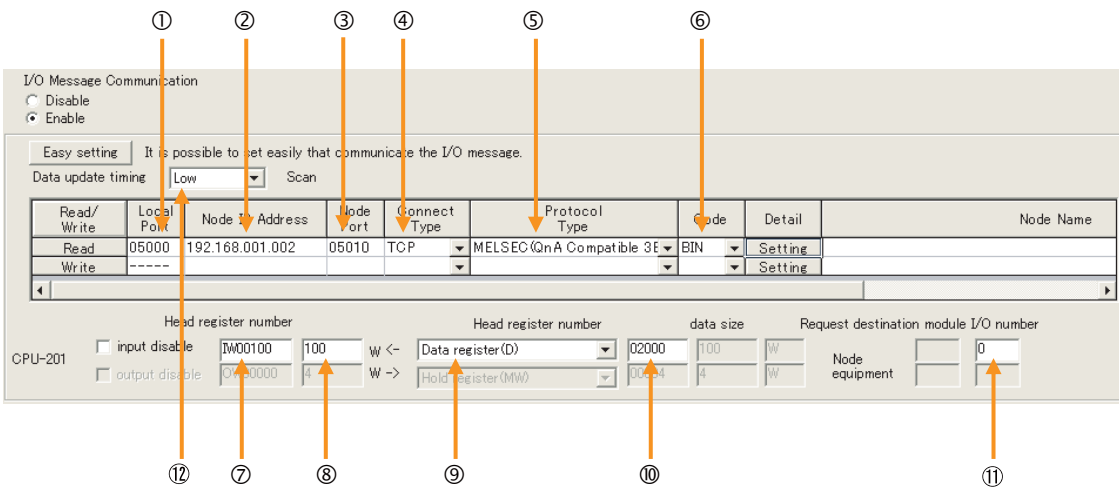

- ① Enter "5000" in the [Local Port] Box.
- ② Enter the following address for the remote device in the [Node IP Address] Box: 192.168.001.002.
- ③ Enter "5010" in the [remote device Node Port] Box.
- ④ Select [TCP] in the [Connect Type] Box.
- ⑤ Select [MELSEC (QnA-compatible 3E)] in the [Protocol Type] Box.
- ⑥ Select [BIN] in the [Code] Box.
- ⑦ Enter "IW0100" in the [Head register number] Box as the read data destination.
- ⑧ Enter "100" in the next box as the size of data to read.
- ⑨ Select [Data register (D)] as the device type in the [Head register number] box.
- ⑩ Enter "02000" as the first address in the remote device.

4.4.1 Using I/O Message Communications with the MP3000 as the Master

- ① Enter "0" in the [Request destination module I/O number] Box for the remote device. The values and meanings of the request destination Module I/O number setting are listed below.

Request Destination Module I/O Number in I/O Message Communications	Request Destination Module I/O Number for Transmission to a Mitsubishi PLC	
	Module I/O Number	Meaning
0	03FF hex	Local station CPU, control CPU, and own system CPU
1	03D0 hex	Control system CPU
2	03D1 hex	Standby system CPU
3	03D2 hex	System A CPU
4	03D3 hex	System B CPU
5	03E0 hex	Multi-CPU No. 1
6	03E1 hex	Multi-CPU No. 2
7	03E2 hex	Multi-CPU No. 3
8	03E3 hex	Multi-CPU No. 4

- ② Select [Low] in the [Data update timing] Box as the timing to update I/O data between the CPU Function Module and 218IFD.

Note: The data update timing is the timing at which the CPU Function Module and 218IFD exchange data. Communications with the remote device are performed asynchronously. The data update timing therefore does not necessarily mean that the messages are sent to the remote device.

Note: In I/O message communications, a message is transmitted from separate ports if registers are both read and written. Therefore, the connected remote device must have two connections to receive both messages.

5. Save the data to flash memory.

Note: Changes made to the communications or connection parameters will become effective only after the changes have been saved to flash memory and the power supply has been cycled.

This concludes the settings for using the MP3000 as the master.

◆ Setting Up the Remote Device (Mitsubishi Q/QnA-series PLC)

Use the following procedure to set up the Mitsubishi Q/QnA-series PLC (MELSEC device).

Information MELSEC devices are manufactured by Mitsubishi Electric Corporation. Contact Mitsubishi Electric Corporation for further information on MELSEC devices.

1. Start GX Developer.
2. Create a project.
3. Set the MELSECNET/Ethernet network parameters.

Parameter	Description
Network type	Ethernet
Starting I/O No.	As required.
Network No.	As required.
Group No.	As required.
Station No.	As required.
Mode	Online

4. Set the Ethernet operation settings.

Parameter	Description
Communications data code	Binary code
Initial timing	Always wait for OPEN
IP address	192.168.001.002
Send frame setting	Ethernet (V2.0)
TCP existence confirmation setting	As required.
Enable Write at RUN time	Enable

5. Specify the open settings.

Table 4.6 Open Settings Example

Parameter	Description
Protocol	TCP
Open system	Full passive
Fixed buffer	As required.
Fixed buffer communication	As required.
Pairing open	As required.
Existence confirmation	As required.
Local station port No.	1392 hex (5010)
Destination IP address	192.168.1.1
Destination port No.	1388 hex (5000)

Table 4.7 Setting Example to Open the Built-in Ethernet Port in a MELSEC Device

Parameter	Description
Protocol	TCP
Open system	MC protocol
TCP connection	–
Local station port No.	1392 hex (5010)
Destination IP address	–
Destination port No.	–

Note: Specify an IP address that is not in use by any other device on the same network. Check with your network administrator for unused IP addresses.

This concludes the setup. Set any other parameters as necessary, then transfer the data to the PLC.

Information

Set the initial settings and router relay parameters as necessary.

- Initial Settings
These settings apply to the timers when TCP is the selected protocol. In most cases, accept the default. Set these settings only when necessary, for example, to shorten the time set for the TCP resend timer.
- Router Relay Parameters
Set these parameters if you are using a subnet mask pattern or default gateway.

◆ Starting Communications

Use the following procedure to write the data in the data registers in the Mitsubishi Q/QnA-series PLC to the input registers in the MP3000.

1. Start receiving messages on the Mitsubishi Q/QnA-series PLC.

The system will automatically start the message reception operation. No further operation is required.

2. Turn ON the power to the MP3000 to start transmitting messages.

The system will automatically start the message transmission operation. No further operation is required.

Note: The MP3000 will establish the TCP connection when it starts execution of I/O message communications.

4.4.2 Using the MSG-SNDE Function with the MP3000 as the Master

This section describes how to communicate with a Mitsubishi Q/QnA-series PLC by using the MSG-SNDE function in the MP3000.

QnA-compatible 3E Frame Commands

The commands that are used with the MSG-SNDE function are listed below.

Function	QnA-compatible 3E Frame (Hex)		Meaning
	Command	Subcommand	
Batch read from the device memory	0401	0001	Reads bit devices in units of one point.
	0401	0000	Reads word devices in units of one point.
Batch write to the device memory	1401	0001	Writes bit devices in units of one point.
	1401	0000	Writes word devices in units of one point.
Random read from the device memory	0403	0000	Reads word devices in units of one point.
Random write to the device memory	1402	0000	Writes word devices in units of one point.

Device Memory and Corresponding Registers in the MP3000

The following tables show the relationship between registers in the MP3000 and device memory in the Mitsubishi Q/QnA-series PLC. Use device addresses within the ranges listed in the tables below according to the conditions of the Mitsubishi Q/QnA-series PLC slave.

A read or write command is automatically generated by specifying the address in the MP3000 that corresponds to the device to be read from or written to in the Mitsubishi Q/QnA-series PLC.

To read data from or write data to the address specified in PARAM14 and PARAM15 of the MSG-SNDE function, specify the register address in the MP3000 that corresponds to the device address in the Mitsubishi Q/QnA-series PLC. Select whether to read or write by setting the function code in parameter PARAM12 for the MSG-SNDE function.

Example

Writing Data into D10000

Set PARAM14 and PARAM15 to the MW10000 register in the MP3000 that corresponds to D10000, and set PARAM12 to 0B or 10 hex.

Example

Reading Data from M001000

Set PARAM14 and PARAM15 to the MB005748 register in the MP3000 that corresponds to M001000, and set PARAM12 to 01 hex.

Note: To access a relay, specify a bit address in PARAM14 and PARAM15. For MB005748, this would be 9192 decimal.

Table 4.8 Bit Device Conversion Table

Device Name	Data Range		
	Notation	Mitsubishi PLC	MP3000
Input Relays	Hexadecimal	X000000 to X001FFF	MB000000 to MB00511F
Output Relays	Hexadecimal	Y000000 to Y001FFF	MB000000 to MB00511F
Internal Relays	Decimal	M000000 to M008191	MB005120 to MB01023F
Latch Relays	Decimal	L000000 to L008191	MB010240 to MB01535F
Step Relays	Decimal	S000000 to S008191	MB015360 to MB02047F
Link Relays	Hexadecimal	B000000 to B001FFF	MB020480 to MB02559F
Annunciators	Decimal	F000000 to F002047	MB025600 to MB02687F
Link Special Relays	Decimal	SM000000 to SM002047	MB026880 to MB02815F
Timer Contacts	Decimal	TS000000 to TS002047	MB005120 to MB00639F
Timer Coils	Decimal	TC000000 to TC002047	MB006400 to MB00767F
Counter Contacts	Decimal	CS000000 to CS001023	MB007680 to MB00831F
Counter Coils	Decimal	CC000000 to CC001023	MB008320 to MB00895F

Table 4.9 Word Device Conversion Table

Device Name	Data Range		
	Notation	Mitsubishi PLC	MP3000
Data Registers	Decimal	D000000 to D012287	MW000000 to MW12287
Link Registers	Hexadecimal	W000000 to W001FFF	MW12288 to MW20479
Link Special Registers	Decimal	SD000000 to SD002047	MW20480 to MW22527
File Registers	Hexadecimal	ZR000000 to ZR007FFF*	MW22528 to MW55295
Timer Registers	Decimal	TN000000 to TN002047	MW000000 to MW02047
Counter Registers	Decimal	CN000000 to CN001023	MW02048 to MW03071

* Access file registers by using the ZR notation for accessing continuous file registers. The R* notation cannot be used.

The following map, based on bit and word device conversion tables, shows how M registers in the MP3000 correspond to devices in the Mitsubishi Q/QnA-series PLCs. All devices in a Mitsubishi Q/QnA-series PLC are assigned to hold registers, input registers, input relays, and coils so that the MP3000 can read and write to them by using MEMOBUS commands as an interface. Data read from a device in the Mitsubishi Q/QnA-series PLC is stored in the corresponding M register in the map. The data that is written to the device in the Mitsubishi Q/QnA-series PLC is sent by forming a message that contains the contents of the corresponding M register in the map.

4.4 Communications with a Mitsubishi PLC (QnA-compatible 3E Frame Protocol)

4.4.2 Using the MSG-SNDE Function with the MP3000 as the Master

M Register Data Address	Hold Registers F 0	Input Registers F 0	Input Relays F 0	Coils F 0
00000			Input relays: X	Output relays: Y
00511 00512			Timer contacts: TS	Internal relays: M
00639 00640			Timer coils: TC	
00767 00768			Counter contacts: CS	
00831 00832			Counter coils: CC	
00895 00896		Timer registers: TN		
01023 01024				Latch relays: L
01535 01536	Data registers: D			Step relays: S
02047 02048		Counter registers: CN		Link relays: B
02559 02560				Annunciators: F
02687 02688				Link special relays: SM
02815 02816				
02071 03072				
~	~	~		
~	~	~		
12287 12288				
~	Link registers: W	~		
~	~	~		
20479 20480	Special registers: SD			
22527 22528				
~	File registers: R	~		
~	~	~		
55295 55296				
~				
~				
65534				

Transfer Size

The following table lists the size of data that can be transferred using the MSG-SNDE function. Use the data size within the ranges listed in the following table according to the conditions of the Mitsubishi Q/QnA-series PLC slave.

The upper limit on the data size will also depend on the MEMOBUS function code that is specified in the MSG-SNDE function.

Refer to the following section for details on the data size parameter in the MSG-SNDE function.

◆ Data Size (PARAM17) on page 4-107

QnA-compatible 3E Frame (Hex)		Meaning	Data size
Command	Subcommand		218IFD
0401	0001	Reads bit devices in units of one point.	1 to 2000 points
0401	0000	Reads word devices in units of one point.	1 to 960 points
1401	0001	Writes bit devices in units of one point.	1 to 800 points
1401	0000	Writes word devices in units of one point.	1 to 960 points
0403	0000	Reads word devices in units of one point.	1 to 192 points
1402	0000	Writes word devices in units of one point.	1 to 160 points

Setting Example

The following figure illustrates how the contents of 800 bits (50 words) from the MB005120 to MB00561F hold registers in the MP3000 master are written to the 000000 to 000799 internal M relays in the CPU Unit of the Mitsubishi PLC slave.

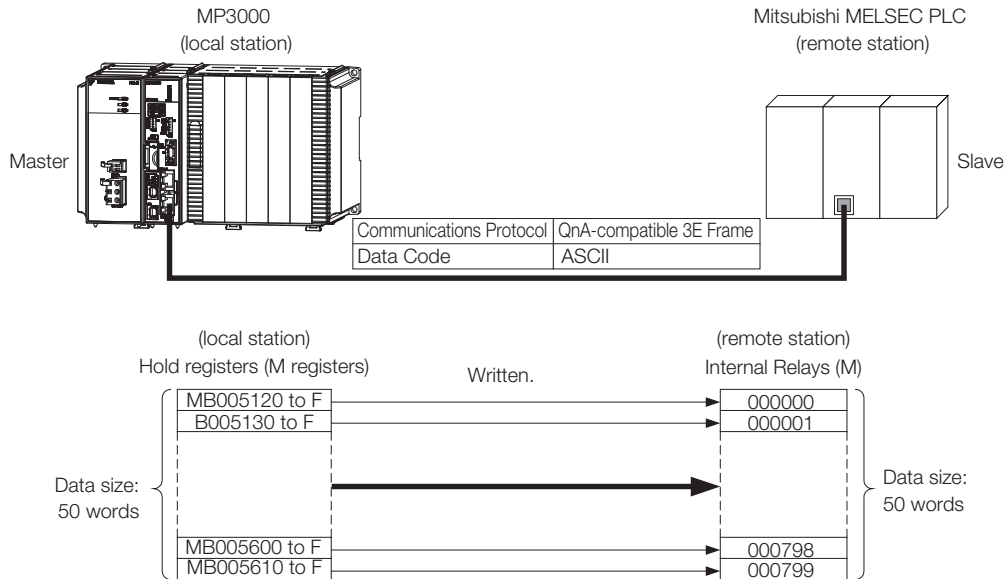

◆ MP3000 Setup

Use the following procedure to set up the MP3000.

Information If the communications parameters (IP address and subnet mask) have already been set, skip to step 3.

1. Double-click the cell for 218IFD in the Module Configuration Definition Tab Page.

Module	Function Module/Slave	Status	Circuit No./AxisAddress		Motion Register	Register(Input/Output)		
			Start	cupied circ.		Disabled	Start - End	Size
01 [CPU-302(32axes)] : ---	01 CPU	----	----	----	----	-----	-----	----
01 MBL-303	02 218IFD	----	☐	Circuit No1	1	-----	☐ Input ☐ OutPut	0000 - 07FF[H] 2048
	03 SVC32	----	☐	Circuit No1	1	8000 - 87FF[H]	☐ Input ☐ OutPut	0800 - 0BFF[H] 1024
	04 SVR32	----	☐	Circuit No3	1	9000 - 97FF[H]	-----	-----
	05 M-EXECUTOR	----	----	----	----	-----	-----	0C00 - 0C3F[H] 64
	06 -- UNDEFINED --	----	-----	-----	-----	-----	-----	-----
	07 -- UNDEFINED --	----	-----	-----	-----	-----	-----	-----
	01 -- UNDEFINED -- [-----]	----	-----	-----	-----	-----	-----	-----
02 -- UNDEFINED -- [-----]	----	-----	-----	-----	-----	-----	-----	
03 -- UNDEFINED --	----	-----	-----	-----	-----	-----	-----	
02 -- UNDEFINED --	----	-----	-----	-----	-----	-----	-----	
02 -- UNDEFINED --	----	-----	-----	-----	-----	-----	-----	
03 -- UNDEFINED --	----	-----	-----	-----	-----	-----	-----	
04 -- UNDEFINED --	----	-----	-----	-----	-----	-----	-----	

The 218IFD Detail Definition Dialog Box will be displayed.

2. Set the communications parameters.

- ① In the [IP Address] Boxes, enter the following address: 192.168.001.001.
- ② In the [Subnet Mask] Boxes, enter the following mask: 255.255.255.000.
- ③ In the [Gateway IP Address] Boxes, enter the following address: 000.000.000.000.

3. Click the [Easy setting] Button in the [Message Communication] Area in the [Connection Parameter] Area.

CNO	Local Port	Node IP Address	Node Port	Connect Type	Protocol Type	Code	Detail
01	----						Setting*
02	----						Setting*
03	----						Setting*
04	----						Setting*
05	----						Setting*
06	----						Setting*
07	----						Setting*

The Message Communication Easy Setting Dialog Box will be displayed.

4. Set the connection parameters.

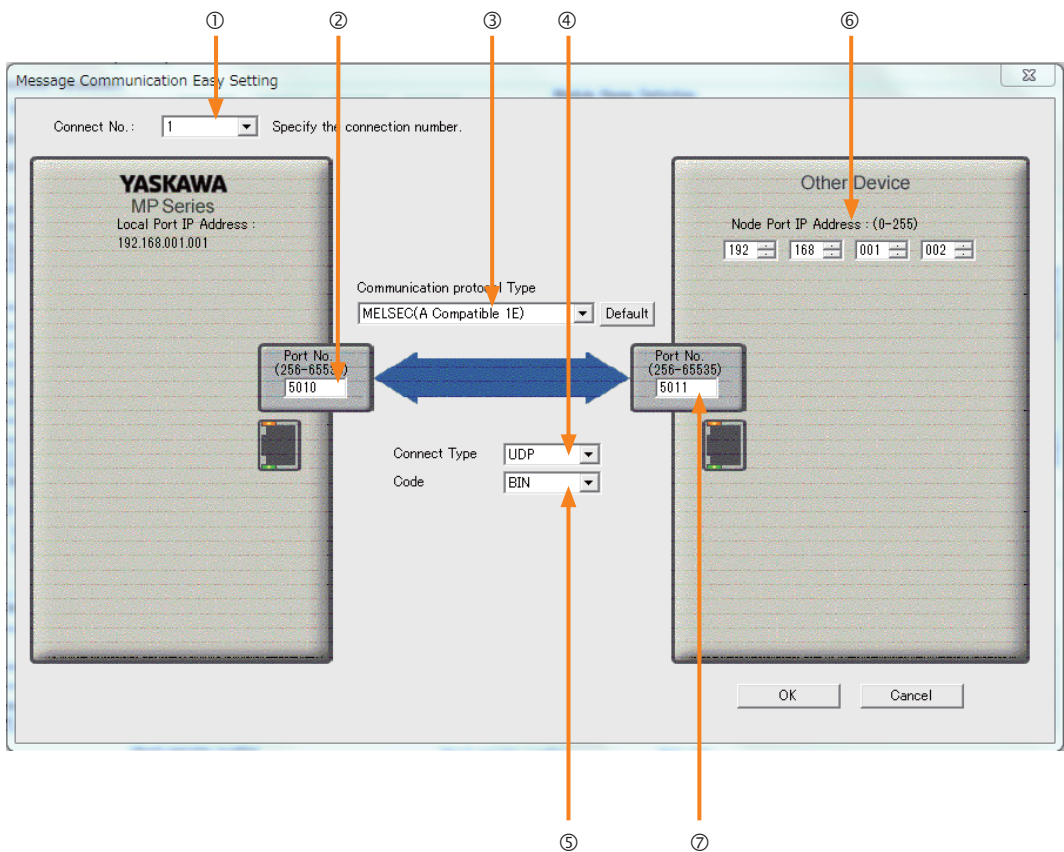

- ① Select [1] in the [Connect No.] Box.
- ② Enter "5010" in the [Port No.] Box for the MP-series Controller.
- ③ Select [MELSEC (QnA-compatible 3E)] in the [Communication protocol Type] Box.
- ④ Select [UDP] in the [Connect Type] Box.
- ⑤ Select [BIN] in the [Code] Box.
- ⑥ Enter the following address in the [Node Port IP Address] Boxes for the other device:
192.168.001.002.
- ⑦ Enter "5011" in the [Port No.] Box for the other device.

Note: Disable automatic reception for any connection for which message functions (MSG-SNDE) are used. If message functions are used while automatic reception is enabled, the communications will not function properly.

5. Click the [OK] Button.

6. Click the [Yes] Button in the Transmission Parameters Confirmation Dialog Box.

Note: If parameters have already been set for the same connection number and you click the Yes Button in the Transmission Parameters Confirmation Dialog Box, the settings will be overwritten by the parameters that are set in the Message Communications Easy Setting Dialog Box.

7. Check the settings and double-click the [Setting] Button in the [Detail] Column.

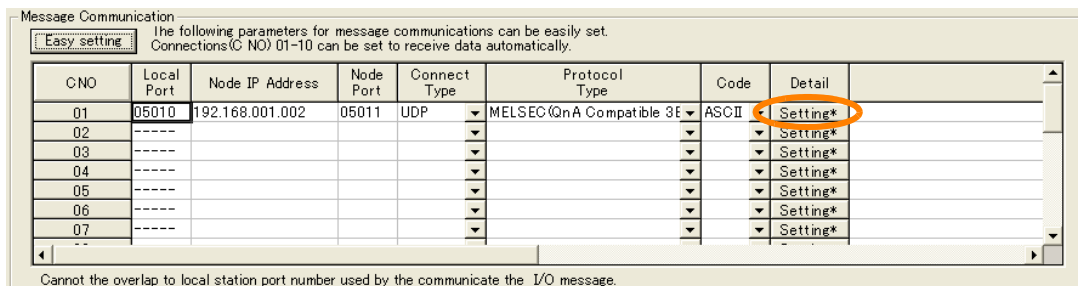

8. Select the [Disable] Option on the Automatically Reception Tab Page.

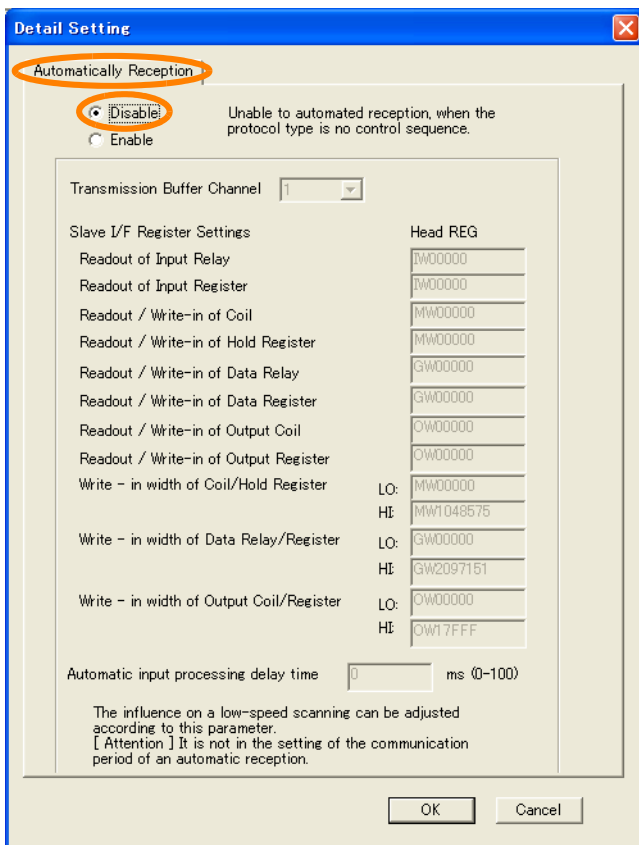

Note: Changes made to the communications or connection parameters will become effective only after the changes have been saved to flash memory and the power supply has been cycled.

9. Create a ladder program for the MSG-SNDE function.

A ladder program example is shown below.

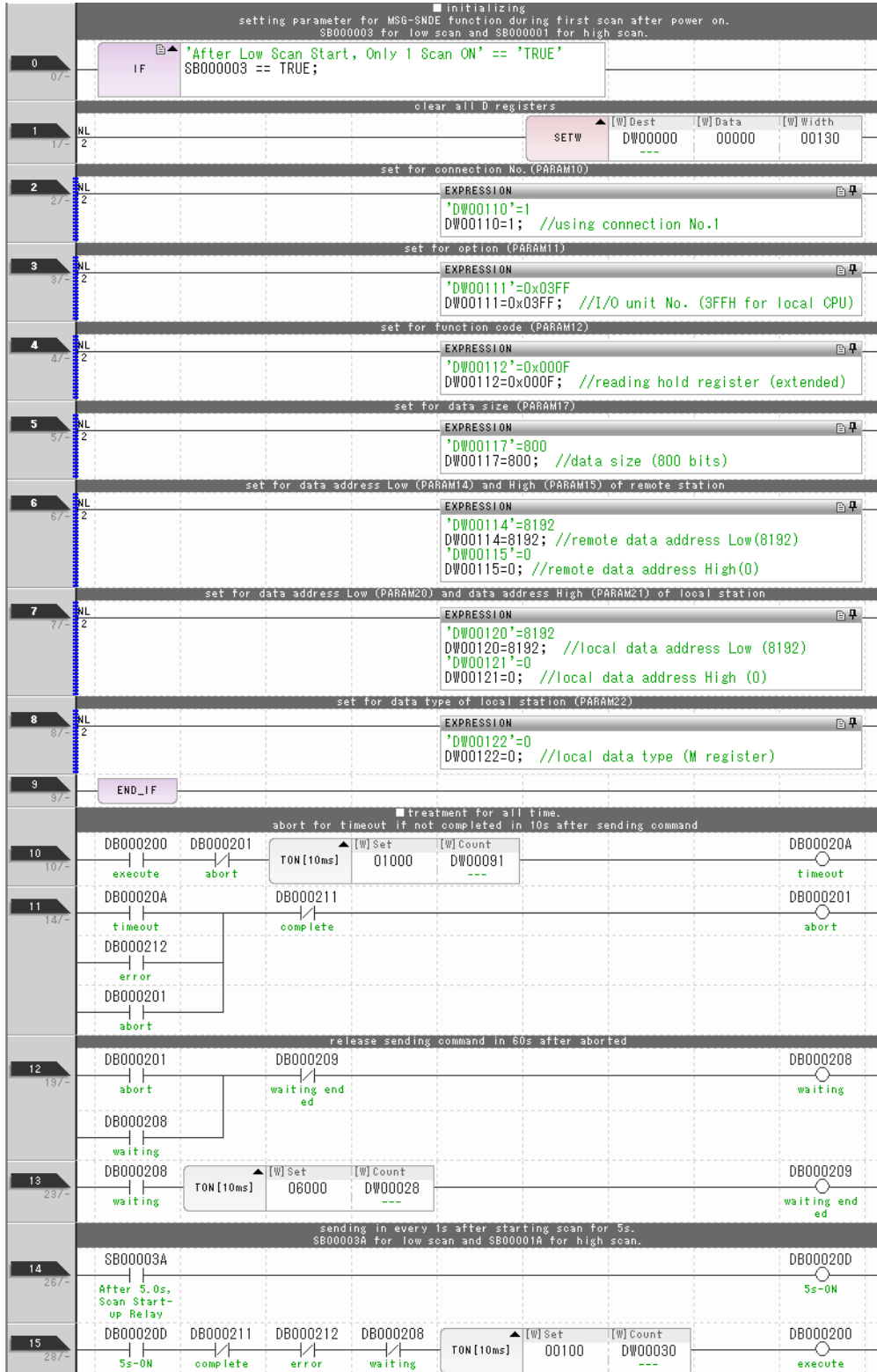

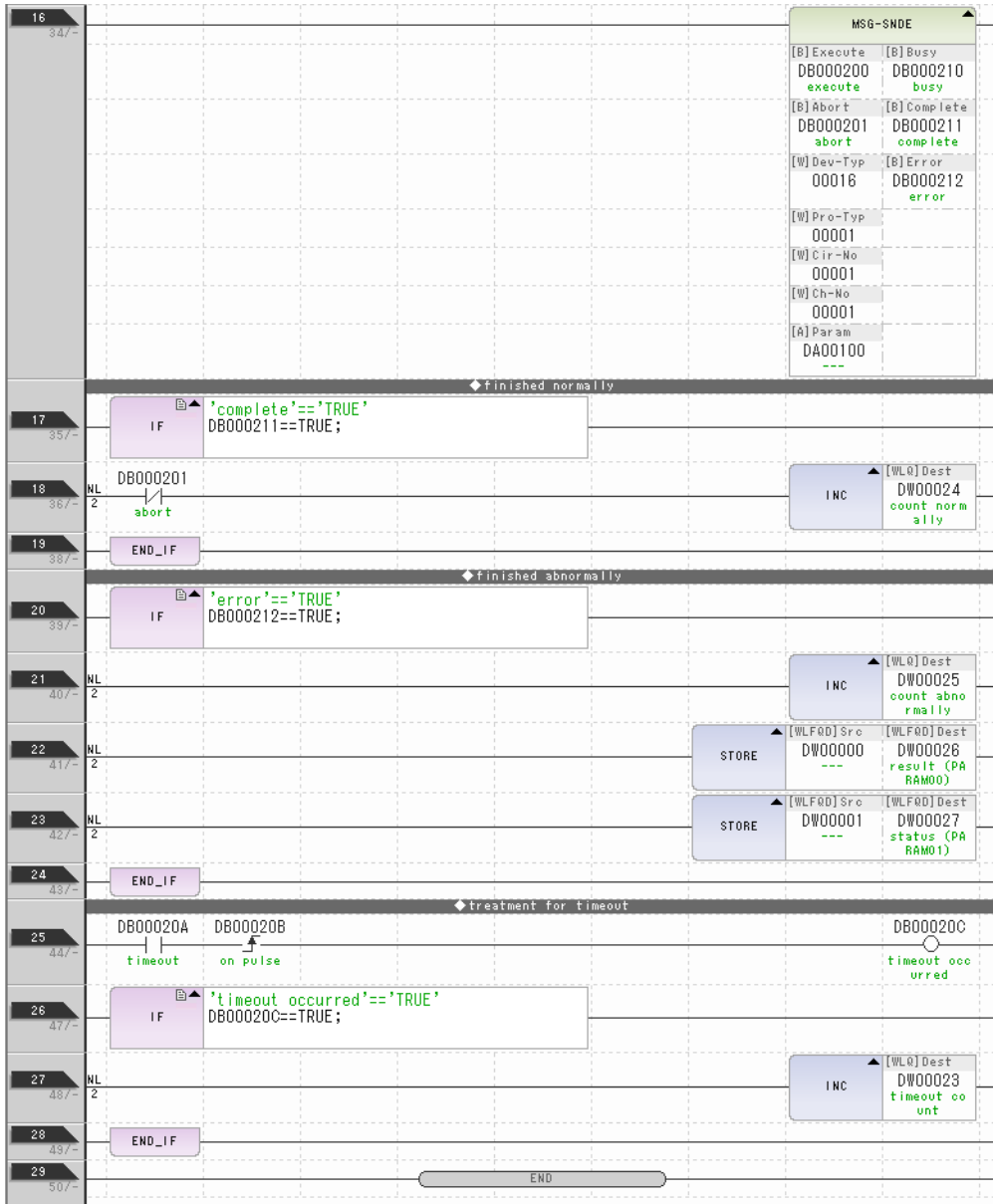

10. Save the data to flash memory.

This concludes the settings for using the MP3000 as the master.

◆ Setting Up the Remote Device (Mitsubishi PLC)

Use the following procedure to set up the Mitsubishi PLC (MELSEC device).

Information MELSEC devices are manufactured by Mitsubishi Electric Corporation. Contact Mitsubishi Electric Corporation for further information on MELSEC devices.

1. Start GX Developer.
2. Create a project.
3. Set the MELSECNET/Ethernet network parameters.

Parameter	Description
Network type	Ethernet
Starting I/O No.	As required.
Network No.	As required.
Group No.	As required.
Station No.	As required.
Mode	Online

4. Set the Ethernet operation settings.

Parameter	Description
Communications data code	ASCII code
Initial timing	Always wait for OPEN
IP address	192.168.001.002
Send frame setting	Ethernet (V2.0)
TCP existence confirmation setting	As required.
Enable Write at RUN time	Enable

5. Specify the open settings.

Table 4.10 Open Settings Example

Parameter	Description
Protocol	UDP
Open system	Full passive
Fixed buffer	As required.
Fixed buffer communication	As required.
Pairing open	As required.
Existence confirmation	As required.
Local station port No.	1393 hex (5011)
Destination IP address	192.168.1.1
Destination port No.	1392 hex (5010)

Table 4.11 Setting Example to Open the Built-in Ethernet Port in a MELSEC Device

Parameter	Description
Protocol	UDP
Open system	MC protocol
TCP connection	–
Local station port No.	1393 hex (5011)
Destination IP address	–
Destination port No.	–

Note: Specify an IP address that is not in use by any other device on the same network. Check with your network administrator for unused IP addresses.

This concludes the setup. Set any other parameters as necessary, then transfer the data to the PLC.

- Information** Set the initial settings and router relay parameters as necessary.
- Initial Settings
These settings apply to the timers when TCP is the selected protocol. In most cases, accept the default. Set these settings only when necessary, for example, to shorten the time set for the TCP resend timer.
 - Router Relay Parameters
Set these parameters if you are using a subnet mask pattern or default gateway.

◆ Starting Communications

Use the following procedure to write the data in the hold registers in the MP3000 to the internal relays in the CPU Unit of the Mitsubishi PLC.

1. Start receiving messages on the Mitsubishi PLC.
The system will automatically start the message reception operation. No further operation is required.
2. Turn ON the power to the MP3000 to start transmitting messages.
The ladder program example is designed to turn ON the Execute Bit (DB000200) in the message send function after six seconds has elapsed from when the low-speed scan (or high-speed scan) starts. Thereafter, the message send function is executed every second by alternating the Execute Bit (DB000200) between OFF and ON each time the message send function completes execution normally or with an error.

Note: The MP3000 will establish the TCP connection when it starts execution of the MSG-SNDE function.

SB00003A:
Turns ON 5 seconds after start.

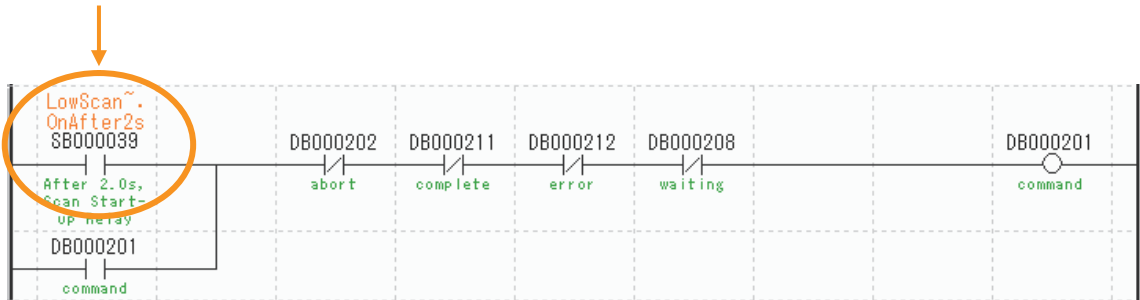

4.4.3 Message Functions

The message functions are used in user communications applications for the QnA-compatible 3E Frame protocol. You can send and receive message data by setting the necessary input items and parameters for the message functions. Message communications using the QnA-compatible 3E Frame protocol can be carried out with the same settings used for MEMOBUS messages.

Inputs and Outputs for the MSG-SNDE Function

I/O Definitions	No.	Name	I/O Designation	Meaning	Description
Input Items	1	Execute	B-VAL	Executes the transmission.	Specify the bit to use to execute the message transmission. When the Execute Bit turns ON, the message will be sent. Keep the Execute Bit ON until the Complete or Error Bit turns ON. To send another message, turn OFF the Execute Bit for at least one scan and then turn it ON again.
	2	Abort	B-VAL	Forces the transmission to end.	Specify the bit to use to abort the message transmission. When the Abort Bit turns ON, the message transmission will be stopped unconditionally. The Abort Bit takes precedence over the Execute Bit.
	3	Dev-Typ	I-REG	Communications device type	Specify the type code of the communications device. 218IFB, 218IFD = 16
	4	Pro-Typ	I-REG	Communications protocol	Specify the type code of the communications protocol. 1: MEMOBUS Select this protocol when using the QnA-compatible 3E Frame protocol. MEMOBUS is automatically converted to QnA-compatible 3E Frame protocol inside the 218IFD. 2: No-protocol communications 1 (unit: words) Not used for the QnA-compatible 3E Frame protocol. 3: No-protocol communications 2 (unit: bytes) Not used for the QnA-compatible 3E Frame protocol.
	5	Cir-No	I-REG	Circuit number	Specify the circuit number for the communications device. Specify the same circuit number as displayed in the MPE720 Module Configuration Definition Tab Page. 218IFB, 218IFD = 1 to 8
	6	Ch-No	I-REG	Communications buffer channel number	Specify the channel number of the communications buffer. You can specify any channel number provided it is within the valid range. When executing more than one function at the same time, do not use the same channel number for the same connection. You can use the same channel number as long as multiple functions are not executed at the same time. 218IFB, 218IFD = 1 to 10
	7	Param	Address Inputs	Parameter list first address (MA, DA)	Specify the first address of the parameter list. A total of 29 words starting from the specified first word are automatically used for the parameter list. The parameter list is used by inputting function codes and relevant parameter data. It is also where the process results and status are output.









Continued on next page.

Continued from previous page.

I/O Definitions	No.	Name	I/O Designation	Meaning	Description
Output Items	1	Busy	B-VAL	Processing.	Specify the bit that shows that the message transmission is in progress. The Busy Bit is ON while a message transmission or abort is in progress. Keep the Execute Bit or Abort Bit turned ON while the Busy Bit is ON.
	2	Complete	B-VAL	Process completed.	Specify the bit that shows when the message transmission has been completed. The Complete Bit turns ON only for one scan when message transmission or forced abort processing has been completed normally.
	3	Error	B-VAL	Error occurred.	Specify the bit that shows if an error occurred when sending the message. When an error occurs, the Error Bit will turn ON only for one scan. Refer to the following section for an example of a timing chart for when an error occurs.  ◆ Error on page 2-8











MSG-SNDE Function Parameters

The following table describes the contents of the addresses specified by the PARAM input parameter to the MSG-SNDE function.

No.	I/O	Meaning	Description	Reference Page
00	Out-puts	Processing Result	Gives the processing status.	 ◆ Processing Result (PARAM00) on page 2-9
01		Status	Gives the status of the current function.	 ◆ Status (PARAM01) on page 2-10
02		Detail Error Code, Lower Word	Gives the details of an error.	 ◆ Detail Error Code (PARAM02 and PARAM03) on page 4-104
03				
04		Status 1	Gives the communications status.	 ◆ Status 1 (PARAM04) on page 2-12
05		Status 2	Gives status information on the most recent error.	 ◆ Status 2 (PARAM05) on page 2-12
06		Status 3	Gives the information of the send pass counter.	 ◆ Status 3 (PARAM06) on page 2-12
07		Status 4	Gives the information of the receive pass counter.	 ◆ Status 4 (PARAM07) on page 2-12
08		Status 5	Gives the information of the error counter.	 ◆ Status 5 (PARAM08) on page 2-13
09	Status 6	Not used for the QnA-compatible 3E Frame protocol.	-	

Continued on next page.

Continued from previous page.

No.	I/O	Meaning	Description	Reference Page
10	Inputs	Connection Number	Sets the connection number used to determine the remote station.	 ◆ <i>Connection Number (PARAM10)</i> on page 4-105
11		Option	Sets the I/O unit number for the remote station.	 ◆ <i>Options (PARAM11)</i> on page 4-105
12		Function Code	Sets the code of the function in the QnA-compatible 3E Frame protocol.	 ◆ <i>Function Code (PARAM12)</i> on page 4-105
13		Reserved for system.	Not used for the QnA-compatible 3E Frame protocol.	–
14		Remote Station Data Address, Lower Word	Sets the data address to read/write at the remote station. (Use word addresses for registers, bit addresses for relays or coils.)	 ◆ <i>Remote Station Data Address (PARAM14 and PARAM15)</i> on page 4-106
15		Remote Station Data Address, Upper Word		
16		Remote Station Register Type	Not used for the QnA-compatible 3E Frame protocol.	–
17		Data Size	Sets the size of the data to read/write. (Use word sizes for registers, bit sizes for relays or coils.)	 ◆ <i>Data Size (PARAM17)</i> on page 4-107
18		Remote CPU Module Number	Not used for the QnA-compatible 3E Frame protocol.	–
19		Reserved for system.	Not used for the QnA-compatible 3E Frame protocol.	–
20		Local Station Data Address, Lower Word	Sets the data address to store read/write data in the local station. (Use word addresses for registers, bit addresses for relays or coils.)	 ◆ <i>Local Station Data Address (PARAM20 and PARAM21)</i> on page 2-18
21		Local Station Data Address, Upper Word		
22		Local Station Register Type	Sets the register type of the read/write data to store in the local station.	 ◆ <i>Local Station Register Type (PARAM22)</i> on page 4-108
23	Reserved for system.	This parameter is used by the system. Do not change the value of this parameter from a user program or by any other means.	 ◆ <i>Reserved for System (PARAM23)</i> on page 2-19	
24	–	For system use	This parameter contains the channel number of the communications buffer that is currently in use. A user program must set this parameter to 0 on the first scan after startup. Thereafter, do not change the value of this parameter from a user program or by any other means because it will be used by the system.	 ◆ <i>Reserved for System (PARAM24)</i> on page 2-19
25	–	Reserved for system.	These parameters are used by the system. Do not change the value of these parameters from a user program or by any other means.	 ◆ <i>Reserved for System (PARAM25 to PARAM28)</i> on page 2-19
26	–	Reserved for system.		
27	–	Reserved for system.		
28	–	Reserved for system.		

◆ Detail Error Code (PARAM02 and PARAM03)

These parameters give the detail error code.

Processing Result Value (PARAM00)	Detail Error Code	Error Description	Description
81□□ hex	1	Function code error	An unused function code was sent or received. Check PARAM12 (Function Code).
82□□ hex	2	Address setting error	The setting of one or more of the following parameters is out of range. Check the settings. PARAM14 and PARAM15 (Remote Station Data Address) PARAM20 and PARAM21 (Local Station Data Address)
83□□ hex	3	Data size error	The data size for sending or receiving is out of range. Check PARAM17 (Data Size).
84□□ hex	4	Circuit number setting error	The circuit number is out of range. Check the circuit number (Cir-No) in the MSG-SNDE function.
85□□ hex	5	Channel number setting error	The channel number for the communications buffer is out of range. Check the communications buffer channel number (Ch-No) in the MSG-SNDE function.
86□□ hex	6	Connection number error	The connection number is out of range. Check PARAM10 (Connection Number).
88□□ hex	8	Communications device error	An error response was received from the communications device. Check the connections to the device. Also check to see if the remote device is ready to communicate.
89□□ hex	9	Device select error	A device that cannot be used was selected. Check the communications device type (Dev-Typ) in the MSG-SNDE function.
C245 hex	–	Local station register type error	The register type for the local station is out of range. Check PARAM22 (Local Station Register Type).
8072 hex to FF72 hex		Remote device error*	An error response was received from the remote station. Check the error code and remove the cause.

* An error response received from the remote device will be formatted in PARAM00 (Processing Result) as follows.
Processing Result (PARAM00): □□72 hex (where □□ is the error code)
□□ contains the sum of the completion code sent from the Mitsubishi PLC and 80 hex.
Refer to the following manual for details on completion codes.

📖 Ethernet Unit Manual from Mitsubishi Electric Corporation

◆ Connection Number (PARAM10)

Specify the connection number.

The valid setting range is given in the following table.

Communications Device	Connection Number	Description
Ethernet (218IFD, 218IFB)	1 to 20	Specifies the connection number of the remote station to send the message to.

Note: Enter the same connection number as displayed in the 218IFB or 218IFD Detail Definition Dialog Box in the MPE720.

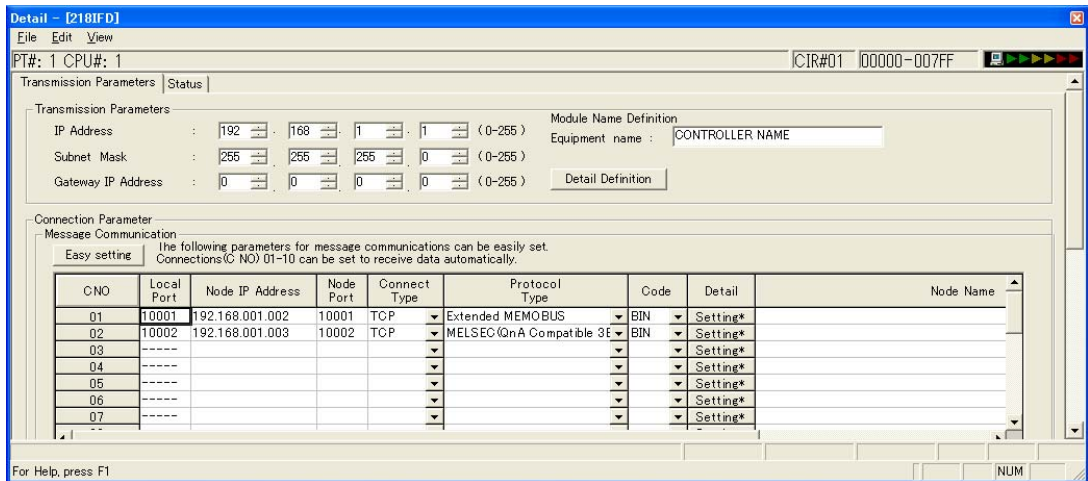

◆ Options (PARAM11)

Set the I/O unit number for the Mitsubishi PLC.

The value you set will be sent as the unit number as is, even if it is not listed below.

Unit Number	Name
03FF hex	Local station CPU, control CPU, and own system CPU
03D0 hex	Control system CPU
03D1 hex	Standby system CPU
03D2 hex	System A CPU
03D3 hex	System B CPU
03E0 hex	Multi-CPU No. 1
03E1 hex	Multi-CPU No. 2
03E2 hex	Multi-CPU No. 3
03E3 hex	Multi-CPU No. 4

◆ Function Code (PARAM12)

Set the function code to send.

You can use the functions that are registered to the function codes.

QnA-compatible 3E Frame Commands		MEMOBUS Function Code	Target Data Type	Function
Command	Subcommand			
0401 hex	0001 hex	01 or 02 hex	B	Reads bit devices in units of one point.
	0000 hex	03, 04, 09, or 0A hex	W	Reads word devices in units of one point.
1401 hex	0001 hex	05 or 0F hex	B	Writes bit devices in units of one point.
	0000 hex	06, 0B, or 10 hex	W	Writes word devices in units of one point.
1402 hex	0000 hex	0E hex	W	Writes word devices in units of one point.
0403 hex	0000 hex	0D hex	W	Reads word devices in units of one point.
0619 hex	0000 hex	08 hex	W	Performs a loopback test.

Note: B: Bit data, W: Word (channel) data

◆ Remote Station Data Address (PARAM14 and PARAM15)

Set the first address for data in the remote station.

Enter the first address as a decimal or hexadecimal number.

Example If the first address is MW01000, enter “1000” (decimal) or “3E8” (hexadecimal).

The applicable function codes and valid range of data addresses depend on the device type and device range of the Mitsubishi Q/QnA-series PLC.

Table 4.12 Bit Device Conversion Table

Device	QnA-compatible 3E Device Range	Notation	MEMOBUS Command	First Address	Register Address
Input Relays	X000000 to X001FFF	Hexadecimal	02 hex: Relays	00000 to 08191	MB000000 to MB00511F
Output Relays	Y000000 to Y001FFF	Hexadecimal	01, 05, and 0F hex: Coils	00000 to 08191	MB000000 to MB00511F
Internal Relays	M000000 to M008191	Decimal	01, 05, and 0F hex: Coils	08192 to 16383	MB005120 to MB01023F
Latch Relays	L000000 to L008191	Decimal	01, 05, and 0F hex: Coils	16384 to 24575	MB010240 to MB01535F
Step Relays	S000000 to S008191	Decimal	01, 05, and 0F hex: Coils	24576 to 32767	MB015360 to MB02047F
Link Relays	B000000 to B001FFF	Hexadecimal	01, 05, and 0F hex: Coils	32768 to 40959	MB020480 to MB02559F
Annunciators	F000000 to F002047	Decimal	01, 05, and 0F hex: Coils	40960 to 43007	MB025600 to MB02687F
Link Special Relays	SM000000 to SM002047	Decimal	01, 05, and 0F hex: Coils	43008 to 45055	MB026880 to MB02815F
Timer Contacts	TS000000 to TS002047	Decimal	02 hex: Relays	08192 to 10239	MB005120 to MB00639F
Timer Coils	TC000000 to TC002047	Decimal	02 hex: Relays	10240 to 12287	MB006400 to MB00767F
Counter Contacts	CS000000 to CS001023	Decimal	02 hex: Relays	12288 to 13311	MB007680 to MB00831F
Counter Coils	CC000000 to CC001023	Decimal	02 hex: Relays	13312 to 14335	MB008320 to MB00895F

Table 4.13 Word Device Conversion Table

Device	QnA-compatible 3E Device Range	Notation	MEMOBUS Command	First Address	Register Address
Data Registers	D000000 to D012287	Decimal	03, 06, 09, 0B, 0D, 0E, and 10 hex: Hold registers	00000 to 12287	MW00000 to MW12287
Link Registers	W000000 to W001FFF	Hexadecimal	03, 06, 09, 0B, 0D, 0E, and 10 hex: Hold registers	12288 to 20479	MW12288 to MW20479
Link Special Registers	SD000000 to SD002047	Decimal	03, 06, 09, 0B, 0D, 0E, and 10 hex: Hold registers	20480 to 22527	MW20480 to MW22527
File Registers	ZR000000 to ZR007FFF	Hexadecimal	03, 06, 09, 0B, 0D, 0E, and 10 hex: Hold registers	22528 to 55295	MW22528 to MW55295
Timer Registers	TN000000 to TN002047	Decimal	04 and 0A hex: Input registers	00000 to 02047	MW00000 to MW02047
Counter Registers	CN000000 to CN001023	Decimal	04 and 0A hex: Input registers	02048 to 03071	MW02048 to MW03071

Note: 1. Even if addresses are within the given device range, they may exceed the range of the device area depending on the model of the Mitsubishi PLC. Refer to the following manual for details.

 Programmable Controller Manual from Mitsubishi Electric Corporation

2. Access file registers by using the notation for accessing continuous file registers: ZR for ASCII data and B0 hex for binary data. The normal access notation (R* for ASCII data and AF hex for binary data) cannot be used.
3. The corresponding register address in the MP3000 can be adjusted by using the offset setting of the MSG-SNDE function.

◆ Data Size (PARAM17)

Set the data size for the read/write request as the number of bits or words.

Be sure that the last data address that is determined by the offset, data address, and data size does not exceed the valid data address range.

The range that is allowed for the data size depends on the function code and data area.

QnA-compatible 3E Frame Commands		MEMOBUS Command	Function	Points
Command	Subcommand			
0401 hex	0001 hex	01 or 02 hex	Reads bit devices in units of one point.	1 to 2000 points
	0000 hex	03 or 04 hex	Reads word devices in units of one point.	1 to 125 points
		09 or 0A hex		1 to 960 points* ²
1401 hex	0001 hex	05 hex	Writes bit devices in units of one point.	1 point
		0F hex		1 to 800 points
	0000 hex	06 hex	Writes word devices in units of one point.	1 point
		0B hex		1 to 960 points* ²
		10 hex		1 to 100 points
1402 hex	0000 hex	0E hex	Writes word devices in units of one point.	1 to 160 points
0403 hex	0000 hex	0D hex	Reads word devices in units of one point.	1 to 192 points
0619 hex	0000 hex	08 hex	Performs a loopback test* ¹ (word data loop)	2 points

*1. In the loopback test, the message sends two words (4 bytes) of data that must be returned.

*2. When using TCP communications, the upper limit is restricted by the MTU size. When communicating with TCP, the maximum size is the size of data that can be sent in a single segment.

◆ Local Station Register Type (PARAM22)

Set the register type of the read data destination or write data source in the MP3000.

Register Type Value	Type	Remarks
0	M	Sets the target data type to MB for bits and MW for words.
1	G	Sets the target data type to GB for bits and GW for words.
2	I	Sets the target data type to IB for bits and IW for words.
3	O	Sets the target data type to OB for bits and OW for words.
4	S	Sets the target data type to SB for bits and SW for words.
5 and higher	–	Not used for the QnA-compatible 3E Frame protocol.

The register types that can be used depend on whether you are reading or writing.

The following table lists the combinations of register types.

Function Code	Applicable Register Types
01, 02, 03, 04, 09, or 0A hex	M, G, or O
05, 06, 0B, 0F, or 10 hex	M, G, I, O, or S
0D hex	M
0E hex	M

Inputs and Outputs for the MSG-RCVE Function

I/O Definitions	No.	Name	I/O Designation	Meaning	Description
Input Items	1	Execute	B-VAL	Executes the transmission.	Specify the bit to use to execute the message transmission. When the Execute Bit turns ON, the message will be sent. Keep the Execute Bit ON until the Complete or Error Bit turns ON. To send another message, turn OFF the Execute Bit for at least one scan and then turn it ON again.
	2	Abort	B-VAL	Forces the transmission to end.	Specify the bit to use to abort the message transmission. When the Abort Bit turns ON, the message transmission will be stopped unconditionally. The Abort Bit takes precedence over the Execute Bit.
	3	Dev-Typ	I-REG	Communications device type	Specify the type code of the communications device. 218IFB, 218IFD = 16
	4	Pro-Typ	I-REG	Communications protocol	Specify the type code of the communications protocol. 1: MEMOBUS Select this protocol when using the QnA-compatible 3E Frame protocol. MEMOBUS is automatically converted to QnA-compatible 3E Frame protocol inside the 218IFD. 2: No-protocol communications 1 (unit: words) Not used for the QnA-compatible 3E Frame protocol. 3: No-protocol communications 2 (unit: bytes) Not used for the QnA-compatible 3E Frame protocol.
	5	Cir-No	I-REG	Circuit number	Specify the circuit number for the communications device. Specify the same circuit number as displayed in the MPE720 Module Configuration Definition Tab Page. 218IFB, 218IFD = 1 to 8
	6	Ch-No	I-REG	Communications buffer channel number	Specify the channel number of the communications buffer. You can specify any channel number provided it is within the valid range. When executing more than one function at the same time, do not use the same channel number for the same connection. You can use the same channel number as long as multiple functions are not executed at the same time. 218IFB, 218IFD = 1 to 10
	7	Param	Address Inputs	Parameter list first address (MA, DA)	Specify the first address of the parameter list. A total of 52 words starting from the specified first word are automatically used for the parameter list. The parameter list is used by inputting function codes and relevant parameter data. It is also where the process results and status are output.











Continued on next page.

Continued from previous page.

I/O Definitions	No.	Name	I/O Designation	Meaning	Description
Output Items	1	Busy	B-VAL	Processing.	Specify the bit that shows that the message transmission is in progress. The Busy Bit is ON while a message transmission or abort is in progress. Keep the Execute Bit or Abort Bit turned ON while the Busy Bit is ON.
	2	Complete	B-VAL	Process completed.	Specify the bit that shows when the message transmission has been completed. The Complete Bit turns ON only for one scan when message transmission or forced abort processing has been completed normally.
	3	Error	B-VAL	Error occurred.	Specify the bit that shows if an error occurred when sending the message. When an error occurs, the Error Bit will turn ON only for one scan. Refer to the following section for an example of a timing chart for when an error occurs.  ◆ Error on page 2-23













MSG-RCVE Function Parameters

The following table describes the contents of the addresses specified by the PARAM input parameter to the MSG-RCVE function.

No.	I/O	Meaning	Description	Reference Page
00	Out-puts	Processing Result	Gives the processing status.	 ◆ Processing Result (PARAM00) on page 2-25
01		Status	Gives the status of the current function.	 ◆ Status (PARAM01) on page 2-25
02		Detail Error Code, Lower Word	Gives the details of an error.	 ◆ Detail Error Code (PARAM02 and PARAM03) on page 4-113
03				
04		Status 1	Gives the communications status.	 ◆ Status 1 (PARAM04) on page 2-27
05		Status 2	Gives status information on the most recent error.	 ◆ Status 2 (PARAM05) on page 2-28
06		Status 3	Gives the information of the send pass counter.	 ◆ Status 3 (PARAM06) on page 2-28
07		Status 4	Gives the information of the receive pass counter.	 ◆ Status 4 (PARAM07) on page 2-28
08		Status 5	Gives the information of the error counter.	 ◆ Status 5 (PARAM08) on page 2-28
09		Status 6	Not used for the QnA-compatible 3E Frame protocol.	—
10	Input	Connection Number	Sets the connection number used to determine the remote station.	 ◆ Connection Number (PARAM10) on page 4-113
11	I/O	Option	Not used for the QnA-compatible 3E Frame protocol.	—
12	Output	Function Code	Gives the function code requested by the remote station.	 ◆ Function Code (PARAM12) on page 4-114
13	I/O	Reserved for system.	This parameter is used by the system. Do not change the value of this parameter from a user program or by any other means.	 ◆ Reserved for System (PARAM13) on page 2-30







Continued on next page.

Continued from previous page.

No.	I/O	Meaning	Description	Reference Page
14	Out-puts	Data Address, Lower Word	Gives the first address of the data that was requested by the remote station.	 ◆ <i>Data Address (PARAM14 and PARAM15)</i> on page 4-114
15		Data Address, Upper Word		
16		Register Types	Gives the register type that was requested by the remote station.	 ◆ <i>Register Type (PARAM16)</i> on page 2-31
17		Data Size	Gives the data size that was requested by the remote station.	 ◆ <i>Data Address (PARAM14 and PARAM15)</i> on page 2-30
18		Remote CPU Module Number	Not used for the QnA-compatible 3E Frame protocol.	—
19	I/O	Reserved for system.	This parameter is used by the system. Do not change the value of this parameter from a user program or by any other means.	 ◆ <i>Reserved for System (PARAM19)</i> on page 2-31
20	Inputs	Coil Offset, Lower Word	Sets the offset word address for a coil (MB).	 ◆ <i>Offsets (PARAM20 to PARAM27)</i> on page 4-115
21		Coil Offset, Upper Word		
22		Input Relay Offset, Lower Word	Sets the offset word address for an input relay (IB).	 ◆ <i>Offsets (PARAM20 to PARAM27)</i> on page 4-115
23		Input Relay Offset, Upper Word		
24		Input Register Offset, Lower Word	Sets the offset word address for an input register (IW).	 ◆ <i>Offsets (PARAM20 to PARAM27)</i> on page 4-115
25		Input Register Offset, Upper Word		
26		Hold Register Offset, Lower Word	Sets the offset word address for a hold register (MW).	 ◆ <i>Offsets (PARAM20 to PARAM27)</i> on page 4-115
27		Hold Register Offset, Upper Word		
28		Data Relay Offset, Lower Word	Sets the offset word address for a data relay (GB).	 ◆ <i>Data Relay Offset (PARAM28 and PARAM29)</i> on page 2-32
29		Data Relay Offset, Upper Word		
30		Data Register Offset, Lower Word	Sets the offset word address for a data register (GW).	 ◆ <i>Data Register Offset (PARAM30 and PARAM31)</i> on page 2-32
31		Data Register Offset, Upper Word		
32		Output Coil Offset, Lower Word	Sets the offset word address for an output coil (OB).	 ◆ <i>Output Coil Offset (PARAM32 and PARAM33)</i> on page 2-32
33		Output Coil Offset, Upper Word		
34		Output Register Offset, Lower Word	Sets the offset address for an output register (OW).	 ◆ <i>Output Register Offset (PARAM34 and PARAM35)</i> on page 2-32
35		Output Register Offset, Upper Word		
36		M Register Writing Range LO, Lower Word	Sets the first address of the writing range for hold register coils.	 ◆ <i>M Register Writing Range (PARAM36 to PARAM39)</i> on page 4-116
37	M Register Writing Range LO, Upper Word			

Continued on next page.

Continued from previous page.

No.	I/O	Meaning	Description	Reference Page
38	Inputs	M register Writing Range HI, Lower Word	Sets the last address of the writing range for hold register coils.	 ◆ M Register Writing Range (PARAM36 to PARAM39) on page 4-116
39		M Register Writing Range HI, Upper Word		
40		G register Writing Range LO, Lower Word	Sets the first address of the writing range for data register data relays.	 ◆ G Register Writing Range LO (PARAM40 and PARAM41) on page 2-33
41		G Register Writing Range LO, Upper Word		
42		G Register Writing Range HI, Lower Word	Sets the last address of the writing range for data register data relays.	 ◆ G Register Writing Range HI (PARAM42 and PARAM43) on page 2-33
43		G Register Writing Range HI, Upper Word		
44		O Register Writing Range LO, Lower Word	Sets the first address of the writing range for output registers.	 ◆ O Register Writing Range LO (PARAM44 and PARAM45) on page 2-33
45		O Register Writing Range LO, Upper Word		
46		O Register Writing Range HI, Lower Word	Sets the last address of the writing range for output registers.	 ◆ O Register Writing Range HI (PARAM46 and PARAM47) on page 2-34
47		O Register Writing Range HI, Upper Word		
48	-	For system use	This parameter contains the channel number of the communications buffer that is currently in use. A user program must set this parameter to 0 on the first scan after startup. Thereafter, do not change the value of this parameter from a user program or by any other means because it will be used by the system.	 ◆ For System Use (PARAM48) on page 2-34
49	-	Reserved for system.	These parameters are used by the system. Do not change the value of these parameters from a user program or by any other means.	 ◆ Reserved for System (PARAM49 to PARAM51) on page 2-34
50	-	Reserved for system.		
51	-	Reserved for system.		

◆ Detail Error Code (PARAM02 and PARAM03)

These parameters give the detail error code.

Processing Result Value (PARAM00)	Detail Error Code	Error Description	Description
81□□ hex	1	Function code error	An unused function code was received. Check the function code of the remote station.
82□□ hex	2	Address setting error	The setting of one or more of the following parameters is out of range. Check the settings. PARAM14 and PARAM15 (Data Address) PARAM20 and PARAM21 (Coil Offset) PARAM26 and PARAM27 (Hold Register Offset)
83□□ hex	3	Data size error	The data size for receiving is out of range. Check the data size at the remote station.
84□□ hex	4	Circuit number setting error	The circuit number is out of range. Check the circuit number (Cir-No) in the MSG-RCVE function.
85□□ hex	5	Channel number setting error	The channel number for the communications buffer is out of range. Check the communications buffer channel number (Ch-No) in the MSG-RCVE function.
86□□ hex	6	Connection number error	The connection number is out of range. Check PARAM10 (Connection Number).
88□□ hex	8	Communications device error	An error response was received from the communications device. Check the connections to the device. Also check to see if the remote device is ready to communicate.
89□□ hex	9	Device select error	A device that cannot be used was selected. Check the communications device type (Dev-Typ) in the MSG-RCVE function.

◆ Connection Number (PARAM10)

Specify the connection number.

The valid setting range is given in the following table.

Communications Device	Connection Number	Remarks
Ethernet (218IFD, 218IFB)	1 to 20	Specifies the connection number of the remote station to receive the message from.

Note: Enter the same connection number as displayed in the 218IFB or 218IFD Detail Definition Dialog Box in the MPE720.

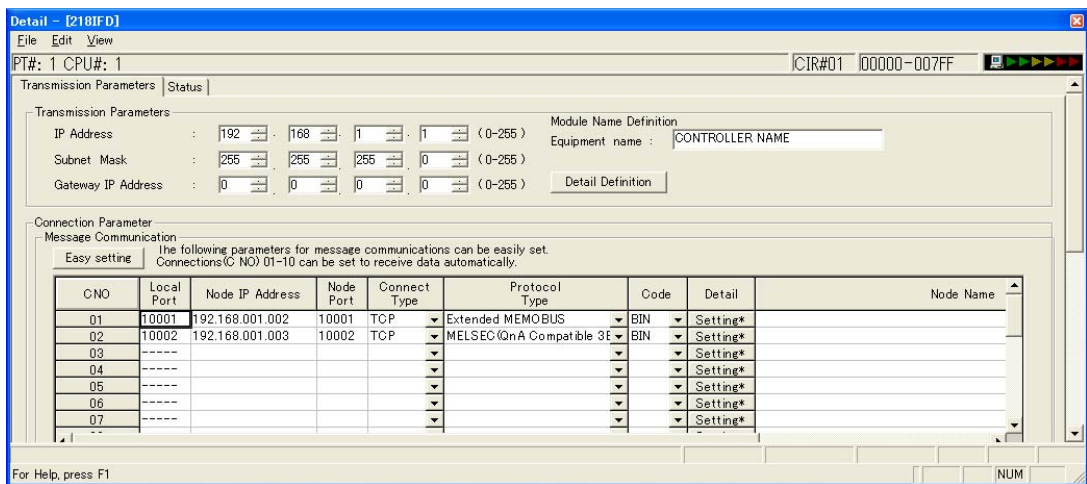

◆ Function Code (PARAM12)

This parameter gives the function code that was received.

QnA-compatible 3E Frame Commands		MEMOBUS Function Code Code	Target Data Type	Function
Command	Subcommand			
0401 hex	0001 hex	01 or 02 hex	B	Reads bit devices in units of one point.
	0000 hex	03, 04, 09, or 0A hex	W	Reads word devices in units of one point.
1401 hex	0001 hex	05 or 0F hex	B	Writes bit devices in units of one point.
	0000 hex	06, 0B, or 10 hex	W	Writes word devices in units of one point.
1402 hex	0000 hex	0E hex	W	Writes word devices in units of one point.
0403 hex	0000 hex	0D hex	W	Reads word devices in units of one point.
0619 hex	0000 hex	08 hex	W	Performs a loopback test.

Note: B: Bit data, W: Word (channel) data

◆ Data Address (PARAM14 and PARAM15)

These parameters give the data address that was requested by the remote station.

The type of device and device range determine the data area.

Table 4.14 Bit Device Conversion Table

Device	QnA-compatible 3E Frame Device Range	Notation	MEMOBUS Command	First Address	Register Address
Input Relays	X000000 to X001FFF	Hexadecimal	02 hex: Relays	00000 to 08191	MB000000 to MB00511F
Output Relays	Y000000 to Y001FFF	Hexadecimal	01, 05, and 0F hex: Coils	00000 to 08191	MB000000 to MB00511F
Internal Relays	M000000 to M008191	Decimal	01, 05, and 0F hex: Coils	08192 to 16383	MB005120 to MB01023F
Latch Relays	L000000 to L008191	Decimal	01, 05, and 0F hex: Coils	16384 to 24575	MB010240 to MB01535F
Step Relays	S000000 to S008191	Decimal	01, 05, and 0F hex: Coils	24576 to 32767	MB015360 to MB02047F
Link Relays	B000000 to B001FFF	Hexadecimal	01, 05, and 0F hex: Coils	32768 to 40959	MB020480 to MB02559F
Annunciators	F000000 to F002047	Decimal	01, 05, and 0F hex: Coils	40960 to 43007	MB025600 to MB02687F
Link Special Relays	SM000000 to SM002047	Decimal	01, 05, and 0F hex: Coils	43008 to 45055	MB026880 to MB02815F
Timer Contacts	TS000000 to TS002047	Decimal	02 hex: Relays	08192 to 10239	MB005120 to MB00639F
Timer Coils	TC000000 to TC002047	Decimal	02 hex: Relays	10240 to 12287	MB006400 to MB00767F
Counter Contacts	CS000000 to CS001023	Decimal	02 hex: Relays	12288 to 13311	MB007680 to MB00831F
Counter Coils	CC000000 to CC001023	Decimal	02 hex: Relays	13312 to 14335	MB008320 to MB00895F

Table 4.15 Word Device Conversion Table

Device	QnA-compatible 3E Frame Device Range	Notation	MEMOBUS Command	First Address	Register Address
Data Registers	D000000 to D012287	Decimal	03, 06, 09, 0B, 0D, 0E, and 10 hex: Hold registers	00000 to 12287	MW00000 to MW12287
Link Registers	W000000 to W001FFF	Hexadecimal	03, 06, 09, 0B, 0D, 0E, and 10 hex: Hold registers	12288 to 20479	MW12288 to MW20479
Link Special Registers	SD000000 to SD002047	Decimal	03, 06, 09, 0B, 0D, 0E, and 10 hex: Hold registers	20480 to 22527	MW20480 to MW22527
File Registers	ZR000000 to ZR007FFF	Hexadecimal	03, 06, 09, 0B, 0D, 0E, and 10 hex: Hold registers	22528 to 55295	MW22528 to MW55295
Timer Registers	TN000000 to TN002047	Decimal	04 and 0A hex: Input registers	00000 to 02047	MW00000 to MW02047
Counter Registers	CN000000 to CN001023	Decimal	04 and 0A hex: Input registers	02048 to 03071	MW02048 to MW03071

Note: 1. Even if addresses are within the given device range, they may exceed the range of the device area depending on the model of the Mitsubishi Q/QnA-series PLC. Refer to the following manual for details.

 Programmable Controller Manual from Mitsubishi Electric Corporation

2. Access file registers by using the notation for accessing continuous file registers: ZR for ASCII data and B0 hex for binary data. The normal access notation (R* for ASCII data and AF hex for binary data) cannot be used.
3. The corresponding register address in the MP3000 can be adjusted by using the offset setting of the MSG-RCVE function.

◆ Offsets (PARAM20 to PARAM27)

Set the offset for the data address in the MP3000.

The MP3000 will offset the address by the number of words specified by the offset.

Note: An offset cannot be a negative value.

Offset parameters are provided for each of the target register types.

The following table lists the offset parameters.

Parameters	Meaning	Description
PARAM20 and 21	Coil Offset	Sets the offset to the word address for a coil.
PARAM22 and 23	Input Relay Offset	Sets the offset to the word address for an input relay.
PARAM24 and 25	Input Register Offset	Sets the offset to the word address for an input register.
PARAM26 and 27	Hold Register Offset	Sets the offset to the word address for a hold register.

4.4.3 Message Functions

The offset parameters that can be used depend on the function code.

The following table lists the valid parameters for each function code.

Function Code	Function	Applicable Offset Parameters
01 hex	Reads the states of coils.	PARAM20 and 21
02 hex	Reads the states of input relays.	PARAM22 and 23
03 hex	Reads the contents of hold registers.	PARAM26 and 27
04 hex	Reads the contents of input registers.	PARAM24 and 25
05 hex	Changes the state of a single coil.	PARAM20 and 21
06 hex	Writes to a single hold register.	PARAM26 and 27
09 hex	Reads the contents of hold registers (extended).	PARAM26 and 27
0A hex	Reads the contents of input registers (extended).	PARAM24 and 25
0B hex	Writes to hold registers (extended).	PARAM26 and 27
0D hex	Reads the contents of non-consecutive hold registers (extended).	PARAM26 and 27
0E hex	Writes the contents of non-consecutive hold registers (extended).	PARAM26 and 27
0F hex	Changes the states of multiple coils.	PARAM20 and 21
10 hex	Writes to multiple hold registers.	PARAM26 and 27

◆ M Register Writing Range (PARAM36 to PARAM39)

Set the allowable address range for write requests from the remote station. An error will occur if the write request is outside this allowable range.

Specify the M Register Writing Range (PARAM36 to PARAM39) with word addresses.

Note: 1. M registers are always used as the destination in the MP3000 for data write requests from the remote station.

2. The writing range parameters allow you to specify the range of M registers that messages are allowed to write to.

The following table lists the writing range parameters.

Parameters	Meaning	Description
PARAM36 and 37	M Register Writing Range LO	First address of the writing range
PARAM38 and 39	M Register Writing Range HI	Last address of the writing range

Set the writing range so that it satisfies the following condition:

$$0 \leq \text{M register writing range LO} \leq \text{M register writing range HI} \leq \text{Maximum M register address}$$

The writing range applies when using the following function codes.

0B hex: Writes to hold registers (extended).

0F hex: Changes the states of multiple coils.

10 hex: Writes to multiple hold registers.

Example Use the following settings to set the allowable writing range of M register addresses to MW0001000 to MW0001999:

```
PARAM36 = 03E8 hex (1000)
PARAM37 = 0000 hex (0000)
PARAM38 = 07CF hex (1999)
PARAM39 = 0000 hex (0000)
```

The MP3000 will return an error if a write request is received for addresses outside the range from MW01000 to MW01999, and will not perform the writing operation.

4.5

Communications with an OMRON PLC (FINS Communications Service)

When using Ethernet communications between the MP3000 and an OMRON PLC, use the FINS protocol as the communications protocol. The FINS protocol allows the master to read and write the slave registers.

This section describes communications when the MP3000 acts as a slave and as the master.

When the MP3000 acts as a slave, communications can take place using automatic reception or using the MSG-RCVE function.

When the MP3000 acts as the master, communications can take place using I/O message communications or the MSG-SNDE function.

The communications modules which can perform communications with an OMRON PLC are 218IFD and 218IFB.

4.5.1

Using Automatic Reception with the MP3000 as a Slave

This section describes how to communicate with an OMRON PLC by using automatic reception.

FINS Commands

The FINS commands that can be used with automatic reception in the MP3000 are listed below. When executing FINS commands on an OMRON PLC that is acting as the master, use the command codes and I/O memory types that are given in the following table.

Name	Command Code (Hex)		I/O Memory Type (Hex)	Meaning	Remarks
	MR	SR			
Reading data from an I/O memory area	01	01	B0	Reads CIO Area words.	Use the RECV instruction.
			B1	Reads Work Area words.	
			B2	Reads Holding Area words.	
			B3	Reads Auxiliary Area words.	
			82	Reads DM Area words.	
Writing data to an I/O memory area	01	02	B0	Writes to CIO Area words.	Use the SEND instruction.
			B1	Writes to Work Area words.	
			B2	Writes to Holding Area words.	
			B3	Writes to Auxiliary Area words.	
			82	Writes to DM Area words.	
Reading non-consecutive data from the I/O memory area	01	04	82	Reads non-consecutive words from the DM Area.	Create a FINS command and use the CMND instruction to send it. This command can only read from the DM Area.

I/O Memory Data Areas and Corresponding Registers in the MP3000

The following table shows the relationship between registers in the MP3000 and the I/O memory data areas.

In an OMRON PLC, commands are used to specify the address and I/O memory area that correspond to the registers to read or write to in the MP3000.

- **Writing**

In the [First Destination Word] operand of the SEND instruction, specify the address in the OMRON CPU Unit that corresponds to the register address to write to in the MP3000.

Example **Writing Data into MW10000**
 Enter "D10000" in the [First Destination Word] operand as the corresponding address in the OMRON CPU Unit.

- **Reading**

In the [First Source Word] operand of the RECV instruction, specify the address in the OMRON CPU Unit that corresponds to the register address to read from in the MP3000.

Example **Reading Data from MW02048**
 Enter "D02048" or "W000" in the [First Source Word] operand as the corresponding address in the OMRON CPU Unit.

Data Area Name	Data Type	Data Range		
		OMRON CPU Unit		MP3000
		Addresses	I/O Memory Addresses	
CIO Area	Word	0000 to 2047	000000 to 07FF00	Word notation: MW00000 to MW02047 Bit notation: MB000000 to MB02047F
Work Area	Word	W000 to W511	00000 to 01FF00	Word notation: MW02048 to MW02559 Bit notation: MB020480 to MB02559F
Holding Area	Word	H000 to H511	00000 to 01FF00	Word notation: MW02560 to MW03071 Bit notation: MB025600 to MB03071F
Auxiliary Area	Word	A000 to A959	00000 to 03BF00	Word notation: MW03072 to MW04031 Bit notation: MB030720 to MB04031F
DM Area	Word	D00000 to D32767	00000 to 7FFF00	MW00000 to MW32767

Note: Word: Specify word addresses.

Transfer Size

The following table lists the data sizes that can be received in a single command by using automatic reception in the MP3000. When executing SEND, RECV, and CMND instructions on an OMRON PLC that is acting as the master, keep the data size within the ranges that are given in the following table.

Command Code (Hex)		I/O Memory Type (Hex)	Meaning	Data Size
MR	SR			
01	01	B0	Reads CIO Area words.	1 to 125 words (16 to 2,000 bits)
		B1	Reads Work Area words.	
		B2	Reads Holding Area words.	
		B3	Reads Auxiliary Area words.	
		82	Reads DM Area words.	
01	02	B0	Writes to CIO Area words.	1 to 50 words (16 to 800 bits)
		B1	Writes to Work Area words.	
		B2	Writes to Holding Area words.	
		B3	Writes to Auxiliary Area words.	
		82	Writes to DM Area words.	
01	04	82	Reads non-consecutive words from the DM Area.	1 to 167 words

Setting Example

The following figure illustrates how the contents of the D00000 to D00099 in the DM Area in the CPU Unit of the OMRON master are written to the MW00000 to MW00099 hold registers in the MP3000 slave.

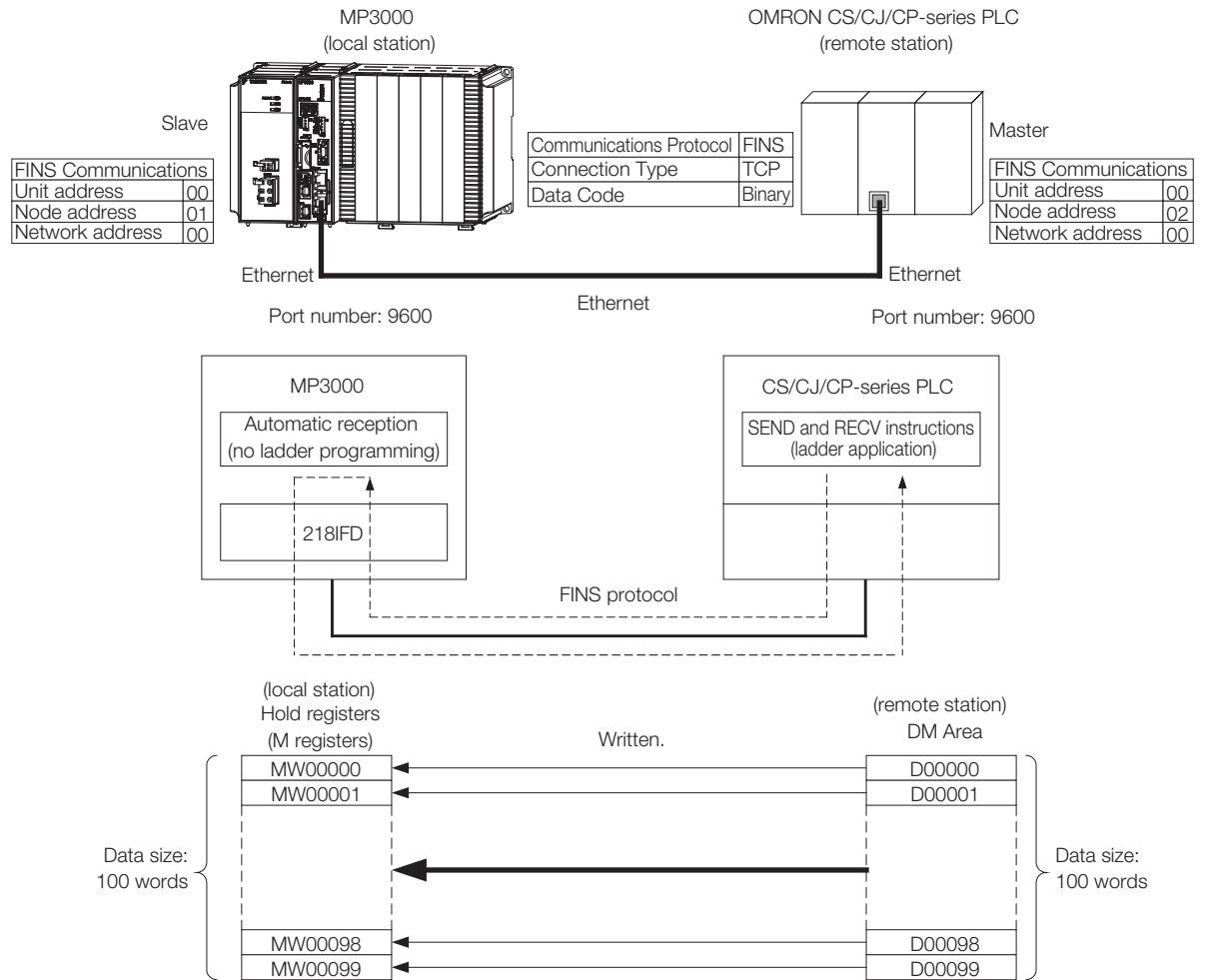

◆ MP3000 Setup

Use the following procedure to set up the MP3000.

Information If the communications parameters (IP address and subnet mask) have already been set, skip to step 3.

1. Double-click the cell for 218IFD in the Module Configuration Definition Tab Page.

Module	Function Module/Slave	Status	Circuit No./AxisAddress		Motion Register	Register(Input/Output)		
			Start	cupied circ.		Disabled	Start - End	Size
01 [CPU-302(32axes)] : ---	01 CPU	----	----	----	----	-----	-----	----
01 MBL-303	02 218IFD	----	品	Circuit No1	1	-----	<input type="checkbox"/> Input <input type="checkbox"/> OutPut	0000 - 07FF[H] 2048
	03 SVC32	----	品	Circuit No1	1	8000 - 87FF[H]	<input type="checkbox"/> Input <input type="checkbox"/> OutPut	0800 - 0BFF[H] 1024
	04 SVR32	----	品	Circuit No3	1	9000 - 97FF[H]	-----	-----
	05 M-EXECUTOR	----	----	----	----	-----	-----	0C00 - 0C3F[H] 64
	06 -- UNDEFINED --	----	----	----	----	-----	-----	-----
	07 -- UNDEFINED --	----	----	----	----	-----	-----	-----
	01 -- UNDEFINED -- [-----]	----	----	----	----	-----	-----	-----
02 -- UNDEFINED -- [-----]	----	----	----	----	-----	-----	-----	
03 -- UNDEFINED --	----	----	----	----	-----	-----	-----	
02 -- UNDEFINED --	----	----	----	----	-----	-----	-----	
02 -- UNDEFINED --	----	----	----	----	-----	-----	-----	
03 -- UNDEFINED --	----	----	----	----	-----	-----	-----	
04 -- UNDEFINED --	----	----	----	----	-----	-----	-----	

The 218IFD Detail Definition Dialog Box will be displayed.

2. Set the communications parameters.

- ① In the [IP Address] Boxes, enter the following address: 192.168.001.001.
- ② In the [Subnet Mask] Boxes, enter the following mask: 255.255.255.000.
- ③ In the [Gateway IP Address] Boxes, enter the following address: 000.000.000.000.

3. Click the [Easy setting] Button in the [Message Communication] Area in the [Connection Parameter] Area.

CNO	Local Port	Node IP Address	Node Port	Connect Type	Protocol Type	Code	Detail
01	-----						Setting*
02	-----						Setting*
03	-----						Setting*
04	-----						Setting*
05	-----						Setting*
06	-----						Setting*
07	-----						Setting*

The Message Communications Easy Setting Dialog Box will be displayed.

4. Set the connection parameters.

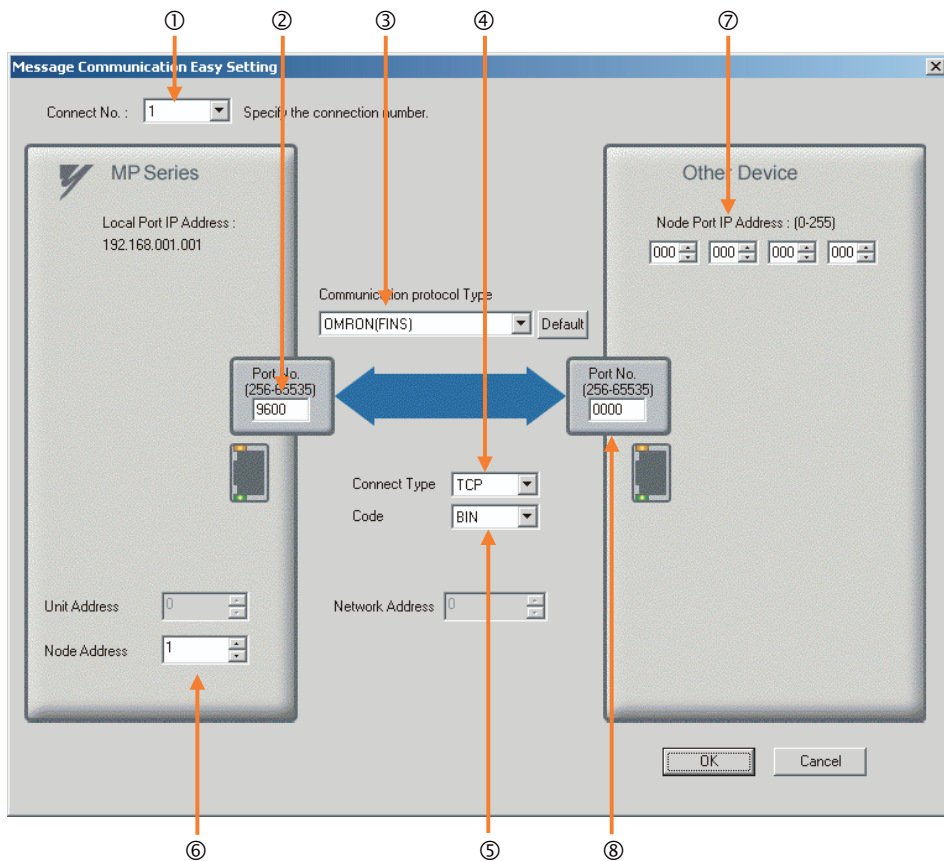

- ① Select [1] in the [Connect No.] Box.
- ② Enter “9600” in the [Port No.] Box for the MP-series Controller.
- ③ Select [OMRON (FINS)] in the [Communication Protocol Type] Box.
- ④ Select [TCP] in the [Connect Type] Box.
- ⑤ Select [BIN] in the [Code] Box.
- ⑥ Enter “001” in the [Node Address] Box for the MP-series Machine Controller.
- ⑦ Enter the following address in the [Node Port IP Address] Boxes for the other device: 000.000.000.000.
- ⑧ Enter “0000” in the [Port No.] Box for the other device.

Note: The unit address and network address of the MP-series Machine Controller are always 00 hex.
If communicating with FINS/UDP, select [UDP] in the [Connect Type] Box.

5. Click the [OK] Button.

6. Click the [Yes] Button in the Transmission Parameters Confirmation Dialog Box.

Note: If parameters have already been set for the same connection number and you click the [Yes] Button in the Transmission Parameters Confirmation Dialog Box, the settings will be overwritten by the parameters that are set in the Message Communications Easy Setting Dialog Box.

7. Check the settings and double-click the [Setting] Button in the [Detail] Column.

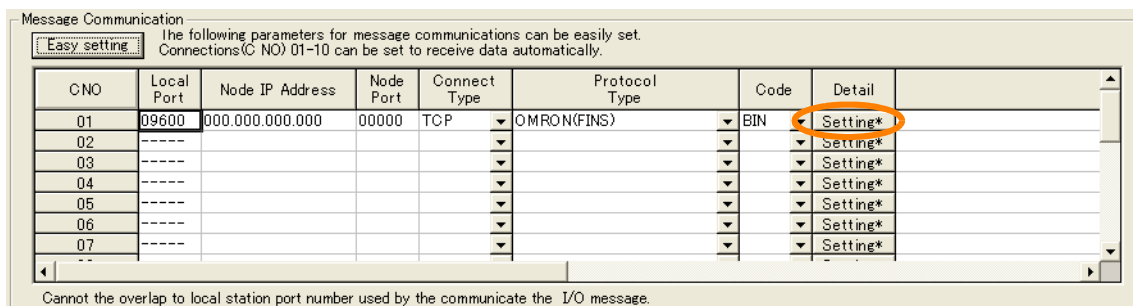

- 8. Select the [Enable] Option in the Automatically Reception Tab Page and then click the [OK] Button.

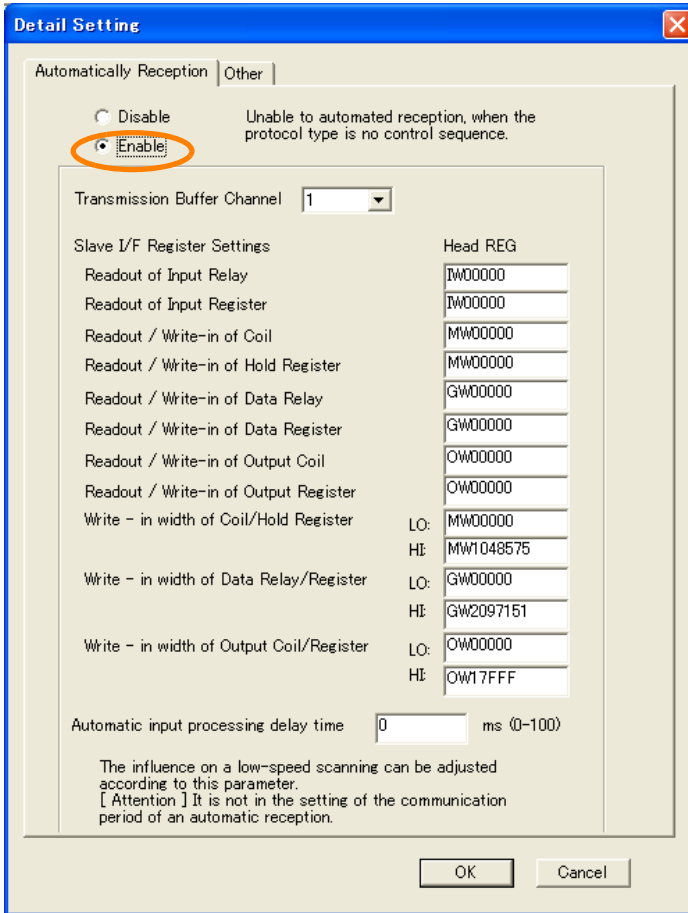

The setting in the [Node Address] Box on the Other Tab Page will contain the value that is set in the Message Communication Easy Setting Dialog Box.

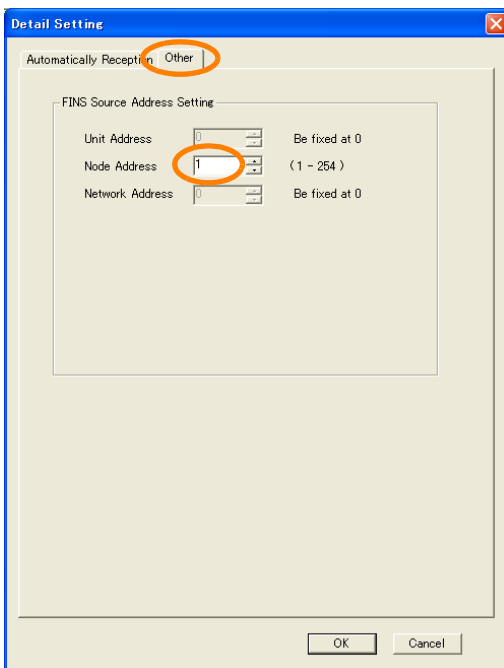

Note: Specify a node address that is not in use by any other device on the same network.

- 9. Save the data to flash memory.

Note: Changes made to the communications or connection parameters will become effective only after the changes have been saved to flash memory and the power supply has been cycled.

This concludes the settings for using the MP3000 as a slave.

◆ Setting the Remote Device (OMRON PLC)

Use the following procedure to set up the OMRON CJ-series PLC.

Information The CJ Series is manufactured by OMRON Corporation.
Contact OMRON Corporation for further information.

1. Set the node address of the Ethernet Unit. In this example, the node address is set to 02 hex.
2. Start the CX-Programmer.
3. Create a project.
4. Set the network parameters.

Parameter	Description
Broadcasting	As required.
FINS/UDP Port	As required.
FINS/TCP Port	Default (9,600)
TCP/IP keep-alive	As required.
IP Address	192.168.1.2
Subnet Mask	255.255.255.000
IP Address Conversion	Combined method
Baud Rate	Automatic detection
Dynamic Change the Target IP Addresses	As required.

Note: When using an OMRON PLC, set the node address of the Ethernet Unit so that it matches the last digit of the IP address (2 in the case of 192.168.001.002). If the node address does not match the last digit, an error may occur in the Ethernet Unit of the OMRON PLC.
When communicating with FINS/UDP, set the FINS/UDP port setting to the same number as the remote station port number of the MP3000.

5. Set the FINS/TCP connection parameters. Use the following settings for FINS/TCP connection number 1.

Note: The FINS/TCP connection settings are not required when communicating with FINS/UDP.

Parameter	Description
FINS/TCP Server/Client	Client
Target IP Address	192.168.1.1
Automatically Allocated FINS Node Address for Server	Do not set.
Keep-alive	As required.

6. Create routing tables if required.

Note: Specify an IP address that is not in use by any other device on the same network.
Check with your network administrator for unused IP addresses.

4.5.1 Using Automatic Reception with the MP3000 as a Slave

7. Create ladder programming for network transmissions.

To write data to a node on the network, use the SEND instruction. The following is an example of the settings for a SEND instruction.

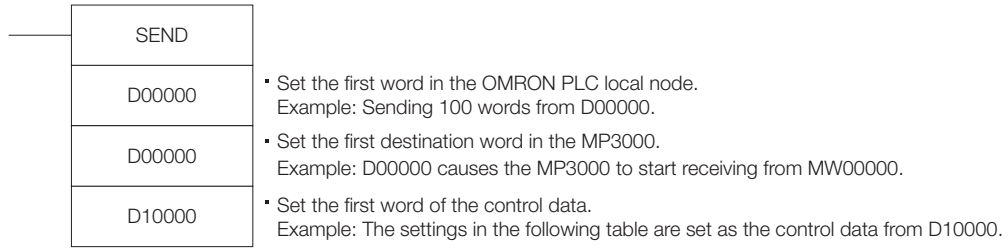

Word	Meaning	Meaning
D10000	0064 hex	Number of words to send = 100 words
D10001	0000 hex	Destination network address = 00 (local)
D10002	0100 hex	Destination node address = 1 Destination unit address = 00
D10003	0701 hex	Response = Required. Communications port number used = 7, Number of retries = 1
D10004	0014 hex	Response monitor time = 20 (2 seconds)

When using the SEND instruction, create any logic necessary to interlock with other processes and to adjust the timing of the execution.

Note: Refer to the following manuals for details on ladder programming with the SEND, RECV, and CMND instructions for network communications.

- 📖 SYSMAC CS/CJ-series Ethernet Units Operation Manual from OMRON Corporation
- 📖 SYSMAC CS/CJ/NSJ-series Programmable Controllers Instructions Reference Manual from OMRON Corporation

This concludes the setup.

◆ Starting Communications

Use the following procedure to write the data in the DM Area in the OMRON PLC to the hold registers in the MP3000.

- 1. Turn ON the power to the MP3000 to start receiving messages.**
The system will automatically start the message reception operation. No further operation is required.
- 2. Start the message send operation on the OMRON PLC.**

Note: The MP3000 will wait for the TCP connection after it starts the automatic reception operation. Therefore, the power supply to the MP3000 must be turned ON before the power supply to the OMRON PLC.

4.5.2 Using the MSG-RCVE Function with the MP3000 as a Slave

This section describes how to communicate with an OMRON PLC by using the MSG-RCVE function.

When an OMRON PLC is used as the master to execute FINS commands, it will need a ladder application that uses the SEND and RECV instructions.

FINS Commands

Refer to the following section for details on the FINS commands that are used with the MSG-RCVE function.

 *FINS Commands* on page 4-125

I/O Memory Data Areas and Corresponding Registers in the MP3000

The following table shows the relationship between registers in the MP3000 and the I/O memory data areas.

In an OMRON PLC, FINS commands are used to specify the address and I/O memory area that correspond to the registers to read or write to in the MP3000.

- **Writing**

In the [First Destination Word] operand of the SEND instruction, specify the address in the OMRON CPU Unit that corresponds to the register address to write to in the MP3000.

Example Writing Data into MW10000
Enter "D10000" in the [First Destination Word] operand as the corresponding address in the OMRON CPU Unit.

- **Reading**

In the [First Source Word] operand of the RECV instruction, specify the address in the OMRON CPU Unit that corresponds to the register address to read from in the MP3000.

Example Reading Data from MW02048
Enter "D02048" or "W000" in the [First Source Word] operand as the corresponding address in the OMRON CPU Unit.

Data Area Name	Data Type	Data Range		
		OMRON CPU Unit		MP3000
		Addresses	I/O Memory Addresses	
CIO Area	Word	0000 to 2047	000000 to 07FF00	Word notation: MW00000 to MW02047 Bit notation: MB000000 to MB02047F
Work Area	Word	W000 to W511	00000 to 01FF00	Word notation: MW02048 to MW02559 Bit notation: MB020480 to MB02559F
Holding Area	Word	H000 to H511	00000 to 01FF00	Word notation: MW02560 to MW03071 Bit notation: MB025600 to MB03071F
Auxiliary Area	Word	A000 to A959	00000 to 03BF00	Word notation: MW03072 to MW04031 Bit notation: MB030720 to MB04031F
DM Area	Word	D00000 to D32767	00000 to 7FFF00	MW00000 to MW32767

Note: Word: Specify word addresses.

Transfer Size

The following table lists the data sizes that can be received in a single FINS command when using the MSG-RCVE function. When executing SEND, RECV, and CMND instructions on an OMRON PLC that is acting as the master, keep the data size within the ranges that are given in the following table.

Command Code (Hex)		I/O Memory Type (Hex)	Meaning	Data Size
MR	SR			
01	01	B0	Reads CIO Area words.	1 to 125 words (16 to 2,000 bits)
		B1	Reads Work Area words.	
		B2	Reads Holding Area words.	
		B3	Reads Auxiliary Area words.	
		82	Reads DM Area words.	
01	02	B0	Writes to CIO Area words.	1 to 50 words (16 to 800 bits)
		B1	Writes to Work Area words.	
		B2	Writes to Holding Area words.	
		B3	Writes to Auxiliary Area words.	
		82	Writes to DM Area words.	
01	04	82	Reads non-consecutive words from the DM Area.	1 to 167 words

Setting Example

The following figure illustrates how the contents of the MW10000 to MW10099 hold registers in the MP3000 slave are read into D10000 to D10099 in the DM Area in the CPU Unit of the OMRON PLC master.

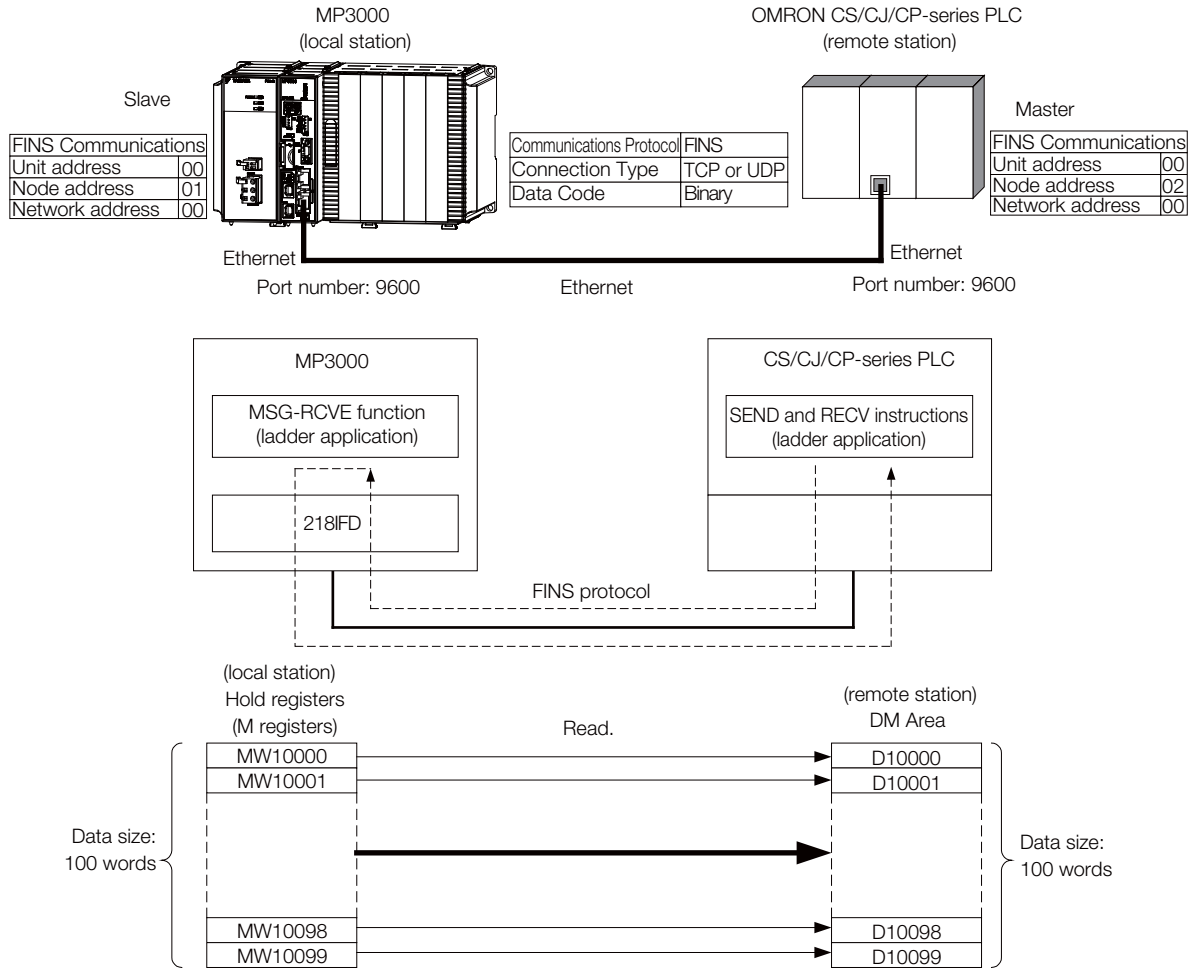

◆ MP3000 Setup

Use the following procedure to set up the MP3000.

Information If the communications parameters (IP address and subnet mask) have already been set, skip to step 3.

1. Double-click the cell for 218IFD in the Module Configuration Definition Tab Page.

Module	Function Module/Slave	Status	Circuit No./AxisAddress		Motion Register	Register(Input/Output)		
			Start	cupied circ.		Disabled	Start - End	Size
01 [CPU-302(32axes)] : ---	01 CPU	----	----	----	----	-----	-----	----
01 MEBL-303	02 218IFD	----	品	Circuit No1	1	-----	<input type="checkbox"/> Input <input type="checkbox"/> OutPut	0000 - 07FF[H] 2048
	03 SVC32	----	品	Circuit No1	1	8000 - 87FF[H]	<input type="checkbox"/> Input <input type="checkbox"/> OutPut	0800 - 0BFF[H] 1024
	04 SVR32	----	品	Circuit No3	1	9000 - 97FF[H]	-----	-----
	05 M-EXECUTOR	----	----	----	----	-----	-----	0C00 - 0C3F[H] 64
	06 -- UNDEFINED --	----	----	----	----	-----	-----	-----
	07 -- UNDEFINED --	----	----	----	----	-----	-----	-----
	01 -- UNDEFINED -- [-----]	----	----	----	----	-----	-----	-----
02 -- UNDEFINED -- [-----]	----	----	----	----	-----	-----	-----	
03 -- UNDEFINED --	----	----	----	----	-----	-----	-----	
02 -- UNDEFINED --	----	----	----	----	-----	-----	-----	
02 -- UNDEFINED --	----	----	----	----	-----	-----	-----	
03 -- UNDEFINED --	----	----	----	----	-----	-----	-----	
04 -- UNDEFINED --	----	----	----	----	-----	-----	-----	

The 218IFD Detail Definition Dialog Box will be displayed.

2. Set the communications parameters.

- ① In the [IP Address] Boxes, enter the following address: 192.168.001.001.
- ② In the [Subnet Mask] Boxes, enter the following mask: 255.255.255.000.
- ③ In the [Gateway IP Address] Boxes, enter the following address: 000.000.000.000.

3. Click the [Easy setting] Button in the [Message Communication] Area in the [Connection Parameter] Area.

CNO	Local Port	Node IP Address	Node Port	Connect Type	Protocol Type	Code	Detail
01	----						Setting*
02	----						Setting*
03	----						Setting*
04	----						Setting*
05	----						Setting*
06	----						Setting*
07	----						Setting*

The Message Communications Easy Setting Dialog Box will be displayed.

4. Set the connection parameters.

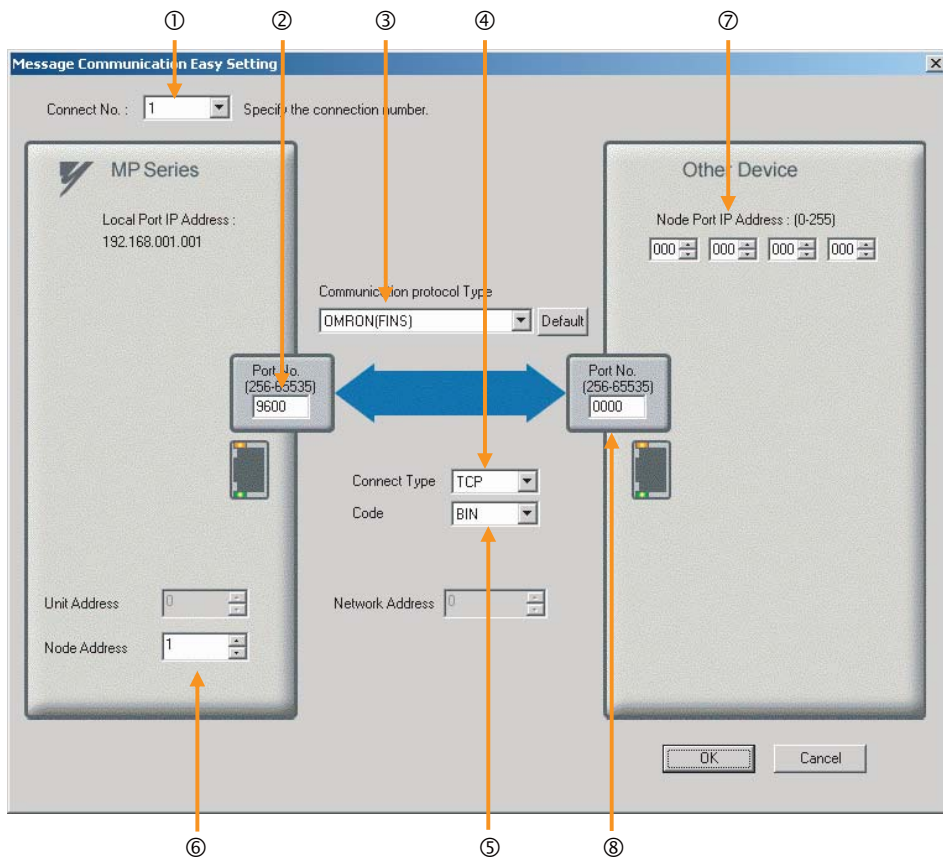

- ① Select [1] in the [Connect No.] Box.
- ② Enter "9600" in the [Port No.] Box for the MP-series Controller.
- ③ Select [OMRON (FINS)] in the [Communication Protocol Type] Box.
- ④ Select [TCP] in the [Connect Type] Box.
- ⑤ Select [BIN] in the [Code] Box.
- ⑥ Enter 001 in the [Node Address] Box for the MP-series Machine Controller.
- ⑦ Enter the following address in the [Node Port IP Address] Boxes for the other device:
000.000.000.000.
- ⑧ Enter 0000 in the [Port No.] Box for the other device.

Note: Disable automatic reception for any connection for which message functions (MSG-SNDE and MSG-RCVE) are used. If message functions are used while automatic reception is enabled, the communications will not function properly.

The unit address and network address of the MP-series Machine Controller are always 00 hex.
If communicating with FINS/UDP, select [UDP] in the [Connect Type] Box.

5. Click the [OK] Button.

6. Click the [Yes] Button in the Transmission Parameters Confirmation Dialog Box.

Note: If parameters have already been set for the same connection number and you click the [Yes] Button in the Transmission Parameters Confirmation Dialog Box, the settings will be overwritten by the parameters that are set in the Message Communications Easy Setting Dialog Box.

7. Check the settings and double-click the [Setting] Button in the [Detail] Column.

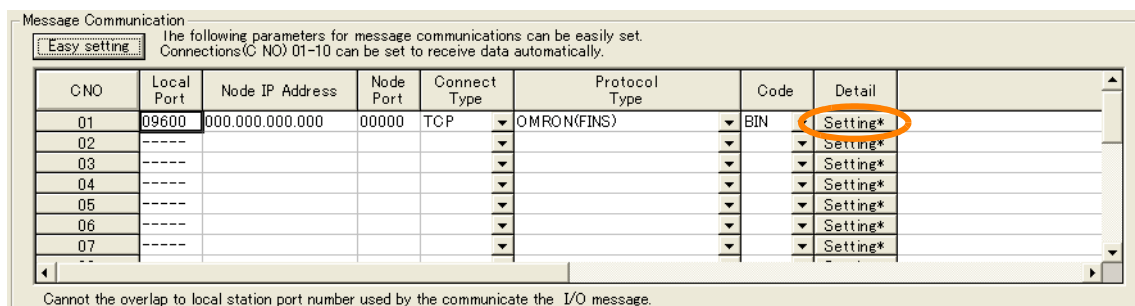

8. Select the [Disable] Option on the Automatically Reception Tab Page.

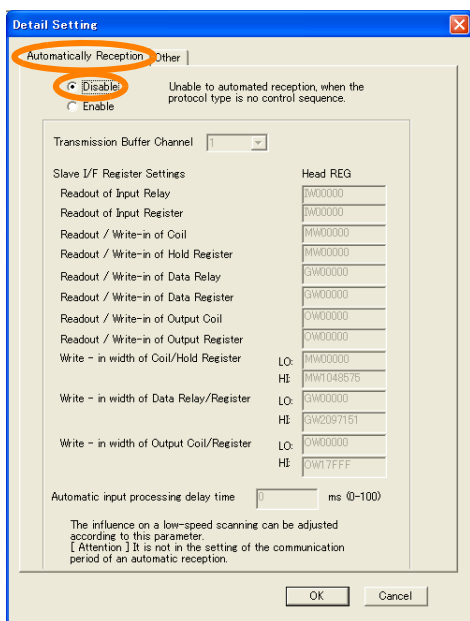

9. Click the Other Tab and enter "1" in the [Node Address] Box.

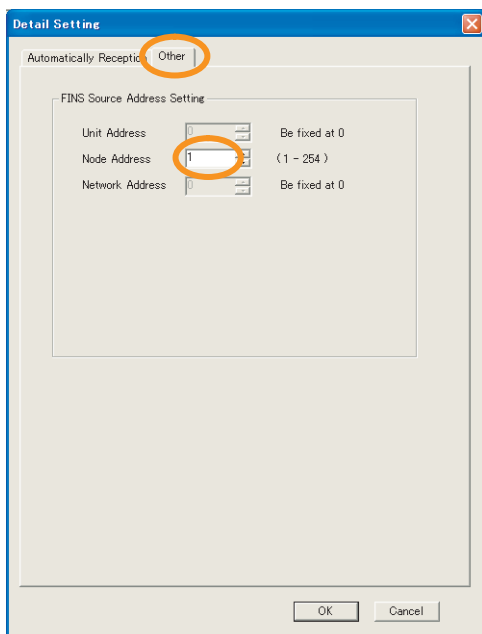

Note: 1. Specify a node address that is not in use by any other device on the same network.
 2. Changes made to the communications or connection parameters will become effective only after the changes have been saved to flash memory and the power supply has been cycled.

10. Create a ladder program for the MSG-RCVE function.

A ladder program example is shown below.

```

    0 0/- 2 IF 'After Low Scan Start, Only 1 Scan ON' == 'TRUE'
        LowScan.FirstScan == TRUE;

    1 1/- 2 clear all D registers
        SETW DW00000, D00000, 00200

    2 2/- 2 set for connection No. (PARAM10)
        EXPRESSION
        'DW00110'=1
        DW00110=1; //using connection 1

    3 3/- 2 set for offset (PARAM20 to PARAM35)
        EXPRESSION
        'DW00120'=0
        DW00120=0; //coil offset MB low (0)
        'DW00121'=0
        DW00121=0; //coil offset MB high (0)
        'DW00122'=0
        DW00122=0; //input relay offset IB low (0)
        'DW00123'=0
        DW00123=0; //input relay offset IB high (0)
        'DW00124'=0
        DW00124=0; //input register offset IW low (0)
        'DW00125'=0
        DW00125=0; //input register offset IW high (0)
        'DW00126'=0
        DW00126=0; //hold register offset MW low (0)
        'DW00127'=0
        DW00127=0; //hold register offset MW high (0)
        'DW00128'=0
        DW00128=0; //data relay offset GB low (0)
        'DW00129'=0
        DW00129=0; //data relay offset GB high (0)
        'DW00130'=0
        DW00130=0; //data register offset GW low (0)
        'DW00131'=0
        DW00131=0; //data register offset GW high (0)
        'DW00132'=0
        DW00132=0; //output coil offset OB low (0)
        'DW00133'=0
        DW00133=0; //output coil offset OB high (0)
        'DW00134'=0
        DW00134=0; //output register offset OW low (0)
        'DW00135'=0
        DW00135=0; //output register offset OW high (0)

    4 4/- 2 M writing range (PARAM36 to PARAM39)
        EXPRESSION
        'DW00136'=0x000
        DW00136=0x000; //M writing range LO low
        'DW00137'=0x000
        DW00137=0x000; //M writing range LO high
        'DW00138'=0xFFFF
        DW00138=0xFFFF; //M writing range HI low
        'DW00139'=0x000F
        DW00139=0x000F; //M writing range HI high

    5 5/- 2 G writing range (PARAM40 to PARAM43)
        EXPRESSION
        'DW00140'=0x000
        DW00140=0x000; //G writing range LO low
        'DW00141'=0x000
        DW00141=0x000; //G writing range LO high
        'DW00142'=0xFFFF
        DW00142=0xFFFF; //G writing range HI low
        'DW00143'=0x001F
        DW00143=0x001F; //G writing range HI high

    6 6/- 2 O writing range (PARAM44 to PARAM47)
        EXPRESSION
        'DW00144'=0x000
        DW00144=0x000; //O writing range LO low
        'DW00145'=0x000
        DW00145=0x000; //O writing range LO high
        'DW00146'=0x7FFF
        DW00146=0x7FFF; //O writing range HI low
        'DW00147'=0x0001
        DW00147=0x0001; //O writing range HI high

    7 7/- 2 END_IF
    
```

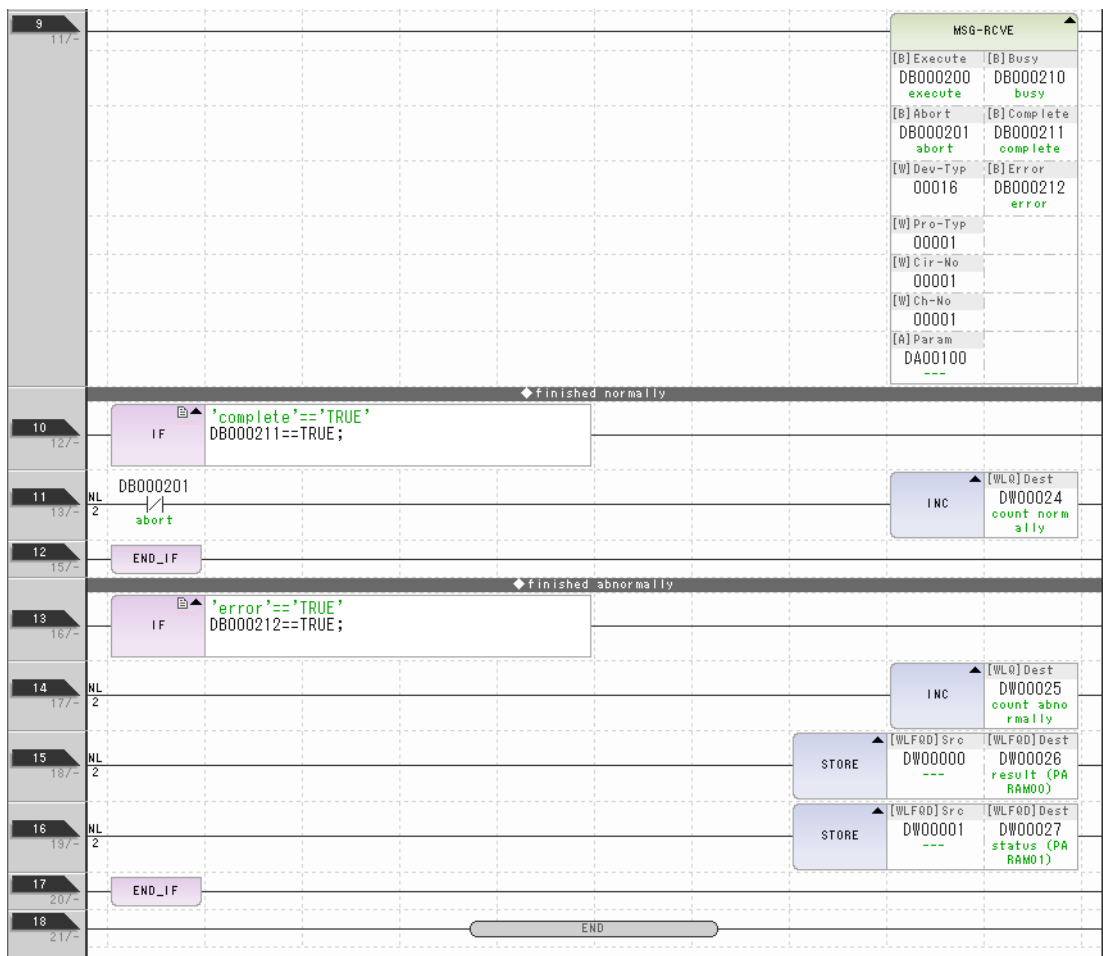

11. Save the data to flash memory.

This concludes the settings for using the MP3000 as a slave.

◆ Setting the Remote Device (OMRON PLC)

Use the following procedure to set up the OMRON CJ-series PLC.

Information The CJ Series is manufactured by OMRON Corporation. Contact OMRON Corporation for further information.

1. Set the node address of the Ethernet Unit. In this example, the node address is set to 02 hex.
2. Start the CX-Programmer.
3. Create a project.

4. Set the network parameters.

Parameter	Description
Broadcasting	As required.
FINS/UDP Port	As required.
FINS/TCP Port	Default (9,600)
TCP/IP Keep-alive	As required.
IP address	192.168.1.2
Subnet Mask	255.255.255.000
IP Address Conversion	Combined method
Baud Rate	Automatic detection
Dynamic Change the Target IP Addresses	As required.

Note: When using an OMRON PLC, set the node address of the Ethernet Unit so that it matches the last digit of the IP address (2 in the case of 192.168.001.002). If the node address does not match the last digit, an error may occur in the Ethernet Unit of the OMRON PLC.
When communicating with FINS/UDP, set the FINS/UDP port setting to the same number as the remote station port number of the MP3000.

5. Set the FINS/TCP connection parameters. Use the following settings for FINS/TCP connection number 1.

Note: The FINS/TCP connection settings are not required when communicating with FINS/UDP.

Parameter	Description
FINS/TCP Server/Client	Client
Target IP Address	192.168.1.1
Automatically Allocated FINS Node Address for Server	Do not set.
Keep-alive	As required.

6. Create routing tables if required.

Note: Specify an IP address that is not in use by any other device on the same network.
Check with your network administrator for unused IP addresses.

7. Create ladder programming for network transmissions.

To read data from a node on the network, use the RECV instruction. The following is an example of the settings for a RECV instruction.

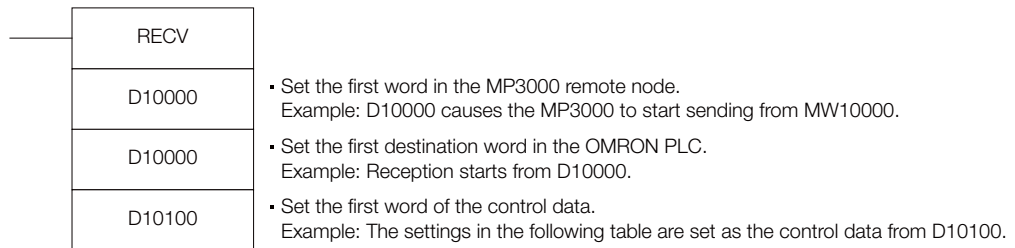

Word	Meaning	Meaning
D10100	0064 hex	Number of words to send = 100 words
D10101	0000 hex	Destination network address = 00 (local)
D10102	0100 hex	Destination node address = 1 Destination unit address = 00
D10103	0701 hex	Response = Required. Communications port number used = 7, Number of retries = 1
D10104	0014 hex	Response monitor time = 20 (2 seconds)

When using the RECV instruction, create any logic necessary to interlock with other processes and to adjust the timing of the execution.

Note: Refer to the following manual for information on ladder programming using the network communications instructions (SEND, RECV, and CMND).

- SYSMAC CS/CJ-series Ethernet Units Operation Manual from OMRON Corporation
- SYSMAC CS/CJ/NSJ-series Programmable Controllers Instructions Reference Manual from OMRON Corporation

This concludes the setup.

◆ Starting Communications

Use the following procedure to write the data in the hold registers in the MP3000 to the DM Area in the CPU Unit of the OMRON PLC.

1. Turn ON the power to the MP3000 to start receiving messages.

In the ladder programming example, the message receive function starts immediately after the scan starts in the MP3000. While the Machine Controller is operating, a normally ON coil is used to keep the message receive function executing.

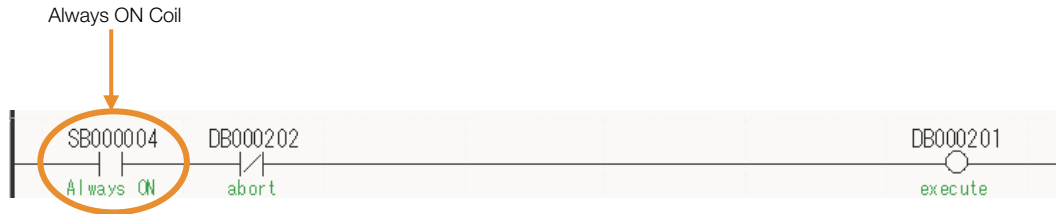

2. Start the message send operation on the OMRON PLC.

Note: The MP3000 will wait for the TCP connection after it starts execution of the MSG-RCVE function. Therefore, the power supply to the MP3000 must be turned ON before the power supply to the OMRON PLC.

4.5.3 Using I/O Message Communications with the MP3000 as the Master

This section describes how to communicate with an OMRON PLC by using I/O message communications.

FINS Commands

The FINS commands that are used with I/O message communications on the MP3000 are given below. Check that the command codes and I/O memory types that are listed in the following table are usable with the OMRON PLC slave.

Name	FINS Command Code (Hex)		I/O Memory Type (Hex)	Meaning
	MR	SR		
Reading data from an I/O memory area	01	01	B0	Reads CIO Area words.
			B1	Reads Work Area words.
			B2	Reads Holding Area words.
			B3	Reads Auxiliary Area words.
			82	Reads DM Area words.
Writing data to an I/O memory area	01	02	B0	Writes to CIO Area words.
			B1	Writes to Work Area words.
			B2	Writes to Holding Area words.
			B3	Writes to Auxiliary Area words.
			82	Writes to DM Area words.

I/O Memory Data Areas and Corresponding Registers in the MP3000

The following table shows the relationship between registers in the MP3000 and the I/O memory data areas.

When reading from or writing to the I/O memory in the OMRON PLC, the FINS commands for reading or writing are automatically generated by assigning I/O registers in the MP3000.

- **Writing**

Set the output register in the MP3000 as follows:

- Set the first address of the OW registers and the size of the data stored in the MP3000 that is to be written to the OMRON PLC.
- Set the first word to the first register address to write to in the OMRON PLC.

- **Reading**

Set the input registers in the MP3000 as follows:

- Set the first address of the IW registers and the size of the read data that is to be stored in the MP3000.
- Set the first word to the first register address to read from in the OMRON PLC.

Data Area Name	Data Type	Data Range		MP3000
		OMRON CPU Unit		
		Addresses	I/O Memory Addresses	
CIO Area	Word	0000 to 6143	000000 to 17FF00	Read: IW0000 to IW7FFF Write: OW0000 to OW7FFF
Work Area	Word	W000 to W511	00000 to 01FF00	
Holding Area	Word	H000 to H511	00000 to 01FF00	
Auxiliary Area	Word	A000 to A959	00000 to 03BF00	
DM Area	Word	D00000 to D32767	00000 to 7FFF00	

Note: Word: Specify word addresses.

Transfer Size

The following table lists the size of data that can be transferred using I/O message communications. Use the data size within the ranges that are listed in the following table according to the conditions of the OMRON PLC slave.

FINS Command Code (Hex)		I/O Memory Type (Hex)	Meaning	Data size
MR	SR			
01	01	B0	Reads CIO Area words.	1 to 999 words
		B1	Reads Work Area words.	1 to 512 words
		B2	Reads Holding Area words.	1 to 512 words
		B3	Reads Auxiliary Area words.	1 to 960 words
		82	Reads DM Area words.	1 to 999 words
01	02	B0	Writes to CIO Area words.	1 to 996 words
		B1	Writes to Work Area words.	1 to 512 words
		B2	Writes to Holding Area words.	1 to 512 words
		B3	Writes to Auxiliary Area words.	1 to 960 words
		82	Writes to DM Area words.	1 to 996 words

Setting Example

The following figure illustrates how the contents of the D02000 to D02199 in the DM Area in the CPU Unit of the OMRON PLC slave are read into the IW0100 to IW01C7 input registers in the MP3000 master.

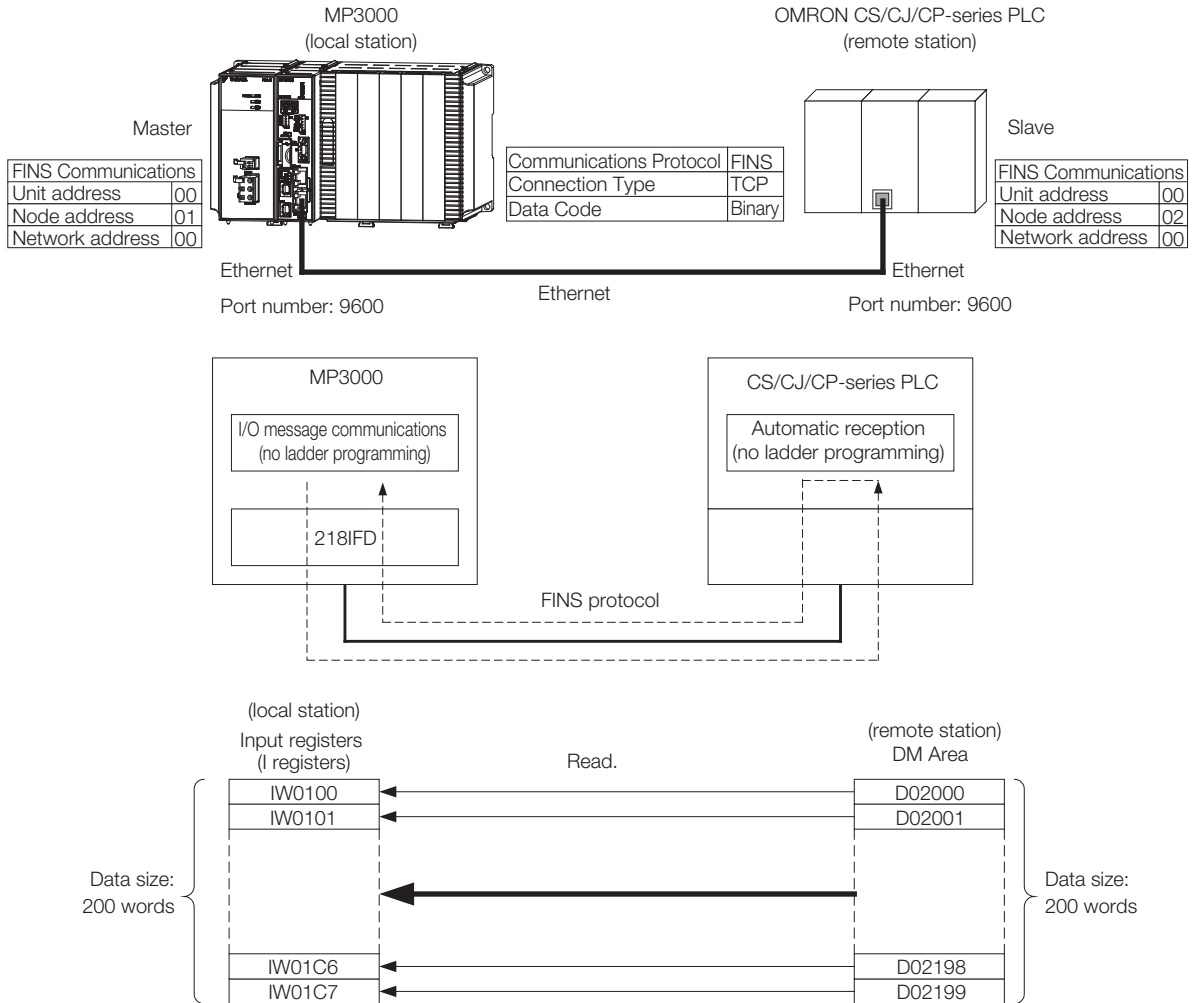

◆ MP3000 Setup

Use the following procedure to set up the MP3000.

Information If the communications parameters (IP address and subnet mask) have already been set, skip to step 3.

1. Double-click the cell for 218IFD in the Module Configuration Definition Tab Page.

Module	Function Module/Slave	Status	Circuit No./Axis Address		Motion Register	Register(Input/Output)		
			Start	cupied circ		Disabled	Start - End	Size
01 [CPU-302(32axes)] : ---								
00 CPU302(32)[-----]	01 CPU	----	----	----	----	----	----	----
	02 218IFD	----	0 Circuit No1	1	----	<input type="checkbox"/> Input <input type="checkbox"/> OutPut	0000 - 07FF[H]	2048
	03 SVC32	----	1 Circuit No1	1	8000 - 87FF[H]	<input type="checkbox"/> Input <input type="checkbox"/> OutPut	0800 - 0BFF[H]	1024
	04 SVR32	----	1 Circuit No3	1	9000 - 97FF[H]	----	----	----
	05 M-EXECUTOR	----	----	----	----	----	0C00 - 0C3F[H]	64
	06 -- UNDEFINED --	----	----	----	----	----	----	----
	07 -- UNDEFINED --	----	----	----	----	----	----	----
01 -- UNDEFINED --[-----]								
02 -- UNDEFINED --[-----]								
03 -- UNDEFINED --								
02 -- UNDEFINED --								
02 -- UNDEFINED --								
03 -- UNDEFINED --								
04 -- UNDEFINED --								

The 218IFD Detail Definition Dialog Box will be displayed.

2. Set the communications parameters.

Transmission Parameters: Status

Transmission Parameters

IP Address : 192 . 168 . 1 . 1 (0-255)

Subnet Mask : 255 . 255 . 255 . 0 (0-255)

Gateway IP Address : 0 . 0 . 0 . 0 (0-255)

Module Name Definition
Equipment name : CONTROLLER NAME

Detail Definition

- ① In the [IP Address] Boxes, enter the following address: 192.168.001.001.
- ② In the [Subnet Mask] Boxes, enter the following mask: 255.255.255.000.
- ③ In the [Gateway IP Address] Boxes, enter the following address: 000.000.000.000.

3. Select the [Enable] Option in the [I/O Message Communication] Area of the [Connection Parameter] Area.

I/O Message Communication

Disable

Enable

Easy setting It is possible to set easily that communicate the I/O message.

Data update timing Low Scan

Read/Write	Local Port	Node IP Address	Node Port	Connect Type	Protocol Type	Code	Detail
Read	----						Setting
Write	----						Setting

Head register number

input disable 0W00000 4 W <- Hold register(MW)

output disable 0W00000 4 W -> Hold register(MW)

data size 00000 4 W

Node equipment

4. Set the connection parameters.

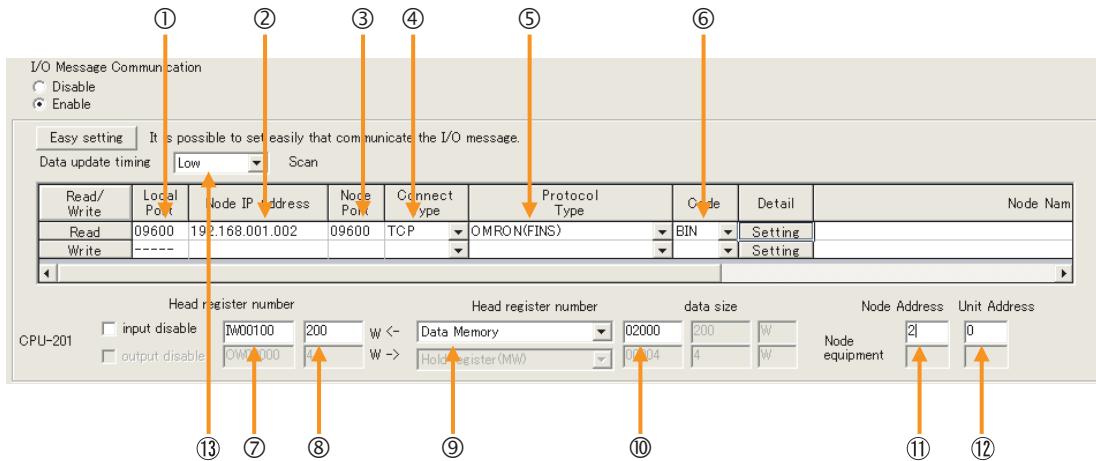

- ① Enter "9600" in the [Local Port] Box.
- ② Enter the following address for the remote device in the [Node IP Address] Box: 192.168.001.002.
- ③ Enter "9600" in the [Node Port] Box.
- ④ Select [TCP] in the [Connect Type] Box.
- ⑤ Select [OMRON (FINS)] in the [Protocol Type] Box.
- ⑥ Select [BIN] in the [Code] Box.
- ⑦ Enter "IW0100" in the [Head register number] Box as the read data destination.
- ⑧ Enter "200" in the next box as the size of data to read.
- ⑨ Select [Data Memory] as the I/O memory type in the [Head register number] box.
- ⑩ Enter "02000" as the first address in the remote device.
- ⑪ Enter "2" in the [Node Address] Box for the other device.
- ⑫ Enter "00" in the [Unit Address] Box for the other device.
- ⑬ Select [Low] in the [Data update timing] Box as the timing to update I/O data between the CPU Function Module and 218IFD.

Note: 1. In I/O message communications, a message is transmitted from separate ports if registers are both read and written. Therefore, the connected remote device must have two connections to receive both messages.
 If communicating with FINS/UDP, select [UDP] in the [Connect Type] Box.

2. The network address cannot be set from the MP3000. The network address is always 00 hex. This means that messages cannot be sent to nodes on another network.
 To reference registers in the CPU Unit of the OMRON PLC, enter "00" in the ⑫ [Unit Address] Box. "00" indicates the CPU Unit of the PLC at the specified node address.

3. The data update timing is the timing at which the CPU Function Module and 218IFD exchange data. Communications with the remote device are performed asynchronously. The data update timing therefore does not necessarily mean that the messages are sent to the remote device.

5. Double-click the [Setting] Button in the [Detail] Box.

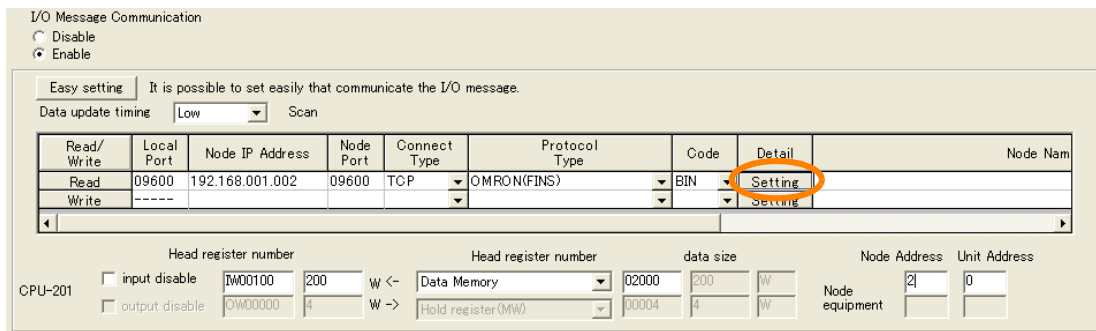

6. Enter "01" in the [Node Address] Box, and then click the [OK] Button.

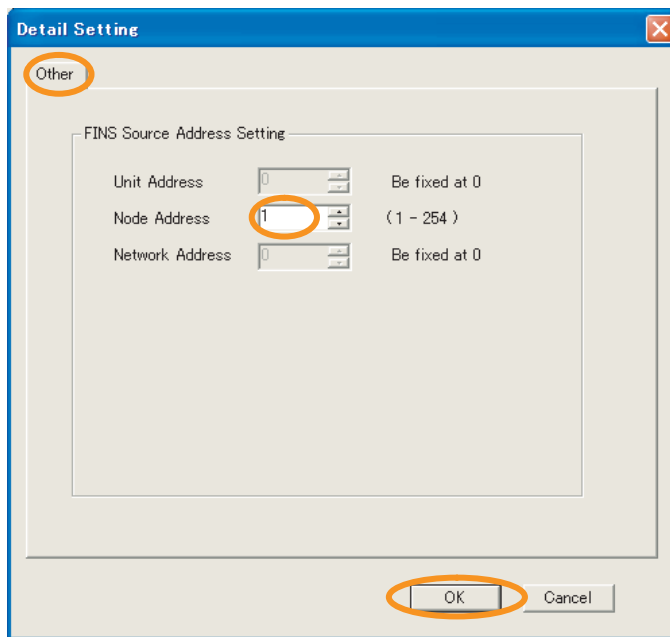

Note: 1. The unit address and network address of the MP3000 are always 00 hex.
2. The node address must be set for each connection. Specify a node address that is not in use by any other device on the same network.

7. Click the [OK] Button.
8. Save the data to flash memory.

Note: Changes made to the communications or connection parameters will become effective only after the changes have been saved to flash memory and the power supply has been cycled.

This concludes the settings for using the MP3000 as the master.

◆ Setting the Remote Device (OMRON PLC)

Use the following procedure to set up the OMRON CJ-series PLC.

Information The CJ Series is manufactured by OMRON Corporation.
Contact OMRON Corporation for further information.

1. Set the node address of the Ethernet Unit. In this example, the node address is set to 02 hex.
2. Start the CX-Programmer.
3. Create a project.
4. Set the network parameters.

Parameter	Description
Broadcasting	As required.
FINS/UDP Port	As required.
FINS/TCP Port	Default (9,600)
TCP/IP Keep-alive	As required.
IP Address	192.168.1.2
Subnet Mask	255.255.255.000
IP Address Conversion	Combined method
Baud Rate	Automatic detection
Dynamic Change the Target IP Addresses	As required.

Note: When using an OMRON PLC, set the node address of the Ethernet Unit so that it matches the last digit of the IP address (2 in the case of 192.168.001.002). If the node address does not match the last digit, an error may occur in the Ethernet Unit of the OMRON PLC.
When communicating with FINS/UDP, set the FINS/UDP port setting to the same number as the remote station port number of the MP3000.

5. Set the FINS/TCP connection parameters. Use the following settings for FINS/TCP connection number 1.

Note: The FINS/TCP connection settings are not required when communicating with FINS/UDP.

Parameter	Description
FINS/TCP Server/Client	Client
Target IP Address	192.168.1.1
Automatically Allocated FINS Node Address for Server	Do not set.
Keep-alive	As required.

6. Create routing tables if required.

Note: Specify an IP address that is not in use by any other device on the same network. Check with your network administrator for unused IP addresses.

This concludes the setup.

◆ Starting Communications

Use the following procedure to write the data in the DM Area in the CPU Unit of the OMRON PLC to the input registers in the MP3000.

1. Start the message receive operation on the OMRON PLC.

The system will automatically start the message reception operation. No further operation is required.

2. Turn ON the power to the MP3000 to start transmitting messages.

The system will automatically start the message transmission operation. No further operation is required.

Note: The MP3000 will establish the TCP connection when it starts execution of I/O message communications.

4.5.4 Using the MSG-SNDE Function with the MP3000 as the Master

This section describes how to communicate with an OMRON PLC by using the MSG-SNDE function.

I/O Memory Data Areas and Corresponding Registers in the MP3000

The following table shows the relationship between registers in the MP3000 and the I/O memory data areas.

A read or write command is automatically generated by specifying the address in the MP3000 that corresponds to the I/O memory to be read from or written to in the OMRON PLC.

Set PARAM14 and PARAM15 of the MSG-SNDE function to the register address in the MP3000 that corresponds to the address to read from or write to in the OMRON CPU Unit. Select whether to read or write by setting the function code in parameter PARAM12 for the MSG-SNDE function.

Example Writing Data into D10000
Set PARAM14 and PARAM15 to the MW10000 register in the MP3000 that corresponds to D10000, and set PARAM12 to 0B or 10 hex.

Example Reading Data from W511
Set PARAM14 and PARAM15 to the MB025590 register in the MP3000 that corresponds to W511, and set PARAM12 to 01 hex.

Information To access a relay, specify a bit address in PARAM14 and PARAM15.

Data Area Name	Data Type	Data Range		
		OMRON CPU Unit		MP3000
		Addresses	I/O Memory Addresses	
CIO Area	Word	000000 to 2047	000000 to 07FF00	Word notation: MW00000 to MW02047 Bit notation: MB000000 to MB02047F
Work Area	Word	W00000 to W511	00000 to 01FF00	Word notation: MW02048 to MW02559 Bit notation: MB020480 to MB02559F
Holding Area	Word	H00000 to H511	00000 to 01FF00	Word notation: MW02560 to MW03071 Bit notation: MB025600 to MB03071F
Auxiliary Area	Word	A00000 to A959	00000 to 03BF00	Word notation: MW03072 to MW04031 Bit notation: MB030720 to MB04031F
DM Area	Word	D00000 to D32767	00000 to 7FFF00	MW00000 to MW32767

Note: Word: Specify word addresses.

Transfer Size

The following table lists the size of data that can be transferred using the MSG-SNDE function. Use the data size within the ranges that are listed in the following table according to the conditions of the OMRON PLC slave.

The upper limit to the data size will also depend on the MEMOBUS function code that is specified in the MSG-SNDE function.

Refer to the following section for details on the data size parameter in the MSG-SNDE function.

 **◆ Data Size (PARAM17)** on page 4-107

FINS Command Code (Hex)		I/O Memory Type (Hex)	Meaning	Data size
MR	SR			
01	01	B0	Reads CIO Area words.	1 to 125 words (16 to 2,000 bits)
		B1	Reads Work Area words.	
		B2	Reads Holding Area words.	
		B3	Reads Auxiliary Area words.	
		82	Reads DM Area words.	1 to 999 words
01	02	B0	Writes to CIO Area words.	1 to 50 words (16 to 800 bits)
		B1	Writes to Work Area words.	
		B2	Writes to Holding Area words.	
		B3	Writes to Auxiliary Area words.	
		82	Writes to DM Area words.	1 to 996 words
01	04	82	Reads non-consecutive words from the DM Area.	1 to 167 words

Setting Example

The following figure illustrates how the contents of 800 bits (50 words) from the MB010000 to MB01049F hold registers in the MP3000 master are written to the I/O bits in CIO 1000 to CIO 1049 in the CPU Unit of the OMRON PLC slave.

On the MP3000, bits are written and read in word units. It is not possible to write or read less than whole words.

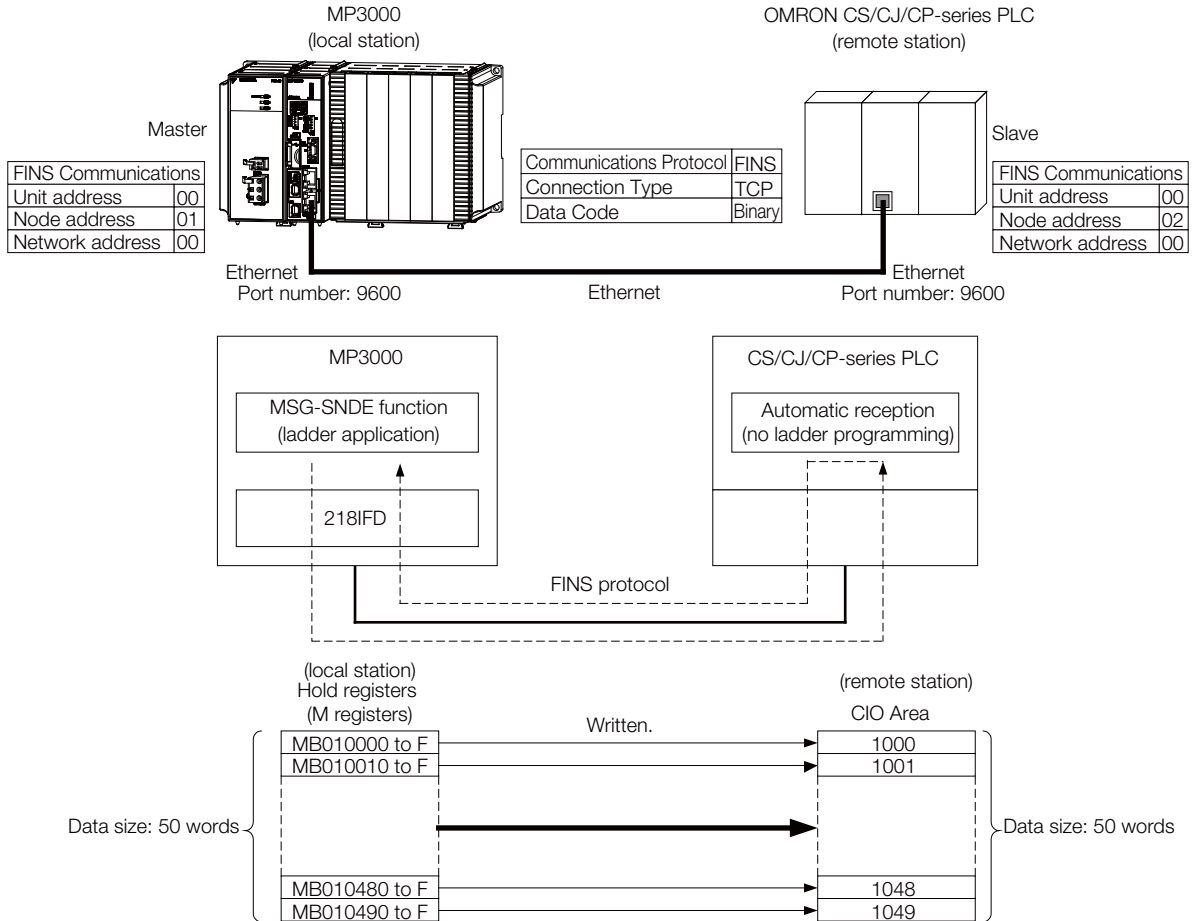

◆ MP3000 Setup

Use the following procedure to set up the MP3000.

Information If the communications parameters (IP address and subnet mask) have already been set, skip to step 3.

1. Double-click the cell for 218IFD in the Module Configuration Definition Tab Page.

Module	Function Module/Slave	Status	Circuit No./Axis Address		Motion Register	Register(Input/Output)		
			Start	Occupied circuit		Disabled	Start - End	Size
01 [CPU-302(32axes)] : ---								
01 CPU302(32) [---]	01 CPU	----	----	----	----	----	----	----
	02 218IFD	----	☐	Circuit No1	1	----	☑ Input ☑ OutPut	0000 - 07FF[H] 2048
	03 + SVC32	----	☑	Circuit No1	1	8000 - 87FF[H]	☑ Input ☑ OutPut	0800 - 0BFF[H] 1024
	04 + SVR32	----	☑	Circuit No3	1	9000 - 97FF[H]	----	----
	05 M-EXECUTOR	----	----	----	----	----	----	0C00 - 0C3F[H] 64
	06 -- UNDEFINED --	----	----	----	----	----	----	----
	07 -- UNDEFINED --	----	----	----	----	----	----	----
01 -- UNDEFINED -- [---]	----	----	----	----	----	----	----	
02 -- UNDEFINED -- [---]	----	----	----	----	----	----	----	
03 -- UNDEFINED -- [---]	----	----	----	----	----	----	----	
02 -- UNDEFINED --	----	----	----	----	----	----	----	
02 -- UNDEFINED --	----	----	----	----	----	----	----	
03 -- UNDEFINED --	----	----	----	----	----	----	----	
04 -- UNDEFINED --	----	----	----	----	----	----	----	

The 218IFD Detail Definition Dialog Box will be displayed.

2. Set the communications parameters.

Transmission Parameters: Status

Transmission Parameters

IP Address : 192 . 168 . 1 . 1 (0-255)

Subnet Mask : 255 . 255 . 255 . 0 (0-255)

Gateway IP Address : 0 . 0 . 0 . 0 (0-255)

Module Name Definition

Equipment name : CONTROLLER NAME

Detail Definition

- ① In the [IP Address] Boxes, enter the following address: 192.168.001.001.
- ② In the [Subnet Mask] Boxes, enter the following mask: 255.255.255.000.
- ③ In the [Gateway IP Address] Boxes, enter the following address: 000.000.000.000.

3. Click the [Easy setting] Button in the [Message Communication] Area in the [Connection Parameter] Area.

Connection Parameter

Message Communication

Easy setting

The following parameters for message communications can be easily set.
Connections(C NO) 01-10 can be set to receive data automatically.

CNO	Local Port	Node IP Address	Node Port	Connect Type	Protocol Type	Code	Detail
01	----						Setting*
02	----						Setting*
03	----						Setting*
04	----						Setting*
05	----						Setting*
06	----						Setting*
07	----						Setting*

The Message Communications Easy Setting Dialog Box will be displayed.

4. Set the connection parameters.

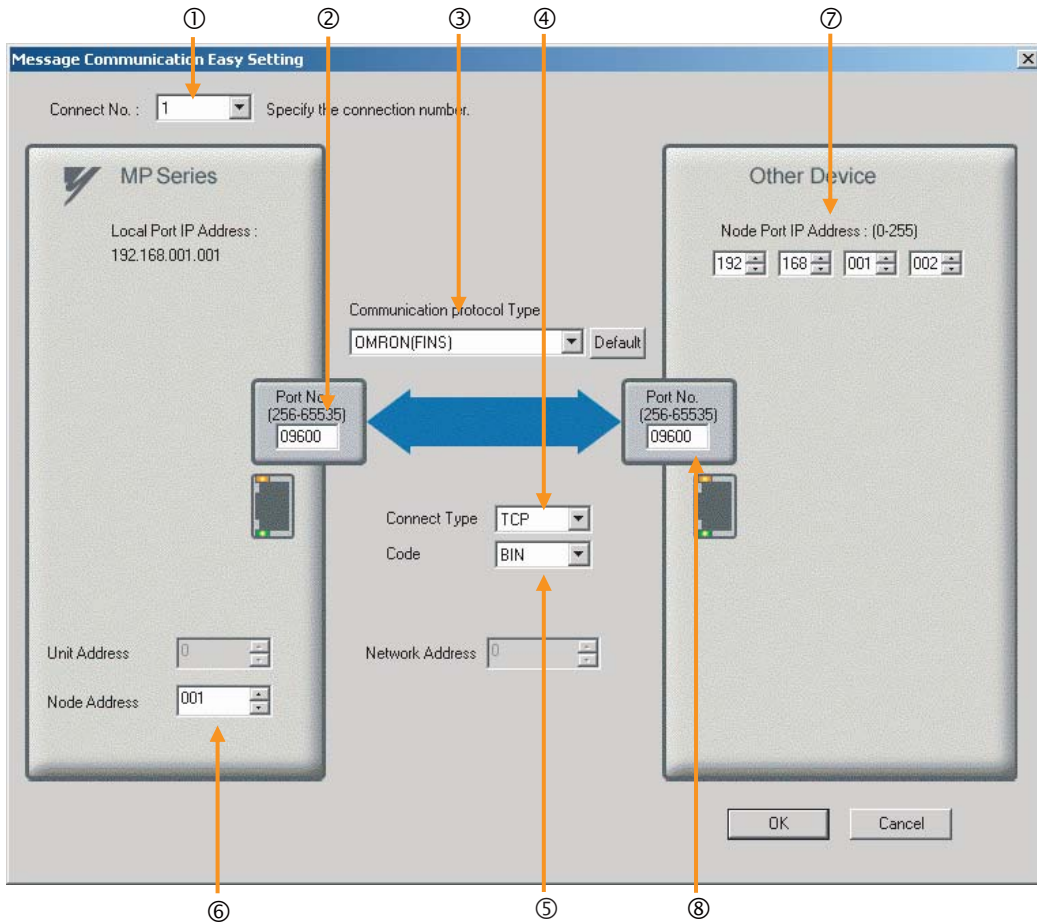

- ① Select [1] in the [Connect No.] Box.
- ② Enter "9600" in the [Port No.] Box for the MP-series Controller.
- ③ Select [OMRON (FINS)] in the [Communication Protocol Type] Box.
- ④ Select [TCP] in the [Connect Type] Box.
- ⑤ Select [BIN] in the [Code] Box.
- ⑥ Enter "001" in the [Node Address] Box for the MP-series Machine Controller.
- ⑦ Enter the following address in the [Node Port IP Address] Boxes for the other device:
192.168.001.002.
- ⑧ Enter "9600" in the [Port No.] Box for the other device.

Note: Disable automatic reception for any connection for which message functions (MSG-SNDE and MSG-RCVE) are used. If message functions are used while automatic reception is enabled, the communications will not function properly.
The unit address and network address of the MP-series Machine Controller are always 00 hex.
If communicating with FINS/UDP, select [UDP] in the [Connect Type] Box.

5. Click the [OK] Button.

6. Click the [Yes] Button in the Transmission Parameters Confirmation Dialog Box.

Note: If parameters have already been set for the same connection number and you click the [Yes] Button in the Transmission Parameters Confirmation Dialog Box, the settings will be overwritten by the parameters that are set in the Message Communications Easy Setting Dialog Box.

7. Check the settings and double-click the [Setting] Button in the [Detail] Column.

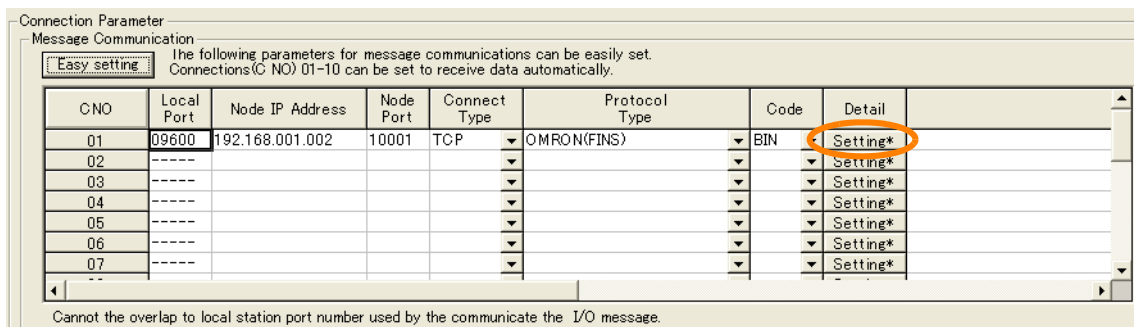

8. Click the [Disable] Option on the Automatically Reception Tab Page.

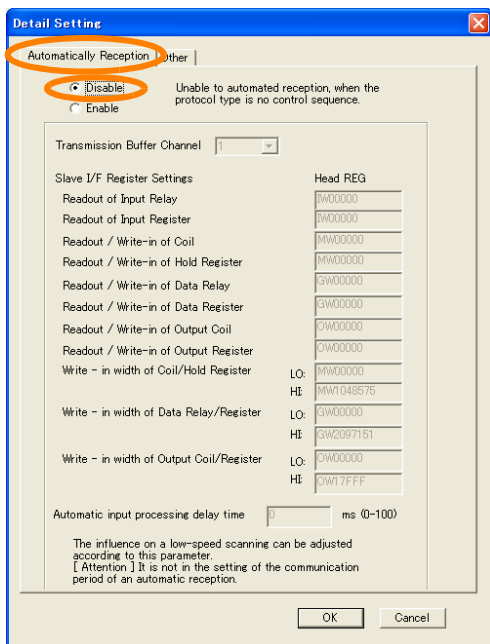

9. Click the Other Tab and enter "1" in the Node Address Box.

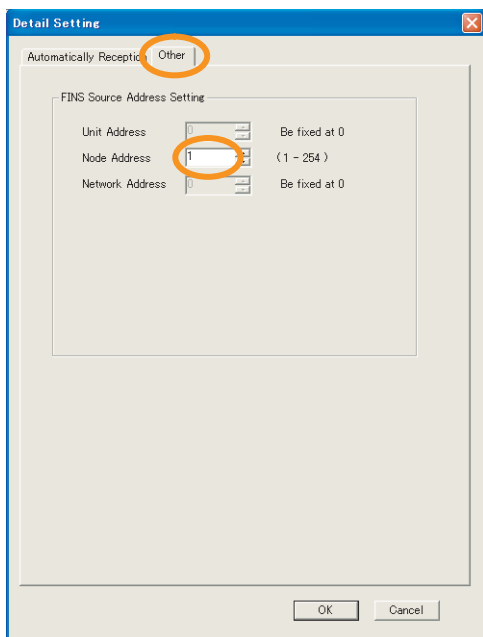

Note: 1. Specify a node address that is not in use by any other device on the same network.
2. Changes made to the communications or connection parameters will become effective only after the changes have been saved to flash memory and the power supply has been cycled.

10. Create a ladder program for the MSG-SNDE function.

A ladder program example is shown below.

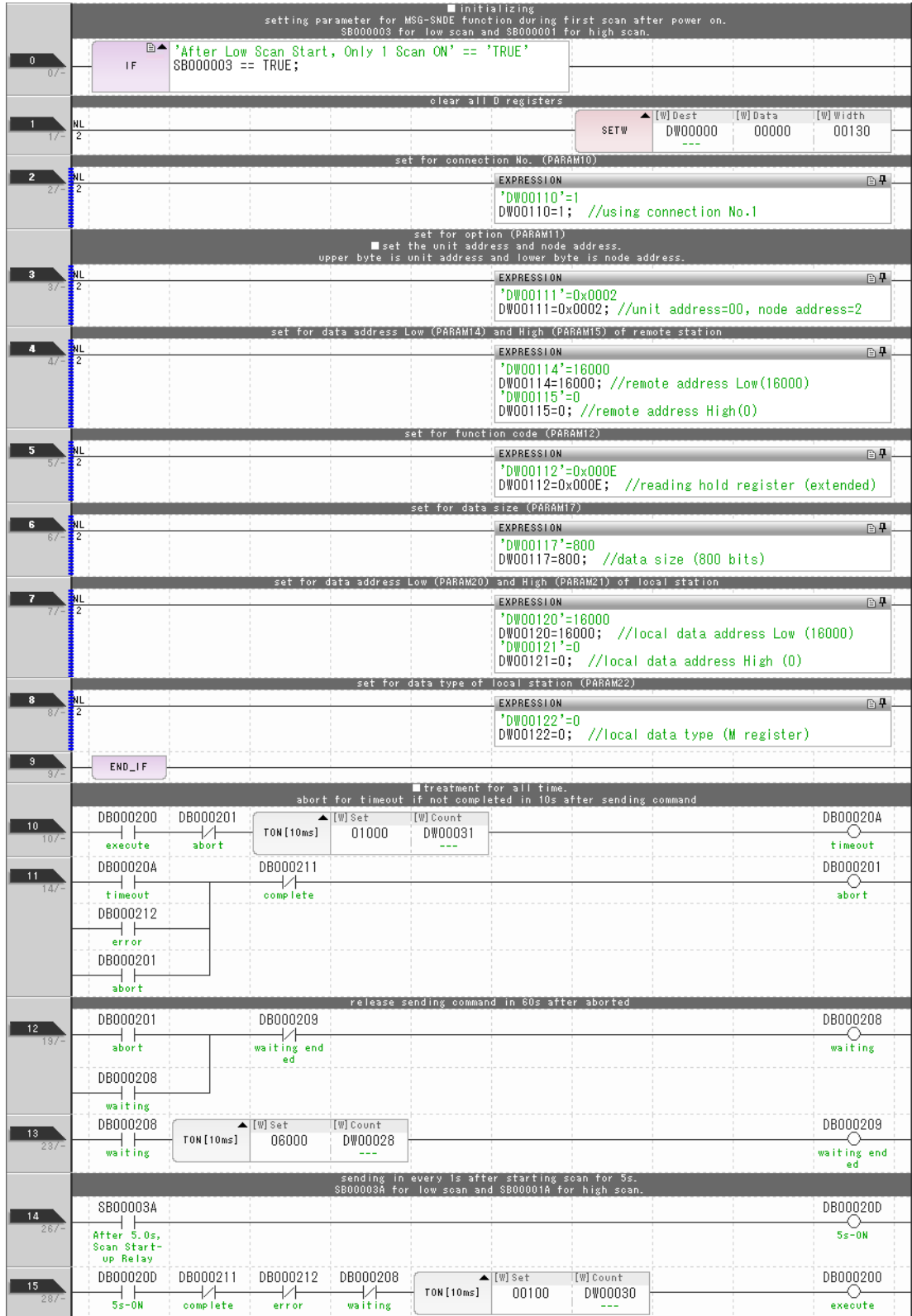

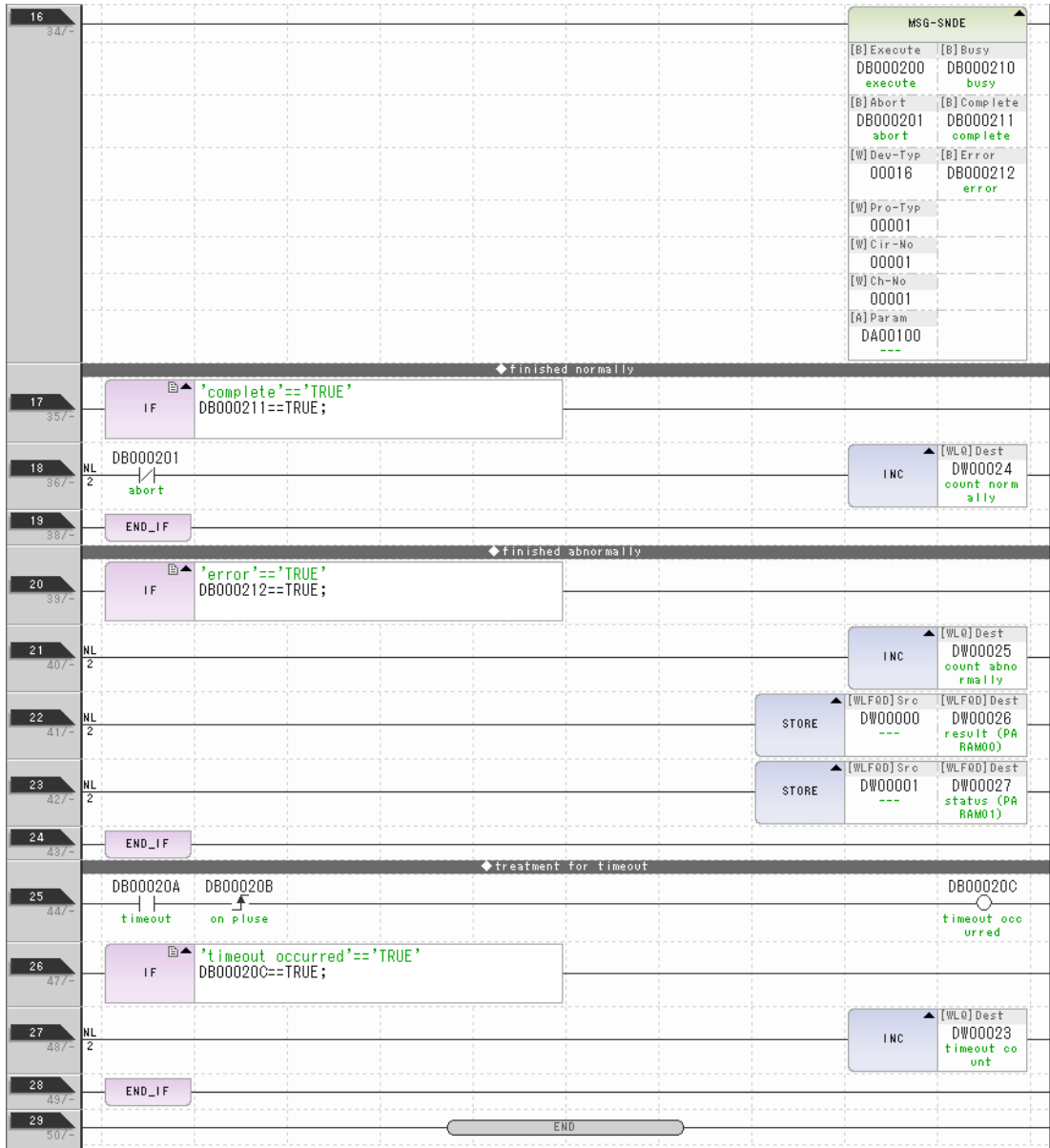

11. Save the data to flash memory.

This concludes the settings for using the MP3000 as the master.

◆ Setting the Remote Device (OMRON PLC)

Use the following procedure to set up the OMRON CJ-series PLC.

Information The CJ Series is manufactured by OMRON Corporation.
Contact OMRON Corporation for further information.

1. Set the node address of the Ethernet Unit. In this example, the node address is set to 02 hex.
2. Start the CX-Programmer.
3. Create a project.
4. Set the network parameters.

Parameter	Description
Broadcasting	As required.
FINS/UDP Port	As required.
FINS/TCP Port	Default (9,600)
TCP/IP Keep-alive	As required.
IP address	192.168.1.2
Subnet Mask	255.255.255.000
IP Address Conversion	Combined method
Baud Rate	Automatic detection
Dynamic Change the Target IP Addresses	As required.

Note: When using an OMRON PLC, set the node address of the Ethernet Unit so that it matches the last digit of the IP address (2 in the case of 192.168.001.002). If the node address does not match the last digit, an error may occur in the Ethernet Unit of the OMRON PLC.
When communicating with FINS/UDP, set the FINS/UDP port setting to the same number as the remote station port number of the MP3000.

5. Set the FINS/TCP connection parameters. Use the following settings for FINS/TCP connection number 1.

Note: The FINS/TCP connection settings are not required when communicating with FINS/UDP.

Parameter	Description
FINS/TCP Server/Client	Client
Target IP Address	192.168.1.1
Automatically Allocated FINS Node Address for Server	Do not set.
Keep-alive	As required.

6. Create routing tables if required.

Note: 1. Specify an IP address that is not in use by any other device on the same network.
Check with your network administrator for unused IP addresses.
2. If the MP3000 performs message communications using multiple connections, set up the same number of FINS/TCP connections in the OMRON PLC.
3. The FINS/TCP connection settings are not required when communicating with FINS/UDP.

This concludes the setup.

◆ Starting Communications

Use the following procedure to write the data in the hold registers in the MP3000 to the I/O bits in the CPU Unit of the OMRON PLC.

1. Start the message receive operation on the OMRON PLC.
The system will automatically start the message reception operation. No further operation is required.
2. Turn ON the power to the MP3000 to start transmitting messages.
The ladder program example is designed to turn ON the Execute Bit (DB000200) in the message send function after six seconds has elapsed from when the low-speed scan (or high-speed scan) starts. Thereafter, the message send function is executed every second by alternating the Execute Bit (DB000200) between OFF and ON each time the message send function completes execution normally or with an error.

Note: The MP3000 will establish the TCP connection when it starts execution of the MSG-SNDE function.

SB00003A: Turns ON 5 seconds after start.

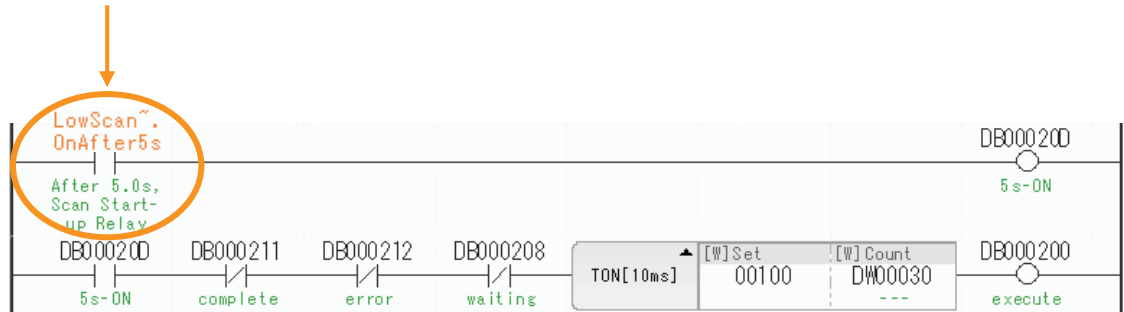

4.5.5 Routing

This section describes the restrictions that apply when sending and receiving I/O messages, and when using the MSG-SNDE and MSG-RCVE functions between the MP3000 and OMRON PLCs connected across different networks.

Using the MP3000 as the Master

When the MP3000 master sends messages using I/O message communications or the MSG-SNDE function, the destination node must be connected to the local network. A node connected to another network cannot be specified as the destination.

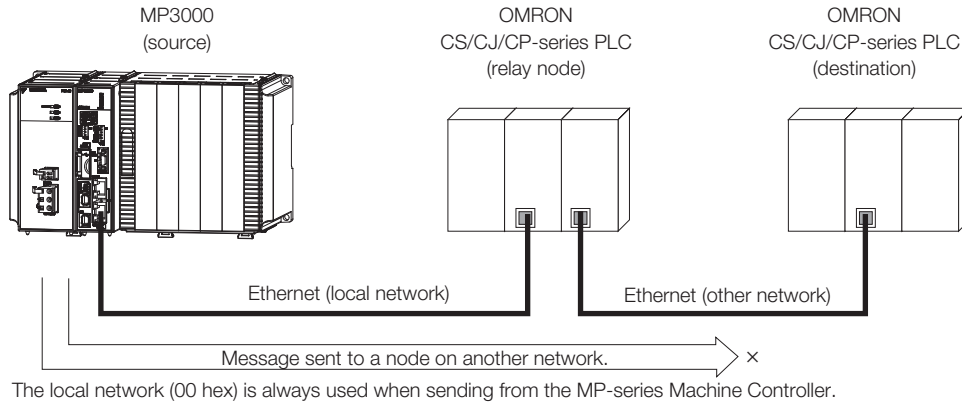

Using the MP3000 as a Slave

When the MP3000 acts as a slave and uses automatic reception or the MSG-RCVE function to receive messages that are routed, it can also receive messages from a node on another network. The MP3000 slave can also return responses to the source.

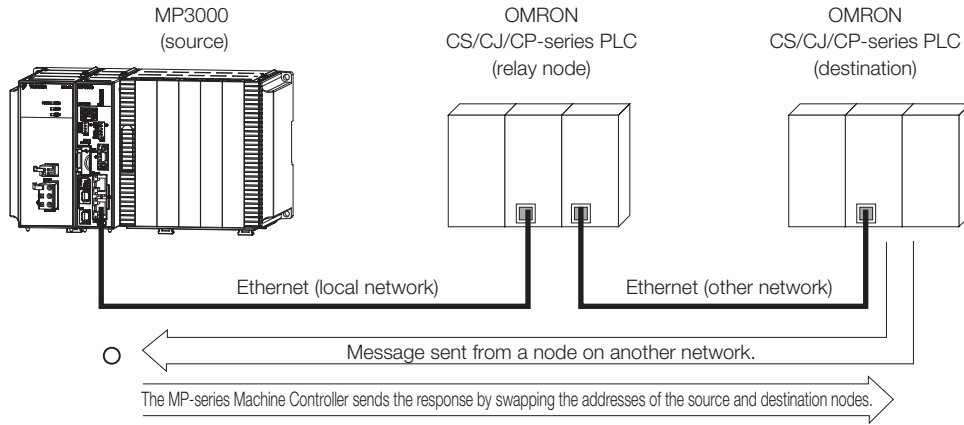

Using the MP3000 as a Router

The MP3000 cannot route messages between different networks.

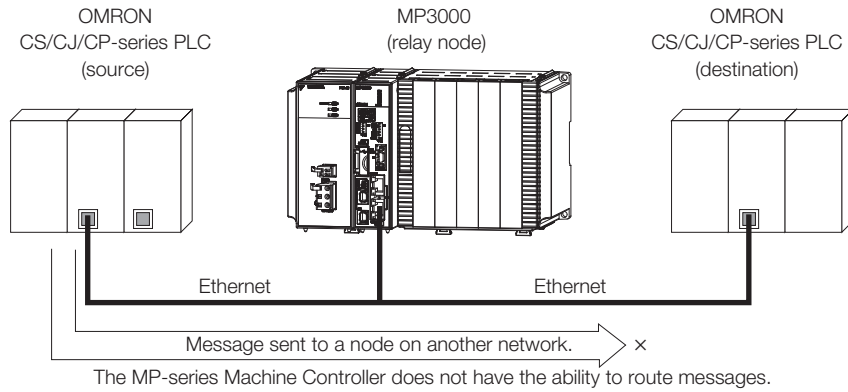

4.5.6 Message Functions

The message functions are used in user communications applications for the FINS protocol. You can send and receive message data by setting the necessary input items and parameters for the message functions. Message communications using the FINS protocol can be performed with the same settings as those used for MEMOBUS messages.

Inputs and Outputs for the MSG-SNDE Function

I/O Definitions	No.	Name	I/O Designation	Meaning	Description
Input Items	1	Execute	B-VAL	Executes the transmission.	Specify the bit to use to execute the message transmission. When the Execute Bit turns ON, the message will be sent. Keep the Execute Bit ON until the Complete or Error Bit turns ON. To send another message, turn OFF the Execute Bit for at least one scan and then turn it ON again.
	2	Abort	B-VAL	Forces the transmission to end.	Specify the bit to use to abort the message transmission. When the Abort Bit turns ON, the message transmission will be stopped unconditionally. The Abort Bit takes precedence over the Execute Bit.
	3	Dev-Typ	I-REG	Communications device type	Specify the type code of the communications device. 218IFB, 218IFD = 16
	4	Pro-Typ	I-REG	Communications protocol	Specify the type code of the communications protocol. 1: MEMOBUS Select this protocol when using the FINS protocol. MEMOBUS is automatically converted to the FINS protocol inside the 218IFD. 2: No-protocol communications 1 (unit: words) Not used for the FINS protocol. 3: No-protocol communications 2 (unit: bytes) Not used for the FINS protocol.
	5	Cir-No	I-REG	Circuit number	Specify the circuit number for the communications device. Specify the same circuit number as displayed in the MPE720 Module Configuration Definition Tab Page. 218IFB, 218IFD = 1 to 8
	6	Ch-No	I-REG	Communications buffer channel number	Specify the channel number of the communications buffer. You can specify any channel number provided it is within the valid range. When executing more than one function at the same time, do not use the same channel number for the same connection. You can use the same channel number as long as multiple functions are not executed at the same time. 218IFB, 218IFD = 1 to 10
	7	Param	Address Inputs	Parameter list first address (MA, DA)	Specify the first address of the parameter list. A total of 29 words starting from the specified first word are automatically used for the parameter list. The parameter list is used by inputting function codes and relevant parameter data. It is also where the process results and status are output.









Continued on next page.

Continued from previous page.

I/O Definitions	No.	Name	I/O Designation	Meaning	Description
Output Items	1	Busy	B-VAL	Processing.	Specify the bit that shows that the message transmission is in progress. The Busy Bit is ON while a message transmission or abort is in progress. Keep the Execute Bit or Abort Bit turned ON while the Busy Bit is ON.
	2	Complete	B-VAL	Process completed.	Specify the bit that shows when the message transmission has been completed. The Complete Bit turns ON only for one scan when message transmission or forced abort processing has been completed normally.
	3	Error	B-VAL	Error occurred.	Specify the bit that shows if an error occurred when sending the message. When an error occurs, the Error Bit will turn ON only for one scan. Refer to the following section for an example of a timing chart for when an error occurs.  ◆ Error on page 2-8













MSG-SNDE Function Parameters

The following table describes the contents of the addresses specified by the PARAM input parameter to the MSG-SNDE function.

No.	I/O	Meaning	Description	Reference Page
00	Out-puts	Processing Result	Gives the processing status.	 ◆ Processing Result (PARAM00) on page 2-9
01		Status	Gives the status of the current function.	 ◆ Status (PARAM01) on page 2-10
02		Detail Error Code, Lower Word	Gives the details of an error.	 ◆ Detail Error Code (PARAM02 and PARAM03) on page 4-154
03				
04		Status 1	Gives the communications status.	 ◆ Status 1 (PARAM04) on page 2-12
05		Status 2	Gives status information on the most recent error.	 ◆ Status 2 (PARAM05) on page 2-12
06		Status 3	Gives the information of the send pass counter.	 ◆ Status 3 (PARAM06) on page 2-12
07		Status 4	Gives the information of the receive pass counter.	 ◆ Status 4 (PARAM07) on page 2-12
08		Status 5	Gives the information of the error counter.	 ◆ Status 5 (PARAM08) on page 2-13
09	Status 6	Not used for the FINS protocol.	—	

Continued on next page.

Continued from previous page.

No.	I/O	Meaning	Description	Reference Page
10	Inputs	Connection Number	Sets the connection number used to determine the remote station.	 ◆ <i>Connection Number (PARAM10)</i> on page 2-13
11		Option	Sets the remote node address.	 ◆ <i>Options (PARAM11)</i> on page 4-154
12		Function Code	Sets the code of the function in the FINS protocol.	 ◆ <i>Function Code (PARAM12)</i> on page 4-155
13		Reserved for system.	This parameter is used by the system. Do not change the value of this parameter from a user program or by any other means.	 ◆ <i>Reserved for System (PARAM13)</i> on page 2-14
14		Remote Station Data Address, Lower Word	Sets the data address to read/write at the remote station. (Use word addresses for registers, bit addresses for relays or coils.)	 ◆ <i>Remote Station Data Address (PARAM14 and PARAM15)</i> on page 4-155
15		Remote Station Data Address, Upper Word		
16		Remote Station Register Type	Not used for the FINS protocol.	–
17		Data Size	Sets the size of the data to read/write. (Use word sizes for registers, bit sizes for relays or coils.)	 ◆ <i>Data Size (PARAM17)</i> on page 4-156
18		Remote CPU Module Number	Not used for the FINS protocol.	–
19		Reserved for system.	This parameter is used by the system. Do not change the value of this parameter from a user program or by any other means.	 ◆ <i>Reserved for System (PARAM19)</i> on page 2-17
20		Local Station Data Address, Lower Word	Sets the data address to store read/write data in the local station. (Use word addresses for registers, bit addresses for relays or coils.)	 ◆ <i>Local Station Data Address (PARAM20 and PARAM21)</i> on page 2-18
21		Local Station Data Address, Upper Word		
22		Local Station Register Type	Sets the register type of the read/write data to store in the local station.	 ◆ <i>Local Station Register Type (PARAM22)</i> on page 4-156
23		Reserved for system.	This parameter is used by the system. Do not change the value of this parameter from a user program or by any other means.	 ◆ <i>Reserved for System (PARAM23)</i> on page 2-19
24	–	For system use	This parameter contains the channel number of the communications buffer that is currently in use. A user program must set this parameter to 0 on the first scan after startup. Thereafter, do not change the value of this parameter from a user program or by any other means because it will be used by the system.	 ◆ <i>Reserved for System (PARAM24)</i> on page 2-19
25	–	Reserved for system.	These parameters are used by the system. Do not change the value of these parameters from a user program or by any other means.	 ◆ <i>Reserved for System (PARAM25 to PARAM28)</i> on page 2-19
26	–	Reserved for system.		
27	–	Reserved for system.		
28	–	Reserved for system.		

◆ Detail Error Code (PARAM02 and PARAM03)

These parameters give the detail error code.

Processing Result Value (PARAM00)	Detail Error Code	Error Description	Description
81□□ hex	1	Function code error	An unused function code was sent or received. Check PARAM12 (Function Code).
82□□ hex	2	Address setting error	The setting of one or more of the following parameters is out of range. Check the settings. PARAM14 and PARAM15 (Remote Station Data Address) PARAM20 and PARAM21 (Local Station Data Address)
83□□ hex	3	Data size error	The data size for sending or receiving is out of range. Check PARAM17 (Data Size).
84□□ hex	4	Circuit number setting error	The circuit number is out of range. Check the circuit number (Cir-No) in the MSG-SNDE function.
85□□ hex	5	Channel number setting error	The channel number for the communications buffer is out of range. Check the communications buffer channel number (Ch-No) in the MSG-SNDE function.
86□□ hex	6	Connection number error	The connection number is out of range. Check PARAM10 (Connection Number).
88□□ hex	8	Communications device error	An error response was received from the communications device. Check the connections to the device. Also check to see if the remote device is ready to communicate.
89□□ hex	9	Device select error	A device that cannot be used was selected. Check the communications device type (Dev-Typ) in the MSG-SNDE function.
C245 hex	–	Local station register type error	The register type for the local station is out of range. Check PARAM22 (Local Station Register Type).
8072 hex to C072 hex		Remote device error*	An error response was received from the remote station. Check the error code and remove the cause.

* An error response received from the remote device will be formatted in PARAM00 (Processing Result) as follows.

Processing Result (PARAM00): □□72 hex (where □□ is the error code)

□□ contains the sum of the completion code sent from the OMRON PLC and 80 hex.

Refer to the following manual for details on completion codes.

📖 CS/CJ/CP/NS Series Communications Commands Reference Manual from OMRON Corporation

◆ Options (PARAM11)

The upper byte of this parameter sets the unit address, and the lower byte sets the remote node address.

The valid setting range is given in the following table.

Option	Address Number	Description
XXYY hex	XX: Unit address	Sets the remote unit address.
	YY: Node address	Sets the remote node address. Sets the remote node address from 1 to FE hex (1 to 254).

Note: 1. The node address for the MP3000 is set with the Connection Parameter setting in the Module Detail Definition Dialog Box.

2. The MP3000 unit address is always 00 hex.

◆ Function Code (PARAM12)

Set the function code to send.

You can use the functions that are registered to the function codes.

MEMOBUS Function Code	FINS Command Code			Target Data Type	Function
	MR	SR	I/O Memory Type		
01 hex	01 hex	01 hex	B0 hex	W	Reads CIO Area words.
			B1 hex	W	Reads Work Area words.
			B2 hex	W	Reads Holding Area words.
			B3 hex	W	Reads Auxiliary Area words.
03 or 09 hex	01 hex	01 hex	82 hex	W	Reads DM Area words.
0F hex	01 hex	02 hex	B0 hex	W	Writes to CIO Area words.
			B1 hex	W	Writes to Work Area words.
			B2 hex	W	Writes to Holding Area words.
			B3 hex	W	Writes to Auxiliary Area words.
0B or 10 hex	01 hex	02 hex	82 hex	W	Writes to DM Area words.
0D hex	01 hex	04 hex	82 hex	W	Reads non-consecutive words from the DM Area.

Note: W: Word (channel) data

◆ Remote Station Data Address (PARAM14 and PARAM15)

Set the first address for data in the remote station.

Enter the first address as a decimal or hexadecimal number.

Example If the first address is MW01000, enter “1000” (decimal) or “3E8” (hexadecimal).

The applicable function codes and valid range of data addresses depend on the device type and device range of the OMRON PLC.

Table 4.16 Bit Conversion Table

Data Area	Address Range	Notation	Function Code	Data Address Setting Range	Corresponding Register Addresses
CIO Area	0000 to 2047	Decimal	01 and 0F hex: Coils	0 to 32767	MB000000 to MB02047F
Work Area	W000 to W511	Decimal	01 and 0F hex: Coils	32768 to 40959	MB020480 to MB02559F
Holding Area	H0000 to H51115	Decimal	01 and 0F hex: Coils	40960 to 49151	MB025600 to MB03071F
Auxiliary Area	A000 to A447 (read only) A448 to A959 (read/write)	Decimal	01 and 0F hex: Coils	49152 to 56319 56320 to 64511	MB030720 to MB03519F MB035200 to MB04031F

Table 4.17 DM Area Conversion Table

Data Area	Address Range	Notation	Function Code	Data Address Setting Range	Corresponding Register Addresses
DM Area	D00000 to D32767	Decimal	03, 09, 0B, 0D, and 10 hex: Hold registers	0 to 32767	MW00000 to MW32767

Note: 1. Even if addresses are within the given address range, they may exceed the range of the device area depending on the model of the OMRON PLC.
Refer to the following manual for details.

 OMRON PLC manuals

2. The corresponding register address in the MP3000 can be adjusted by using the offset setting of the MSG-SNDE function.

◆ Data Size (PARAM17)

Set the data size for the read/write request as the number of bits or words.

Be sure that the last data address that is determined by the offset, data address, and data size does not exceed the valid data address range.

The range that is allowed for the data size depends on the function code and data area.

MEMOBUS Function Code	FINS Command Code			Function	Data Size Setting Range
	MR	SR	I/O Memory Type		
01 hex	01 hex	01 hex	B0 hex	Reads CIO Area words.	16 to 2,000 bits
			B1 hex	Reads Work Area words.	16 to 2,000 bits
			B2 hex	Reads Holding Area words.	16 to 2,000 bits
01 hex	01 hex	01 hex	B3 hex	Reads Auxiliary Area words.	16 to 2,000 bits
03 hex	01 hex	01 hex	82 hex	Reads DM Area words.	1 to 125 words
09 hex	01 hex	01 hex	82 hex	Reads DM Area words.	1 to 999 words
0F hex	01 hex	02 hex	B0 hex	Writes to CIO Area words.	16 to 800 bits
			B1 hex	Writes to Work Area words.	16 to 800 bits
			B2 hex	Writes to Holding Area words.	16 to 800 bits
			B3 hex	Writes to Auxiliary Area words.	16 to 800 bits
0B hex	01 hex	02 hex	82 hex	Writes to DM Area words.	1 to 996 words
10 hex	01 hex	02 hex	82 hex	Writes to DM Area words.	1 to 100 words
0D hex	01 hex	04 hex	82 hex	Reads non-consecutive words from the DM Area.	1 to 167 words

Note: Bits are read and written in words. The data size is specified in units of 16 bits (16, 32, 48, ...).

◆ Local Station Register Type (PARAM22)

Set the register type of the read data destination or write data source in the MP3000.

Register Type Value	Type	Remarks
0	M	Sets the target data type to MB for bits and MW for words.
1	G	Sets the target data type to GB for bits and GW for words.
2	I	Sets the target data type to IB for bits and IW for words.
3	O	Sets the target data type to OB for bits and OW for words.
4	S	Sets the target data type to SB for bits and SW for words.
5 or higher	-	Not used for the FINS protocol.

The register types that can be used depend on whether you are reading or writing.

The following table lists the combinations of register types.

Function Code	Applicable Register Types
01, 03, or 09 hex	M, G, or O
0B, 0F, or 10 hex	M, G, I, O, or S
0D hex	M

Inputs and Outputs for the MSG-RCVE Function

I/O Definitions	No.	Name	I/O Designation	Meaning	Description
Input Items	1	Execute	B-VAL	Executes the transmission.	Specify the bit to use to execute the message transmission. When the Execute Bit turns ON, the message will be sent. Keep the Execute Bit ON until the Complete or Error Bit turns ON. To send another message, turn OFF the Execute Bit for at least one scan and then turn it ON again.
	2	Abort	B-VAL	Forces the transmission to end.	Specify the bit to use to abort the message transmission. When the Abort Bit turns ON, the message transmission will be stopped unconditionally. The Abort Bit takes precedence over the Execute Bit.
	3	Dev-Typ	I-REG	Communications device type	Specify the type code of the communications device. 218IFB, 218IFD = 16
	4	Pro-Typ	I-REG	Communications protocol	Specify the type code of the communications protocol. 1: MEMOBUS Select this protocol when using the FINS protocol. MEMOBUS is automatically converted to the FINS protocol inside the 218IFD. 2: No-protocol communications 1 (unit: words) Not used for the FINS protocol. 3: No-protocol communications 2 (unit: bytes) Not used for the FINS protocol.
	5	Cir-No	I-REG	Circuit number	Specify the circuit number for the communications device. Specify the same circuit number as displayed in the MPE720 Module Configuration Definition Tab Page. 218IFB, 218IFD = 1 to 8
	6	Ch-No	I-REG	Communications buffer channel number	Specify the channel number of the communications buffer. You can specify any channel number provided it is within the valid range. When executing more than one function at the same time, do not use the same channel number for the same connection. You can use the same channel number as long as multiple functions are not executed at the same time. 218IFB, 218IFD = 1 to 10
	7	Param	Address Inputs	Parameter list first address (MA, DA)	Specify the first address of the parameter list. A total of 52 words starting from the specified first word are automatically used for the parameter list. The parameter list is used by inputting function codes and relevant parameter data. It is also where the process results and status are output.











Continued on next page.

Continued from previous page.

I/O Definitions	No.	Name	I/O Designation	Meaning	Description
Output Items	1	Busy	B-VAL	Processing.	Specify the bit that shows that the message transmission is in progress. The Busy Bit is ON while a message transmission or abort is in progress. Keep the Execute Bit or Abort Bit turned ON while the Busy Bit is ON.
	2	Complete	B-VAL	Process completed.	Specify the bit that shows when the message transmission has been completed. The Complete Bit turns ON only for one scan when message transmission or forced abort processing has been completed normally.
	3	Error	B-VAL	Error occurred.	Specify the bit that shows if an error occurred when sending the message. When an error occurs, the Error Bit will turn ON only for one scan. Refer to the following section for an example of a timing chart for when an error occurs.  ◆ Error on page 2-23















MSG-RCVE Function Parameters

The following table describes the contents of the addresses specified by the PARAM input parameter to the MSG-RCVE function.

No.	I/O	Meaning	Description	Reference Page
00	Out-puts	Processing Result	Gives the processing status.	 ◆ Processing Result (PARAM00) on page 2-25
01		Status	Gives the status of the current function.	 ◆ Status (PARAM01) on page 2-25
02		Detail Error Code, Lower Word	Gives the details of an error.	 ◆ Detail Error Code (PARAM02 and PARAM03) on page 4-161
03				
04		Status 1	Gives the communications status.	 ◆ Status 1 (PARAM04) on page 2-27
05		Status 2	Gives status information on the most recent error.	 ◆ Status 2 (PARAM05) on page 2-28
06		Status 3	Gives the information of the send pass counter.	 ◆ Status 3 (PARAM06) on page 2-28
07		Status 4	Gives the information of the receive pass counter.	 ◆ Status 4 (PARAM07) on page 2-28
08		Status 5	Gives the information of the error counter.	 ◆ Status 5 (PARAM08) on page 2-28
09		Status 6	Not used for the FINS protocol.	–
10	Input	Connection Number	Sets the connection number used to determine the remote station.	 ◆ Connection Number (PARAM10) on page 2-29
11	I/O	Option	Not used for the FINS protocol.	–
12	Out-put	Function Code	Gives the function code requested by the remote station.	 ◆ Detail Error Code (PARAM02 and PARAM03) on page 4-161
13	I/O	Reserved for system.	This parameter is used by the system. Do not change the value of this parameter from a user program or by any other means.	 ◆ Reserved for System (PARAM13) on page 2-30







Continued on next page.

Continued from previous page.

No.	I/O	Meaning	Description	Reference Page
14	Out-puts	Data Address, Lower Word	Gives the first address of the data that was requested by the remote station.	 ◆ <i>Data Address (PARAM14 and PARAM15) on page 4-162</i>
15		Data Address, Upper Word		
16		Register Types	Gives the register type that was requested by the remote station.	 ◆ <i>Register Type (PARAM16) on page 2-31</i>
17		Data Size	Gives the data size that was requested by the remote station.	 ◆ <i>Data Size (PARAM17) on page 2-31</i>
18		Remote CPU Module Number	Not used for the FINS protocol.	–
19	I/O	Reserved for system.	This parameter is used by the system. Do not change the value of this parameter from a user program or by any other means.	 ◆ <i>Reserved for System (PARAM19) on page 2-31</i>
20	Inputs	Coil Offset, Lower Word	Sets the offset word address for a coil (MB).	 ◆ <i>Offsets (PARAM20 to PARAM27) on page 4-162</i>
21		Coil Offset, Upper Word		
22		Input Relay Offset, Lower Word	Sets the offset word address for an input relay (IB).	 ◆ <i>Offsets (PARAM20 to PARAM27) on page 4-162</i>
23		Input Relay Offset, Upper Word		
24		Input Register Offset, Lower Word	Sets the offset word address for an input register (IW).	 ◆ <i>Offsets (PARAM20 to PARAM27) on page 4-162</i>
25		Input Register Offset, Upper Word		
26		Hold Register Offset, Lower Word	Sets the offset word address for a hold register (MW).	 ◆ <i>Offsets (PARAM20 to PARAM27) on page 4-162</i>
27		Hold Register Offset, Upper Word		
28		Data Relay Offset, Lower Word	Sets the offset word address for a data relay (GB).	 ◆ <i>Data Relay Offset (PARAM28 and PARAM29) on page 2-32</i>
29		Data Relay Offset, Upper Word		
30		Data Register Offset, Lower Word	Sets the offset word address for a data register (GW).	 ◆ <i>Data Register Offset (PARAM30 and PARAM31) on page 2-32</i>
31		Data Register Offset, Upper Word		
32		Output Coil Offset, Lower Word	Sets the offset word address for an output coil (OB).	 ◆ <i>Output Coil Offset (PARAM32 and PARAM33) on page 2-32</i>
33		Output Coil Offset, Upper Word		
34		Output Register Offset, Lower Word	Sets the offset address for an output register (OW).	 ◆ <i>Output Register Offset (PARAM34 and PARAM35) on page 2-32</i>
35		Output Register Offset, Upper Word		
36		M Register Writing Range LO, Lower Word	Sets the first address of the writing range for hold register coils.	 ◆ <i>M Register Writing Range (PARAM36 to PARAM39) on page 4-163</i>
37		M Register Writing Range LO, Upper Word		
38		M register Writing Range HI, Lower Word	Sets the last address of the writing range for hold register coils.	 ◆ <i>M Register Writing Range (PARAM36 to PARAM39) on page 4-163</i>
39		M Register Writing Range HI, Upper Word		

Continued on next page.

Continued from previous page.

No.	I/O	Meaning	Description	Reference Page
40	Inputs	G register Writing Range LO, Lower Word	Sets the first address of the writing range for data register data relays.	 ◆ G Register Writing Range LO (PARAM40 and PARAM41) on page 2-33
41		G Register Writing Range LO, Upper Word		
42		G Register Writing Range HI, Lower Word	Sets the last address of the writing range for data register data relays.	 ◆ G Register Writing Range HI (PARAM42 and PARAM43) on page 2-33
43		G Register Writing Range HI, Upper Word		
44		O Register Writing Range LO, Lower Word	Sets the first address of the writing range for output registers.	 ◆ O Register Writing Range LO (PARAM44 and PARAM45) on page 2-33
45		O Register Writing Range LO, Upper Word		
46		O Register Writing Range HI, Lower Word	Sets the last address of the writing range for output registers.	 ◆ O Register Writing Range HI (PARAM46 and PARAM47) on page 2-34
47		O Register Writing Range HI, Upper Word		
48	–	For system use	This parameter contains the channel number of the communications buffer that is currently in use. A user program must set this parameter to 0 on the first scan after startup. Thereafter, do not change the value of this parameter from a user program or by any other means because it will be used by the system.	 ◆ For System Use (PARAM48) on page 2-34
49	–	Reserved for system.	These parameters are used by the system. Do not change the value of these parameters from a user program or by any other means.	 ◆ Reserved for System (PARAM49 to PARAM51) on page 2-34
50	–	Reserved for system.		
51	–	Reserved for system.		

◆ Detail Error Code (PARAM02 and PARAM03)

These parameters give the detail error code.

Processing Result Value (PARAM00)	Detail Error Code	Error Description	Description
81□□ hex	1	Function code error	An unused function code was received. Check the function code of the remote station.
82□□ hex	2	Address setting error	The setting of one or more of the following parameters is out of range. Check the settings. PARAM14 and PARAM15 (Data Address) PARAM20 and PARAM21 (Coil Offset) PARAM26 and PARAM27 (Hold Register Offset)
83□□ hex	3	Data size error	The data size for receiving is out of range. Check the data size at the remote station.
84□□ hex	4	Circuit number setting error	The circuit number is out of range. Check the circuit number (Cir-No) in the MSG-RCVE function.
85□□ hex	5	Channel number setting error	The channel number for the communications buffer is out of range. Check the communications buffer channel number (Ch-No) in the MSG-RCVE function.
86□□ hex	6	Connection number error	The connection number is out of range. Check PARAM10 (Connection Number).
88□□ hex	8	Communications device error	An error response was received from the communications device. Check the connections to the device. Also check to see if the remote device is ready to communicate.
89□□ hex	9	Device select error	A device that cannot be used was selected. Check the communications device type (Dev-Typ) in the MSG-RCVE function.

◆ Function Code (PARAM12)

This parameter gives the function code that was received.

MEMOBUS Function Code	FINS Command Code			Target Data Type	Function
	MR	SR	I/O Memory Type		
01 hex	01 hex	01 hex	B0 hex	W	Reads CIO Area words.
			B1 hex	W	Reads Work Area words.
			B2 hex	W	Reads Holding Area words.
			B3 hex	W	Reads Auxiliary Area words.
03 or 09 hex	01 hex	01 hex	82 hex	W	Reads DM Area words.
0F hex	01 hex	02 hex	B0 hex	W	Writes to CIO Area words.
			B1 hex	W	Writes to Work Area words.
			B2 hex	W	Writes to Holding Area words.
			B3 hex	W	Writes to Auxiliary Area words.
0B or 10 hex	01 hex	02 hex	82 hex	W	Writes to DM Area words.
0D hex	01 hex	04 hex	82 hex	W	Reads non-consecutive words from the DM Area.

Note: W: Word (channel) data

◆ **Data Address (PARAM14 and PARAM15)**

These parameters give the data address that was requested by the remote station. The type of device and device range determine the data area.

Table 4.18 Bit Conversion Table

Data Area	Address Range	Notation	Function Code	Data Address Setting Range	Corresponding Register Addresses
CIO Area	0000 to 2047	Decimal	01 and 0F hex: Coils	0 to 32767	MB000000 to MB02047F
Work Area	W000 to W511	Decimal	01 and 0F hex: Coils	32768 to 40959	MB020480 to MB02559F
Holding Area	H00000 to H51115	Decimal	01 and 0F hex: Coils	40960 to 49151	MB025600 to MB03071F
Auxiliary Area	A000 to A447 (read only) A448 to A959 (read/write)	Decimal	01 and 0F hex: Coils	49152 to 56319 56320 to 64511	MB030720 to MB03519F MB035200 to MB04031F

Table 4.19 DM Area Conversion Table

Data Area	Address Range	Notation	Function Code	Data Address Setting Range	Corresponding Register Addresses
DM Area	D00000 to D32767	Decimal	03, 09, 0B, 0D, and 10 hex: Hold registers	0 to 32767	MW00000 to MW32767

◆ **Offsets (PARAM20 to PARAM27)**

Set the data address in the MP3000. The MP3000 will offset the address by the number of words specified by the offset.

Note: An offset cannot be a negative value.

Offset parameters are provided for each of the target register types.

The following table lists the offset parameters.

Parameters	Meaning	Description
PARAM20 and 21	Coil Offset	Sets the offset to the word address for a coil.
PARAM22 and 23	Input Relay Offset	Not used for the FINS protocol.
PARAM24 and 25	Input Register Offset	Not used for the FINS protocol.
PARAM26 and 27	Hold Register Offset	Sets the offset to the word address for a hold register.

The offset parameters that can be used depend on the function code.

The following table lists the valid parameters for each function code.

Function Code	Function	Applicable Offset Parameters
01 hex	Reads the states of coils.	PARAM20 and 21
03 hex	Reads the contents of hold registers.	PARAM26 and 27
09 hex	Reads the contents of hold registers (extended).	PARAM26 and 27
0B hex	Writes to hold registers (extended).	PARAM26 and 27
0D hex	Reads the contents of non-consecutive hold registers (extended).	PARAM26 and 27
0F hex	Changes the states of multiple coils.	PARAM20 and 21
10 hex	Writes to multiple hold registers.	PARAM26 and 27

◆ M Register Writing Range (PARAM36 to PARAM39)

Set the allowable address range for write requests from the remote station. An error will occur if the write request is outside this allowable range.

Specify the M Register Writing Range (PARAM36 to PARAM39) with word addresses.

Note: 1. M registers are always used as the destination in the MP3000 for data write requests from the remote station.

2. The writing range parameters allow you to specify the range of M registers that messages are allowed to write to.

The following table lists the writing range parameters.

Parameters	Meaning	Description
PARAM36 and 37	M Register Writing Range LO	First address of the writing range
PARAM38 and 39	M Register Writing Range HI	Last address of the writing range

Set the writing range so that it satisfies the following condition:

$$0 \leq \text{M register writing range LO} \leq \text{M register writing range HI} \leq \text{Maximum M register address}$$

The writing range applies when using the following function codes.

0B hex: Writes to hold registers (extended).

0F hex: Changes the states of multiple coils.

10 hex: Writes to multiple hold registers.

Example Use the following settings to set the allowable writing range of M register addresses to MW0001000 to MW0001999:

PARAM36 = 03E8 hex (1000)
 PARAM37 = 0000 hex (0000)
 PARAM38 = 07CF hex (1999)
 PARAM39 = 0000 hex (0000)

The MP3000 will return an error if a write request is received for addresses outside the range from MW01000 to MW01999, and will not perform the writing operation.

4.6 Communications with a KOYO PLC (MODBUS/TCP Protocol)

When using Ethernet communications between the MP3000 and a KOYO PLC, use the MODBUS/TCP protocol as the communications protocol. The MODBUS/TCP protocol allows the master to read and write to the slave registers. This section describes communications when the MP3000 acts as a slave and as the master.

4.6.1 Using Automatic Reception with the MP3000 as a Slave

This section describes how to communicate with a KOYO PLC by using automatic reception.

Setting Example

The following figure illustrates how the contents of the R1200 to R1261 hold registers in the KOYO PLC master are written to the MW00000 to MW00049 hold registers in the MP3000 slave.

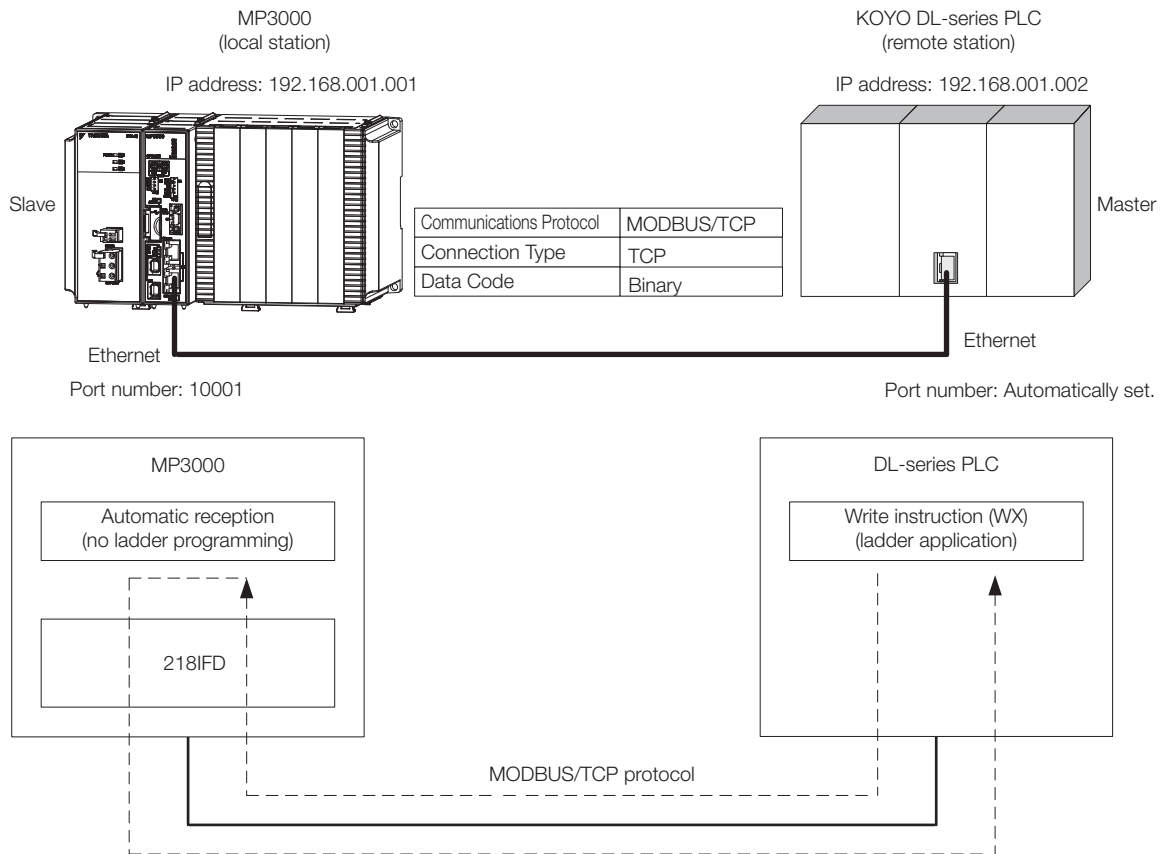

- Note: 1. Automatic reception uses one-to-one communications.
 2. If you need to communicate with multiple devices, use the MSG-RCVE function.

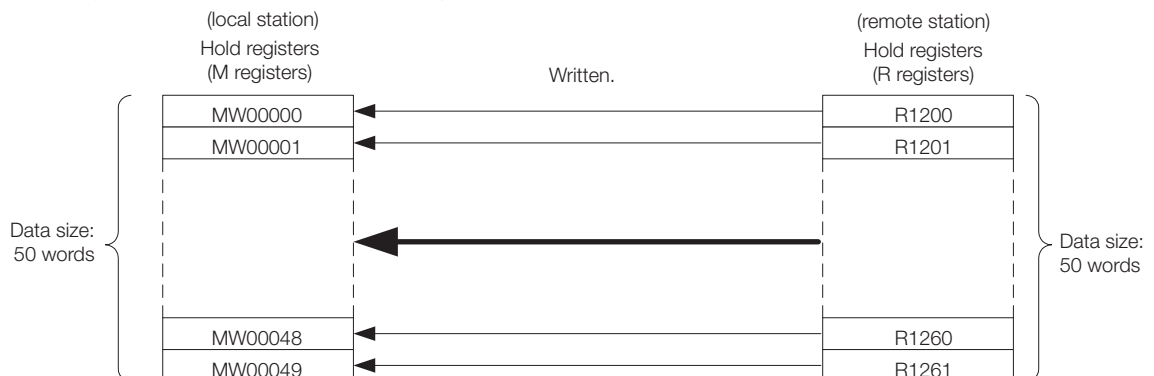

◆ MP3000 Setup

Use the following procedure to set up the MP3000.

Information If the communications parameters (IP address and subnet mask) have already been set, skip to step 3.

1. Double-click the cell for 218IFD in the Module Configuration Definition Tab Page.

Module	Function Module/Slave	Status	Circuit No./Axis Address		Motion Register	Register(Input/Output)		
			Start	cupied circ		Disabled	Start - End	Size
01 [CPU-302(32axes)] : ---								
00 CPU302(32) [---]	01 CPU	---						
	02 218IFD	---	0	Circuit No1	1		Input Output	0000 - 07FF[H] 2048
	03 SVC32	---	1	Circuit No1	1	8000 - 87FF[H]	Input Output	0800 - 0BFF[H] 1024
	04 SVR32	---	1	Circuit No3	1	9000 - 97FF[H]		
	05 M-EXECUTOR	---						0C00 - 0C3F[H] 64
	06 -- UNDEFINED --	---						
	07 -- UNDEFINED --	---						
01 -- UNDEFINED -- [---]								
02 -- UNDEFINED -- [---]								
03 -- UNDEFINED -- [---]								
02 -- UNDEFINED --								
02 -- UNDEFINED --								
03 -- UNDEFINED --								
04 -- UNDEFINED --								

The 218IFD Detail Definition Dialog Box will be displayed.

2. Set the communications parameters.

Transmission Parameters: Status

Transmission Parameters

IP Address : 192 . 168 . 1 . 1 (0-255)

Subnet Mask : 255 . 255 . 255 . 0 (0-255)

Gateway IP Address : 0 . 0 . 0 . 0 (0-255)

Module Name Definition
Equipment name : CONTROLLER NAME

Detail Definition

- ① In the [IP Address] Boxes, enter the following address: 192.168.001.001.
- ② In the [Subnet Mask] Boxes, enter the following mask: 255.255.255.000.
- ③ In the [Gateway IP Address] Boxes, enter the following address: 000.000.000.000.

3. Click the [Easy setting] Button in the [Message Communication] Area in the [Connection Parameter] Area.

Connection Parameter

Message Communication

Easy setting

The following parameters for message communications can be easily set.
Connections(C NO) 01-10 can be set to receive data automatically.

CNO	Local Port	Node IP Address	Node Port	Connect Type	Protocol Type	Code	Detail
01	---						Setting*
02	---						Setting*
03	---						Setting*
04	---						Setting*
05	---						Setting*
06	---						Setting*
07	---						Setting*

The Message Communications Easy Setting Dialog Box will be displayed.

4. Set the connection parameters.

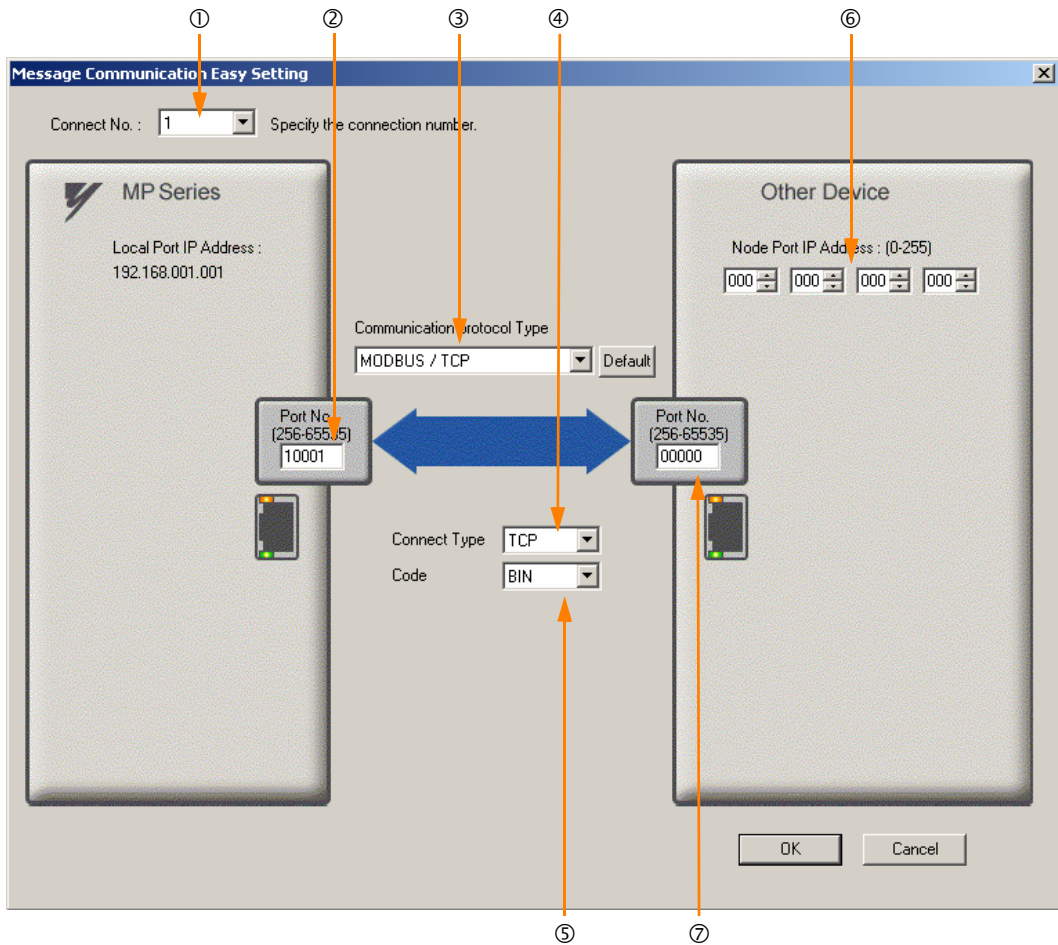

- ① Select [1] in the [Connect No.] Box.
- ② Enter "10001" in the [Port No.] Box for the MP-series Controller.
- ③ Select [MODBUS/TCP] protocol in the [Communications Protocol Type] Box, and then click the [Default] Button.
- ④ Select [TCP] in the [Connect Type] Box.
- ⑤ Select [BIN] in the [Code] Box.
- ⑥ Enter the following address in the [Node Port IP Address] Boxes for the other device:
000.000.000.000.
- ⑦ Enter "00000" in the [Port No.] Box for the other device.

5. Click the [OK] Button.

6. Click the [Yes] Button in the Transmission Parameters Confirmation Dialog Box.

Note: If parameters have already been set for the same connection number and you click the [Yes] Button in the Transmission Parameters Confirmation Dialog Box, the settings will be overwritten by the parameters that are set in the Message Communications Easy Setting Dialog Box.

7. Check the settings and double-click the [Setting] Button in the [Detail] Column.

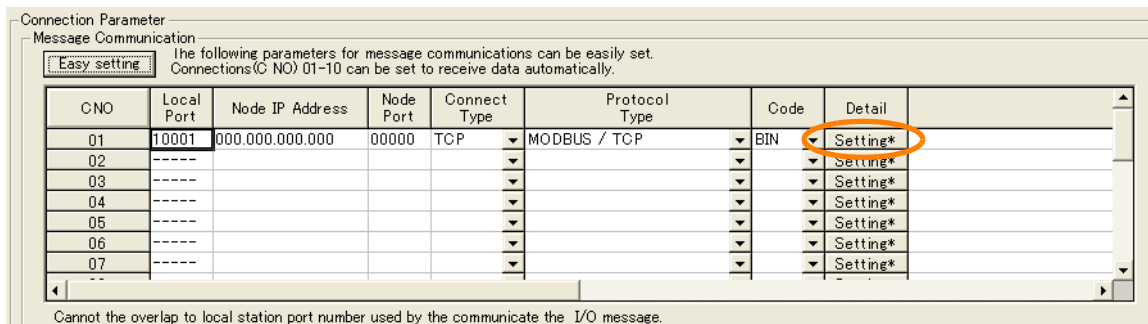

8. Select the [Enable] Option in the Automatically Reception Tab Page and then click the [OK] Button.

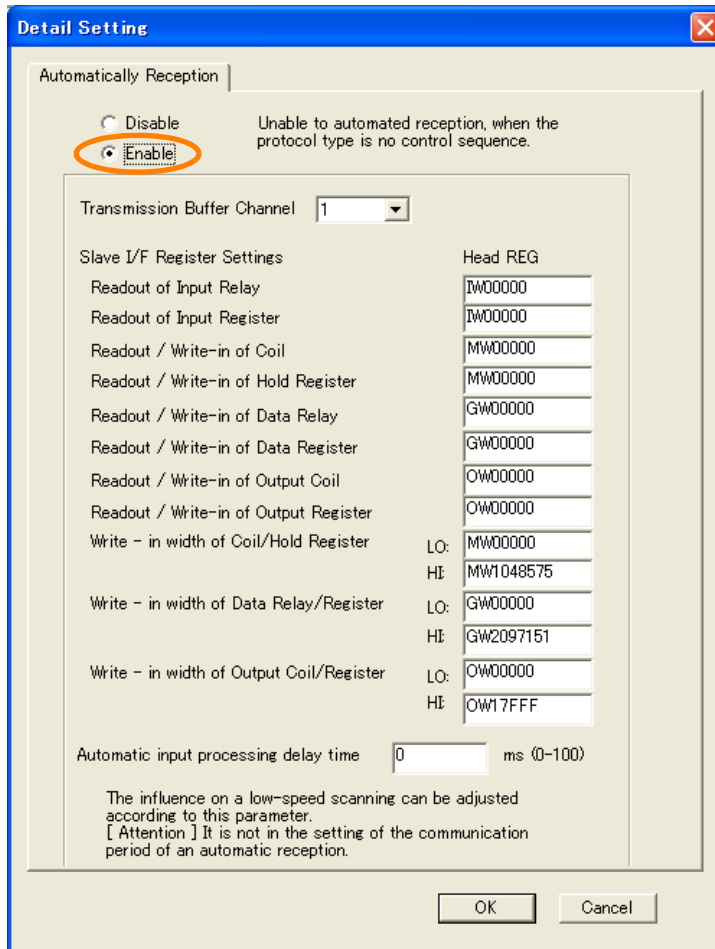

Note: Disable automatic reception for any connection for which message functions (MSG-SNDE and MSG-RCVE) are used. If message functions are used while automatic reception is enabled, the communications will not function properly.

9. Save the data to flash memory.

Note: Changes made to the communications or connection parameters will become effective only after the changes have been saved to flash memory and the power supply has been cycled.

This concludes the settings for using the MP3000 as a slave.

◆ Setting the Remote Device (KOYO PLC)

Use the following procedure to set the KOYO DL-series PLC.

Information The DL-series PLCs are manufactured by KOYO Electronics Industries. Contact KOYO Electronics Industries for further information.

1. Start DirectSoft32.
2. Create a project.
3. Start NetEdit3.
4. Click the [ECOM Settings] Tab followed by the [General] Button in the [Configuration] Area to set the network parameters.

Parameter	Description
Select the [Use the following IP settings] Option before setting the following items.	
IP Address	192.168.1.2
Subnet mask	255.255.255.0
Others	As required.

5. Click the [ECOM Settings] Tab followed by the [Peer to Peer] Button in the [Configuration] Area to set the MODBUS/TCP parameters.

Parameter	Description
RX/WX Device Number	1
Select the [Modbus-TCP] Option before setting the following items.	
IP Address	192.168.1.1
Port	10001
Unit ID	0

Note: Specify an IP address that is not in use by any other device on the same network. Check with your network administrator for unused IP addresses.

6. Create a ladder program for communications.

- ① Use the Load (LDS) instruction to specify the base number, ECOM slot number, and server node number.

Example LDS K301
Base number: 0 (CPU base), ECOM slot number: 1, Server node number: 01

- ② Use the Load instruction to specify the number of bytes to send.

Example LDS K100
Number of bytes: 100 (50 words)

- ③ Use the LDR instruction to specify the master memory area.

Example LDS O1200
Master memory area: 01200
Specify the first address to store the data to send in the DL-series PLC.

- ④ Use the Write (WX) instruction to specify the memory area in the slave and send the message.

Example WX TA0
Slave memory area: R0 (TA0)
Set the first address offset of the registers to write to in the MP3000.
If the MP3000 has not been set to use offset addressing, specifying R0 (TA0) will write the specified size of data in the MP3000 starting at address MW00000.

Note: Contact KOYO Electronics Industries for further information on ladder programming.

This concludes the setup. Set any other parameters as necessary, then transfer the data to the PLC.

◆ Starting Communications

Use the following procedure to write the data in the holding registers in the KOYO PLC to the hold registers in the MP3000.

1. Turn ON the power to the MP3000 to start receiving messages.
The system will automatically start the message reception operation. No further operation is required.
2. Send the message by executing the WX instruction on the KOYO PLC.
The MP3000 will receive the message when the KOYO PLC sends it.

4.6.2 Using I/O Message Communications with the MP3000 as the Master

This section describes how to communicate with a KOYO PLC by using I/O message communications.

Setting Example

The following figure illustrates how the contents of the OW00064 to OW00095 output registers in the MP3000 master are written to the R1300 to R1361 holding registers in the KOYO PLC slave.

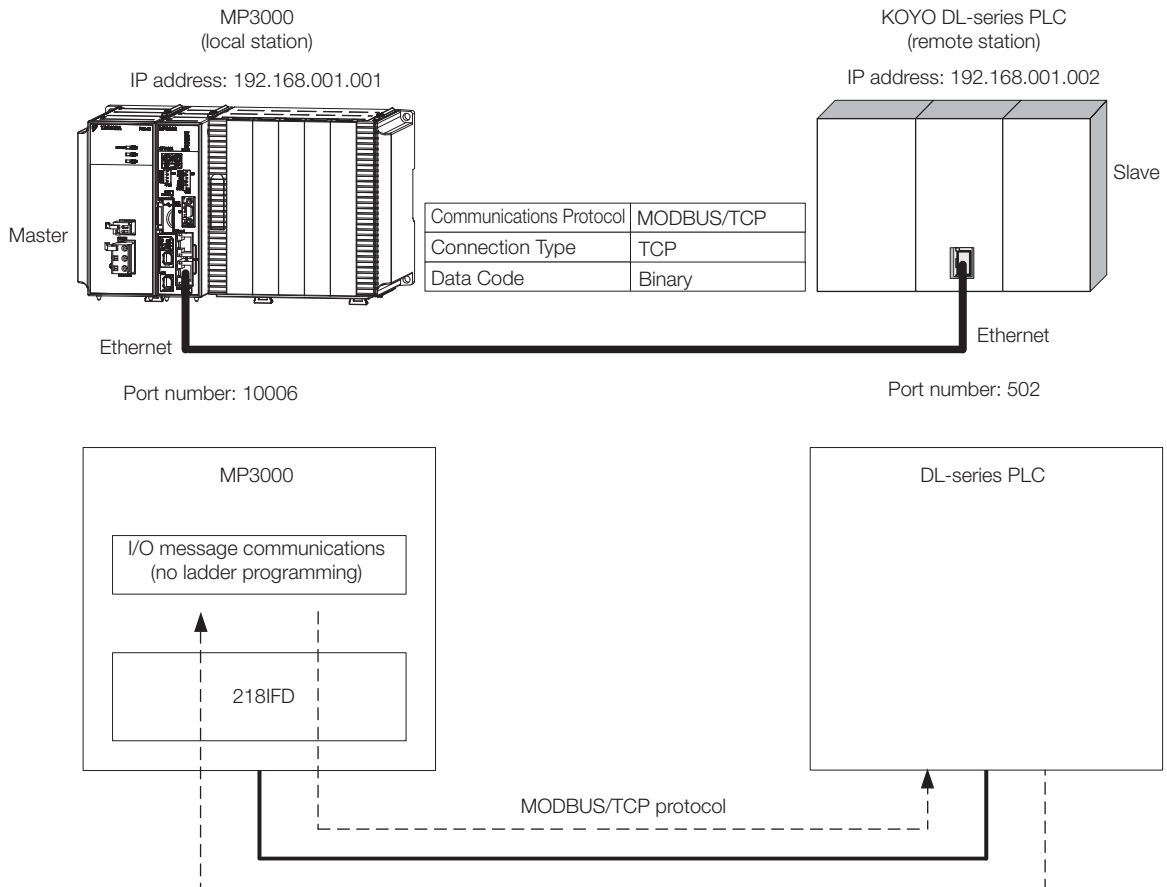

- Note: 1. I/O message communications use one-to-one communications.
 2. When using the MODBUS/TCP protocol to communicate with a KOYO DL-series PLC, you can only read and write holding registers.
 3. When communicating with multiple remote devices or when you need to perform any operations other than reading and writing to holding registers, such as reading the states of coils and input relays, and changing the states of coils, use the send message function (MSG-SNDE).

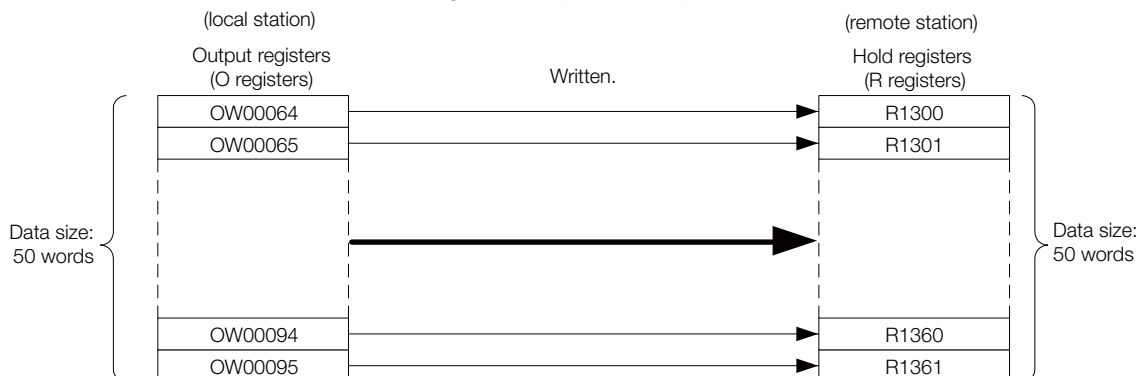

◆ MP3000 Setup

Use the following procedure to set up the MP3000.

Information If the communications parameters (IP address and subnet mask) have already been set, skip to step 3.

1. Double-click the cell for 218IFD in the Module Configuration Definition Tab Page.

Module	Function Module/Slave	Status	Circuit No./AxisAddress		Motion Register	Register(Input/Output)		
			Start	cupied circl		Disabled	Start - End	Size
01 [CPU-302(32axes)] : ---	01 CPU	----	----	----	----	----	----	----
01 MBL-303	02 218IFD	----	☐	Circuit No1	1	----	<input type="checkbox"/> Input <input type="checkbox"/> OutPut	0000 - 07FF[H] 2048
	03 SVC32	----	☐	Circuit No1	1	8000 - 87FF[H]	<input type="checkbox"/> Input <input type="checkbox"/> OutPut	0800 - 0BFF[H] 1024
	04 SVR32	----	☐	Circuit No3	1	9000 - 97FF[H]	----	----
	05 M-EXECUTOR	----	----	----	----	----	----	0C00 - 0C3F[H] 64
	06 -- UNDEFINED --	----	----	----	----	----	----	----
	07 -- UNDEFINED --	----	----	----	----	----	----	----
	01 -- UNDEFINED --[-----]	----	----	----	----	----	----	----
02 -- UNDEFINED --[-----]	----	----	----	----	----	----	----	
03 -- UNDEFINED --	----	----	----	----	----	----	----	
02 -- UNDEFINED --	----	----	----	----	----	----	----	
02 -- UNDEFINED --	----	----	----	----	----	----	----	
03 -- UNDEFINED --	----	----	----	----	----	----	----	
04 -- UNDEFINED --	----	----	----	----	----	----	----	

The 218IFD Detail Definition Dialog Box will be displayed.

2. Set the communications parameters.

- ① In the [IP Address] Boxes, enter the following address: 192.168.001.001.
- ② In the [Subnet Mask] Boxes, enter the following mask: 255.255.255.000.
- ③ In the [Gateway IP Address] Boxes, enter the following address: 000.000.000.000.

3. Select the [Enable] Option in the [I/O Message Communication] Area of the [Connection Parameter] Area.

4. Set the connection parameters.

- ① Enter "10006" in the MP3000 [Local Port] Box.
- ② Enter the following address for the remote device in the [Node IP Address] Box: 192.168.001.002.
- ③ Enter "502" in the [Node Port] Box.
- ④ Select [TCP] in the [Connect Type] Box.
- ⑤ Select [MODBUS/TCP] in the [Protocol Type] Box.
- ⑥ Select [BIN] in the [Code] Box.
- ⑦ Enter "OW0064" in the [Head register number] Box as the write data destination.
- ⑧ Enter "50" in the [Data Size] Box as the size of data to write.
- ⑨ Select [Low] in the [Data update timing] Box as the timing to update I/O data between the CPU Function Module and 218IFD.
- ⑩ Enter "4X" as the register type and "00001" as the first address to write to on the remote device.

Note: 1. In I/O message communications, a message is transmitted from separate ports if registers are both read and written. Therefore, the connected remote device must have two connections to receive both messages.
 2. The data update timing is the timing at which the CPU Function Module and 218IFD exchange data. Communications with the remote device are performed asynchronously. The data update timing therefore does not necessarily mean that the messages are sent to the remote device.

5. Save the data to flash memory.

Note: Changes made to the communications or connection parameters will become effective only after the changes have been saved to flash memory and the power supply has been cycled.

This concludes the settings for using the MP3000 as the master.

◆ Setting the Remote Device (KOYO PLC)

Use the following procedure to set the KOYO DL-series PLC.

Information The DL-series PLCs are manufactured by KOYO Electronics Industries. Contact KOYO Electronics Industries for further information.

1. Start DirectSoft32.
2. Create a project.
3. Start NetEdit3.
4. Click the [ECOM Settings] Tab followed by the [General] Button in the [Configuration] Area to set the network parameters.

Parameter	Description
Select the [Use the following IP settings] Option before setting the following items.	
IP Address	192.168.1.2
Subnet Mask	255.255.255.0
Others	As required.

- Click the [ECOM Settings] Tab followed by the [Peer to Peer] Button in the [Configuration] Area to set the MODBUS/TCP parameters.

Parameter	Description
RX/WX Device Number	1
Select the [Modbus-TCP] Option before setting the following items.	
IP Address	192.168.1.1
Port	10006
Unit ID	0

Note: Specify an IP address that is not in use by any other device on the same network.
Check with your network administrator for unused IP addresses.

This concludes the setup. Set any other parameters as necessary, then transfer the data to the PLC.

◆ Starting Communications

Use the following procedure to write the data in the output registers in the MP3000 to the holding registers in KOYO PLC.

- Start receiving messages on the KOYO PLC.**
The system will automatically start the message reception operation. No further operation is required.
- Turn ON the power to the MP3000 to start transmitting messages.**
The system will automatically start the message transmission operation. No further operation is required.

4.6.3 Using the MSG-SNDE Function with the MP3000 as the Master

This section describes how to communicate with a KOYO DL-series PLC by using the MSG-SNDE function in the MP3000.

Setting Example

The following figure illustrates how the contents of the OW00000 to OW00049 output registers in the MP3000 master are written to the R1300 to R1361 holding registers in the KOYO PLC slave.

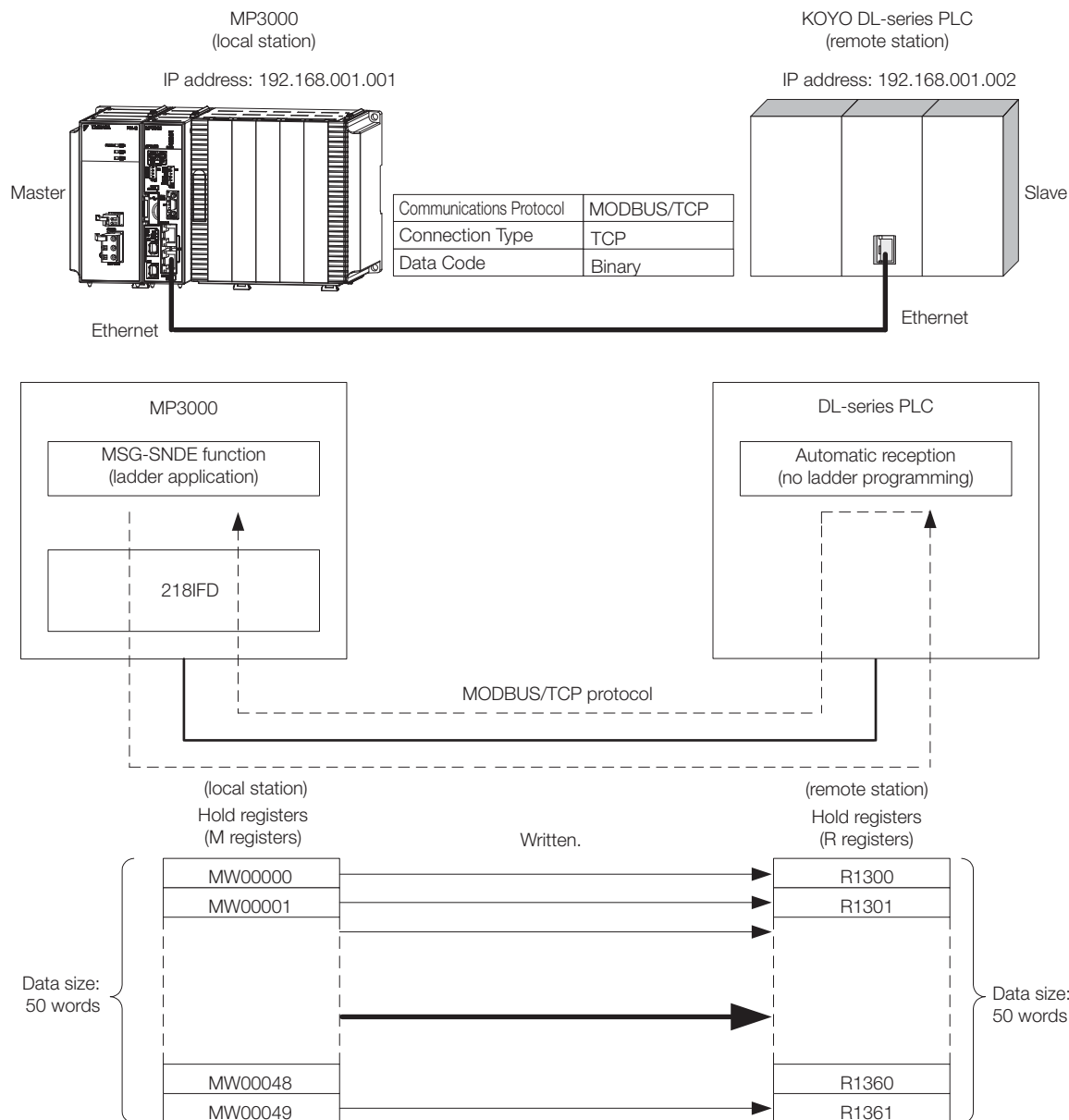

◆ MP3000 Setup

Use the following procedure to set up the MP3000.

Information If the communications parameters (IP address and subnet mask) have already been set, skip to step 3.

1. Double-click the cell for 218IFD in the Module Configuration Definition Tab Page.

Module	Function Module/Slave	Status	Circuit No./AxisAddress		Motion Register	Register(Input/Output)		
			Start	cupied circ		Disabled	Start - End	Size
01 [CPU-302(32axes)] : ---	01 CPU	----	----	----	----	----	----	----
00 CPU302(32)[-----]	02 218IFD	----	00	Circuit No1 1	----	<input type="checkbox"/> Input <input type="checkbox"/> OutPut	0000 - 07FF[H]	2048
	03 SVC32	----	01	Circuit No1 1	8000 - 87FF[H]	<input type="checkbox"/> Input <input type="checkbox"/> OutPut	0800 - 0BFF[H]	1024
	04 SVR32	----	02	Circuit No3 1	9000 - 97FF[H]	----	----	----
	05 M-EXECUTOR	----	----	----	----	----	0C00 - 0C3F[H]	64
	06 -- UNDEFINED --	----	----	----	----	----	----	----
	07 -- UNDEFINED --	----	----	----	----	----	----	----
	01 -- UNDEFINED --[-----]	----	----	----	----	----	----	----
02 -- UNDEFINED --[-----]	----	----	----	----	----	----	----	
03 -- UNDEFINED --	----	----	----	----	----	----	----	
02 -- UNDEFINED --	----	----	----	----	----	----	----	
02 -- UNDEFINED --	----	----	----	----	----	----	----	
03 -- UNDEFINED --	----	----	----	----	----	----	----	
04 -- UNDEFINED --	----	----	----	----	----	----	----	

The 218IFD Detail Definition Dialog Box will be displayed.

2. Set the communications parameters.

Transmission Parameters | Status

Transmission Parameters

IP Address : 192 . 168 . 001 . 001 (0-255)

Subnet Mask : 255 . 255 . 255 . 000 (0-255)

Gateway IP Address : 0 . 0 . 0 . 0 (0-255)

Module Name Definition
Equipment name : CONTROLLER NAME

Detail Definition

- ① In the [IP Address] Boxes, enter the following address: 192.168.001.001.
- ② In the [Subnet Mask] Boxes, enter the following mask: 255.255.255.000.
- ③ In the [Gateway IP Address] Boxes, enter the following address: 000.000.000.000.

3. Click the [Easy setting] Button in the [Message Communication] Area in the [Connection Parameter] Area.

Connection Parameter

Message Communication

The following parameters for message communications can be easily set.
Connections(C NO) 01-10 can be set to receive data automatically.

Easy setting

CNO	Local Port	Node IP Address	Node Port	Connect Type	Protocol Type	Code	Detail
01	----						Setting*
02	----						Setting*
03	----						Setting*
04	----						Setting*
05	----						Setting*
06	----						Setting*
07	----						Setting*

The Message Communications Easy Setting Dialog Box will be displayed.

4. Set the connection parameters.

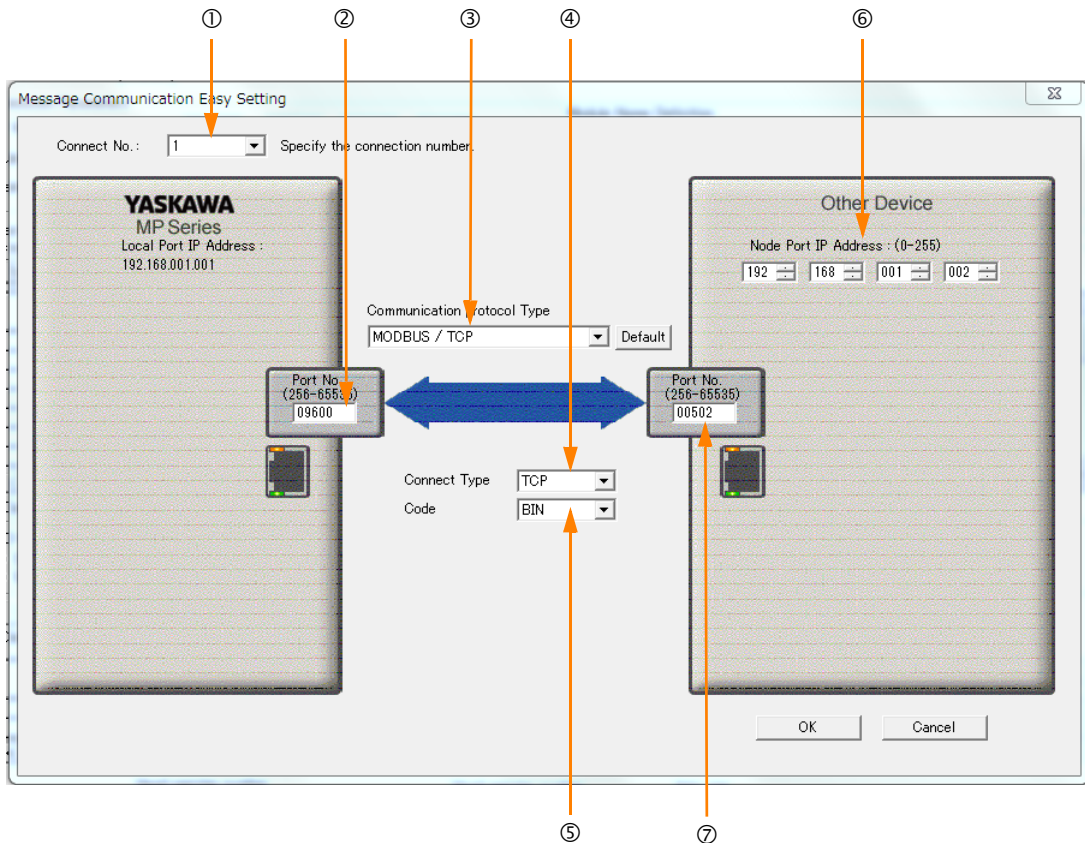

- ① Select [1] in the [Connect No.] Box.
- ② Enter "9600" in the [Port No.] Box for the MP-series Controller.
- ③ Select [MODBUS/TCP] in the [Communication Protocol Type] Box.
- ④ Select [TCP] in the [Connect Type] Box.
- ⑤ Select [BIN] in the [Code] Box.
- ⑥ Enter the following address in the [Node Port IP Address] Boxes for the other device:
192.168.001.002.
- ⑦ Enter "502" in the [Port No.] Box for the other device.

Note: Disable automatic reception for any connection for which message functions (MSG-SNDE and MSG-RCVE) are used. If message functions are used while automatic reception is enabled, the communications will not function properly.
 The unit address and network address of the MP-series Machine Controller are always 00 hex.
 If communicating with FINS/UDP, select [UDP] in the [Connect Type] Box.

5. Click the [OK] Button.

6. Click the [Yes] Button in the Transmission Parameters Confirmation Dialog Box.

Note: If parameters have already been set for the same connection number and you click the [Yes] Button in the Transmission Parameters Confirmation Dialog Box, the settings will be overwritten by the parameters that are set in the Message Communications Easy Setting Dialog Box.

7. Check the settings and double-click the [Setting] Button in the [Detail] Column.

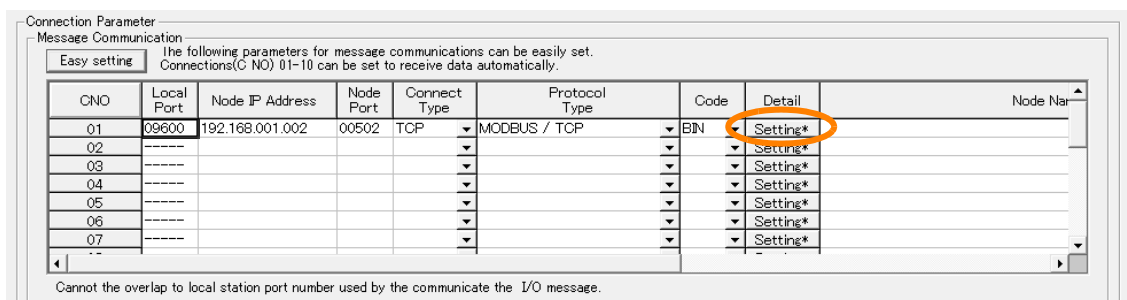

8. Create a ladder program for the MSG-SNDE function.
 A ladder program example is shown below.

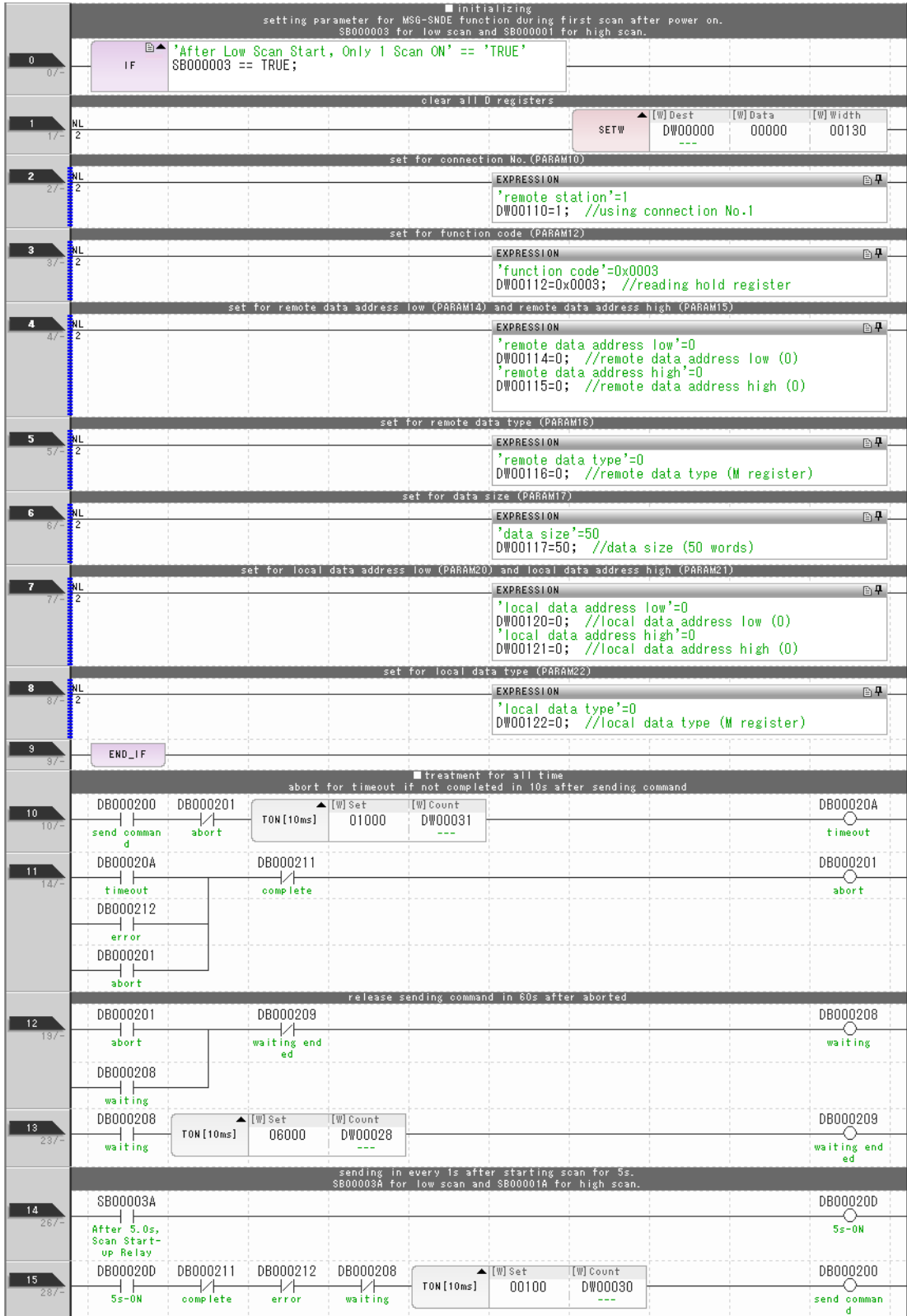

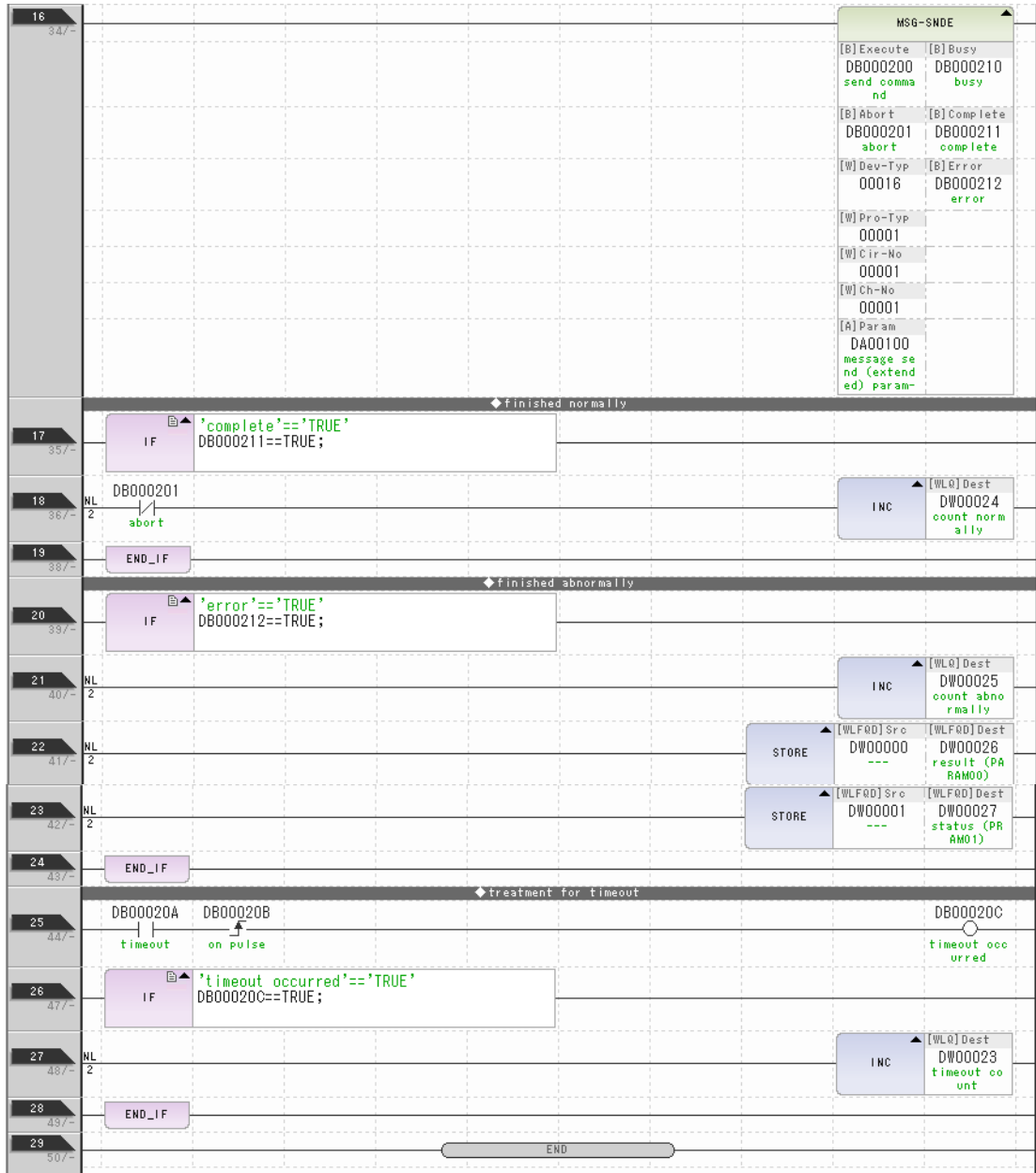

9. Save the data to flash memory.

This concludes the settings for using the MP3000 as the master.

◆ Setting the Remote Device (KOYO PLC)

Refer to the following section for details on KOYO DL-series PLC settings.

◆ Setting the Remote Device (KOYO PLC) on page 4-171

◆ Starting Communications

Use the following procedure to write the data in the hold registers in the MP3000 to the I/O bits in the CPU Unit of the KOYO PLC.

1. Start receiving messages on the KOYO PLC.

The system will automatically start the message reception operation. No further operation is required.

2. Turn ON the power to the MP3000 to start transmitting messages.

The ladder program example is designed to turn ON the Execute Bit (DB000200) in the message send function after six seconds has elapsed from when the low-speed scan (or high-speed scan) starts. Thereafter, the message send function is executed every second by alternating the Execute Bit (DB000200) between OFF and ON each time the message send function completes execution normally or with an error.

Note: The MP3000 will establish the TCP connection when it starts execution of the MSG-SNDE function.

SB00003A: Turns ON 5 seconds after start.

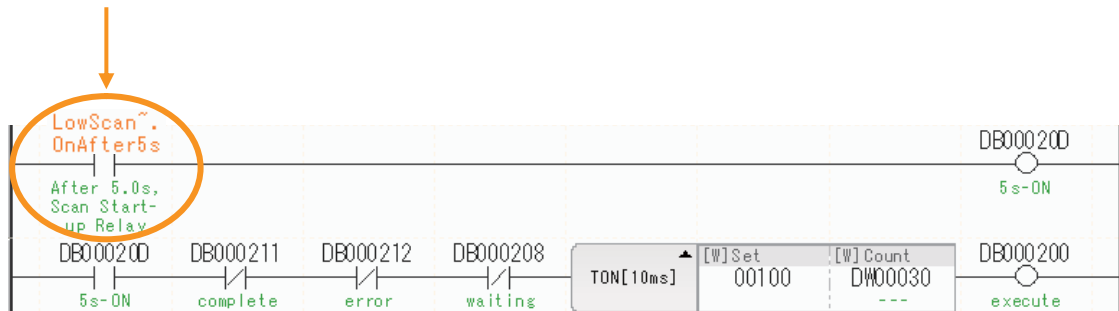

4.6.4 Message Functions

The message functions are used in user communications applications for the MODBUS/TCP protocol. You can send and receive message data by setting the necessary input items and parameters for the message functions.

Inputs and Outputs for the MSG-SNDE Function

I/O Definitions	No.	Name	I/O Designation	Meaning	Description
Input Items	1	Execute	B-VAL	Executes the transmission.	Specify the bit to use to execute the message transmission. When the Execute Bit turns ON, the message will be sent. Keep the Execute Bit ON until the Complete or Error Bit turns ON. To send another message, turn OFF the Execute Bit for at least one scan and then turn it ON again.
	2	Abort	B-VAL	Forces the transmission to end.	Specify the bit to use to abort the message transmission. When the Abort Bit turns ON, the message transmission will be stopped unconditionally. The Abort Bit takes precedence over the Execute Bit.
	3	Dev-Typ	I-REG	Communications device type	Specify the type code of the communications device. 218IFB, 218IFD = 16, 218IF = 6
	4	Pro-Typ	I-REG	Communications protocol	Specify the type code of the communications protocol. 1: MEMOBUS Select this protocol when using the MODBUS/TCP protocol. MEMOBUS is automatically converted to MODBUS/TCP inside the 218IFD. 2: No-protocol communications 1 (unit: words) Not used for the MODBUS/TCP protocol. 3: No-protocol communications 2 (unit: bytes) Not used for the MODBUS/TCP protocol.
	5	Cir-No	I-REG	Circuit number	Specify the circuit number for the communications device. Specify the same circuit number as displayed in the MPE720 Module Configuration Definition Tab Page. 218IFB, 218IFD, 218IF = 1 to 8
	6	Ch-No	I-REG	Communications buffer channel number	Specify the channel number of the communications buffer. You can specify any channel number provided it is within the valid range. When executing more than one function at the same time, do not use the same channel number for the same connection. You can use the same channel number as long as multiple functions are not executed at the same time. 218IFB, 218IFD, 218IF = 1 to 10
	7	Param	Address Inputs	Parameter list first address (MA, DA)	Specify the first address of the parameter list. A total of 29 words starting from the specified first word are automatically used for the parameter list. The parameter list is used by inputting function codes and relevant parameter data. It is also where the process results and status are output.









Continued on next page.

Continued from previous page.

I/O Definitions	No.	Name	I/O Designation	Meaning	Description
Output Items	1	Busy	B-VAL	Processing.	Specify the bit that shows that the message transmission is in progress. The Busy Bit is ON while a message transmission or abort is in progress. Keep the Execute Bit or Abort Bit turned ON while the Busy Bit is ON.
	2	Complete	B-VAL	Process completed.	Specify the bit that shows when the message transmission has been completed. The Complete Bit turns ON only for one scan when message transmission or forced abort processing has been completed normally.
	3	Error	B-VAL	Error occurred.	Specify the bit that shows if an error occurred when sending the message. When an error occurs, the Error Bit will turn ON only for one scan. Refer to the following section for an example of a timing chart for when an error occurs.  ◆ Error on page 2-8













MSG-SNDE Function Parameters

The following table describes the contents of the addresses specified by the PARAM input parameter to the MSG-SNDE function.

No.	I/O	Meaning	Description	Reference Page
00	Out-puts	Processing Result	Gives the processing status.	 ◆ Processing Result (PARAM00) on page 2-9
01		Status	Gives the status of the current function.	 ◆ Status (PARAM01) on page 2-10
02		Detail Error Code, Lower Word	Gives the details of an error.	 ◆ Detail Error Code (PARAM02 and PARAM03) on page 2-11
03				
04		Status 1	Gives the communications status.	 ◆ Status 1 (PARAM04) on page 2-12
05		Status 2	Gives status information on the most recent error.	 ◆ Status 2 (PARAM05) on page 2-12
06		Status 3	Gives the information of the send pass counter.	 ◆ Status 3 (PARAM06) on page 2-12
07		Status 4	Gives the information of the receive pass counter.	 ◆ Status 4 (PARAM07) on page 2-12
08		Status 5	Gives the information of the error counter.	 ◆ Status 5 (PARAM08) on page 2-13
09	Status 6	Not used for the MODBUS/TCP protocol.	–	

Continued on next page.

Continued from previous page.

No.	I/O	Meaning	Description	Reference Page
10	Inputs	Connection Number	Sets the connection number used to determine the remote station.	 ◆ <i>Connection Number (PARAM10)</i> on page 2-13
11		Option	Not used for the MODBUS/TCP protocol.	–
12		Function Code	Sets the code of the function in the MODBUS/TCP protocol.	 ◆ <i>Function Code (PARAM12)</i> on page 4-182
13		Reserved for system.	This parameter is used by the system. Do not change the value of this parameter from a user program or by any other means.	 ◆ <i>Reserved for System (PARAM13)</i> on page 2-14
14		Remote Station Data Address, Lower Word	Sets the data address to read/write at the remote station. (Use word addresses for registers, bit addresses for relays or coils.)	 ◆ <i>Remote Station Data Address (PARAM14 and PARAM15)</i> on page 2-15
15		Remote Station Data Address, Upper Word		
16		Remote Station Register Type	Sets the register type to read/write at the remote station.	 ◆ <i>Remote Station Register Type (PARAM16)</i> on page 4-183
17		Data Size	Sets the size of the data to read/write. (Use word sizes for registers, bit sizes for relays or coils.)	 ◆ <i>Data Size (PARAM17)</i> on page 4-156
18		Remote CPU Module Number	Sets the CPU number at the remote station.	 ◆ <i>Remote CPU Module Number (PARAM18)</i> on page 2-17
19		Reserved for system.	This parameter is used by the system. Do not change the value of this parameter from a user program or by any other means.	 ◆ <i>Reserved for System (PARAM19)</i> on page 2-17
20		Local Station Data Address, Lower Word	Sets the data address to store read/write data in the local station. (Use word addresses for registers, bit addresses for relays or coils.)	 ◆ <i>Local Station Data Address (PARAM20 and PARAM21)</i> on page 2-18
21		Local Station Data Address, Upper Word		
22		Local Station Register Type	Sets the register type of the read/write data to store in the local station.	 ◆ <i>Local Station Register Type (PARAM22)</i> on page 4-156
23		Reserved for system.	This parameter is used by the system. Do not change the value of this parameter from a user program or by any other means.	 ◆ <i>Reserved for System (PARAM23)</i> on page 2-19
24	–	For system use	This parameter is used by the system. It contains the channel number of the communications buffer that is currently in use. A user program must set this parameter to 0 on the first scan after startup. Thereafter, do not change the value of this parameter from a user program or by any other means because it will be used by the system.	 ◆ <i>Reserved for System (PARAM24)</i> on page 2-19
25		Reserved for system.	These parameters are used by the system. Do not change the value of these parameters from a user program or by any other means.	 ◆ <i>Reserved for System (PARAM25 to PARAM28)</i> on page 2-19
26		Reserved for system.		
27		Reserved for system.		
28		Reserved for system.		

◆ **Function Code (PARAM12)**

Set the function code to send.

You can use the functions that are registered to the function codes.

Function Code Code	Target Data Type	Function	Registers When Acting as the Master			
			Send Registers	Receive Registers		
00 hex	–	Not used for the MODBUS/TCP protocol.	M	M		
01 hex	B	Reads the states of coils.				
02 hex	B	Reads the states of input relays.				
03 hex	W	Reads the contents of hold registers.				
04 hex	W	Reads the contents of input registers.				
05 hex	B	Changes the state of a single coil.				
06 hex	W	Writes to a single hold register.				
07 hex	–	Not used for the MODBUS/TCP protocol.				
08 hex	–	Performs a loopback test.				
09 hex	W	Reads the contents of hold registers (extended).				
0A hex	W	Reads the contents of input registers (extended).				
0B hex	W	Writes to hold registers (extended).				
0C hex	–	Not used for the MODBUS/TCP protocol.				
0D hex	W	Reads the contents of non-consecutive hold registers (extended).				
0E hex	W	Writes the contents of non-consecutive hold registers (extended).				
0F hex	B	Changes the states of multiple coils.				
10 hex	W	Writes to multiple hold registers.				
4341 hex	B	Reads the states of bits.			S, M, G, I, or O	M or G
4345 hex	B	Changes the state of a single bit.				
4346 hex	W	Writes to a single register.				
4349 hex	W	Reads the contents of registers.				
434B hex	W	Writes to multiple registers.				
434D hex	W	Reads the contents of non-consecutive registers.				
434E hex	W	Writes the contents of non-consecutive registers.				
434F hex	B	Changes the states of multiple bits.				

Note: B: Bit data, W: Integer data

◆ Remote Station Register Type (PARAM16)

Set the register type in the remote station. This parameter is valid when using function codes 43□□hex.

Enter the register type as a decimal or hexadecimal number.

Register Type Value	Type	Remarks
0	M	Sets the target data type to MB for bits and MW for words.
1	G	Sets the target data type to GB for bits and GW for words.
2	I	Sets the target data type to IB for bits and IW for words.
3	O	Sets the target data type to OB for bits and OW for words.
4	S	Sets the target data type to SB for bits and SW for words.
5 or higher	–	Not used for the MODBUS/TCP protocol.

The register types that can be used depend on whether you are reading or writing.

The following table lists the combinations of register types.

Function Code	Applicable Register Types
4341 or 4349 hex	M, G, I, O, or S
4345, 4346, 434B, or 434F hex	M, G, O, or S
434D hex*	M or G
434E hex*	M or G

* The address table at the remote station is stored in registers in the local station. The contents of the M, G, I, O, and S registers in the remote station can be read by specifying the register type in the address table at the remote station.

For more information on remote station address tables, refer to the following sections.

 *Function Code: 434D Hex on page 6-17*

 *Function Code: 434E Hex on page 6-19*

Inputs and Outputs for the MSG-RCVE Function

I/O Definitions	No.	Name	I/O Designation	Meaning	Description
Input Items	1	Execute	B-VAL	Executes the transmission.	Specify the bit to use to execute the message transmission. When the Execute Bit turns ON, the message will be sent. Keep the Execute Bit ON until the Complete or Error Bit turns ON. To send another message, turn OFF the Execute Bit for at least one scan and then turn it ON again.
	2	Abort	B-VAL	Forces the transmission to end.	Specify the bit to use to abort the message transmission. When the Abort Bit turns ON, the message transmission will be stopped unconditionally. The Abort Bit takes precedence over the Execute Bit.
	3	Dev-Typ	I-REG	Communications device type	Specify the type code of the communications device. 218IFB, 218IFD, 218IF = 6
	4	Pro-Typ	I-REG	Communications protocol	Specify the type code of the communications protocol. 1: MEMOBUS Select this protocol when using the Extended MEMOBUS protocol. MEMOBUS is automatically converted to Extended MEMOBUS inside the 218IFD. 2: No-protocol communications 1 (unit: words) Not used for the Extended MEMOBUS protocol. 3: No-protocol communications 2 (unit: bytes) Not used for the Extended MEMOBUS protocol.
	5	Cir-No	I-REG	Circuit number	Specify the circuit number for the communications device. Specify the same circuit number as displayed in the MPE720 Module Configuration Definition Tab Page. 218IFB, 218IFD, 218IF = 1 to 8
	6	Ch-No	I-REG	Communications buffer channel number	Specify the channel number of the communications buffer. You can specify any channel number provided it is within the valid range. When executing more than one function at the same time, do not use the same channel number for the same connection. You can use the same channel number as long as multiple functions are not executed at the same time. 218IFB, 218IFD, 218IF = 1 to 10
	7	Param	Address Inputs	Parameter list first address (MA, DA)	Specify the first address of the parameter list. A total of 52 words starting from the specified first word are automatically used for the parameter list. The parameter list is used by inputting function codes and relevant parameter data. It is also where the process results and status are output.











Continued on next page.

Continued from previous page.

I/O Definitions	No.	Name	I/O Designation	Meaning	Description
Output Items	1	Busy	B-VAL	Processing.	Specify the bit that shows that the message transmission is in progress. The Busy Bit is ON while a message transmission or abort is in progress. Keep the Execute Bit or Abort Bit turned ON while the Busy Bit is ON.
	2	Complete	B-VAL	Process completed.	Specify the bit that shows when the message transmission has been completed. The Complete Bit turns ON only for one scan when message transmission or forced abort processing has been completed normally.
	3	Error	B-VAL	Error occurred.	Specify the bit that shows if an error occurred when sending the message. When an error occurs, the Error Bit will turn ON only for one scan. Refer to the following section for an example of a timing chart for when an error occurs.  ◆ Error on page 2-23

MSG-RCVE Function Parameters

The following table describes the contents of the addresses specified by the PARAM input parameter to the MSG-RCVE function.

No.	I/O	Meaning	Description	Reference Page
00	Outputs	Processing Result	Gives the processing status.	 ◆ Processing Result (PARAM00) on page 2-25
01		Status	Gives the status of the current function.	 ◆ Status (PARAM01) on page 2-25
02		Detail Error Code, Lower Word	Gives the details of an error.	 ◆ Detail Error Code (PARAM02 and PARAM03) on page 2-27
03				
04		Status 1	Gives the communications status.	 ◆ Status 1 (PARAM04) on page 2-27
05		Status 2	Gives status information on the most recent error.	 ◆ Status 2 (PARAM05) on page 2-28
06		Status 3	Gives the information of the send pass counter.	 ◆ Status 3 (PARAM06) on page 2-28
07		Status 4	Gives the information of the receive pass counter.	 ◆ Status 4 (PARAM07) on page 2-28
08		Status 5	Gives the information of the error counter.	 ◆ Status 5 (PARAM08) on page 2-28
09	Status 6	Not used for the MODBUS/TCP protocol.	–	
10	Input	Connection Number	Sets the connection number used to determine the remote station.	 ◆ Connection Number (PARAM10) on page 2-29
11	I/O	Option	Not used for the MODBUS/TCP protocol.	–
12	Output	Function Code	Gives the function associated with reading or writing that was received from the remote station as the function code.	 ◆ Function Code (PARAM12) on page 2-29
13	I/O	Reserved for system.	This parameter is used by the system. Do not change the value of this parameter from a user program or by any other means.	 ◆ Reserved for System (PARAM13) on page 2-30

Continued on next page.







4.6.4 Message Functions

Continued from previous page.

No.	I/O	Meaning	Description	Reference Page
14	Out-puts	Data Address, Lower Word	Gives the first address of the data that was requested by the remote station.	☞ Data Address (PARAM14 and PARAM15) on page 2-30
15		Data Address, Upper Word		
16		Register Types	Gives the register type that was requested by the remote station.	☞ Register Type (PARAM16) on page 2-31
17		Data Size	Gives the data size that was requested by the remote station.	☞ Data Size (PARAM17) on page 2-31
18		Remote CPU Module Number	Not used for the MODBUS/TCP protocol.	☞ Remote CPU Module Number (PARAM18) on page 2-31
19	I/O	Reserved for system.	This parameter is used by the system. Do not change the value of this parameter from a user program or by any other means.	☞ Reserved for System (PARAM19) on page 2-31
20	Inputs	Coil Offset, Lower Word	Sets the offset word address for a coil (MB).	☞ Coil Offset (PARAM20 and PARAM21) on page 2-31
21		Coil Offset, Upper Word		
22		Input Relay Offset, Lower Word	Sets the offset word address for an input relay (IB).	☞ Input Relay Offset (PARAM22 and PARAM23) on page 2-32
23		Input Relay Offset, Upper Word		
24		Input Register Offset, Lower Word	Sets the offset word address for an input register (IW).	☞ Input Register Offset (PARAM24 and PARAM25) on page 2-32
25		Input Register Offset, Upper Word		
26		Hold Register Offset, Lower Word	Sets the offset word address for a hold register (MW).	☞ Hold Register Offset (PARAM26 and PARAM27) on page 2-32
27		Hold Register Offset, Upper Word		
28		Data Relay Offset, Lower Word	Sets the offset word address for a data relay (GB).	☞ Data Relay Offset (PARAM28 and PARAM29) on page 2-32
29		Data Relay Offset, Upper Word		
30		Data Register Offset, Lower Word	Sets the offset word address for a data register (GW).	☞ Data Register Offset (PARAM30 and PARAM31) on page 2-32
31		Data Register Offset, Upper Word		
32		Output Coil Offset, Lower Word	Sets the offset word address for an output coil (OB).	☞ Output Coil Offset (PARAM32 and PARAM33) on page 2-32
33		Output Coil Offset, Upper Word		
34		Output Register Offset, Lower Word	Sets the offset address for an output register (OW).	☞ Output Register Offset (PARAM34 and PARAM35) on page 2-32
35		Output Register Offset, Upper Word		
36	M Register Writing Range LO, Lower Word	Sets the first address of the writing range for hold register coils.	☞ M Register Writing Range LO (PARAM36 and PARAM37) on page 2-33	
37	M Register Writing Range LO, Upper Word			

Continued on next page.

Continued from previous page.

No.	I/O	Meaning	Description	Reference Page
38	Inputs	M register Writing Range HI, Lower Word	Sets the last address of the writing range for hold register coils.	 ◆ M Register Writing Range HI (PARAM38 and PARAM39) on page 2-33
39		M Register Writing Range HI, Upper Word		
40		G register Writing Range LO, Lower Word	Sets the first address of the writing range for data register data relays.	 ◆ G Register Writing Range LO (PARAM40 and PARAM41) on page 2-33
41		G Register Writing Range LO, Upper Word		
42		G Register Writing Range HI, Lower Word	Sets the last address of the writing range for data register data relays.	 ◆ G Register Writing Range HI (PARAM42 and PARAM43) on page 2-33
43		G Register Writing Range HI, Upper Word		
44		O Register Writing Range LO, Lower Word	Sets the first address of the writing range for output registers.	 ◆ O Register Writing Range LO (PARAM44 and PARAM45) on page 2-33
45		O Register Writing Range LO, Upper Word		
46		O Register Writing Range HI, Lower Word	Sets the last address of the writing range for output registers.	 ◆ O Register Writing Range HI (PARAM46 and PARAM47) on page 2-34
47		O Register Writing Range HI, Upper Word		
48	-	For system use	This parameter is used by the system. It contains the channel number of the communications buffer that is currently in use. A user program must set this parameter to 0 on the first scan after startup. Thereafter, do not change the value of this parameter from a user program or by any other means because it will be used by the system.	 ◆ For System Use (PARAM48) on page 2-34
49	-	Reserved for system.	These parameters are used by the system. Do not change the value of these parameters from a user program or by any other means.	 ◆ Reserved for System (PARAM49 to PARAM51) on page 2-34
50	-	Reserved for system.		
51	-	Reserved for system.		

4.7 Communications with a JTEKT PLC (TOYOPUC Protocol)

When using Ethernet communications between the MP3000 and a JTEKT PLC, use the TOYOPUC protocol as the communications protocol. The TOYOPUC protocol allows the master to read and write to the slave registers.

This section describes communications when the MP3000 acts as a slave and as the master. When the MP3000 acts as a slave, communications can take place using automatic reception or using the MSG-RCVE function.

When the MP3000 acts as the master, communications can take place using the MSG-SNDE function.

The communications modules which can perform communications with a JTEKT PLC are 218IFD and 218IFB.

4.7.1 Using Automatic Reception with the MP3000 as a Slave

This section describes how to communicate with a JTEKT PLC by using automatic reception. When a JTEKT PLC is used as the master to write data to the file memory in the 2PORT-EFR, you will need to create a ladder application that uses the SPW instruction.

Information The SPW instruction is used to write data to the file memory in the 2PORT-EFR. Refer to the following manual for details.
 📖 Manual for the 2PORT-EFR Module from JTEKT Corporation

Communications Format

The MP3000 acts as a slave and receives data and returns a response to the master by using the communications formats for file memory commands that are shown below. Execution of the MSG-RCVE function in the MP3000 ends when a response is returned.

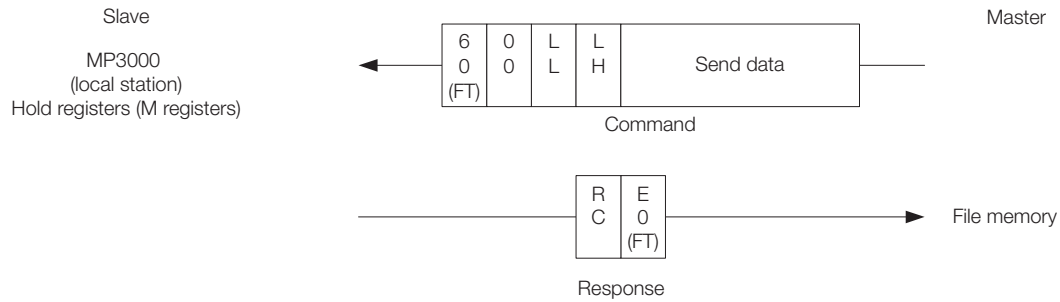

Note: In the figure shown above, the Ethernet header, TCP/UDP header, FCS and other items have been omitted. Only the data portion of the communications format is shown.

File Memory and Corresponding Registers in the MP3000

The following table shows the relationship between registers in the MP3000 and the send data area of file memory in the 2PORT-EFR.

Regardless of the connection number of the 2PORT-EFR, the MP3000 stores data from the first address (MW00000) of the hold registers by default. To store the data in a specific hold register, use the automatic reception offset setting.

Data Range		
2PORT-EFR Module		MP3000
File memory Data Area	File Memory Send/Receive Data Area Addresses	Hold Register Data Area Addresses
Connection 1	1000: Data size, 1002 to 17FD: Send data	Storage area*: MW00000 to MW02043
Connection 2	2000: Data size, 2002 to 27FD: Send data	
Connection 3	3000: Data size, 3002 to 37FD: Send data	
Connection 4	4000: Data size, 4002 to 47FD: Send data	
Connection 5	5000: Data size, 5002 to 57FD: Send data	
Connection 6	6000: Data size, 6002 to 67FD: Send data	
Connection 7	7000: Data size, 7002 to 77FD: Send data	
Connection 8	8000: Data size, 8002 to 87FD: Send data	

* The automatic reception offset allows you to make any address between MW00000 and MW65534 the first address.

Transfer Size

The following table lists the data sizes that can be received in a single file memory command when using automatic reception.

Applicable Model	Data size
MP3000	1 to 1,022 words Specify the number of whole words.

Setting Example

The following figure illustrates how the contents of the 1002 to 10C9 file memory addresses in the JTEKT PLC master are written to the MW00000 to MW00099 hold registers in the MP3000 slave.

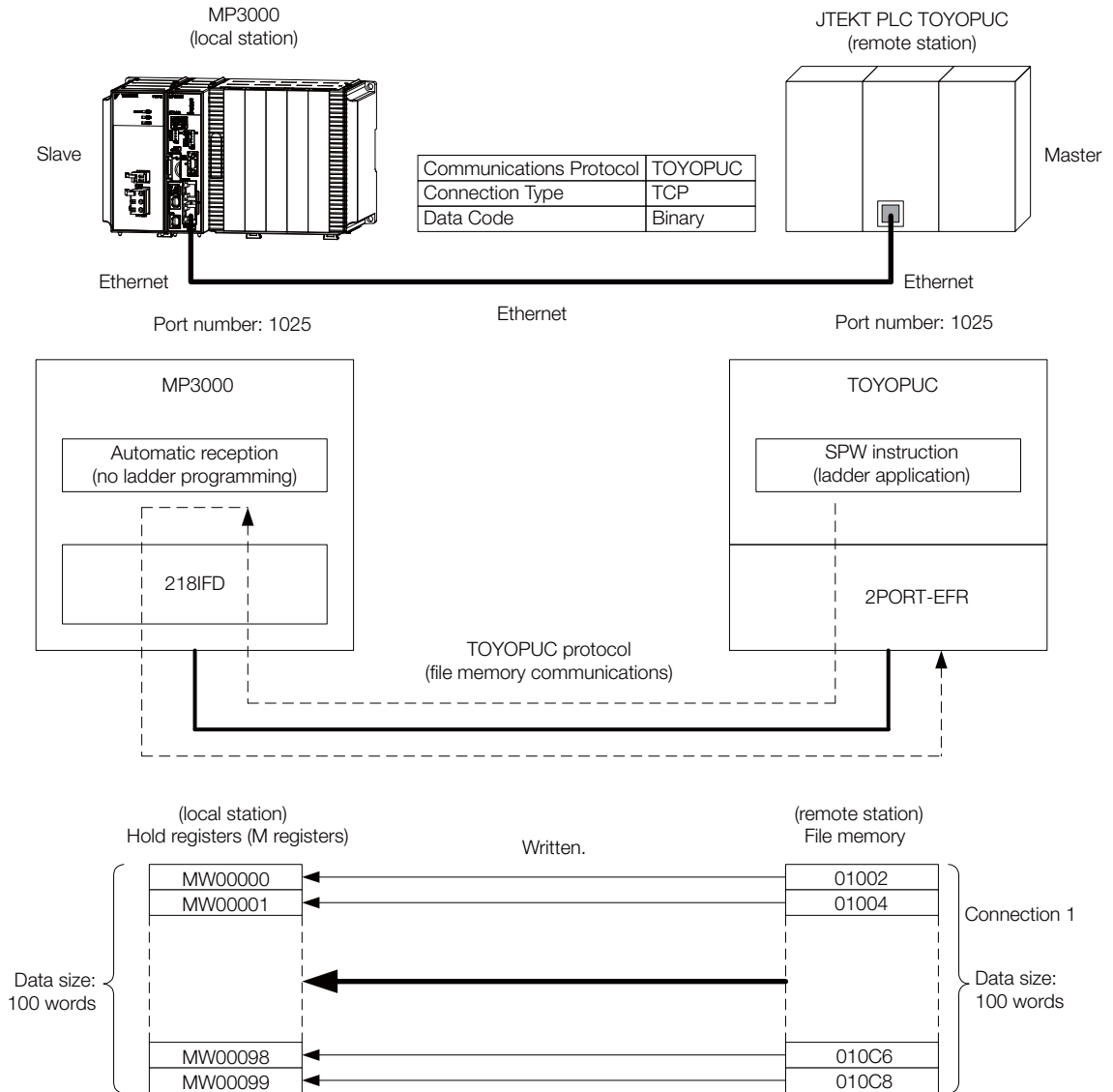

◆ MP3000 Setup

Use the following procedure to set up the MP3000.

Information If the communications parameters (IP address and subnet mask) have already been set, skip to step 3.

1. Double-click the cell for 218IFD in the Module Configuration Definition Tab Page.

Module	Function Module/Slave	Status	Circuit No./AxisAddress		Motion Register	Register(Input/Output)		
			Start	cupied circui		Disabled	Start - End	Size
01 [CPU-302(32axes)] : ---								
00 CPU302(32) [-----]	01 CPU	----	----	----	----	----	----	----
	02 218IFD	----	0 Circuit No1	1	----	<input type="checkbox"/> Input <input type="checkbox"/> OutPut	0000 - 07FF[H]	2048
	03 SVC32	----	0 Circuit No1	1	8000 - 87FF[H]	<input type="checkbox"/> Input <input type="checkbox"/> OutPut	0800 - 0BFF[H]	1024
	04 SVR32	----	0 Circuit No3	1	9000 - 97FF[H]	----	----	----
	05 M-EXECUTOR	----	----	----	----	----	0C00 - 0C3F[H]	64
	06 -- UNDEFINED --	----	----	----	----	----	----	----
	07 -- UNDEFINED --	----	----	----	----	----	----	----
01 -- UNDEFINED -- [-----]								
02 -- UNDEFINED -- [-----]								
03 -- UNDEFINED -- [-----]								
02 -- UNDEFINED --								
02 -- UNDEFINED --								
03 -- UNDEFINED --								
04 -- UNDEFINED --								

The 218IFD Detail Definition Dialog Box will be displayed.

2. Set the communications parameters.

Transmission Parameters: [Status]

Transmission Parameters

IP Address : [192] [168] [001] [001] (0-255) Module Name Definition
Equipment name : [CONTROLLER NAME]

Subnet Mask : [255] [255] [255] [0] (0-255)

Gateway IP Address : [0] [0] [0] [0] (0-255) [Detail Definition]

① In the [IP Address] Boxes, enter the following address: 192.168.001.001.

② In the [Subnet Mask] Boxes, enter the following mask: 255.255.255.000.

③ In the [Gateway IP Address] Boxes, enter the following address: 000.000.000.000.

3. Click the [Easy setting] Button in the [Message Communication] Area in the [Connection Parameter] Area.

Connection Parameter

Message Communication

The following parameters for message communications can be easily set.
Connections(C NO) 01-10 can be set to receive data automatically.

Easy setting

CNO	Local Port	Node IP Address	Node Port	Connect Type	Protocol Type	Code	Detail
01	----						Setting*
02	----						Setting*
03	----						Setting*
04	----						Setting*
05	----						Setting*
06	----						Setting*
07	----						Setting*

The Message Communications Easy Setting Dialog Box will be displayed.

4. Set the connection parameters.

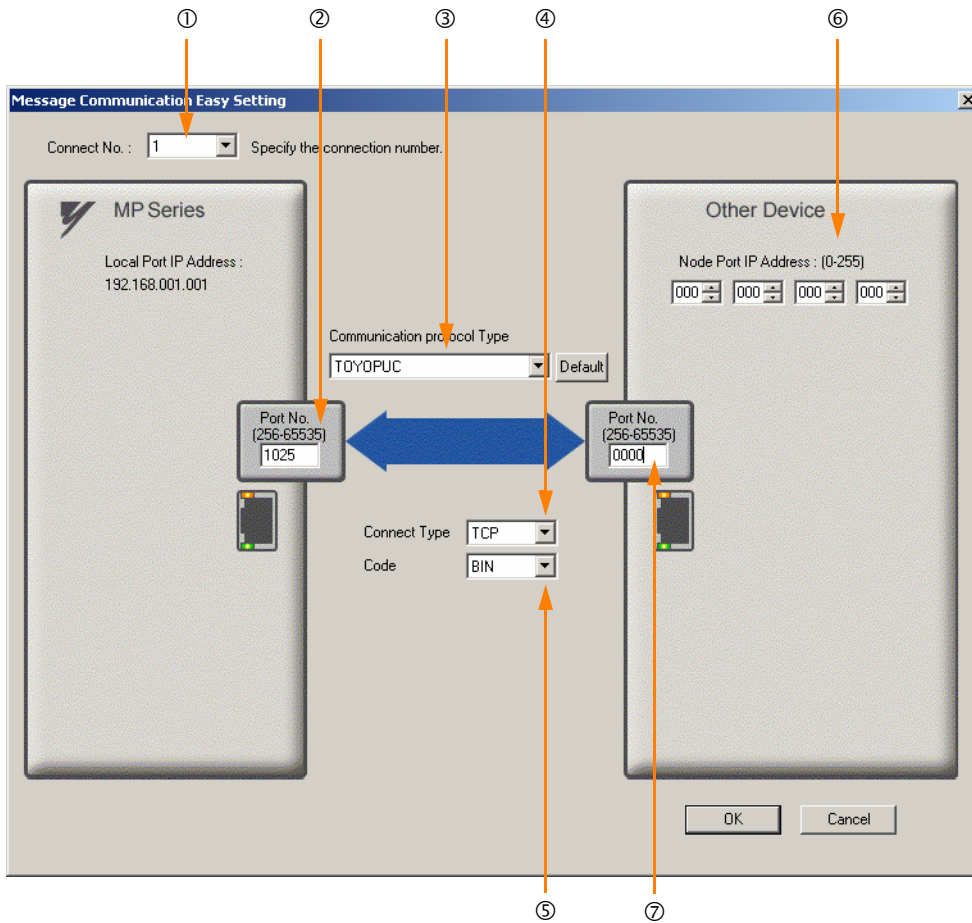

- ① Select [1] in the [Connect No.] Box.
- ② Enter "1025" in the [Port No.] Box for the MP-series Controller.
- ③ Select [TOYOPUC] in the [Communication Protocol Type] Box.
- ④ Select [TCP] in the [Connect Type] Box.
- ⑤ Select [BIN] in the [Code] Box.
- ⑥ Enter the following address in the [Node Port IP Address] Boxes for the other device:
000.000.000.000.
- ⑦ Enter "0000" in the [Port No.] Box for the other device.

Note: 1. When using automatic reception, do not use the MSG-SNDE and MSG-RCVE functions on connection 01. Automatic reception for connection 01 is set to [Enable] by default.
 2. The settings in the above screen capture will open an unpassive connection because the remote station port and IP address are set to 0. To open a full passive connection, enter a port number and IP address for the remote device in steps (6) and (7).
 3. If communicating by UDP, select [UDP] in the [Connect Type] Box.

5. Click the [OK] Button.

6. Click the [Yes] Button in the Transmission Parameters Confirmation Dialog Box.

Note: If parameters have already been set for the same connection number and you click the [Yes] Button in the Transmission Parameters Confirmation Dialog Box, the settings will be overwritten by the parameters that are set in the Message Communications Easy Setting Dialog Box.

7. Check the settings and double-click the [Setting] Button in the [Detail] Column.

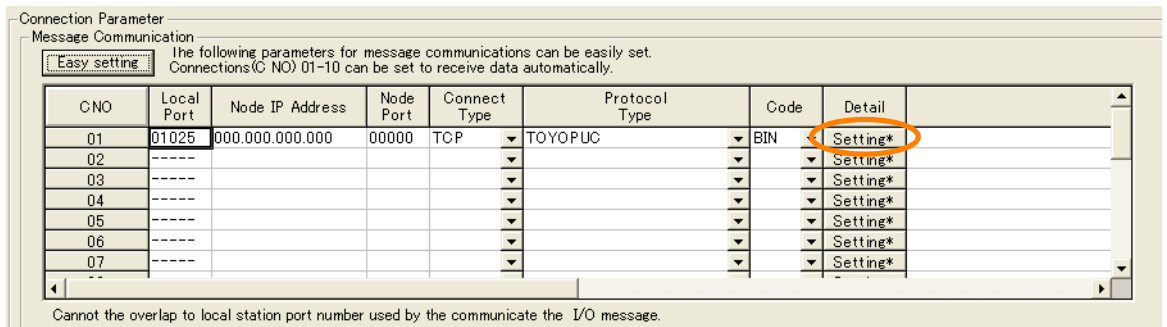

8. Select the [Enable] Option in the Automatically Reception Tab Page and then click the [OK] Button.

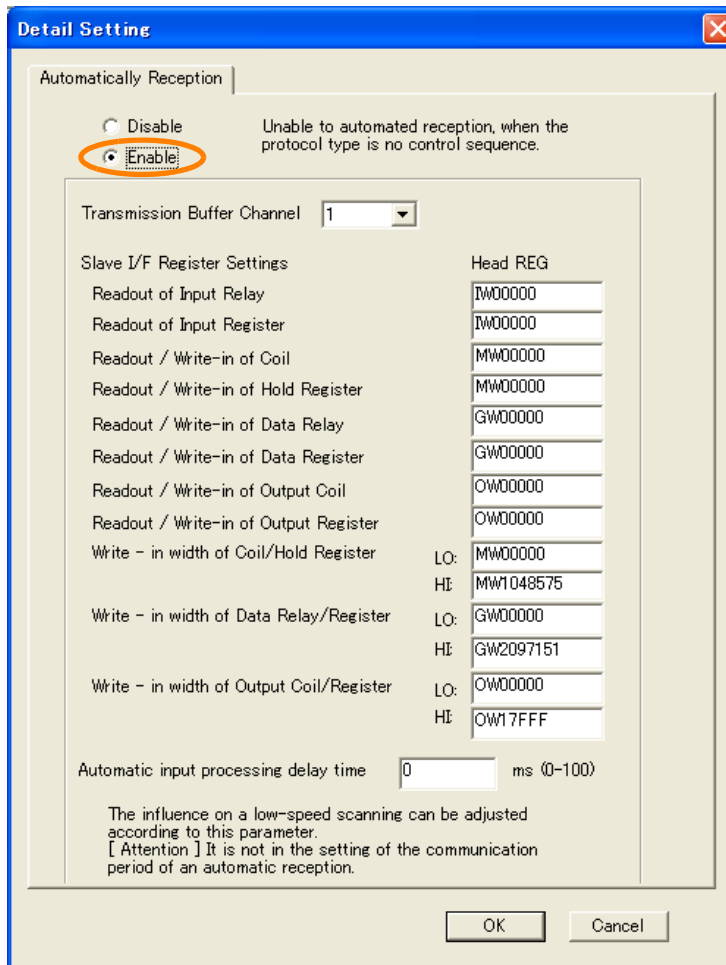

Note: Disable automatic reception for any connection for which message functions (MSG-SNDE and MSG-RCVE) are used. If message functions are used while automatic reception is enabled, the communications will not function properly.

9. Save the data to flash memory.

Note: Changes made to the communications or connection parameters will become effective only after the changes have been saved to flash memory and the power supply has been cycled.

This concludes the settings for using the MP3000 as a slave.

◆ Setting the Remote Device (JTEKT PLC)

Use the following procedure to set up the JTEKT TOYOPUC PLC.

Information TOYOPUC PLCs are manufactured by JTEKT Corporation. Refer to the following manual for details.
 Manual for the 2PORT-EFR Module from JTEKT Corporation

1. Set the Ethernet settings and baud rate using the DIP switch on the 2PORT-EFR Module.
2. Start the PCWIN.
3. Set up the I/O Module. The identification code for a 2PORT-EFR module that has been set up to use Ethernet communications is “B3”.
4. Set the Link Module name. In the Link Parameter Dialog Box, select the rack number and slot number to assign to the 2PORT-EFR Module, and set the Link Module name to [Ethernet].
5. Set the communications parameters.

Table 4.20 Ethernet Settings Example

Parameter	Description
Own Node IP Address	192.168.1.2
Connection 1	Use
Open Protocol	TCP Active Open
Own Node Port No.	1025
Other Node Table No.	1

Table 4.21 Other Node Table Settings Example

Parameter	Description
Table 1	Use
Other Node IP Address	192.168.1.1
Other Node Port No.	1025

Table 4.22 Timers Settings Example

Parameter	Description
Reset Wait Resending Times	As required.
Non-Reception Timer	As required.
Response Timer	As required.
Resending Timer (Data)	As required.
Resending Timer (SYN/FIN)	As required.
Close Timer	As required.
Packet Alive Time	As required.
IP Assembly Timer	As required.

Table 4.23 Sub-Net Mask and Gateway IP Address Settings Example

Parameter	Description
Subnet Mask	255.255.255.0
Gateway IP Address	As required.

Note: When using automatic reception on a TCP connection, set the open protocol setting on the 2PORT-EFR module to [TCP Active Open]. The MP3000 is capable of opening a TCP connection as a specified passive node or a non-specified passive node.

6. Create a ladder program to send data to the send data area in the file memory on network connection 1.

Note: Refer to the following manual for information on ladder programming using the SPW instruction.
 Manual for the 2PORT-EFR Module from JTEKT Corporation

This concludes the setup.

◆ Starting Communications

Use the following procedure to write the data in the file memory in the JTEKT PLC to the hold registers in the MP3000.

- 1. Turn ON the power to the MP3000 to start receiving messages.**
The system will automatically start the message reception operation. No further operation is required.
- 2. Start the processing to open connection 1 from the JTEKT PLC to start data transmissions.**

Note: The MP3000 will wait for the TCP connection after it starts the automatic reception operation. Therefore, the power supply to the MP3000 must be turned ON before the power supply to the JTEKT PLC.

4.7.2 Using the MSG-RCVE Function with the MP3000 as a Slave

This section describes how to communicate with a JTEKT PLC by using the MSG-RCVE function.

When a JTEKT PLC is used as the master to write data to the file memory in the 2PORT-EFR, you will need to create a ladder application that uses the SPW instruction.

Information The SPW instruction is used to write data to the file memory in the 2PORT-EFR. Refer to the following manual for details.
 📖 Manual for the 2PORT-EFR Module from JTEKT Corporation

Communications Format

The MP3000 acts as a slave and receives data and returns a response to the master by using the communications formats for file memory commands that are shown below. Execution of the MSG-RCVE function in the MP3000 ends when a response is returned.

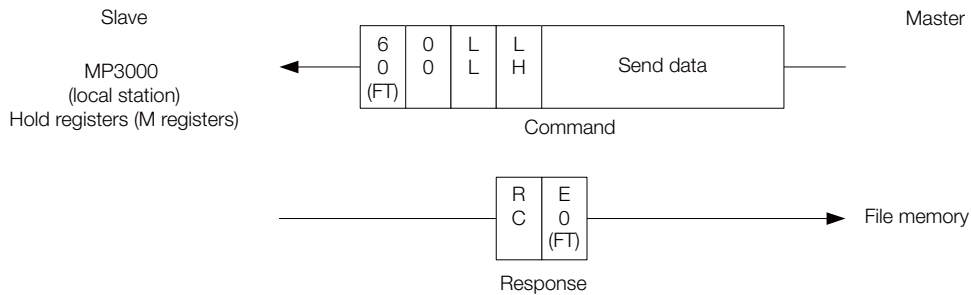

Note: In the figure shown above, the Ethernet header, TCP/UDP header, FCS and other items have been omitted. Only the data portion of the communications format is shown.

File Memory and Corresponding Registers in the MP3000

The following table shows the relationship between registers in the MP3000 and the send data area of file memory in the 2PORT-EFR.

Regardless of the connection number of the 2PORT-EFR, the MP3000 stores data from the first address (MW00000) of the hold registers by default. To store the data in a specific hold register, use the hold register offset parameters (PARAM26 and PARAM27) in the MSG-RCVE function. Thus, if PARAM26 and PARAM27 are set to 10,000, the data sent from the 2PORT-EFR will be stored in the registers starting from MW10000.

Data Range		
2PORT-EFR Module		MP3000 Hold Register Data Area Addresses
File memory Data Area	File Memory Send/Receive Data Area Addresses	
Connection 1	1000: Data size, 1002 to 17FD: Send data	Storage area*: MW00000 to MW01021
Connection 2	2000: Data size, 2002 to 27FD: Send data	
Connection 3	3000: Data size, 3002 to 37FD: Send data	
Connection 4	4000: Data size, 4002 to 47FD: Send data	
Connection 5	5000: Data size, 5002 to 57FD: Send data	
Connection 6	6000: Data size, 6002 to 67FD: Send data	
Connection 7	7000: Data size, 7002 to 77FD: Send data	
Connection 8	8000: Data size, 8002 to 87FD: Send data	

* The hold register offset parameter in the MSG-RCVE function allows you to make any address between MW00000 and MW65534 the first address.

Transfer Size

The following table lists the data sizes that can be received in a single file memory command when using the MSG-RCVE function.

Applicable Model	Data size
MP3000	1 to 1,022 words Specify the number of whole words.

Setting Example

The following figure illustrates how the contents of 200 words from the 3002 to 3191 file memory addresses in the JTEKT PLC master are written to the MW05000 to MW05199 hold registers in the MP3000 slave.

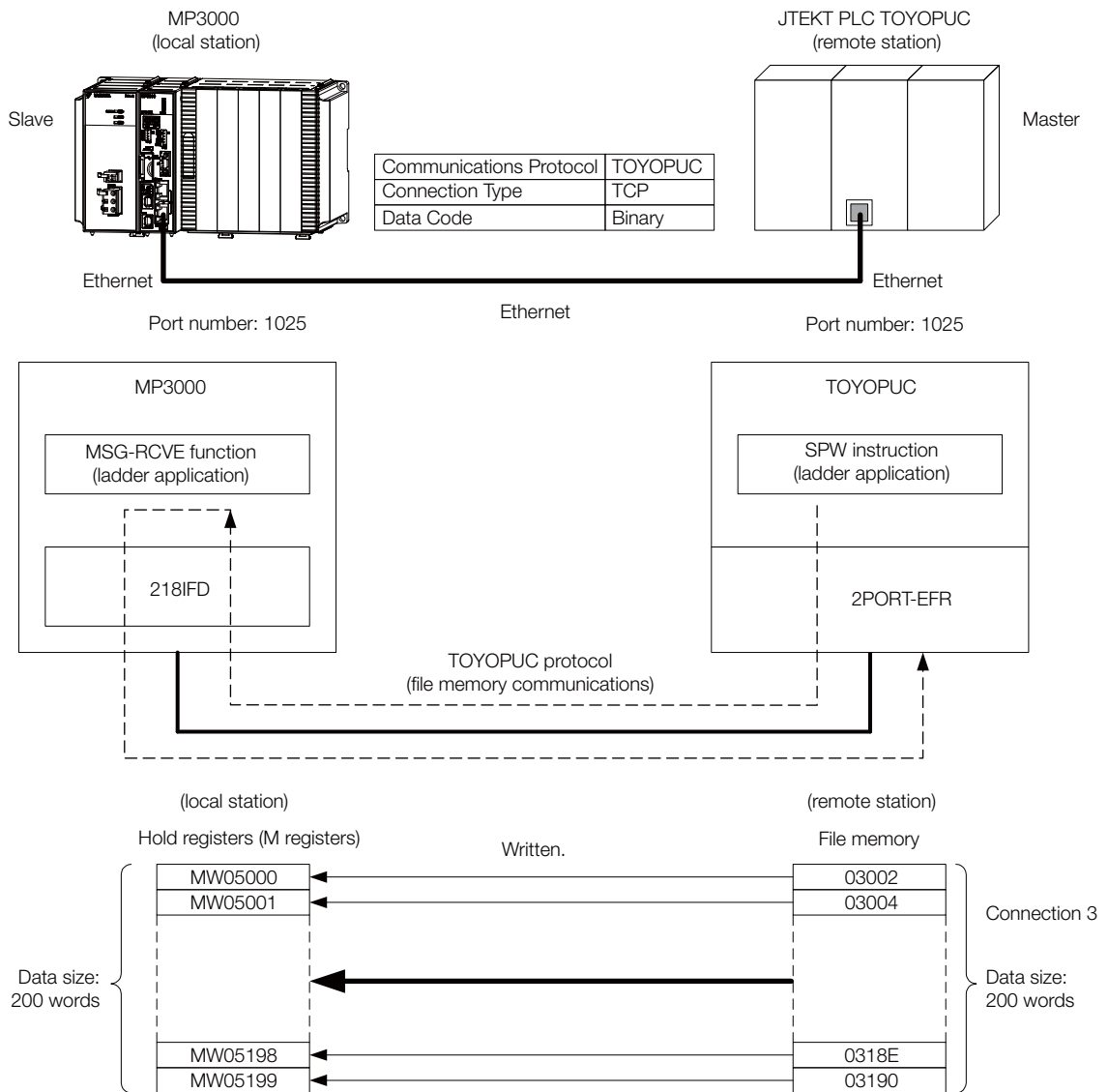

◆ MP3000 Setup

Use the following procedure to set up the MP3000.

Information If the communications parameters (IP address and subnet mask) have already been set, skip to step 3.

1. Double-click the cell for 218IFD in the Module Configuration Definition Tab Page.

Module	Function Module/Slave	Status	Circuit No./AxisAddress		Motion Register	Register(Input/Output)		
			Start	cupied circ.		Disabled	Start - End	Size
01 [CPU-302(32axes)] : ---	01 CPU	----	----	----	----	-----	-----	----
01 MBL-303	02 218IFD	----	☐	Circuit No1	1	-----	☐ Input ☐ OutPut	0000 - 07FF[H] 2048
	03 SVC32	----	☐	Circuit No1	1	8000 - 87FF[H]	☐ Input ☐ OutPut	0800 - 0BFF[H] 1024
	04 SVR32	----	☐	Circuit No3	1	9000 - 97FF[H]	-----	-----
	05 M-EXECUTOR	----	----	----	----	-----	-----	0C00 - 0C3F[H] 64
	06 -- UNDEFINED --	----	-----	-----	-----	-----	-----	-----
	07 -- UNDEFINED --	----	-----	-----	-----	-----	-----	-----
	01 -- UNDEFINED -- [-----]	----	-----	-----	-----	-----	-----	-----
02 -- UNDEFINED -- [-----]	----	-----	-----	-----	-----	-----	-----	
03 -- UNDEFINED --	----	-----	-----	-----	-----	-----	-----	
02 -- UNDEFINED --	----	-----	-----	-----	-----	-----	-----	
02 -- UNDEFINED --	----	-----	-----	-----	-----	-----	-----	
03 -- UNDEFINED --	----	-----	-----	-----	-----	-----	-----	
04 -- UNDEFINED --	----	-----	-----	-----	-----	-----	-----	

The 218IFD Detail Definition Dialog Box will be displayed.

2. Set the communications parameters.

- ① In the [IP Address] Boxes, enter the following address: 192.168.001.001.
- ② In the [Subnet Mask] Boxes, enter the following mask: 255.255.255.000.
- ③ In the [Gateway IP Address] Boxes, enter the following address: 000.000.000.000.

3. Click the [Easy setting] Button in the [Message Communication] Area in the [Connection Parameter] Area.

CNO	Local Port	Node IP Address	Node Port	Connect Type	Protocol Type	Code	Detail
01	-----						Setting*
02	-----						Setting*
03	-----						Setting*
04	-----						Setting*
05	-----						Setting*
06	-----						Setting*
07	-----						Setting*

The Message Communications Easy Setting Dialog Box will be displayed.

4. Set the connection parameters.

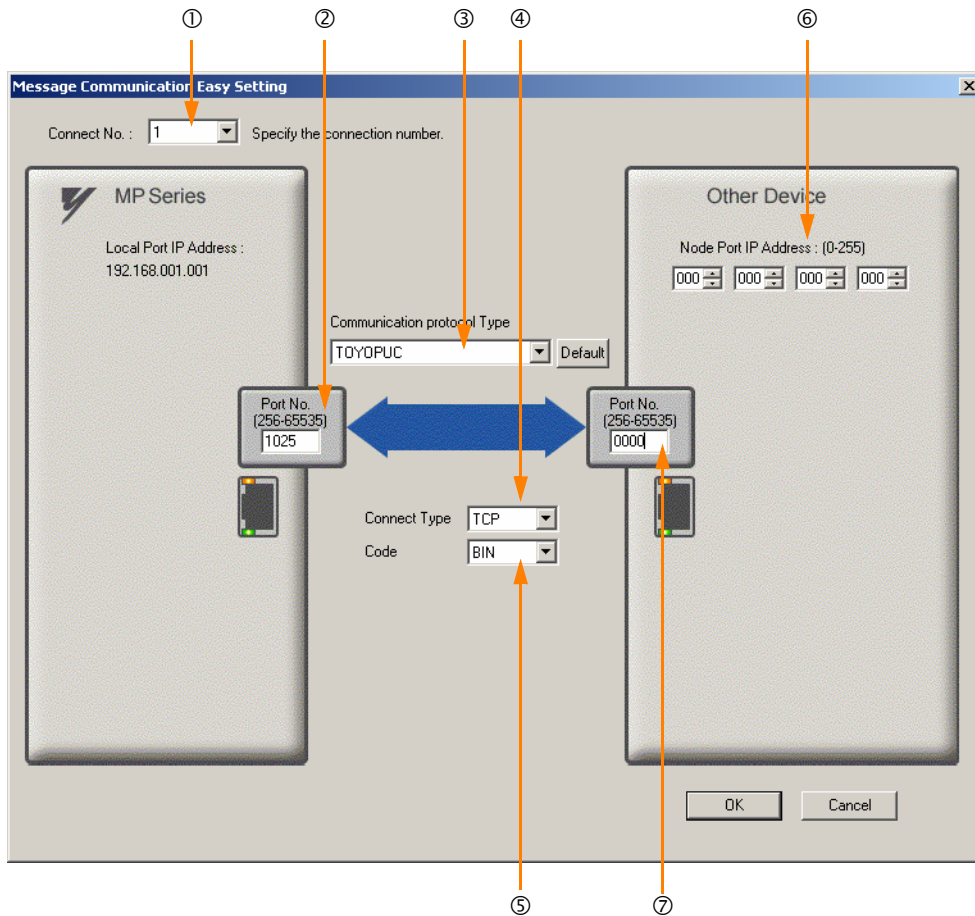

- ① Select [1] in the [Connect No.] Box.
- ② Enter "1025" in the [Port No.] Box for the MP-series Controller.
- ③ Select [TOYOPUC] in the [Communication Protocol Type] Box.
- ④ Select [TCP] in the [Connect Type] Box.
- ⑤ Select [BIN] in the [Code] Box.
- ⑥ Enter the following address in the [Node Port IP Address] Boxes for the other device:
000.000.000.000.
- ⑦ Enter "0000" in the [Port No.] Box for the other device.

Note: 1. Disable automatic reception for any connection for which message functions (MSG-SNDE and MSG-RCVE) are used. If message functions are used while automatic reception is enabled, the communications will not function properly.
2. The settings in the above screen capture will open an unpassive connection because the remote station port and IP address are set to 0. To open a full passive connection, enter a port number and IP address for the remote device in steps (6) and (7).
3. If communicating by UDP, select [UDP] in the [Connect Type] Box.

5. Click the [OK] Button.

6. Click the [Yes] Button in the Transmission Parameters Confirmation Dialog Box.

Note: If parameters have already been set for the same connection number and you click the [Yes] Button in the Transmission Parameters Confirmation Dialog Box, the settings will be overwritten by the parameters that are set in the Message Communications Easy Setting Dialog Box.

7. Check the settings and double-click the [Setting] Button in the [Detail] Column.

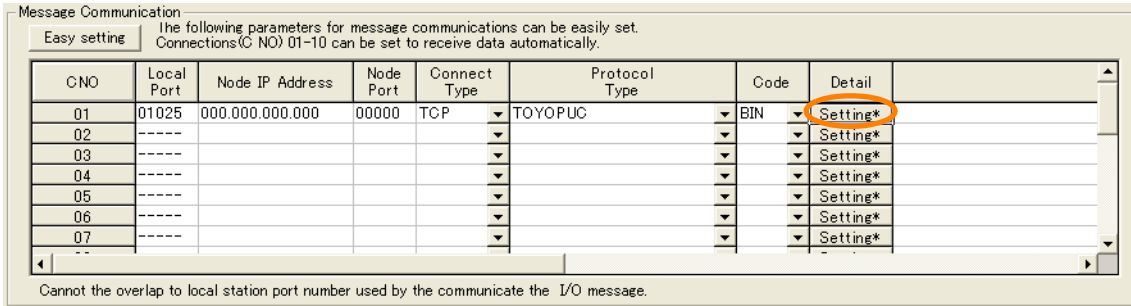

8. Select the [Disable] Option in the Automatically Reception Tab Page and then click the [OK] Button.

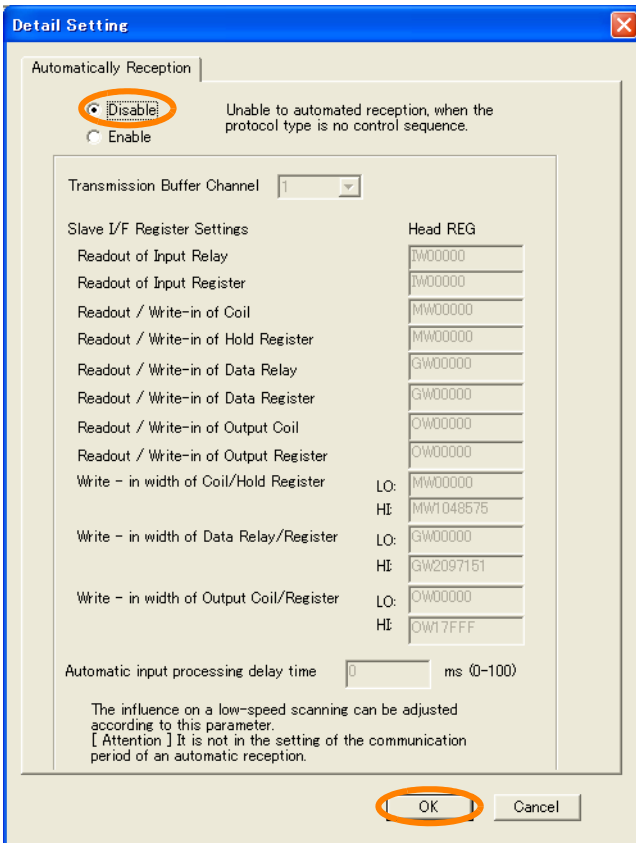

Note: Changes made to the communications or connection parameters will become effective only after the changes have been saved to flash memory and the power supply has been cycled.

9. Create a ladder program for the MSG-RCVE function.

A ladder program example is shown below.

```

setting parameter for MSG-RCVE function during first scan after power on.
SB000003 for low scan and SB000001 for high scan.

0 0/2 IF 'After Low Scan Start, Only 1 Scan ON' == 'TRUE'
    SB000003 == TRUE;

1 1/2 NL
    SETW DWO0000 00000 00200

2 2/2 NL
    EXPRESSION
    'DWO0110'=1
    DWO0110=1; //using connection No.1

3 3/2 NL
    EXPRESSION
    'DWO0120'=0
    DWO0120=0; //coil offset MB low (0)
    'DWO0121'=0
    DWO0121=0; //coil offset MB high (0)
    'DWO0122'=0
    DWO0122=0; //input relay offset IB low (0)
    'DWO0123'=0
    DWO0123=0; //input relay offset IB high (0)
    'DWO0124'=0
    DWO0124=0; //input register offset IW low (0)
    'DWO0125'=0
    DWO0125=0; //input register offset IW high (0)
    'DWO0126'=0
    DWO0126=0; //hold register offset MW low (0)
    'DWO0127'=0
    DWO0127=0; //hold register offset MW high (0)
    'DWO0128'=0
    DWO0128=0; //data relay offset GB low (0)
    'DWO0129'=0
    DWO0129=0; //data relay offset GB high (0)
    'DWO0130'=0
    DWO0130=0; //data register offset GW low (0)
    'DWO0131'=0
    DWO0131=0; //data register offset GW high (0)
    'DWO0132'=0
    DWO0132=0; //output coil offset OB low (0)
    'DWO0133'=0
    DWO0133=0; //output coil offset OB high (0)
    'DWO0134'=0
    DWO0134=0; //output register offset OW low (0)
    'DWO0135'=0
    DWO0135=0; //output register offset OW high (0)

4 4/2 NL
    EXPRESSION
    'DWO0136'=0x000
    DWO0136=0x000; //M writing range LO low
    'DWO0137'=0x000
    DWO0137=0x000; //M writing range LO high
    'DWO0138'=0xFFFF
    DWO0138=0xFFFF; //M writing range HI low
    'DWO0139'=0x000F
    DWO0139=0x000F; //M writing range HI high

5 5/2 NL
    EXPRESSION
    'DWO0140'=0x000
    DWO0140=0x000; //G writing range LO low
    'DWO0141'=0x000
    DWO0141=0x000; //G writing range LO high
    'DWO0142'=0xFFFF
    DWO0142=0xFFFF; //G writing range HI low
    'DWO0143'=0x001F
    DWO0143=0x001F; //G writing range HI high

6 6/2 NL
    EXPRESSION
    'DWO0144'=0x000
    DWO0144=0x000; //O writing range LO low
    'DWO0145'=0x000
    DWO0145=0x000; //O writing range LO high
    'DWO0146'=0x7FFF
    DWO0146=0x7FFF; //O writing range HI low
    'DWO0147'=0x0001
    DWO0147=0x0001; //O writing range HI high

7 7/2 NL
    END_IF
  
```

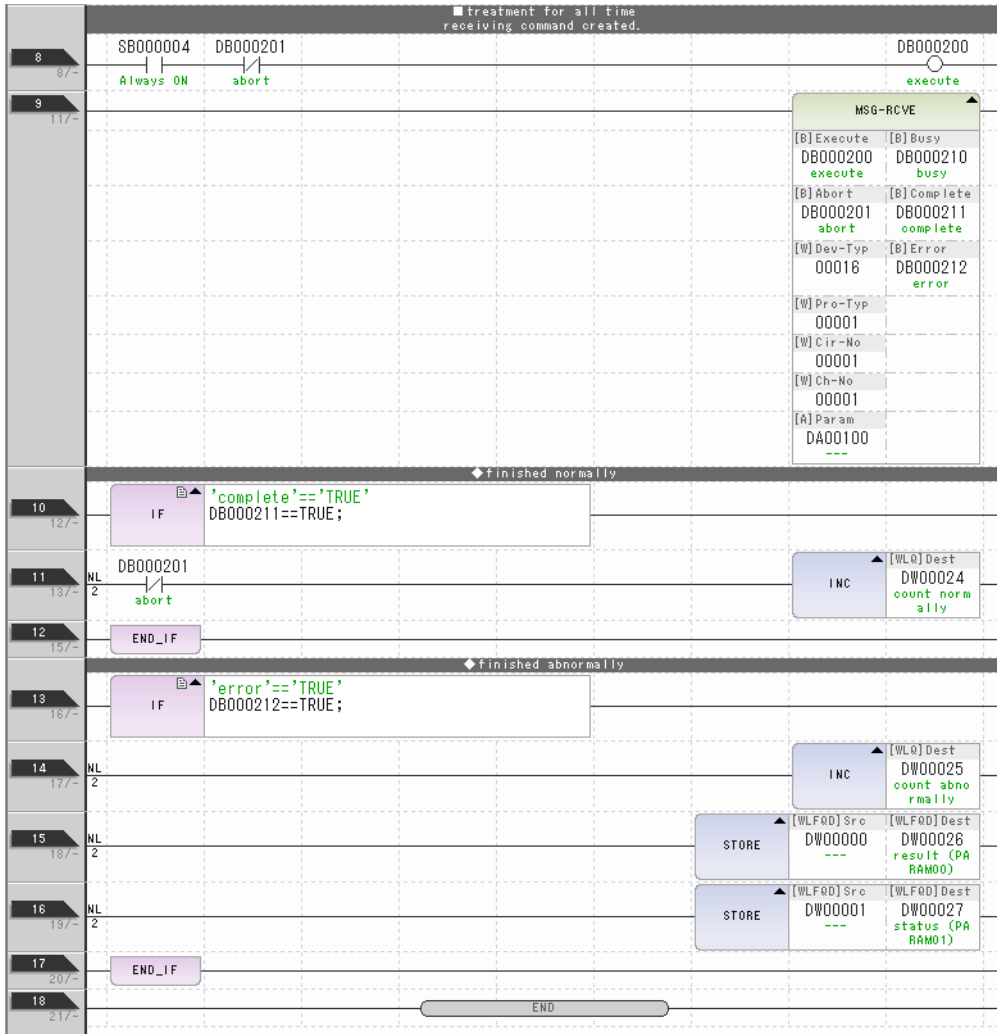

10. Save the data to flash memory.

This concludes the settings for using the MP3000 as a slave.

◆ Setting the Remote Device (JTEKT PLC)

Use the following procedure to set up the JTEKT TOYOPUC PLC.

Information TOYOPUC PLCs are manufactured by JTEKT Corporation. Refer to the following manual for details.
 Manual for the 2PORT-EFR Module from JTEKT Corporation

1. Set the Ethernet settings and baud rate using the DIP switch on the 2PORT-EFR Module.
2. Start the PCWIN.
3. Set up the I/O Module. The identification code for a 2PORT-EFR module that has been set up to use Ethernet communications is “B3”.
4. Set the link module name. In the Link Parameter Dialog Box, select the rack number and slot number to assign to the 2PORT-EFR Module, and set the Link Module name to [Ethernet].

5. Set the communications parameters.

Table 4.24 Ethernet Settings Example

Parameter	Description
Own Node IP Address	192.168.1.2
Connection 3	Use
Open Protocol	TCP Active Open
Own Node Port No.	1025
Other Node Table No.	1

Table 4.25 Other Node Table Settings Example

Parameter	Description
Table 1	Use
Other Node IP Address	192.168.1.1
Other Node Port No.	1025

Table 4.26 Timers Settings Example

Parameter	Description
Reset Wait Resending Times	As required.
Non-Reception Timer	As required.
Response Timer	As required.
Resending Timer (Data)	As required.
Resending Timer (SYN/FIN)	As required.
Close Timer	As required.
Packet Alive Time	As required.
IP Assembly Timer	As required.

Table 4.27 Sub-Net Mask and Gateway IP Address Settings Example

Parameter	Description
Subnet Mask	255.255.255.0
Gateway IP Address	As required.

Note: When communicating with TCP and the open protocol setting on the 2PORT-EFR is set to [TCP Active Open], execute the MSG-RCVE function on the MP3000 to receive messages. If the open protocol setting on the 2PORT-EFR is set to [TCP Destination] - [Specified Passive], or [TCP Non-Specified Passive], execute the MSG-SNDE function in the MP3000. The MP3000 is capable of operating as a TCP active node when using the MSG-SNDE function, and as a TCP specified passive node or TCP non-specified passive node when using the MSG-RCVE function.

6. Create a ladder program to send data to the send data area in the file memory on network connection 1.

Note: Refer to the following manual for information on ladder programming using the SPW instruction.

 Manual for the 2PORT-EFR Module from JTEKT Corporation

This concludes the setup.

◆ Starting Communications

Use the following procedure to write the data in the file memory in the JTEKT PLC to the hold registers in the MP3000.

1. Turn ON the power to the MP3000 to start receiving messages.

In the ladder programming example, the message receive function is executed immediately after the scan starts in the MP3000. While the Machine Controller is operating, a normally ON coil is used to keep the message receive function executing.

2. Start the processing to open connection 3 from the JTEKT PLC to start data transmissions.

Note: The MP3000 will wait for the TCP connection after it starts execution of the MSG-RCVE function. Therefore, the power supply to the MP3000 must be turned ON before the power supply to the JTEKT PLC.

SB000004: Always ON Coil



4.7.3 Using the MSG-SNDE Function with the MP3000 as the Master

This section describes how to communicate with a JTEKT PLC by using the MSG-SNDE function.

When a JTEKT PLC is used as the slave to read data from the file memory in the 2PORT-EFR, you will need to create a ladder application that uses the SPR instruction.

Information The SPR instruction is used to read data from the file memory in the 2PORT-EFR. Refer to the following manual for details.

Manual for the 2PORT-EFR Module from JTEKT Corporation

Communications Format

The MP3000 acts as a master and sends data and receives responses using the communications formats for file memory commands that are shown below. Execution of the MSG-SNDE function ends when the response is received.

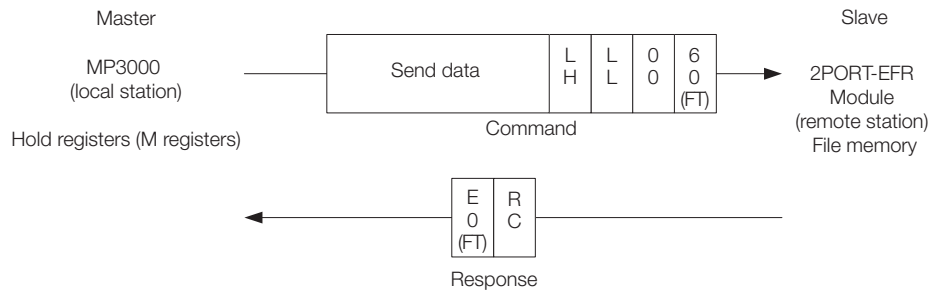

Note: In the figure shown above, the Ethernet header, TCP/UDP header, FCS and other items have been omitted. Only the data portion of the communications format is shown.

File Memory and Corresponding Registers in the MP3000

The following table shows the relationship between registers in the MP3000 and the receive data area of file memory in the 2PORT-EFR.

Regardless of the connection number of the 2PORT-EFR, the MP3000 can store the data from any hold registers into the receive data area in the file memory.

To specify the data to send, use the data address parameter (PARAM14 and PARAM15) and the hold register offset parameter (PARAM20, PARAM21 and PARAM22) of the MSG-SNDE function. Thus, if PARAM14 and PARAM15 are set to 10,000 and PARAM20 and PARAM21 are set to 20,000, and PARAM22 is set to 0, the data sent to the 2PORT-EFR will be read out of the registers from MW30000, which is the sum of MW10000 and MW20000.

Data Range		
2PORT-EFR Module		MP3000 Hold Register Data Area Addresses
File memory Data Area	File Memory Send/Receive Data Area Addresses	
Connection 1	1800: Data size, 1802 to 1FFD: Receive data	MW00000 to MW65534
Connection 2	2800: Data size, 2802 to 2FFD: Receive data	
Connection 3	3800: Data size, 3802 to 3FFD: Receive data	
Connection 4	4800: Data size, 4802 to 4FFD: Receive data	
Connection 5	5800: Data size, 5802 to 5FFD: Receive data	
Connection 6	6800: Data size, 6802 to 6FFD: Receive data	
Connection 7	7800: Data size, 7802 to 7FFD: Receive data	
Connection 8	8800: Data size, 8802 to 8FFD: Receive data	

Note: The data address setting and hold register offset setting in the MSG-SNDE function allow you to make any address between MW00000 and MW65534 the first address of the send data.

Transfer Size

The following table lists the size of data that can be transferred using the MSG-SNDE function.

Applicable Model	Data size
MP3000	1 to 1,022 words Specify the number of whole words.

Setting Example

The following figure illustrates how the contents of the 300 words from the MW30000 to MW30299 hold registers in the MP3000 master are written to the 5802 to 5A59 file memory addresses in the JTEKT PLC slave.

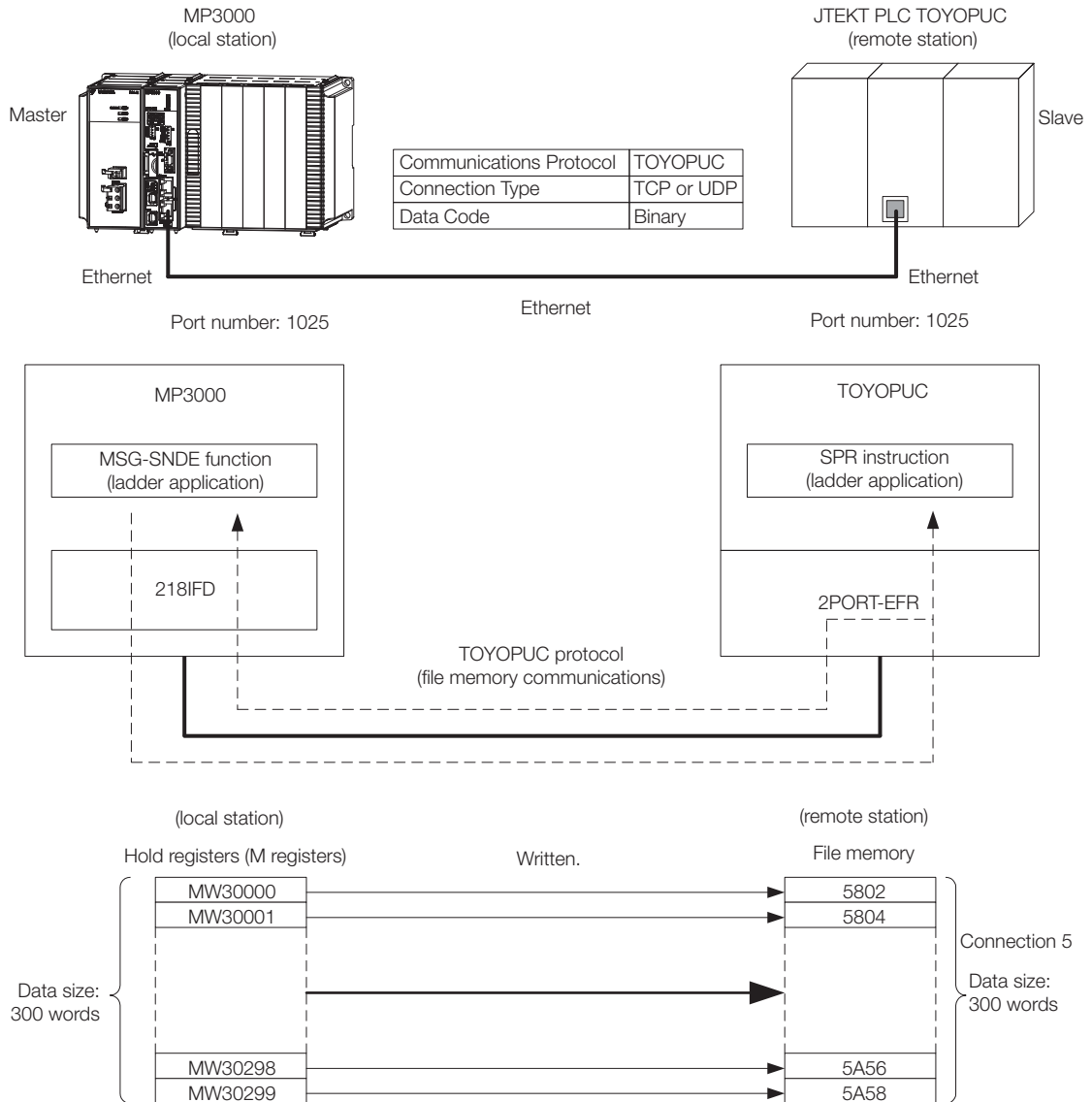

◆ MP3000 Setup

Use the following procedure to set up the MP3000.

Information If the communications parameters (IP address and subnet mask) have already been set, skip to step 3.

1. Double-click the cell for 218IFD in the Module Configuration Definition Tab Page.

Module	Function Module/Slave	Status	Circuit No./Axis Address		Motion Register	Register(Input/Output)		
			Start	cupied circuit		Disabled	Start - End	Size
01 [CPU-302(32axes)] : ---								
00 CPU302(32) [-----]	01 CPU	----	----	----	----	----	----	----
	02 218IFD	----	0 Circuit No1	1	----	Input Output	0000 - 07FF[H]	2048
	03 SVC32	----	0 Circuit No1	1	8000 - 87FF[H]	Input Output	0800 - 0BFF[H]	1024
	04 SVR32	----	0 Circuit No3	1	9000 - 97FF[H]	----	----	----
	05 M-EXECUTOR	----	----	----	----	----	0C00 - 0C3F[H]	64
	06 -- UNDEFINED --	----	----	----	----	----	----	----
	07 -- UNDEFINED --	----	----	----	----	----	----	----
01 -- UNDEFINED -- [-----]								
02 -- UNDEFINED -- [-----]								
03 -- UNDEFINED -- [-----]								
02 -- UNDEFINED --								
02 -- UNDEFINED --								
03 -- UNDEFINED --								
04 -- UNDEFINED --								

The 218IFD Detail Definition Dialog Box will be displayed.

2. Set the communications parameters.

Transmission Parameters: Status

Transmission Parameters

IP Address : 192 . 168 . 1 . 1 (0-255) Module Name Definition
Equipment name : CONTROLLER NAME

Subnet Mask : 255 . 255 . 255 . 0 (0-255)

Gateway IP Address : 0 . 0 . 0 . 0 (0-255) Detail Definition

① In the [IP Address] Boxes, enter the following address: 192.168.001.001.

② In the [Subnet Mask] Boxes, enter the following mask: 255.255.255.000.

③ In the [Gateway IP Address] Boxes, enter the following address: 000.000.000.000.

3. Click the [Easy Setting] Button in the [Message Communication] Area in the [Connection Parameter] Area.

Connection Parameter

Message Communication

The following parameters for message communications can be easily set.
Connections(C NO) 01-10 can be set to receive data automatically.

Easy setting

CNO	Local Port	Node IP Address	Node Port	Connect Type	Protocol Type	Code	Detail
01	----						Setting*
02	----						Setting*
03	----						Setting*
04	----						Setting*
05	----						Setting*
06	----						Setting*
07	----						Setting*

The Message Communications Easy Setting Dialog Box will be displayed.

4. Set the connection parameters.

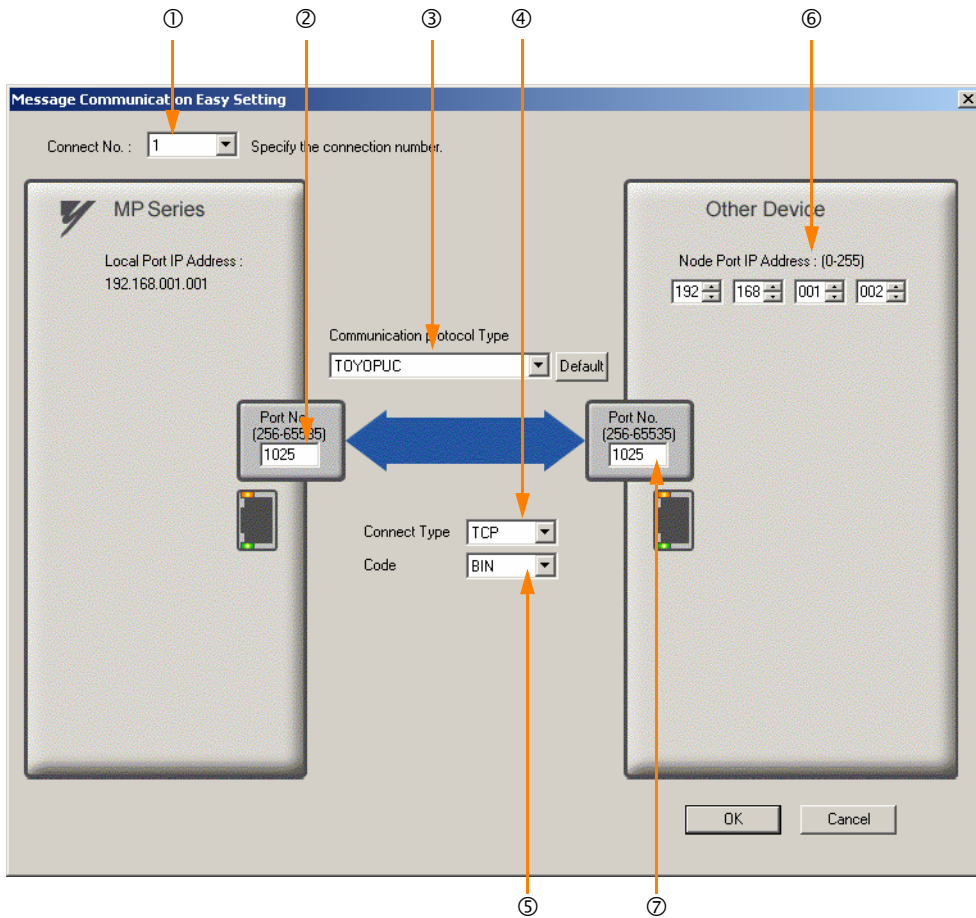

- ① Select [1] in the [Connect No.] Box.
- ② Enter "1025" in the [Port No.] Box for the MP-series Controller.
- ③ Select [TOYOPUC] in the [Communication Protocol Type] Box.
- ④ Select [TCP] in the [Connect Type] Box.
- ⑤ Select [BIN] in the [Code] Box.
- ⑥ Enter the following address in the [Node Port IP Address] Boxes for the other device:
192.168.001.002.
- ⑦ Enter "1025" in the [Port No.] Box for the other device.

Note: 1. Disable automatic reception for any connection for which message functions (MSG-SNDE and MSG-RCVE) are used. If message functions are used while automatic reception is enabled, the communications will not function properly.
 2. If the MP3000 is the master, or the client in the connection, specify a full passive connection by setting the IP address and port number for the remote device to non-zero values.
 3. If communicating by UDP, select [UDP] in the [Connect Type] Box.

5. Click the [OK] Button.

6. Click the [Yes] Button in the Transmission Parameters Confirmation Dialog Box.

Note: If parameters have already been set for the same connection number and you click the [Yes] Button in the Transmission Parameters Confirmation Dialog Box, the settings will be overwritten by the parameters that are set in the Message Communications Easy Setting Dialog Box.

7. Check the settings and double-click the [Setting] Button in the [Detail] Column.

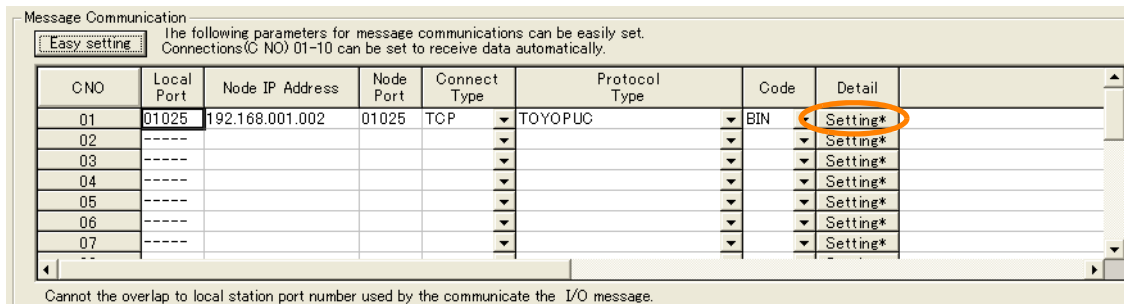

8. Select the [Disable] Option and then click the [OK] Button.

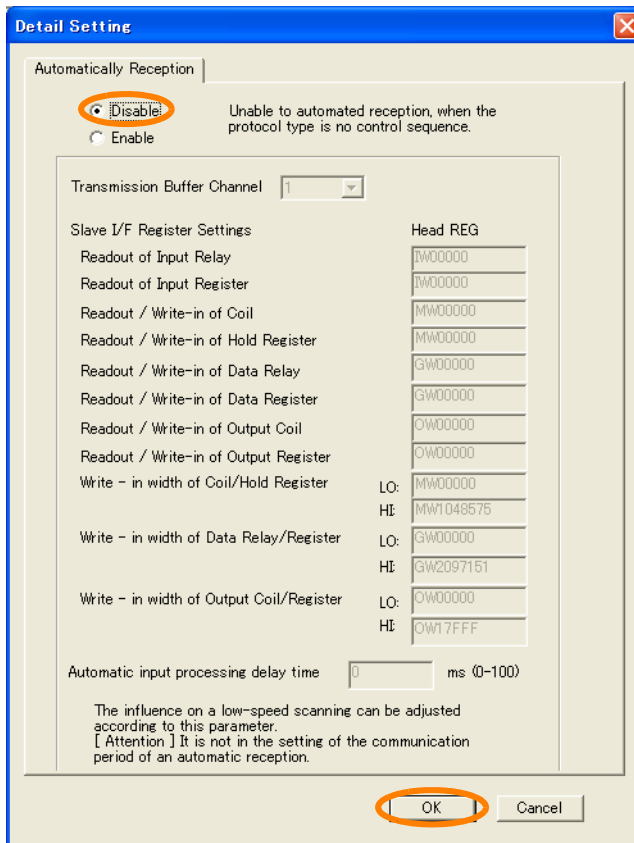

Note: Changes made to the communications or connection parameters will become effective only after the changes have been saved to flash memory and the power supply has been cycled.

9. Create a ladder program for the MSG-SNDE function.
A ladder program example is shown below.

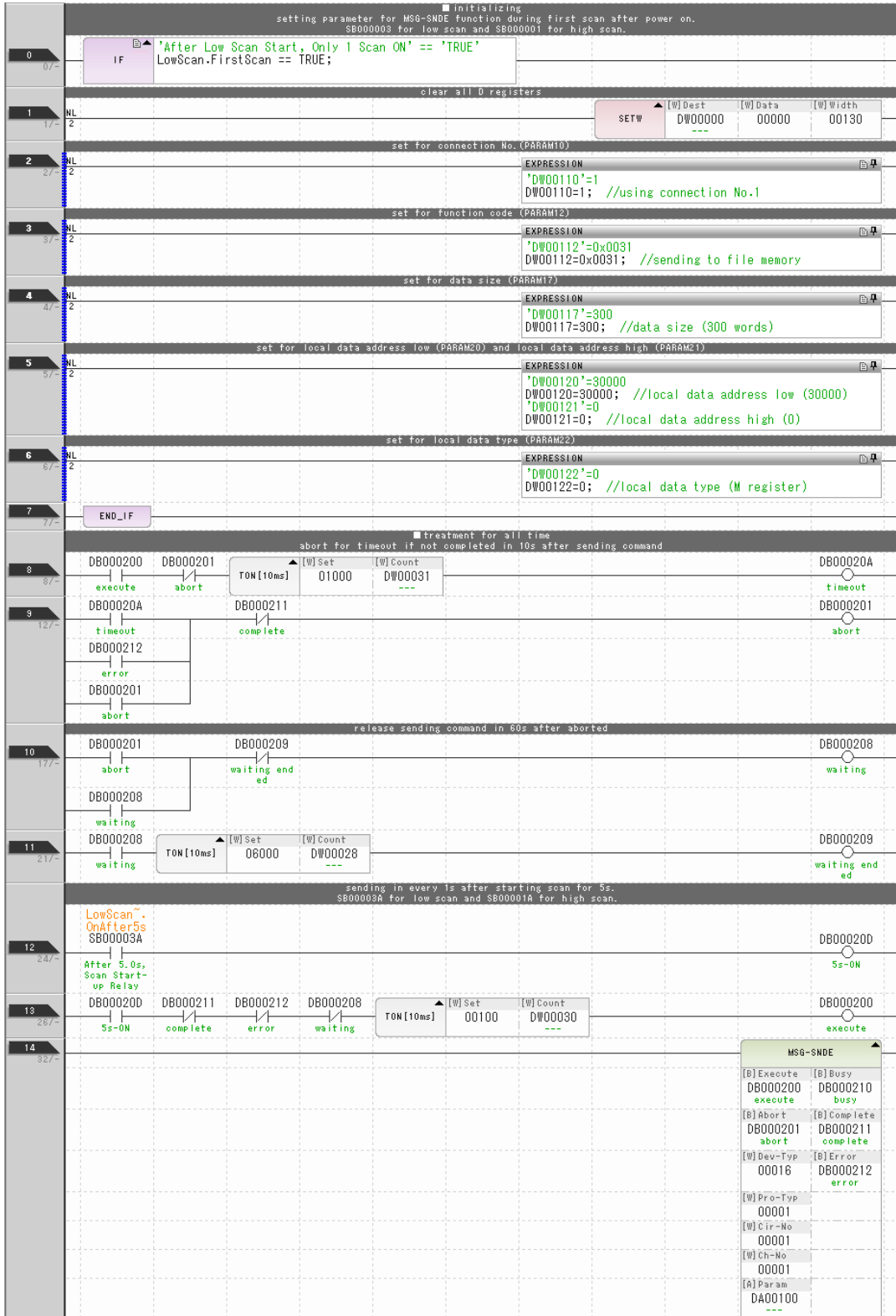

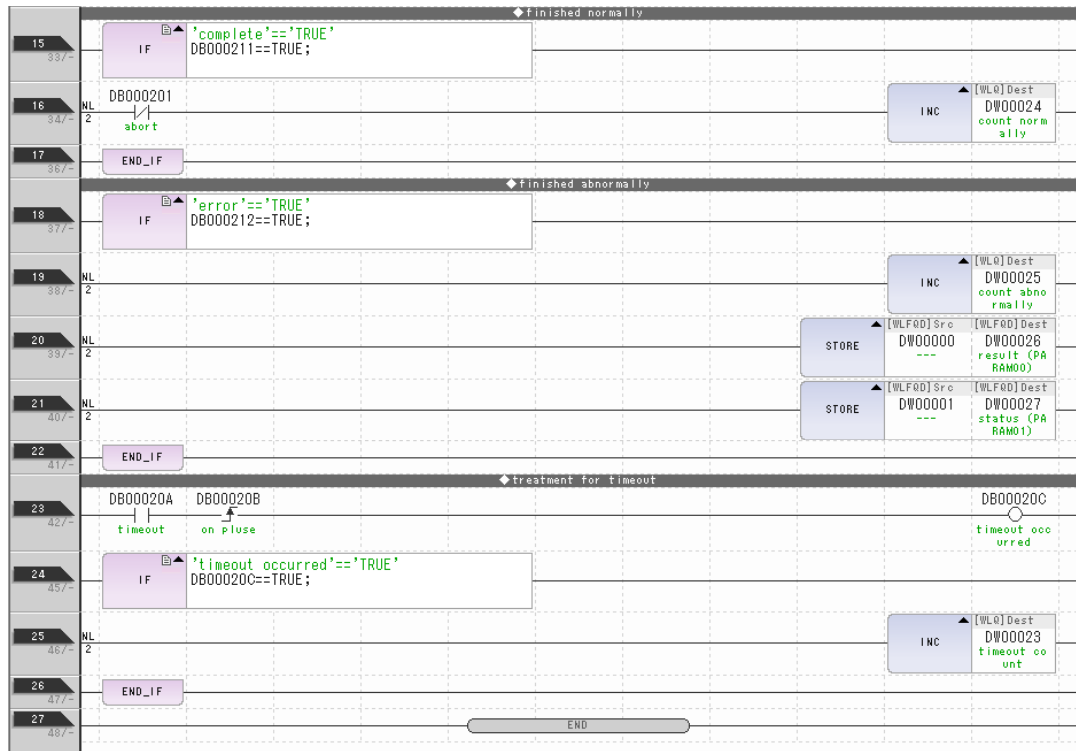

10. Save the data to flash memory.

This concludes the settings for using the MP3000 as the master.

◆ Setting the Remote Device (JTEKT PLC)

Use the following procedure to set up the JTEKT TOYOPUC PLC.

Information TOYOPUC PLCs are manufactured by JTEKT Corporation. Refer to the following manual for details.
 Manual for the 2PORT-EFR Module from JTEKT Corporation

1. Set the Ethernet settings and baud rate using the DIP switch on the 2PORT-EFR Module.
2. Start the PCWIN.
3. Set up the I/O Module. The identification code for a 2PORT-EFR module that has been set up to use Ethernet communications is "B3".
4. Set the link module name. In the Link Parameter Dialog Box, select the rack number and slot number to assign to the 2PORT-EFR Module, and set the Link Module name to [Ethernet].

5. Set the communications parameters.

Table 4.28 Ethernet Settings Example

Parameter	Description
Own Node IP Address	192.168.1.2
Connection 5	Use
Open Protocol	TCP Destination Specified Passive
Own Node Port No.	1025
Other Node Table No.	1

Table 4.29 Other Node Table Settings Example

Parameter	Description
Table 1	Use
Other Node IP Address	192.168.1.1
Other Node Port No.	1025

Table 4.30 Timers Settings Example

Parameter	Description
Reset Wait Resending Times	As required.
Non-Reception Timer	As required.
Response Timer	As required.
Resending Timer (Data)	As required.
Resending Timer (SYN/FIN)	As required.
Close Timer	As required.
Packet Alive Time	As required.
IP Assembly Timer	As required.

Table 4.31 Sub-Net Mask and Gateway IP Address Settings Example

Parameter	Description
Subnet Mask	255.255.255.0
Gateway IP Address	As required.

Note: When communicating with TCP and the open protocol setting on the 2PORT-EFR is set to [TCP Active Open], execute the MSG-RCVE function on the MP3000 to receive messages. If the open protocol setting on the 2PORT-EFR is set to [TCP Destination] - [Specified Passive], or [TCP Non-Specified Passive], execute the MSG-SNDE function in the MP3000. The MP3000 is capable of operating as a TCP active node when using the MSG-SNDE function, and as a TCP specified passive node or TCP non-specified passive node when using the MSG-RCVE function.

6. Create a ladder program for receive data from the receive data area in the file memory on network connection 5.

Note: Refer to the following manual for information on ladder programming using the SPR instruction.

 Manual for the 2PORT-EFR Module from JTEKT Corporation

This concludes the setup.

◆ Starting Communications

Use the following procedure to write the data in the hold registers in the MP3000 to the file memory of the JTEKT PLC.

1. Start the JTEKT PLC in TCP Destination - Specified Passive mode.

2. Turn ON the power to the MP3000 to start transmitting messages.

The ladder program example is designed to turn ON the Execute Bit (DB000200) in the message send function after six seconds has elapsed from when the low-speed scan (or high-speed scan) starts. Thereafter, the message send function is executed every second by alternating the Execute Bit (DB000200) between OFF and ON each time the message send function completes execution normally or with an error.

Note: The MP3000 will establish the TCP connection when it starts execution of the MSG-SNDE function.

SB00003A: Turns ON 5 seconds after start.

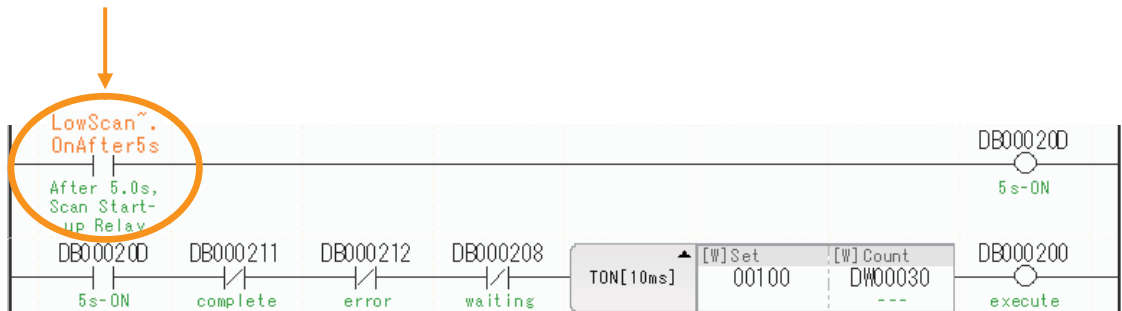

4.7.4 Message Functions

The message functions are used in user communications applications for the TOYOPUC protocol. You can send and receive message data by setting the necessary input items and parameters for the message functions. Message communications using the TOYOPUC protocol can be carried out with the same settings used for MEMOBUS messages.

Inputs and Outputs for the MSG-SNDE Function

I/O Definitions	No.	Name	I/O Designation	Meaning	Description
Input Items	1	Execute	B-VAL	Executes the transmission.	Specify the bit to use to execute the message transmission. When the Execute Bit turns ON, the message will be sent. Keep the Execute Bit ON until the Complete or Error Bit turns ON. To send another message, turn OFF the Execute Bit for at least one scan and then turn it ON again.
	2	Abort	B-VAL	Forces the transmission to end.	Specify the bit to use to abort the message transmission. When the Abort Bit turns ON, the message transmission will be stopped unconditionally. The Abort Bit takes precedence over the Execute Bit.
	3	Dev-Typ	I-REG	Communications device type	Specify the type code of the communications device. 218IFB, 218IFD = 16
	4	Pro-Typ	I-REG	Communications protocol	Specify the type code of the communications protocol. 1: MEMOBUS Select this protocol when using the TOYOPUC protocol. MEMOBUS is automatically converted to the TOYOPUC protocol inside the 218IFD. 2: No-protocol communications 1 (unit: words) Not used for the TOYOPUC protocol. 3: No-protocol communications 2 (unit: bytes) Not used for the TOYOPUC protocol.
	5	Cir-No	I-REG	Circuit number	Specify the circuit number for the communications device. Specify the same circuit number as displayed in the MPE720 Module Configuration Definition Tab Page. 218IFB, 218IFD = 1 to 8
	6	Ch-No	I-REG	Communications buffer channel number	Specify the channel number of the communications buffer. You can specify any channel number provided it is within the valid range. When executing more than one function at the same time, do not use the same channel number for the same connection. You can use the same channel number as long as multiple functions are not executed at the same time. 218IFB, 218IFD = 1 to 10
	7	Param	Address Inputs	Parameter list first address (MA, DA)	Specify the first address of the parameter list. A total of 29 words starting from the specified first word are automatically used for the parameter list. The parameter list is used by inputting function codes and relevant parameter data. It is also where the process results and status are output.









Continued on next page.

Continued from previous page.

I/O Definitions	No.	Name	I/O Designation	Meaning	Description
Output Items	1	Busy	B-VAL	Processing.	Specify the bit that shows that the message transmission is in progress. The Busy Bit is ON while a message transmission or abort is in progress. Keep the Execute Bit or Abort Bit turned ON while the Busy Bit is ON.
	2	Complete	B-VAL	Process completed.	Specify the bit that shows when the message transmission has been completed. The Complete Bit turns ON only for one scan when message transmission or forced abort processing has been completed normally.
	3	Error	B-VAL	Error occurred.	Specify the bit that shows if an error occurred when sending the message. When an error occurs, the Error Bit will turn ON only for one scan. Refer to the following section for an example of a timing chart for when an error occurs.  ◆ Error on page 2-8

MSG-SNDE Function Parameters

The following table describes the contents of the addresses specified by the PARAM input parameter to the MSG-SNDE function.











No.	I/O	Meaning	Description	Reference Page
00	Out-puts	Processing Result	Gives the processing status.	 ◆ Processing Result (PARAM00) on page 2-9
01		Status	Gives the status of the current function.	 ◆ Status (PARAM01) on page 2-10
02		Detail Error Code, Lower Word	Gives the details of an error.	 ◆ Detail Error Code (PARAM02 and PARAM03) on page 4-217
03				
04		Status 1	Gives the communications status.	 ◆ Status 1 (PARAM04) on page 2-12
05		Status 2	Gives status information on the most recent error.	 ◆ Status 2 (PARAM05) on page 2-12
06		Status 3	Gives the information of the send pass counter.	 ◆ Status 3 (PARAM06) on page 2-12
07		Status 4	Gives the information of the receive pass counter.	 ◆ Status 4 (PARAM07) on page 2-12
08		Status 5	Gives the information of the error counter.	 ◆ Status 5 (PARAM08) on page 2-13
09	Status 6	Not used for the TOYOPUC protocol.	—	

Continued on next page.

4.7 Communications with a JTEKT PLC (TOYOPUC Protocol)

4.7.4 Message Functions

Continued from previous page.

No.	I/O	Meaning	Description	Reference Page	
10	Inputs	Connection Number	Sets the connection number used to determine the remote station.	 ◆ <i>Connection Number (PARAM10)</i> on page 2-13	
11		Option	Not used for the TOYOPUC protocol.	–	
12		Function Code	Sets the code of the function in the TOYOPUC protocol.	 ◆ <i>Function Code (PARAM12)</i> on page 4-217	
13		Reserved for system.	This parameter is used by the system. Do not change the value of this parameter from a user program or by any other means.	 ◆ <i>Reserved for System (PARAM13)</i> on page 2-14	
14		Remote Station Data Address, Lower Word	Not used for the TOYOPUC protocol.	–	
15		Remote Station Data Address, Upper Word			
16		Remote Station Register Type	Not used for the TOYOPUC protocol.	–	
17		Data Size	Specify the size of the data to write. (Specify the size in words.)	 ◆ <i>Data Size (PARAM17)</i> on page 4-217	
18		Remote CPU Module Number	Not used for the TOYOPUC protocol.	–	
19		Reserved for system.	This parameter is used by the system. Do not change the value of this parameter from a user program or by any other means.	 ◆ <i>Reserved for System (PARAM19)</i> on page 2-17	
20		Local Station Data Address, Lower Word	Sets the data address to store read/write data in the local station. (Use word addresses for registers, bit addresses for relays or coils.)	 ◆ <i>Local Station Data Address (PARAM20 and PARAM21)</i> on page 2-18	
21		Local station data Address, Upper Word			
22		Local Station Register Type	Sets the register type of the read/write data to store in the local station.	 ◆ <i>Local Station Register Type (PARAM22)</i> on page 4-218	
23		Reserved for system.	This parameter is used by the system. Do not change the value of this parameter from a user program or by any other means.	 ◆ <i>Reserved for System (PARAM23)</i> on page 2-19	
24		–	For system use	This parameter contains the channel number of the communications buffer that is currently in use. A user program must set this parameter to 0 on the first scan after startup. Thereafter, do not change the value of this parameter from a user program or by any other means because it will be used by the system.	 ◆ <i>Reserved for System (PARAM24)</i> on page 2-19
25		–	Reserved for system.	These parameters are used by the system. Do not change the value of these parameters from a user program or by any other means.	 ◆ <i>Reserved for System (PARAM25 to PARAM28)</i> on page 2-19
26		–	Reserved for system.		
27		–	Reserved for system.		
28		–	Reserved for system.		

◆ Detail Error Code (PARAM02 and PARAM03)

These parameters give the detail error code.

Processing Result Value (PARAM00)	Detail Error Code	Error Description	Description
81□□ hex	1	Function code error	An unused function code was sent or received. Check PARAM12 (Function Code).
82□□ hex	2	Address setting error	The setting of one or more of the following parameters is out of range. Check the settings. PARAM14 and PARAM15 (Remote Station Data Address) PARAM20 and PARAM21 (Local Station Data Address)
83□□ hex	3	Data size error	The data size for sending or receiving is out of range. Check PARAM17 (Data Size).
84□□ hex	4	Circuit number setting error	The circuit number is out of range. Check the circuit number (Cir-No) in the MSG-SNDE function.
85□□ hex	5	Channel number setting error	The channel number for the communications buffer is out of range. Check the communications buffer channel number (Ch-No) in the MSG-SNDE function.
86□□ hex	6	Connection number error	The connection number is out of range. Check PARAM10 (Connection Number).
88□□ hex	8	Communications device error	An error response was received from the communications device. Check the connections to the device. Also check to see if the remote device is ready to communicate.
89□□ hex	9	Device select error	A device that cannot be used was selected. Check the communications device type (Dev-Typ) in the MSG-SNDE function.
C245 hex	–	Local station register type error	The register type for the local station is out of range. Check PARAM22 (Local Station Register Type).
8072 hex to FF72 hex		Remote device error*	An error response was received from the remote station. Check the error code and remove the cause.

* An error response received from the remote device will be formatted in PARAM00 (Processing Result) as follows.

Processing Result (PARAM00): □□72 hex (where □□ is the error code)

□□ contains the sum of the completion code sent from the JTEKT PLC and 80 hex.

Refer to the following manual for details on completion codes.

📖 Manual for the 2PORT-EFR Module from JTEKT Corporation

◆ Function Code (PARAM12)

Set the function code to send.

You can use the functions that are registered to the function codes.

MEMOBUS Function		File Memory Frame Type	
Code	Meaning	Code	Function
31 hex	Writes to a fixed buffer in units of one word.	60 hex: Command E0 hex: Response	Sends file memory data.

◆ Data Size (PARAM17)

Set the data size for the write request in words.

Be sure that the last data address that is determined by the offset, data address, and data size does not exceed the valid data address range.

MEMOBUS Function Code	Function	Data Size Setting Range
31 hex	Sends data to the file memory.	1 to 1,022 words

◆ Local Station Register Type (PARAM22)

Set the register type of the read data destination or write data source in the MP3000.

Register Type Value	Type	Remarks
0	M	Sets the target data type to MB for bits and MW for words.
1	G	Sets the target data type to GB for bits and GW for words.
2	I	Sets the target data type to IB for bits and IW for words.
3	O	Sets the target data type to OB for bits and OW for words.
4	S	Sets the target data type to SB for bits and SW for words.
5 or higher	–	Not used for the TOYOPUC protocol.

The register types that can be used depend on whether you are reading or writing.

The following table lists the combinations of register types.

Function Code	Applicable Register Types
31 hex	M, G, I, O, or S

Note: You can store the write data address table in registers in the local station.
The data stored in the M, G, I, O, and S registers in the local station can be read from or written to the remote station by specifying the register type in the write data address table.

Inputs and Outputs for the MSG-RCVE Function

I/O Definitions	No.	Name	I/O Designation	Meaning	Description
Input Items	1	Execute	B-VAL	Executes the transmission.	Specify the bit to use to execute the message transmission. When the Execute Bit turns ON, the message will be sent. Keep the Execute Bit ON until the Complete or Error Bit turns ON. To send another message, turn OFF the Execute Bit for at least one scan and then turn it ON again.
	2	Abort	B-VAL	Forces the transmission to end.	Specify the bit to use to abort the message transmission. When the Abort Bit turns ON, the message transmission will be stopped unconditionally. The Abort Bit takes precedence over the Execute Bit.
	3	Dev-Typ	I-REG	Communications device type	Specify the type code of the communications device. 218IFB, 218IFD = 16
	4	Pro-Typ	I-REG	Communications protocol	Specify the type code of the communications protocol. 1: MEMOBUS Select this protocol when using the TOYOPUC protocol. MEMOBUS is automatically converted to the TOYOPUC protocol inside the 218IFD. 2: No-protocol communications 1 (unit: words) Not used for the TOYOPUC protocol. 3: No-protocol communications 2 (unit: bytes) Not used for the TOYOPUC protocol.
	5	Cir-No	I-REG	Circuit number	Specify the circuit number for the communications device. Specify the same circuit number as displayed in the MPE720 Module Configuration Definition Tab Page. 218IFB, 218IFD = 1 to 8
	6	Ch-No	I-REG	Communications buffer channel number	Specify the channel number of the communications buffer. You can specify any channel number provided it is within the valid range. When executing more than one function at the same time, do not use the same channel number for the same connection. You can use the same channel number as long as multiple functions are not executed at the same time. 218IFB, 218IFD = 1 to 10
	7	Param	Address Inputs	Parameter list first address (MA, DA)	Specify the first address of the parameter list. A total of 52 words starting from the specified first word are automatically used for the parameter list. The parameter list is used by inputting function codes and relevant parameter data. It is also where the process results and status are output.











Continued on next page.

Continued from previous page.

I/O Definitions	No.	Name	I/O Designation	Meaning	Description
Output Items	1	Busy	B-VAL	Processing.	Specify the bit that shows that the message transmission is in progress. The Busy Bit is ON while a message transmission or abort is in progress. Keep the Execute Bit or Abort Bit turned ON while the Busy Bit is ON.
	2	Complete	B-VAL	Process completed.	Specify the bit that shows when the message transmission has been completed. The Complete Bit turns ON only for one scan when message transmission or forced abort processing has been completed normally.
	3	Error	B-VAL	Error occurred.	Specify the bit that shows if an error occurred when sending the message. When an error occurs, the Error Bit will turn ON only for one scan. Refer to the following section for an example of a timing chart for when an error occurs.  ◆ Error on page 2-23





MSG-RCVE Function Parameters

The following table describes the contents of the addresses specified by the PARAM input parameter to the MSG-RCVE function.

No.	I/O	Meaning	Description	Reference Page
00	Out-puts	Processing Result	Gives the processing status.	 ◆ Processing Result (PARAM00) on page 2-25
01		Status	Gives the status of the current function.	 ◆ Status (PARAM01) on page 2-25
02		Detail Error Code, Lower Word	Gives the details of an error.	 ◆ Detail Error Code (PARAM02 and PARAM03) on page 4-223
03				
04		Status 1	Gives the communications status.	 ◆ Status 1 (PARAM04) on page 2-27
05		Status 2	Gives status information on the most recent error.	 ◆ Status 2 (PARAM05) on page 2-28
06		Status 3	Gives the information of the send pass counter.	 ◆ Status 3 (PARAM06) on page 2-28
07		Status 4	Gives the information of the receive pass counter.	 ◆ Status 4 (PARAM07) on page 2-28
08		Status 5	Gives the information of the error counter.	 ◆ Status 5 (PARAM08) on page 2-28
09	Status 6	Not used for the TOYOPUC protocol.	–	
10	Input	Connection Number	Sets the connection number used to determine the remote station.	 ◆ Connection Number (PARAM10) on page 2-29
11	I/O	Option	Not used for the TOYOPUC protocol.	–
12	Out-put	Function Code	Gives the function code requested by the remote station.	 ◆ Function Code (PARAM12) on page 4-223
13	I/O	Reserved for system.	This parameter is used by the system. Do not change the value of this parameter from a user program or by any other means.	 ◆ Reserved for System (PARAM13) on page 2-30



Continued on next page.

Continued from previous page.

No.	I/O	Meaning	Description	Reference Page
14	Out-puts	Data Address, Lower Word	Not used for the TOYOPUC protocol.	-
15		Data Address, Upper Word		
16		Register Types	Not used for the TOYOPUC protocol.	-
17		Data Size	Gives the data size that was requested by the remote station.	 ◆ <i>Data Size (PARAM17)</i> on page 2-31
18		Remote CPU Module Number	Not used for the TOYOPUC protocol.	-
19	I/O	Reserved for system.	This parameter is used by the system. Do not change the value of this parameter from a user program or by any other means.	 ◆ <i>Reserved for System (PARAM19)</i> on page 2-31
20	Inputs	Coil Offset, Lower Word	Not used for the TOYOPUC protocol.	-
21		Coil Offset, Upper Word		
22		Input Relay Offset, Lower Word	Not used for the TOYOPUC protocol.	-
23		Input Relay Offset, Upper Word		
24		Input Register Offset, Lower Word	Not used for the TOYOPUC protocol.	-
25		Input Register Offset, Upper Word		
26		Hold Register Offset, Lower Word	Sets the offset word address for a hold register (MW).	 ◆ <i>Offsets (PARAM20 to PARAM27)</i> on page 4-223
27		Hold Register Offset, Upper Word		
28		Data Relay Offset, Lower Word	Not used for the TOYOPUC protocol.	-
29		Data Relay Offset, Upper Word		
30		Data Register Offset, Lower Word	Not used for the TOYOPUC protocol.	-
31		Data Register Offset, Upper Word		
32		Output Coil Offset, Lower Word	Not used for the TOYOPUC protocol.	-
33		Output Coil Offset, Upper Word		
34		Output Register Offset, Lower Word	Not used for the TOYOPUC protocol.	-
35		Output Register Offset, Upper Word		
36		M Register Writing Range LO, Lower Word	Sets the first address of the writing range for hold register coils.	 ◆ <i>M Register Writing Range (PARAM36 to PARAM39)</i> on page 4-224
37		M Register Writing Range LO, Upper Word		
38		M register Writing Range HI, Lower Word	Sets the last address of the writing range for hold register coils.	 ◆ <i>M Register Writing Range (PARAM36 to PARAM39)</i> on page 4-224
39		M Register Writing Range HI, Upper Word		

Continued on next page.

Continued from previous page.

No.	I/O	Meaning	Description	Reference Page
40	Inputs	G register Writing Range LO, Lower Word	Not used for the TOYOPUC protocol.	-
41		G Register Writing Range LO, Upper Word		
42		G Register Writing Range HI, Lower Word	Not used for the TOYOPUC protocol.	-
43		G Register Writing Range HI, Upper Word		
44		O Register Writing Range LO, Lower Word	Not used for the TOYOPUC protocol.	-
45		O Register Writing Range LO, Upper Word		
46		O Register Writing Range HI, Lower Word	Not used for the TOYOPUC protocol.	-
47		O Register Writing Range HI, Upper Word		
48	-	For system use	This parameter contains the channel number of the communications buffer that is currently in use. A user program must set this parameter to 0 on the first scan after startup. Thereafter, do not change the value of this parameter from a user program or by any other means because it will be used by the system.	 ◆ For System Use (PARAM48) on page 2-34
49	-	Reserved for system.	These parameters are used by the system. Do not change the value of these parameters from a user program or by any other means.	 ◆ Reserved for System (PARAM49 to PARAM51) on page 2-34
50	-	Reserved for system.		
51	-	Reserved for system.		

◆ Detail Error Code (PARAM02 and PARAM03)

These parameters give the detail error code.

Processing Result Value (PARAM00)	Detail Error Code	Error Description	Description
81□□ hex	1	Function code error	An unused function code was received. Check the function code of the remote station.
82□□ hex	2	Address setting error	The setting of one or more of the following parameters is out of range. Check the settings. PARAM14 and PARAM15 (Data Address) PARAM20 and PARAM21 (Coil Offset) PARAM26 and PARAM27 (Hold Register Offset)
83□□ hex	3	Data size error	The data size for receiving is out of range. Check the data size at the remote station.
84□□ hex	4	Circuit number setting error	The circuit number is out of range. Check the circuit number (Cir-No) in the MSG-RCVE function.
85□□ hex	5	Channel number setting error	The channel number for the communications buffer is out of range. Check the communications buffer channel number (Ch-No) in the MSG-RCVE function.
86□□ hex	6	Connection number error	The connection number is out of range. Check PARAM10 (Connection Number).
88□□ hex	8	Communications device error	An error response was received from the communications device. Check the connections to the device. Also check to see if the remote device is ready to communicate.
89□□ hex	9	Device select error	A device that cannot be used was selected. Check the communications device type (Dev-Typ) in the MSG-RCVE function.

◆ Function Code (PARAM12)

This parameter gives the function code that was received.

When the MP3000 receives the file memory data sent from the 2PORT-EFR, the data is converted to the format specified in MEMOBUS command 31 hex and sent to the CPU Module.

File Memory Frame Type		MEMOBUS Function	
Code	Function	Code	Meaning
60 hex: Command E0 hex: Response	Sends file memory data.	31 hex	Writes to a fixed buffer in units of one word.

◆ Offsets (PARAM20 to PARAM27)

Set the offset for the data address in the MP3000.

The MP3000 will offset the address by the number of words specified by the offset.

Note: An offset cannot be a negative value.

Offset parameters are provided for each of the target register types.

The following table lists the offset parameters.

Parameters	Meaning	Description
PARAM20 and 21	Coil Offset	Not used for the TOYOPUC protocol.
PARAM22 and 23	Input Relay Offset	Not used for the TOYOPUC protocol.
PARAM24 and 25	Input Register Offset	Not used for the TOYOPUC protocol.
PARAM26 and 27	Hold Register Offset	Sets the offset to the word address for a hold register.

◆ M Register Writing Range (PARAM36 to PARAM39)

Set the allowable address range for write requests from the remote station. An error will occur if the write request is outside this allowable range.

Specify the M Register Writing Range (PARAM36 to PARAM39) with word addresses.

Note: 1. M registers are always used as the destination in the MP3000 for data write requests from the remote station.

2. The writing range parameters allow you to specify the range of M registers that messages are allowed to write to.

The following table lists the writing range parameters.

Parameters	Meaning	Description
PARAM36 and 37	M Register Writing Range LO	First address of the writing range
PARAM38 and 39	M Register Writing Range HI	Last address of the writing range

Set the writing range so that it satisfies the following condition:

$$0 \leq \text{M register writing range LO} \leq \text{M register writing range HI} \leq \text{Maximum M register address}$$

4.8 No-Protocol Communications

Use no-protocol communications to perform communications with a protocol that is not implemented in MP-series Controllers.

This section describes how to perform communications using no-protocol communications.

4.8.1 Using the MSG-SNDE and MSG-RCVE Functions with the MP3000 as the Master

This section describes how to send instructions to a remote device with the MSG-SNDE function and how to receive responses from the remote device with the MSG-RCVE function when the MP3000 is the master.

System Configuration Example

The following figure illustrates how the master MP3000 sends the contents of the MW10000 to MW10099 hold registers to the remote device. Then as the response to the instruction, the master MP3000 writes the content received from the remote device to the MW20000 to MW20099 hold registers.

This sample shows a command/response protocol that uses no-protocol communications. The device that sends the command is the master and the device that sends the response is the slave.

4.8 No-Protocol Communications

4.8.1 Using the MSG-SNDE and MSG-RCVE Functions with the MP3000 as the Master

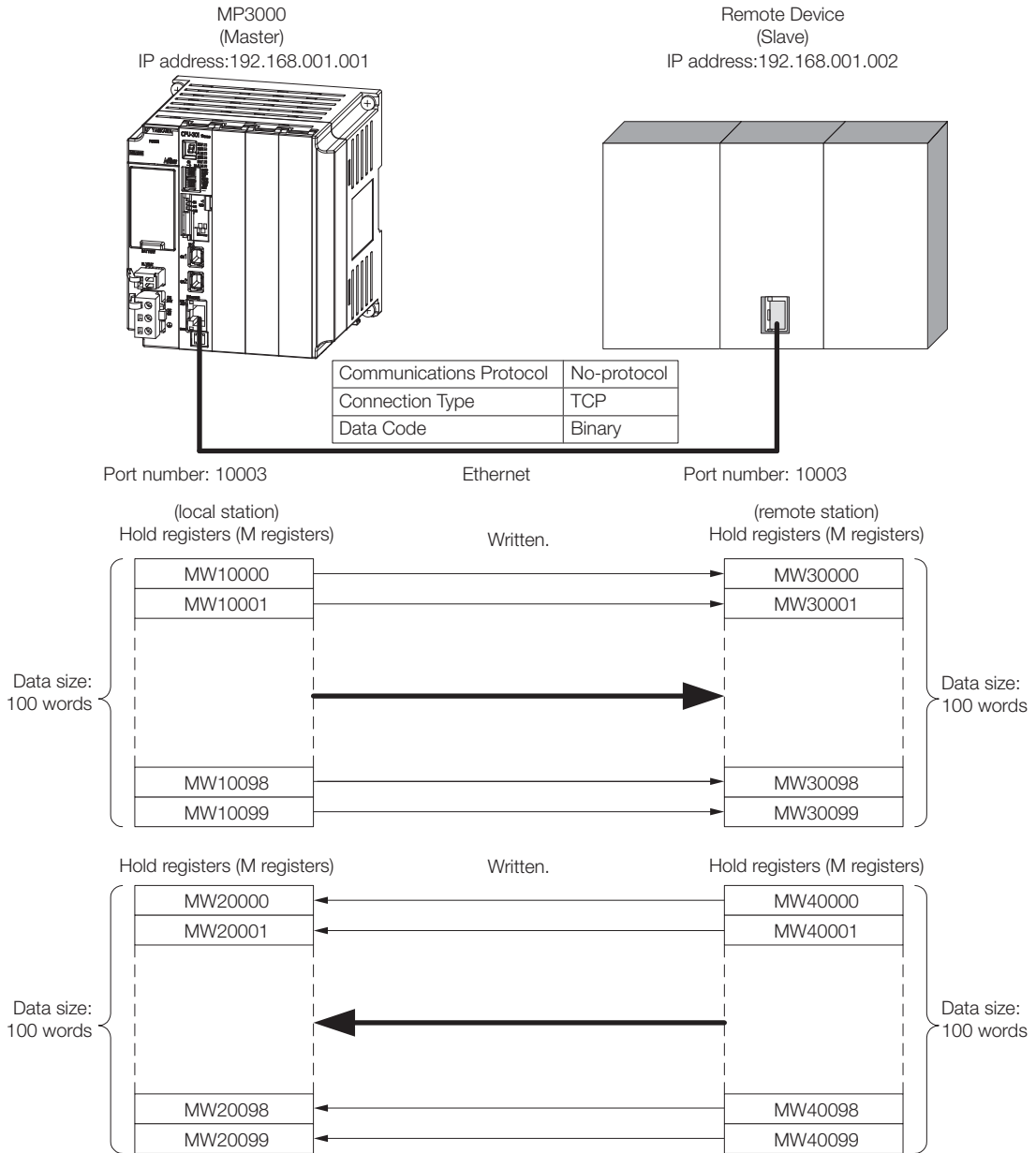

MP3000 Setup

Use the following procedure to set up the MP3000.

Information If the communications parameters (IP address and subnet mask) have already been set, skip to step 3.

1. Double-click the cell for 218IFD in the Module Configuration Definition Tab Page.

Module	Function Module/Slave	Status	Circuit No./AxisAddress		Motion Register	Register(Input/Output)		
			Start	cupied circ		Disabled	Start - End	Size
01 [CPU-302(32axes)] - ---								
808-NEW I0 00 CPU302(32)[-----]	01 CPU	---	---	---				
	02 218IFD	---	☐	Circuit No1	1		☐ Input ☐ OutPut	0000 - 07FF[H] 2048
	03 + SVC32	---	☐	Circuit No1	1	8000 - 87FF[H]	☐ Input ☐ OutPut	0800 - 0BFF[H] 1024
	04 + SVR32	---	☐	Circuit No3	1	9000 - 97FF[H]		
	05 M-EXECUTOR	---						0C00 - 0C3F[H] 64
06 -- UNDEFINED --								
07 -- UNDEFINED --								
01 -- UNDEFINED --[-----]								
02 -- UNDEFINED --[-----]								
03 -- UNDEFINED --								
02 -- UNDEFINED --								
02 -- UNDEFINED --								
03 -- UNDEFINED --								
04 -- UNDEFINED --								

The 218IFD Detail Definition Dialog Box will be displayed.

2. Set the communications parameters.

- ① In the [IP Address] Boxes, enter the following address: 192.168.001.001.
- ② In the [Subnet Mask] Boxes, enter the following mask: 255.255.255.000.
- ③ In the [Gateway IP Address] Boxes, enter the following address: 000.000.000.000.

3. Click the [Easy Setting] Button in the [Message Communication] Area in the [Connection Parameter] Area.

CNO	Local Port	Node IP Address	Node Port	Connect Type	Protocol Type	Code	Detail
01	----						Setting*
02	----						Setting*
03	----						Setting*
04	----						Setting*
05	----						Setting*
06	----						Setting*
07	----						Setting*

The Message Communications Easy Setting Dialog Box will be displayed.

4. Set the connection parameters.

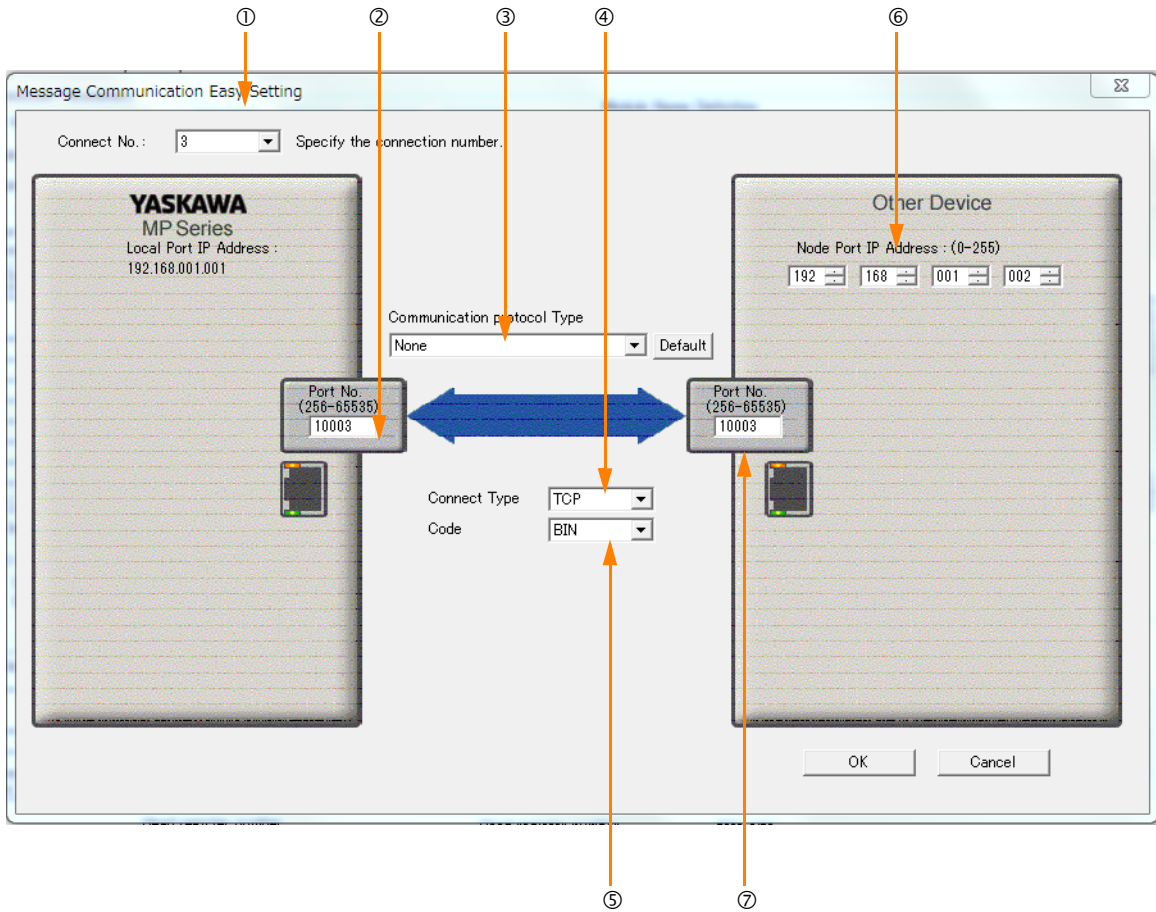

- ① Select [3] in the [Connect No.] Box.
- ② Enter "010003" in the [Port No.] Box for the MP-series Controller.
- ③ Select [No-Protocol] in the [Communications Protocol Type] Box, and then click the [Default] Button.
- ④ Select [TCP] in the [Connect Type] Box.
- ⑤ Select [BIN] in the [Code] Box.
- ⑥ Enter the following address in the [Node Port IP Address] Boxes for the other device: 192.168.001.002.
- ⑦ Enter "10003" in the [Port No.] Box for the other device.

5. Click the [OK] Button.

6. Click the [Yes] Button in the Transmission Parameters Confirmation Dialog Box.

Note: If parameters have already been set for the same connection number and you click the [Yes] Button in the Transmission Parameters Confirmation Dialog Box, the settings will be overwritten by the parameters that are set in the Message Communications Easy Setting Dialog Box.

7. Check the settings.

Connection Parameter

Message Communication

Easy setting The following parameters for message communications can be easily set. Connections(C NO) 01-10 can be set to receive data automatically.

CNO	Local Port	Node IP Address	Node Port	Connect Type	Protocol Type	Code	Detail	Node Name
01							Setting*	
02							Setting*	
03	10003	192.168.001.002	10003	TCP	None	BIN	Setting*	
04							Setting*	
05							Setting*	
06							Setting*	
07							Setting*	

Cannot the overlap to local station port number used by the communicate the I/O message.

Note: Changes made to the communications or connection parameters will become effective only after the changes have been saved to flash memory and the power supply has been cycled.

8. Create a ladder program for the MSG-SNDE and MSG-RCVE functions. A ladder program example is shown below.

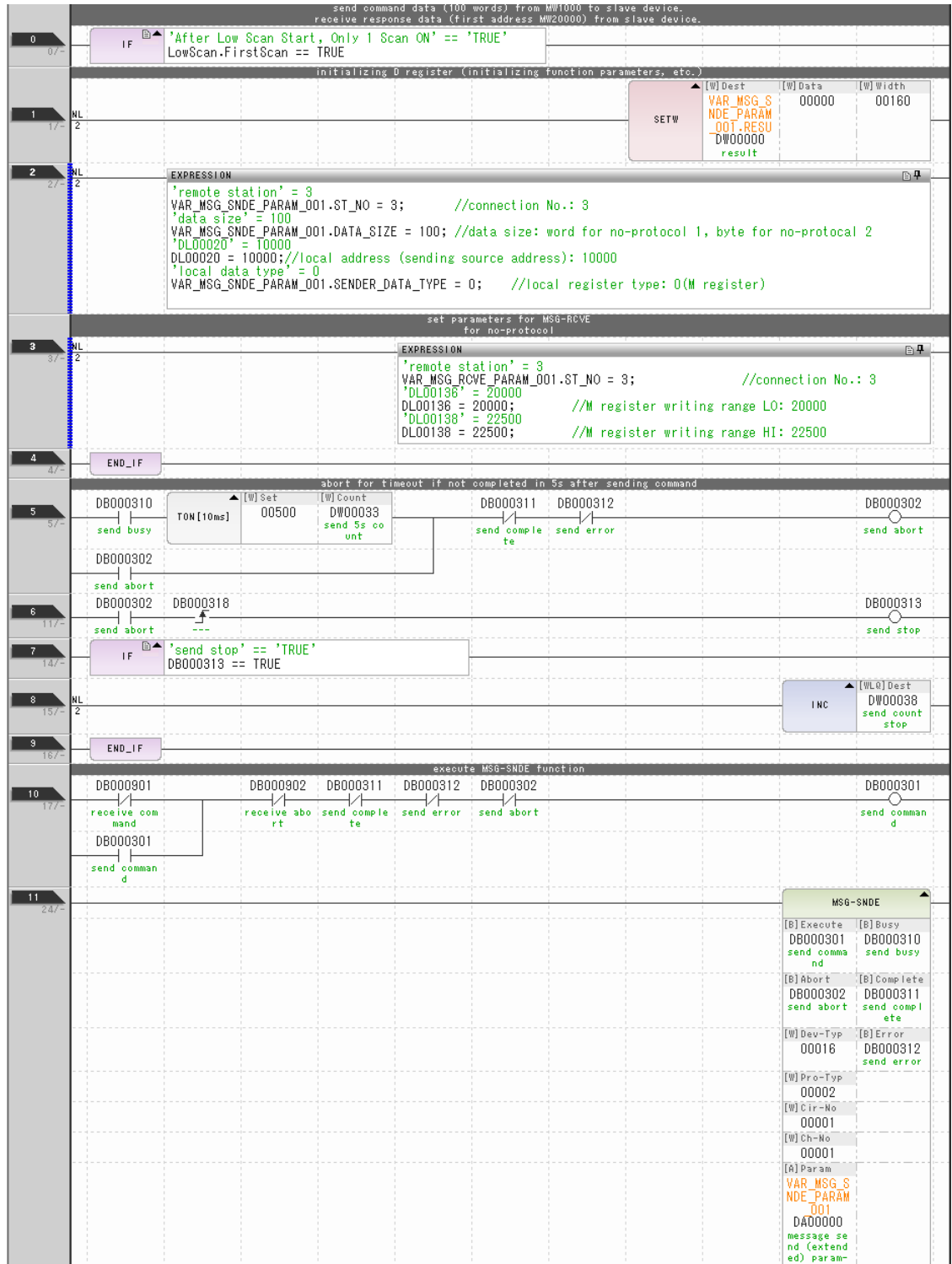

4.8 No-Protocol Communications

4.8.1 Using the MSG-SNDE and MSG-RCVE Functions with the MP3000 as the Master

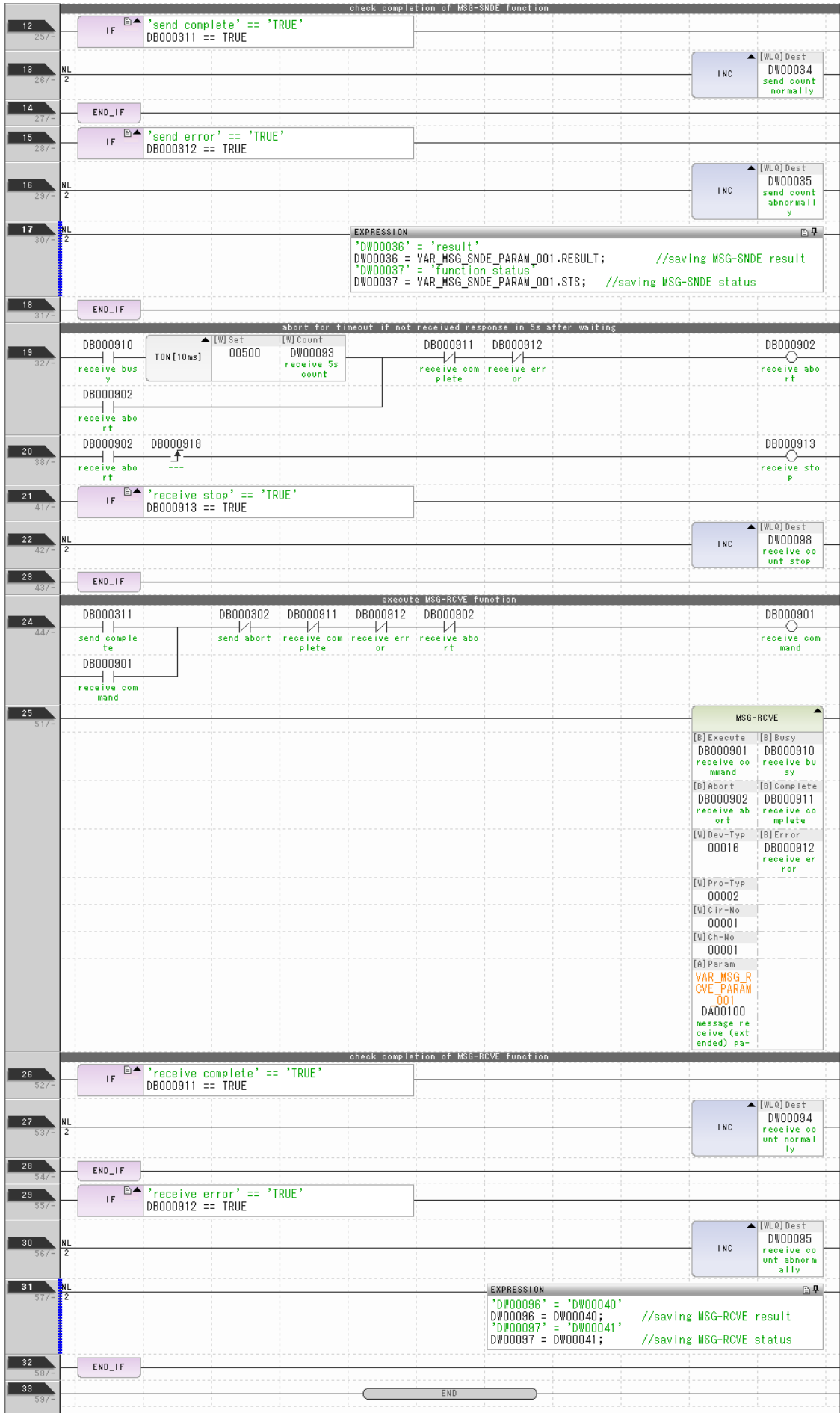

9. Save the data to flash memory.

This concludes the settings for using the MP3000 as the master.

Starting Communications

Turn ON the power to the MP3000 to start transmitting messages.

Using Serial Communications

5

This chapter describes the operating methods for performing Ethernet communications with controllers from various manufacturers using the MEMOBUS message communications method or the no-protocol communications method.

5.1	MEMOBUS Protocol	5-3
5.1.1	Using Automatic Reception with the MP3000 as a Slave	5-3
5.1.2	Using the MSG-RCVE Function with the MP3000 as a Slave	5-9
5.1.3	Using the MSG-SNDE Function with the MP3000 as the Master	5-16
5.1.4	Message Functions	5-22
5.2	A-Compatible 1C Frame Protocol	5-30
5.2.1	Using the MSG-SNDE Function with the MP3000 as the Master	5-30
5.2.2	Message Functions	5-36
5.3	OMRON Protocol	5-41
5.3.1	Using the MSG-SNDE Function with the MP3000 as the Master	5-41
5.3.2	Message Functions	5-46
5.4	No-Protocol Communications	5-51
5.4.1	Using the MSG-SNDE and MSG-RCVE Functions with the MP3000 as the Master	5-51

5.5 No-Protocol FD Communications5-57

- 5.5.1 Using the MSG-SNDE and MSG-RCVE
Functions with the MP3000 as the Master5-57

5.1 MEMOBUS Protocol

5.1.1 Using Automatic Reception with the MP3000 as a Slave

This section describes how to perform serial communications with a master MP3000 and slave MP2310 by using I/O message communications.

System Configuration Example

In this example, messages in the MEMOBUS protocol sent from the MP2310 (remote station: master) are automatically received by the MP3000 (local station: slave).

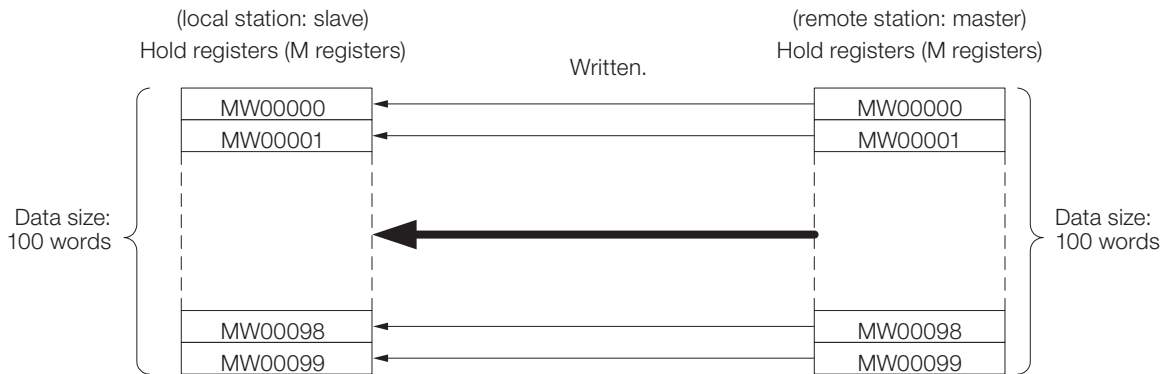
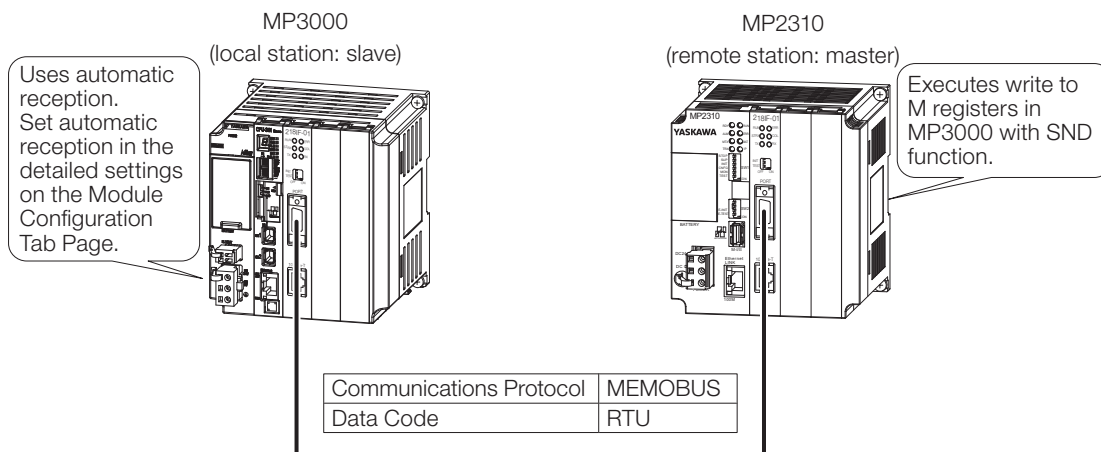

MP3000 Setup

Use the following procedure to set up the MP3000.

Information If the communications parameters (IP address and subnet mask) have already been set, skip to step 3.

1. Double-click the cell for 217IF in the Module Configuration Definition Tab Page.

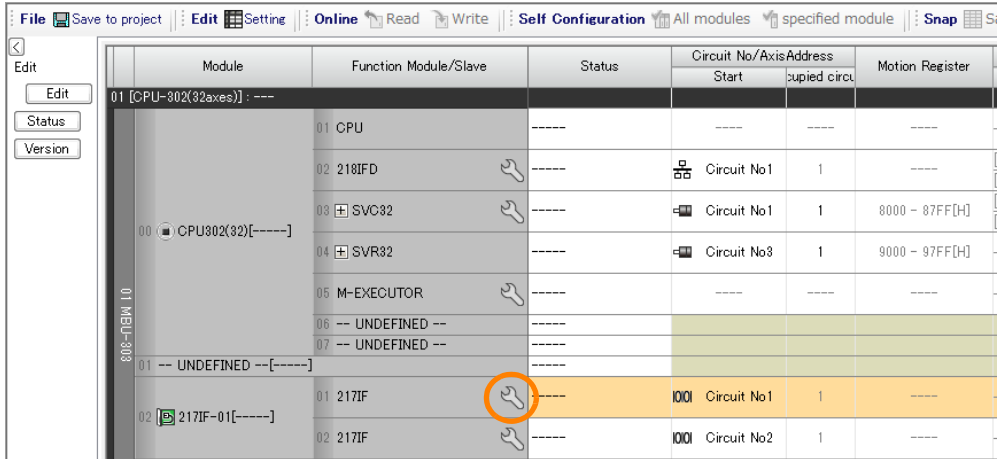

The 217IF Detail Definition Dialog Box will be displayed.

2. Set the detail definition for the 217IF.

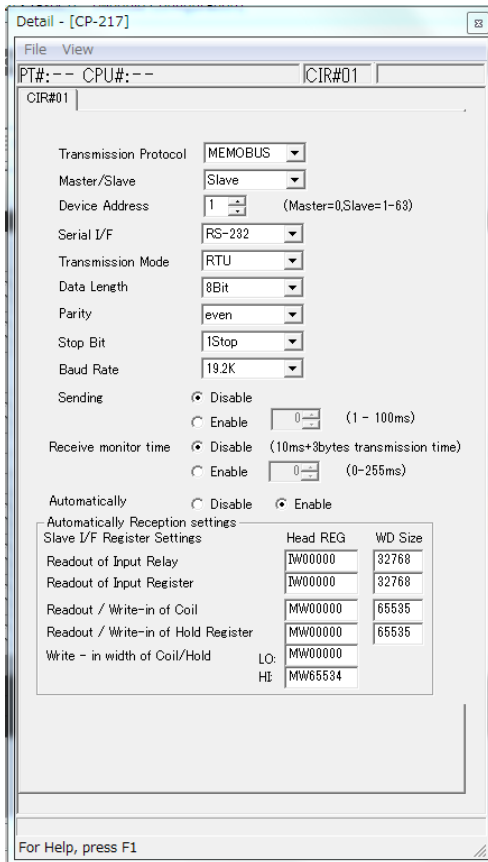

- ① Select [MEMOBUS] in the [Transmission Protocol] Box.
- ② Select [Slave] in the [Master/Slave] Box.
- ③ For [Device Address], enter the unit number found in the detailed settings of the logical port settings for the serial port.
- ④ For [Data Length], [Parity], [Stop Bit], and [Baud Rate], enter the settings according to the detailed settings of the logical port settings for the serial port.
- ⑤ Select [Enable] for [Automatically] and configure the settings in [Automatically Reception settings] as necessary.

3. Select [Save] from the File Menu.

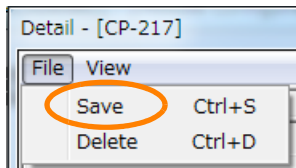

4. Click the [Yes] Button.

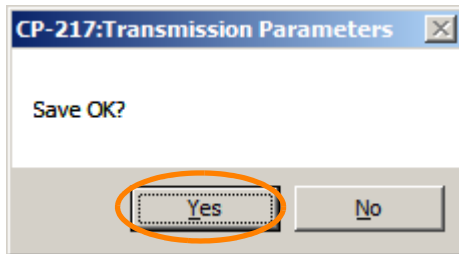

5. Save the data to flash memory.

Note: Changes made to the communications or connection parameters will become effective only after the changes have been saved to flash memory and the power supply has been cycled.

This concludes the settings for using the MP3000 as a slave.

Setting Up the Remote Device (MP2310)

Use the following procedure to set up the MP2310.

Information If the communications parameters (IP address and subnet mask) have already been set, skip to step 3.

1. Double-click the cell for 217IF in the Module Configuration Definition Tab Page.

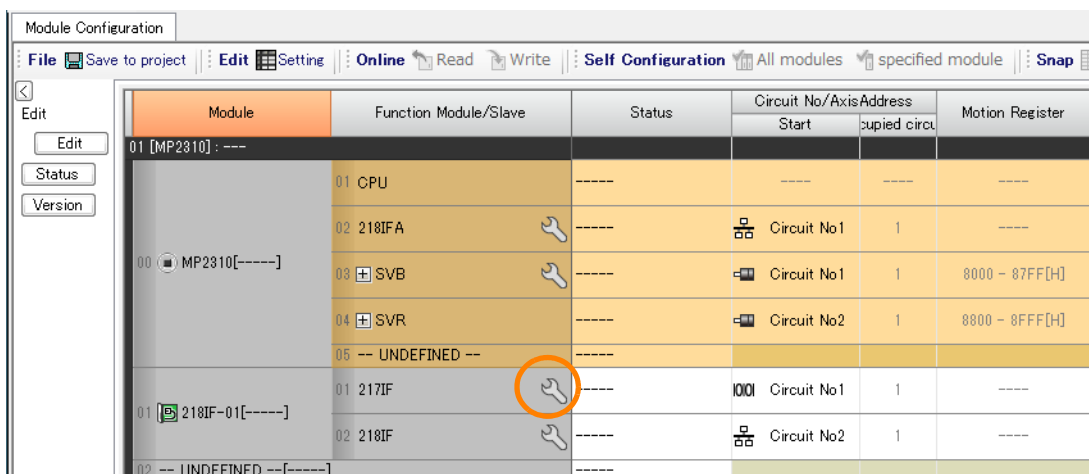

The 217IF Detail Definition Dialog Box will be displayed.

2. Set the detail definition for the 217IF.

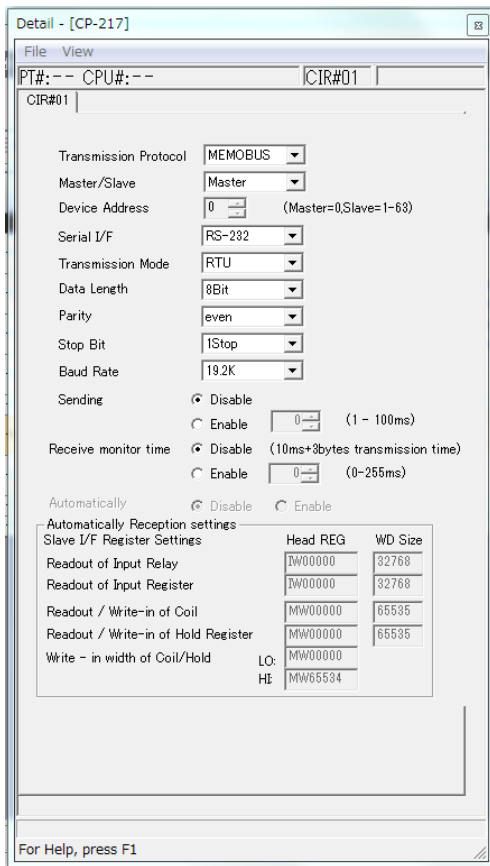

- ① Select [MEMOBUS] in the [Transmission Protocol] Box.
- ② Select [Master] in the [Master/Slave] Box.
- ③ For [Transmission Mode], [Data Length], [Parity], [Stop Bit], and [Baud Rate], enter the settings according to the settings on the slave.

3. Select [Save] from the File Menu.

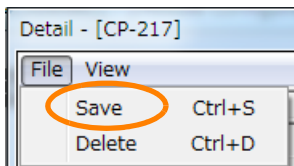

4. Click the [Yes] Button.

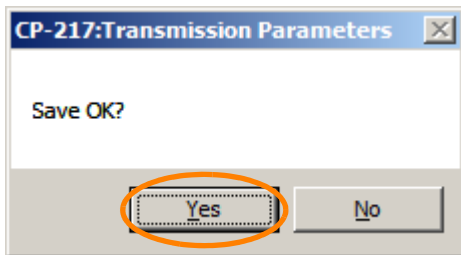

5. Create a ladder program for the MSG-SND function. A ladder program example is shown below.

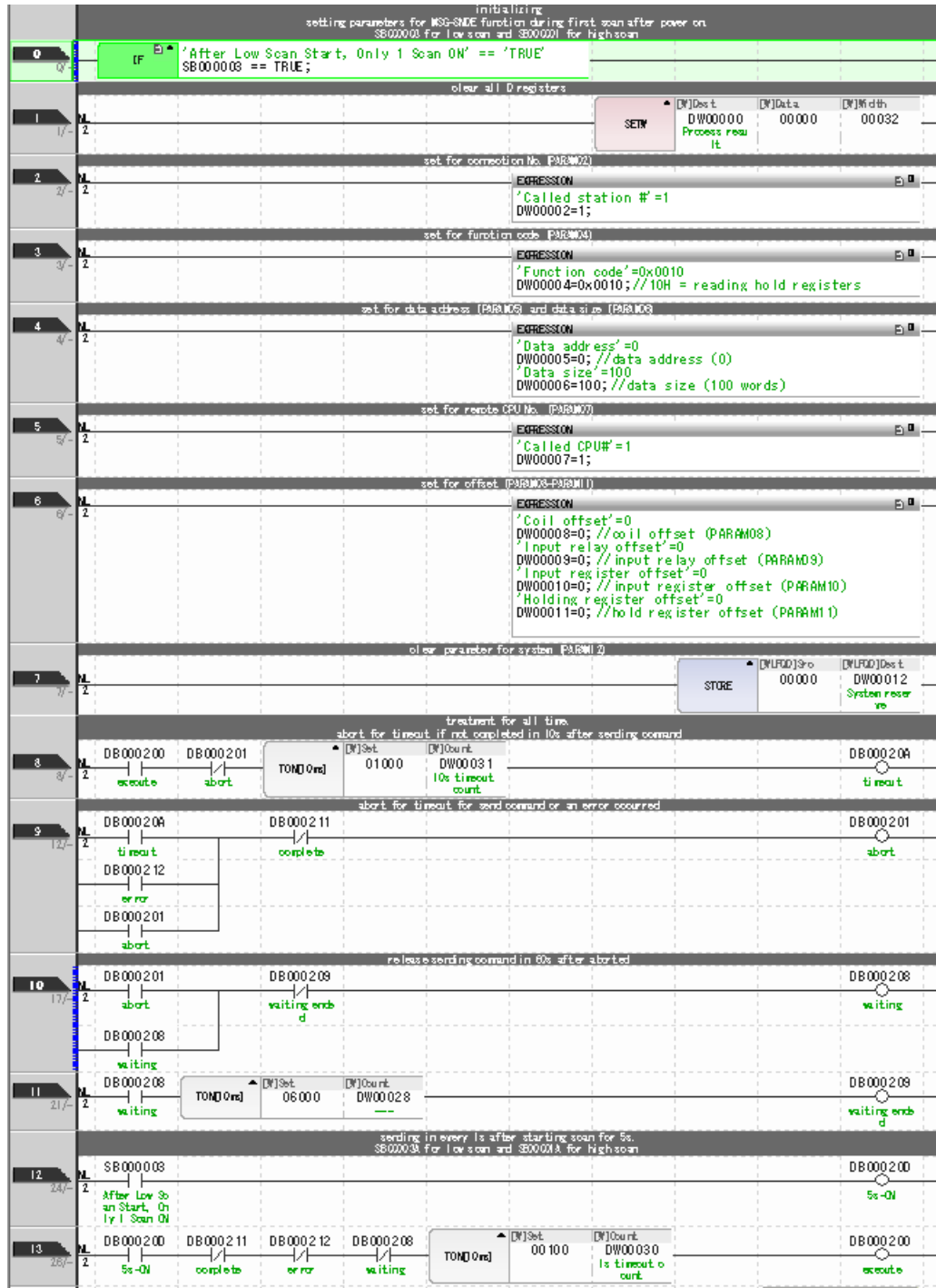

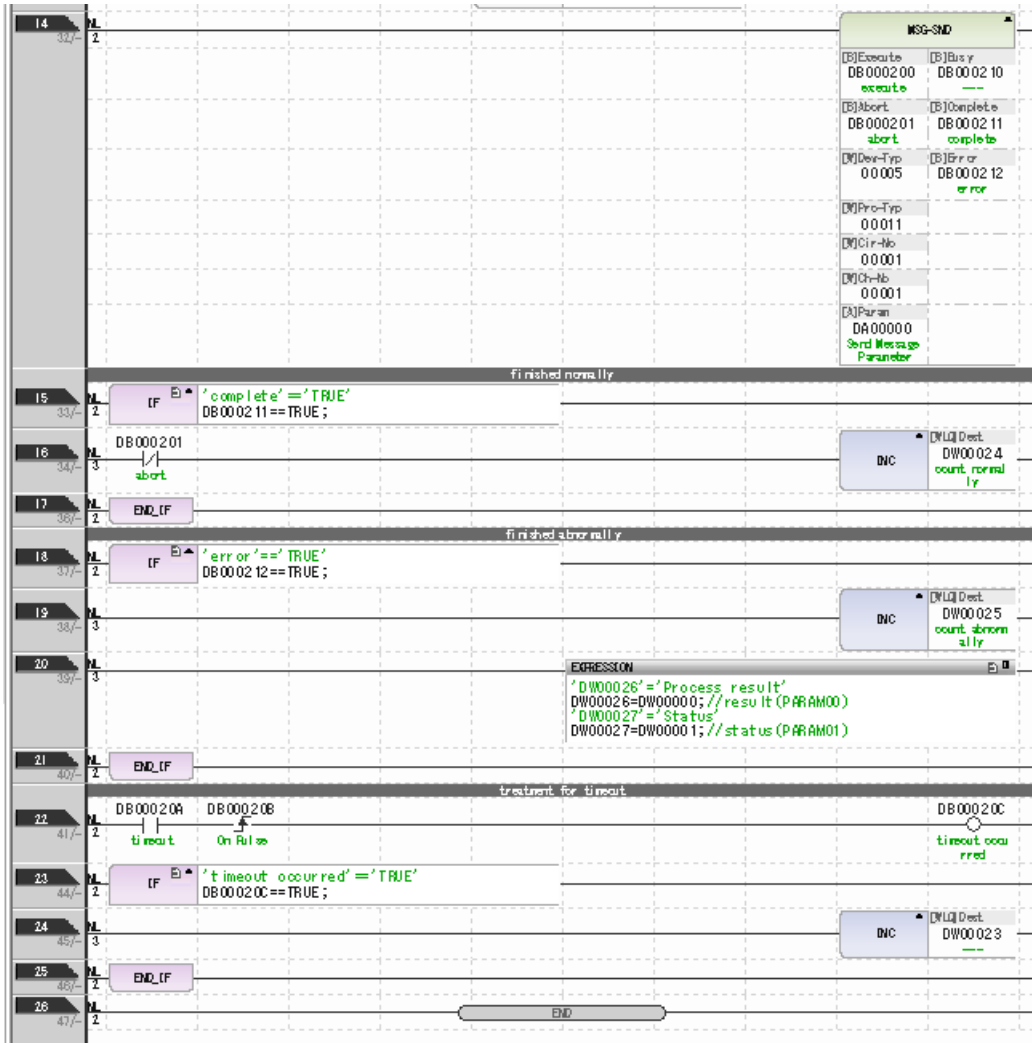

6. Save the data to flash memory.

This concludes the setup.

Starting Communications

1. Turn ON the power to the MP3000 to start receiving messages.
The system will automatically start the message reception operation. No further operation is required.
2. Turn ON the Execute Bit (e.g., DB000200) for the MSG-SND function in the MP2310 to start sending messages.
The ladder program example is designed to send a message every second after five seconds have elapsed from when the low-speed scan (or high-speed scan) starts.
To change the message transmission interval, change the timer value ①.

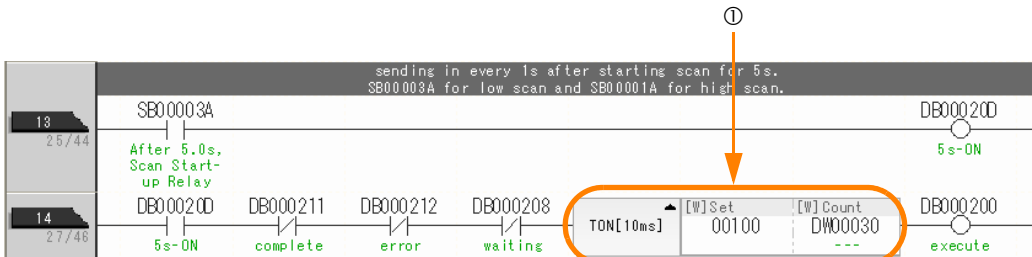

5.1.2 Using the MSG-RCVE Function with the MP3000 as a Slave

This section describes how to perform serial communications with a slave MP3000 and master MP2310 by using the MSG-RCVE function.

Setting Example

The following figure illustrates how the contents of the MW00100 to MW00199 hold registers in the MP2310 master are written to the MW00100 to MW00199 hold registers in the MP3000 slave.

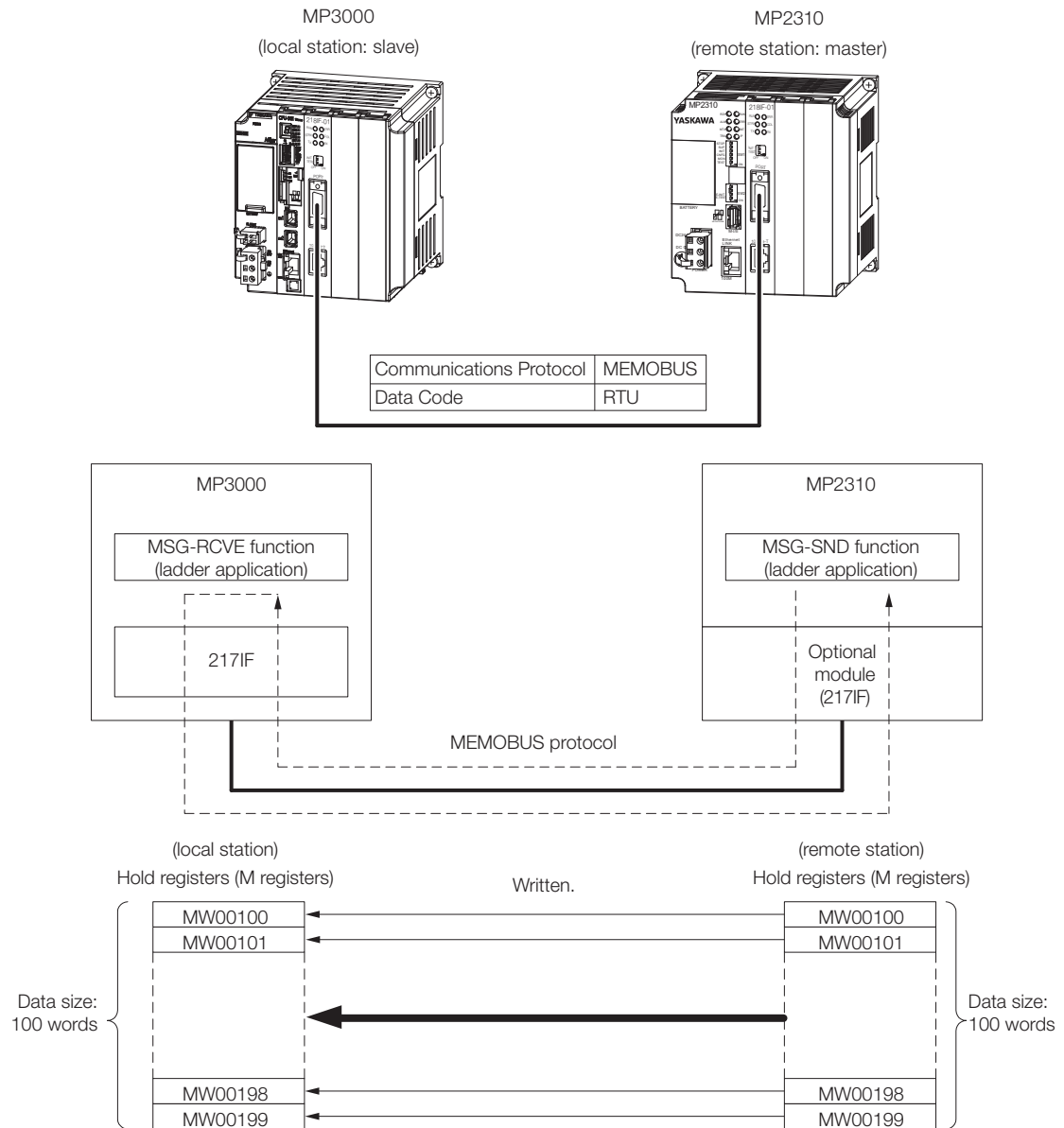

MP3000 Setup

Use the following procedure to set up the MP3000.

Information If the communications parameters (IP address and subnet mask) have already been set, skip to step 3.

1. Double-click the cell for 217IF in the Module Configuration Definition Tab Page.

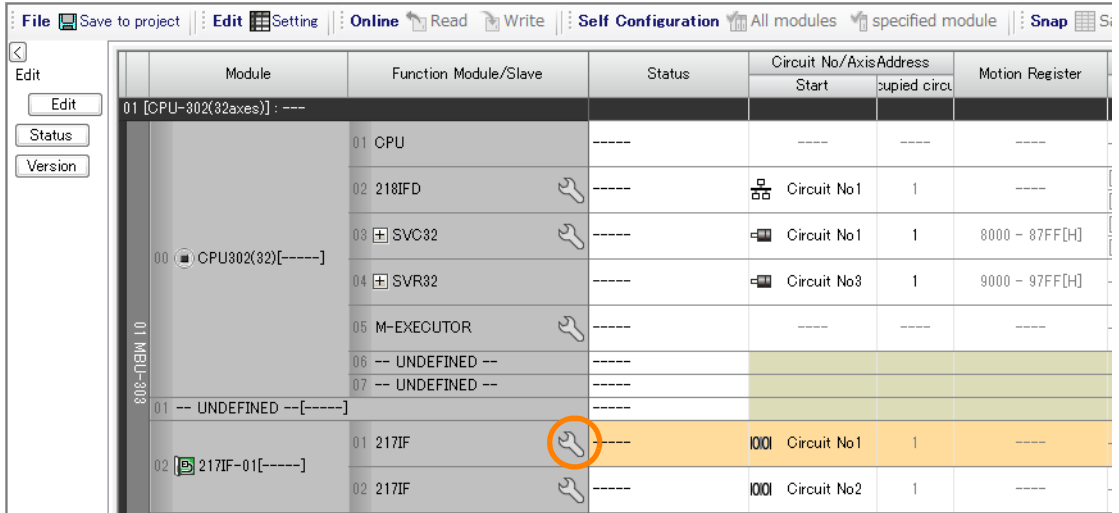

The 217IF Detail Definition Dialog Box will be displayed.

2. Set the detail definition for the 217IF.

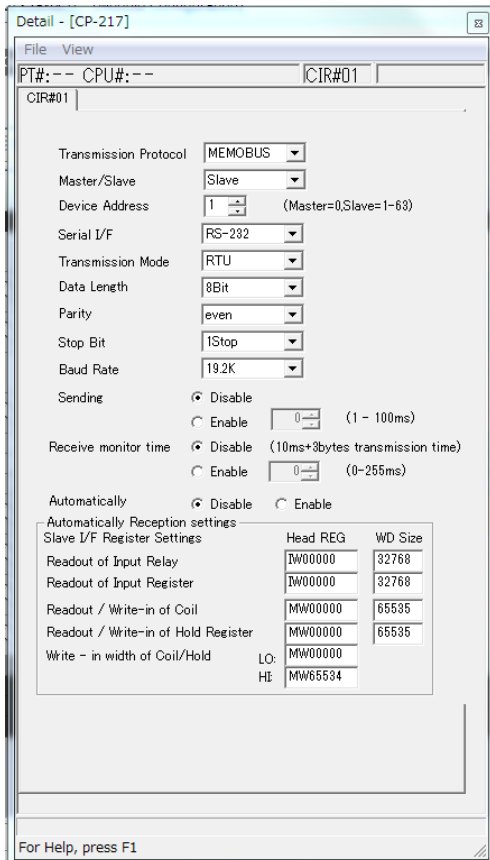

- ① Select [MEMOBUS] in the [Transmission Protocol] Box.
- ② Select [Slave] in the [Master/Slave] Box.
- ③ Enter 1 in the [Device Address] Box.
- ④ For the [Serial I/F], [Transmission Mode], [Data Length], [Parity], [Stop Bit], and [Baud Rate] Boxes, enter the settings as necessary.

3. Select [Save] from the File Menu.

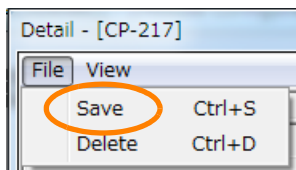

The Message Communications Easy Setting Dialog Box will be displayed.

4. Click the [Yes] Button.

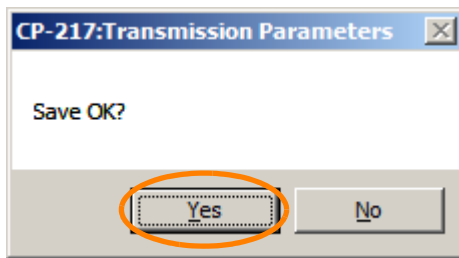

5. Click the [Yes] Button in the Transmission Parameters Confirmation Dialog Box.

Note: If parameters have already been set for the same station number and you click the [Yes] Button in the Transmission Parameters Confirmation Dialog Box, the settings will be overwritten by the parameters that are set in the Message Communications Easy Setting Dialog Box.

6. Create a ladder program for the MSG-RCVE function.

A ladder program example is shown below.

```

0 0/- IF 'After Low Scan Start, Only 1 Scan ON' == 'TRUE'
    SB000003 == TRUE;

1 1/- NL
    SETW DW00000 00000 00160

2 2/- END_IF

3 3/- set for offset (PARAM20 to PARAM35)
    EXPRESSION
    'coil offset low'=0
    DW00120=0; //coil offset MB low (0)
    'coil offset high'=0
    DW00121=0; //coil offset MB high (0)
    'input relay offset low'=0
    DW00122=0; //input relay offset IB low (0)
    'input relay offset high'=0
    DW00123=0; //input relay offset IB high (0)
    'input register offset low'=0
    DW00124=0; //input register offset IW low (0)
    'input register offset high'=0
    DW00125=0; //input register offset IW high (0)
    'hold register offset low'=0
    DW00126=0; //hold register offset MW low (0)
    'hold register offset high'=0
    DW00127=0; //hold register offset MW high (0)
    'data relay offset low'=0
    DW00128=0; //data relay offset GB low (0)
    'data relay offset high'=0
    DW00129=0; //data relay offset GB high (0)
    'data register offset low'=0
    DW00130=0; //data register offset GW low (0)
    'data register offset high'=0
    DW00131=0; //data register offset GW high (0)
    'output coil offset low'=0
    DW00132=0; //output coil offset OB low (0)
    'output coil offset high'=0
    DW00133=0; //output coil offset OB high (0)
    'output register offset low'=0
    DW00134=0; //output register offset OW low (0)
    'output register offset high'=0
    DW00135=0; //output register offset OW high (0)

4 4/- set for M writing range (PARAM36 to PARAM39)
    EXPRESSION
    'M writing range LO low'=0x000
    DW00136=0x000; //M writing range LO low
    'M writing range LO high'=0x000
    DW00137=0x000; //M writing range LO high
    'M writing range HI low'=0xFFFF
    DW00138=0xFFFF; //M writing range HI low
    'M writing range HI high'=0x000F
    DW00139=0x000F; //M writing range HI high
  
```

5.1 MEMOBUS Protocol

5.1.2 Using the MSG-RCVE Function with the MP3000 as a Slave

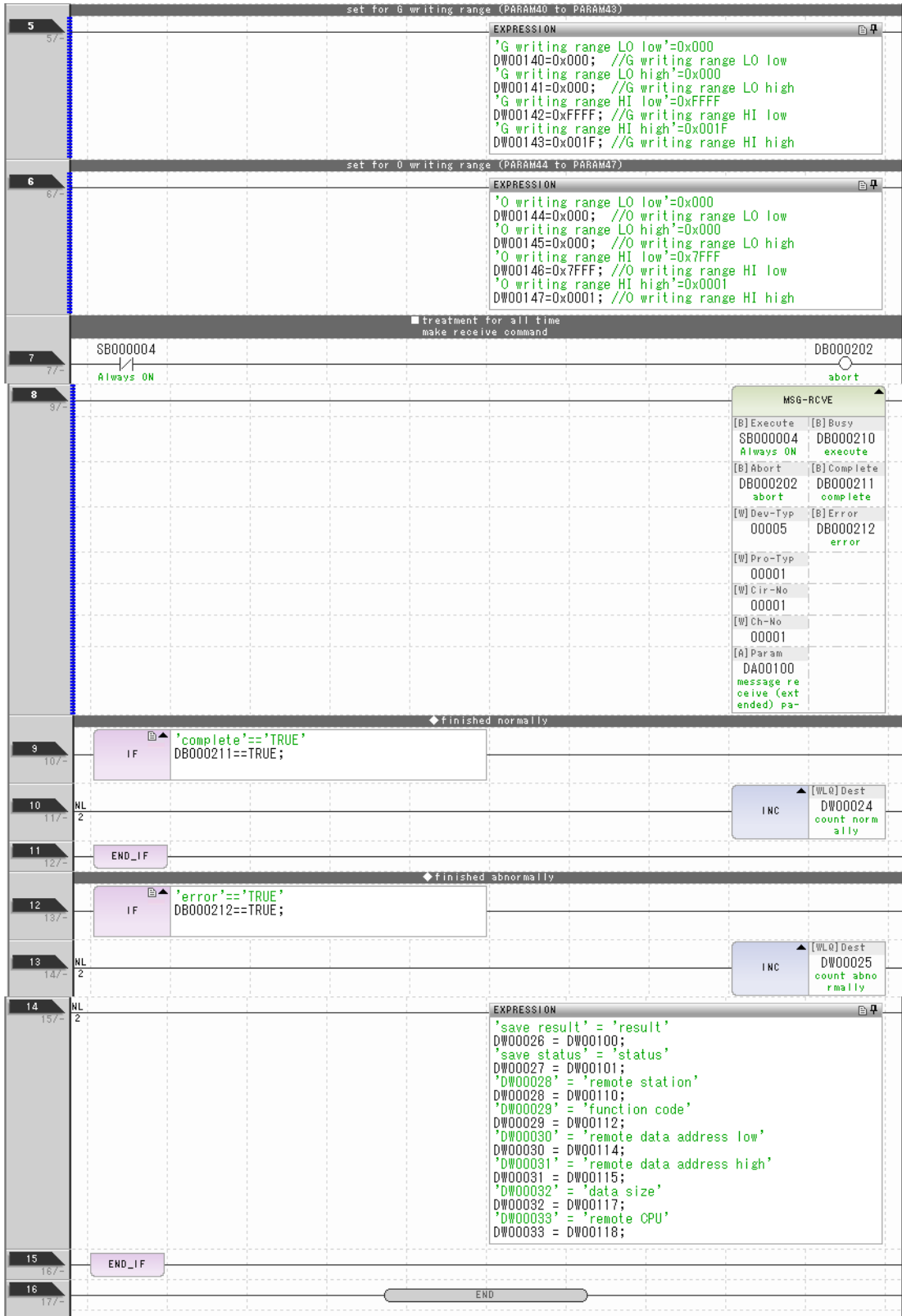

7. Save the data to flash memory.

This concludes the settings for using the MP3000 as a slave.

◆ Setting Up the Remote Device (MP2310)

Use the following procedure to set up the MP2310.

Information If the communications parameters (IP address and subnet mask) have already been set, skip to step 3.

1. Double-click the cell for 217IF in the Module Details Area of the Module Configuration Definition Tab Page.

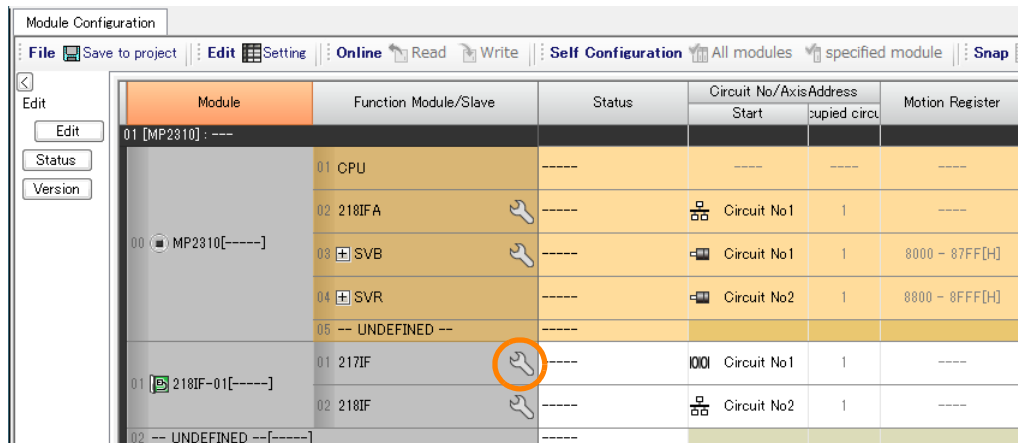

The 217IF Detail Definition Dialog Box will be displayed.

2. Set the detail definition for the 217IF.

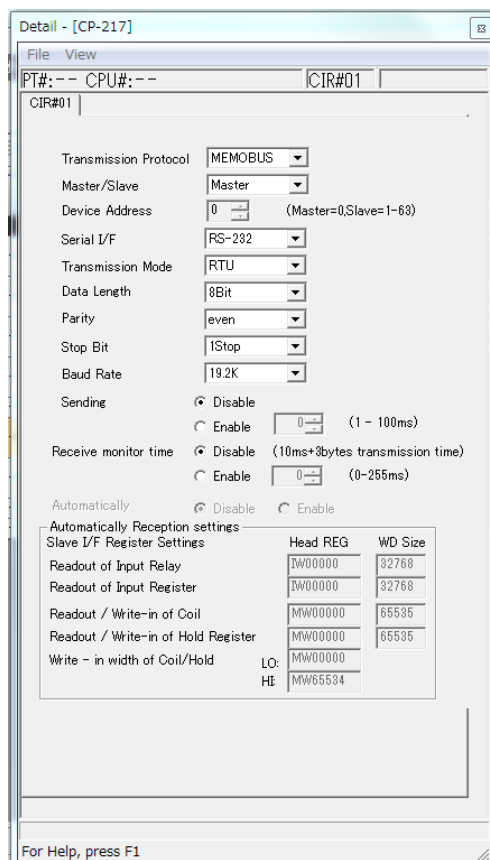

- ① Select [MEMBUS] in the [Transmission Protocol] Box.
- ② Select [Master] in the [Master/Slave] Box.
- ③ Configure the other settings, from [Device Address] to [Baud Rate], as necessary.

3. Click the [Yes] Button.

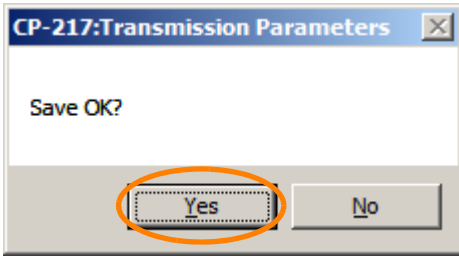

4. Create a ladder program for the MSG-SND function. A ladder program example is shown below.

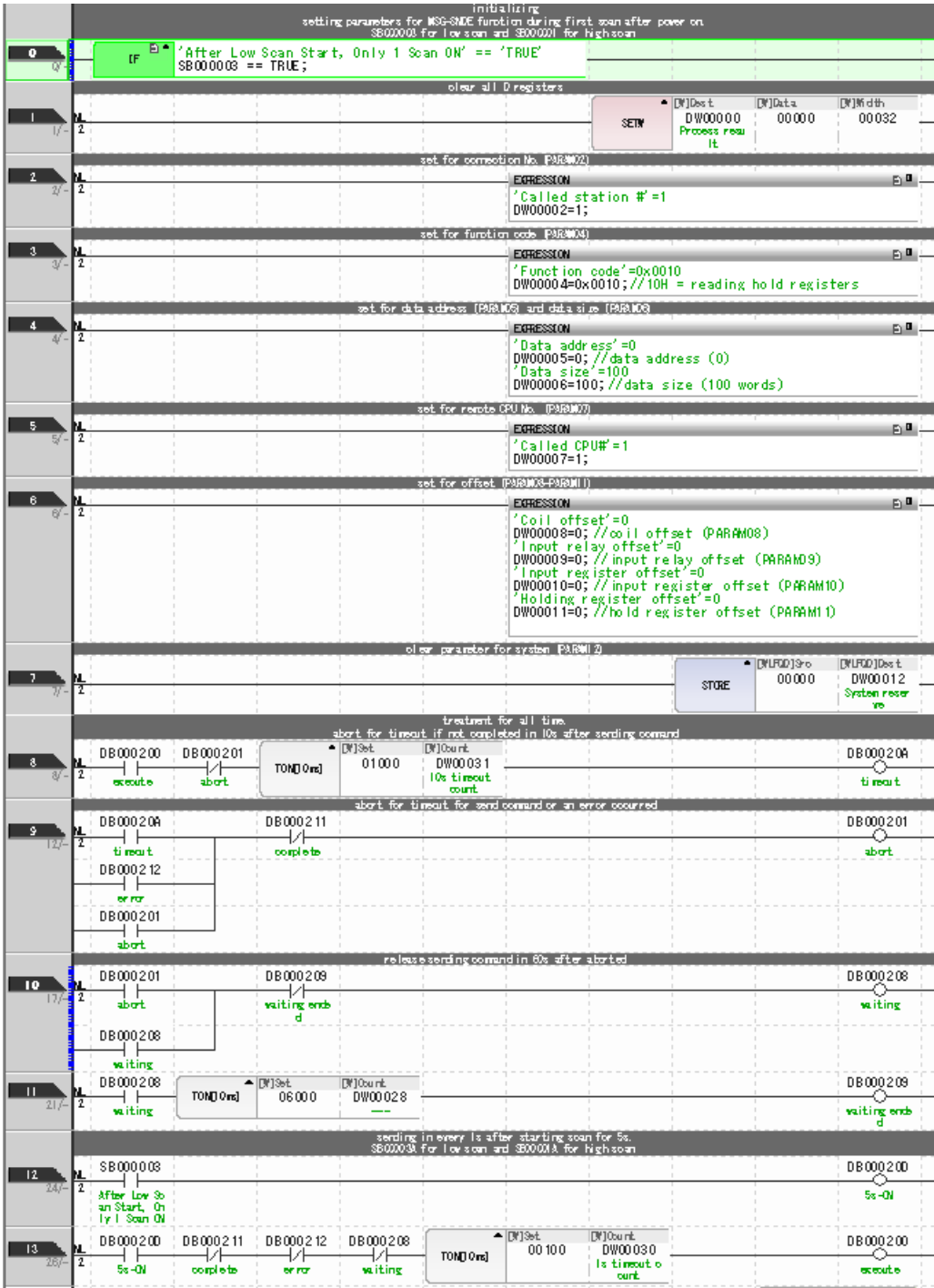

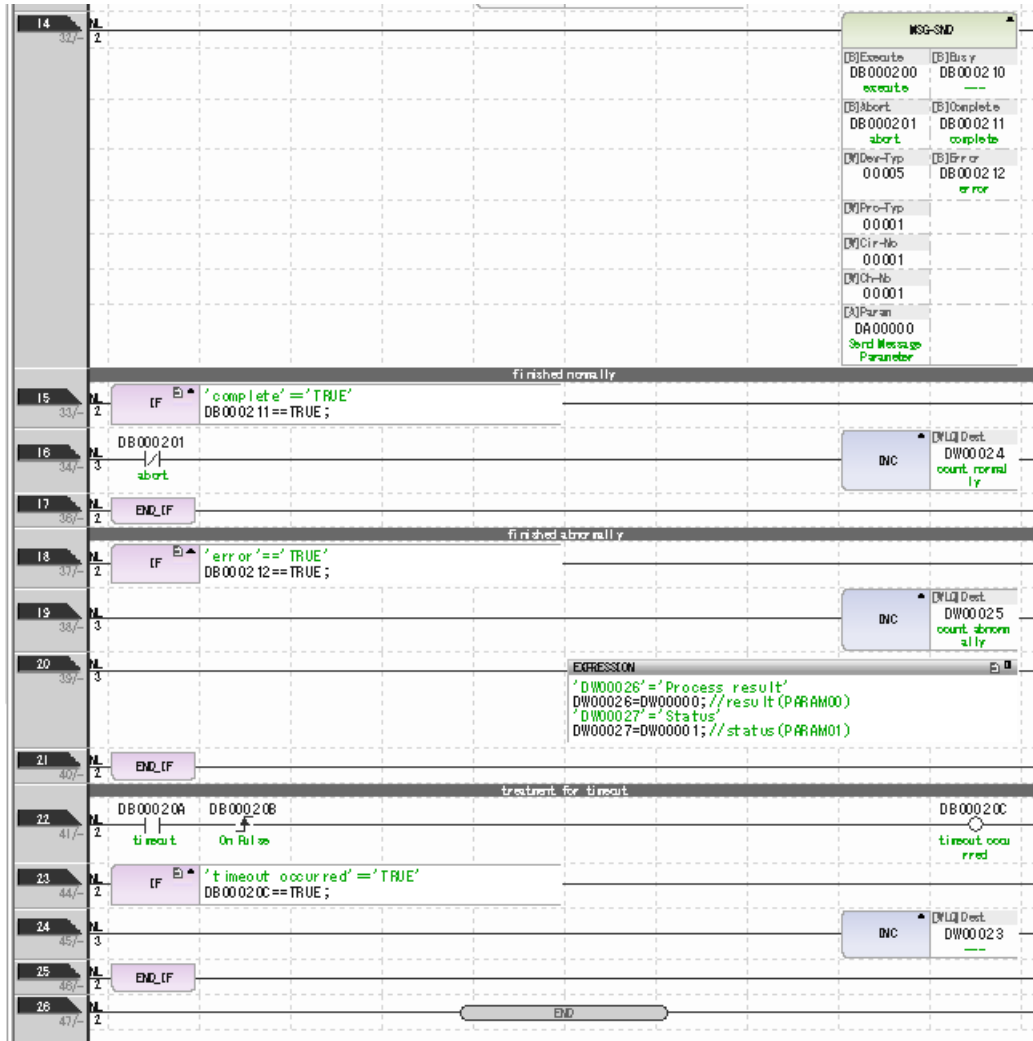

5. Save the data to flash memory.

This concludes the setup.

◆ Starting Communications

1. Turn ON the power to the MP3000 to start receiving messages.
In the ladder program example, message reception starts immediately after the system starts. No further operation is required.
2. Turn ON the Execute Bit (e.g., DB000200) for the MSG-SND function in the 2310 to start sending messages.
The ladder program example is designed to send a message every second after five seconds have elapsed from when the low-speed scan (or high-speed scan) starts. To change the message transmission interval, change the timer value ①.

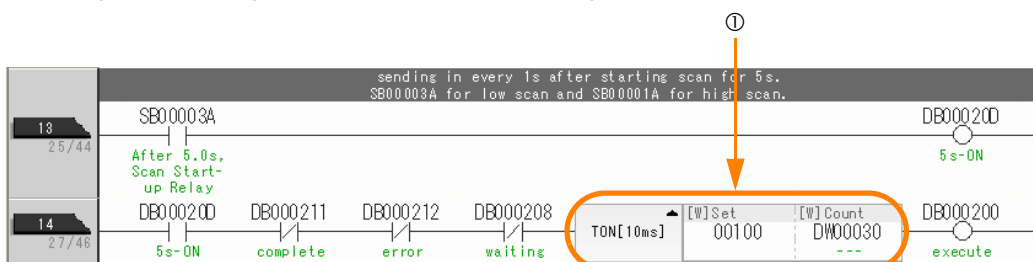

5.1.3 Using the MSG-SNDE Function with the MP3000 as the Master

This section describes how to perform serial communications with a master MP3000 and slave MP2310 by using the MSG-SNDE function.

System Configuration Example

The following figure illustrates how the contents of the MW00400 to MW00499 hold registers in the MP2310 slave are read into the MW00400 to MW00499 hold registers in the MP3000 master.

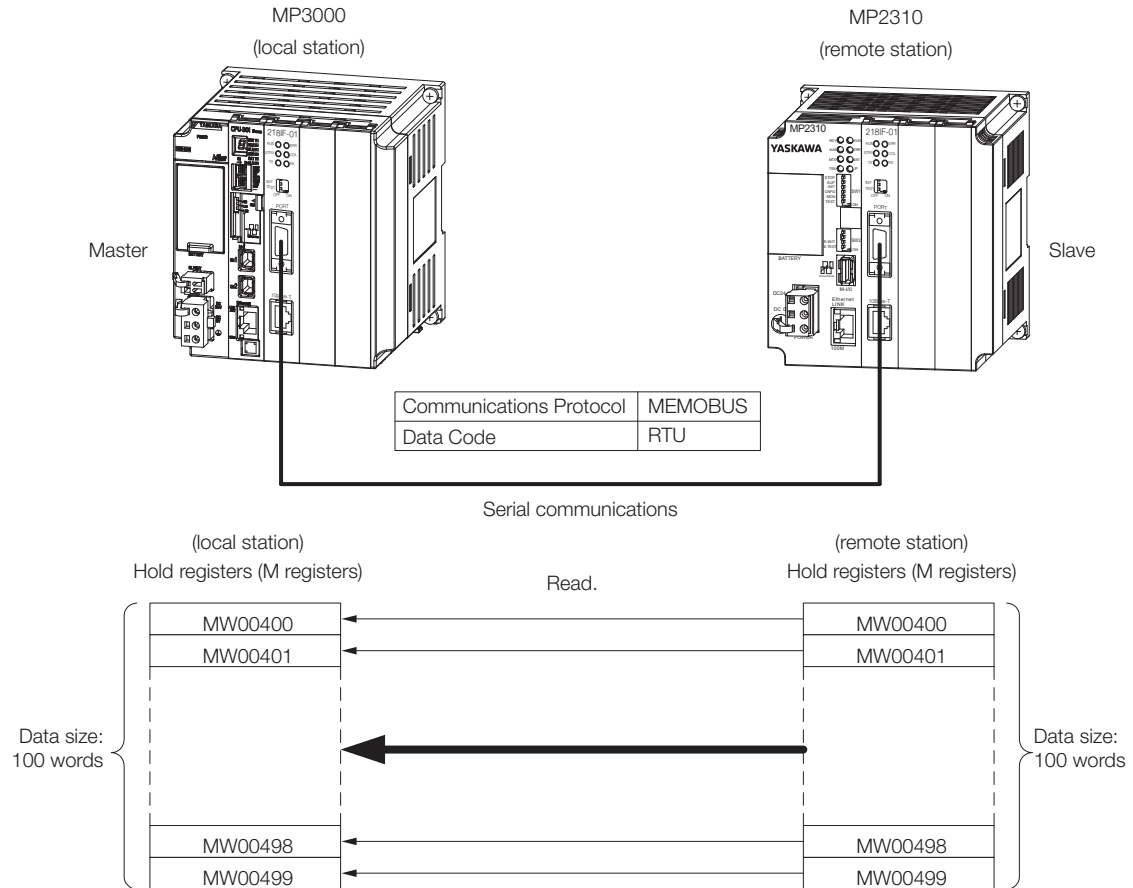

MP3000 Setup

Use the following procedure to set up the MP3000.

Information If the communications parameters (IP address and subnet mask) have already been set, skip to step 3.

1. Double-click the cell for 217IF in the Module Configuration Definition Tab Page.

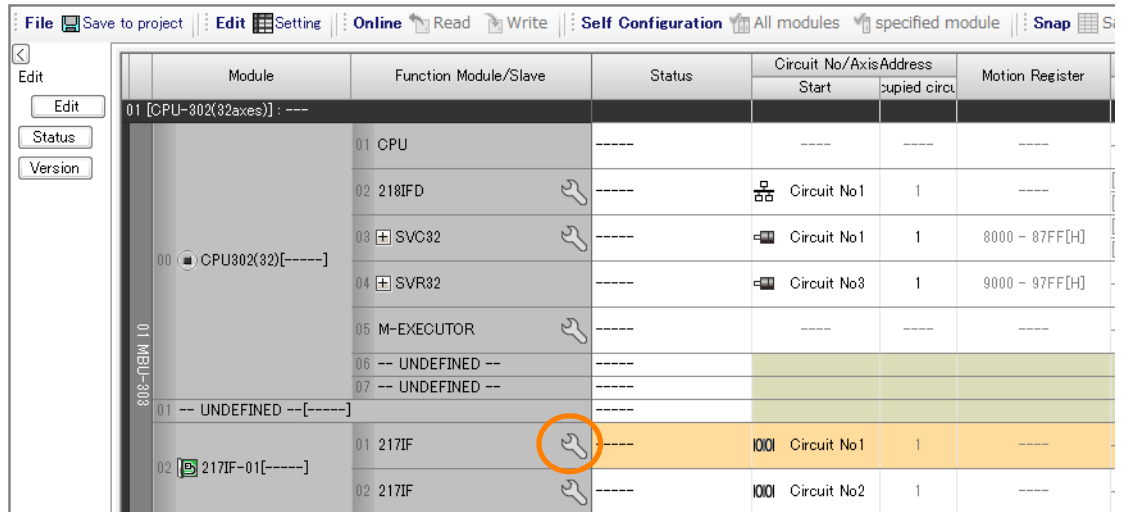

The 217IF Detail Definition Dialog Box will be displayed.

2. Set the detail definition for the 217IF.

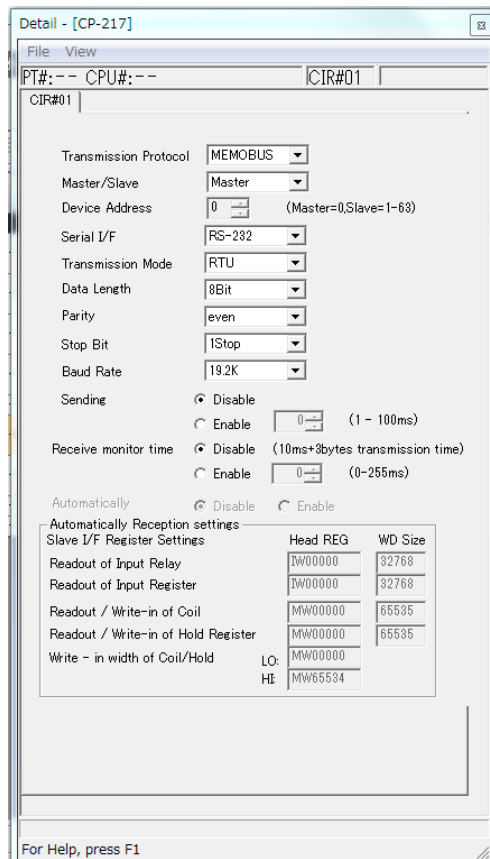

- ① Select [MEMOBUS] in the [Transmission Protocol] Box.
- ② Select [Master] in the [Master/Slave] Box.
- ③ For [Transmission Mode], [Data Length], [Parity], [Stop Bit], and [Baud Rate], enter the settings according to the settings on the master.

- 3. Select [Save] from the File Menu.

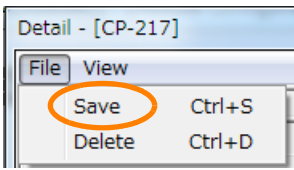

- 4. Click the [Yes] Button.

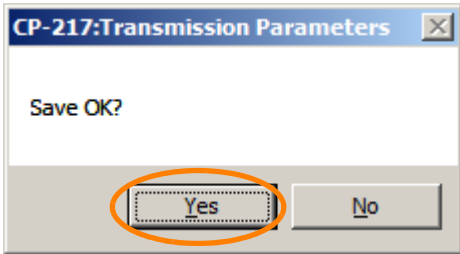

- 5. Create a ladder program for the MSG-SNDE function. A ladder program example is shown below.

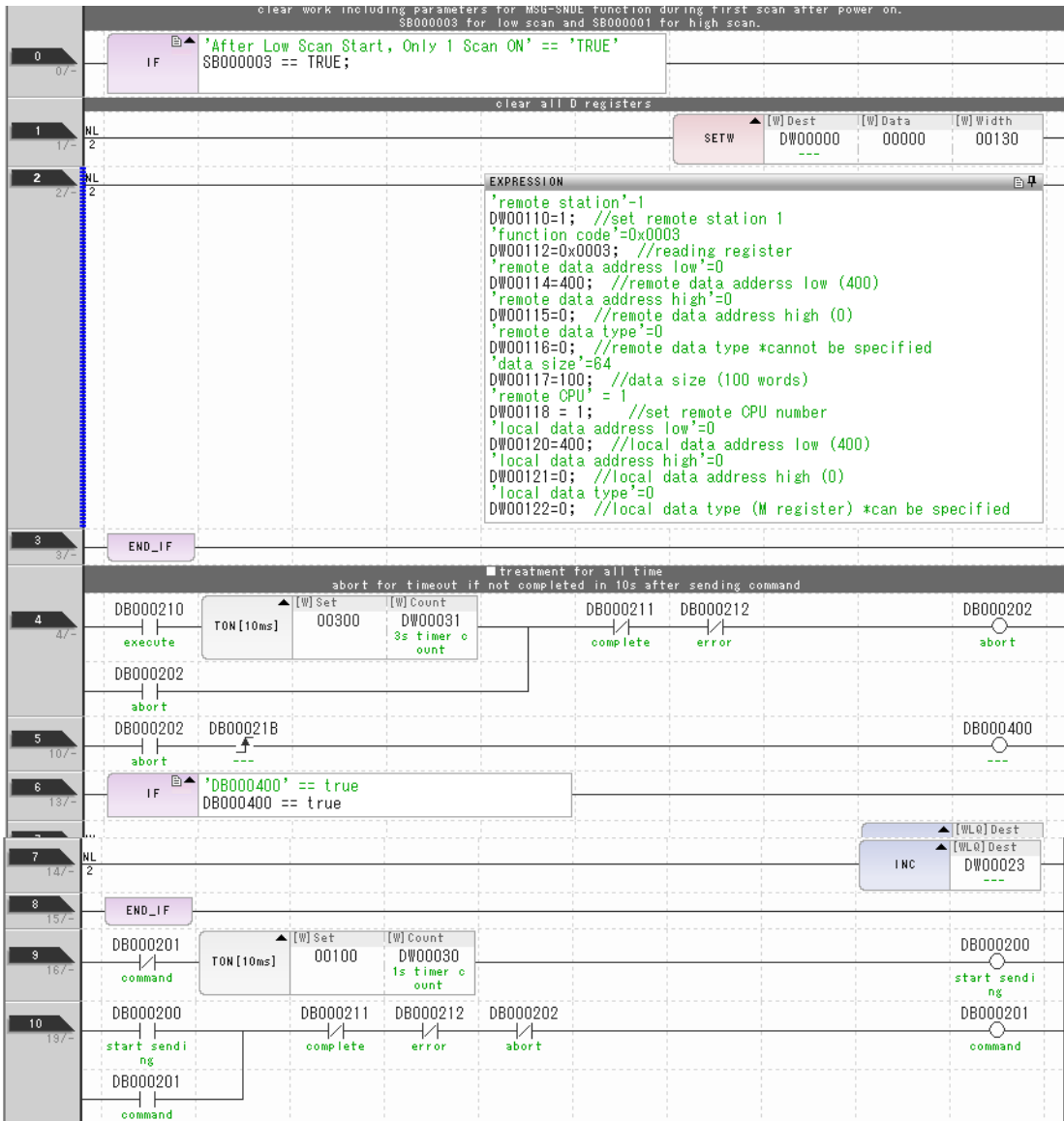

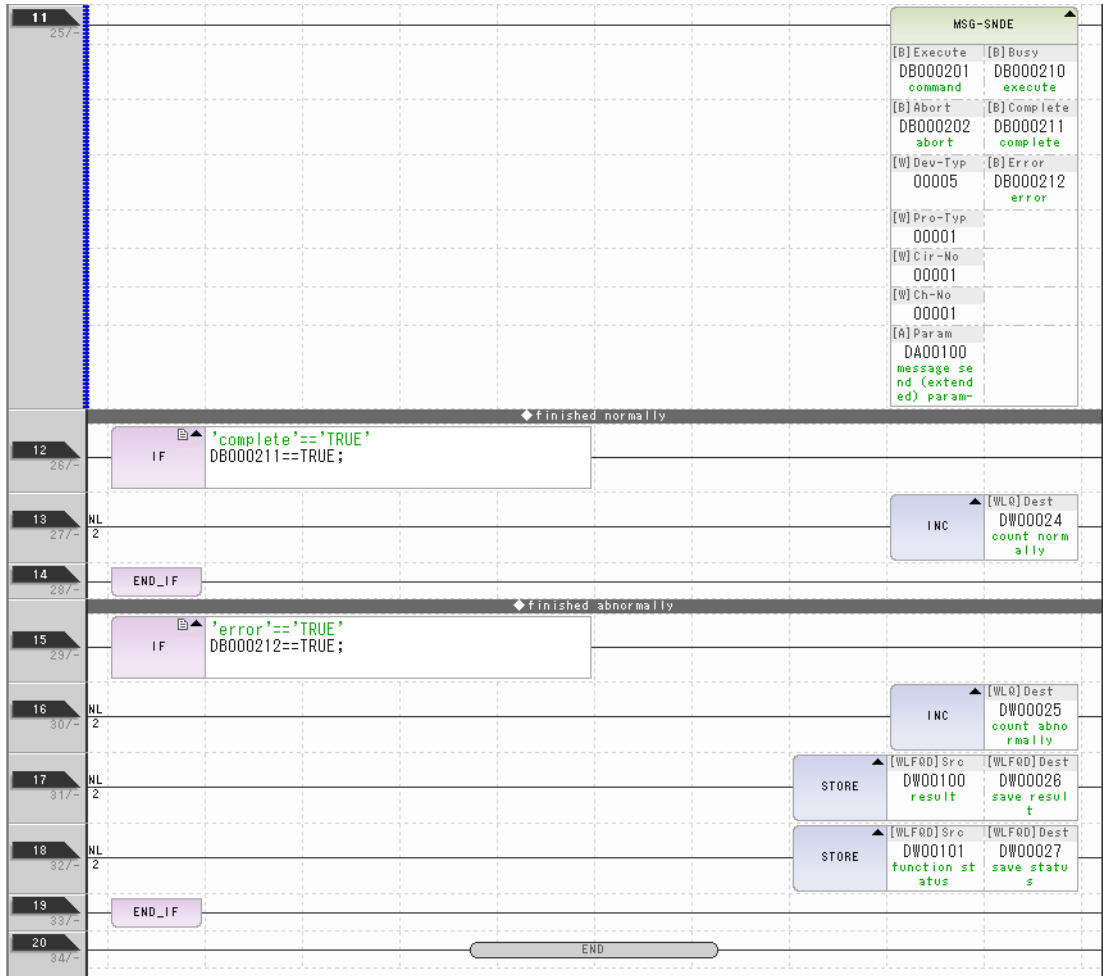

6. Save the data to flash memory.

This concludes the settings for using the MP3000 as the master.

Setting Up the Remote Device (MP2310)

Use the following procedure to set up the MP2310.

Information If the communications parameters (IP address and subnet mask) have already been set, skip to step 3.

1. Double-click the cell for 217IF in the Module Configuration Definition Tab Page.

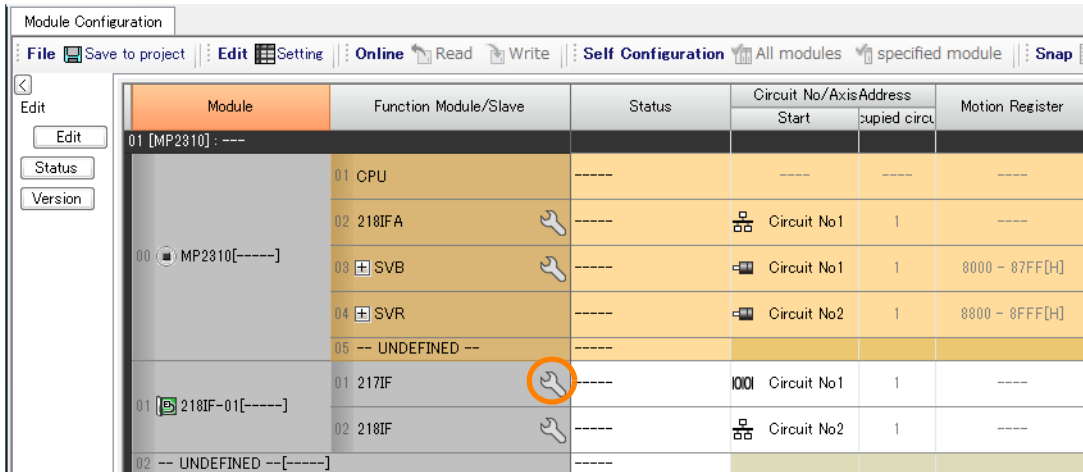

The 217IF Detail Definition Dialog Box will be displayed.

2. Set the detail definition for the 217IF.

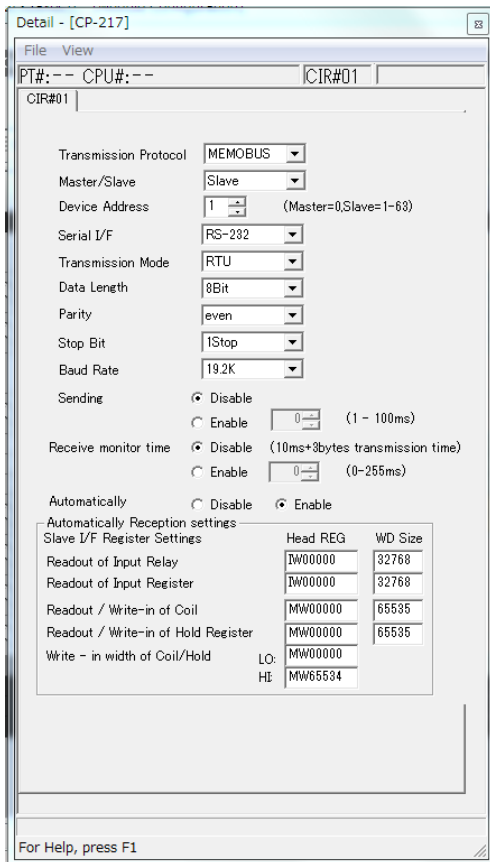

- ① Select [MEMOBUS] in the [Transmission Protocol] Box.
- ② Select [Slave] in the [Master/Slave] Box.
- ③ For [Transmission Mode], [Data Length], [Parity], [Stop Bit], and [Baud Rate], enter the settings according to the settings on the master.
- ④ Select [Enable] for [Automatically].

3. Select [Save] from the File Menu.

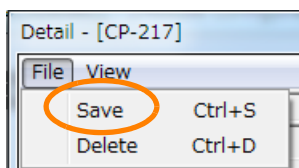

4. Click the [Yes] Button.

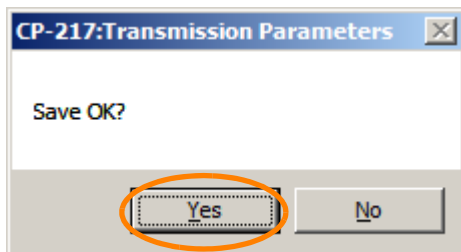

5. Save the data to flash memory.

This concludes the setup.

Starting Communications

1. Turn ON the power to the MP2310 to start automatically receiving messages.
2. Turn ON the Execute Bit (e.g., DB000200) for the MSG-SNDE function in the MP3000 to start sending messages.

The ladder program example is designed to send a message every second after five seconds have elapsed from when the low-speed scan (or high-speed scan) starts.

To change the message transmission interval, change the timer value ①.

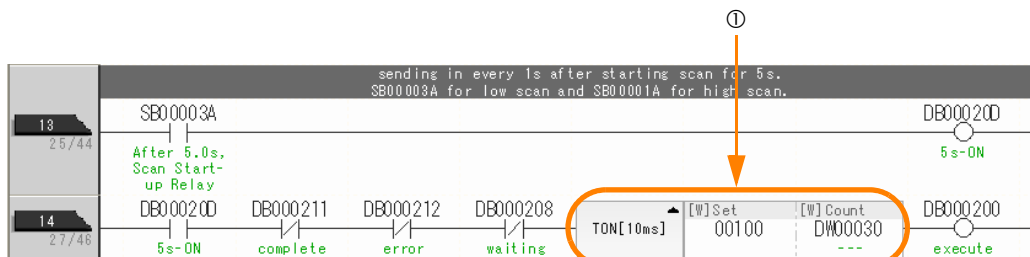

5.1.4 Message Functions

The message functions are used in user communications applications for the MEMOBUS protocol. You can send and receive message data by setting the necessary input items and parameters for the message functions.

Inputs and Outputs for the MSG-SNDE Function

I/O Definitions	No.	Name	I/O Designation	Meaning	Description
Input Items	1	Execute	B-VAL	Executes the transmission.	Specify the bit to use to execute the message transmission. When the Execute Bit turns ON, the message will be sent. Keep the Execute Bit ON until the Complete or Error Bit turns ON. To send another message, turn OFF the Execute Bit for at least one scan and then turn it ON again.
	2	Abort	B-VAL	Forces the transmission to end.	Specify the bit to use to abort the message transmission. When the Abort Bit turns ON, the message transmission will be stopped unconditionally. The Abort Bit takes precedence over the Execute Bit.
	3	Dev-Typ	I-REG	Communications device type	Specify the type code of the communications device. 217IF = 5
	4	Pro-Typ	I-REG	Communications protocol	Specify the type code of the communications protocol. 1: MEMOBUS Select this protocol when using the MEMOBUS protocol. 2: No-protocol communications 1 (unit: words) Not used for the MEMOBUS protocol. 3: No-protocol communications 2 (unit: bytes) Not used for the MEMOBUS protocol.
	5	Cir-No	I-REG	Circuit number	Specify the circuit number for the communications device. Specify the same circuit number as displayed in the MPE720 Module Configuration Definition Tab Page. 217IF = 1 to 16
	6	Ch-No	I-REG	Communications buffer channel number	Specify the channel number of the communications buffer. You can specify any channel number provided it is within the valid range. When executing more than one function at the same time, do not use the same channel number for the same station. You can use the same channel number as long as multiple functions are not executed at the same time. 217IF = 1
	7	Param	Address Inputs	Parameter list first address (MA, DA)	Specify the first address of the parameter list. A total of 29 words starting from the specified first word are automatically used for the parameter list. The parameter list is used by inputting function codes and relevant parameter data. It is also where the process results and status are output.



Continued on next page.

Continued from previous page.

I/O Definitions	No.	Name	I/O Designation	Meaning	Description
Output Items	1	Busy	B-VAL	Processing.	Specify the bit that shows that the message transmission is in progress. The Busy Bit is ON while a message transmission or abort is in progress. Keep the Execute Bit or Abort Bit turned ON while the Busy Bit is ON.
	2	Complete	B-VAL	Process completed.	Specify the bit that shows when the message transmission has been completed. The Complete Bit turns ON only for one scan when message transmission or forced abort processing has been completed normally.
	3	Error	B-VAL	Error occurred.	Specify the bit that shows if an error occurred when sending the message. When an error occurs, the Error Bit will turn ON only for one scan. Refer to the following section for an example of a timing chart for when an error occurs.  ◆ Error on page 2-8

MSG-SNDE Function Parameters

The following table describes the contents of the addresses specified by the PARAM input parameter to the MSG-SNDE function.















No.	I/O	Meaning	Description	Reference Page
00	Out-puts	Processing Result	Gives the processing status.	 ◆ Processing Result (PARAM00) on page 2-9
01		Status	Gives the status of the current function.	 ◆ Status (PARAM01) on page 2-10
02		Detail Error Code, Lower Word	Gives the details of an error.	 ◆ Detail Error Code (PARAM02 and PARAM03) on page 2-11
03		Detail Error Code, Upper Word		
04		Status 1	Not used for the 217IF.	–
05		Status 2	Not used for the 217IF.	–
06		Status 3	Not used for the 217IF.	–
07		Status 4	Not used for the 217IF.	–
08		Status 5	Not used for the 217IF.	–
09	Status 6	Not used for the 217IF.	–	

Continued on next page.

5.1 MEMOBUS Protocol

5.1.4 Message Functions

Continued from previous page.

No.	I/O	Meaning	Description	Reference Page
10	Inputs	Station Number	Sets the remote station number.	 ◆ <i>Connection Number (PARAM10)</i> on page 2-13
11		Option	Not used for the MEMOBUS protocol.	–
12		Function Code	Sets the code of the function in the MEMOBUS protocol.	 ◆ <i>Function Code (PARAM12)</i> on page 5-25
13		Reserved for system.	This parameter is used by the system. Do not change the value of this parameter from a user program or by any other means.	 ◆ <i>Reserved for System (PARAM13)</i> on page 2-14
14		Remote Station Data Address, Lower Word	Sets the data address to read/write at the remote station. (Use word addresses for registers, bit addresses for relays or coils.)	 ◆ <i>Remote Station Data Address (PARAM14 and PARAM15)</i> on page 2-15
15		Remote Station Data Address, Upper Word		
16		Remote Station Register Type	Not used for the 217IF.	  <i>Inputs and Outputs for the MSG-RCVE Function</i> on page 5-26
17		Data Size	Sets the size of the data to read/write. (Use word sizes for registers, bit sizes for relays or coils.)	 ◆ <i>Data Size (PARAM17)</i> on page 2-16
18		Remote CPU Module Number	Sets the CPU number at the remote station.	 ◆ <i>Remote CPU Module Number (PARAM18)</i> on page 2-17
19		Reserved for system.	This parameter is used by the system. Do not change the value of this parameter from a user program or by any other means.	 ◆ <i>Reserved for System (PARAM19)</i> on page 2-17
20		Local Station Data Address, Lower Word	Sets the data address to store read/write data in the local station. (Use word addresses for registers, bit addresses for relays or coils.)	 ◆ <i>Local Station Data Address (PARAM20 and PARAM21)</i> on page 2-18
21		Local Station Data Address, Upper Word		
22		Local station register type	Sets the register type of the read/write data to store in the local station.	 ◆ <i>Local Station Register Type (PARAM22)</i> on page 2-19
23		Reserved for system.	This parameter is used by the system. Do not change the value of this parameter from a user program or by any other means.	 ◆ <i>Reserved for System (PARAM23)</i> on page 2-19
24	–	For system use	This parameter is used by the system. It contains the channel number of the communications buffer that is currently in use. A user program must set this parameter to 0 on the first scan after startup. Thereafter, do not change the value of this parameter from a user program or by any other means because it will be used by the system.	 ◆ <i>Reserved for System (PARAM24)</i> on page 2-19
25	–	Reserved for system.	These parameters are used by the system. Do not change the value of these parameters from a user program or by any other means.	 ◆ <i>Reserved for System (PARAM25 to PARAM28)</i> on page 2-19
26	–	Reserved for system.		
27	–	Reserved for system.		
28	–	Reserved for system.		

◆ Function Code (PARAM12)

Set the function code to send.

You can use the functions that are registered to the function codes.

Function Code Code	Target Data Type	Function	Registers When Acting as the Master	
			Send Registers	Receive Registers
00 hex	–	Not used for the MEMOBUS protocol.	S, M, G, I, or O	M or G
01 hex	B	Reads the states of coils.		
02 hex	B	Reads the states of input relays.		
03 hex	W	Reads the contents of hold registers.		
04 hex	W	Reads the contents of input registers.		
05 hex	B	Changes the state of a single coil.		
06 hex	W	Writes to a single hold register.		
07 hex	–	Not used for the MEMOBUS protocol.		
08 hex	–	Performs a loopback test.		
0F hex	B	Changes the states of multiple coils.		
10 hex	W	Writes to multiple hold registers.		

Note: B: Bit data, W: Integer data

Inputs and Outputs for the MSG-RCVE Function

I/O Definitions	No.	Name	I/O Designation	Meaning	Description
Input Items	1	Execute	B-VAL	Executes the transmission.	Specify the bit to use to execute the message transmission. When the Execute Bit turns ON, the message will be sent. Keep the Execute Bit ON until the Complete or Error Bit turns ON. To send another message, turn OFF the Execute Bit for at least one scan and then turn it ON again.
	2	Abort	B-VAL	Forces the transmission to end.	Specify the bit to use to abort the message transmission. When the Abort Bit turns ON, the message transmission will be stopped unconditionally. The Abort Bit takes precedence over the Execute Bit.
	3	Dev-Typ	I-REG	Communications device type	Specify the type code of the communications device. 217IF = 5
	4	Pro-Typ	I-REG	Communications protocol	Specify the type code of the communications protocol. 1: MEMOBUS Select this protocol when using the MEMOBUS protocol. 2: No-protocol communications 1 (unit: words) Not used for the MEMOBUS protocol. 3: No-protocol communications 2 (unit: bytes) Not used for the MEMOBUS protocol.
	5	Cir-No	I-REG	Circuit number	Specify the circuit number for the communications device. Specify the same circuit number as displayed in the MPE720 Module Configuration Definition Tab Page. 217IF = 1 to 16
	6	Ch-No	I-REG	Communications buffer channel number	Specify the channel number of the communications buffer. You can specify any channel number provided it is within the valid range. When executing more than one function at the same time, do not use the same channel number for the same station. You can use the same channel number as long as multiple functions are not executed at the same time. 217IF = 1
	7	Param	Address Inputs	Parameter list first address (MA,DA)	Specify the first address of the parameter list. A total of 52 words starting from the specified first word are automatically used for the parameter list. The parameter list is used by inputting function codes and relevant parameter data. It is also where the process results and status are output.







Continued on next page.

Continued from previous page.

I/O Definitions	No.	Name	I/O Designation	Meaning	Description
Output Items	1	Busy	B-VAL	Processing.	Specify the bit that shows that the message transmission is in progress. The Busy Bit is ON while a message transmission or abort is in progress. Keep the Execute Bit or Abort Bit turned ON while the Busy Bit is ON.
	2	Complete	B-VAL	Process completed.	Specify the bit that shows when the message transmission has been completed. The Complete Bit turns ON only for one scan when message transmission or forced abort processing has been completed normally.
	3	Error	B-VAL	Error occurred.	Specify the bit that shows if an error occurred when sending the message. When an error occurs, the Error Bit will turn ON only for one scan. Refer to the following section for an example of a timing chart for when an error occurs.  ◆ Error on page 2-23

MSG-RCVE Function Parameters

The following table describes the contents of the addresses specified by the PARAM input parameter to the MSG-RCVE function.

No.	I/O	Meaning	Description	Reference Page
00	Out-puts	Processing Result	Gives the processing status.	 ◆ Processing Result (PARAM00) on page 2-25
01		Status	Gives the status of the current function.	 ◆ Status (PARAM01) on page 2-25
02		Detail Error Code, Lower Word	Gives the details of an error.	 ◆ Detail Error Code (PARAM02 and PARAM03) on page 2-27
03		Detail Error Code, Upper Word		
04		Status 1	Not used for the 217IF.	–
05		Status 2	Not used for the 217IF.	–
06		Status 3	Not used for the 217IF.	–
07		Status 4	Not used for the 217IF.	–
08		Status 5	Not used for the 217IF.	–
09		Status 6	Not used for the 217IF.	–
10		Station Number	Sets the remote station number.	 ◆ Connection Number (PARAM10) on page 2-29
11	I/O	Option	Not used for the MEMOBUS protocol.	–
12	Output	Function Code	Gives the function associated with reading or writing that was received from the remote station as the function code.	 ◆ Function Code (PARAM12) on page 2-29
13	I/O	Reserved for system.	This parameter is used by the system. Do not change the value of this parameter from a user program or by any other means.	 ◆ Reserved for System (PARAM13) on page 2-30

Continued on next page.

5.1 MEMOBUS Protocol







5.1.4 Message Functions

Continued from previous page.

No.	I/O	Meaning	Description	Reference Page
14	Out-puts	Data Address, Lower Word	Gives the first address of the data that was requested by the remote station.	☞ ◆ Data Address (PARAM14 and PARAM15) on page 2-30
15		Data Address, Upper Word		
16		Register Types	Not used for the 217IF.	–
17		Data Size	Gives the data size that was requested by the remote station.	☞ ◆ Data Size (PARAM17) on page 2-31
18		Remote CPU Module Number	Not used for the MEMOBUS protocol.	–
19	I/O	Reserved for system.	This parameter is used by the system. Do not change the value of this parameter from a user program or by any other means.	☞ ◆ Reserved for System (PARAM19) on page 2-31
20	Inputs	Coil Offset Lower Word	Sets the offset word address for a coil (MB).	☞ ◆ Coil Offset (PARAM20 and PARAM21) on page 2-31
21		Coil offset Upper Word		
22		Input Relay Offset, Lower Word	Sets the offset word address for an input relay (IB).	☞ ◆ Input Relay Offset (PARAM22 and PARAM23) on page 2-32
23		Input Relay Offset, Upper Word		
24		Input Register Offset, Lower Word	Sets the offset word address for an input register (IW).	☞ ◆ Input Register Offset (PARAM24 and PARAM25) on page 2-32
25		Input Register Offset, Upper Word		
26		Hold Register Offset, Lower Word	Sets the offset word address for a hold register (MW).	☞ ◆ Hold Register Offset (PARAM26 and PARAM27) on page 2-32
27		Hold Register Offset, Upper Word		
28		Data Relay Offset, Lower Word	Sets the offset word address for a data relay (GB).	☞ ◆ Data Relay Offset (PARAM28 and PARAM29) on page 2-32
29		Data Relay Offset, Upper Word		
30		Data Register Offset, Lower Word	Sets the offset word address for a data register (GW).	☞ ◆ Data Register Offset (PARAM30 and PARAM31) on page 2-32
31		Data Register Offset, Upper Word		
32		Output Coil Offset, Lower Word	Sets the offset word address for an output coil (OB).	☞ ◆ Output Coil Offset (PARAM32 and PARAM33) on page 2-32
33		Output Coil Offset, Upper Word		
34		Output Register Offset, Lower Word	Sets the offset address for an output register (OW).	☞ ◆ Output Register Offset (PARAM34 and PARAM35) on page 2-32
35		Output Register Offset, Upper Word		
36		M Register Writing Range LO, Lower Word	Sets the first address of the writing range for hold register coils.	☞ ◆ M Register Writing Range LO (PARAM36 and PARAM37) on page 2-33
37	M Register Writing Range LO, Upper Word			

Continued on next page.

Continued from previous page.

No.	I/O	Meaning	Description	Reference Page
38	Inputs	M register Writing Range HI, Lower Word	Sets the last address of the writing range for hold register coils.	 ◆ M Register Writing Range HI (PARAM38 and PARAM39) on page 2-33
39		M Register Writing Range HI, Upper Word		
40		G register Writing Range LO, Lower Word	Sets the first address of the writing range for data register data relays.	 ◆ G Register Writing Range LO (PARAM40 and PARAM41) on page 2-33
41		G Register Writing Range LO, Upper Word		
42		G Register Writing Range HI, Lower Word	Sets the last address of the writing range for data register data relays.	 ◆ G Register Writing Range HI (PARAM42 and PARAM43) on page 2-33
43		G Register Writing Range HI, Upper Word		
44		O Register Writing Range LO, Lower Word	Sets the first address of the writing range for output registers.	 ◆ O Register Writing Range LO (PARAM44 and PARAM45) on page 2-33
45		O Register Writing Range LO, Upper Word		
46		O Register Writing Range HI, Lower Word	Sets the last address of the writing range for output registers.	 ◆ O Register Writing Range HI (PARAM46 and PARAM47) on page 2-34
47		O Register Writing Range HI, Upper Word		
48	-	For system use	This parameter is used by the system. It contains the channel number of the communications buffer that is currently in use. A user program must set this parameter to 0 on the first scan after startup. Thereafter, do not change the value of this parameter from a user program or by any other means because it will be used by the system.	 ◆ For System Use (PARAM48) on page 2-34
49	-	Reserved for system.	These parameters are used by the system. Do not change the value of these parameters from a user program or by any other means.	 ◆ Reserved for System (PARAM49 to PARAM51) on page 2-34
50	-	Reserved for system.		
51	-	Reserved for system.		

5.2 A-Compatible 1C Frame Protocol

5.2.1 Using the MSG-SNDE Function with the MP3000 as the Master

Setting Example

The following figure illustrates how the contents of 64 words from the MB00000 to MB00063 hold registers in the MP3000 master are written to the 000000 to 000063 data registers in the CPU Unit of the Mitsubishi PLC slave.

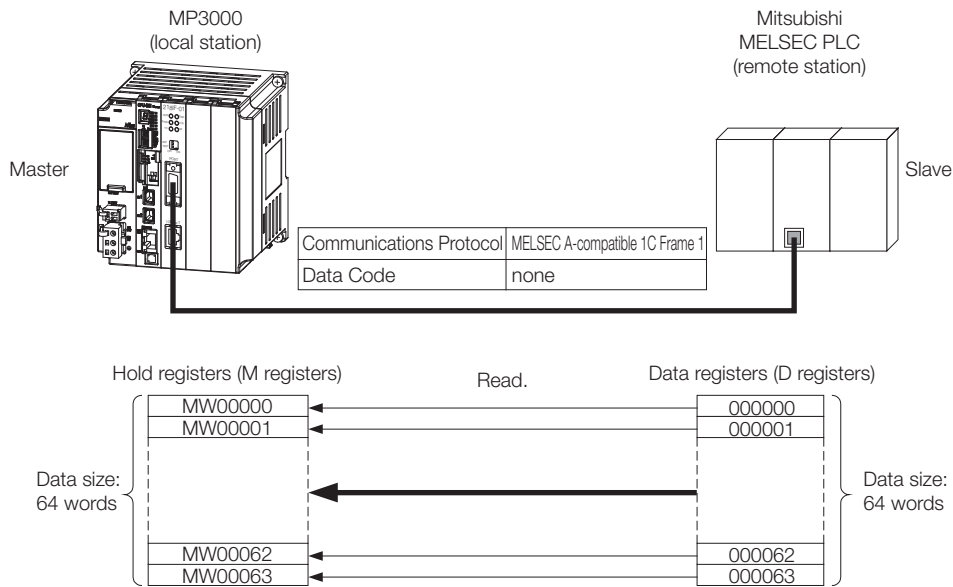

◆ MP3000 Setup

Use the following procedure to set up the MP3000.

Information If the communications parameters (IP address and subnet mask) have already been set, skip to step 3.

1. Double-click the cell for 217IF in the Module Configuration Definition Tab Page.

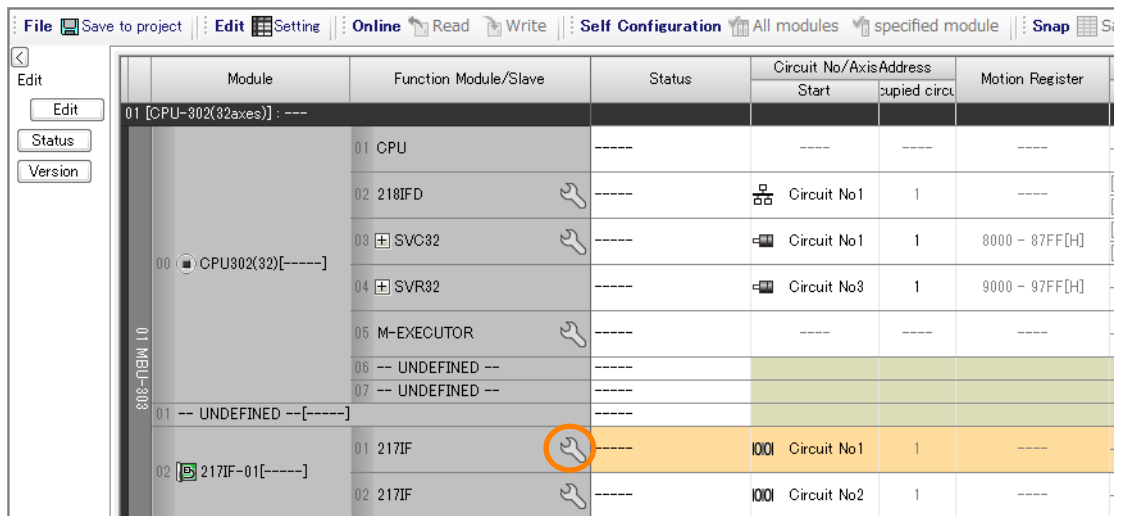

The 217IF Detail Definition Dialog Box will be displayed.

2. Set the detail definition for the 217IF.

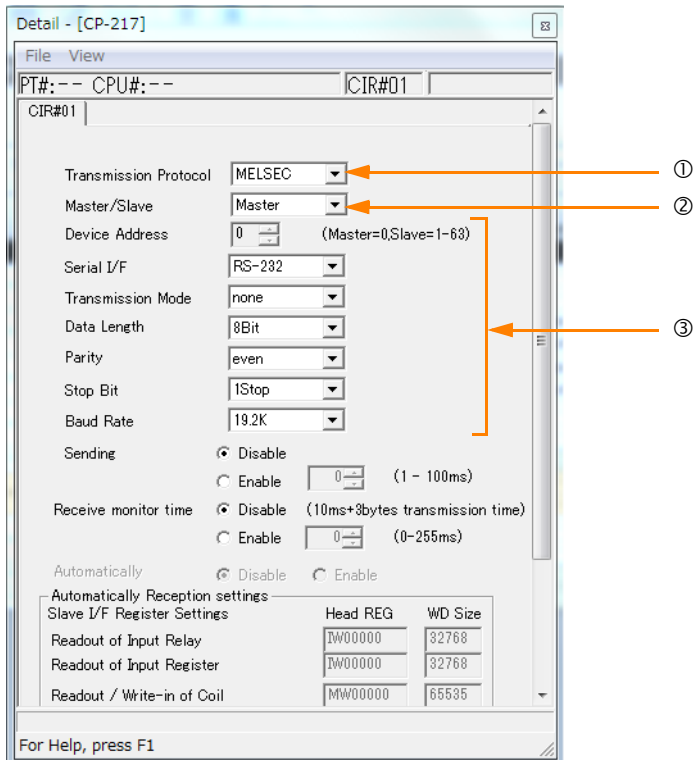

3. Select [Save] from the File Menu.

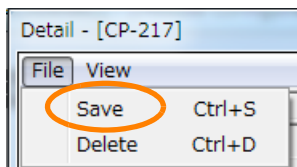

4. Click the [Yes] Button.

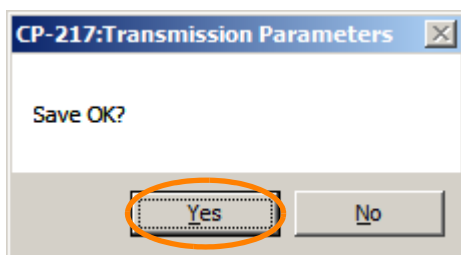

5. Create a ladder program for the MSG-SNDE function.
 A ladder program example is shown below.

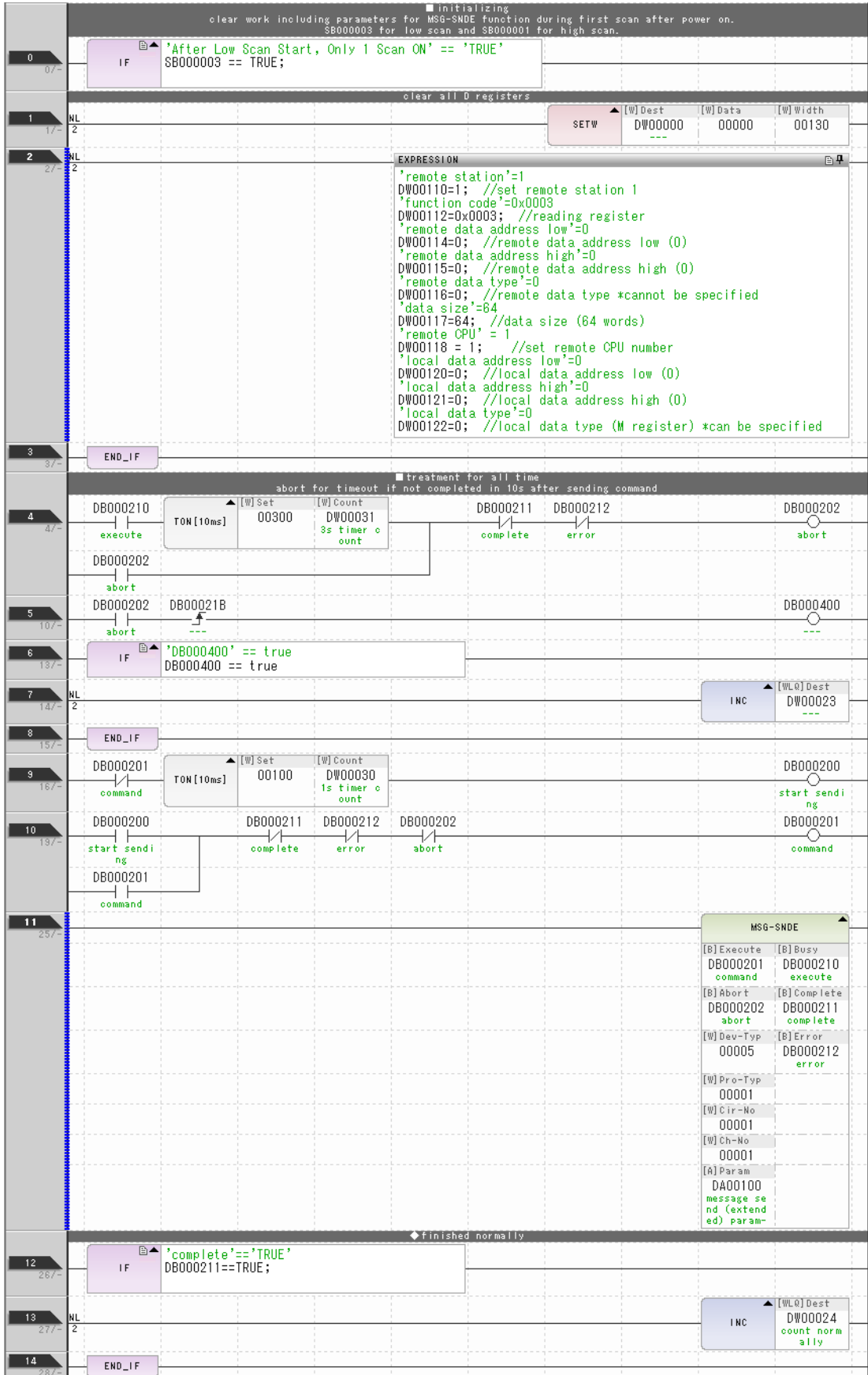

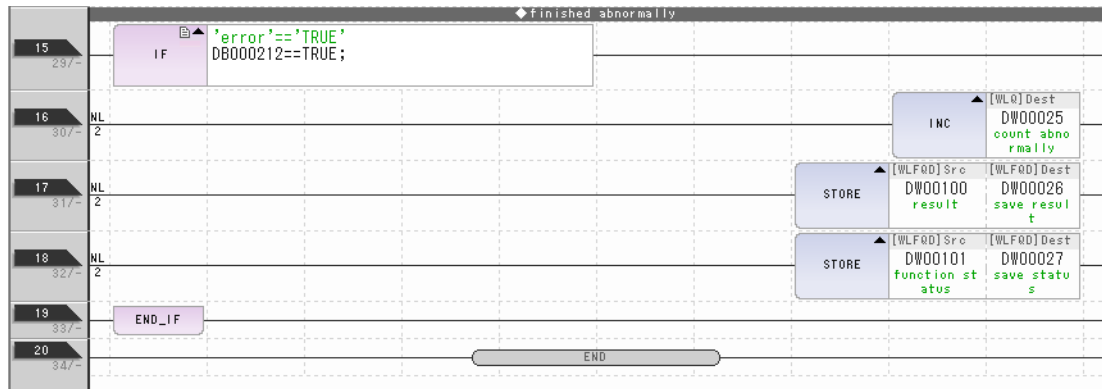

6. Save the data to flash memory.

This concludes the settings for using the MP3000 as the master.

◆ Setting Up the Remote Device (Mitsubishi PLC)

Use the following procedure to set up the Mitsubishi PLC (MELSEC device). The AJ71UC24 is used as an example.

Information MELSEC devices are manufactured by Mitsubishi Electric Corporation. Contact Mitsubishi Electric Corporation for further information on MELSEC devices.

■ Buffer Memory Settings

Change the two locations shown in the following table.

The buffer memory is not backed up. Set these values in the user program.

Address	Name	Default	Recommended Value
10B hex	RS-232C CD terminal check setting area	0 (Check)	1 (Do not check)
11A hex	Transfer flow control designation area	0 (DTR flow control)	1 (No DTR flow control)

Note: 1. Keep the other addresses at the default settings.

2. The above addresses are the values when the 217IF-01 is mounted in Slot 1. The values will change in other slots.

■ Station Number Setting Switches

Set the station number between 01 and 31. (Recommended value: 01)

Switch Name	Parameter	Recommended Value
×10 (Rotary switch from 0 to 9)	Sets the tens place of the station number.	0
×1 (Rotary switch from 0 to 9)	Sets the ones place of the station number.	1

■ Communications Settings Switches on the AJ71UC24 Module

Switch Name	Parameter	Description		Setting Value* ¹
		ON	OFF	
SW11	Main channel setting	RS-422	RS-232C	OFF
SW12	Data bits setting	8 bits	7 bits	ON
SW13	Baud rate setting	* ² See the following table.		OFF
SW14				ON
SW15				ON
SW16	Parity bit selection	Use	Do not use	ON
SW17	Even parity/odd parity	Even	Odd	ON
SW18	Stop bit setting	2 bits	1 bit	OFF
SW21	Checksum selection	Use	Do not use	ON
SW22	Allow writes while running	Allow	Prohibit	ON
SW23	Computer link/multidrop	Computer link	Multidrop	ON
SW24	Not used	–		OFF

*1. The values in shaded cells are example settings.

*2. The following table shows the relationship between the settings of switches SW13 to SW15 and the baud rate.

Rate in bps	300	600	1200	2400	4800	9600	19200
SW13	OFF	ON	OFF	ON	OFF	ON	OFF
SW14	OFF	OFF	ON	ON	OFF	OFF	ON
SW15	OFF	OFF	OFF	OFF	ON	ON	ON

Note: For the AJ71C24-S8, the selection of terminating resistance on the sending device and the settings to use as well as the selection of terminating resistance on the receiving device and the settings to use depends on the wiring.

■ Mode Setting Switch

Switch Name	Setting Switch Number	Port Operation Mode		Setting Value	
		RS-232C Port	RS-422/485-side Port		
MODE (Rotary switch from 0 to F)	0	Cannot be used		RS-232C connection: 1 RS-422/485 connection: 5	
	1	Format 1 protocol mode	No-protocol communications		
	2	Format 2 protocol mode	No-protocol communications		
	3	Format 3 protocol mode	No-protocol communications		
	4	Format 4 protocol mode	No-protocol communications		
	5	No-protocol communications	Format 1 protocol mode		
	6	No-protocol communications	Format 2 protocol mode		
	7	No-protocol communications	Format 3 protocol mode		
	8	No-protocol communications	Format 4 protocol mode		
	9	No-protocol communications	↔		No-protocol communications
	A	Format 1 protocol mode	↔		Format 1 protocol mode
	B	Format 2 protocol mode	↔		Format 2 protocol mode
	C	Format 3 protocol mode	↔		Format 3 protocol mode
	D	Format 4 protocol mode	↔		Format 4 protocol mode
E	Cannot be used				
F	For standalone testing				

◆ Starting Communications

Use the following procedure to write the data in the hold registers in the MP3000 to the internal relays in the CPU Unit of the Mitsubishi PLC.

1. Start receiving messages on the Mitsubishi PLC.

The system will automatically start the message reception operation. No further operation is required.

2. Turn ON the power to the MP3000 to start transmitting messages.

The ladder program example is designed to turn ON the Execute Bit (DB000201) in the message send function after one second has elapsed from when the low-speed scan (or high-speed scan) starts. Thereafter, the message send function is executed every second by alternating the Execute Bit (DB000201) between OFF and ON each time the message send function completes execution normally or with an error.

5.2.2 Message Functions

Inputs and Outputs for the MSG-SNDE Function

I/O Definitions	No.	Name	I/O Designation	Meaning	Description
Input Items	1	Execute	B-VAL	Executes the transmission.	Specify the bit to use to execute the message transmission. When the Execute Bit turns ON, the message will be sent. Keep the Execute Bit ON until the Complete or Error Bit turns ON. To send another message, turn OFF the Execute Bit for at least one scan and then turn it ON again.
	2	Abort	B-VAL	Forces the transmission to end.	Specify the bit to use to abort the message transmission. When the Abort Bit turns ON, the message transmission will be stopped unconditionally. The Abort Bit takes precedence over the Execute Bit.
	3	Dev-Typ	I-REG	Communications device type	Specify the type code of the communications device. 217IF = 5
	4	Pro-Typ	I-REG	Communications protocol	Specify the type code of the communications protocol. 1: MEMOBUS Select this protocol when using the A-compatible 1C Frame protocol. MEMOBUS is automatically converted to the A-compatible 1C Frame protocol inside the 217IF. 2: No-protocol communications 1 (unit: words) Not used for the A-compatible 1C Frame protocol. 3: No-protocol communications 2 (unit: bytes) Not used for the A-compatible 1C Frame protocol.
	5	Cir-No	I-REG	Circuit number	Specify the circuit number for the communications device. Specify the same circuit number as displayed in the MPE720 Module Configuration Definition Tab Page. 217IF = 1 to 16
	6	Ch-No	I-REG	Communications buffer channel number	Specify the channel number of the communications buffer. You can specify any channel number provided it is within the valid range. When executing more than one function at the same time, do not use the same channel number for the same station. You can use the same channel number as long as multiple functions are not executed at the same time. 217IF = 1
	7	Param	Address Inputs	Parameter list first address (MA, DA)	Specify the first address of the parameter list. A total of 29 words starting from the specified first word are automatically used for the parameter list. The parameter list is used by inputting function codes and relevant parameter data. It is also where the process results and status are output.



Continued on next page.

Continued from previous page.

I/O Definitions	No.	Name	I/O Designation	Meaning	Description
Output Items	1	Busy	B-VAL	Processing.	Specify the bit that shows that the message transmission is in progress. The Busy Bit is ON while a message transmission or abort is in progress. Keep the Execute Bit or Abort Bit turned ON while the Busy Bit is ON.
	2	Complete	B-VAL	Process completed.	Specify the bit that shows when the message transmission has been completed. The Complete Bit turns ON only for one scan when message transmission or forced abort processing has been completed normally.
	3	Error	B-VAL	Error occurred.	Specify the bit that shows if an error occurred when sending the message. When an error occurs, the Error Bit will turn ON only for one scan. Refer to the following section for an example of a timing chart for when an error occurs.  ◆ Error on page 2-8

MSG-SNDE Function Parameters

The following table describes the contents of the addresses specified by the PARAM input parameter to the MSG-SNDE function.









No.	I/O	Meaning	Description	Reference Page
00	Out-puts	Processing Result	Gives the processing status.	 ◆ Processing Result (PARAM00) on page 2-9
01		Status	Gives the status of the current function.	 ◆ Status (PARAM01) on page 2-10
02		Detail Error Code, Lower Word	Gives the details of an error.	 ◆ Detail Error Code (PARAM02 and PARAM03) on page 2-11
03		Detail Error Code, Upper Word		
04		Status 1	Not used for the 217IF.	–
05		Status 2	Not used for the 217IF.	–
06		Status 3	Not used for the 217IF.	–
07		Status 4	Not used for the 217IF.	–
08		Status 5	Not used for the 217IF.	–
09	Status 6	Not used for the 217IF.	–	

Continued on next page.

5.2 A-Compatible 1C Frame Protocol

5.2.2 Message Functions

Continued from previous page.

No.	I/O	Meaning	Description	Reference Page
10	Inputs	Station Number	Sets the remote station number.	 ◆ Station Number (PARAM10) on page 5-39
11		Option	Not used for the A-compatible 1C Frame protocol.	–
12		Function Code	Sets the code of the function in the A-compatible 1C Frame protocol.	 ◆ Function Code (PARAM12) on page 5-39
13		Reserved for system.	Not used for the A-compatible 1C Frame protocol.	–
14		Remote Station Data Address, Lower Word	Sets the data address to read/write at the remote station. (Use word addresses for registers, bit addresses for relays or coils.)	 ◆ Data Addresses (PARAM14 and PARAM15) on page 5-39
15		Remote Station Data Address, Upper Word		
16		Remote Station Register Type	Not used for the A-compatible 1C Frame protocol.	–
17		Data Size	Sets the size of the data to read/write. (Use word sizes for registers, bit sizes for relays or coils.)	 ◆ Data Size (PARAM17) on page 5-40
18		Remote CPU Module Number	Not used for the A-compatible 1C Frame protocol.	–
19		Reserved for system.	Not used for the A-compatible 1C Frame protocol.	–
20		Local Station Data Address, Lower Word	Sets the data address to store read/write data in the local station. (Use word addresses for registers, bit addresses for relays or coils.)	 ◆ Data Addresses (PARAM14 and PARAM15) on page 5-39
21		Local Station Data Address, Upper Word		
22		Local Station Register Type	Sets the register type of the read/write data to store in the local station.	 ◆ Local Station Register Type (PARAM22) on page 2-19
23		Reserved for system.	This parameter is used by the system. Do not change the value of this parameter from a user program or by any other means.	 ◆ Reserved for System (PARAM23) on page 2-19
24		For system use	This parameter contains the channel number of the communications buffer that is currently in use. A user program must set this parameter to 0 on the first scan after startup. Thereafter, do not change the value of this parameter from a user program or by any other means because it will be used by the system.	 ◆ Reserved for System (PARAM24) on page 2-19
25		–	Reserved for system.	 ◆ Reserved for System (PARAM25 to PARAM28) on page 2-19
26		Reserved for system.	These parameters are used by the system. Do not change the value of these parameters from a user program or by any other means.	
27		Reserved for system.		
28		Reserved for system.		

◆ Station Number (PARAM10)

Specify the station number. The valid setting range is given in the following table.

Communications Device	Station Number	Remarks
Serial (2171F)	0x100	Sends the message to the remote station set to station number 0.
	1 to 254	Sends the message to the remote station set by the specified station number.

Note: The station number setting may be fixed to 0 depending on the MELSEC serial unit. In this case, set the remote station number to 0x100.

◆ Function Code (PARAM12)

This parameter gives the function code that was received.

The following table lists the function code when using MELSEC as the protocol type.

Common Instructions for MELSEC ACPUs	Function Code	Target Data Type	Function
WR	01 or 02 hex	B	Reads bit devices in units of 16 points.
	03 or 04 hex	W	Reads word devices in units of one point.
WW	0F hex	B	Writes bit devices in units of 16 points.
	10 hex	W	Writes word devices in units of one point.
TT	08 hex	–	Performs a loopback test.

Note: 1. B: Bit data, W: Integer data

2. AnCPU special instructions cannot be used. Instructions for extended file registers are also not supported.

◆ Data Addresses (PARAM14 and PARAM15)

Set the first address of the data.

Enter the first address as a decimal or hexadecimal number.

Example: If the first address is MW01000, enter 1000 (decimal) or 3E8 (hexadecimal).

The applicable function codes and valid range of data addresses depend on the device type and device range of the MELSEC PLC.

The following table lists the setting ranges of data addresses when using MELSEC as the protocol type.

Device	Common Instructions for ACPUs Device Range	Decimal/Hexadecimal	Function Code	Data Address Setting Range	Corresponding Register Addresses
X	X0000 to X07FF	Hexadecimal	02 hex: Input relay	0 to 2047	MB000000 to MB00127F
Y	Y0000 to Y07FF	Hexadecimal	01 or 0F hex: Coil	0 to 2047	MB000000 to MB00127F
M	M000 to M2047	Decimal	01 or 0F hex: Coil	2048 to 4095	MB001280 to MB00255F
M	M9000 to M9255	Decimal	01 or 0F hex: Coil	4096 to 4351	MB002560 to MB002715F
B	B0000 to B03FF	Hexadecimal	01 or 0F hex: Coil	4352 to 5375	MB002720 to MB00335F
F	F0000 to F0255	Decimal	01 or 0F hex: Coil	5376 to 5631	MB003360 to MB00351F
TS	TS000 to TS255	Decimal	02 hex: Input relay	2048 to 2303	MB001280 to MB00143F
TC	TC000 to TC255	Decimal	02 hex: Input relay	2304 to 2559	MB001440 to MB00159F
CS	CS000 to CS255	Decimal	02 hex: Input relay	2560 to 2815	MB001660 to MB00175F
CC	CC000 to CC255	Decimal	02 hex: Input relay	2816 to 3071	MB001760 to MB00191F
TN	TN0000 to TN255	Decimal	04 hex: Input register	0 to 255	MW000000 to MW000255
CN	CN0000 to CN255	Decimal	04 hex: Input register	256 to 511	MW000256 to MW000511
D	D0000 to D1023	Decimal	03 or 10 hex: Hold register	0 to 1023	MW000000 to MW01023

Continued on next page.

Continued from previous page.

Device	Common Instructions for ACPUs Device Range	Decimal/Hexadecimal	Function Code	Data Address Setting Range	Corresponding Register Addresses
D (Special)	D9000 to D9255	Decimal	03 or 10 hex: Hold register	1024 to 1279	MW01024 to MW01279
W	W0000 to W03FF	Hexadecimal	03 or 10 hex: Hold register	1280 to 2303	MW01280 to MW02303
R	R0000 to R8191	Decimal	03 or 10 hex: Hold register	2304 to 10495	MW02304 to MW10495

Note: 1. The address range of the device area depends on the MELSEC PLC, even if addresses are within the given range. Refer to the MELSEC manual for details.

2. The corresponding register address in the MP3000-series Machine Controller can be adjusted by using the offset settings of the MSG-SND function.

◆ Data Size (PARAM17)

Set the data size for the read/write request as the number of bits or words.

Be sure that the last data address that is determined by the offset, data address, and data size does not exceed the valid data address range.

The range that is allowed for the data size depends on the function code and communications device.

The following table lists the setting ranges of data sizes when using MELSEC as the protocol type.

MELSEC Common Instructions for ACPUs	Function Code	Function	Data Size Setting Range
WR	01 or 02 hex	Reads bit devices in units of 16 points.	1 to 512 points (32 words)
	03 or 04 hex	Reads word devices in units of one point.	1 to 64 points
WW	0F hex	Writes bit devices in units of 16 points.	1 to 160 points (10 words)
	10 hex	Writes word devices in units of one point.	1 to 64 points
TT	08 hex	Performs a loopback test.	–

5.3 OMRON Protocol

5.3.1 Using the MSG-SNDE Function with the MP3000 as the Master

This section describes how to communicate with an OMRON PLC by using the MSG-SNDE function.

Setting Example

The following figure illustrates how the contents of 100 words from the MW00000 to MW00099 hold registers in the MP3000 master are written to the DM0000 to DM00099 data memory in the CPU Unit of the OMRON PLC slave.

On the MP3000, bits are written and read in word units. It is not possible to write or read less than whole words.

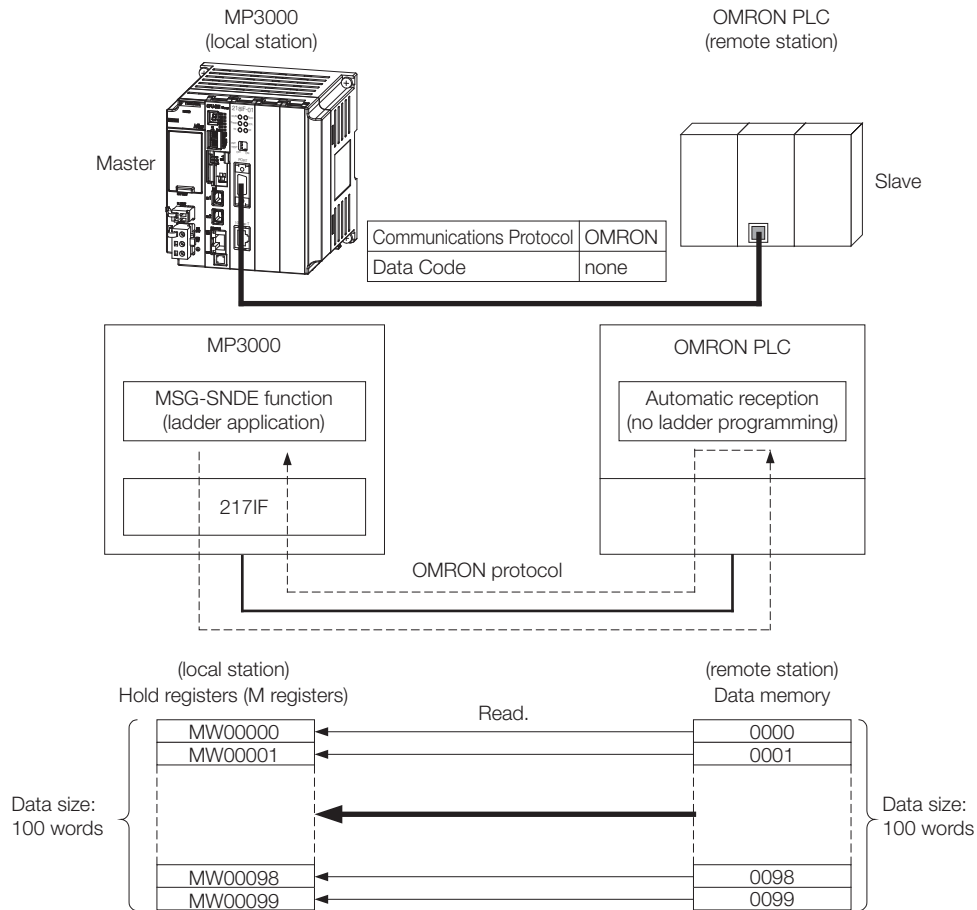

◆ MP3000 Setup

Use the following procedure to set up the MP3000.

Information If the communications parameters (IP address and subnet mask) have already been set, skip to step 3.

1. Double-click the cell for 217IF in the Module Configuration Definition Tab Page.

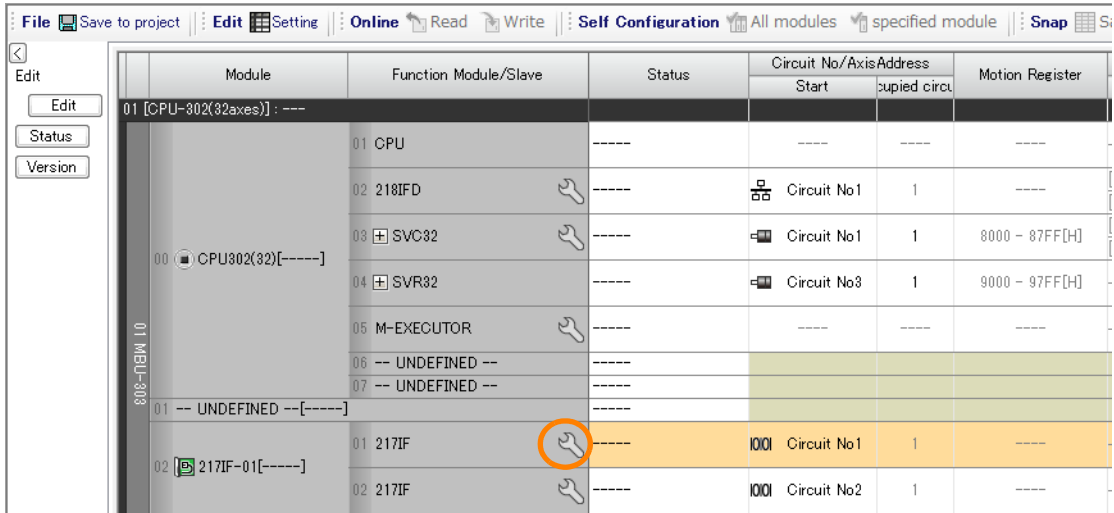

The 217IF Detail Definition Dialog Box will be displayed.

2. Set the detail definition for the 217IF.

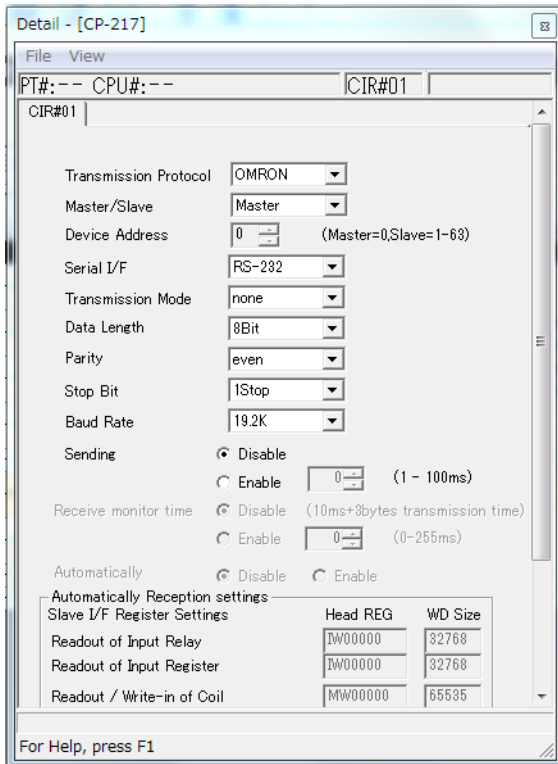

- ① Select [OMRON] in the [Transmission Protocol] Box.
- ② Select [Master] in the [Master/Slave] Box.
- ③ Configure the other settings, from [Device Address] to [Baud Rate], as necessary.

3. Select [Save] from the File Menu.

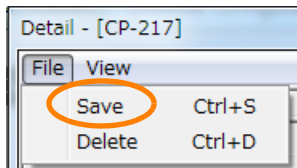

4. Click the [Yes] Button.

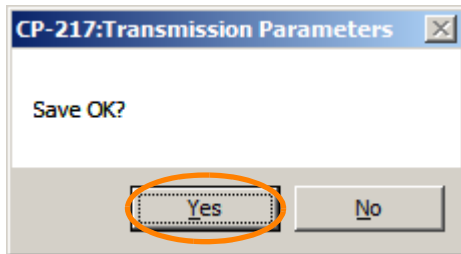

5. Create a ladder program for the MSG-SNDE function.
A ladder program example is shown below.

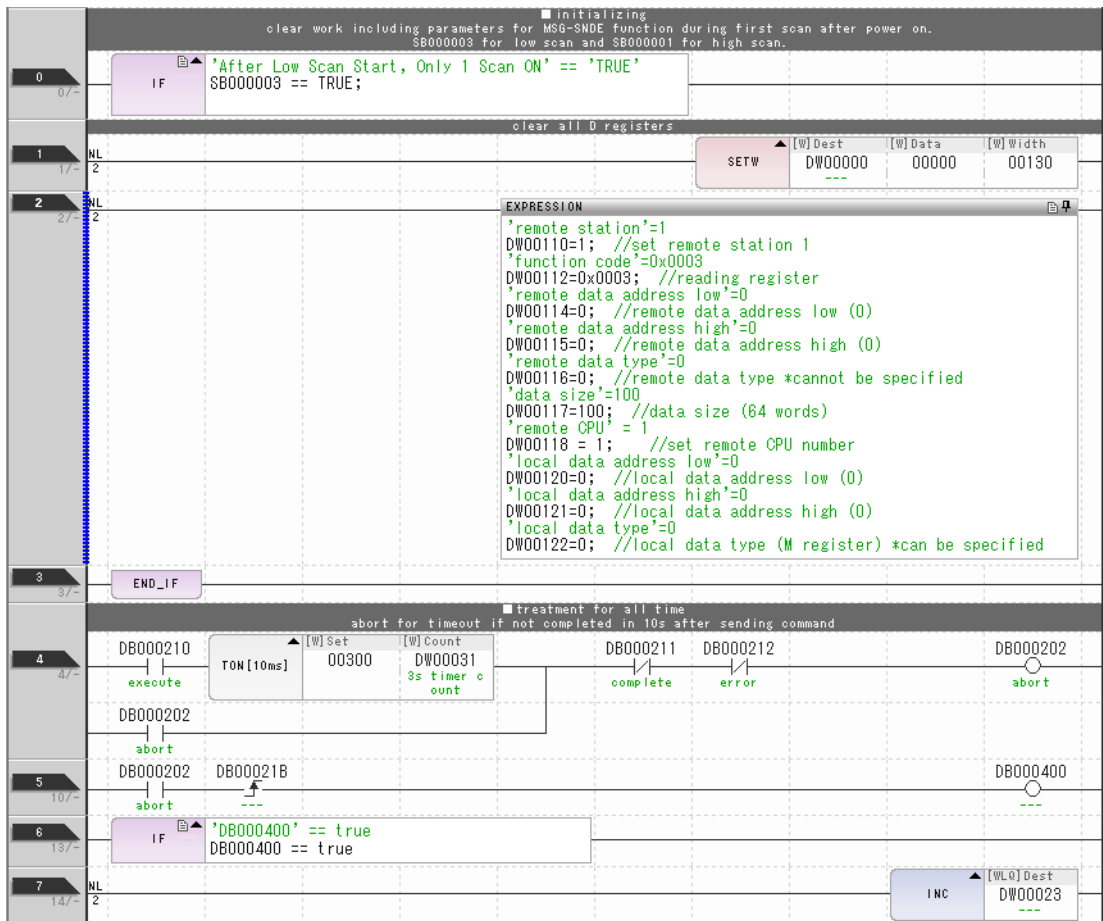

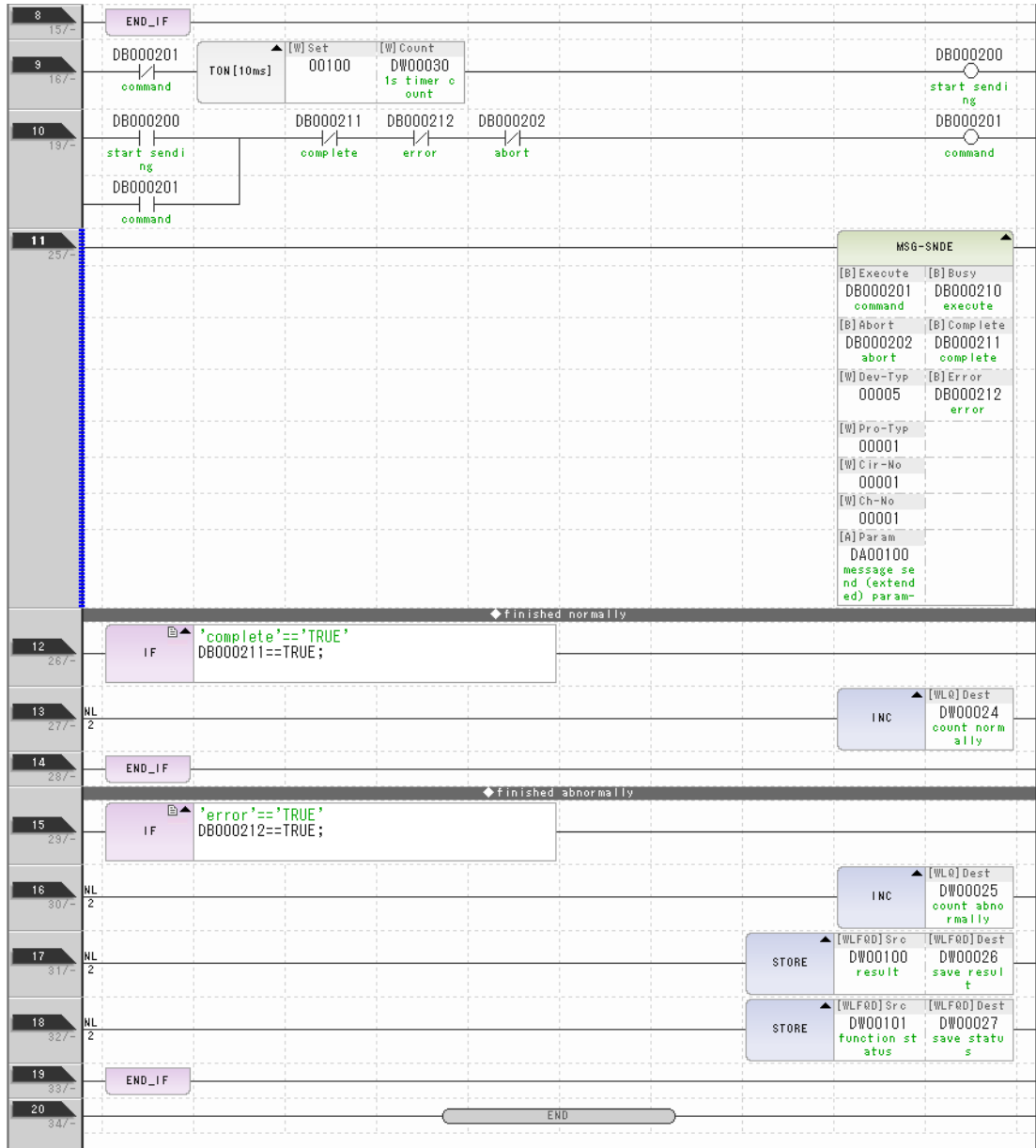

6. Save the data to flash memory.

This concludes the settings for using the MP3000 as the master.

◆ Setting Up the Remote Device (OMRON PLC)

Setting the remote device (OMRON PLC) depends on the model of OMRON PLC. Refer to the OMRON manual for details.

Item	Setting Value (Recommended Value)
Baud Rate	Set to the value on the Communications Module.
Start Bit	1 bit
Data Length	7 or 8 bits (Use same value as 217IF.)
Stop Bit	1 or 2 bits (Use same value as 217IF.)
Parity Bit	Even, odd, or none (Use same value as 217IF.)
Communications Mode	Host link
RS/CS flow control setting	No flow control
Unit No.	Set to a value other than 0.*

* The default value for the unit number is 0. However, change the unit number on the OMRON PLC to a value other than 0 because the device address of an MP3000-series Machine Controller is 0 when it acts as the master.

◆ Starting Communications

Use the following procedure to write the data in the hold registers in the MP3000 to the I/O bits in the CPU Unit of the OMRON PLC.

1. Start the message receive operation on the OMRON PLC.

The system will automatically start the message reception operation. No further operation is required.

2. Turn ON the power to the MP3000 to start transmitting messages.

The ladder program example is designed to turn ON the Execute Bit (DB000200) in the message send function after six seconds has elapsed from when the low-speed scan (or high-speed scan) starts. Thereafter, the message send function is executed every second by alternating the Execute Bit (DB000200) between OFF and ON each time the message send function completes execution normally or with an error.

Note: The MP3000 will establish the TCP connection when it starts execution of the MSG-SNDE function.

SB00003A: Turns ON 5 seconds after start.

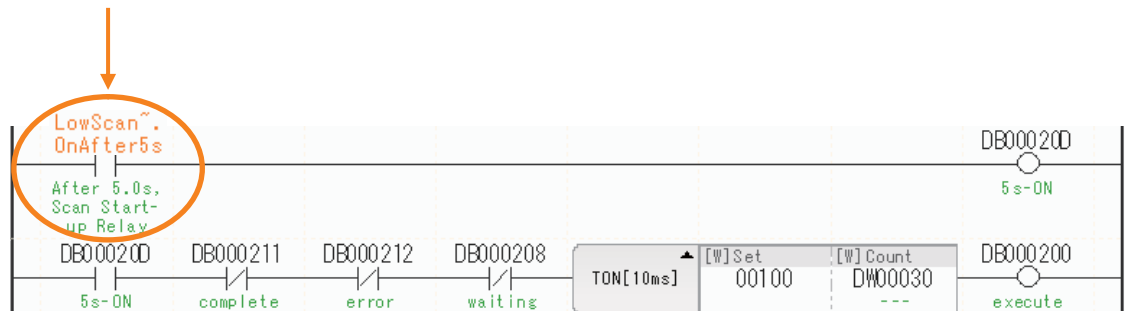

5.3.2 Message Functions

Inputs and Outputs for the MSG-SNDE Function

I/O Definitions	No.	Name	I/O Designation	Meaning	Description
Input Items	1	Execute	B-VAL	Executes the transmission.	Specify the bit to use to execute the message transmission. When the Execute Bit turns ON, the message will be sent. Keep the Execute Bit ON until the Complete or Error Bit turns ON. To send another message, turn OFF the Execute Bit for at least one scan and then turn it ON again.
	2	Abort	B-VAL	Forces the transmission to end.	Specify the bit to use to abort the message transmission. When the Abort Bit turns ON, the message transmission will be stopped unconditionally. The Abort Bit takes precedence over the Execute Bit.
	3	Dev-Typ	I-REG	Communications device type	Specify the type code of the communications device. 217IF = 5
	4	Pro-Typ	I-REG	Communications protocol	Specify the type code of the communications protocol. 1: MEMOBUS Select this protocol when using the OMRON protocol. MEMOBUS is automatically converted to the OMRON protocol inside the 217IF. 2: No-protocol communications 1 (unit: words) Not used for the OMRON protocol. 3: No-protocol communications 2 (unit: bytes) Not used for the OMRON protocol.
	5	Cir-No	I-REG	Circuit number	Specify the circuit number for the communications device. Specify the same circuit number as displayed in the MPE720 Module Configuration Definition Tab Page. 217IF = 1 to 16
	6	Ch-No	I-REG	Communications buffer channel number	Specify the channel number of the communications buffer. You can specify any channel number provided it is within the valid range. When executing more than one function at the same time, do not use the same channel number for the same station. You can use the same channel number as long as multiple functions are not executed at the same time. 217IF = 1
	7	Param	Address Inputs	Parameter list first address (MA, DA)	Specify the first address of the parameter list. A total of 29 words starting from the specified first word are automatically used for the parameter list. The parameter list is used by inputting function codes and relevant parameter data. It is also where the process results and status are output.



Continued on next page.

Continued from previous page.

I/O Definitions	No.	Name	I/O Designation	Meaning	Description
Output Items	1	Busy	B-VAL	Processing.	Specify the bit that shows that the message transmission is in progress. The Busy Bit is ON while a message transmission or abort is in progress. Keep the Execute Bit or Abort Bit turned ON while the Busy Bit is ON.
	2	Complete	B-VAL	Process completed.	Specify the bit that shows when the message transmission has been completed. The Complete Bit turns ON only for one scan when message transmission or forced abort processing has been completed normally.
	3	Error	B-VAL	Error occurred.	Specify the bit that shows if an error occurred when sending the message. When an error occurs, the Error Bit will turn ON only for one scan. Refer to the following section for an example of a timing chart for when an error occurs.  ◆ Error on page 2-8











MSG-SNDE Function Parameters

The following table describes the contents of the addresses specified by the PARAM input parameter to the MSG-SNDE function.

No.	I/O	Meaning	Description	Reference Page
00	Out-puts	Processing Result	Gives the processing status.	 ◆ Processing Result (PARAM00) on page 2-9
01		Status	Gives the status of the current function.	 ◆ Status (PARAM01) on page 2-10
02		Detail Error Code, Lower Word	Gives the details of an error.	 ◆ Detail Error Code (PARAM02 and PARAM03) on page 2-11
03		Detail Error Code, Upper Word		
04		Status 1	Not used for the 217IF.	–
05		Status 2	Not used for the 217IF.	–
06		Status 3	Not used for the 217IF.	–
07		Status 4	Not used for the 217IF.	–
08		Status 5	Not used for the 217IF.	–
09	Status 6	Not used for the 217IF.	–	

Continued on next page.

Continued from previous page.

No.	I/O	Meaning	Description	Reference Page
10	Inputs	Station Number	Sets the remote station number.	 ◆ Station Number (PARAM10) on page 5-49
11		Option	Not used for the OMRON protocol.	–
12		Function Code	Sets the code of the function in the OMRON protocol.	 ◆ Function Code (PARAM12) on page 5-49
13		Reserved for system.	This parameter is used by the system. Do not change the value of this parameter from a user program or by any other means.	 ◆ Reserved for System (PARAM13) on page 2-14
14		Remote Station Data Address, Lower Word	Sets the data address to read/write at the remote station. (Use word addresses for registers, bit addresses for relays or coils.)	 ◆ Data Addresses (PARAM14 and PARAM15) on page 5-49
15		Remote Station Data Address, Upper Word		
16		Remote Station Register Type	Not used for the OMRON protocol.	–
17		Data Size	Sets the size of the data to read/write. (Use word sizes for registers, bit sizes for relays or coils.)	 ◆ Data Size (PARAM17) on page 5-50
18		Remote CPU Module Number	Not used for the OMRON protocol.	–
19		Reserved for system.	This parameter is used by the system. Do not change the value of this parameter from a user program or by any other means.	 ◆ Reserved for System (PARAM19) on page 2-17
20		Local Station Data Address, Lower Word	Sets the data address to store read/write data in the local station. (Use word addresses for registers, bit addresses for relays or coils.)	 ◆ Data Addresses (PARAM14 and PARAM15) on page 5-49
21		Local Station Data Address, Upper Word		
22		Local Station Register Type	Sets the register type of the read/write data to store in the local station.	 ◆ Local Station Register Type (PARAM22) on page 2-19
23	Reserved for system.	This parameter is used by the system. Do not change the value of this parameter from a user program or by any other means.	 ◆ Reserved for System (PARAM23) on page 2-19	
24	–	For system use	This parameter contains the channel number of the communications buffer that is currently in use. A user program must set this parameter to 0 on the first scan after startup. Thereafter, do not change the value of this parameter from a user program or by any other means because it will be used by the system.	 ◆ Reserved for System (PARAM24) on page 2-19
25	–	Reserved for system.	These parameters are used by the system. Do not change the value of these parameters from a user program or by any other means.	 ◆ Reserved for System (PARAM25 to PARAM28) on page 2-19
26	–	Reserved for system.		
27	–	Reserved for system.		
28	–	Reserved for system.		

◆ Station Number (PARAM10)

Specify the station number.

The valid setting range is given in the following table.

Communications Device	Station Number	Remarks
Serial (217IF)	0	Sends the message to all stations (broadcast).
	1 to 254	Sends the message to the remote station set by the specified station number.

Note: For a broadcast, the message is sent without waiting for response data. For this reason, a broadcast can use only write commands.

◆ Function Code (PARAM12)

Set the function code to send.

You can use the functions (e.g., read bit and word devices and write to word devices) that are registered to the function codes by specifying that code.

The following table lists the function code when using OMRON as the protocol type.

OMRONC Header Code	Function Code	Target Data Type	Function
RR	01 hex	B	Reads CIO Area bits, Work Area bits, and Auxiliary Area bits.
RD	03 hex	W	Reads DM Area.
WR	0F hex	B	Writes CIO Area bits, Work Area bits, and Auxiliary Area bits.
WD	10 hex	W	Writes DM Area.
TS	08 hex	–	Performs a test.

◆ Data Addresses (PARAM14 and PARAM15)

Set the first address of the data.

Enter the first address as a decimal or hexadecimal number.

Example: If the first address is MW01000, enter 1000 (decimal) or 3E8 (hexadecimal).

The following table lists the setting ranges of data addresses when using OMRON as the protocol type.

Device	Channel Number	Relay Number	Function Code	Data address Setting Range	Corresponding Register Addresses
CIO Area	000 to 039	00000 to 03915	01 or 0F hex: Coil	0 to 639	MB000000 to MB00039F
Work Area	040 to 246	04000 to 24615	01 or 0F hex: Coil	640 to 3951	MB000400 to MB00246F
Auxiliary Area	247 to 255	24700 to 25507	01 or 0F hex: Coil	3952 to 4088	MB002470 to MB002557
DM Area	0000 to 9999	DM0000 to 9999	03 or 10 hex: Hold register	0000 to 9999	MW000000 to MW099999

◆ Data Size (PARAM17)

Set the data size for the read/write request as the number of bits or words.

Be sure that the last data address that is determined by the offset, data address, and data size does not exceed the valid data address range.

The range that is allowed for the data size depends on the function code and communications device.

The following table lists the setting ranges of data sizes when using OMRON as the protocol type.

OMRONC Header Code	Function Code	Function	Data Size Setting Range
RR	01 hex	Reads CIO Area bits, Work Area bits, and Auxiliary Area bits.	1 to 2000 bits (125 words)*
RD	03 hex	Reads DM Area.	1 to 125 words
WR	0F hex	Writes CIO Area bits, Work Area bits, and Auxiliary Area bits.	1 to 800 bits (50 words)*
WD	10 hex	Writes DM Area.	1 to 100 words
TS	08 hex	Performs a test.	–

* The data size is set in units of 16 bits.

Note: The setting range of the data size is the upper limit on the number of words that can be accessed with one instruction due to MEMOBUS protocol limitations.

5.4 No-Protocol Communications

5.4.1 Using the MSG-SNDE and MSG-RCVE Functions with the MP3000 as the Master

System Configuration Example

In this example, an SR Mini Temperature Controller manufactured by RKC Instrument Inc. is connected to the RS-232C port of a Communications Module or the RS-422/485 port of a 2171F-01 Module to read the temperature data. The MSG-SNDE function is used to send instructions and the MSG-RCVE function is used to receive responses.

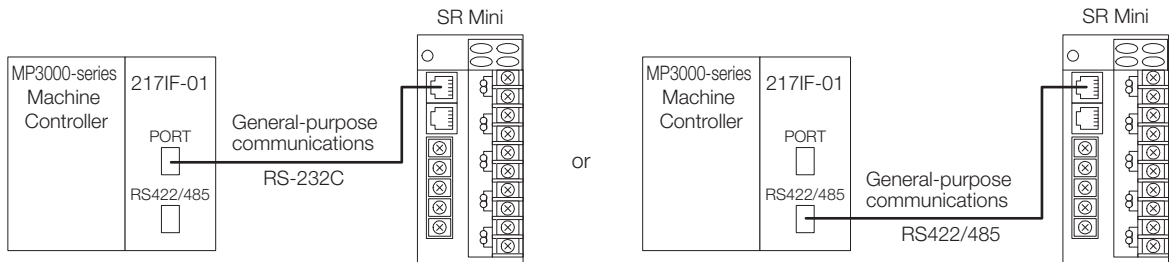

Cable Specifications

◆ RS-232C (PORT) Cable

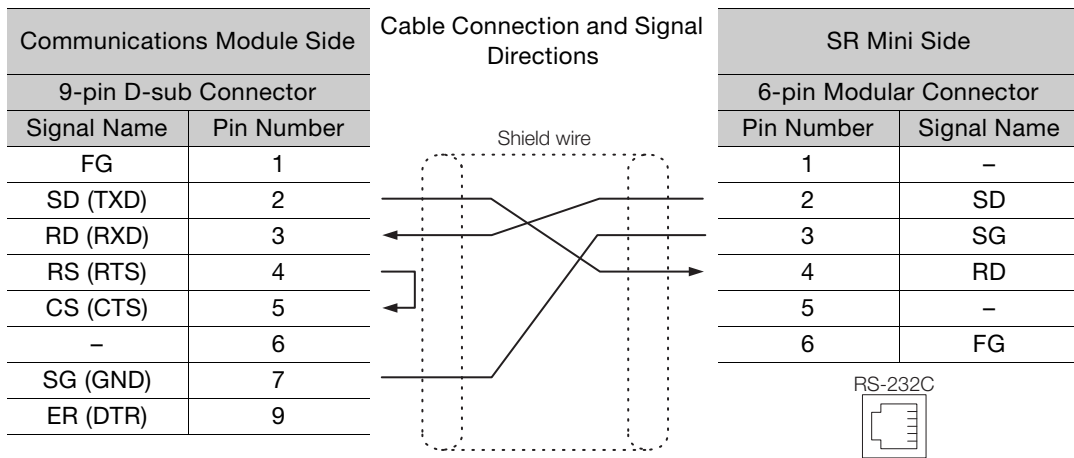

Note: The SR Mini is available with the following three interfaces. Specify the interface when ordering the SR Mini.
 RS-232C
 RS422
 RS485

◆ RS-422 Cable

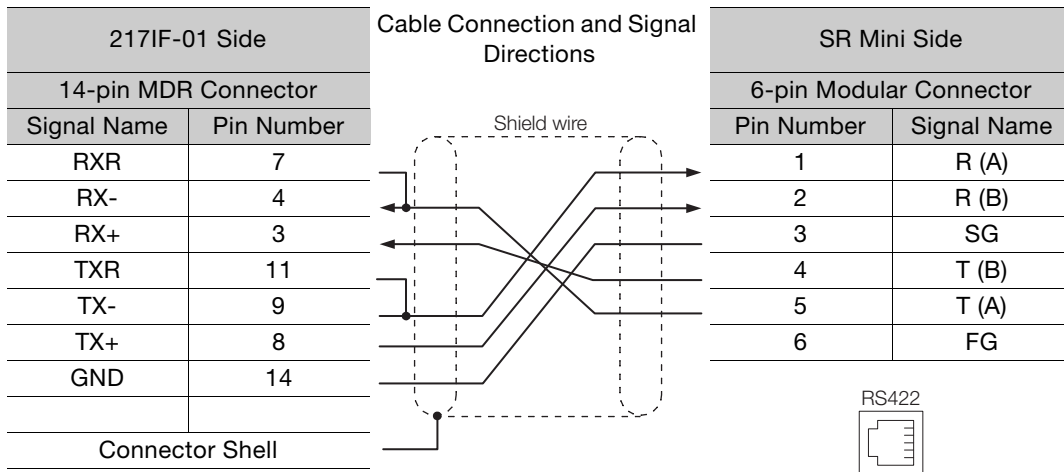

Note: Wire to enable terminating resistance on the 217IF-01.

◆ RS-485 Cable

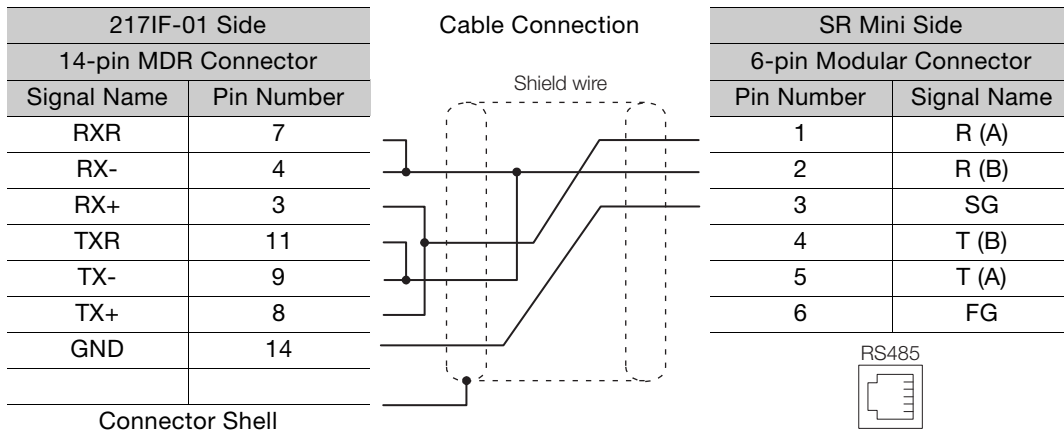

Note: Wire to enable terminating resistance on the 217IF-01.

MP3000 Setup

Use the following procedure to set up the MP3000.

1. Double-click the cell for 217IF in the Module Configuration Definition Tab Page.

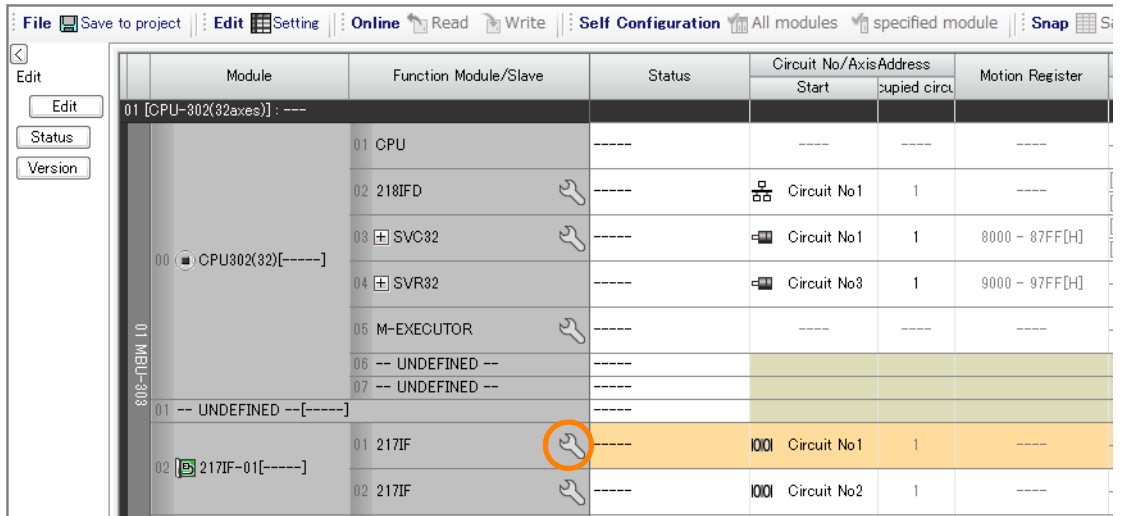

The 217IF Detail Definition Dialog Box will be displayed.

2. Set the detail definition for the 217IF.

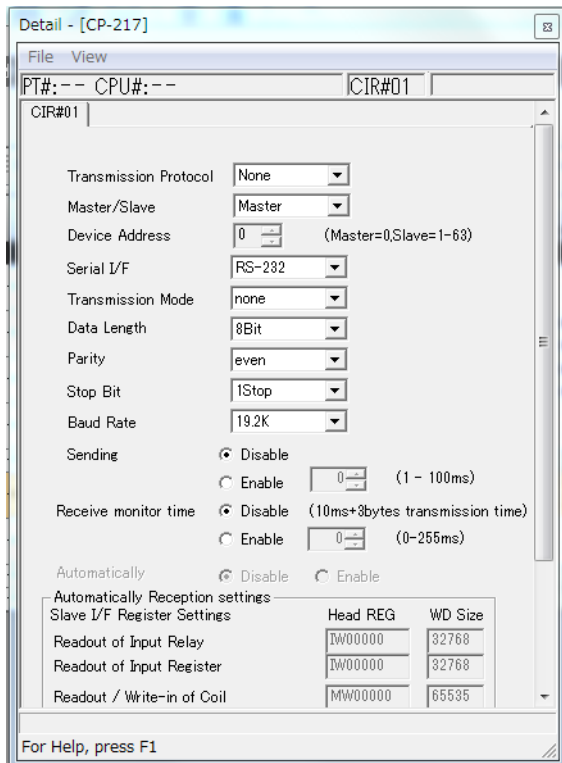

- ① Select [None] in the [Transmission Protocol] Box.
- ② Select [Master] in the [Master/Slave] Box.
- ③ Configure the other settings, from [Device Address] to [Baud Rate], as necessary.

3. Select [Save] from the File Menu.

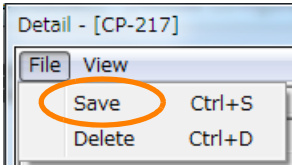

4. Click the [Yes] Button.

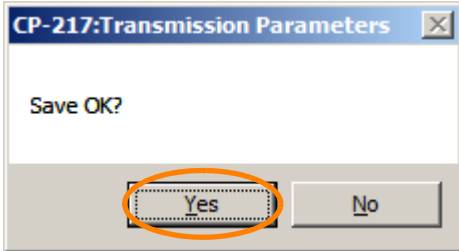

5. Create a ladder program for the MSG-SNDE function.

A ladder program example is shown below.

The ladder program must implement exclusive control to prevent the MSG-SNDE and MSG-RCVE functions from being started simultaneously because there is only one message channel when using no-protocol communications. In the following sample, the MSG-RCVE function is started to receive the response after the instruction is sent with the MSG-SNDE function. After the response is received, the MSG-SNDE function is started again to send the instruction.

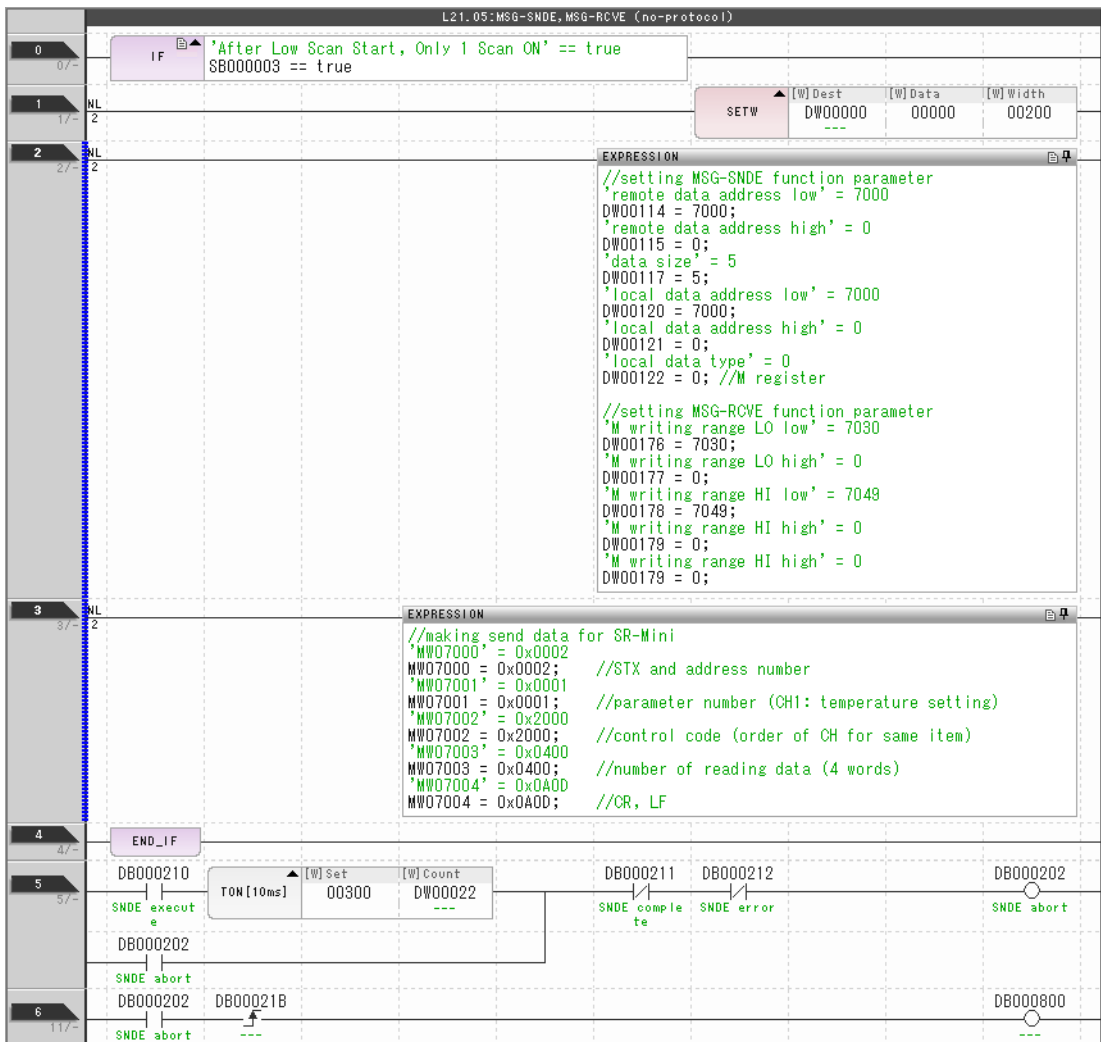

5.4.1 Using the MSG-SNDE and MSG-RCVE Functions with the MP3000 as the Master

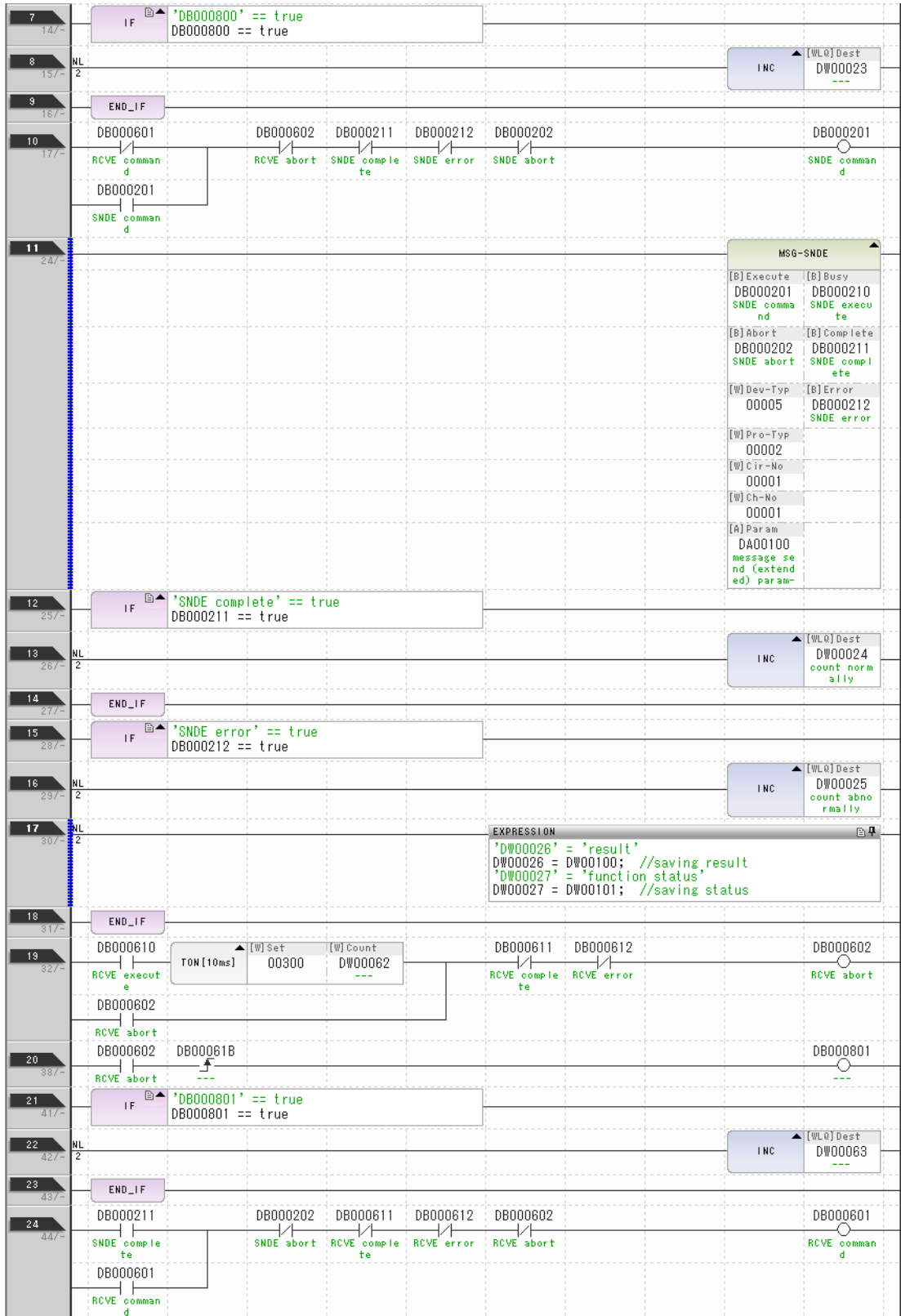

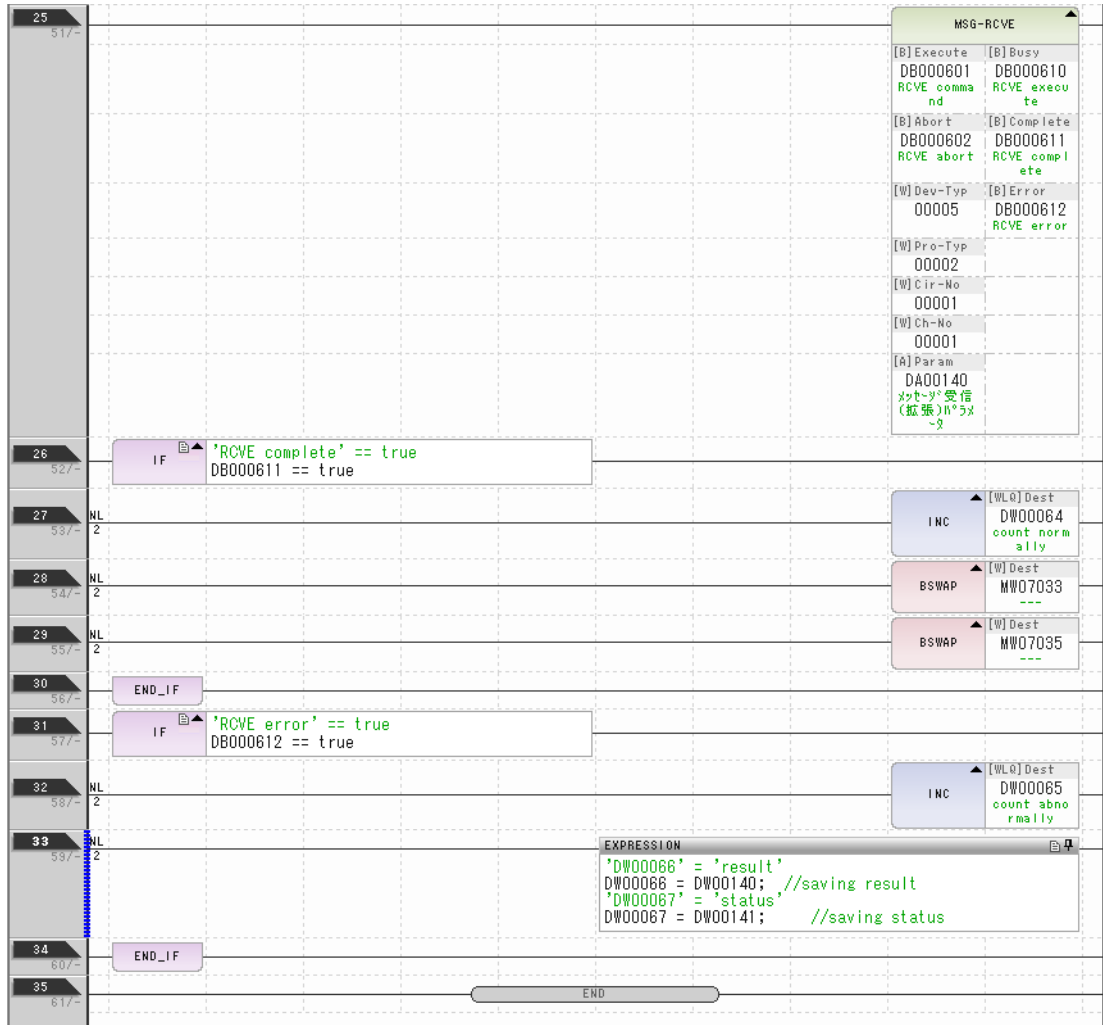

6. Save the data to flash memory.

This concludes the settings for using the MP3000 as the master.

Temperature Controller Setup

Set the switches on the SR Mini Temperature Controller as shown in the following tables.

Bit1	OFF	Always OFF
Bit2	OFF	Always OFF
Bit3	ON	Set according to baud rate.
Bit4	ON	Set according to baud rate.

Bit3	Bit4	Baud Rate
OFF	OFF	2400 bps
OFF	ON	4800 bps
ON	OFF	9600 bps (default setting)
ON	ON	19200 bps

Starting Communications

1. Turn ON the power to the Temperature Controller to start receiving messages.
In the ladder program example, message reception starts immediately after the system starts. No further operation is required.
2. Turn ON the power to the MP3000 to start transmitting messages.

5.5 No-Protocol FD Communications

5.5.1 Using the MSG-SNDE and MSG-RCVE Functions with the MP3000 as the Master

System Configuration Example

In this example, an SR Mini Temperature Controller manufactured by RKC Instrument Inc. is connected to the RS-232C port of a Communications Module or the RS-422/485 port of a 2171F-01 Module to read the temperature data. The MSG-SNDE function is used to send instructions and the MSG-RCVE function is used to receive responses.

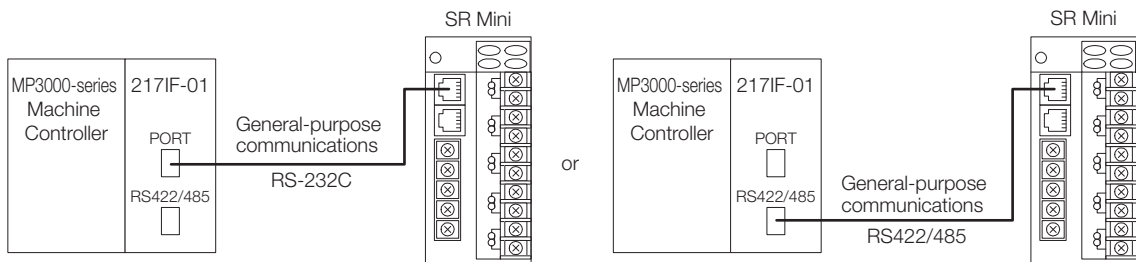

Cable Specifications

For cable specifications, refer to the following sections.

- ☞ **RS-232C (PORT) Cable** on page 5-51
- ☞ **RS-422 Cable** on page 5-52
- ☞ **RS-485 Cable** on page 5-52

MP3000 Setup

Use the following procedure to set up the MP3000.

1. Double-click the cell for 217IF in the Module Configuration Definition Tab Page.

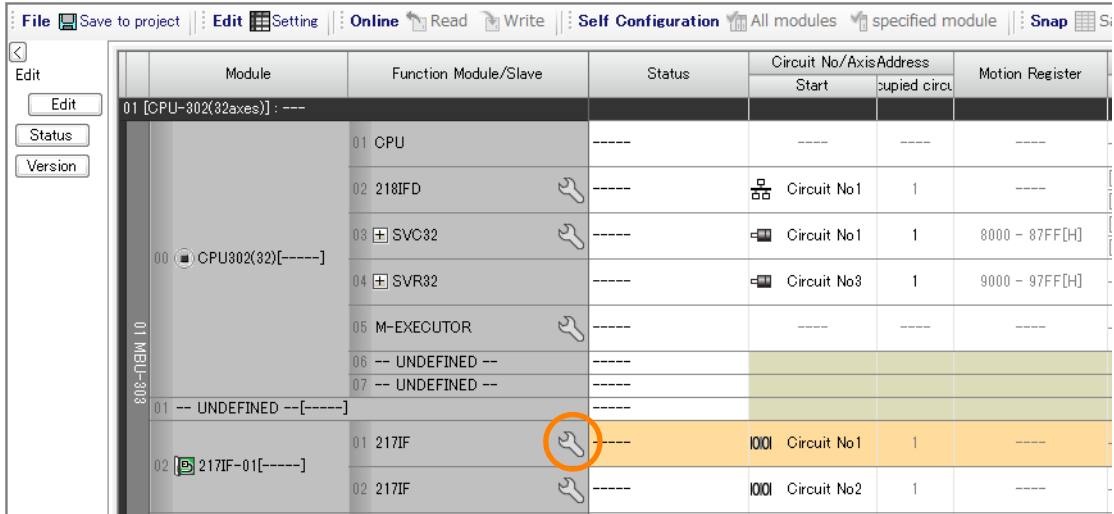

The 217IF Detail Definition Dialog Box will be displayed.

2. Set the detail definition for the 217IF.

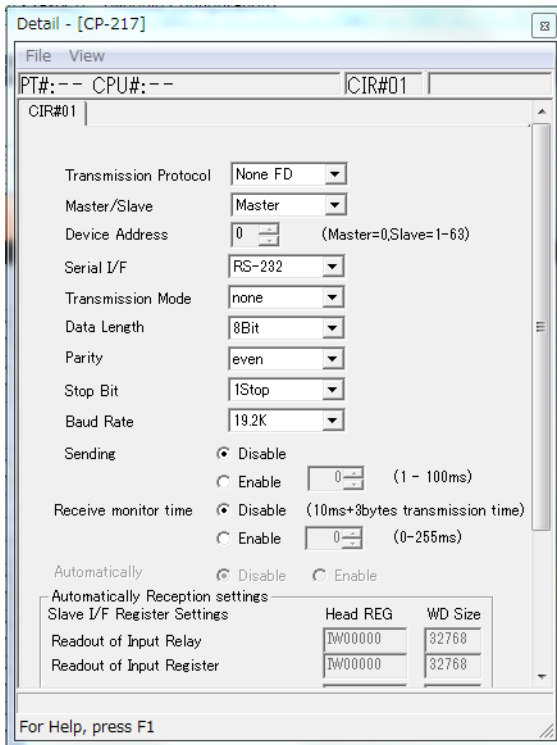

- ① Select [None FD] in the [Transmission Protocol] Box.
- ② Select [Master] in the [Master/Slave] Box.
- ③ Configure the other settings, from [Device Address] to [Baud Rate], as necessary.

3. Select [Save] from the File Menu.

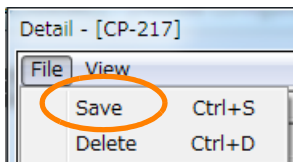

- Click the [Yes] Button.

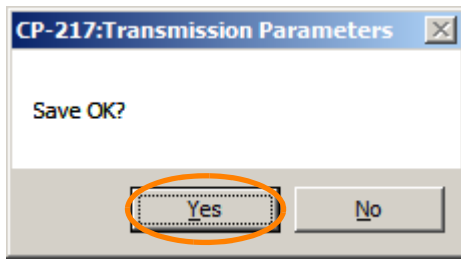

- Create a ladder program for the MSG-SNDE function.

A ladder program example is shown below.

There are two message channels when using no-protocol FD communications. One channel is for sending messages and one channel is for receiving messages. The ladder program can start the MSG-SNDE and MSG-RCVE functions simultaneously. In this sample, the MSG-RCVE is always running to receive responses and the MSG-SNDE function is executed as required to send instructions.

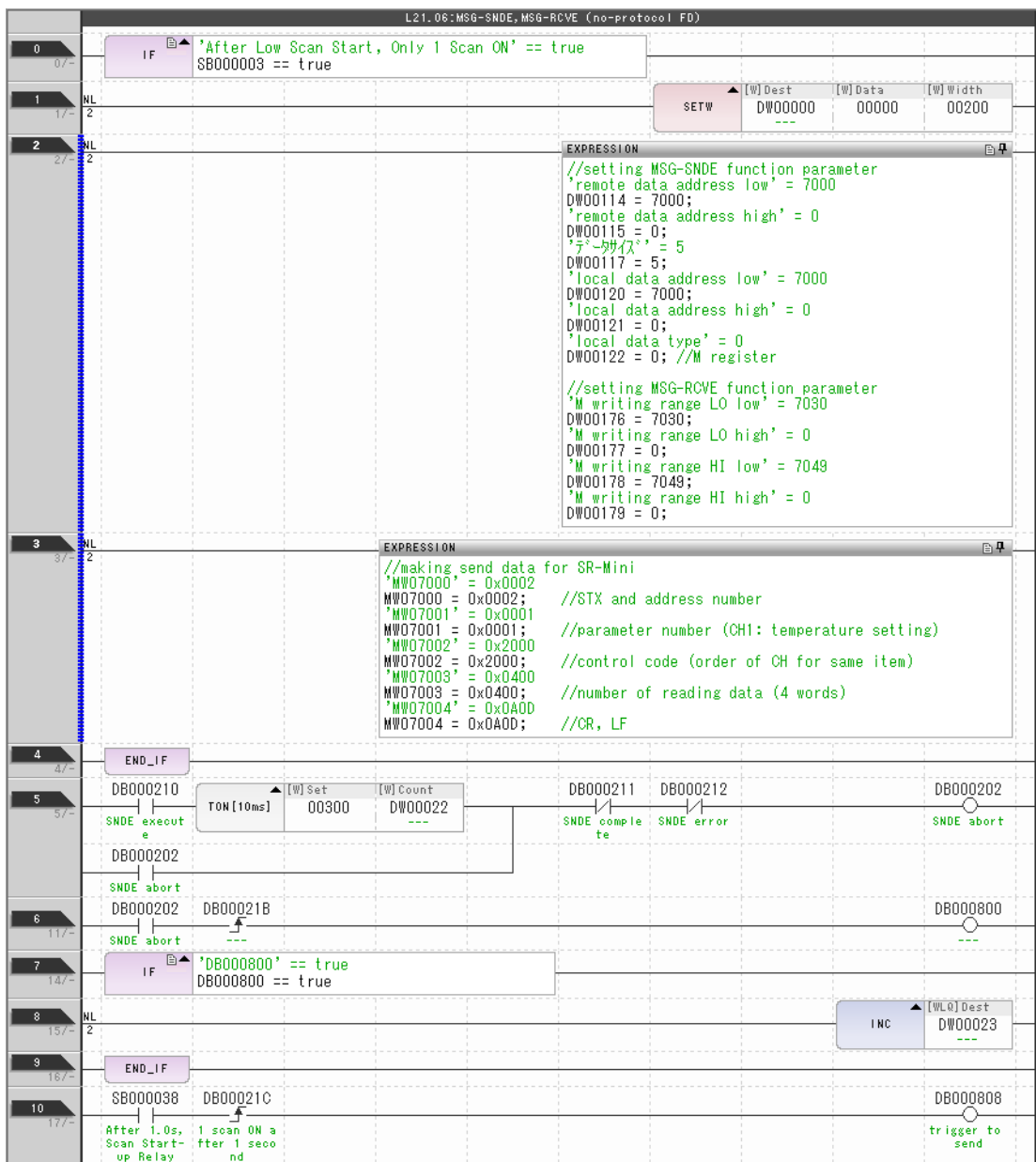

5.5 No-Protocol FD Communications

5.5.1 Using the MSG-SNDE and MSG-RCVE Functions with the MP3000 as the Master

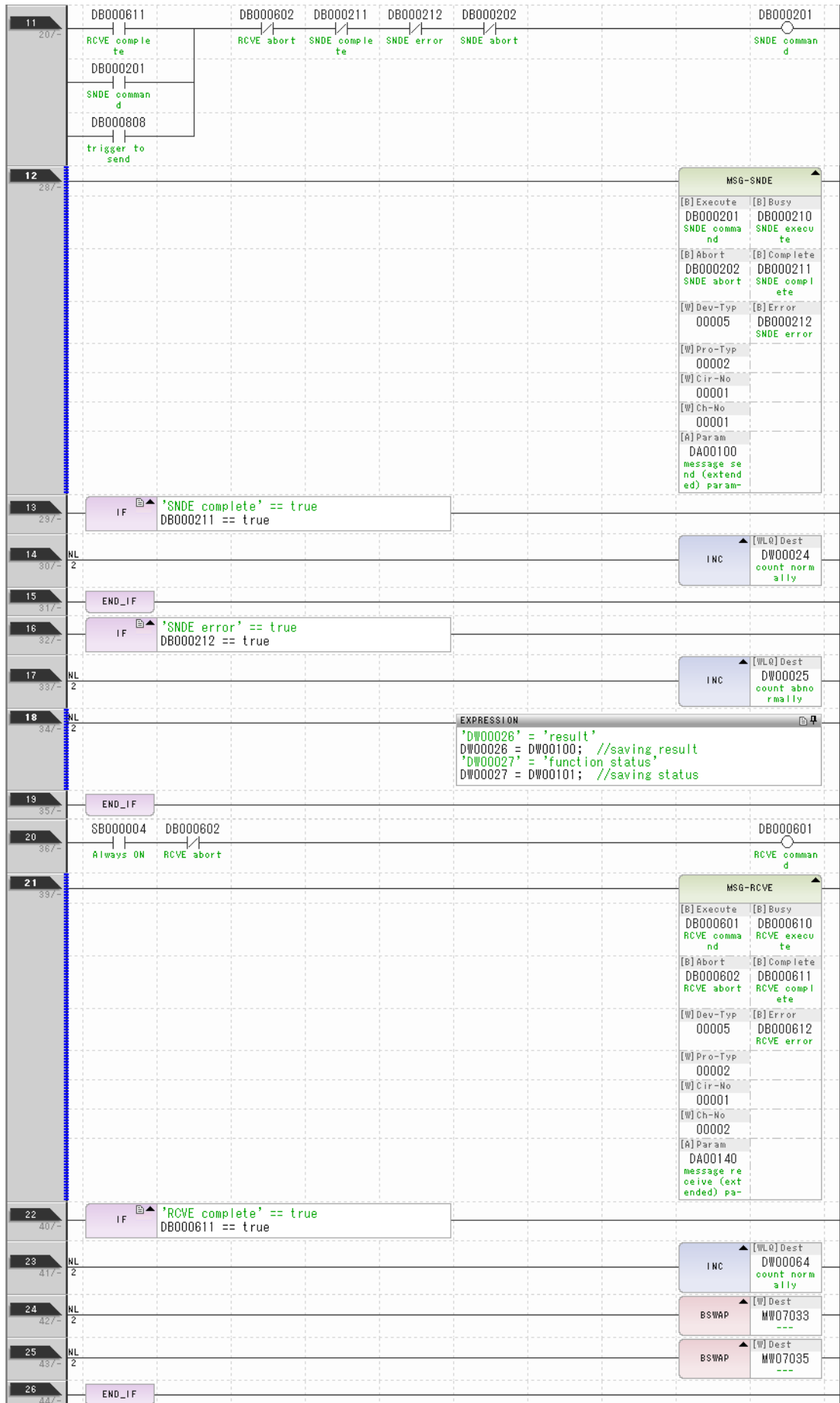

5.5.1 Using the MSG-SNDE and MSG-RCVE Functions with the MP3000 as the Master

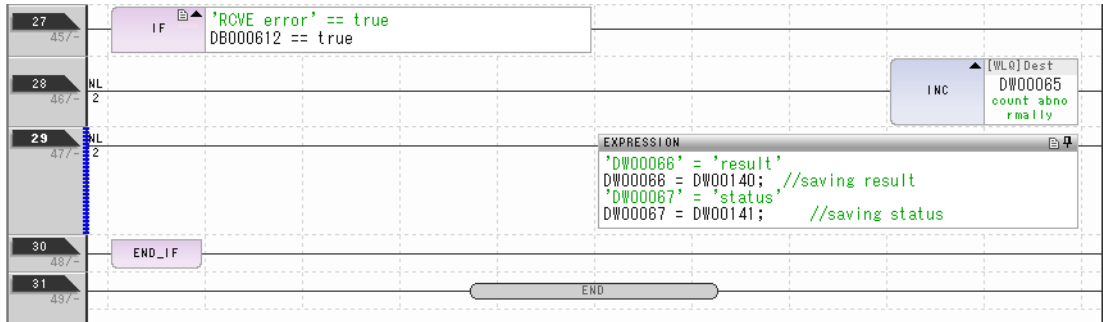

6. Save the data to flash memory.

This concludes the settings for using the MP3000 as the master.

Setting Up the Temperature Controller

Set the switches on the SR Mini Temperature Controller as shown in the following tables.

Bit1	OFF	Always OFF
Bit2	OFF	Always OFF
Bit3	ON	Set according to baud rate.
Bit4	ON	Set according to baud rate.

Bit3	Bit4	Baud Rate
OFF	OFF	2400 bps
OFF	ON	4800 bps
ON	OFF	9600 bps (default setting)
ON	ON	19200 bps

Starting Communications

- Turn ON the power to the Temperature Controller to start receiving messages. In the ladder program example, message reception starts immediately after the system starts. No further operation is required.
- Turn ON the Execute Bit (e.g., DB000200) for the MSG-SNDE function in the MP3000 to start sending messages. The ladder program example is designed to send a message every second after five seconds have elapsed from when the low-speed scan (or high-speed scan) starts. To change the message transmission interval, change the timer value ①.

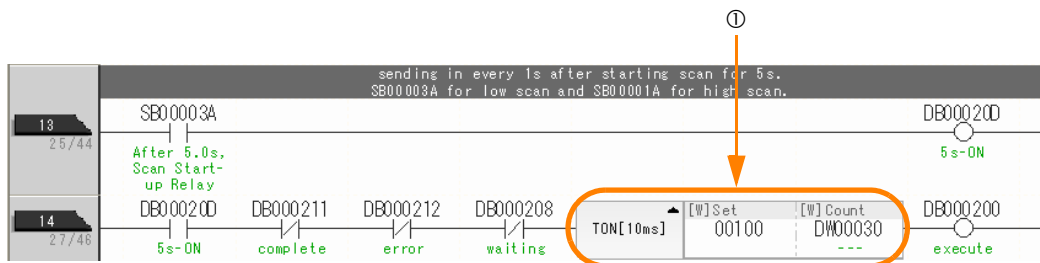

Appendix

6

6.1	Communications Specifications	6-2
6.1.1	Ethernet Communications Specifications	6-2
6.1.2	Serial Communications Specifications	6-4
6.2	Communications Buffer Channels	6-5
6.3	Using Message Functions	6-7
6.3.1	Function Codes	6-7
6.3.2	Using Function Codes	6-8
6.4	Details on Protocols	6-25
6.4.1	Extended MEMOBUS protocol	6-25
6.4.2	MEMOBUS Protocol	6-48
6.4.3	No-Protocol Communications	6-55

6.1 Communications Specifications

The following table lists the specifications of Ethernet communications and serial communications.

6.1.1 Ethernet Communications Specifications

Item		Specification		
Module	CPU201, CPU202	CPU-301 (16 axes)/ CPU-301 (32 axes), CPU-302 (16 axes)/ CPU-302 (32 axes)	218IF-01	218IF-02
Function Name	218IFD		218IF	218IFB
Communications Interface	10Base-T/100Base-TX		10Base-T	10Base-T/100Base-TX
Number of Communications Ports (Connectors)	2	1	1	1
Communications Protocols	TCP/UDP/IP/ARP/ICMP		TCP/UDP/IP/ARP/ICMP	TCP/UDP/IP/ARP/ICMP
Maximum Number of Communications Connections	20 + 2 (I/O message communications) (Simultaneous communications supports up to 12 connections including I/O message communications.)		20 (Simultaneous communications supports up to 10 connections.)	20 (Simultaneous communications supports up to 10 connections.)
Maximum Number of Communications Channels	10 + 2 (I/O message communications)		10	10
Automatic Reception	Supported.		Not supported.	Not supported.
Number of Automatic Reception Connections	10		–	–
Maximum Size of Message Communications	MEMOBUS	Write: 100 words Read: 125 words	Write: 100 words Read: 125 words	Write: 100 words Read: 125 words
	Extended MEMOBUS	Write: 2043 words Read: 2044 words	Write: 507 words Read: 508 words	Write: 2043 words Read: 2044 words
	MELSEC (A-compatible 1E)	Write: 256 words Read: 256 words Read/write when using random-access communications: 1017 words	Write: 256 words Read: 256 words Write when using random-access communications: 507 words Read: 508 words	Write: 256 words Read: 256 words Read/write when using random-access communications: 1017 words
	MELSEC (QnA-compatible 3E)	Write: 960 words Read: 960 words	–	Write: 960 words Read: 960 words
	MODBUS/TCP	Write: 100 words Read: 125 words	Write: 100 words Read: 125 words	Write: 100 words Read: 125 words
	OMRON	Write: 996 words Read: 999 words	–	Write: 996 words Read: 999 words
	TOYOPUC	Write: 1022 words	–	Write: 1022 words
	No-protocol	Write: 2046 words	Write: 510 words	Write: 2046 words

Continued on next page.

Continued from previous page.

Item		Specification		
Maximum Size of I/O Message Communications	MEMOBUS	Write: 100 words Read: 125 words	–	–
	Extended MEMOBUS	Write: 1024 words Read: 1024 words	–	–
	MELSEC (A-compatible 1E)	Write: 256 words Read: 256 words	–	–
	MELSEC (QnA-compatible 3E)	Write: 256 words Read: 256 words	–	–
	MODBUS/TCP	Write: 100 words Read: 125 words	–	–
	OMRON	Write: 996 words Read: 999 words	–	–
	Execution Conditions	After the power is turned ON, cyclic communications, or start/stop control from ladder programs.	–	–
	Execution Status Monitoring	Supported.	–	–
Receive Buffer Mode Selection for No-protocol Communications	Supported.	–	Supported.	
Communications Platform	Ethernet	Ethernet	Ethernet	
Controller Searches with Engineering Tool	Supported.	–	Supported.	

6.1.2 Serial Communications Specifications

Item	Specification					
	218IF-02	217IF-01	218IF-01	260IF-01	261IF-01	215AIF-01
Module	218IF-02	217IF-01	218IF-01	260IF-01	261IF-01	215AIF-01
Function Name	217IF	217IF	217IF			
Communications Interface	RS-232C	RS-232C, RS422, RS485	RS-232C			
Communications Ports	1 (RS-232C)	1 (RS-232C) 1 (RS422/RS485)	1 (RS-232C)			
Communications Speed (Kbps)	9.6, 19.2, 38.4, 57.6, 76.8, 115.2	9.6, 14.4, 19.2, 28.8, 38.4, 48.0, 57.6, 76.8	9.6, 19.2			
Connection Type	1: 1	1: 1 (RS232, RS422) 1: N (RS485) N = up to 31	1: 1			
Maximum Number of Communications Channels	1	1 (When using no-protocol FD: 2)	1			
MEMOBUS	Write: 100 words Read: 125 words	Write: 100 words Read: 125 words	Write: 100 words Read: 125 words			
A-compatible 1E	Write: 64 words Read: 64 words	Write: 64 words Read: 64 words	Write: 64 words Read: 64 words			
OMRON	Write: 100 words Read: 125 words	Write: 100 words Read: 125 words	Write: 100 words Read: 125 words			
No-protocol	Write: 254 words	Write: 254 words	Write: 254 words			
No-protocol FD	–	Write: 254 words		–		
Automatic Reception	Supported.	Supported.	Supported.			
Number of Automatic Reception Connections	1	2	1			
I/O Message Communications	–	–		–		
Multiple Buffers during No-Protocol Communications	Not supported.	Supported. (only when using no-protocol FD)	Not supported.			
Communications Platform	Serial	Serial	Serial			
Engineering Tool Function	Supported.	Supported.	Supported.			
Controller Searches	Not supported.	Not supported.	Not supported.			

6.2 Communications Buffer Channels

A communications buffer channel is a data buffer that interfaces the MSG-SNDE or MSG-RCVE function with the communications device. This data buffer consists of one or more channels. Each channel is identified by a communications buffer channel number.

The communications buffer channel is associated with the connection based on the setting of the Ch-No (Communications Buffer Channel Number) input parameter in the MSG-SNDE and MSG-RCVE functions, and PARAM10 (Connection Number) in the parameter list (Param).

A connection refers to communications settings between the local station and a remote station. These settings are set in the Transmission Parameters Tab Page of the MPE720 Module Configuration Definition Dialog Box.

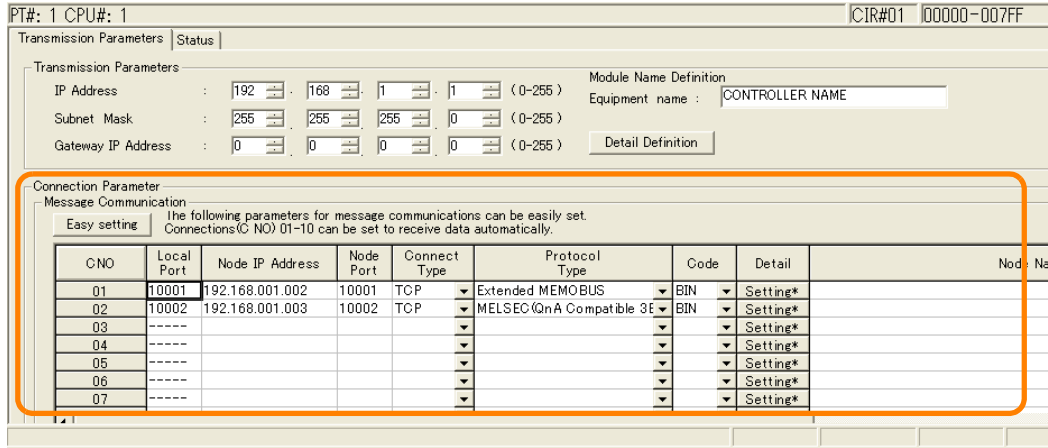

The following figure illustrates the concept of the communications buffer channels.

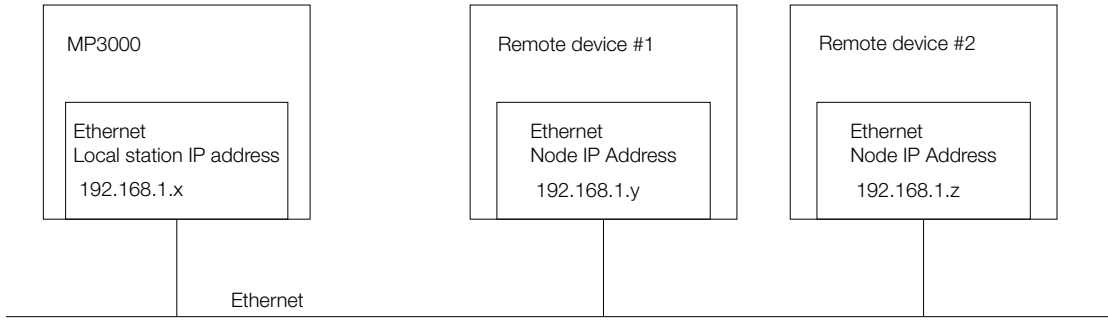

Network Configuration

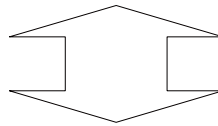

The connection is set in the Transmission Parameters Tab Page of the MPE720 Module Configuration Definition Dialog Box.

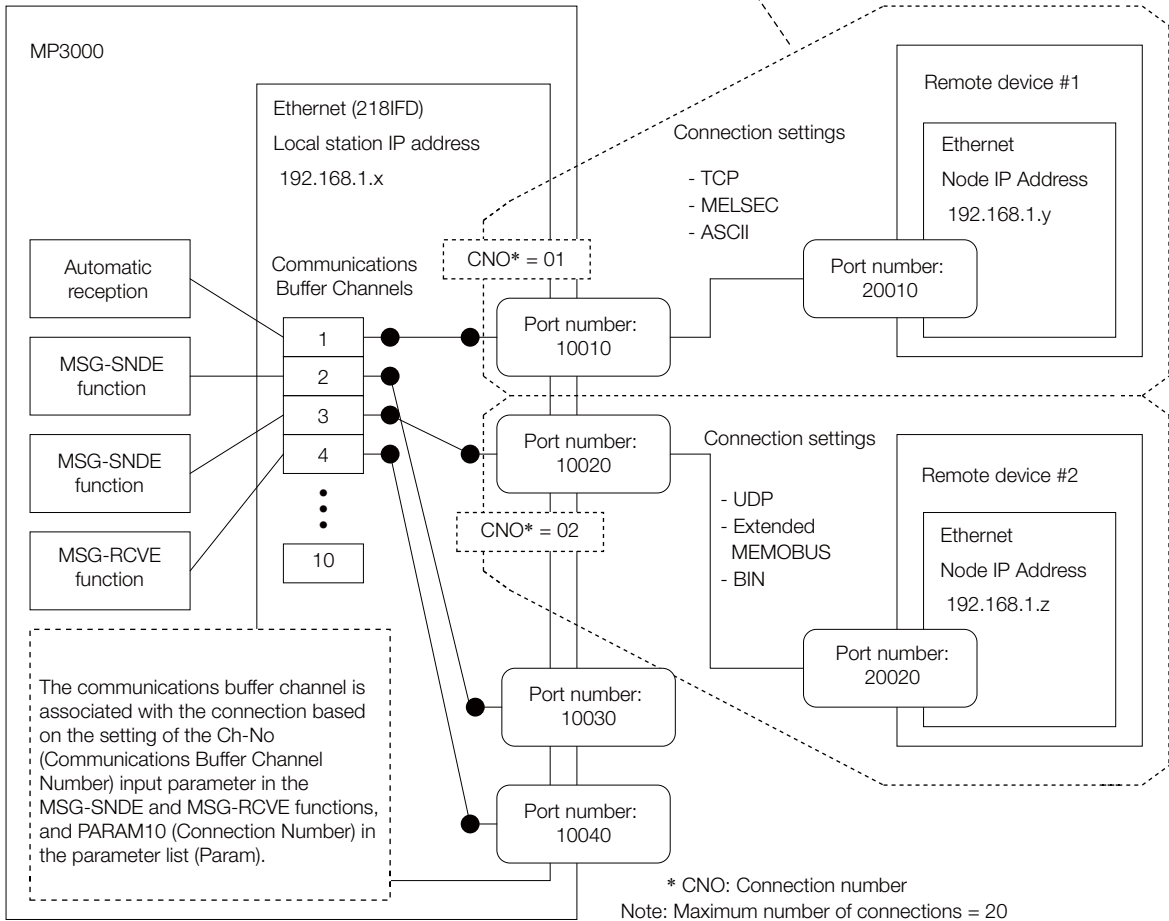

6.3

Using Message Functions

You can use any registered function by specifying the corresponding function code in the message function.

This section describes the function codes and how to use them.

6.3.1 Function Codes

The following tables list the function codes for each protocol.

Function Codes for the Extended MEMOBUS Protocol

Function Code	Function
00 hex	Not used.
01 hex	Reads the states of coils.
02 hex	Reads the states of input relays.
03 hex	Reads the contents of hold registers.
04 hex	Reads the contents of input registers.
05 hex	Changes the state of a single coil.
06 hex	Writes to a single hold register.
07 hex	Not used.
08 hex	Performs a loopback test.
09 hex	Reads the contents of hold registers (extended).
0A hex	Reads the contents of input registers (extended).
0B hex	Writes to hold registers (extended).
0C hex	Not used.
0D hex	Reads the contents of non-consecutive hold registers (extended).
0E hex	Writes the contents of non-consecutive hold registers (extended).
0F hex	Changes the states of multiple coils.
10 hex	Writes to multiple hold registers.
4341 hex	Reads the states of bits.
4345 hex	Changes the state of a single bit.
4346 hex	Writes to a single register.
4349 hex	Reads the contents of registers.
434B hex	Writes to multiple registers.
434D hex	Reads the contents of non-consecutive registers.
434E hex	Writes the contents of non-consecutive registers.
434F hex	Changes the states of multiple bits.

Function Codes for the A-compatible 1E Frame Protocol

Function Code	Function
01 or 02 hex	Reads bit devices in units of one point.
03, 04, 09, or 0A hex	Reads word devices in units of one point.
05 or 0F hex	Writes bit devices in units of one point.
06, 0B, or 10 hex	Writes word devices in units of one point.
08 hex	Performs a loopback test.
0E hex	Sets/resets word devices in units of one point by specifying a device number.
31 hex	Writes to a fixed buffer in units of one word.
32 hex	Reads from the random access buffer in units of one word.
33 hex	Writes to the random access buffer in units of one word.

Function Codes for the QnA-compatible 3E Frame Protocol

Function Code	Function
01 or 02 hex	Reads bit devices in units of one point.
03, 04, 09, or 0A hex	Reads word devices in units of one point.
05 or 0F hex	Writes bit devices in units of one point.
06, 0B, or 10 hex	Writes word devices in units of one point.
0E hex	Writes word devices in units of one point.
0D hex	Reads word devices in units of one point.
08 hex	Performs a loopback test.

Function Codes for the FINS Protocol

Function Code	Function
01 hex	Reads CIO Area bits, Work Area bits, Holding Area bits, and Auxiliary Area bits in units of one word.
03 or 09 hex	Reads DM Area in units of one word.
0F hex	Writes to CIO Area bits, Work Area bits, Holding Area bits, and Auxiliary Area bits in units of one word.
0B or 10 hex	Writes to DM Area in units of one word.
0D hex	Reads non-consecutive words from the DM Area.

Function Codes for the TOYOPUC Protocol

Function Code	Function
31 hex	Writes to the file memory in units of one word.

6.3.2 Using Function Codes

This section describes the use of the message function for each function code.

Function Codes: 01, 02, 03, 04, 09, and 0A Hex

Function: Reads data.

The specified size of data is read from specified registers in the remote station and stored in registers in the local station.

The following parameters need to be set in the MSG-SNDE function.

MSG-SNDE Function Parameter	Description
PARAM10	Connection Number Set the connection number used to determine the remote station.
PARAM11	Option This parameter is used with the QnA-compatible 3E Frame protocol and the FINS protocol. Refer to the section for each protocol for details.
PARAM12	Function Code Set the function code for the function to use.
PARAM14	Remote Station Data Address, Lower Word Set the first address to read from in the remote station. Specify a bit address for function codes 01 and 02 hex, and a word address for function codes 03, 04, 09, and 0A hex.
PARAM15	Remote Station Data Address, Upper Word Not used.
PARAM16	Remote Station Register Type Not used
PARAM17	Data Size Set the size of the data to read. Specify the size in bits for function codes 01 and 02 hex, and in words for function codes 03, 04, 09, and 0A hex.
PARAM18	Remote CPU Module Number This parameter is used with the Extended MEMOBUS protocol. Set the CPU number at the remote station.

Continued on next page.

Continued from previous page.

MSG-SNDE Function Parameter		Description
PARAM20	Local Station Data Address, Lower Word	Set the first register address to store the read data in the local station. Specify a bit address for function codes 01 and 02 hex, and a word address for function codes 03, 04, 09, and 0A hex.
PARAM21	Local Station Data Address, Upper Word	
PARAM22	Local Station Register Type	Set the register type (M, G, or O) to store the read data in the local station.
PARAM24	For system use	Set this parameter to 0 from a user program or by other means in the first scan after the power is turned ON. Thereafter, do not change the value of this parameter. This parameter is used by the system.

The following example illustrates how the contents of hold registers are read by using function code 09 hex. In this example, 200 words of data are read from register MW0030000 in the remote station and stored in registers in the local station starting at address GW0200000.

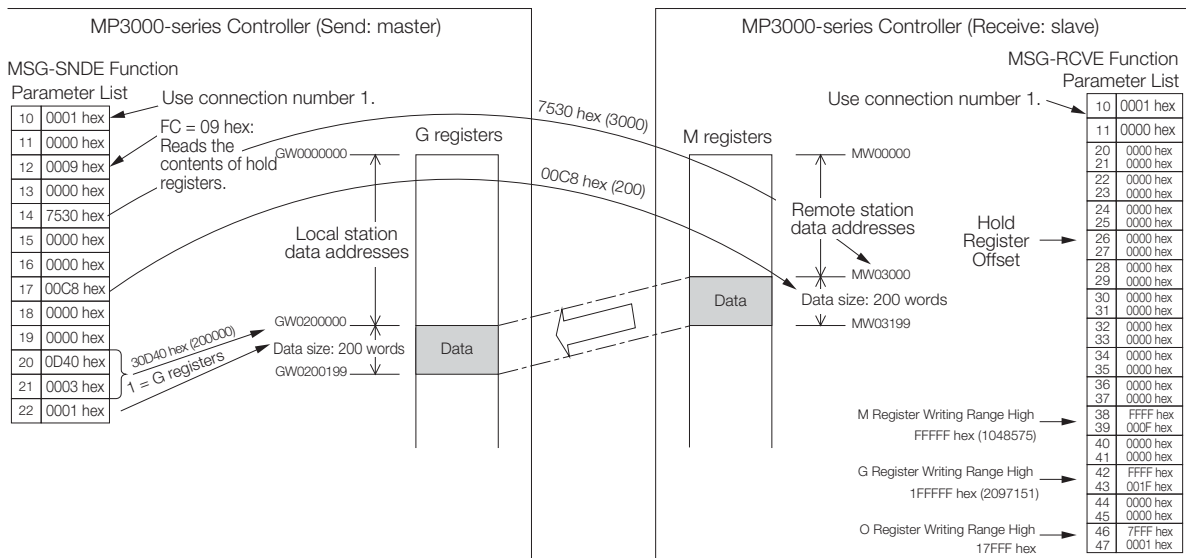

Example of Addressing and Offset Addressing with Function Codes 01, 02, 03, 04, 09, or 0A Hex

Information If the hold register offset parameters in the MSG-RCVE function are set to a non-zero value, the actual addresses that are read in the remote station will be the sum of the remote station data addresses and the value in the hold register offset parameters.

Function Codes: 05, 06, 0B, 0F, and 10 Hex

Function: Writes data.

The specified size of data is read from registers in the local station and written to specified registers in the remote station.

The following parameters need to be set in the MSG-SNDE function.

MSG-SNDE Function Parameter		Description
PARAM10	Connection Number	Set the connection number used to determine the remote station.
PARAM11	Option	This parameter is used with the QnA-compatible 3E Frame protocol and the FINS protocol. Refer to the section for each protocol for details.
PARAM12	Function Code	Set the function code for the function to use.
PARAM14	Remote Station Data Address, Lower Word	Set the first address to write to in the remote station. Specify a bit address for function codes 05 and 0F hex, and a word address for function codes 06, 0B, and 10 hex.
PARAM15	Remote Station Data Address, Upper Word	Not used.
PARAM16	Remote Station Register Type	Not used.
PARAM17	Data Size	Set the size of the data to write. Specify the size in bits for function code 0F hex, and in words for function code 0B and 10 hex. This parameter is not used for function codes 05 and 06 hex.
PARAM18	Remote CPU Module Number	This parameter is used with the Extended MEMOBUS protocol. Set the CPU number at the remote station.
PARAM20	Local Station Data Address, Lower Word	Set the first register address in the local station where the data to be written is stored. Specify a bit address for function codes 05 and 0F hex, and a word address for function codes 06, 0B, and 10 hex.
PARAM21	Local Station Data Address, Upper Word	
PARAM22	Local Station Register Type	Set the register type (M, G, I, O, or S) of the data to be written that is stored in the local station.
PARAM24	For system use	Set this parameter to 0 from a user program or by other means in the first scan after the power is turned ON. Thereafter, do not change the value of this parameter. This parameter is used by the system.

The following example illustrates how the states of multiple coils are changed by using function code 0F hex. In this example, 400 bits of data starting from register OB120000 in the local station are written to registers starting at MB00010000 in the remote station.

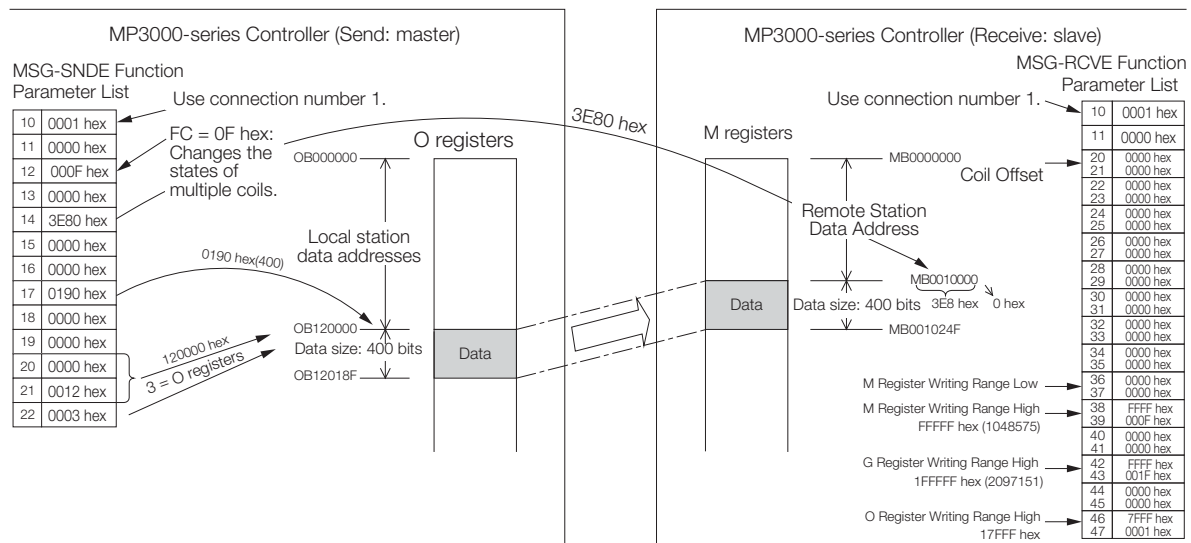

Example of Addressing and Offset Addressing with Function Codes 05, 06, 0B, 0F, or 10 Hex

- Information**
1. If the coil offset parameters in the MSG-RCVE function are set to a non-zero value, the actual addresses that are written to in the remote station will be the sum of the remote station data addresses and the word offset value in the coil offset parameters.
 2. Set the address of the registers to write to within the range specified by the M Register Writing Range Low and M Register Writing Range High parameters in the MSG-RCVE function. Data will not be written if an address exceeds the valid setting range.

Function Code: 0D Hex

Function: Reads data from multiple specified registers, one point at a time.

Data is read one word at a time from registers in the remote station as specified in the remote station address table that is stored in registers in the local station. This function reads the number of data items that is specified in the data size parameter.

The applicable registers that can be read from the remote station are the M registers. The register addresses to store the data in the local station are set to the sum of each address specified in the remote station address table and the local station data address.

The following parameters need to be set in the MSG-SNDE function.

MSG-SNDE Function Parameter		Description
PARAM10	Connection Number	Set the connection number used to determine the remote station.
PARAM11	Option	This parameter is used with the QnA-compatible 3E Frame protocol and the FINS protocol. Refer to the section for each protocol for details.
PARAM12	Function Code	Set the function code for the function to use.
PARAM14	Remote Station Data Address, Lower Word	Set the first register address where the remote station address table is stored.
PARAM15	Remote Station Data Address, Upper Word	
PARAM16	Remote Station Register Type	Set the register type (M, G, I, O, or S) in the local station where the remote station address table is stored.
PARAM17	Data Size	Set the number of data items to read.
PARAM18	Remote CPU Module Number	This parameter is used with the Extended MEMOBUS protocol. Set the CPU number at the remote station.
PARAM20	Local Station Data Address, Lower Word	These parameters are used to offset the address for writing data in registers in the local station that have been read from the remote station. Data will be written to the addresses that are the sum of each address specified in the remote station address table and the local station data address.
PARAM21	Local Station Data Address, Upper Word	
PARAM22	Local Station Register Type	Set the register type (M, G, or O) to store the read data in the local station.
PARAM24	For system use	Set this parameter to 0 from a user program or by other means in the first scan after the power is turned ON. Thereafter, do not change the value of this parameter. This parameter is used by the system.

6.3 Using Message Functions

6.3.2 Using Function Codes

The following example illustrates how the contents of non-consecutive hold registers are read by using function code 0D hex. In this example, the contents of registers MW0001000, MW0002000, and MW0003000 in the remote station are read and stored in registers GW0002000, GW0003000, and GW0004000 in the local station. The remote station address table starts at register MW0010000 in the local station.

The remote station address table contains a one-word address specifier for each data item, as illustrated below.

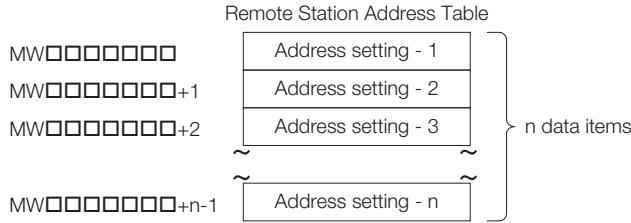

Remote Station Address Table When Using Function Code 0D Hex

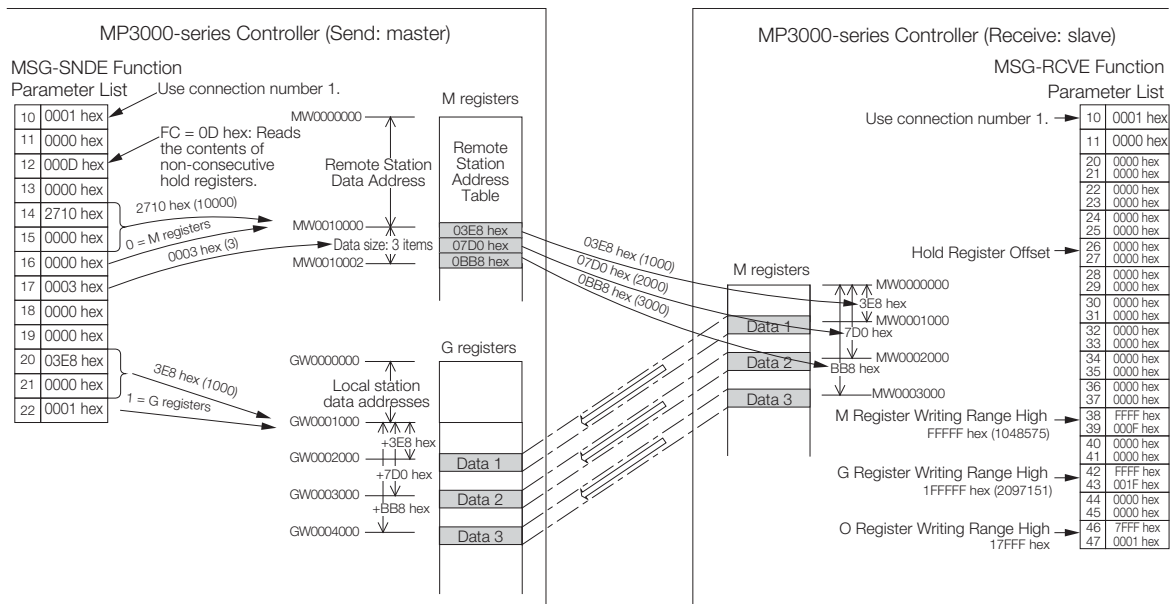

Example of Addressing and Offset Addressing with Function Code 0D Hex

Information If the hold register offset parameters in the MSG-RCVE function are set to a non-zero value, the actual addresses that are read in the remote station will be the sum of the specified data addresses and the value in the hold register offset parameters.

Function Code: 0E Hex

Function: Writes data to multiple specified registers, one point at a time.

Data is written one word at a time in registers in the remote station as specified in the remote station address table that is stored in registers in the local station. This function writes the number of data items specified by the data size parameter.

The applicable registers that can be written to in the remote station are the M registers. The register addresses to store the data to be written in the local station are set to the sum of each address specified in the remote station address table and the local station data address.

The following parameters need to be set in the MSG-SNDE function.

MSG-SNDE Function Parameter		Description
PARAM10	Connection Number	Set the connection number used to determine the remote station.
PARAM11	Option	This parameter is used with the QnA-compatible 3E Frame protocol. Refer to the section for each protocol for details.
PARAM12	Function Code	Set the function code for the function to use.
PARAM14	Remote Station Data Address, Lower Word	Set the first register address where the remote station address table is stored.
PARAM15	Remote Station Data Address, Upper Word	
PARAM16	Remote Station Register Type	Set the register type (M, G, I, O, or S) in the local station where the remote station address table is stored.
PARAM17	Data Size	Set the number of data items to write.
PARAM18	Remote CPU Module Number	This parameter is used with the Extended MEMOBUS protocol. Set the CPU number at the remote station.
PARAM20	Local Station Data Address, Lower Word	These parameters are used to offset the address for reading data from registers in the local station for writing in the remote station. Data will be read from the addresses that are the sum of each address specified in the remote station address table and the local station data address.
PARAM21	Local Station Data Address, Upper Word	
PARAM22	Local Station Register Type	Set the register type (M, G, I, O, or S) of the data to be written that is stored in the local station.
PARAM24	For system use	Set this parameter to 0 from a user program or by other means in the first scan after the power is turned ON. Thereafter, do not change the value of this parameter. This parameter is used by the system.

6.3 Using Message Functions

6.3.2 Using Function Codes

The following example illustrates how the contents of non-consecutive hold registers are written by using function code 0E hex. In this example, data stored in registers IW0002000, IW000200A, and IW0002014 in the local station are written to registers MW0001000, MW0001010, and MW0001020 in the remote station. The remote station address table starts at register GW0200000 in the local station.

The remote station address table contains a one-word address specifier for each data item, as illustrated below.

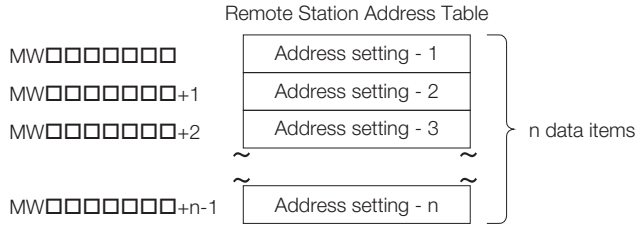

Remote Station Address Table When Using Function Code 0E Hex

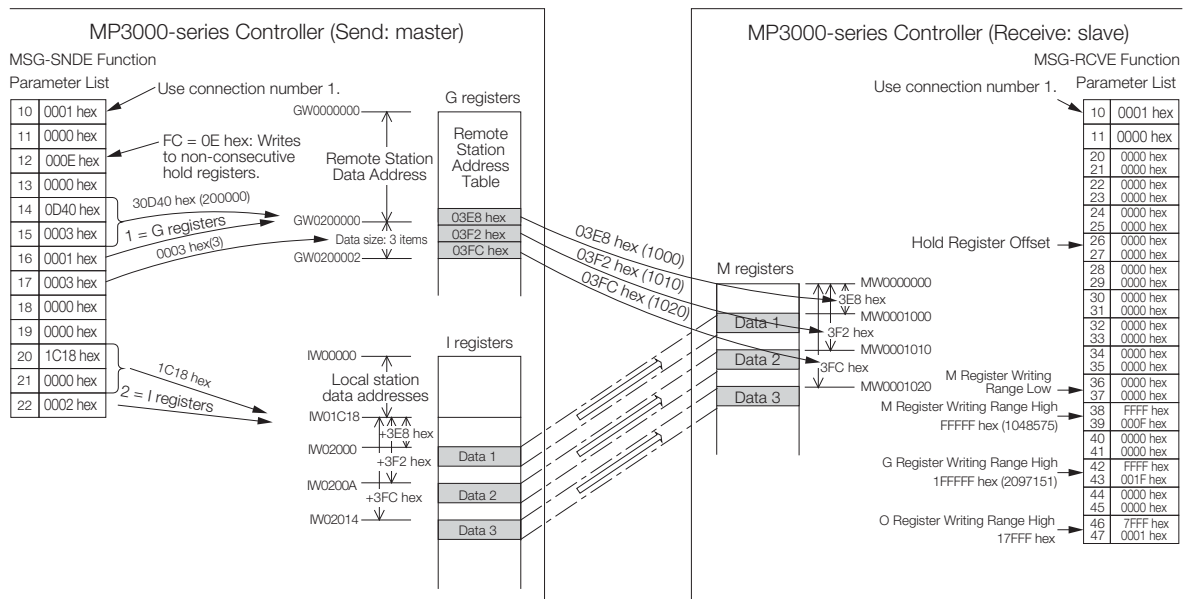

Example of Addressing and Offset Addressing with Function Code 0E Hex

Information If the hold register offset parameters in the MSG-RCVE function are set to a non-zero value, the actual addresses that are written to in the remote station will be the sum of the specified data addresses and the value in the hold register offset parameters.

Function Codes: 4341 and 4349 Hex

Function: Reads data from a data address in the remote station specified with a 32-bit address.

The specified size of data is read from specified registers in the remote station and stored in registers in the local station.

The following parameters need to be set in the MSG-SNDE function.

MSG-SNDE Function Parameter	Description	
PARAM10	Connection Number	Set the connection number that determines the remote station.
PARAM11	Option	Not used.
PARAM12	Function Code	Set the function code for the function to use.
PARAM14	Remote Station Data Address, Lower Word	Set the first address to read from in the remote station. Specify a bit address for function code 4341 hex, and a word address for function code 4349 hex.
PARAM15	Remote Station Data Address, Upper Word	
PARAM16	Remote Station Register Type	Set the register type (M, G, I, O, or S) to read from in the remote station.
PARAM17	Data Size	Set the size of the data to read. Specify the size in bits for function code 4341 hex, and in words for function code 4349 hex.
PARAM18	Remote CPU Module Number	This parameter is used with the Extended MEMOBUS protocol. Set the CPU number at the remote station.
PARAM20	Local Station Data Address, Lower Word	Set the first register address to store the read data in the local station. Specify a bit address for function code 4341 hex, and a word address for function code 4349 hex.
PARAM21	Local Station Data Address, Upper Word	
PARAM22	Local Station Register Type	Set the register type (M, G, or O) to store the read data in the local station.
PARAM24	For system use	Set this parameter to 0 from a user program or by other means in the first scan after the power is turned ON. Thereafter, do not change the value of this parameter. This parameter is used by the system.

The following example illustrates how the contents of multiple registers are read by using function code 4349 hex. In this example, 1000 words of data are read from register OW10100 in the remote station and stored in registers in the local station starting at address MW0010000.

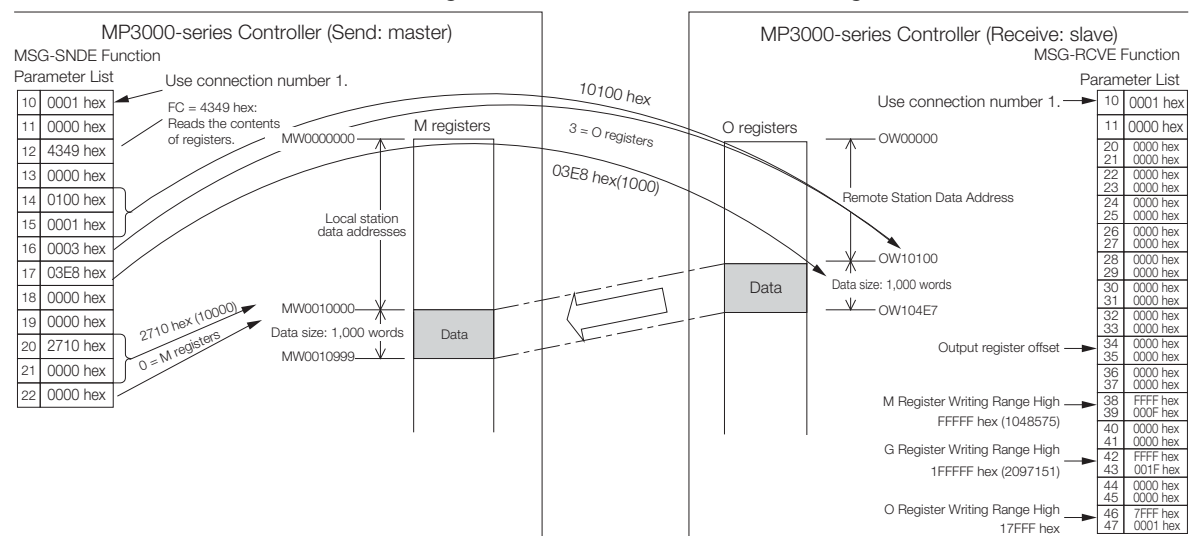

Example of Addressing and Offset Addressing with Function Code 4314 or 4349 Hex

Information If the output register offset parameters in the MSG-RCVE function are set to a non-zero value, the actual addresses that are read in the remote station will be the sum of the remote station data addresses and the value in the output register offset parameters.

Function Codes: 4345, 4346, 434B, and 434F Hex

Function: Writes data to a data address in the remote station specified by a 32-bit address. The specified size of data is read from registers in the local station and written to specified registers in the remote station.

The following parameters need to be set in the MSG-SNDE function.

MSG-SNDE Function Parameter		Description
PARAM10	Connection Number	Set the connection number used to determine the remote station.
PARAM11	Option	Not used.
PARAM12	Function Code	Set the function code for the function to use.
PARAM14	Remote Station Data Address, Lower Word	Set the first address to write to in the remote station. Specify a bit address for function code 4345 or 434F hex, and a word address for function code 4346 or 434B hex.
PARAM15	Remote Station Data Address, Upper Word	
PARAM16	Remote Station Register Type	Set the register type (M, G, O, or S) to write to in the remote station.
PARAM17	Data Size	Set the size of the data to write. Specify the size in bits for function code 434F hex, and in words for function code 434B hex. This parameter is not used for function codes 4345 and 4346 hex.
PARAM18	Remote CPU Module Number	This parameter is used with the Extended MEMOBUS protocol. Set the CPU number at the remote station.
PARAM20	Local Station Data Address, Lower Word	Set the first register address in the local station where the data to be written is stored. Specify a bit address for function code 4345 or 434F hex, and a word address for function code 4346 or 434B hex.
PARAM21	Local Station Data Address, Upper Word	
PARAM22	Local Station Register Type	Set the register type (M, G, I, O, or S) of the data to be written that is stored in the local station.
PARAM24	For system use	Set this parameter to 0 from a user program or by other means in the first scan after the power is turned ON. Thereafter, do not change the value of this parameter. This parameter is used by the system.

The following example illustrates how the states of multiple bits are changed by using function code 434F hex. In this example, 5000 bits of data starting from register IB120000 in the local station are written to registers starting at GB02000008 in the remote station.

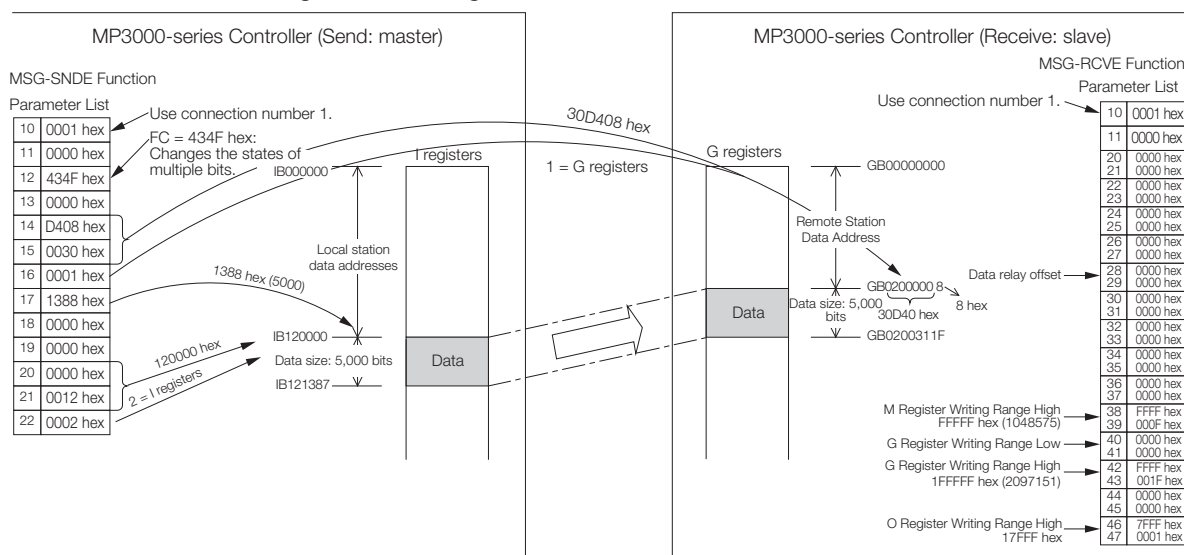

Example of Addressing and Offset Addressing with Function Code 4345, 4346, 434B, or 434F Hex

Information

1. If the data relay offset parameters in the MSG-RCVE function are set to a non-zero value, the actual addresses that are written to in the remote station will be the sum of the remote station data addresses and the word offset value in the data relay offset parameters.
2. Set the address of the registers to write to within the range specified by the G Register Writing Range Low and G Register Writing Range High parameters in the MSG-RCVE function. Data will not be written if an address exceeds the valid setting range.

Function Code: 434D Hex

Function: Reads data from multiple registers specified by a 32-bit address, one point at a time. Data is read one or two words at a time from registers in the remote station as specified in the remote station address table that is stored in registers in the local station. This function reads the number of data items that is specified in the data size parameter.

The register to read from in the remote station is listed in the remote station address table.

The following parameters need to be set in the MSG-SNDE function.

MSG-SNDE Function Parameter		Description
PARAM10	Connection Number	Set the connection number used to determine the remote station.
PARAM11	Option	Not used.
PARAM12	Function Code	Set the function code for the function to use.
PARAM14	Remote Station Data Address, Lower Word	Set the first register address where the remote station address table is stored.
PARAM15	Remote Station Data Address, Upper Word	
PARAM16	Remote Station Register Type	Set the register type (M or G) in the local station where the remote station address table is stored.
PARAM17	Data Size	Set the number of data items to read.
PARAM18	Remote CPU Module Number	This parameter is used with the Extended MEMOBUS protocol. Set the CPU number at the remote station.
PARAM20	Local Station Data Address, Lower Word	Set the first register address to store the read data in the local station.
PARAM21	Local Station Data Address, Upper Word	
PARAM22	Local Station Register Type	Set the register type (M or G) where the read data is to be stored in the local station.
PARAM24	For system use	Set this parameter to 0 from a user program or by other means in the first scan after the power is turned ON. Thereafter, do not change the value of this parameter. This parameter is used by the system.

The following example illustrates how the contents of non-consecutive registers are read by using function code 434D hex. In this example, 2 words of data are read from register MW0001000, 1 word from register GW0200000, and 2 words from register IW17FFE in the remote station. These words are stored in the same order in registers in the local station starting at address MW0500000. The remote station address table starts at register GW0020000 in the local station.

The remote station address table consists of 4 words per data item, as illustrated below.

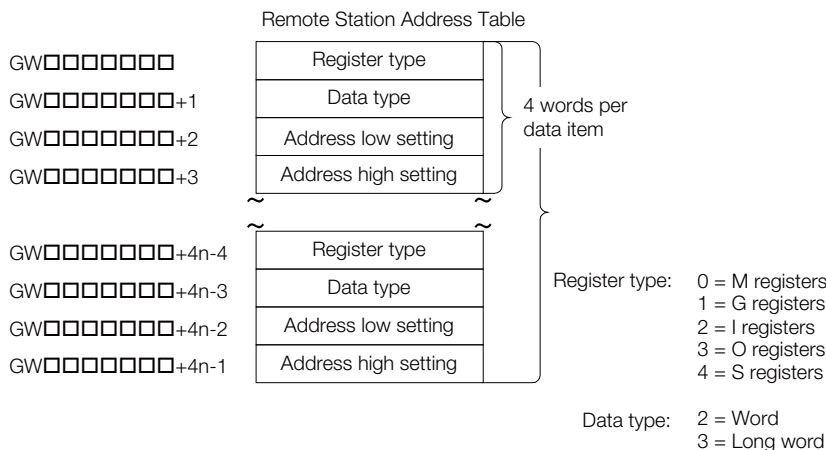

Remote Station Address Table When Using Function Code 434D Hex

6.3 Using Message Functions

6.3.2 Using Function Codes

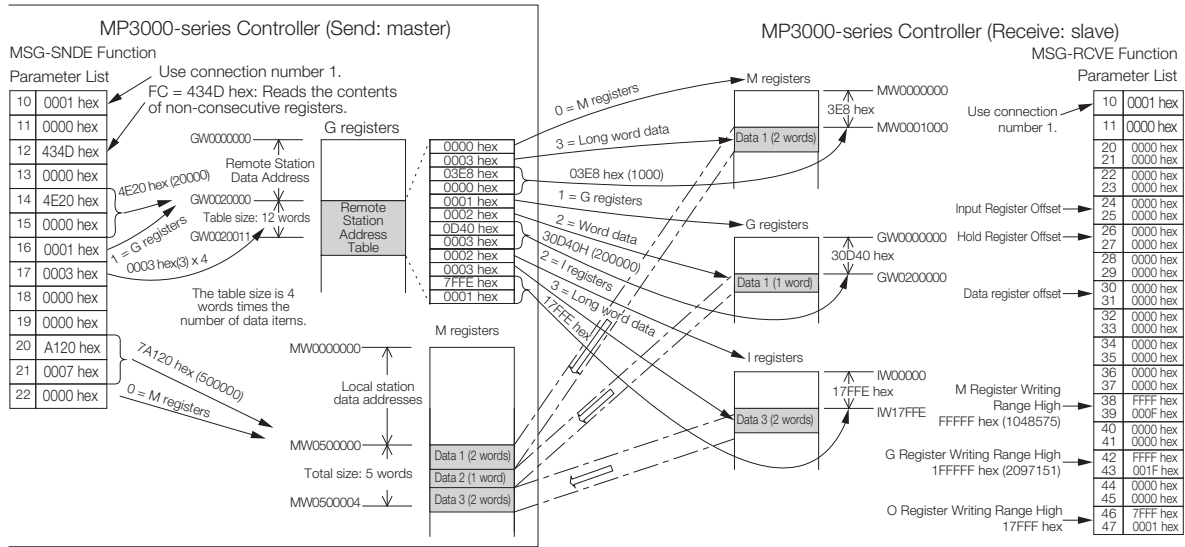

Example of Addressing and Offset Addressing with Function Code 434D Hex

Information If the various offset parameters in the MSG-RCVE function are set to non-zero values, the actual addresses that are read in the remote station will be the sum of the specified data addresses and the values in the offset parameters.

Function Code: 434E Hex

Function: Writes data to multiple registers specified by a 32-bit address, one point at a time. Data is written one or two words at a time in registers in the remote station as specified in the remote station address table that is stored in registers in the local station. This function writes the number of data items specified by the data size parameter. The register type and data address that are specified in the remote station address table determine the registers in the remote station.

The following parameters need to be set in the MSG-SNDE function.

MSG-SNDE Function Parameter		Description
PARAM10	Connection Number	Set the connection number used to determine the remote station.
PARAM11	Option	Not used.
PARAM12	Function Code	Set the function code for the function to use.
PARAM14	Remote Station Data Address, Lower Word	Set the first register address where the remote station address table is stored.
PARAM15	Remote Station Data Address, Upper Word	
PARAM16	Remote Station Register Type	Set the register type (M or G) in the local station where the remote station address table is stored.
PARAM17	Data Size	Set the number of data items to write.
PARAM18	Remote CPU Module Number	This parameter is used with the Extended MEMOBUS protocol. Set the CPU number at the remote station.
PARAM20	Local Station Data Address, Lower Word	Set the register address that points to the first address of the local station address table that lists where the data to be written is stored.
PARAM21	Local Station Data Address, Upper Word	
PARAM22	Local Station Register Type	Set the register type (M or G) in the local station where the local station address table is stored.
PARAM24	For system use	Set this parameter to 0 from a user program or by other means in the first scan after the power is turned ON. Thereafter, do not change the value of this parameter. This parameter is used by the system.

The following example illustrates how the contents of non-consecutive registers are written by using function code 434E hex. In this example, 2 words of data are read from register IW0002000, 2 words from register MW0120000, and 1 word from register SW00200 in the local station. These words are written to registers MW0001000, GW1000000, and GW2097151 in the remote station. The remote station address table starts at register GW0001000 and the local station address table starts at register GW0002000 in the local station.

The remote station address table and local station address table consist of 4 words per data item, as illustrated below.

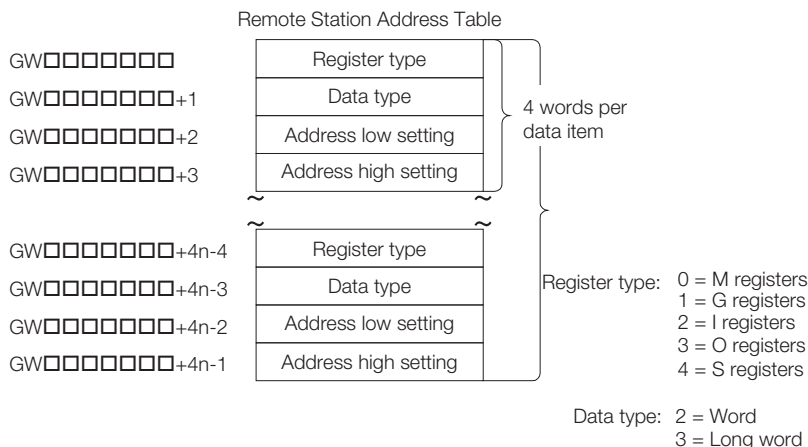

Remote Station Address Table When Using Function Code 434E Hex

6.3 Using Message Functions

6.3.2 Using Function Codes

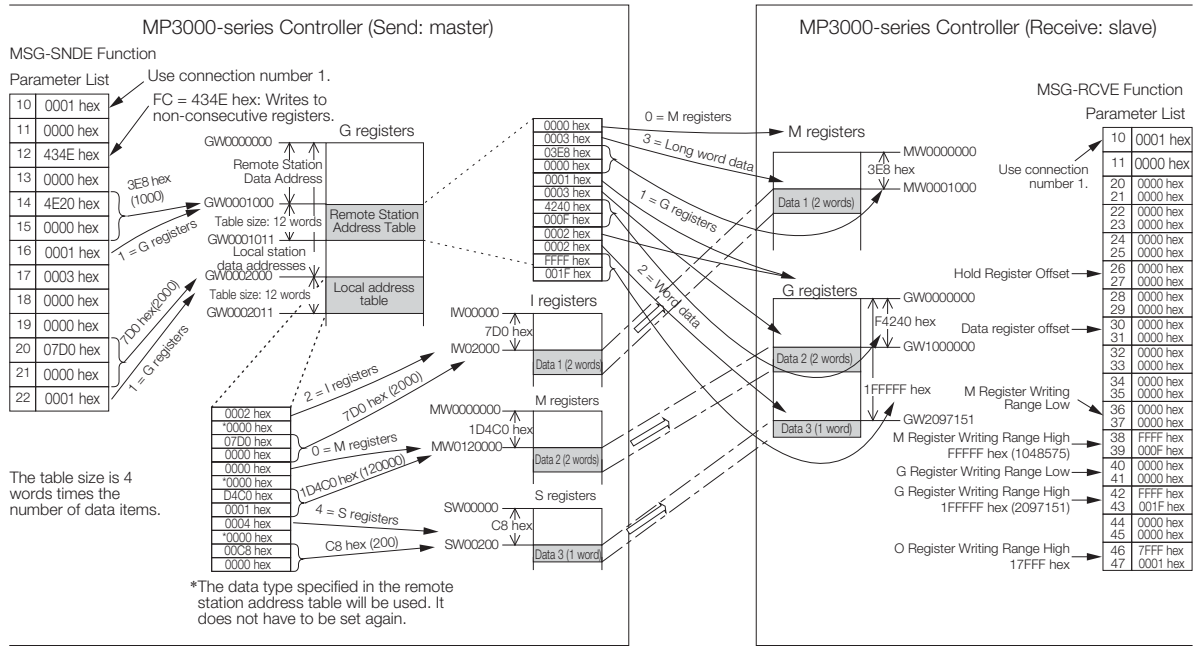

Example of Addressing and Offset Addressing with Function Code 434E Hex

Information

1. If the various register offset parameters in the MSG-RCVE function are set to non-zero values, the actual addresses that are written to in the remote station will be the sum of the remote station data addresses and the word offset values in the register offset parameters.
2. Set the address of the registers to write to within the range specified by the Register Writing Range Low and Register Writing Range High parameters in the MSG-RCVE function. Data will not be written if an address exceeds the valid setting range.

Function Code: 31 Hex

Function: Writes to the fixed buffer in a Mitsubishi PLC, or to the file memory in a TEKT PLC. The specified size of data is read from registers in the local station and written to registers in the remote station.

The register address in the remote station cannot be specified.

The following parameters need to be set in the MSG-SNDE function.

MSG-SNDE Function Parameter	Description
PARAM10	Connection Number Set the connection number used to determine the remote station.
PARAM11	Option Not used.
PARAM12	Function Code Set the function code for the function to use.
PARAM14	Remote Station Data Address, Lower Word Set the first address to write to in the remote station.
PARAM15	Remote Station Data Address, Upper Word Not used.
PARAM16	Remote Station Register Type Not used.
PARAM17	Data Size Set the size of the data to write. (Specify the size in words.)
PARAM18	Remote CPU Module Number Not used.
PARAM20	Local Station Data Address, Lower Word Set the first register address in the local station where the data to be written is stored. (Set the word address.)
PARAM21	Local Station Data Address, Upper Word
PARAM22	Local Station Register Type Set the register type (M, G, I, O, or S) of the data to be written that is stored in the local station.
PARAM24	For system use Set this parameter to 0 from a user program or by other means in the first scan after the power is turned ON. Thereafter, do not change the value of this parameter. This parameter is used by the system.

The following example illustrates how data is written to fixed buffers by using function code 31 hex. In this example, 1,000 bits of data starting from register GW0500000 in the local station are written to fixed buffers in the remote station.

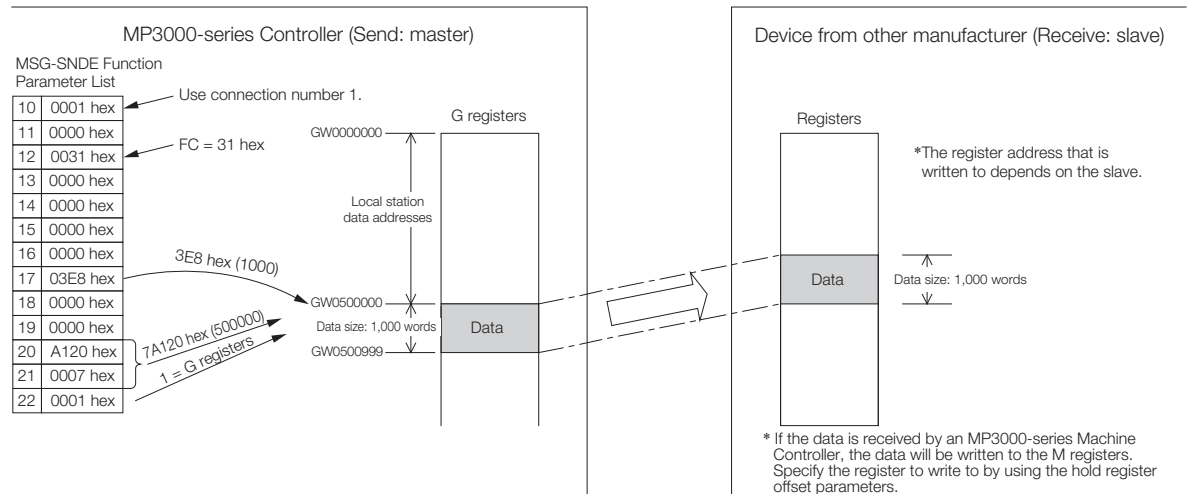

Example of Addressing and Offset Addressing with Function Code 31 Hex

Information

1. If the data is being received by an MP3000 slave, the data will be written to the addresses that are specified by the hold register offset parameters in the MSG-RCVE function.
2. Set the address of the register to write to within the range specified by the M Register Writing Range Low and M Register Writing Range High parameters in the MSG-RCVE function. Data will not be written if an address exceeds the valid setting range.

Function Code: 32 Hex

Function: Reads from the random access buffer in a Mitsubishi PLC.

The specified size of data is read from specified registers in the remote station and stored in registers in the local station.

The read works only with the random access buffer in the remote station.

The following parameters need to be set in the MSG-SNDE function.

MSG-SNDE Function Parameter	Description	
PARAM10	Connection Number	Set the connection number used to determine the remote station.
PARAM11	Option	Not used.
PARAM12	Function Code	Set the function code for the function to use.
PARAM14	Remote Station Data Address, Lower Word	Set the first address to read from in the remote station. (Set the word address.)
PARAM15	Remote Station Data Address, Upper Word	Not used.
PARAM16	Remote Station Register Type	Not used.
PARAM17	Data Size	Set the size of the data to read. (Specify the size in words.)
PARAM18	Remote CPU Module Number	Not used.
PARAM20	Local Station Data Address, Lower Word	Set the first register address to store the read data in the local station. (Set the word address.)
PARAM21	Local Station Data Address, Upper Word	
PARAM22	Local Station Register Type	Set the register type (M, G, or O) to store the read data in the local station.
PARAM24	For system use	Set this parameter to 0 from a user program or by other means in the first scan after the power is turned ON. Thereafter, do not change the value of this parameter. This parameter is used by the system.

The following example illustrates how the contents of the random access buffer is read by using function code 32 hex. In this example, 500 words of data are read starting from register 00010 in the remote station and stored in registers in the local station starting at address MW0010000.

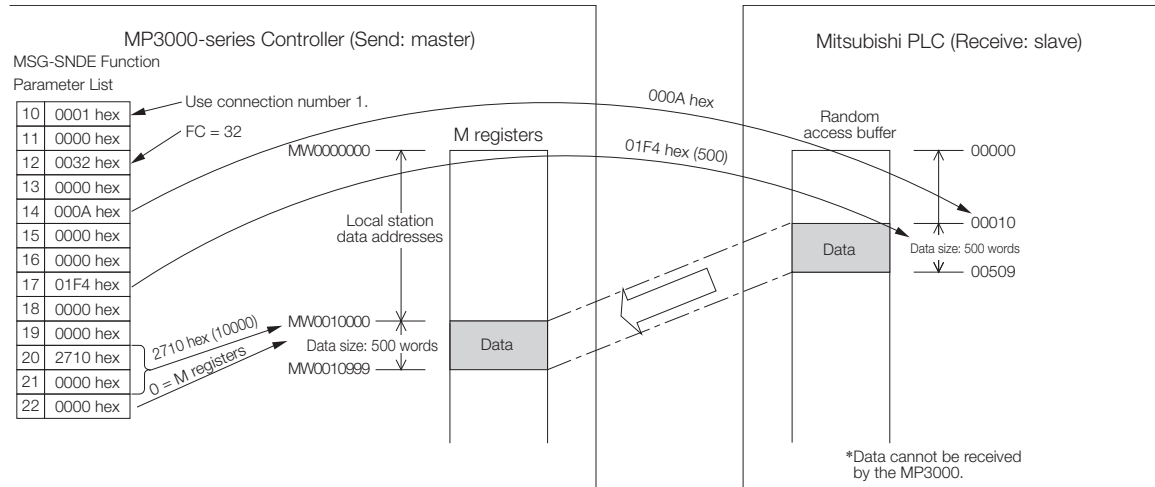

Example of Addressing and Offset Addressing with Function Code 32 Hex

Information When the MP3000 acts as a slave, function command 32 hex cannot be used to receive data.

Function Code: 33 Hex

Function: Writes to the random access buffer in a Mitsubishi PLC.

The specified size of data is read from registers in the local station and written to the remote station starting from the specified register.

The read works only with the random access buffer in the remote station.

The following parameters need to be set in the MSG-SNDE function.

MSG-SNDE Function Parameter	Description	
PARAM10	Connection Number	Set the connection number used to determine the remote station.
PARAM11	Option	Not used.
PARAM12	Function Code	Set the function code for the function to use.
PARAM14	Remote Station Data Address, Lower Word	Set the first address to write to in the remote station. (Set the word address.)
PARAM15	Remote Station Data Address, Upper Word	Not used.
PARAM16	Remote Station Register Type	Not used.
PARAM17	Data Size	Set the size of the data to write. (Specify the size in words.)
PARAM18	Remote CPU Module Number	Not used.
PARAM20	Local Station Data Address, Lower Word	Set the first register address in the local station where the data to be written is stored. (Set the word address.)
PARAM21	Local Station Data Address, Upper Word	
PARAM22	Local Station Register Type	Set the register type (M, G, I, O, or S) of the data to be written that is stored in the local station.
PARAM24	For system use	Set this parameter to 0 from a user program or by other means in the first scan after the power is turned ON. Thereafter, do not change the value of this parameter. This parameter is used by the system.

The following example illustrates how to write to the random access buffer by using function code 33 hex. In this example, 600 words of data starting from register IW05000 in the local station are written to registers starting at 00016 in the remote station.

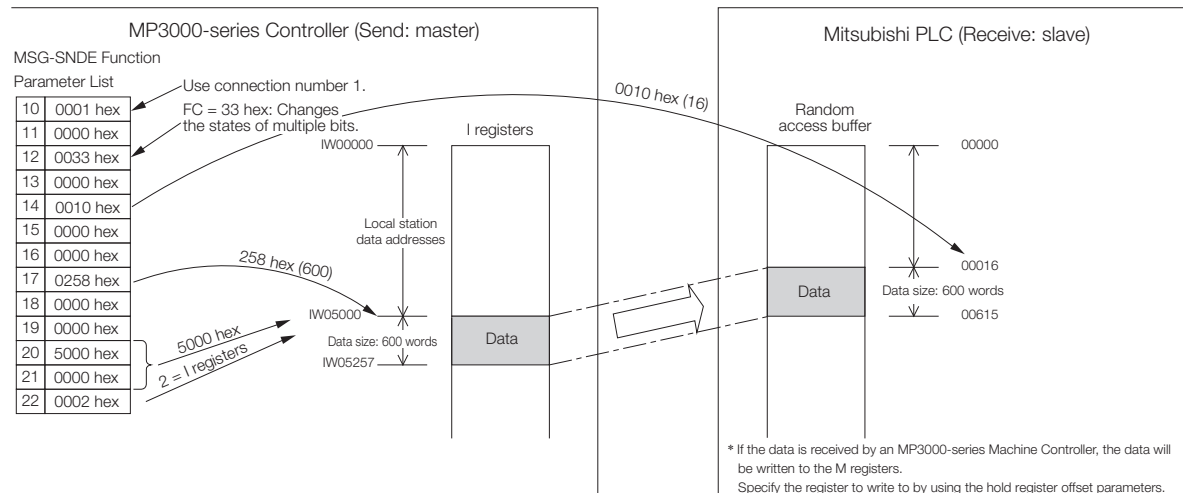

Example of Addressing and Offset Addressing with Function Code 33 Hex

Information

1. If the data is being received by an MP3000 slave, the data will be written to the addresses that are specified by the hold register offset parameters in the MSG-RCVE function.
2. Set the address of the register to write to within the range specified by the M Register Writing Range Low and M Register Writing Range High parameters in the MSG-RCVE function. Data will not be written if an address exceeds the valid setting range.

No-protocol Communications (No Function Code)

Function: Writes data.

The specified size of data is read from registers in the local station and written to M registers in the remote station.

The applicable registers in the remote station are the M registers.

The following parameters need to be set in the MSG-SNDE function.

MSG-SNDE Function Parameter	Description	
PARAM10	Connection Number	Set the connection number used to determine the remote station.
PARAM11	Option	Not used.
PARAM12	Function Code	Not used.
PARAM14	Remote Station Data Address, Lower Word	Not used.
PARAM15	Remote Station Data Address, Upper Word	Not used.
PARAM16	Remote Station Register Type	Not used.
PARAM17	Data Size	Set the size of the data to write. Specify the size in words for no-protocol 1 and in bytes for no-protocol 2.
PARAM18	Remote CPU Module Number	Not used.
PARAM20	Local Station Data Address, Lower Word	Set the first register address in the local station where the data to be written is stored.
PARAM21	Local Station Data Address, Upper Word	
PARAM22	Local Station Register Type	Set the register type (M, G, I, O, or S) of the data to be written that is stored in the local station.
PARAM24	For system use	Set this parameter to 0 from a user program or by other means in the first scan after the power is turned ON. Thereafter, do not change the value of this parameter. This parameter is used by the system.

6.3 Using Message Functions

6.3.2 Using Function Codes

The following example illustrates how data is written using no-protocol communications. In this example, 1,500 words of data starting from register IW07800 in the local station are written to registers starting at MW0800000 in the remote station.

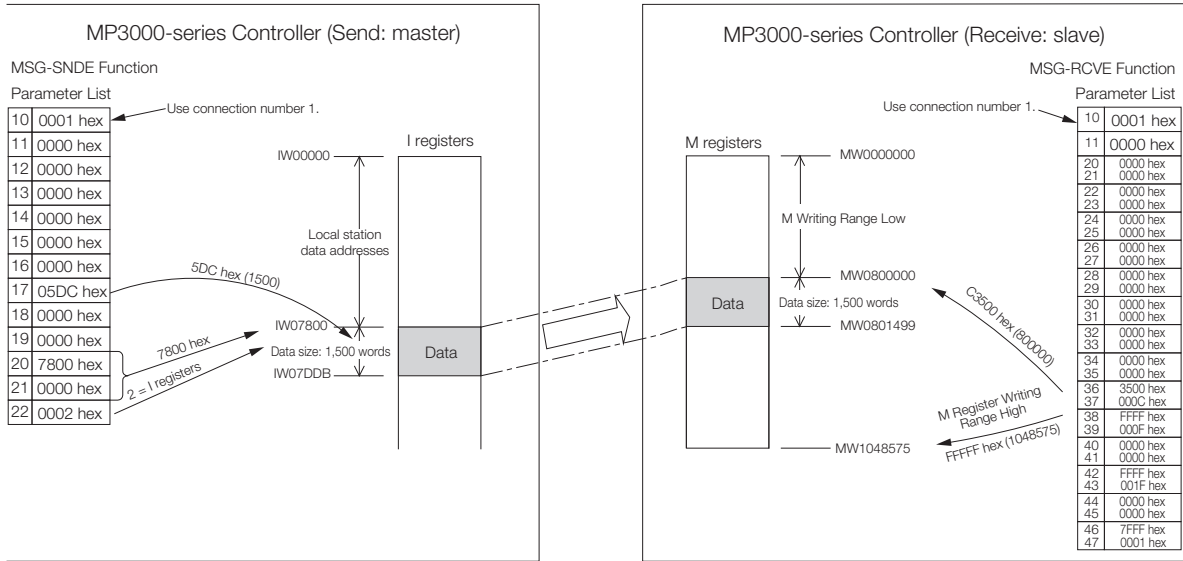

Example of Addressing and Offset Addressing with No-Protocol Communications

Information

1. The registers in the remote station are specified by the M Register Writing Range Low parameter in the MSG-RCVE function.
2. Set the address of the registers to write to within the range specified by the M Register Writing Range Low and M Register Writing Range High parameters in the MSG-RCVE function. Data will not be written if an address exceeds the valid setting range.

6.4 Details on Protocols

This section provides details on the Extended MEMOBUS protocol, MEMOBUS protocol, and no-protocol communications.

6.4.1 Extended MEMOBUS protocol

Message Structure

The following message structure is used in Ethernet communications. Use this as reference when developing a PC-based application.

When the Extended MEMOBUS protocol is used to send and receive data, each message consists of three fields: a header field, a 218 header field, and the application data field.

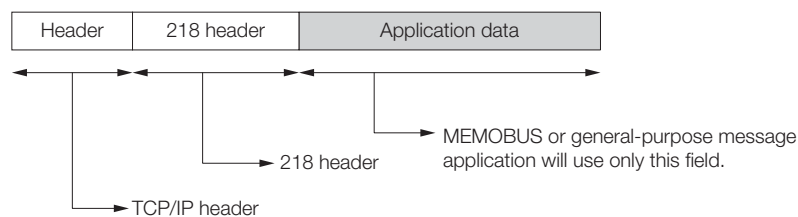

The header is used for TCP/IP and UDP/IP. User programs do not need to be aware of this header because it is automatically appended and removed in the 218IFD.

The 218 header is required when using the Extended MEMOBUS protocol for Ethernet communications. User programs also do not need to be aware of the 218 header because it is automatically appended and removed in the 218IFD.

The actual data for the Extended MEMOBUS protocol is stored in the application data field.

When communicating between a 218IFD and a host computer, the application on the host computer must append and remove the 218 header.

The application data field contains the following parameter structure based on the combination of communications protocol and the code that is specified.

Communications Protocols	Code	Reference
MEMOBUS message communications	BIN	<i>MEMOBUS Binary Mode on page 6-27</i>
MEMOBUS message communications	ASCII	<i>MEMOBUS ASCII Mode on page 6-47</i>
General-purpose message communications (no-protocol)	BIN	<i>General-purpose Message Binary Mode on page 6-47</i>
General-purpose message communications (no-protocol)	ASCII	<i>General-purpose Message ASCII Mode on page 6-48</i>

◆ 218 Header

When communicating with the Extended MEMOBUS protocol, a 12-byte header called the 218 header is appended before the application data. The following figure illustrates the 218 header structure and contents.

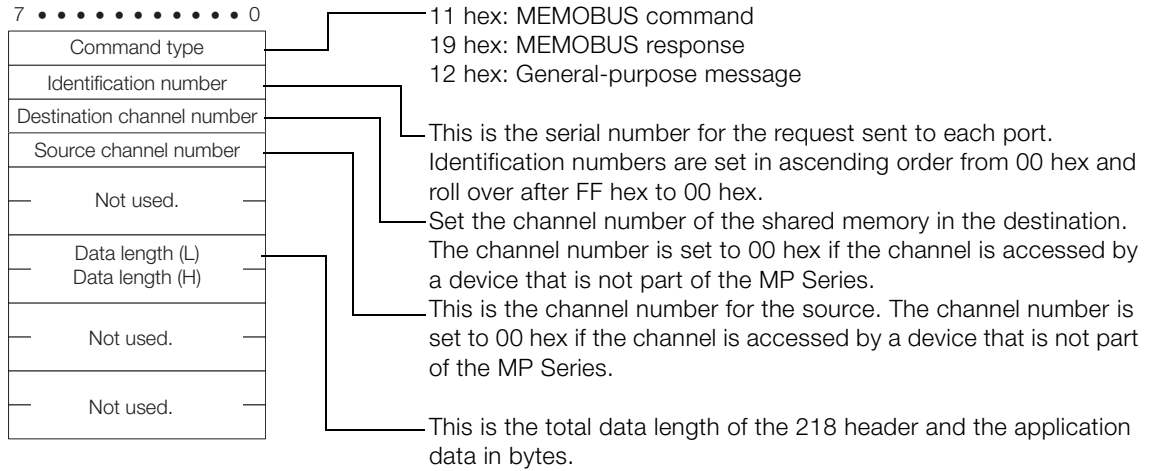

◆ Extended MEMOBUS Commands

The commands that make up the Extended MEMOBUS messages are identified by function codes and provide the functions given in the following table.

Major Function Code	Sub Function Code	Function
20 hex	01 hex	Reads the states of coils.
	02 hex	Reads the states of input relays.
	03 hex	Reads the contents of hold registers.
	04 hex	Reads the contents of input registers.
	05 hex	Changes the state of a single coil.
	06 hex	Writes to a single hold register or one word.
	08 hex	Performs a loopback test.
	09 hex	Reads the contents of hold registers (extended).
	0A hex	Reads the contents of input registers (extended).
	0B hex	Writes to hold registers (extended).
43 hex (extended function for accessing registers using 32-bit addresses)	0D hex	Reads the contents of non-consecutive hold registers (extended).
	0E hex	Writes the contents of non-consecutive hold registers (extended).
	0F hex	Changes the states of multiple coils.
	10 hex	Writes to multiple hold registers.
	41 hex	Reads the states of bits.
	45 hex	Changes the state of a single bit.
	46 hex	Writes to a single register.
	49 hex	Reads the contents of registers.
4B hex	Writes to multiple registers.	
4D hex	Reads the contents of non-consecutive registers.	
4E hex	Writes the contents of non-consecutive registers.	
4F hex	Changes the states of multiple bits.	

◆ Register Types

When the major function code is 43 hex and the function specified by the sub function code references the contents of a register, such as a read, write, or change of state, specify the target register type in the slave. The codes for register types are given below.

Register Types	Code	Available Sub Function Codes
Hold Registers (M)	4D hex	41, 45, 46, 49, 4B, 4D, 4E, or 4F hex
Data registers (G)	47 hex	41, 45, 46, 49, 4B, 4D, 4E, or 4F hex
Input Registers (I)	49 hex	41, 49, or 4D hex
Output Registers (O)	4F hex	41, 45, 46, 49, 4B, 4D, 4E, or 4F hex
System Registers (S)	53 hex	41, 45, 46, 49, 4B, 4D, 4E, or 4F hex

◆ Data Types

When the major function code is 43 hex and the function specified by the sub function code reads or writes to non-consecutive registers, specify the type of the target data. The codes for data types are given below.

Data Types	Code	Available Sub Function Codes
Word (2 bytes)	2	4D or 4E hex
Long word (4 bytes)	3	4D or 4E hex

MEMOBUS Binary Mode

The following formats are used for MEMOBUS message communications in binary mode.

◆ Reading the States of Coils

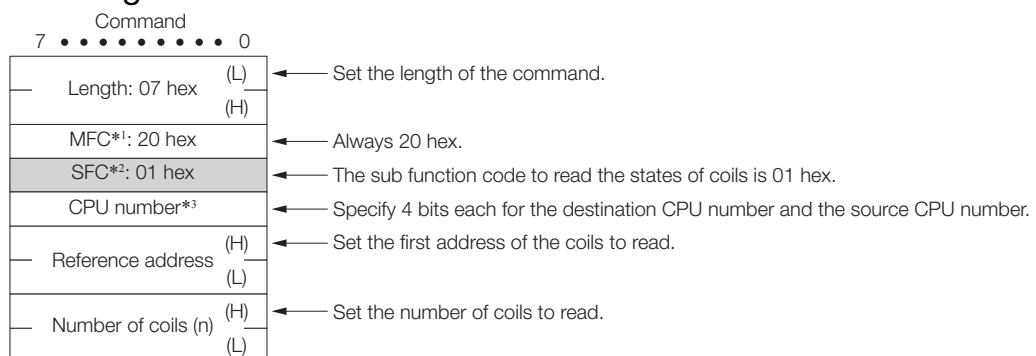

*1. MFC: Major function code

*2. SFC: Sub function code

*3. The CPU number is arranged as follows:

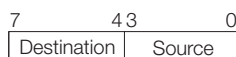

Example

In this example, CPU 2 is the source and it will send a message to CPU 1, the destination.

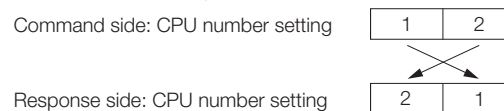

Note: When sending a message to MP2000 or MP3000, set to 1 as the destination.

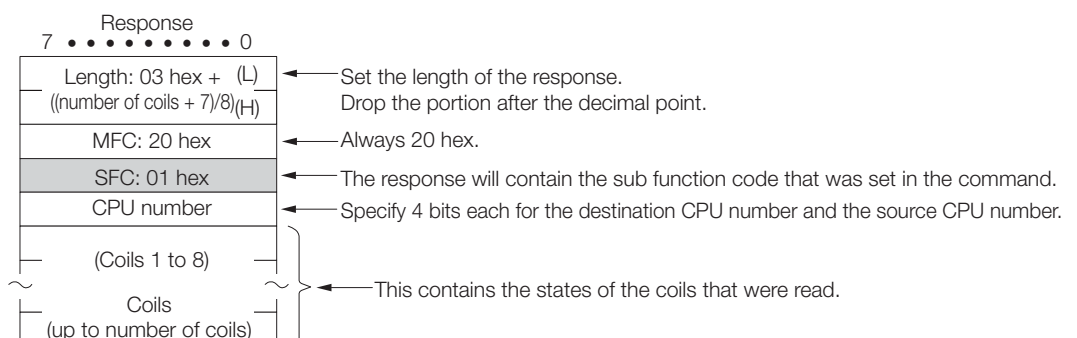

◆ Reading the States of Input Relays

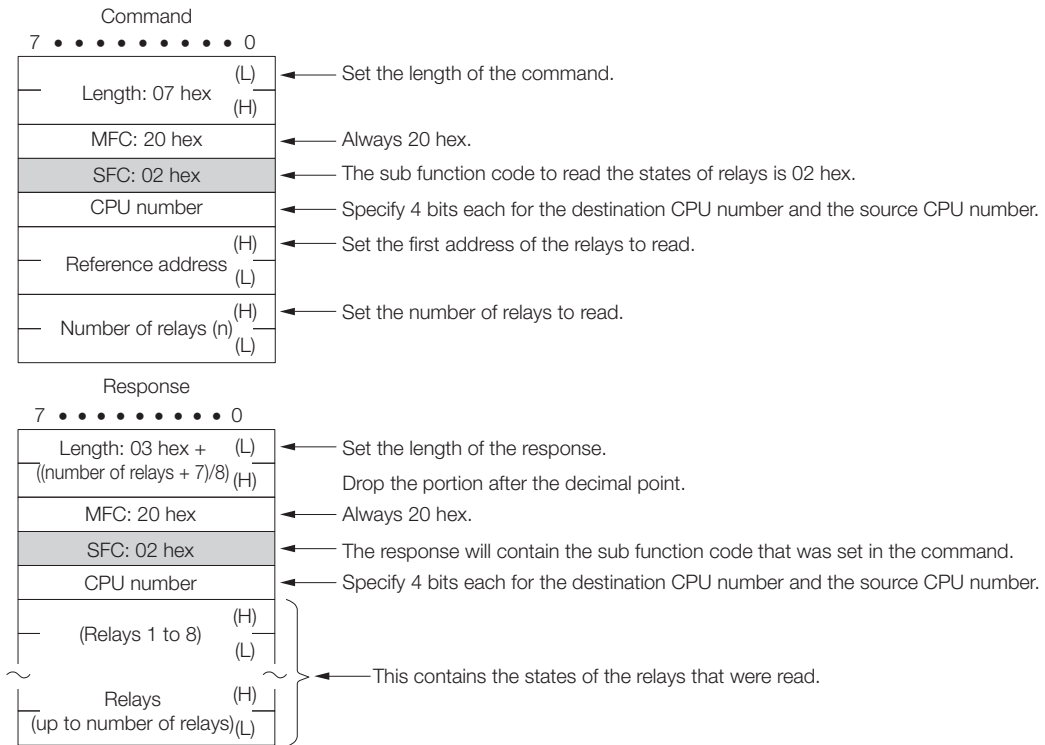

◆ Reading the Contents of Hold Registers

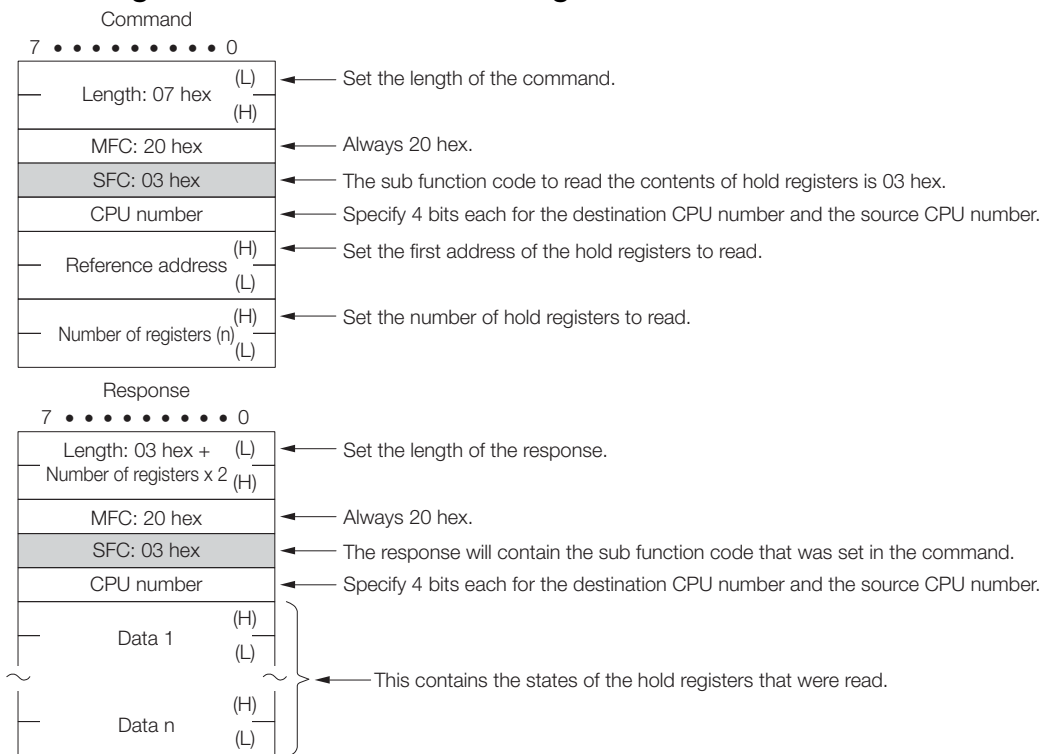

◆ Reading the Contents of Input Registers

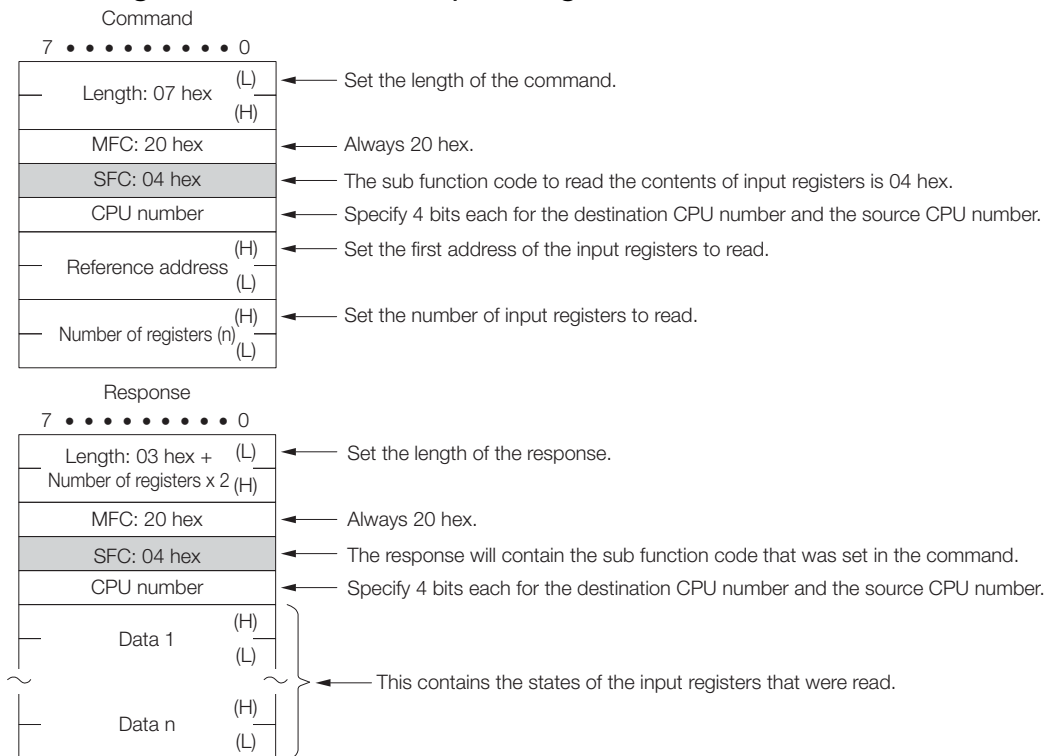

◆ Changing the State of a Single Coil

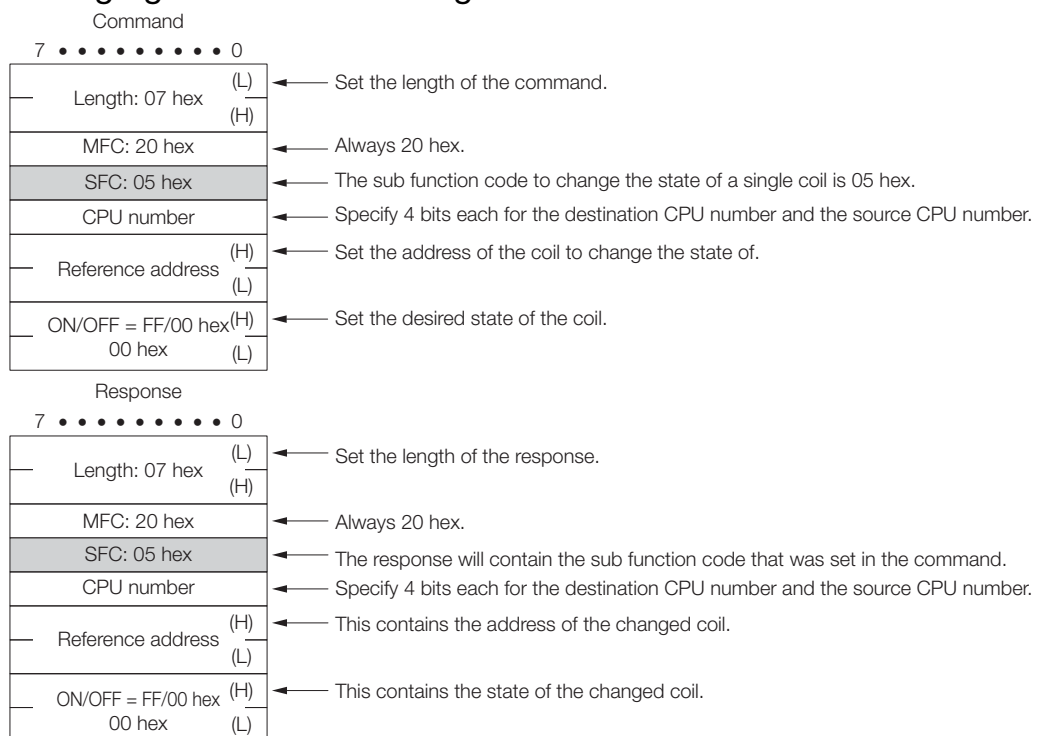

◆ Writing to a Single Hold Register

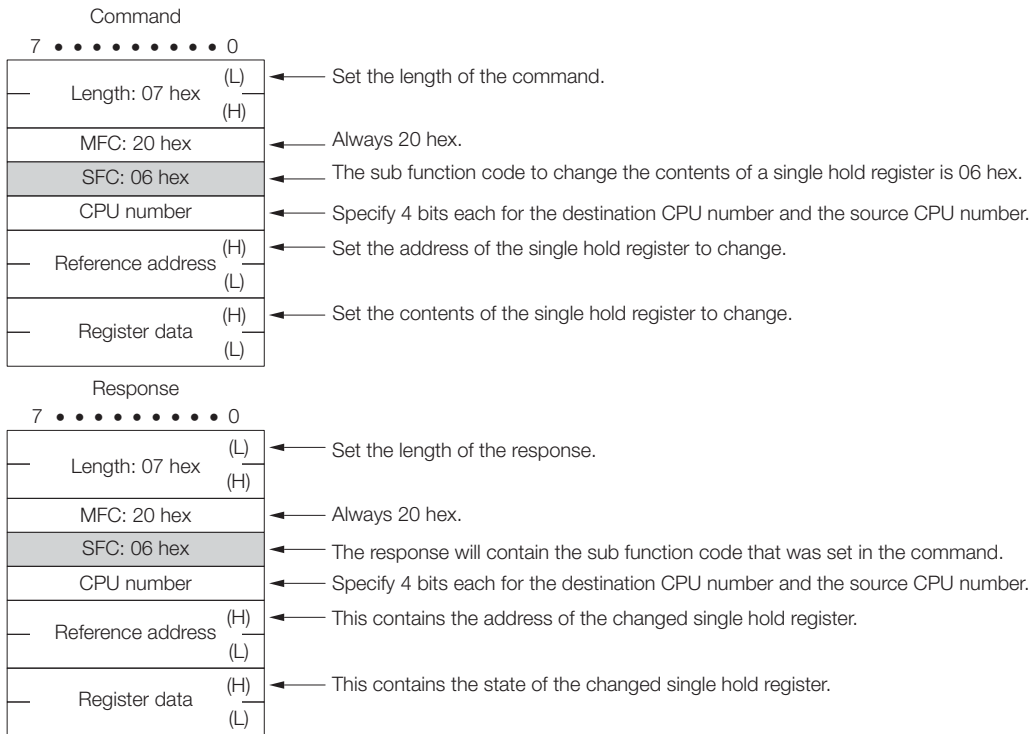

◆ Performing a Loopback Test

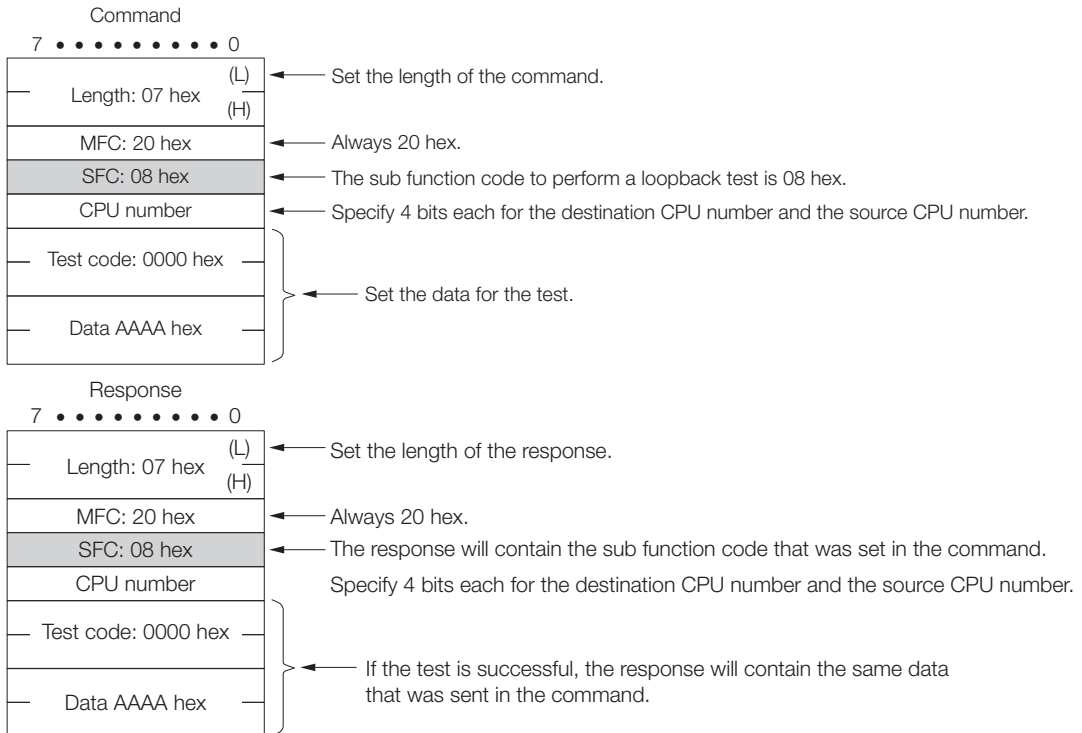

◆ Reading the Contents of Hold Registers (Extended)

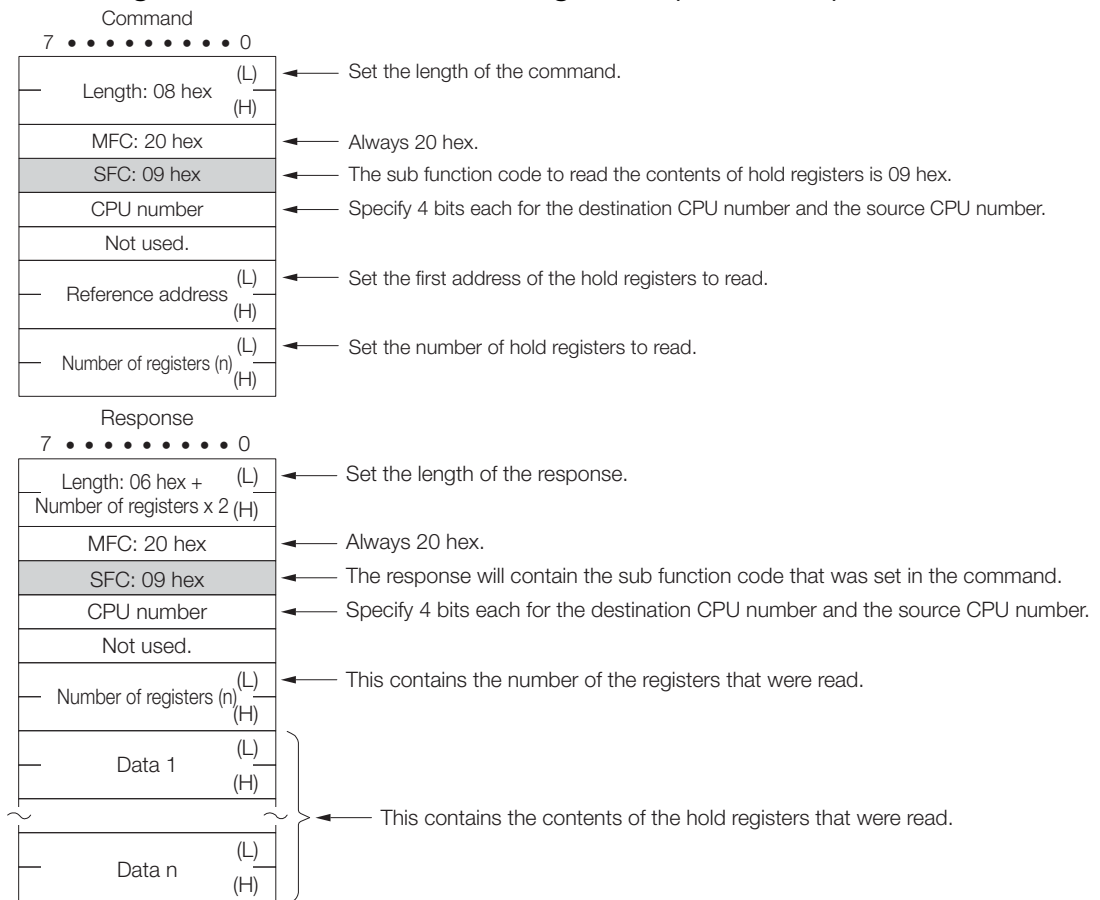

◆ Reading the Contents of Input Registers (Extended)

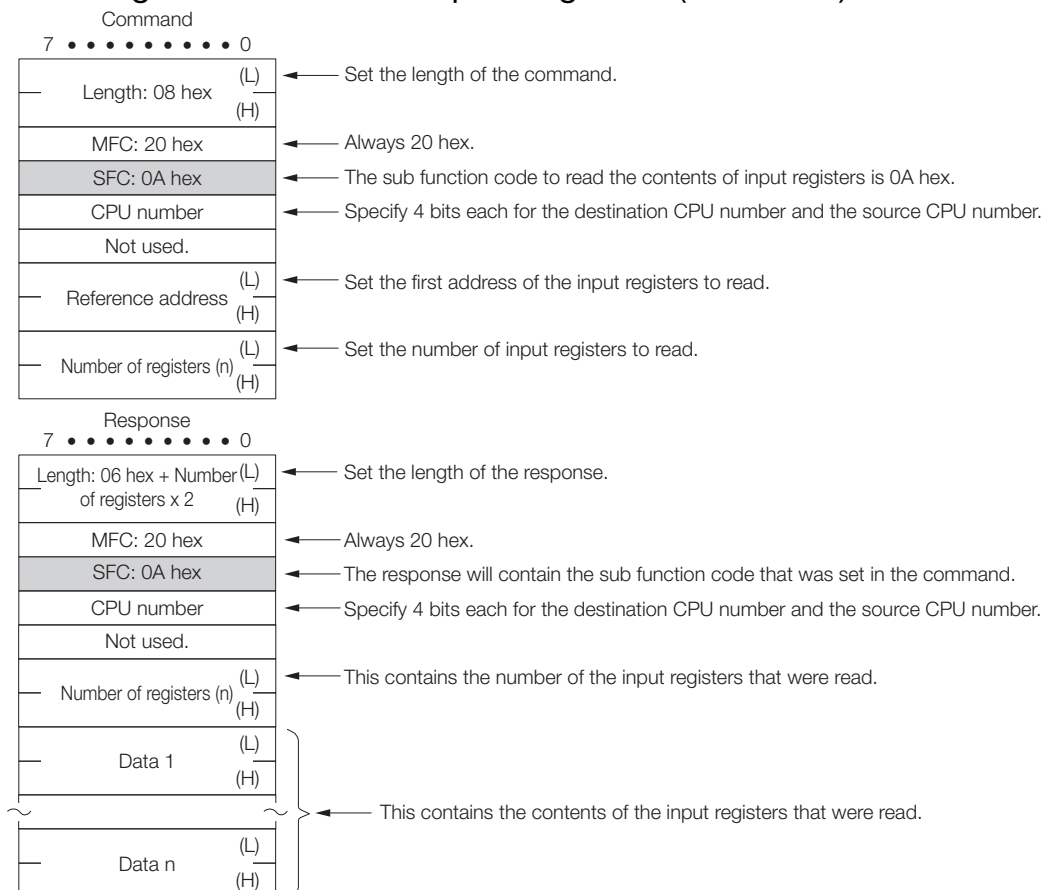

◆ Writing to Hold Registers (Extended)

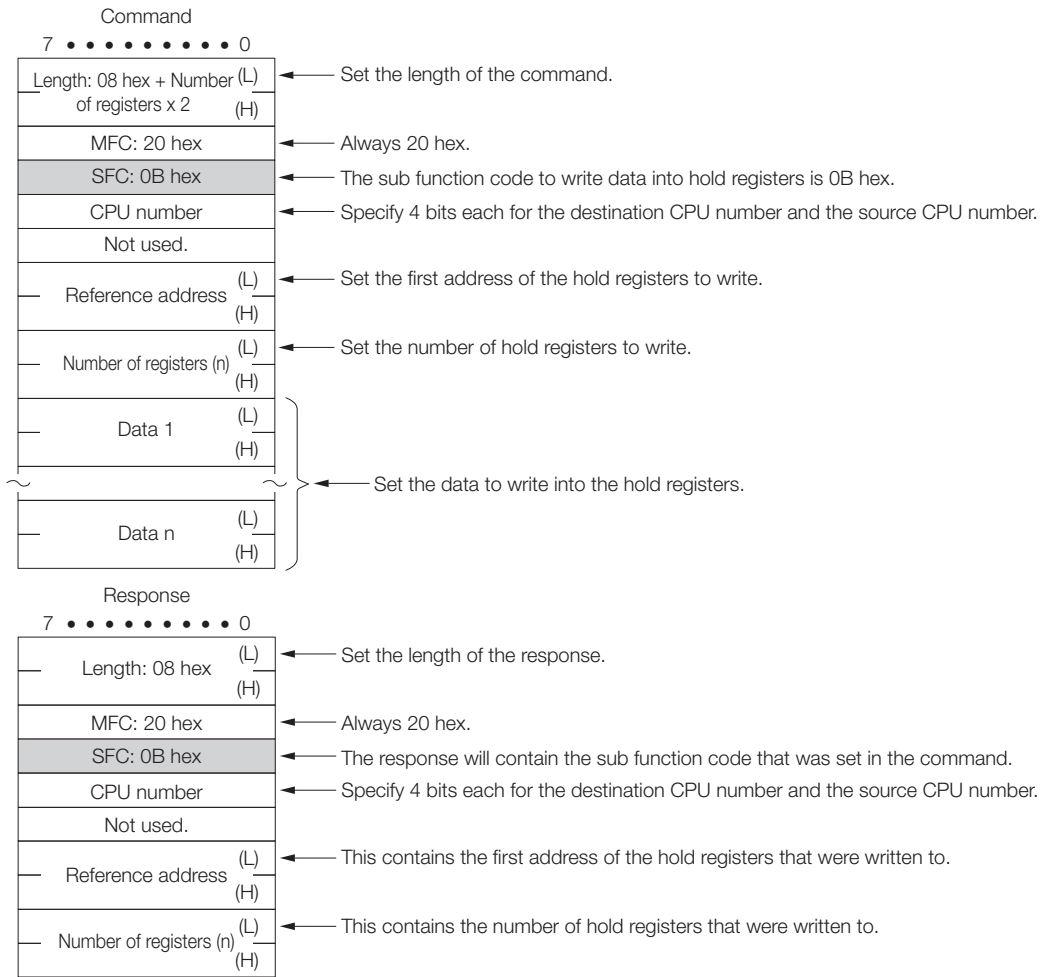

◆ Reading the Contents of Non-consecutive Hold Registers (Extended)

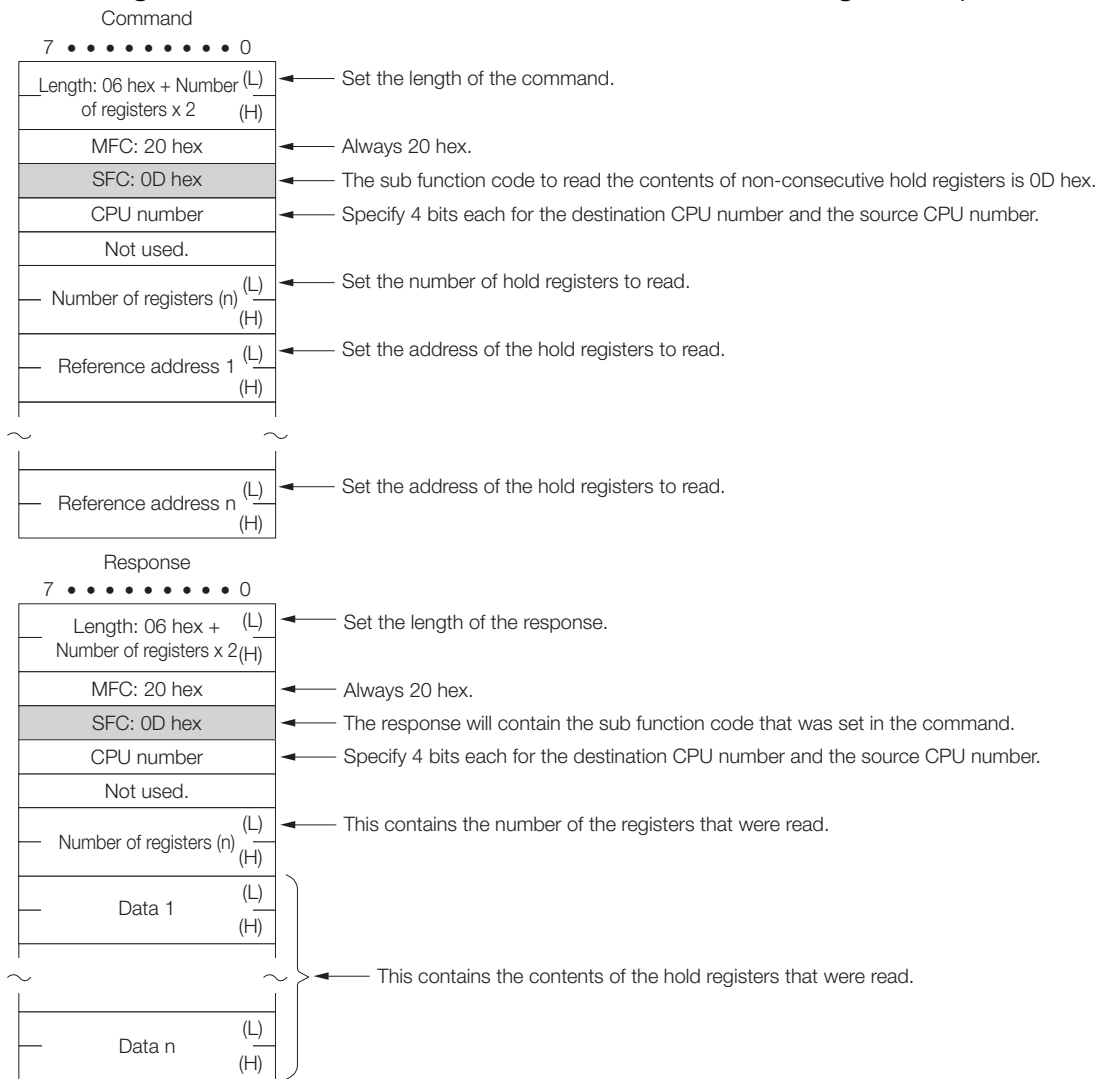

◆ Writing to Non-consecutive Hold Registers (Extended)

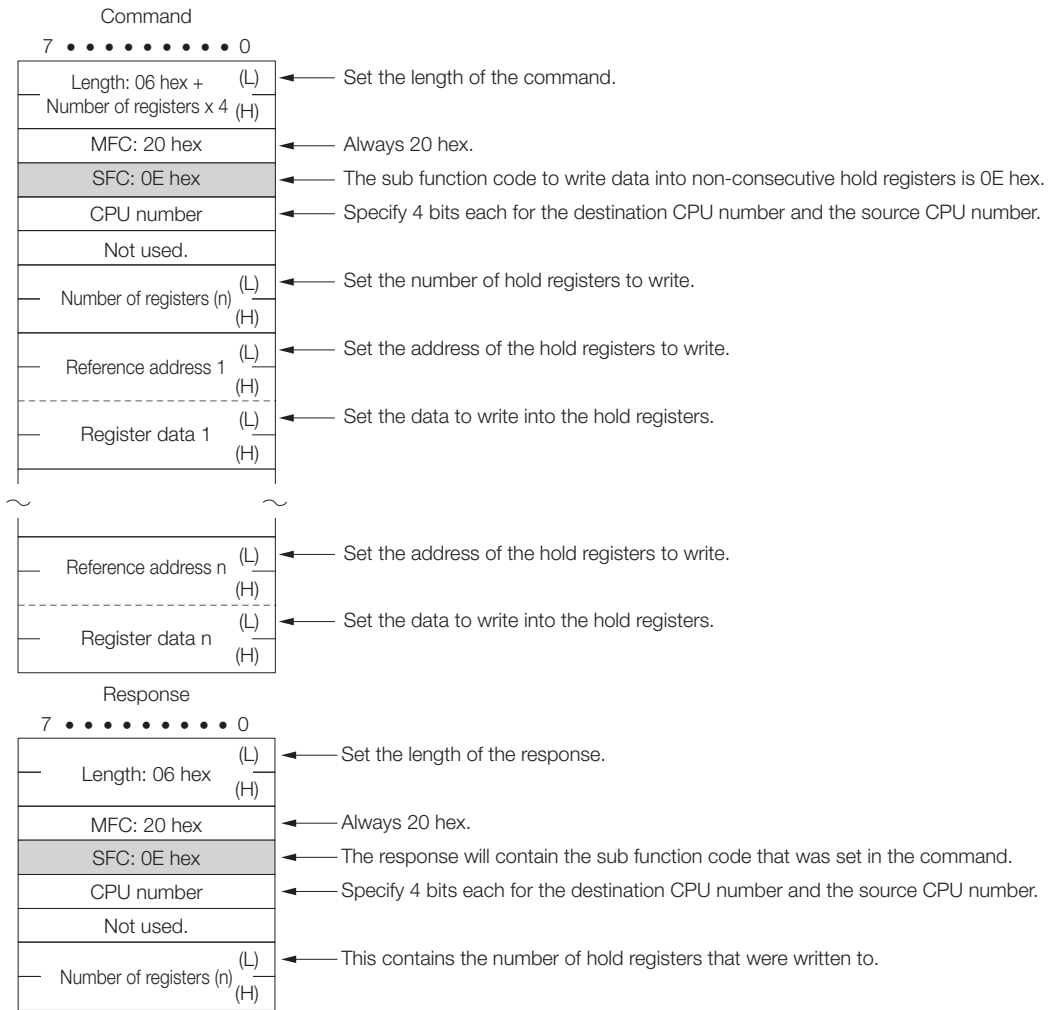

◆ Changing the States of Multiple Coils

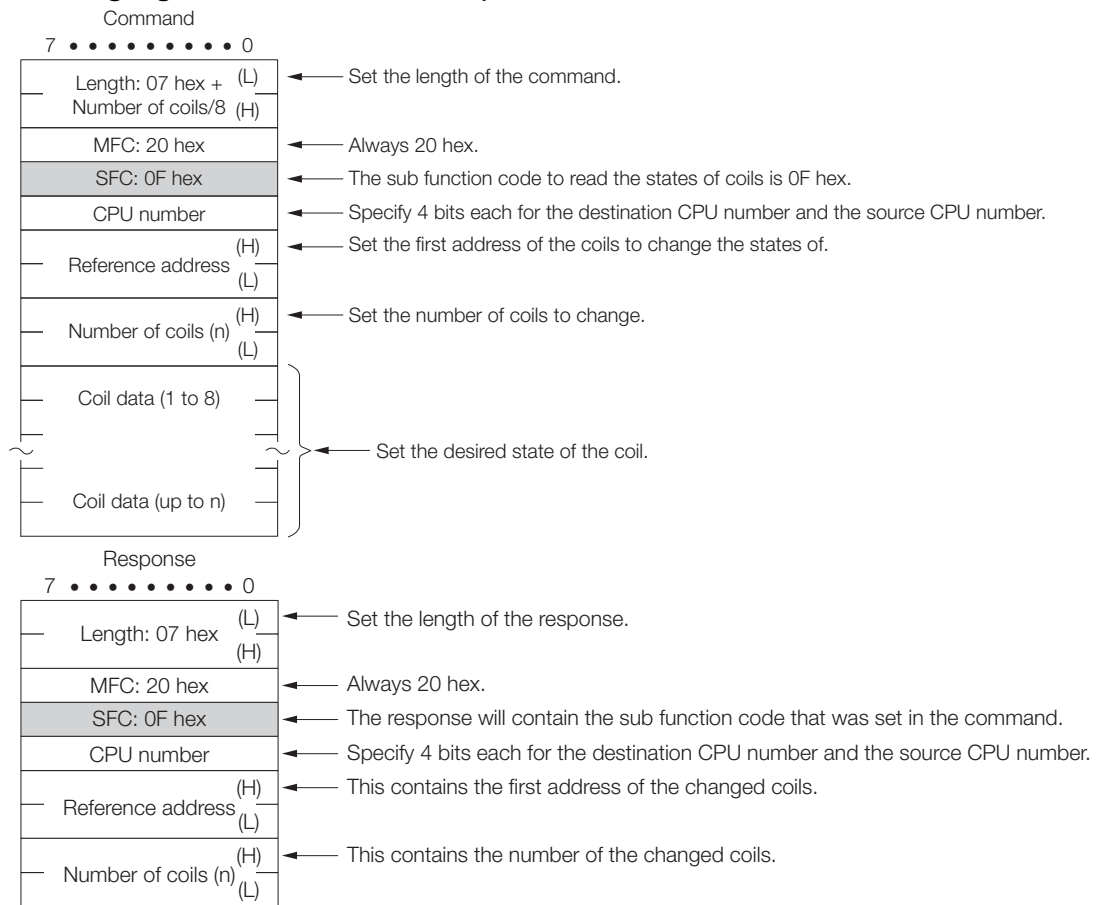

◆ Writing to Multiple Hold Registers

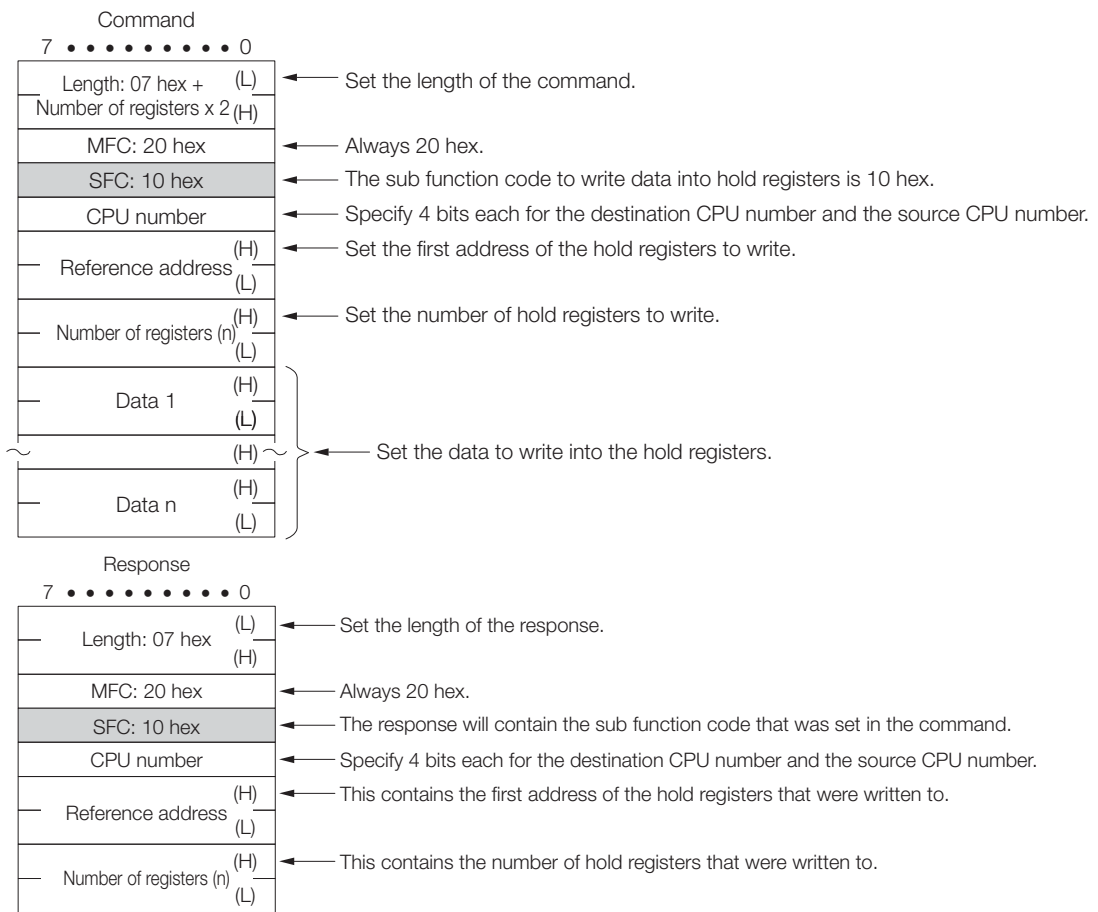

◆ Reading the States of Bits Using 32-bit Addressing

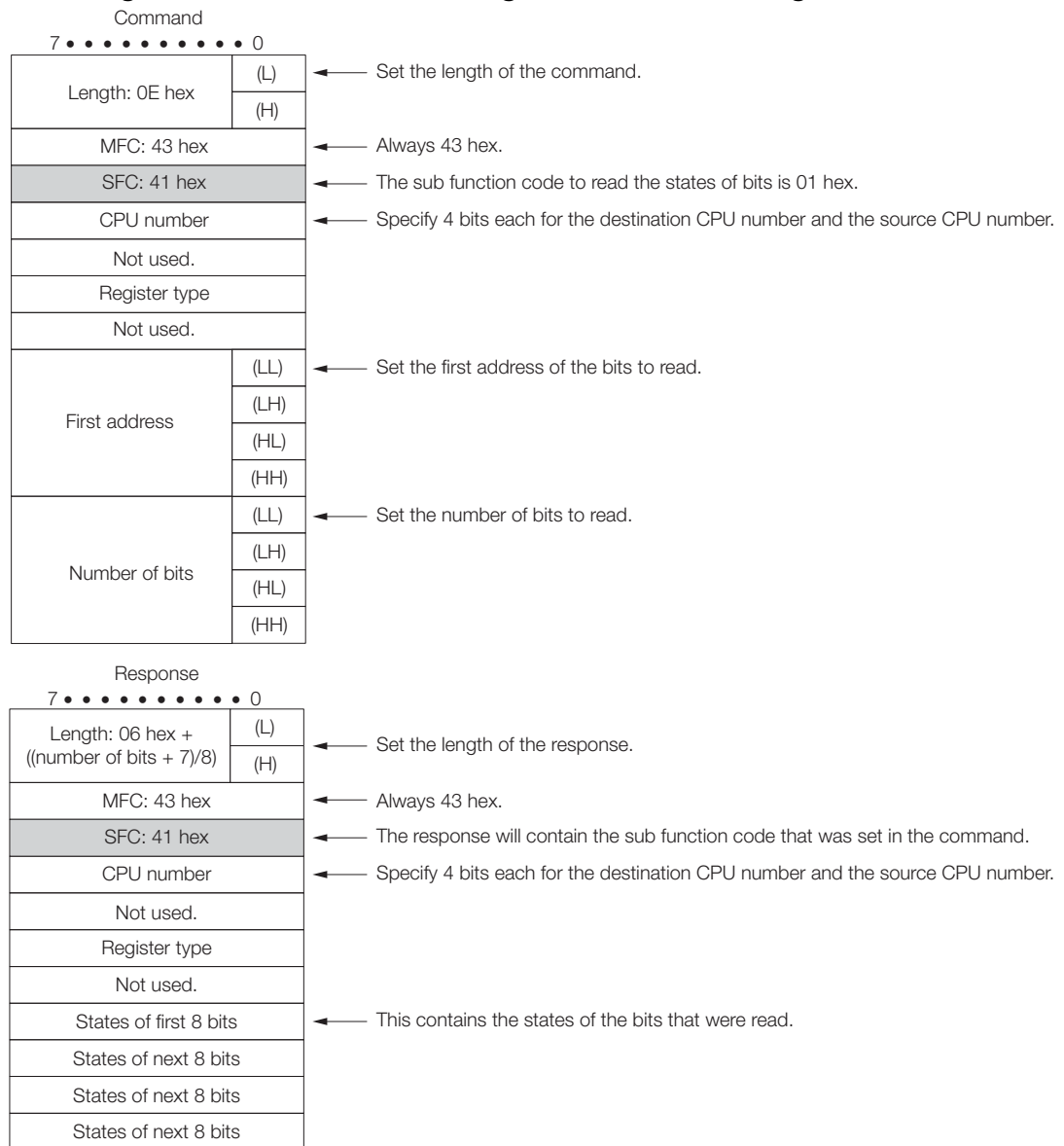

◆ Changing the State of a Single Bit Using 32-bit Addressing

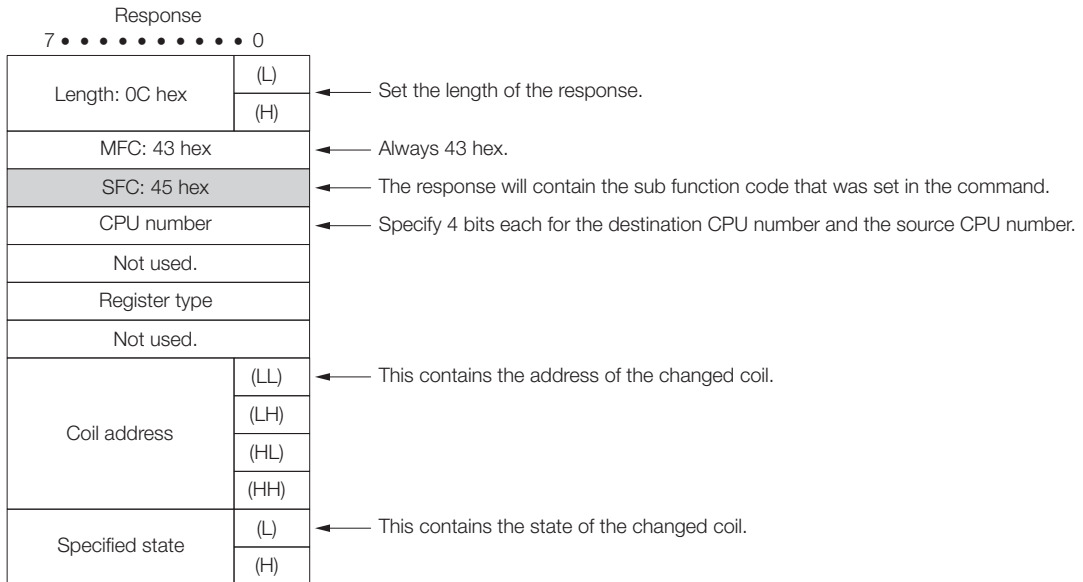
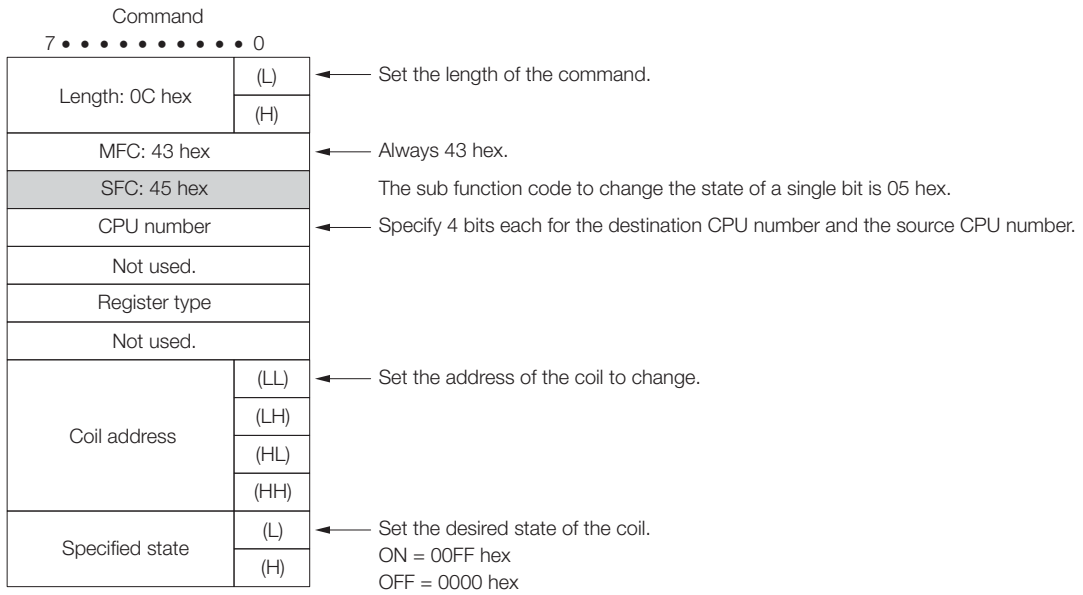

◆ Writing to a Single Register Using 32-bit Addressing

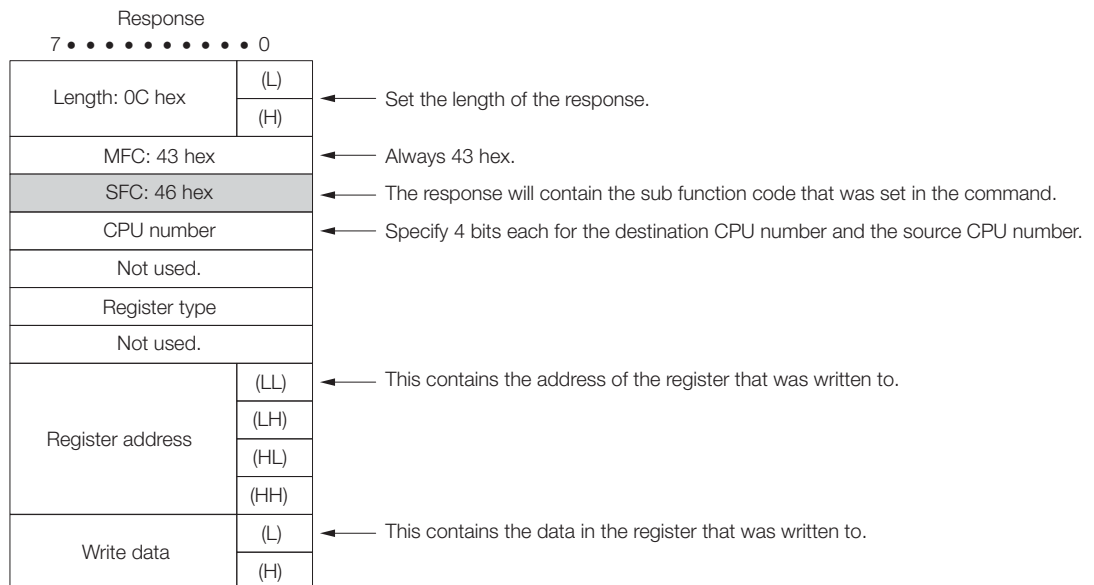
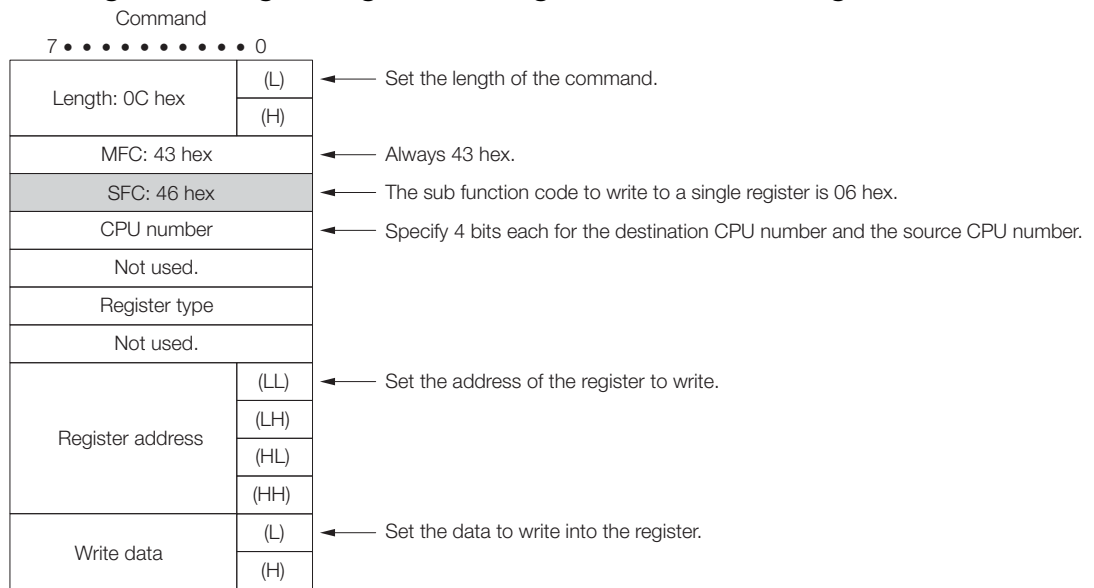

◆ Reading the Contents of Registers Using 32-bit Addressing

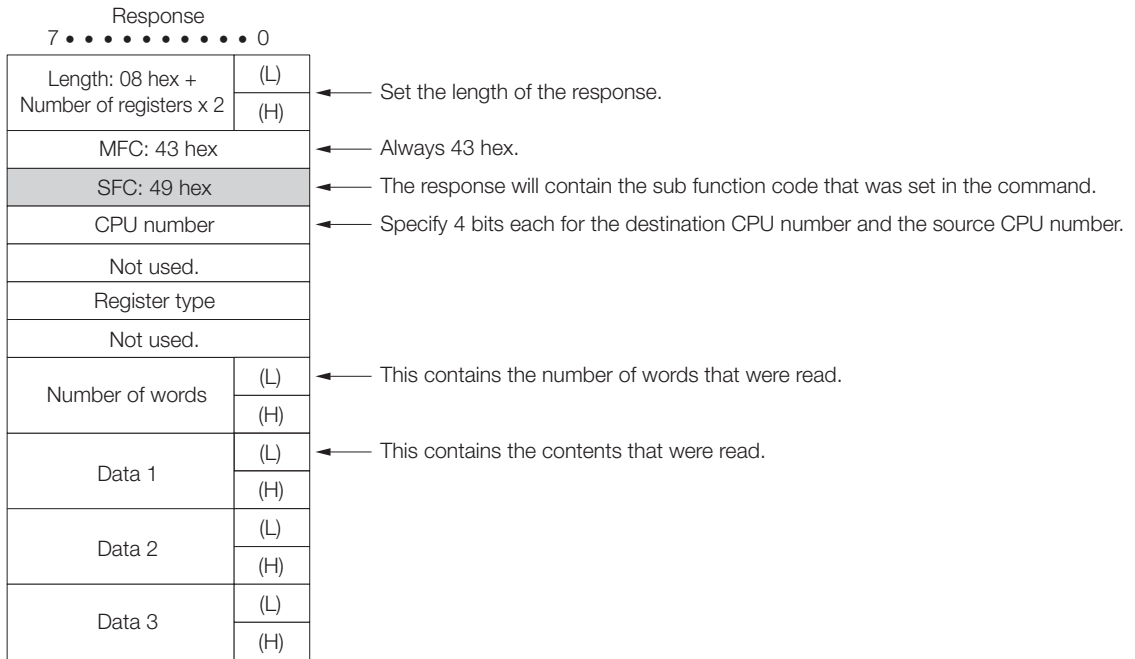
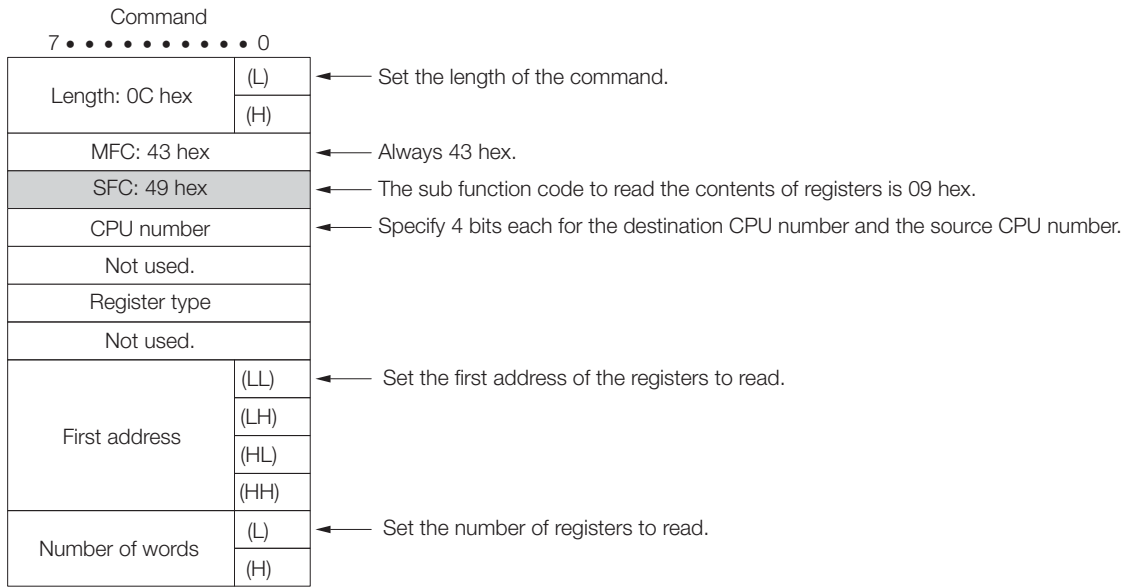

◆ Writing to Non-consecutive Registers Using 32-bit Addressing

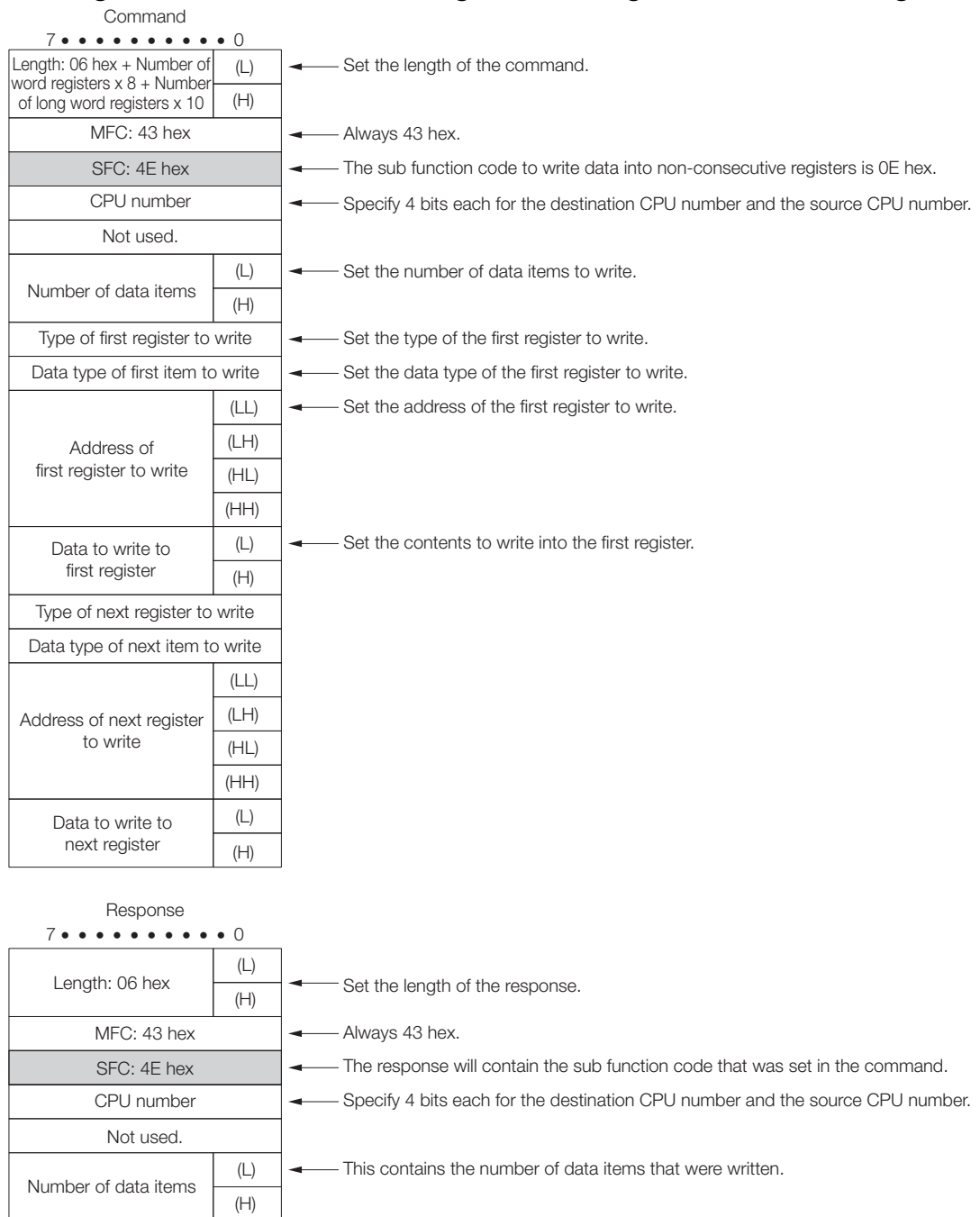

◆ Changing the States of Multiple Bits Using 32-bit Addressing

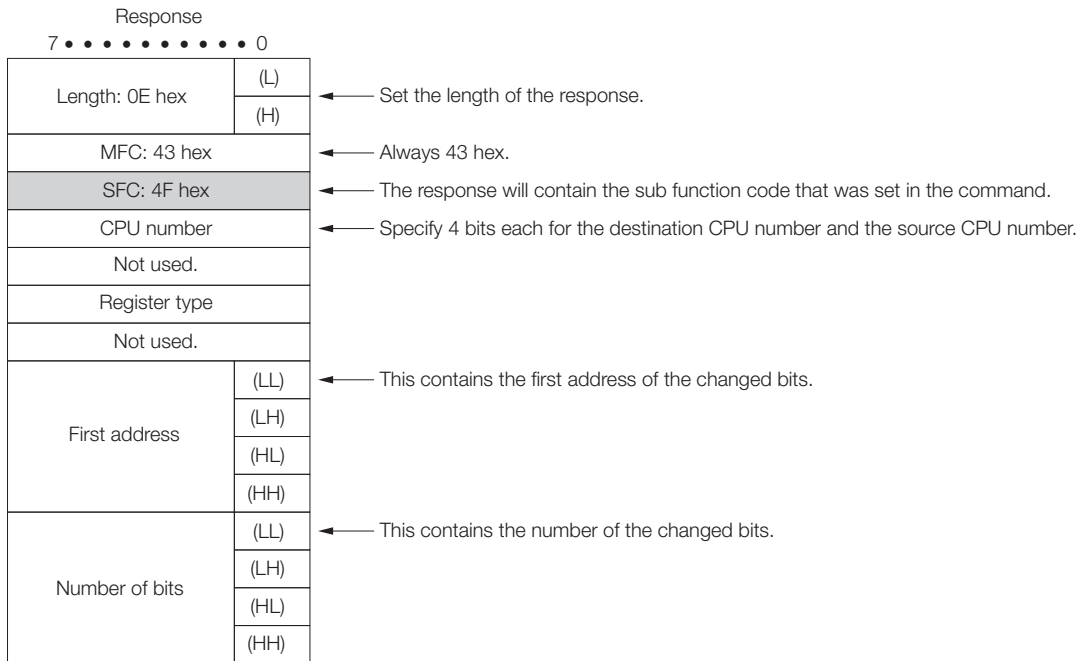
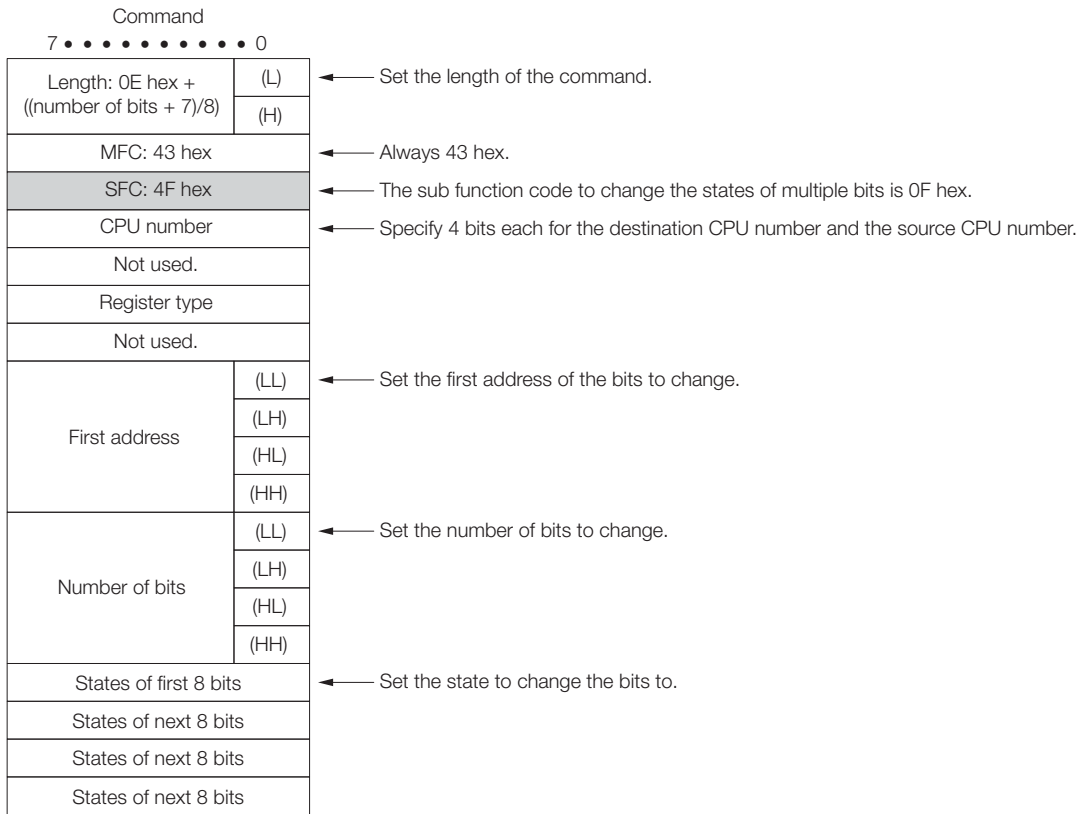

◆ Error Responses

■ Major Function Code of 20 Hex

The following message is returned.

- The sub function code in the command message is illegal.
- The reference address is illegal.
- The number of data items is incorrect.

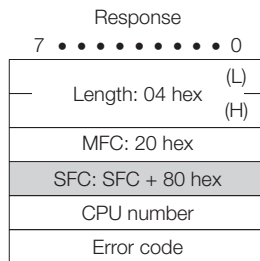
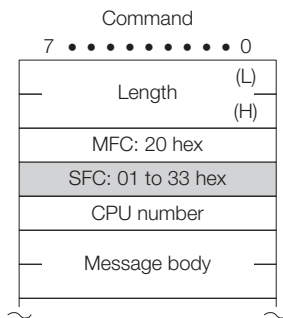

Error code

- 01: SFC error
- 02: Reference address error
- 03: Number of data items error

■ Major Function Code of 43 Hex

The following message is returned.

- The register type is incorrect.
- The command is incorrect for the data type to be accessed.
- The local register type is incorrect.

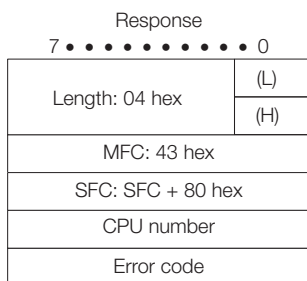
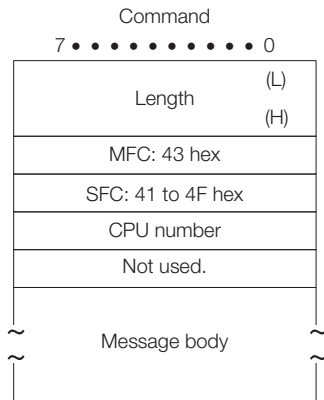

Error code

- 01 hex: SFC error
- 02 hex: Reference address error
- 03 hex: Number of data items error
- 40 hex: Register type error
- 41 hex: Data type error
- 42 hex: Local station register type error

MEMOBUS ASCII Mode

In ASCII Mode, binary data is converted to ASCII before being sent or received.

The following diagram illustrates the conversion from binary to ASCII. As shown in the example, 8-bit data is converted into two 7-bit ASCII characters. The example shows the conversion of only the application data field. In actual conversion, however, the EIF header is also converted to ASCII.

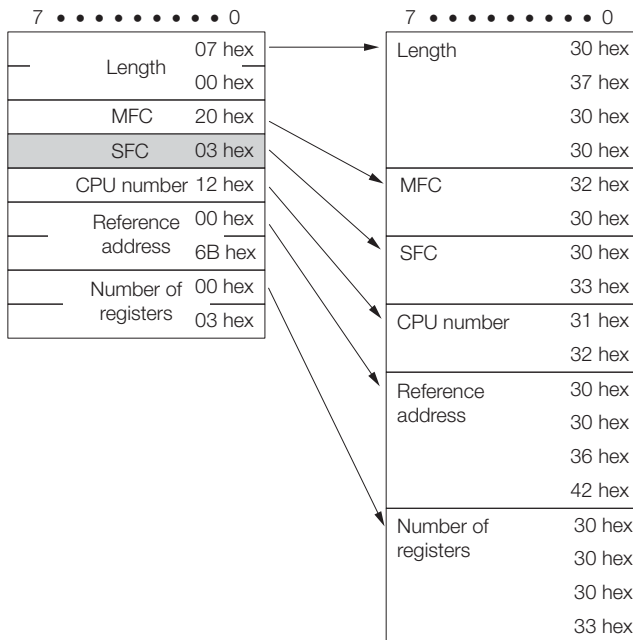

General-purpose Message Binary Mode

In the general-purpose message mode, the values of the MW hold registers in the Machine Controller are sent and received in the application data field that follows the EIF header.

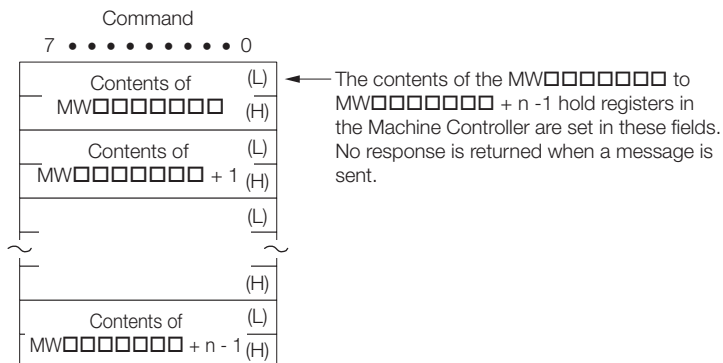

General-purpose Message ASCII Mode

In ASCII Mode, binary data is converted to ASCII before being sent or received.

The following diagram illustrates the conversion from binary to ASCII. As shown in the example, 8-bit data is converted into two 7-bit ASCII characters. The example shows the conversion of only the application data field. In actual conversion, however, the EIF header is also converted to ASCII.

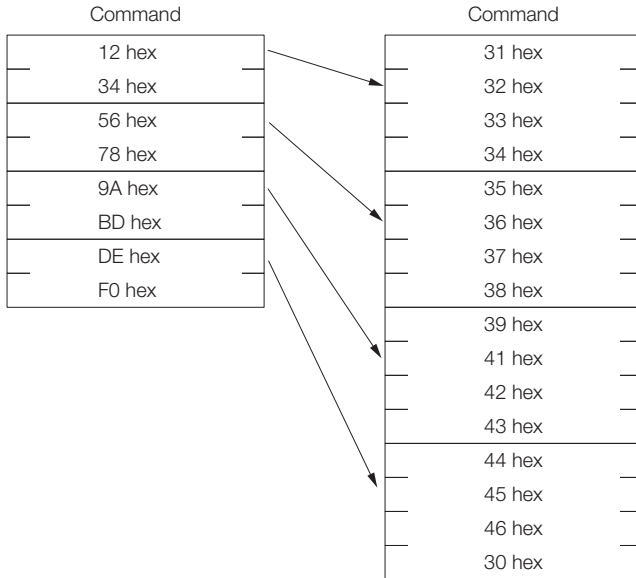

6.4.2 MEMOBUS Protocol

Message Structure

The following message structure is used in communications with 217IF and 218IF Modules. Refer to the following manual for details.

MEMOBUS Descriptive Information Industrial Communication System (Manual No. SIE-C815-13.60)

When the MEMOBUS protocol is used to send and receive data, each message consists of two fields: a header field and the application data field. The 218 header that is used for the Extended MEMOBUS protocol is not used.

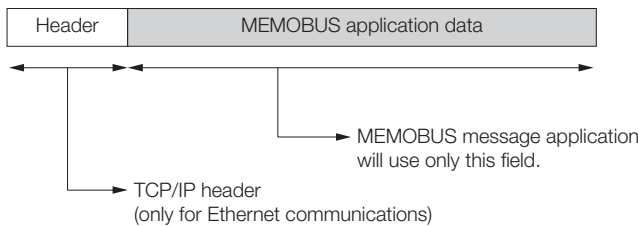

The header is for TCP/IP and UDP/IP connections and is used only for Ethernet communications. User programs do not need to be aware of this header because it is automatically appended and removed in the 218IFD.

When communicating using the 217IF, only the MEMOBUS application data field is sent and received.

The structure for parameters in the application data field is given below. The actual data for the MEMOBUS protocol is stored in the application data field.

Communications Protocols	Code	Reference
MEMOBUS message communications	RTU	MEMOBUS RTU Mode on page 6-49
MEMOBUS message communications	ASCII	MEMOBUS ASCII Mode on page 6-54

Information Whether RTU or ASCII is used for Ethernet communications depends on the code setting for the remote station in the connection parameters. When communicating with a 217IF Module, this is determined by the communications mode setting in the communications parameters. When a message is received in Ethernet communications, neither the CRC-16 in RTU Mode nor the LRC in ASCII Mode are checked. Error checking for received messages is performed using error detection in the TCP, UDP, and IP headers. It is therefore not necessary to calculate the CRC-16 or LRC when sending a message.

◆ MEMOBUS Commands

The commands that make up the MEMOBUS messages are identified by function codes and provide the functions given in the following table.

Function Code	Sub Function Code	Function	Maximum Size (RTU/ASCII)
01 hex	–	Reads the states of coils.	2000 points
02 hex	–	Reads the states of input relays.	2000 points
03 hex	–	Reads the contents of hold registers.	125 words
04 hex	–	Reads the contents of input registers.	125 words
05 hex	–	Changes the state of a single coil.	1 point
06 hex	–	Writes to a single hold register or one word.	1 word
08 hex	–	Performs a loopback test.	–
0F hex	–	Changes the states of multiple coils.	800 points
10 hex	–	Writes to multiple hold registers.	100 words

MEMOBUS RTU Mode

Information When a message is received on a 218IFD Module using the MEMOBUS protocol, the CRC-16 is not checked.

◆ Reading the States of Coils

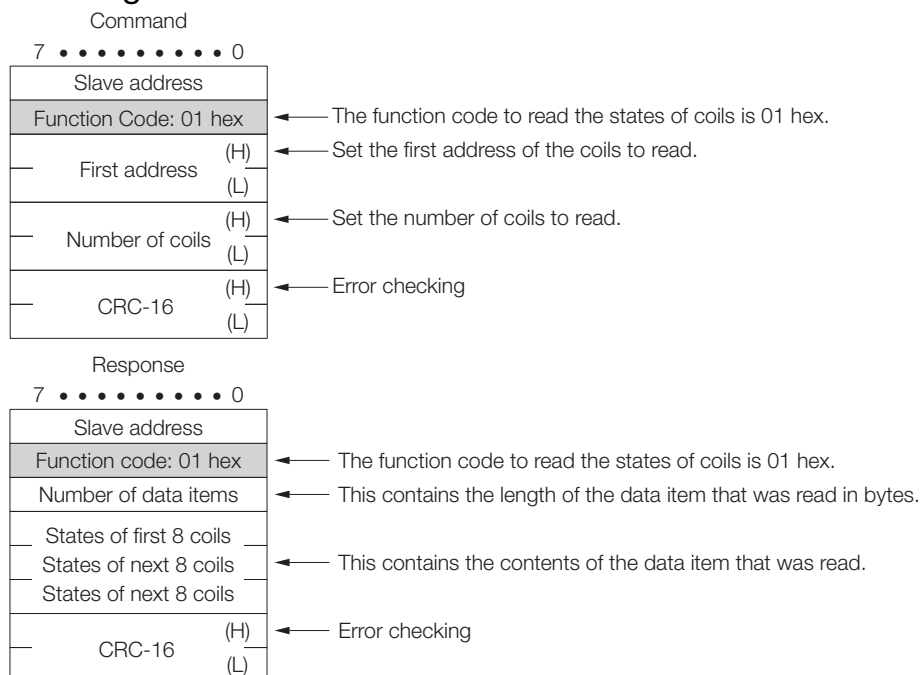

◆ Reading the States of Input Relays

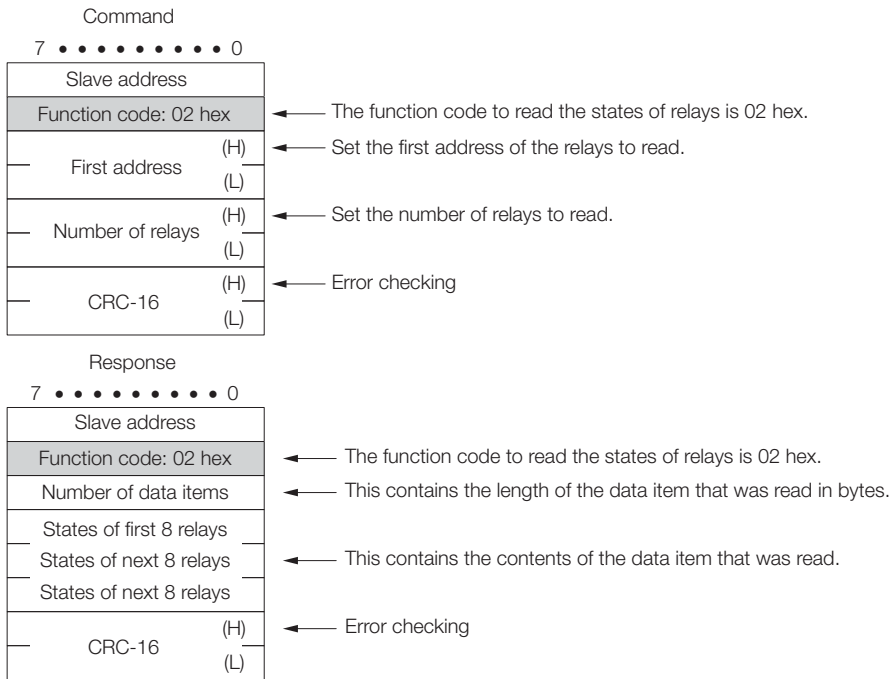

◆ Reading the Contents of Hold Registers

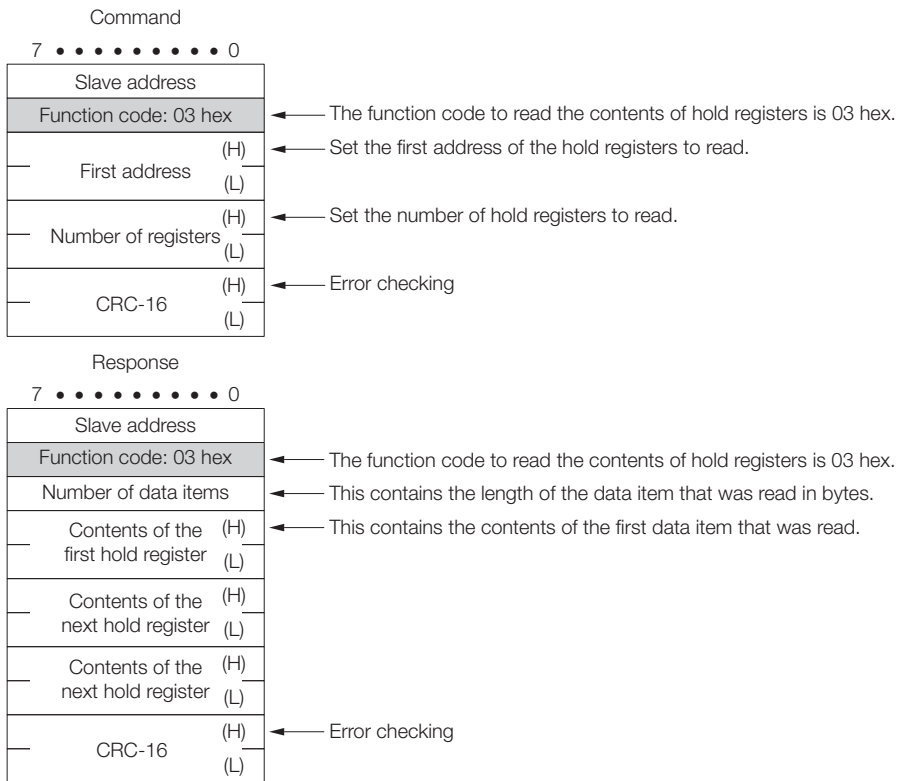

◆ Reading the Contents of Input Registers

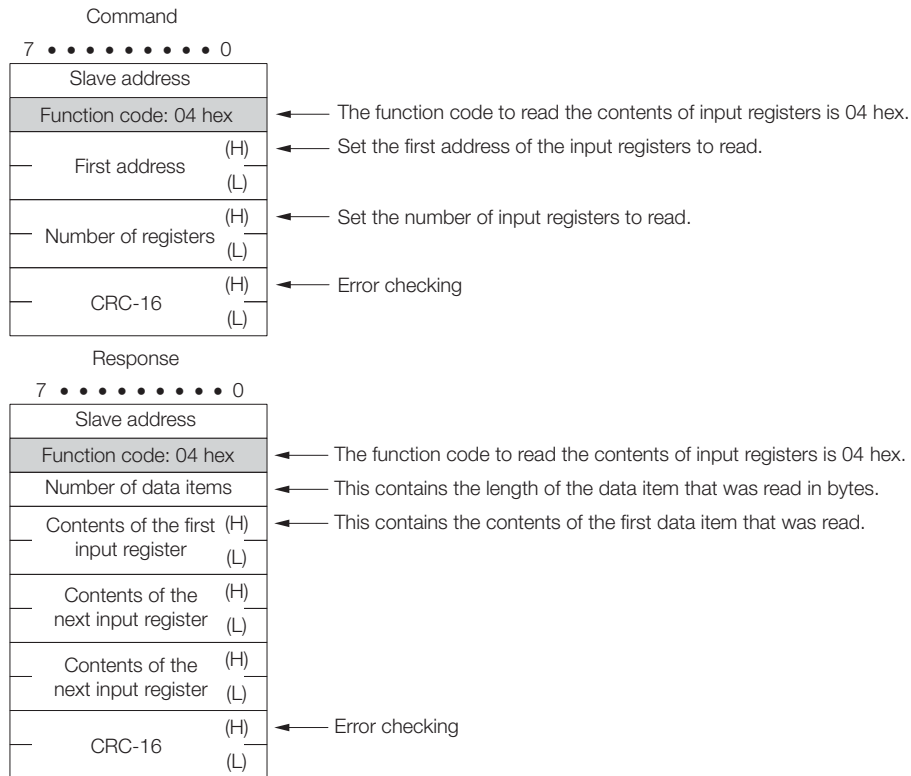

◆ Changing the State of a Single Coil

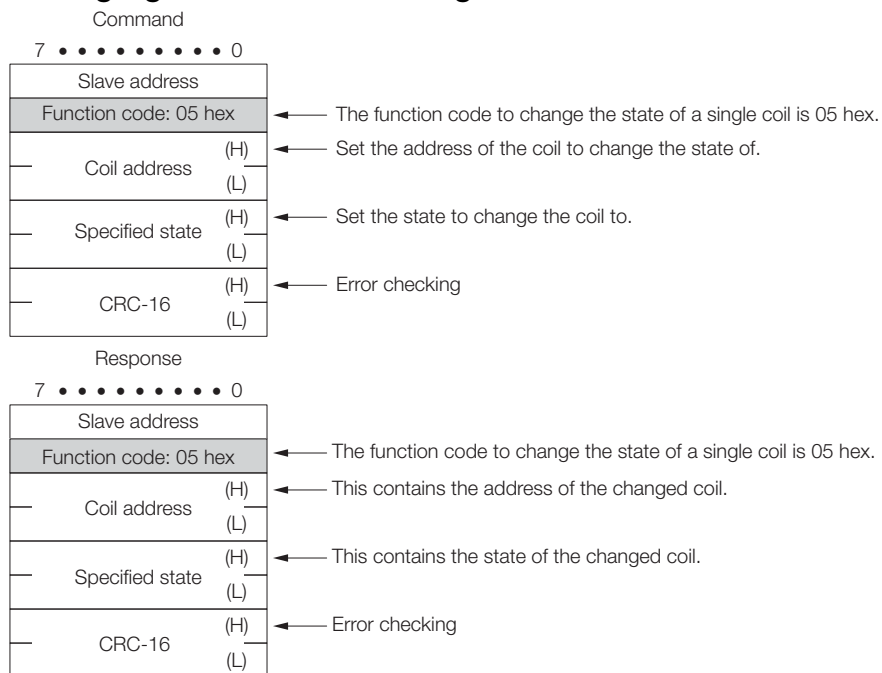

◆ Changing the Contents of a Single Hold Register

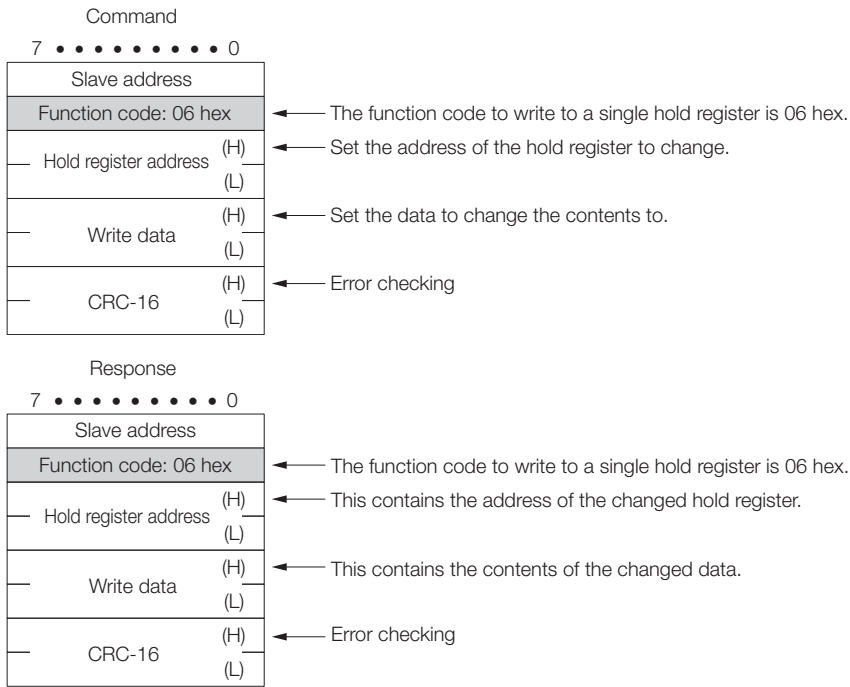

◆ Performing a Loopback Test

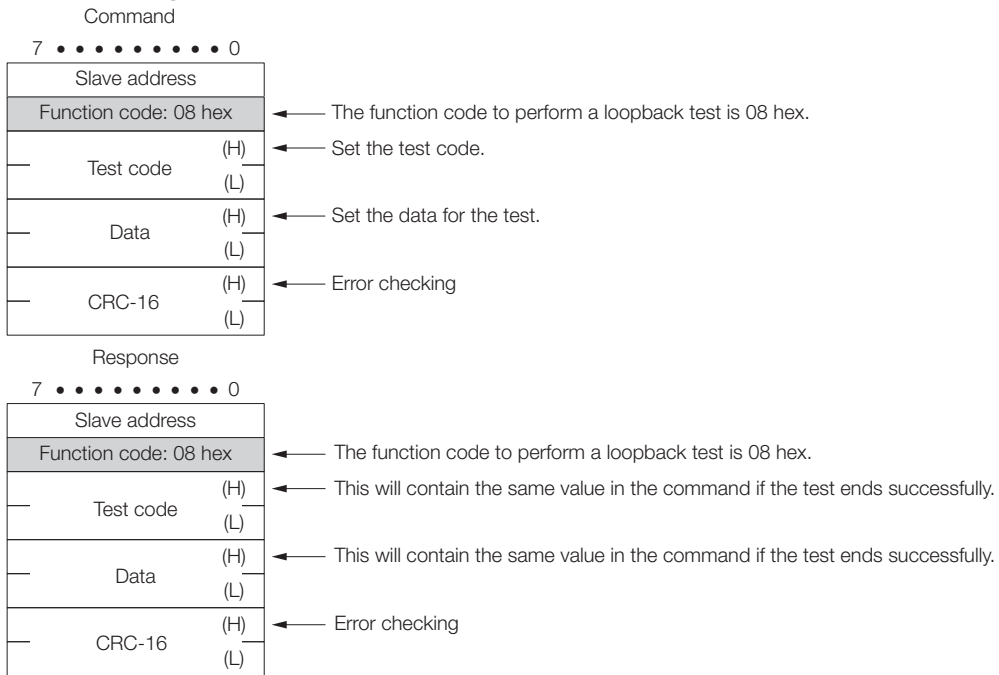

◆ Changing the States of Multiple Coils

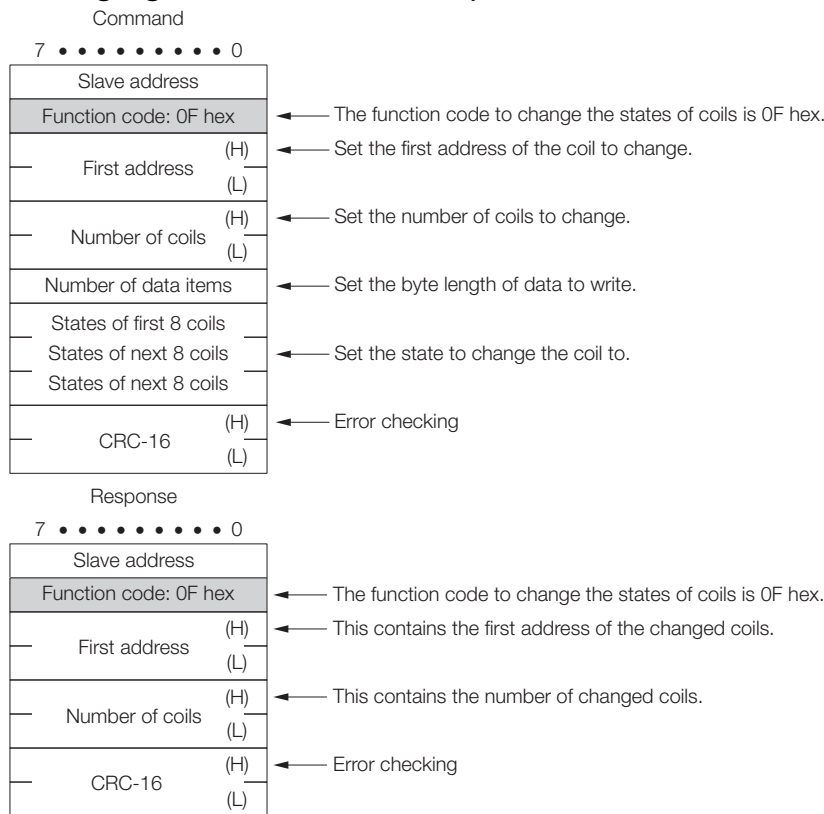

◆ Writing to Multiple Hold Registers

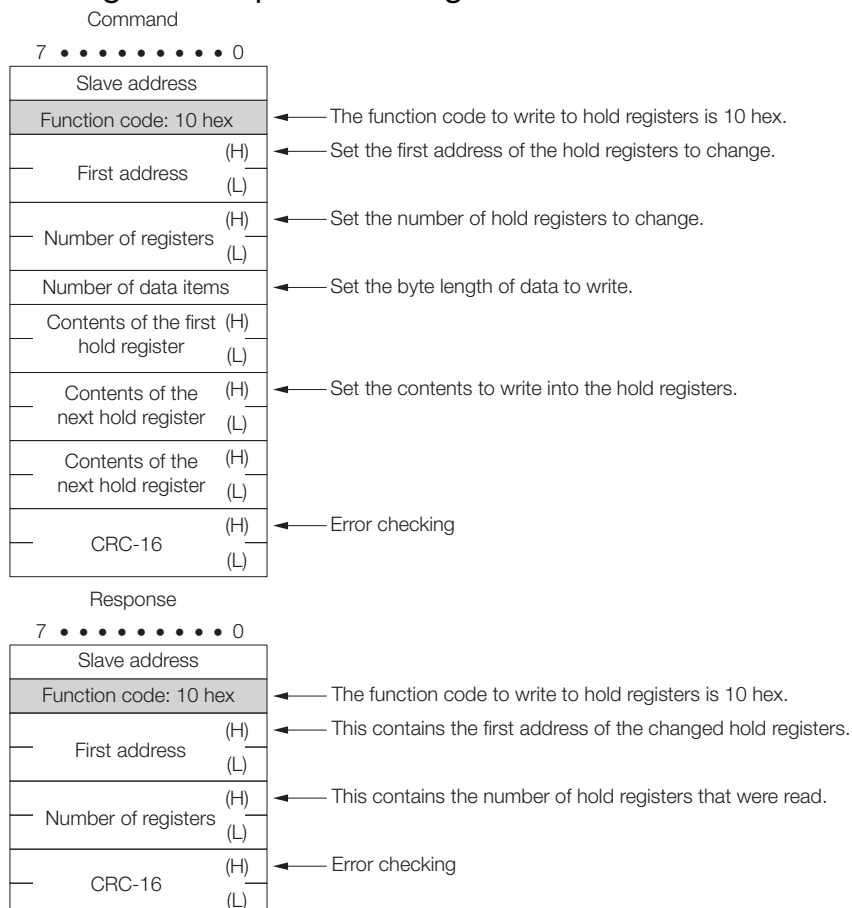

◆ Error Responses

If the command message contains an error, the slave will ignore the requested function and return an error response message.

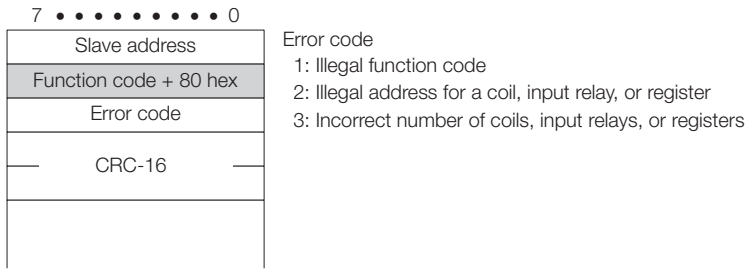

MEMOBUS ASCII Mode

In ASCII Mode, RTU data is converted to ASCII before being sent or received. The following diagram illustrates the conversion from RTU to ASCII. As shown in the example, 8-bit data in the application data field is converted into two 7-bit ASCII characters. In the MEMOBUS format, the code for a “:” is added to the beginning of the data to indicate where the data starts, and the codes “CR” and “LF” are added to the end of the data to indicate where it ends. Error checking is done with the LRC.

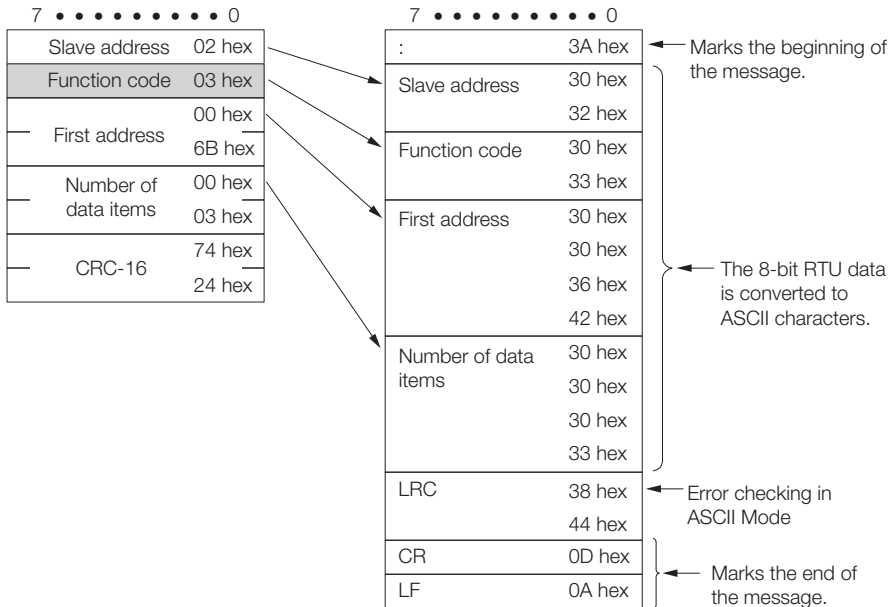

Information When a message is received on a 218IFD Module using the MEMOBUS protocol, the LRC is not checked.

6.4.3 No-Protocol Communications

Message Structure

When no-protocol communications is set as the communications protocol, application data is handled as a general-purpose message. When sending and receiving data, each message consists of two fields: a header and the application data field.

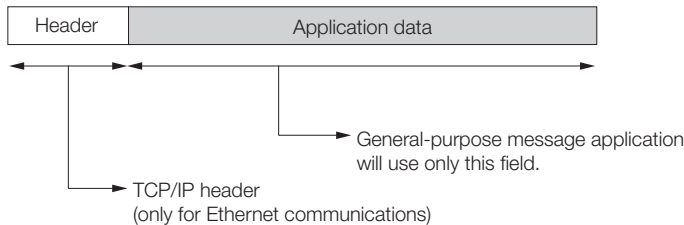

The header is for TCP/IP and UDP/IP connections and is used only for Ethernet communications. User programs do not need to be aware of this header because it is automatically appended and removed in the 218IFD.

The application data field can be formatted as required by the application. The application data field has the following message structure.

Communications Protocols	Code	Reference
No-protocol communications	BIN	<i>General-purpose Binary Mode on page 6-55</i>
No-protocol communications	ASCII	<i>General-purpose ASCII Mode on page 6-56</i>

Information Ethernet communications will use either binary or ASCII data based on the code setting in the connection parameters.

The difference compared to using the general-purpose messaging mode with the Extended MEMOBUS protocol is that the 218 header is not appended before the application data.

◆ General-purpose Message Commands

General-purpose message commands can be set as required by the application.

General-purpose Binary Mode

In no-protocol communications, the values of the MW hold registers in the Machine Controller are sent and received in the application data field.

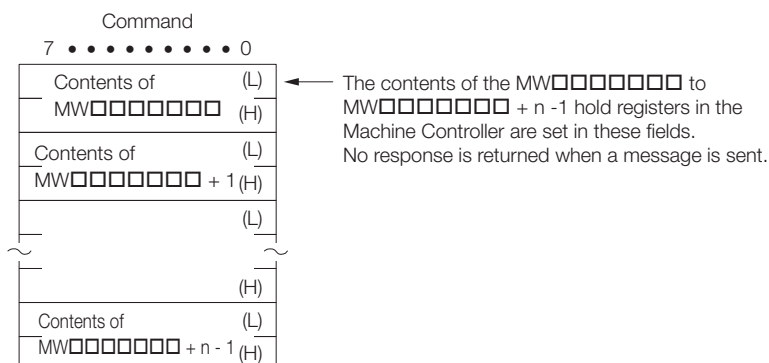

General-purpose ASCII Mode

In ASCII Mode, binary data is converted to ASCII before being sent or received.

The following diagram illustrates the conversion from binary to ASCII. As shown in the example, 8-bit data is converted into two 7-bit ASCII characters.

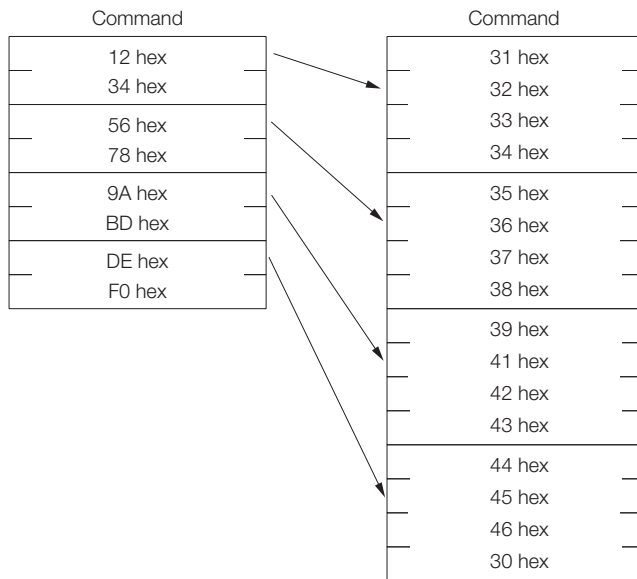

Index

Numerics

218 header - - - - - 6-26
218IFD - - - - - 6-2

A

Abort - - - - - 2-6, 2-21
A-compatible 1E frame protocol - - - - - 4-55

B

Busy - - - - - 2-7, 2-22

C

Ch-No - - - - - 2-6, 2-22
circuit number - - - - - 2-6, 2-21
Cir-No - - - - - 2-6, 2-21
communications buffer channel number - - - - - 2-6, 2-22
communications device type - - - - - 2-6
communications protocol - - - - - 2-6, 2-21
communications with a JTEKT PLC
 message functions - - - - - 4-214
 inputs and outputs for the MSG-RCVE
 function - - - - - 4-219
 inputs and outputs for the MSG-SNDE
 function - - - - - 4-214
 MSG-RCVE function parameters - - - - - 4-220
 MSG-SNDE function parameters - - - - - 4-215
 using automatic reception with the MP3000
 as a slave - - - - - 4-188
 using automatic reception with the MP3000 as a slave
 communications format - - - - - 4-188
 file memory and corresponding registers in
 the MP3000 - - - - - 4-189
 MP3000 setup - - - - - 4-191
 setting example - - - - - 4-190
 setting the remote device (JTEKT PLC) - - - - - 4-194
 starting communications - - - - - 4-195
 transfer size - - - - - 4-189
 using the MSG-RCVE function with the MP3000
 as a slave - - - - - 4-196
 communications format - - - - - 4-196
 file memory and corresponding registers in
 the MP3000 - - - - - 4-196
 MP3000 setup - - - - - 4-198
 setting example - - - - - 4-197
 setting the remote device (JTEKT PLC) - - - - - 4-202
 starting communications - - - - - 4-204
 transfer size - - - - - 4-197

 using the MSG-SNDE function with the MP3000
 as the master - - - - - 4-205
 communications format - - - - - 4-205
 file memory and corresponding registers in
 the MP3000 - - - - - 4-205
 MP3000 setup - - - - - 4-207
 setting example - - - - - 4-206
 setting the remote device (JTEKT PLC) - - - - - 4-211
 starting communications - - - - - 4-213
 transfer size - - - - - 4-206

communications with a KOYO PLC
 message functions - - - - - 4-179
 inputs and outputs for the MSG-RCVE
 function - - - - - 4-184
 inputs and outputs for the MSG-SNDE
 function - - - - - 4-179
 MSG-RCVE function parameters - - - - - 4-185
 MSG-SNDE function parameters - - - - - 4-180
 using automatic reception with the MP3000
 as a slave - - - - - 4-164
 MP3000 setup - - - - - 4-165
 setting example - - - - - 4-164
 setting the remote device (KOYO PLC) - - - - - 4-167
 starting communications - - - - - 4-168
 using I/O message communications with
 the MP3000 as the master - - - - - 4-169
 MP3000 setup - - - - - 4-170
 setting example - - - - - 4-169
 setting the remote device (KOYO PLC) - - - - - 4-171
 starting communications - - - - - 4-172
 using MSG-SNDE function with the MP3000
 as the master
 MP3000 setup - - - - - 4-174
 setting example - - - - - 4-173
 setting the remote device (KOYO PLC) - - - - - 4-177
 starting communications - - - - - 4-178
 using the MSG-SNDE function with the MP3000
 as the master - - - - - 4-173
communications with a Mitsubishi PLC
(A-compatible 1C frame protocol)
 message functions - - - - - 5-36
 inputs and outputs for the MSG-SNDE
 function - - - - - 5-36
 MSG-SNDE function parameters - - - - - 5-37
 using the MSG-SNDE function with the MP3000
 as the master
 MP3000 setup - - - - - 5-30
 setting example - - - - - 5-30
 setting up the remote device (Mitsubishi PLC) - - - - - 5-33
 starting communications - - - - - 5-35

- communications with a Mitsubishi PLC (A-compatible 1E frame protocol)
 - message functions - - - - - 4-70
 - inputs and outputs for the MSG-RCVE function - - - - - 4-77
 - inputs and outputs for the MSG-SNDE function - - - - - 4-70
 - MSG-RCVE function parameters - - - - - 4-78
 - MSG-SNDE function parameters - - - - - 4-71
 - using automatic reception with the MP3000
 - as a slave - - - - - 4-55
 - MP3000 setup - - - - - 4-56
 - setting example - - - - - 4-55
 - setting up the remote device (Mitsubishi PLC) - - - - - 4-58
 - starting communications - - - - - 4-58
 - using I/O message communications with the MP3000
 - as the master - - - - - 4-59
 - MP3000 setup - - - - - 4-60
 - setting example - - - - - 4-59
 - setting up the remote device (Mitsubishi Q/A-series PLC) - - - - - 4-62
 - starting communications - - - - - 4-63
 - using the MSG-SNDE function with the MP3000
 - as the master - - - - - 4-64
 - MP3000 setup - - - - - 4-65
 - setting example - - - - - 4-64
 - setting up the remote device (Mitsubishi Q/A-series PLC) - - - - - 4-69
 - starting communications - - - - - 4-69
- communications with a Mitsubishi PLC (QnA-compatible 3E frame protocol)
 - message functions - - - - - 4-101
 - inputs and outputs for the MSG-RCVE function - - - - - 4-109
 - inputs and outputs for the MSG-SNDE function - - - - - 4-101
 - MSG-RCVE function parameters - - - - - 4-110
 - MSG-SNDE function parameters - - - - - 4-102
 - using I/O message communications with the MP3000 as the master - - - - - 4-84
 - using the I/O message communications with the MP3000 as the master
 - device memory and corresponding registers in the MP3000 - - - - - 4-84
 - MP3000 setup - - - - - 4-86
 - QnA-compatible 3E frame commands - - - - - 4-84
 - setting example - - - - - 4-86
 - setting up the remote device (Mitsubishi Q/QnA-series PLC) - - - - - 4-88
 - starting communications - - - - - 4-89
 - transfer size - - - - - 4-85
 - using the MSG-SNDE function with the MP3000
 - as the master - - - - - 4-90
 - device memory and corresponding registers in the MP3000 - - - - - 4-90
 - MP3000 setup - - - - - 4-94
 - QnA-compatible 3E frame commands - - - - - 4-90
 - setting example - - - - - 4-93
 - setting up the remote device (Mitsubishi PLC) - - - - - 4-99
 - starting communications - - - - - 4-100
 - transfer size - - - - - 4-93
- communications with a touch panel
 - using automatic reception with the MP3000
 - as a slave - - - - - 4-48
 - MP3000 setup - - - - - 4-49
 - setting example - - - - - 4-48
 - setting up the touch panel - - - - - 4-52
 - starting communications - - - - - 4-54
- communications with an OMRON PLC
 - message functions - - - - - 4-151, 5-46
 - inputs and outputs for the MSG-RCVE function - - - - - 4-157
 - inputs and outputs for the MSG-SNDE function - - - - - 4-151, 5-46
 - MSG-RCVE function parameters - - - - - 4-158
 - MSG-SNDE function parameters - - - - - 4-152, 5-47
 - routing - - - - - 4-149
 - using the MP3000 as a router - - - - - 4-150
 - using the MP3000 as a slave - - - - - 4-150
 - using the MP3000 as the master - - - - - 4-149
 - using automatic reception with the MP3000
 - as a slave - - - - - 4-117
 - FINS commands - - - - - 4-117
 - I/O memory data areas and corresponding registers in the MP3000 - - - - - 4-118
 - MP3000 setup - - - - - 4-120
 - setting example - - - - - 4-119
 - setting the remote device (OMRON PLC) - - - - - 4-123
 - starting communications - - - - - 4-124
 - transfer size - - - - - 4-118
 - using I/O message communications with the MP3000 as the master - - - - - 4-134
 - FINS commands - - - - - 4-134
 - I/O memory data areas and corresponding registers in the MP3000 - - - - - 4-135
 - MP3000 setup - - - - - 4-137
 - setting example - - - - - 4-136
 - setting the remote device (OMRON PLC) - - - - - 4-139
 - starting communications - - - - - 4-140
 - transfer size - - - - - 4-135
 - using the MSG-RCVE function with the MP3000
 - as a slave - - - - - 4-125
 - FINS commands - - - - - 4-125
 - I/O memory data areas and corresponding registers in the MP3000 - - - - - 4-125
 - MP3000 setup - - - - - 4-128
 - setting example - - - - - 4-127
 - setting the remote device (OMRON PLC) - - - - - 4-132
 - starting communications - - - - - 4-134
 - transfer size - - - - - 4-126

- using the MSG-SNDE function with the MP3000
 - as the master - - - - - 4-140
 - I/O memory data areas and corresponding registers in the MP3000 - - - - - 4-140
 - MP3000 setup - - - - - 4-143, 5-42
 - setting example - - - - - 4-142, 5-41
 - setting the remote device (OMRON PLC) - - - - - 4-148
 - setting up the remote device (OMRON PLC) - - - - - 5-44
 - starting communications - - - - - 4-149, 5-45
 - transfer size - - - - - 4-141
 - communications with MP-series controllers
 - message functions - - - - - 4-39
 - inputs and outputs for the MSG-RCVE function - - - - - 2-20, 4-44, 5-26
 - inputs and outputs for the MSG-SNDE function - - - - - 2-5, 4-39, 5-22
 - MSG-RCVE function parameters - - - - - 2-24, 4-45, 5-27
 - MSG-SNDE function parameters - - - - - 2-9, 4-40, 5-23
 - using automatic reception with the MP3000
 - as a slave - - - - - 4-3
 - MP3000 setup - - - - - 4-5, 5-4
 - setting example - - - - - 4-4
 - setting up the remote device (MP2300) - - - - - 4-8
 - setting up the remote device (MP2310) - - - - - 5-5
 - starting communications - - - - - 4-12, 5-8
 - using I/O message communications with the MP3000
 - as the master - - - - - 4-23
 - MP3000 setup - - - - - 4-24
 - setting example - - - - - 4-23
 - setting up the remote device (MP2310) - - - - - 4-27
 - starting communications - - - - - 4-30
 - using the MSG-RCVE function with the MP3000
 - as a slave - - - - - 4-13
 - MP3000 setup - - - - - 4-14, 5-10
 - setting example - - - - - 4-13
 - setting up the remote device (MP2300) - - - - - 4-18
 - setting up the remote device (MP2310) - - - - - 5-13
 - starting communications - - - - - 4-22, 5-15
 - using the MSG-SNDE function with the MP3000
 - as the master - - - - - 4-31
 - MP3000 setup - - - - - 4-33, 5-17
 - setting example - - - - - 4-32
 - setting up the remote device (MP2310) - - - - - 4-37, 5-20
 - starting communications - - - - - 4-38, 5-21
- Complete - - - - - 2-7, 2-23
- D**
- data size - - - - - 2-16
 - data types - - - - - 6-27
 - details on protocols
 - extended MEMOBUS protocol - - - - - 6-25
 - general-purpose message ASCII mode - - - - - 6-48
 - general-purpose message binary mode - - - - - 6-47
 - MEMOBUS ASCII mode - - - - - 6-47
 - MEMOBUS binary mode - - - - - 6-27
 - message structure - - - - - 6-25
 - MEMOBUS protocol - - - - - 6-48
 - MEMOBUS ASCII mode - - - - - 6-54
 - MEMOBUS RTU mode - - - - - 6-49
 - message structure - - - - - 6-48
 - no-protocol communications - - - - - 6-55
 - general-purpose ASCII mode - - - - - 6-56
 - general-purpose binary mode - - - - - 6-55
 - message structure - - - - - 6-55
 - Dev-Typ - - - - - 2-6, 2-21
- E**
- Error - - - - - 2-8, 2-23
 - Execute - - - - - 2-5, 2-20
 - extended MEMOBUS commands - - - - - 6-26
 - extended MEMOBUS protocol - - - - - 4-3, 4-48, 6-25
- F**
- FINS commands - - - - - 4-117, 4-134
 - first address of parameter list - - - - - 2-7, 2-22
- I**
- inputs and outputs for the MSG-RCVE function - - - - - 4-44, 5-26
 - inputs and outputs for the MSG-SNDE function - - - - - 4-39, 5-22
- M**
- MEMOBUS commands - - - - - 6-49
 - MEMOBUS protocol - - - - - 6-48
 - message functions - - - - - 4-39, 5-22
- P**
- Param - - - - - 2-7, 2-22
 - processing result - - - - - 2-9
 - Pro-Typ - - - - - 2-6, 2-21
- Q**
- QnA-compatible 3E frame protocol - - - - - 4-84
- R**
- register types - - - - - 6-27
 - RESULT - - - - - 2-10, 2-26, 2-36, 2-44
- U**
- using message functions
 - function codes - - - - - 6-7
 - using function codes - - - - - 6-8

Revision History

The date of publication, revision number, and web revision number are given at the bottom right of the back cover. Refer to the following example.

MANUAL NO. SIEP C880725 35A <1>-0
Published in Japan June 2020

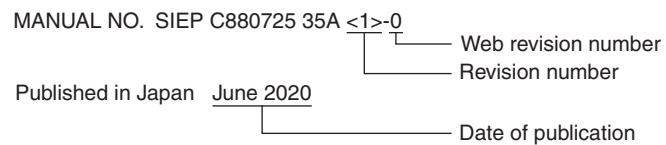

Web revision number
Revision number
Date of publication

Date of Publication	Rev. No.	Web Rev. No.	Section	Revised Contents
June 2020	-	-	-	First edition

Machine Controller MP3000 Series

Message Communications

USER'S MANUAL

IRUMA BUSINESS CENTER (SOLUTION CENTER)

480, Kamifujisawa, Iruma, Saitama, 358-8555, Japan
Phone: +81-4-2962-5151 Fax: +81-4-2962-6138
www.yaskawa.co.jp

YASKAWA AMERICA, INC.

2121, Norman Drive South, Waukegan, IL 60085, U.S.A.
Phone: +1-800-YASKAWA (927-5292) or +1-847-887-7000 Fax: +1-847-887-7310
www.yaskawa.com

YASKAWA ELÉTRICO DO BRASIL LTDA.

777, Avenida Piraporinha, Diadema, São Paulo, 09950-000, Brasil
Phone: +55-11-3585-1100 Fax: +55-11-3585-1187
www.yaskawa.com.br

YASKAWA EUROPE GmbH

Hauptstraße 185, 65760 Eschborn, Germany
Phone: +49-6196-569-300 Fax: +49-6196-569-398
www.yaskawa.eu.com E-mail: info@yaskawa.eu.com

YASKAWA ELECTRIC KOREA CORPORATION

35F, Three IFC, 10 Gukjegeumyung-ro, Yeongdeungpo-gu, Seoul, 07326, Korea
Phone: +82-2-784-7844 Fax: +82-2-784-8495
www.yaskawa.co.kr

YASKAWA ASIA PACIFIC PTE. LTD.

30A, Kallang Place, #06-01, 339213, Singapore
Phone: +65-6282-3003 Fax: +65-6289-3003
www.yaskawa.com.sg

YASKAWA ELECTRIC (THAILAND) CO., LTD.

59, 1F-5F, Flourish Building, Soi Ratchadapisek 18, Ratchadapisek Road, Huaykwang, Bangkok, 10310, Thailand
Phone: +66-2-017-0099 Fax: +66-2-017-0799
www.yaskawa.co.th

YASKAWA ELECTRIC (CHINA) CO., LTD.

22F, Link Square 1, No.222, Hubin Road, Shanghai, 200021, China
Phone: +86-21-5385-2200 Fax: +86-21-5385-3299
www.yaskawa.com.cn

YASKAWA ELECTRIC (CHINA) CO., LTD. BEIJING OFFICE

Room 1011, Tower W3 Oriental Plaza, No.1, East Chang An Avenue,
Dong Cheng District, Beijing, 100738, China
Phone: +86-10-8518-4086 Fax: +86-10-8518-4082

YASKAWA ELECTRIC TAIWAN CORPORATION

12F, No. 207, Section 3, Beishin Road, Shindian District, New Taipei City 23143, Taiwan
Phone: +886-2-8913-1333 Fax: +886-2-8913-1513 or +886-2-8913-1519
www.yaskawa.com.tw

YASKAWA

YASKAWA ELECTRIC CORPORATION

In the event that the end user of this product is to be the military and said product is to be employed in any weapons systems or the manufacture thereof, the export will fall under the relevant regulations as stipulated in the Foreign Exchange and Foreign Trade Regulations. Therefore, be sure to follow all procedures and submit all relevant documentation according to any and all rules, regulations and laws that may apply.

Specifications are subject to change without notice for ongoing product modifications and improvements.

© 2020 YASKAWA ELECTRIC CORPORATION

MANUAL NO. SIEP C880725 35A

Published in Japan June 2020

19-10-16

Original instructions