

Σ -7-Series AC Servo Drive Σ -7S SERVOPACK with 400V-Input Power and EtherCAT (CoE) Communications References FT/EX Specification ZONE Outputs Product Manual

Model: SGD7S-□□□DA0B□□□F64

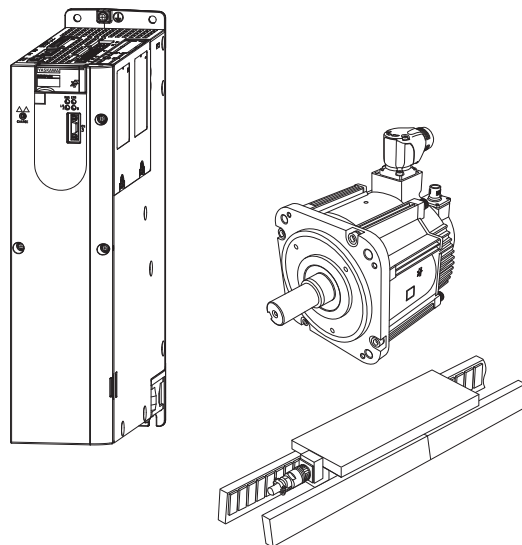

Basic Information on SERVOPACKs	1
Selecting a SERVOPACK	2
SERVOPACK Installation	3
Wiring and Connecting SERVOPACKs	4
Wiring and Settings for the Dynamic Brake	5
Basic Functions That Require Setting before Operation	6
Application Functions	7
Trial Operation and Actual Operation	8
Tuning	9
Monitoring	10
Fully-Closed Loop Control	11
Safety Functions	12
EtherCAT Communications	13
CiA402 Drive Profile	14
Object Dictionary	15
Maintenance	16
Parameter and Object Lists	17
Appendices	18

Copyright © 2015 YASKAWA ELECTRIC CORPORATION

All rights reserved. No part of this publication may be reproduced, stored in a retrieval system, or transmitted, in any form, or by any means, mechanical, electronic, photocopying, recording, or otherwise, without the prior written permission of Yaskawa. No patent liability is assumed with respect to the use of the information contained herein. Moreover, because Yaskawa is constantly striving to improve its high-quality products, the information contained in this manual is subject to change without notice. Every precaution has been taken in the preparation of this manual. Nevertheless, Yaskawa assumes no responsibility for errors or omissions. Neither is any liability assumed for damages resulting from the use of the information contained in this publication.

About this Manual

This manual provides information required to select Σ -7S SERVOPACKs with EtherCAT Communications References for Σ -7-Series AC Servo Drives, and to design, perform trial operation of, tune, operate, and maintain the Servo Drives.

Read and understand this manual to ensure correct usage of the Σ -7-Series AC Servo Drives. Keep this manual in a safe place so that it can be referred to whenever necessary.

Outline of Manual

The contents of the chapters of this manual are described in the following table.

Refer to these chapters as required.

Chapter	Chapter Title	Contents
1	Basic Information on SERVOPACKs	Provides information required to select SERVOPACKs, such as SERVOPACK models and combinations with Servomotors.
2	Selecting a SERVOPACK	Provides information required to select SERVOPACKs, such as specifications, block diagrams, dimensional drawings, and connection examples.
3	SERVOPACK Installation	Provides information on installing SERVOPACKs in the required locations.
4	Wiring and Connecting SERVOPACKs	Provides information on wiring and connecting SERVOPACKs to power supplies and peripheral devices.
5	Wiring and Settings for the Dynamic Brake	Provides information about selecting the resistor, wiring, and parameter settings when using the dynamic brake.
6	Basic Functions That Require Setting before Operation	Describes the basic functions that must be set before you start Servo System operation. It also describes the setting methods.
7	Application Functions	Describes the application functions that you can set before you start Servo System operation. It also describes the setting methods.
8	Trial Operation and Actual Operation	Provides information on the flow and procedures for trial operation and convenient functions to use during trial operation.
9	Tuning	Provides information on the flow of tuning, details on tuning functions, and related operating procedures.
10	Monitoring	Provides information on monitoring SERVOPACK product information and SERVOPACK status.
11	Fully-Closed Loop Control	Provides detailed information on performing fully-closed loop control with the SERVOPACK.
12	Safety Functions	Provides detailed information on the safety functions of the SERVOPACK.
13	EtherCAT Communications	Provides basic information on EtherCAT communications.
14	CiA402 Drive Profile	Provides detailed information on the CiA402 drive profile.
15	Object Dictionary	Provides an overview and details on the object dictionary.
16	Maintenance	Provides information on the meaning of, causes of, and corrections for alarms and warnings.
17	Parameter and Object Lists	Provides information on parameters and objects.
18	Appendices	Provides information on interpreting panel displays and tables of corresponding SERVOPACK and SigmaWin+ function names.

Related Documents

The relationships between the documents that are related to the Servo Drives are shown in the following figure. The numbers in the figure correspond to the numbers in the table on the following pages. Refer to these documents as required.

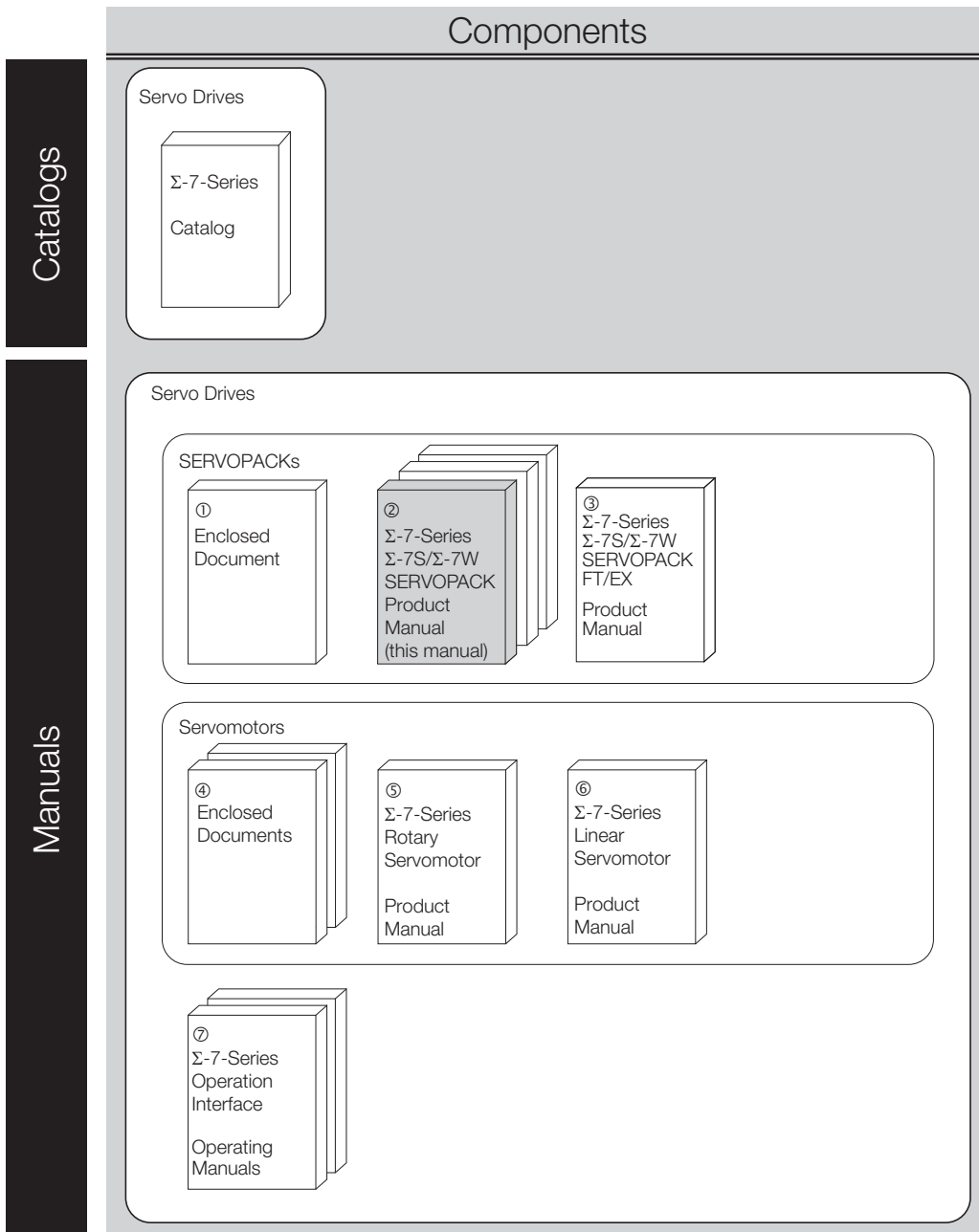



Classification	Document Name	Document No.	Description
① Enclosed Document	Σ -7-Series AC Servo Drive Σ -7S and Σ -7W SERVOPACK with 400 V-Input Power Safety Precautions	TOMP C710828 02	Provides detailed information for the safe usage of Σ -7-Series SERVOPACKs.
② Σ -7-Series Σ -7S/ Σ -7W SERVOPACK Product Manual	Σ -7-Series AC Servo Drive Σ -7S SERVOPACK with 400 V-Input Power and EtherCAT (CoE) Communications References Product Manual	This manual (SIEP S800001 80)	Provide detailed information on selecting Σ -7-Series SERVOPACKs and information on installing, con- necting, setting, performing trial operation for, tuning, monitoring, and maintaining the Servo Drives.
	Σ -7-Series AC Servo Drive Σ -7S SERVOPACK with 400-V Input Power and MECHATROLINK-III Communications References RJ-45 Connectors Product Manual	SIEP S8000002 14	
	Σ -7-Series AC Servo Drive Σ -7W SERVOPACK with 400-V Input Power and EtherCAT (CoE) Communications References Product Manual	SIEP S800002 19	
	Σ -7-Series AC Servo Drive Σ -7W SERVOPACK with 400-V Input Power and MECHATROLINK-III Communications References RJ-45 Connectors Product Manual	SIEP S800002 20	
③ Σ -7-Series Σ -7S/ Σ -7W SERVOPACK FT/EX Product Manual	Σ -7-Series AC Servo Drive Σ -7S SERVOPACK with 400-V Input Power and EtherCAT (CoE) Communications References FT/EX Specification for Advanced Safety Module Product Manual	SIEP S800002 30	Provide detailed information on the FT/EX Option for Σ -7-Series SERVOPACKs.
④ Enclosed Documents	AC Servo Drive Rotary Servomotor Safety Precautions	TOBP C230260 00	Provides detailed information for the safe usage of Σ -7-Series Rotary Servomotors and Direct Drive Ser- vomotors.
	AC Servomotor Linear Σ Series Safety Precautions	TOBP C230800 00	Provides detailed information for the safe usage of Σ -7-Series Linear Servomotors.
⑤ Σ -7-Series Rotary Servomotor Product Manual	Σ -7-Series AC Servo Drive Rotary Servomotor with 400 V-Input Power Product Manual	SIEP S800001 86	Provide detailed information on selecting, installing, and connecting the Σ -7-Series Servomotors.
⑥ Σ -7-Series Linear Servomotor Product Manual	Σ -7-Series AC Servo Drive Linear Servomotor with 400 V-Input Power Product Manual	SIEP S800001 81	
⑦ Σ -7-Series Operation Interface Operating Manuals	Σ -7-Series AC Servo Drive Digital Operator Operating Manual	SIEP S800001 33	Describes the operating proce- dures for a Digital Operator for a Σ -7-Series Servo System.
	AC Servo Drive Engineering Tool SigmaWin+ Operation Manual	SIET S800001 34	Provides detailed operating proce- dures for the SigmaWin+ Engineer- ing Tool for a Σ -7-Series Servo System.

Using This Manual

◆ Technical Terms Used in This Manual

The following terms are used in this manual.

Term	Meaning
Servomotor	A Σ -7-Series Rotary Servomotor or Linear Servomotor
Rotary Servomotor	A Σ -7-Series Rotary Servomotor (SGM7J, SGM7A, or SGM7G).
Linear Servomotor	A Σ -7-Series Linear Servomotor (SGLF or SGLT).
SERVOPACK	A Σ -7-Series Σ -7S servo amplifier with EtherCAT Communications References.
Servo Drive	The combination of a Servomotor and SERVOPACK.
Servo System	A servo control system that includes the combination of a Servo Drive with a host controller and peripheral devices.
servo ON	Supplying power to the motor.
servo OFF	Not supplying power to the motor.
Servo ON command (Enable Operation command)	A command that is used to turn ON the servo (i.e., supply power to the motor) when bit 3 of controlword (6040h) is changed to 1 (ON) while the control power supply and main circuit power supply are ON. Refer to the following section for details.  14.1 Device Control (page 14-3)
Servo OFF command (Disable Operation command)	A command that is used to turn OFF the servo (i.e., power not supplied to the motor) when bit 3 of controlword (6040h) is changed to 0 (OFF) while the control power supply and main circuit power supply are ON. Refer to the following section for details.  14.1 Device Control (page 14-3)
base block (BB)	Shutting OFF the power supply to the motor by shutting OFF the base current to the power transistor in the SERVOPACK.
servo lock	A state in which the motor is stopped and is in a position loop with a position reference of 0.
Main Circuit Cable	One of the cables that connect to the main circuit terminals, including the Main Circuit Power Supply Cable, Control Power Supply Cable, and Servomotor Main Circuit Cable.
SigmaWin+	The Engineering Tool for setting up and tuning Servo Drives or a computer in which the Engineering Tool is installed.

◆ Differences in Terms for Rotary Servomotors and Linear Servomotors

There are differences in the terms that are used for Rotary Servomotors and Linear Servomotors. This manual primarily describes Rotary Servomotors. If you are using a Linear Servomotor, you need to interpret the terms as given in the following table.

Rotary Servomotors	Linear Servomotors
torque	force
moment of inertia	mass
rotation	movement
forward rotation and reverse rotation	forward movement and reverse movement
CW and CCW pulse trains	forward and reverse pulse trains
rotary encoder	linear encoder
absolute rotary encoder	absolute linear encoder
incremental rotary encoder	incremental linear encoder
unit: min^{-1}	unit: mm/s
unit: $\text{N}\cdot\text{m}$	unit: N

◆ Notation Used in this Manual

■ Notation for Reverse Signals

The names of reverse signals (i.e., ones that are valid when low) are written with a forward slash (/) before the signal abbreviation.

Notation Example

\overline{BK} is written as /BK.

■ Notation for Parameters

The notation depends on whether the parameter requires a numeric setting (parameter for numeric setting) or requires the selection of a function (parameter for selecting functions).

• Parameters for Numeric Settings

The control methods for which the parameters apply are given.
Speed: Speed control Position: Position control Torque: Torque control

Parameter number Pn100 (2100h)	Speed Loop Gain					Speed Position
	Setting Range	Setting Unit	Default Setting	When Enabled	Classification	
	10 to 20,000	0.1 Hz	400	Immediately	Tuning	

Object index number used to access the parameter with EtherCAT (CoE) communications

This is the setting range for the parameter.

This is the minimum unit (setting increment) that you can set for the parameter.

This is the parameter setting before shipment.

This is when any change made to the parameter will become effective.

This is the parameter classification.

• Parameters for Selecting Functions

Parameter	Meaning	When Enabled	Classification
Parameter number Pn002 (2002h)	n.□0□□ (default setting)	After restart	Setup
	n.□1□□		
	n.□2□□		

Object index number used to access the parameter with EtherCAT (CoE) communications

The notation "n.□□□□" indicates a parameter for selecting functions. Each □ indicates the setting for one digit. The notation shown here means that the third digit from the right is set to 2.

This column explains the selections for the function.

Notation Example

Notation Examples for Pn002

Digit Notation		Numeric Value Notation	
Notation	Meaning	Notation	Meaning
n.0000			
Pn002 = n.□□□X	Indicates the first digit from the right in Pn002.	Pn002 = n.□□□1	Indicates that the first digit from the right in Pn002 is set to 1.
Pn002 = n.□□X□	Indicates the second digit from the right in Pn002.	Pn002 = n.□□1□	Indicates that the second digit from the right in Pn002 is set to 1.
Pn002 = n.□X□□	Indicates the third digit from the right in Pn002.	Pn002 = n.□1□□	Indicates that the third digit from the right in Pn002 is set to 1.
Pn002 = n.X□□□	Indicates the fourth digit from the right in Pn002.	Pn002 = n.1□□□	Indicates that the fourth digit from the right in Pn002 is set to 1.

◆ Engineering Tools Used in This Manual

This manual uses the interfaces of the SigmaWin+ for descriptions.

◆ Trademarks

- EtherCAT® is a registered trademark and patented technology, licensed by Beckhoff Automation GmbH, Germany.
- Safety over EtherCAT® is a registered trademark and patented technology, licensed by Beckhoff Automation GmbH, Germany.
- QR code is a trademark of Denso Wave Inc.
- Other product names and company names are the trademarks or registered trademarks of the respective company. “TM” and the ® mark do not appear with product or company names in this manual.

◆ Visual Aids

The following aids are used to indicate certain types of information for easier reference.



Indicates precautions or restrictions that must be observed.
Also indicates alarm displays and other precautions that will not result in machine damage.



Indicates definitions of difficult terms or terms that have not been previously explained in this manual.

Example Indicates operating or setting examples.

Information Indicates supplemental information to deepen understanding or useful information.

Safety Precautions

◆ Safety Information

To prevent personal injury and equipment damage in advance, the following signal words are used to indicate safety precautions in this document. The signal words are used to classify the hazards and the degree of damage or injury that may occur if a product is used incorrectly. Information marked as shown below is important for safety. Always read this information and heed the precautions that are provided.



DANGER

- Indicates precautions that, if not heeded, are likely to result in loss of life, serious injury, or fire.



WARNING

- Indicates precautions that, if not heeded, could result in loss of life, serious injury, or fire.



CAUTION

- Indicates precautions that, if not heeded, could result in relatively serious or minor injury, or in fire.

NOTICE

- Indicates precautions that, if not heeded, could result in property damage.

◆ Safety Precautions That Must Always Be Observed

■ General Precautions



DANGER

- Read and understand this manual to ensure the safe usage of the product.
- Keep this manual in a safe, convenient place so that it can be referred to whenever necessary. Make sure that it is delivered to the final user of the product.
- Do not remove covers, cables, connectors, or optional devices while power is being supplied to the SERVOPACK.
There is a risk of electric shock, operational failure of the product, or burning.



WARNING

- Use a power supply with specifications (number of phases, voltage, frequency, and AC/DC type) that are appropriate for the product.
There is a risk of burning, electric shock, or fire.
- Connect the ground terminals on the SERVOPACK and Servomotor to ground poles according to local electrical codes. (Connect to 10 Ω or less for the SERVOPACK.)
There is a risk of electric shock or fire.
- Do not attempt to disassemble, repair, or modify the product.
There is a risk of fire or failure.
The warranty is void for the product if you disassemble, repair, or modify it.



CAUTION

- The SERVOPACK heat sinks, Regenerative Resistors, Servomotors, and other components can be very hot while power is ON or soon after the power is turned OFF. Implement safety measures, such as installing covers, so that hands and parts such as cables do not come into contact with hot components.
There is a risk of burn injury.
- For a 24-VDC power supply, use a power supply device with double insulation or reinforced insulation.
There is a risk of electric shock.
- Do not damage, pull on, apply excessive force to, place heavy objects on, or pinch cables.
There is a risk of failure, damage, or electric shock.
- The person who designs the system that uses the hard wire base block safety function must have a complete knowledge of the related safety standards and a complete understanding of the instructions in this document.
There is a risk of injury, product damage, or machine damage.
- Do not use the product in an environment that is subject to water, corrosive gases, or flammable gases, or near flammable materials.
There is a risk of electric shock or fire.

NOTICE

- Do not attempt to use a SERVOPACK or Servomotor that is damaged or that has missing parts.
- Install external emergency stop circuits that shut OFF the power supply and stops operation immediately when an error occurs.
- In locations with poor power supply conditions, install the necessary protective devices (such as AC Reactors) to ensure that the input power is supplied within the specified voltage range. There is a risk of damage to the SERVOPACK.
- Use a Noise Filter to minimize the effects of electromagnetic interference. Electronic devices used near the SERVOPACK may be affected by electromagnetic interference.
- Always use a Servomotor and SERVOPACK in one of the specified combinations.
- Do not touch a SERVOPACK or Servomotor with wet hands. There is a risk of product failure.

■ Storage Precautions



CAUTION

- Do not place an excessive load on the product during storage. (Follow all instructions on the packages.) There is a risk of injury or damage.

NOTICE

- Do not install or store the product in any of the following locations.
 - Locations that are subject to direct sunlight
 - Locations that are subject to ambient temperatures that exceed product specifications
 - Locations that are subject to relative humidities that exceed product specifications
 - Locations that are subject to condensation as the result of extreme changes in temperature
 - Locations that are subject to corrosive or flammable gases
 - Locations that are near flammable materials
 - Locations that are subject to dust, salts, or iron powder
 - Locations that are subject to water, oil, or chemicals
 - Locations that are subject to vibration or shock that exceeds product specifications
 - Locations that are subject to radiationIf you store or install the product in any of the above locations, the product may fail or be damaged.

■ Transportation Precautions



CAUTION

- Transport the product in a way that is suitable to the mass of the product.
- Do not use the eyebolts on a SERVOPACK or Servomotor to move the machine. There is a risk of damage or injury.
- When you handle a SERVOPACK or Servomotor, be careful of sharp parts, such as the corners. There is a risk of injury.
- Do not place an excessive load on the product during transportation. (Follow all instructions on the packages.) There is a risk of injury or damage.

NOTICE

- Do not hold onto the front cover or connectors when you move a SERVOPACK.
There is a risk of the SERVOPACK falling.
- A SERVOPACK or Servomotor is a precision device. Do not drop it or subject it to strong shock.
There is a risk of failure or damage.
- Do not subject connectors to shock.
There is a risk of faulty connections or damage.
- If disinfectants or insecticides must be used to treat packing materials such as wooden frames, plywood, or pallets, the packing materials must be treated before the product is packaged, and methods other than fumigation must be used.
Example: Heat treatment, where materials are kiln-dried to a core temperature of 56°C for 30 minutes or more.
If the electronic products, which include stand-alone products and products installed in machines, are packed with fumigated wooden materials, the electrical components may be greatly damaged by the gases or fumes resulting from the fumigation process. In particular, disinfectants containing halogen, which includes chlorine, fluorine, bromine, or iodine can contribute to the erosion of the capacitors.
- Do not overtighten the eyebolts on a SERVOPACK or Servomotor.
If you use a tool to overtighten the eyebolts, the tapped holes may be damaged.

■ Installation Precautions



CAUTION

- Install the Servomotor or SERVOPACK in a way that will support the mass given in technical documents.
- Install SERVOPACKs, Servomotors, regenerative resistors, and External Dynamic Brake Resistors on nonflammable materials.
Installation directly onto or near flammable materials may result in fire.
- Provide the specified clearances between the SERVOPACK and the control panel as well as with other devices.
There is a risk of fire or failure.
- Install the SERVOPACK in the specified orientation.
There is a risk of fire or failure.
- Do not step on or place a heavy object on the product.
There is a risk of failure, damage, or injury.
- Do not allow any foreign matter to enter the SERVOPACK or Servomotor.
There is a risk of failure or fire.

NOTICE

- **Do not install or store the product in any of the following locations.**
 - Locations that are subject to direct sunlight
 - Locations that are subject to ambient temperatures that exceed product specifications
 - Locations that are subject to relative humidities that exceed product specifications
 - Locations that are subject to condensation as the result of extreme changes in temperature
 - Locations that are subject to corrosive or flammable gases
 - Locations that are near flammable materials
 - Locations that are subject to dust, salts, or iron powder
 - Locations that are subject to water, oil, or chemicals
 - Locations that are subject to vibration or shock that exceeds product specifications
 - Locations that are subject to radiationIf you store or install the product in any of the above locations, the product may fail or be damaged.
- **Use the product in an environment that is appropriate for the product specifications.**

If you use the product in an environment that exceeds product specifications, the product may fail or be damaged.
- **A SERVOPACK or Servomotor is a precision device. Do not drop it or subject it to strong shock.**

There is a risk of failure or damage.
- **Always install a SERVOPACK in a control panel.**
- **Do not allow any foreign matter to enter a SERVOPACK or a Servomotor with a Cooling Fan and do not cover the outlet from the Servomotor's cooling fan.**

There is a risk of failure.

■ Wiring Precautions



DANGER

- **Do not change any wiring while power is being supplied.**

There is a risk of electric shock or injury.



WARNING

- **Wiring and inspections must be performed only by qualified engineers.**

There is a risk of electric shock or product failure.
- **Check all wiring and power supplies carefully.**

Incorrect wiring or incorrect voltage application to the output circuits may cause short-circuit failures. If a short-circuit failure occurs as a result of any of these causes, the holding brake will not work. This could damage the machine or cause an accident that may result in death or injury.
- **Connect the AC and DC power supplies to the specified SERVOPACK terminals.**
 - Connect an AC power supply to the L1, L2, and L3 terminals on the SERVOPACK.
 - Connect a DC power supply to the B1 and $\ominus 2$ terminals and the 24 V and 0 V terminals on the SERVOPACK.

There is a risk of failure or fire.



CAUTION

- Wait for six minutes after turning OFF the power supply and then make sure that the CHARGE indicator is not lit before starting wiring or inspection work. Do not touch the power supply terminals while the CHARGE lamp is lit after turning OFF the power supply because high voltage may still remain in the SERVOPACK.
There is a risk of electric shock.
- Observe the precautions and instructions for wiring and trial operation precisely as described in this document.
Failures caused by incorrect wiring or incorrect voltage application in the brake circuit may cause the SERVOPACK to fail, damage the equipment, or cause an accident resulting in death or injury.
- Check the wiring to be sure it has been performed correctly.
Connectors and pin layouts are sometimes different for different models. Always confirm the pin layouts in technical documents for your model before operation.
There is a risk of failure or malfunction.
- Connect wires to power supply terminals and motor connection terminals securely with the specified methods and tightening torque.
Insufficient tightening may cause wires and terminal blocks to generate heat due to faulty contact, possibly resulting in fire.
- Use shielded twisted-pair cables or screened unshielded multi-twisted-pair cables for I/O Signal Cables and Encoder Cables.
- The maximum wiring length is 10 m for Control Power Supply Cables (+24 V, 0 V), 3 m for I/O Signal Cables, and 50 m for Encoder Cables or Servomotor Main Circuit Cables.
- Observe the following precautions when wiring the SERVOPACK's main circuit terminals.
 - Turn ON the power supply to the SERVOPACK only after all wiring, including the main circuit terminals, has been completed.
 - If a connector is used for the main circuit terminals, remove the main circuit connector from the SERVOPACK before you wire it.
 - Insert only one wire per insertion hole in the main circuit terminals.
 - When you insert a wire, make sure that the conductor wire (e.g., whiskers) does not come into contact with adjacent wires.
- Install molded-case circuit breakers and other safety measures to provide protection against short circuits in external wiring.
There is a risk of fire or failure.

NOTICE

- Whenever possible, use the Cables specified by Yaskawa.
If you use any other cables, confirm the rated current and application environment of your model and use the wiring materials specified by Yaskawa or equivalent materials.
- Securely tighten connector screws and lock mechanisms.
Insufficient tightening may result in connectors falling off during operation.
- Do not bundle power lines (e.g., the Main Circuit Cable) and low-current lines (e.g., the I/O Signal Cables or Encoder Cables) together or run them through the same duct. If you do not place power lines and low-current lines in separate ducts, separate them by at least 30 cm.
If the cables are too close to each other, malfunctions may occur due to noise affecting the low-current lines.
- Install a battery at either the host controller or on the Encoder Cable.
If you install batteries both at the host controller and on the Encoder Cable at the same time, you will create a loop circuit between the batteries, resulting in a risk of damage or burning.
- When connecting a battery, connect the polarity correctly.
There is a risk of battery rupture or encoder failure.
- If you use an External Regenerative Resistor or External Dynamic Brake Resistor, use cable ties, clamps, or other means to secure the resistor so that the connectors or terminal blocks inside the SERVOPACK will not be affected even if the resistor is subjected to vibration or shock.
There is a risk of SERVOPACK damage.

■ Operation Precautions



WARNING

- **Before starting operation with a machine connected, change the settings of the switches and parameters to match the machine.**
Unexpected machine operation, failure, or personal injury may occur if operation is started before appropriate settings are made.
- **Do not radically change the settings of the parameters.**
There is a risk of unstable operation, machine damage, or injury.
- **Install limit switches or stoppers at the ends of the moving parts of the machine to prevent unexpected accidents.**
There is a risk of machine damage or injury.
- **For trial operation, securely mount the Servomotor and disconnect it from the machine.**
There is a risk of injury.
- **Forcing the motor to stop for overtravel is disabled when the Jog, Origin Search, or Easy FFT utility function is executed. Take necessary precautions.**
There is a risk of machine damage or injury.
- **When an alarm occurs, the motor will coast to a stop or stop with the dynamic brake according to a setting in the SERVOPACK. The coasting distance will change with the moment of inertia of the load. Check the coasting distance during trial operation and implement suitable safety measures on the machine.**
- **Do not enter the machine's range of motion during operation.**
There is a risk of injury.
- **Do not touch the moving parts of the Servomotor or machine during operation.**
There is a risk of injury.



CAUTION

- **Design the system to ensure safety even when problems, such as broken signal lines, occur.**
For example, the P-OT and N-OT signals are set in the default settings to operate on the safe side if a signal line breaks. Do not change the polarity of this type of signal.
- **When overtravel occurs, the power supply to the motor is turned OFF and the brake is released.**
If you use the Servomotor to drive a vertical load, set the Servomotor to enter a zero-clamped state after the Servomotor stops. Also, install safety devices (such as an external brake or counterweight) to prevent the moving parts of the machine from falling.
- **Always turn OFF the servo before you turn OFF the power supply. If you turn OFF the main circuit power supply or control power supply during operation before you turn OFF the servo, the Servomotor will stop as follows:**
 - If you turn OFF the main circuit power supply during operation without turning OFF the servo, the Servomotor will stop abruptly with the dynamic brake or it will coast to a stop.
 - If you turn OFF the control power supply during operation without turning OFF the servo, the Servomotor will stop abruptly with the dynamic brake or it will coast to a stop. For details, refer to the manual for the SERVOPACK.
 - If you use an External Dynamic Brake Resistor, the Servomotor stopping method will be different from when the built-in dynamic brake resistor is used. For details, refer to the product manual for your SERVOPACK.
- **Do not use the dynamic brake for any application other than an emergency stop.**
There is a risk of failure due to rapid deterioration of elements in the SERVOPACK and the risk of unexpected operation, machine damage, burning, or injury.

NOTICE

- When you adjust the gain during system commissioning, use a measuring instrument to monitor the torque waveform and speed waveform and confirm that there is no vibration.
If a high gain causes vibration, the Servomotor will be damaged quickly.
- Do not frequently turn the power supply ON and OFF. After you have started actual operation, allow at least one hour between turning the power supply ON and OFF (as a guideline).
Do not use the product in applications that require the power supply to be turned ON and OFF frequently.
The elements in the SERVOPACK will deteriorate quickly.
- An alarm or warning may occur if communications are performed with the host controller while the SigmaWin+ or Digital Operator is operating.
If an alarm or warning occurs, it may interrupt the current process and stop the system.
- After you complete trial operation of the machine and facilities, use the SigmaWin+ to back up the settings of the SERVOPACK parameters. You can use them to reset the parameters after SERVOPACK replacement.
If you do not copy backed up parameter settings, normal operation may not be possible after a faulty SERVOPACK is replaced, possibly resulting in machine or equipment damage.

■ Maintenance and Inspection Precautions

DANGER

- Do not change any wiring while power is being supplied.
There is a risk of electric shock or injury.

WARNING

- Wiring and inspections must be performed only by qualified engineers.
There is a risk of electric shock or product failure.

CAUTION

- Wait for six minutes after turning OFF the power supply and then make sure that the CHARGE indicator is not lit before starting wiring or inspection work. Do not touch the power supply terminals while the CHARGE lamp is lit after turning OFF the power supply because high voltage may still remain in the SERVOPACK.
There is a risk of electric shock.
- Before you replace a SERVOPACK, back up the settings of the SERVOPACK parameters. Copy the backed up parameter settings to the new SERVOPACK and confirm that they were copied correctly.
If you do not copy backed up parameter settings or if the copy operation is not completed normally, normal operation may not be possible, possibly resulting in machine or equipment damage.

NOTICE

- Discharge all static electricity from your body before you operate any of the buttons or switches inside the front cover of the SERVOPACK.
There is a risk of equipment damage.

■ Troubleshooting Precautions



DANGER

- If the safety device (molded-case circuit breaker or fuse) installed in the power supply line operates, remove the cause before you supply power to the SERVOPACK again. If necessary, repair or replace the SERVOPACK, check the wiring, and remove the factor that caused the safety device to operate.
There is a risk of fire, electric shock, or injury.



WARNING

- The product may suddenly start to operate when the power supply is recovered after a momentary power interruption. Design the machine to ensure human safety when operation restarts.
There is a risk of injury.



CAUTION

- When an alarm occurs, remove the cause of the alarm and ensure safety. Then reset the alarm or turn the power supply OFF and ON again to restart operation.
There is a risk of injury or machine damage.
- If the Servo ON signal is input to the SERVOPACK and an alarm is reset, the Servomotor may suddenly restart operation. Confirm that the servo is OFF and ensure safety before you reset an alarm.
There is a risk of injury or machine damage.
- Always insert a Magnetic Contactor in the line between the main circuit power supply and the main circuit power supply terminals on the SERVOPACK so that the power supply can be shut OFF at the main circuit power supply.
If a Magnetic Contactor is not connected when the SERVOPACK fails, a large current may flow, possibly resulting in fire.
- If an alarm occurs, shut OFF the main circuit power supply.
There is a risk of fire due to a Regenerative Resistor overheating as the result of regenerative transistor failure.
- Install a ground fault detector against overloads and short-circuiting or install a molded-case circuit breaker combined with a ground fault detector.
There is a risk of SERVOPACK failure or fire if a ground fault occurs.
- The holding brake on a Servomotor will not ensure safety if there is the possibility that an external force (including gravity) may move the current position and create a hazardous situation when power is interrupted or an error occurs. If an external force may cause movement, install an external braking mechanism that ensures safety.

■ Disposal Precautions

- Correctly discard the product as stipulated by regional, local, and municipal laws and regulations. Be sure to include these contents in all labelling and warning notifications on the final product as necessary.



■ General Precautions

- Figures provided in this document are typical examples or conceptual representations. There may be differences between them and actual wiring, circuits, and products.
- The products shown in illustrations in this document are sometimes shown without covers or protective guards. Always replace all covers and protective guards before you use the product.
- If you need a new copy of this document because it has been lost or damaged, contact your nearest Yaskawa representative or one of the offices listed on the back of this document.
- This document is subject to change without notice for product improvements, specifications changes, and improvements to the manual itself.
We will update the document number of the document and issue revisions when changes are made.
- Any and all quality guarantees provided by Yaskawa are null and void if the customer modifies the product in any way. Yaskawa disavows any responsibility for damages or losses that are caused by modified products.

Warranty

◆ Details of Warranty

■ Warranty Period

The warranty period for a product that was purchased (hereinafter called the “delivered product”) is one year from the time of delivery to the location specified by the customer or 18 months from the time of shipment from the Yaskawa factory, whichever is sooner.

■ Warranty Scope

Yaskawa shall replace or repair a defective product free of charge if a defect attributable to Yaskawa occurs during the above warranty period.

This warranty does not cover defects caused by the delivered product reaching the end of its service life and replacement of parts that require replacement or that have a limited service life.

This warranty does not cover failures that result from any of the following causes.

- Improper handling, abuse, or use in unsuitable conditions or in environments not described in product catalogs or manuals, or in any separately agreed-upon specifications
- Causes not attributable to the delivered product itself
- Modifications or repairs not performed by Yaskawa
- Use of the delivered product in a manner in which it was not originally intended
- Causes that were not foreseeable with the scientific and technological understanding at the time of shipment from Yaskawa
- Events for which Yaskawa is not responsible, such as natural or human-made disasters

◆ Limitations of Liability

- Yaskawa shall in no event be responsible for any damage or loss of opportunity to the customer that arises due to failure of the delivered product.
- Yaskawa shall not be responsible for any programs (including parameter settings) or the results of program execution of the programs provided by the user or by a third party for use with programmable Yaskawa products.
- The information described in product catalogs or manuals is provided for the purpose of the customer purchasing the appropriate product for the intended application. The use thereof does not guarantee that there are no infringements of intellectual property rights or other proprietary rights of Yaskawa or third parties, nor does it construe a license.
- Yaskawa shall not be responsible for any damage arising from infringements of intellectual property rights or other proprietary rights of third parties as a result of using the information described in catalogs or manuals.

◆ Suitability for Use

- It is the customer's responsibility to confirm conformity with any standards, codes, or regulations that apply if the Yaskawa product is used in combination with any other products.
- The customer must confirm that the Yaskawa product is suitable for the systems, machines, and equipment used by the customer.
- Consult with Yaskawa to determine whether use in the following applications is acceptable. If use in the application is acceptable, use the product with extra allowance in ratings and specifications, and provide safety measures to minimize hazards in the event of failure.
 - Outdoor use, use involving potential chemical contamination or electrical interference, or use in conditions or environments not described in product catalogs or manuals
 - Nuclear energy control systems, combustion systems, railroad systems, aviation systems, vehicle systems, medical equipment, amusement machines, and installations subject to separate industry or government regulations
 - Systems, machines, and equipment that may present a risk to life or property
 - Systems that require a high degree of reliability, such as systems that supply gas, water, or electricity, or systems that operate continuously 24 hours a day
 - Other systems that require a similar high degree of safety
- Never use the product for an application involving serious risk to life or property without first ensuring that the system is designed to secure the required level of safety with risk warnings and redundancy, and that the Yaskawa product is properly rated and installed.
- The circuit examples and other application examples described in product catalogs and manuals are for reference. Check the functionality and safety of the actual devices and equipment to be used before using the product.
- Read and understand all use prohibitions and precautions, and operate the Yaskawa product correctly to prevent accidental harm to third parties.

◆ Specifications Change

The names, specifications, appearance, and accessories of products in product catalogs and manuals may be changed at any time based on improvements and other reasons. The next editions of the revised catalogs or manuals will be published with updated code numbers. Consult with your Yaskawa representative to confirm the actual specifications before purchasing a product.

Compliance with UL Standards, EU Directives, and Other Safety Standards

Certification marks for the standards for which the product has been certified by certification bodies are shown on nameplate. Products that do not have the marks are not certified for the standards. Refer to the Servomotor manual for compliant standards of Servomotors.

◆ North American Safety Standards (UL)



Product	Model	UL Standards (UL File No.)
SERVOPACKs	SGD7S	UL 61800-5-1 (E147823), CSA C22.2 No.274

◆ European Directives



Product	Model	EU Directive	Harmonized Standards
SERVOPACKs	SGD7S	Machinery Directive 2006/42/EC	EN ISO13849-1: 2015
		EMC Directive 2014/30/EU	EN 55011 group 1, class A EN 61000-6-2 EN 61000-6-4 EN 61800-3 (Category C2, Second environment)
		Low Voltage Directive 2014/35/EU	EN 50178 EN 61800-5-1
		RoHS Directive 2011/65/EU (EU)2015/863	EN IEC 63000

Note: 1. We declared the CE Marking based on the harmonized standards in the above table.

2. These products are for industrial use. In home environments, these products may cause electromagnetic interference and additional noise reduction measures may be necessary.

◆ Safety Standards

Product	Model	Safety Standards	Standards
SERVOPACKs	<ul style="list-style-type: none"> • SGD7S • SGD7W 	Safety of Machinery	EN ISO13849-1: 2015 IEC 60204-1
		Functional Safety	IEC 61508 series IEC 62061 IEC 61800-5-2
		EMC	IEC 61326-3-1

■ Safety Parameters

Item	Standards	Performance Level	
Safety Integrity Level	IEC 61508	SIL3	
	IEC 62061	SILCL3	
Mission Time	IEC 61508	10 years	20 years
Probability of Dangerous Failure per Hour	IEC 61508 IEC 62061	PFH = 4.60×10^{-9} [1/h] (4.60% of SIL3)	PFH = 4.62×10^{-9} [1/h] (4.62% of SIL3)
Performance Level	EN ISO 13849-1	PLe (Category 3)	
Mean Time to Dangerous Failure of Each Channel	EN ISO 13849-1	MTTFd: High	
Average Diagnostic Coverage	EN ISO 13849-1	DCavg: Medium	
Stop Category	IEC 60204-1	Stop category 0	
Safety Function	IEC 61800-5-2	STO	
Hardware Fault Tolerance	IEC 61508	HFT = 1	
Subsystem	IEC 61508	B	

Contents

About this Manual	iii
Outline of Manual	iii
Related Documents	iv
Using This Manual	vi
Safety Precautions	ix
Warranty	xix
Compliance with UL Standards, EU Directives, and Other Safety Standards	xxi

1

Basic Information on SERVOPACKs

1.1	The Σ-7 Series	1-3
1.2	Introduction to EtherCAT	1-4
1.2.1	Introduction to CANopen	1-4
1.2.2	CANopen over EtherCAT OSI Model	1-4
1.2.3	Sending and Receiving Data in EtherCAT (CoE) Communications	1-5
1.2.4	CoE Terminology	1-5
1.2.5	Data Types	1-6
1.2.6	Data Ranges	1-6
1.3	Interpreting the Nameplate	1-7
1.4	Part Names	1-8
1.5	Model Designations	1-10
1.5.1	Interpreting SERVOPACK Model Numbers	1-10
1.5.2	Interpreting Servomotor Model Numbers	1-11
1.6	Combinations of SERVOPACKs and Servomotors	1-12
1.6.1	Combinations of Rotary Servomotors and SERVOPACKs	1-12
1.6.2	Combinations of Linear Servomotors and SERVOPACKs	1-13
1.7	Functions	1-14
1.8	EtherCAT Communications LED Indicators	1-16
1.8.1	RUN	1-16
1.8.2	ERR	1-17
1.8.3	Link/Activity	1-17

2

Selecting a SERVOPACK

2.1	Ratings and Specifications	2-2
2.1.1	Ratings	2-2
2.1.2	SERVOPACK Overload Protection Characteristics	2-3
2.1.3	Specifications	2-4
2.2	Block Diagrams	2-8
2.2.1	SERVOPACKs without Built-in Servomotor Brake Control	2-8
2.2.2	SERVOPACKs with Built-in Servomotor Brake Control	2-11

2.3	External Dimensions	2-14
2.3.1	Front Cover Dimensions and Connector Specifications	2-14
2.3.2	SERVOPACK External Dimensions	2-16
2.4	Examples of Standard Connections between SERVOPACKs and Peripheral Devices . .	2-18

3

SERVOPACK Installation

3.1	Installation Precautions	3-2
3.2	Mounting Types and Orientation	3-3
3.3	Mounting Hole Dimensions	3-4
3.4	Mounting Interval	3-5
3.4.1	Installing One SERVOPACK in a Control Panel	3-5
3.4.2	Installing More Than One SERVOPACK in a Control Panel	3-5
3.5	Monitoring the Installation Environment	3-6
3.6	Derating Specifications	3-7
3.7	EMC Installation Conditions	3-8

4

Wiring and Connecting SERVOPACKs

4.1	Wiring and Connecting SERVOPACKs	4-3
4.1.1	General Precautions	4-3
4.1.2	Countermeasures against Noise	4-5
4.1.3	Grounding	4-8
4.2	Basic Wiring Diagrams	4-9
4.3	Wiring the Power Supply to the SERVOPACK	4-11
4.3.1	Terminal Symbols and Terminal Names	4-11
4.3.2	Connector Wiring Procedure	4-13
4.3.3	Power ON Sequence	4-14
4.3.4	Power Supply Wiring Diagrams	4-15
4.3.5	Wiring Regenerative Resistors	4-18
4.3.6	Wiring Reactors for Harmonic Suppression	4-18
4.4	Wiring Servomotors	4-19
4.4.1	Terminal Symbols and Terminal Names	4-19
4.4.2	Pin Arrangement of Encoder Connector (CN2)	4-19
4.4.3	Wiring the SERVOPACK to the Encoder	4-20
4.4.4	Wiring the SERVOPACK to the Holding Brake	4-28
4.5	Connecting I/O Signals	4-30
4.5.1	I/O Signal Connector (CN1) Names and Functions	4-30
4.5.2	I/O Signal Connector (CN1) Pin Arrangement	4-32
4.5.3	I/O Signal Wiring Examples	4-33
4.5.4	I/O Circuits	4-35

4.6	Connecting Safety Function Signals	4-37
4.6.1	Pin Arrangement of Safety Function Signals (CN8)	4-37
4.6.2	I/O Circuits	4-37
4.7	Connecting EtherCAT Communications Cables	4-39
4.7.1	EtherCAT Connectors (RJ45)	4-39
4.7.2	Ethernet Communications Cables	4-40
4.8	Connecting the Other Connectors	4-41
4.8.1	Serial Communications Connector (CN3)	4-41
4.8.2	Computer Connector (CN7)	4-41
4.8.3	Analog Monitor Connector (CN5)	4-41

5

Wiring and Settings for the Dynamic Brake

5.1	Introduction to the Dynamic Brake	5-2
5.1.1	SERVOPACK Models with a Built-In Dynamic Brake	5-2
5.1.2	SERVOPACK Models without a Built-In Dynamic Brake	5-2
5.2	SERVOPACK Models with a Built-In Dynamic Brake	5-3
5.2.1	Using the Dynamic Brake	5-3
5.2.2	Selecting the Dynamic Brake Resistor	5-4
5.2.3	Connecting Dynamic Brake Resistors	5-7
5.2.4	Setting the Energy Consumption and Resistance of the Dynamic Brake Resistor	5-9
5.3	SERVOPACK Models without a Built-In Dynamic Brake	5-10
5.3.1	Using the Dynamic Brake	5-10
5.3.2	Selecting the Devices Required for the Dynamic Brake Circuit	5-12
5.3.3	Wiring the Dynamic Brake Circuit	5-15
5.3.4	Parameter Settings for the Dynamic Brake Circuit	5-16
5.4	Coasting Distances for Dynamic Braking	5-18
5.4.1	Coasting Distance during Dynamic Braking	5-18
5.4.2	Data for Calculating Coasting Distance	5-19

6

Basic Functions That Require Setting before Operation

6.1	Manipulating SERVOPACK Parameters (Pn□□□)	6-3
6.1.1	Classifications of SERVOPACK Parameters	6-3
6.1.2	Notation for SERVOPACK Parameters	6-4
6.1.3	Setting Methods for SERVOPACK Parameters	6-5
6.1.4	Write Prohibition Setting for SERVOPACK Parameters	6-7
6.1.5	Initializing SERVOPACK Parameter Settings	6-10
6.2	Power Supply Type Settings for the Main Circuit	6-12
6.3	Automatic Detection of Connected Motor	6-13
6.4	Motor Direction Setting	6-14
6.5	Setting the Linear Encoder Pitch	6-15

6.6	Writing Linear Servomotor Parameters	6-16
6.7	Selecting the Phase Sequence for a Linear Servomotor	6-20
6.8	Polarity Sensor Setting	6-22
6.9	Polarity Detection	6-23
6.9.1	Restrictions	6-23
6.9.2	Using the Servo ON Command (Enable Operation Command) to Perform Polarity Detection	6-24
6.9.3	Using a Tool Function to Perform Polarity Detection	6-25
6.10	Overtravel and Related Settings	6-26
6.10.1	Overtravel Signals	6-26
6.10.2	Setting to Enable/Disable Overtravel	6-27
6.10.3	Motor Stopping Method for Overtravel	6-27
6.10.4	Overtravel Warnings	6-29
6.10.5	Overtravel Release Method Selection	6-30
6.10.6	Overtravel Status	6-31
6.10.7	Overtravel Operation by Mode	6-31
6.11	Holding Brake	6-32
6.11.1	Brake Operating Sequence	6-32
6.11.2	/BK (Brake) Signal	6-33
6.11.3	Output Timing of /BK (Brake) Signal When the Servomotor Is Stopped	6-34
6.11.4	Output Timing of /BK (Brake) Signal When the Servomotor Is Operating	6-35
6.11.5	Built-in Brake Relay Usage Selection	6-36
6.12	Motor Stopping Methods for Servo OFF and Alarms	6-37
6.12.1	Stopping Method for Servo OFF	6-38
6.12.2	Servomotor Stopping Method for Alarms	6-38
6.13	Motor Overload Detection Level	6-40
6.13.1	Detection Timing for Overload Warnings (A.910)	6-40
6.13.2	Detection Timing for Overload Alarms (A.720)	6-41
6.14	Setting Unit Systems	6-42
6.14.1	Setting the Position Reference Unit	6-42
6.14.2	Setting the Speed Reference Unit	6-47
6.14.3	Setting the Acceleration Reference Unit	6-48
6.14.4	Setting the Torque Reference Unit	6-48
6.14.5	Setting the Encoder Resolution	6-48
6.15	Resetting the Absolute Encoder	6-49
6.15.1	Precautions on Resetting	6-49
6.15.2	Preparations	6-49
6.15.3	Applicable Tools	6-49
6.15.4	Operating Procedure	6-50
6.16	Setting the Origin of the Absolute Encoder	6-52
6.16.1	Absolute Encoder Origin Offset	6-52
6.16.2	Setting the Origin of the Absolute Linear Encoder	6-52
6.17	Setting the Regenerative Resistor Capacity	6-55

7

Application Functions

7.1	I/O Signal Allocations	7-4
7.1.1	Input Signal Allocations	7-4
7.1.2	Output Signal Allocations	7-5
7.1.3	ALM (Servo Alarm) Signal	7-7
7.1.4	/WARN (Warning) Signal	7-7
7.1.5	/TGON (Rotation Detection) Signal	7-8
7.1.6	/S-RDY (Servo Ready) Signal	7-8
7.1.7	/V-CMP (Speed Coincidence Detection) Signal	7-9
7.1.8	/COIN (Positioning Completion) Signal	7-10
7.1.9	/NEAR (Near) Signal	7-11
7.1.10	Speed Limit during Torque Control	7-12
7.2	Operation for Momentary Power Interruptions	7-14
7.3	SEMI F47 Function	7-15
7.4	Setting the Motor Maximum Speed	7-17
7.5	Encoder Divided Pulse Output	7-18
7.5.1	Encoder Divided Pulse Output Signals	7-18
7.5.2	Setting for the Encoder Divided Pulse Output	7-23
7.6	Software Limits	7-25
7.7	Selecting Torque Limits	7-26
7.7.1	Internal Torque Limits	7-26
7.7.2	External Torque Limits	7-27
7.7.3	/CLT (Torque Limit Detection) Signal	7-30
7.8	Absolute Encoders	7-31
7.8.1	Connecting an Absolute Encoder	7-31
7.8.2	Structure of the Position Data of the Absolute Encoder	7-32
7.8.3	Output Ports for the Position Data from the Absolute Encoder	7-32
7.8.4	Reading the Position Data from the Absolute Encoder	7-33
7.8.5	Transmission Specifications	7-34
7.8.6	Calculating the Current Position in Machine Coordinates	7-35
7.8.7	Multiturn Limit Setting	7-36
7.8.8	Multiturn Limit Disagreement Alarm (A.CC0)	7-37
7.9	Absolute Linear Encoders	7-40
7.9.1	Connecting an Absolute Linear Encoder	7-40
7.9.2	Structure of the Position Data of the Absolute Linear Encoder	7-40
7.9.3	Output Ports for the Position Data from the Absolute Linear Encoder	7-41
7.9.4	Reading the Position Data from the Absolute Linear Encoder	7-42
7.9.5	Transmission Specifications	7-42
7.9.6	Calculating the Current Position in Machine Coordinates	7-43
7.10	Software Reset	7-44
7.10.1	Preparations	7-44
7.10.2	Applicable Tools	7-44
7.10.3	Operating Procedure	7-45

7.11	Initializing the Vibration Detection Level	7-46
7.11.1	Preparations	7-46
7.11.2	Applicable Tools	7-47
7.11.3	Operating Procedure	7-47
7.11.4	Related Parameters	7-49
7.12	Adjusting the Motor Current Detection Signal Offset	7-50
7.12.1	Automatic Adjustment	7-50
7.12.2	Manual Adjustment.	7-53
7.13	Forcing the Motor to Stop	7-55
7.13.1	FSTP (Forced Stop Input) Signal	7-55
7.13.2	Stopping Method Selection for Forced Stops.	7-55
7.13.3	Resetting Method for Forced Stops	7-57
7.14	ZONE Outputs (FT64 Specification)	7-58
7.14.1	ZONE Table and ZONE Signals.	7-58
7.14.2	ZONE Table Settings	7-59
7.14.3	ZONE Signals 1 to 4 Outputs (/ZONE0 to /ZONE3).	7-60
7.14.4	nZONE Signal Output	7-61
7.14.5	ZONE Output Application Example.	7-62
7.15	Overheat Protection	7-63
7.15.1	Connecting the Overheat Protection Input (TH) Signal	7-63
7.15.2	Overheat Protection Selections	7-63

8

Trial Operation and Actual Operation

8.1	Flow of Trial Operation	8-2
8.1.1	Flow of Trial Operation for Rotary Servomotors	8-2
8.1.2	Flow of Trial Operation for Linear Servomotors.	8-4
8.2	Inspections and Confirmations before Trial Operation	8-6
8.3	Trial Operation for the Servomotor without a Load	8-7
8.3.1	Preparations	8-7
8.3.2	Applicable Tools	8-8
8.3.3	Operating Procedure	8-8
8.4	Trial Operation with EtherCAT (CoE) Communications	8-10
8.5	Trial Operation with the Servomotor Connected to the Machine . .	8-11
8.5.1	Precautions	8-11
8.5.2	Preparations.	8-11
8.5.3	Operating Procedure	8-12
8.6	Convenient Function to Use during Trial Operation.	8-13
8.6.1	Program Jogging	8-13
8.6.2	Origin Search	8-19
8.6.3	Test without a Motor.	8-21

9

Tuning

9.1	Overview and Flow of Tuning	9-4
9.1.1	Tuning Functions	9-5
9.1.2	Diagnostic Tool	9-6
9.2	Monitoring Methods	9-7
9.3	Precautions to Ensure Safe Tuning	9-8
9.3.1	Overtravel Settings	9-8
9.3.2	Torque Limit Settings	9-8
9.3.3	Setting the Position Deviation Overflow Alarm Level	9-8
9.3.4	Vibration Detection Level Setting	9-10
9.3.5	Setting the Position Deviation Overflow Alarm Level at Servo ON	9-10
9.4	Tuning-less Function	9-12
9.4.1	Application Restrictions	9-12
9.4.2	Operating Procedure	9-13
9.4.3	Troubleshooting Alarms	9-14
9.4.4	Parameters Disabled by Tuning-less Function	9-15
9.4.5	Automatically Adjusted Function Setting	9-15
9.4.6	Related Parameters	9-15
9.5	Estimating the Moment of Inertia	9-16
9.5.1	Outline	9-16
9.5.2	Restrictions	9-16
9.5.3	Applicable Tools	9-17
9.5.4	Operating Procedure	9-17
9.6	Autotuning without Host Reference	9-23
9.6.1	Outline	9-23
9.6.2	Restrictions	9-24
9.6.3	Applicable Tools	9-25
9.6.4	Operating Procedure	9-25
9.6.5	Troubleshooting Problems in Autotuning without a Host Reference	9-29
9.6.6	Automatically Adjusted Function Settings	9-31
9.6.7	Related Parameters	9-33
9.7	Autotuning with a Host Reference	9-34
9.7.1	Outline	9-34
9.7.2	Restrictions	9-35
9.7.3	Applicable Tools	9-35
9.7.4	Operating Procedure	9-36
9.7.5	Troubleshooting Problems in Autotuning with a Host Reference	9-39
9.7.6	Automatically Adjusted Function Settings	9-39
9.7.7	Related Parameters	9-40
9.8	Custom Tuning	9-41
9.8.1	Outline	9-41
9.8.2	Preparations	9-41
9.8.3	Applicable Tools	9-42
9.8.4	Operating Procedure	9-42
9.8.5	Automatically Adjusted Function Settings	9-48
9.8.6	Tuning Example for Tuning Mode 2 or 3	9-48
9.8.7	Related Parameters	9-49

9.9	Anti-Resonance Control Adjustment	9-50
9.9.1	Outline	9-50
9.9.2	Preparations	9-50
9.9.3	Applicable Tools	9-51
9.9.4	Operating Procedure	9-51
9.9.5	Related Parameters	9-53
9.9.6	Suppressing Different Vibration Frequencies with Anti-resonance Control	9-53
9.10	Vibration Suppression	9-55
9.10.1	Outline	9-55
9.10.2	Preparations	9-56
9.10.3	Applicable Tools	9-56
9.10.4	Operating Procedure	9-56
9.10.5	Setting Combined Functions	9-58
9.10.6	Related Parameters	9-58
9.11	Speed Ripple Compensation	9-59
9.11.1	Outline	9-59
9.11.2	Setting Up Speed Ripple Compensation	9-59
9.11.3	Setting Parameters	9-63
9.12	Additional Adjustment Functions	9-65
9.12.1	Gain Switching	9-65
9.12.2	Friction Compensation	9-68
9.12.3	Gravity Compensation	9-69
9.12.4	Current Control Mode Selection	9-70
9.12.5	Current Gain Level Setting	9-71
9.12.6	Speed Detection Method Selection	9-71
9.12.7	Speed Feedback Filter	9-71
9.12.8	Backlash Compensation	9-72
9.13	Manual Tuning	9-77
9.13.1	Tuning the Servo Gains	9-77
9.13.2	Compatible Adjustment Functions	9-87
9.14	Diagnostic Tools	9-91
9.14.1	Mechanical Analysis	9-91
9.14.2	Easy FFT	9-93

10

Monitoring

10.1	Monitoring Product Information	10-2
10.1.1	Items That You Can Monitor	10-2
10.1.2	Operating Procedures	10-2
10.2	Monitoring SERVOPACK Status	10-3
10.2.1	Servo Drive Status	10-3
10.2.2	Monitoring Operation, Status, and I/O	10-3
10.2.3	I/O Signals Status Monitor	10-5
10.3	Monitoring Machine Operation Status and Signal Waveforms	10-7
10.3.1	Items That You Can Monitor	10-7
10.3.2	Using the SigmaWin+	10-8
10.3.3	Using a Measuring Instrument	10-10

10.4	Monitoring Product Life	10-14
10.4.1	Items That You Can Monitor	10-14
10.4.2	Operating Procedure	10-15
10.4.3	Preventative Maintenance	10-15
10.5	Alarm Tracing	10-17
10.5.1	Data for Which Alarm Tracing Is Performed	10-17
10.5.2	Applicable Tools	10-17

11 Fully-Closed Loop Control

11.1	Fully-Closed System	11-2
11.2	SERVOPACK Commissioning Procedure	11-3
11.3	Parameter and Object Settings for Fully-closed Loop Control.	11-5
11.3.1	Control Block Diagram for Fully-Closed Loop Control	11-5
11.3.2	Setting the Motor Direction and the Machine Movement Direction	11-6
11.3.3	Setting the Number of External Encoder Scale Pitches	11-7
11.3.4	Setting the PAO, PBO, and PCO (Encoder Divided Pulse Output) Signals	11-7
11.3.5	External Absolute Encoder Data Reception Sequence	11-8
11.3.6	Setting Unit Systems	11-8
11.3.7	Alarm Detection Settings	11-8
11.3.8	Analog Monitor Signal Settings	11-9
11.3.9	Setting to Use an External Encoder for Speed Feedback	11-9
11.4	Monitoring an External Encoder.	11-10
11.4.1	Option Module Required for Monitoring.	11-10
11.4.2	Block Diagrams	11-10

12 Safety Functions

12.1	Introduction to the Safety Functions	12-3
12.1.1	Safety Functions	12-3
12.1.2	Precautions for Safety Functions.	12-4
12.2	Hard Wire Base Block (HWBB and SBB)	12-5
12.2.1	Risk Assessment	12-5
12.2.2	Hard Wire Base Block (HWBB) State	12-6
12.2.3	Resetting the HWBB State	12-7
12.2.4	Recovery Method	12-8
12.2.5	Detecting Errors in HWBB Signal.	12-8
12.2.6	HWBB Input Signal Specifications.	12-9
12.2.7	Operation without a Host Controller	12-9
12.2.8	/S-RDY (Servo Ready Output) Signal	12-10
12.2.9	/BK (Brake Output) Signal	12-10
12.2.10	Stopping Methods.	12-11
12.2.11	ALM (Servo Alarm) Signal	12-11
12.3	EDM1 (External Device Monitor)	12-12
12.3.1	EDM1 Output Signal Specifications.	12-12

12.4	Applications Examples for Safety Functions	12-13
12.4.1	Connection Example	12-13
12.4.2	Failure Detection Method	12-13
12.4.3	Procedure.	12-14
12.5	Validating Safety Functions	12-15
12.6	Connecting a Safety Function Device	12-16
12.7	Safety Module Safety Functions	12-17
12.7.1	Safety Base Block with Delay (SBB-D)	12-17
12.7.2	Safe Position Monitor with Delay (SPM-D)	12-18
12.7.3	Safe Speed Limit with Delay (SLS-D)	12-19
12.7.4	Active Mode Function.	12-19

13

EtherCAT Communications

13.1	EtherCAT Slave Information	13-2
13.2	EtherCAT State Machine	13-3
13.3	EtherCAT (CoE) Communications Settings	13-5
13.3.1	Normal Device Recognition Process at Startup	13-5
13.3.2	Application Example.	13-5
13.3.3	Device Recognition with Station Aliases.	13-5
13.4	PDO Mappings	13-6
13.4.1	Setting Procedure for PDO Mappings.	13-7
13.4.2	Default PDO Mappings.	13-7
13.5	Synchronization with Distributed Clocks	13-8
13.6	Emergency Messages	13-11

14

CiA402 Drive Profile

14.1	Device Control	14-3
14.1.1	State Machine Control Commands.	14-4
14.1.2	Bits in Statusword (6041h)	14-4
14.1.3	Related Objects	14-4
14.2	Modes of Operation	14-5
14.2.1	Related Objects	14-5
14.2.2	Dynamic Mode Changes	14-5
14.3	Position Control Modes	14-6
14.3.1	Profile Position Mode	14-6
14.3.2	Interpolated Position Mode	14-9
14.3.3	Cyclic Synchronous Position Mode	14-12

14.4	Homing	14-14
	14.4.1 Related Objects	14-14
	14.4.2 Homing Method (6098h)	14-14
14.5	Velocity Control Modes	14-17
	14.5.1 Profile Velocity Mode	14-17
	14.5.2 Cyclic Synchronous Velocity Mode	14-18
14.6	Torque Control Modes	14-19
	14.6.1 Profile Torque Mode	14-19
	14.6.2 Cyclic Sync Torque Mode	14-20
14.7	Torque Limits	14-21
14.8	Digital I/O Signals	14-22
14.9	Touch Probe	14-23
	14.9.1 Related Objects	14-23
	14.9.2 Example of Execution Procedure for a Touch Probe	14-24
14.10	Fully-Closed Loop Control	14-25

15 Object Dictionary

15.1	Object Dictionary List	15-3
15.2	General Objects	15-5
15.3	PDO Mapping Objects	15-9
15.4	Sync Manager Communications Objects	15-13
15.5	Manufacturer-Specific Objects	15-17
15.6	Device Control	15-23
15.7	Profile Position Mode	15-31
15.8	Homing Mode	15-33
15.9	Position Control Function	15-35
15.10	Interpolated Position Mode	15-37
15.11	Cyclic Synchronous Position Mode	15-43
15.12	Profile Velocity/Cyclic Synchronous Velocity Mode	15-44
15.13	Profile Torque/Cyclic Synchronous Torque Mode	15-45
15.14	Torque Limit Function	15-46

15.15	Touch Probe Function	15-47
15.16	Digital Inputs/Outputs	15-49
15.17	Dual Encoder Feedback	15-51

16

Maintenance

16.1	Inspections and Part Replacement	16-2
16.1.1	Inspections	16-2
16.1.2	Guidelines for Part Replacement	16-2
16.1.3	Replacing the Battery	16-3
16.2	Alarm Displays	16-5
16.2.1	List of Alarms	16-5
16.2.2	Troubleshooting Alarms	16-11
16.2.3	Resetting Alarms	16-42
16.2.4	Displaying the Alarm History	16-43
16.2.5	Clearing the Alarm History	16-44
16.2.6	Resetting Alarms Detected in Option Modules	16-45
16.2.7	Resetting Motor Type Alarms	16-46
16.3	Warning Displays	16-48
16.3.1	List of Warnings	16-48
16.3.2	Troubleshooting Warnings	16-49
16.4	Troubleshooting Based on the Operation and Conditions of the Servomotor	16-55

17

Parameter and Object Lists

17.1	List of Parameters	17-2
17.1.1	Interpreting the Parameter Lists	17-2
17.1.2	List of Parameters	17-3
17.2	Object List	17-33
17.3	SDO Abort Code List	17-42
17.4	Parameter Recording Table	17-43

18

Appendices

18.1	Interpreting Panel Displays	18-2
18.1.1	Interpreting Status Displays	18-2
18.1.2	Alarm and Warning Displays	18-2
18.1.3	Hard Wire Base Block Active Display	18-2
18.1.4	Overtravel Display	18-2
18.1.5	Forced Stop Display	18-2

18.2 Corresponding SERVOPACK and SigmaWin+ Function Names . . 18-3

- 18.2.1 Corresponding SERVOPACK Utility Function Names 18-3
- 18.2.2 Corresponding SERVOPACK Monitor Display Function Names 18-5

Index

Revision History

Basic Information on SERVOPACKs

1

This chapter provides information required to select SERVOPACKs, such as SERVOPACK models and combinations with Servomotors.

1.1	The Σ-7 Series	1-3
1.2	Introduction to EtherCAT	1-4
1.2.1	Introduction to CANopen	1-4
1.2.2	CANopen over EtherCAT OSI Model	1-4
1.2.3	Sending and Receiving Data in EtherCAT (CoE) Communications	1-5
1.2.4	CoE Terminology	1-5
1.2.5	Data Types	1-6
1.2.6	Data Ranges	1-6
1.3	Interpreting the Nameplate	1-7
1.4	Part Names	1-8
1.5	Model Designations	1-10
1.5.1	Interpreting SERVOPACK Model Numbers	1-10
1.5.2	Interpreting Servomotor Model Numbers	1-11
1.6	Combinations of SERVOPACKs and Servomotors . .	1-12
1.6.1	Combinations of Rotary Servomotors and SERVOPACKs	1-12
1.6.2	Combinations of Linear Servomotors and SERVOPACKs	1-13
1.7	Functions	1-14

1.8 EtherCAT Communications LED Indicators . . 1-16

1.8.1	RUN	1-16
1.8.2	ERR	1-17
1.8.3	Link/Activity	1-17

1.1 The Σ -7 Series

The Σ -7-series SERVOPACKs are designed for applications that require frequent high-speed and high-precision positioning. The SERVOPACK will make the most of machine performance in the shortest time possible, thus contributing to improving productivity.

These SERVOPACKs support ZONE outputs.

ZONE outputs are used to output signals during preset ranges of positions. You can use the ZONE outputs as triggers for operations related to positioning.

Refer to the following chapter for details on ZONE outputs.

 7.14 ZONE Outputs (FT64 Specification) on page 7-58

1.2 Introduction to EtherCAT

The CANopen over EtherCAT (CoE) Communications Reference SERVOPACKs implement the CiA 402 CANopen drive profile for EtherCAT communications (real-time Ethernet communications).

Basic position, speed, and torque control are supported along with synchronous position, speed, and torque control. You can select the type of control to match your system from basic positioning to high-speed, high-precision path control.

You can also use EtherCAT communications to control the high-level servo control performance, advanced turning functions, and many actuators of the Σ-7 Series.

1.2.1 Introduction to CANopen

The CiA 402 CANopen profile is based on the IEC 61800-7-1, IEC61800-7-201, and IEC 61800-7-301 standards for international standardization of drive control and operation control.

1.2.2 CANopen over EtherCAT OSI Model

The OSI model implemented by the SERVOPACKs consists of three layers: the application layer (CANopen), the data link layer (EtherCAT), and the physical layer (Ethernet). The four layers other than the application layer, data link layer, and physical layer are not used. The data link layer is implemented with EtherCAT communications and the application layer is implemented with the DS402 CANopen drive profile.

This manual describes mainly the specifications of the application layer implemented in the SERVOPACKs. For detailed information on the data link layer (EtherCAT), refer to documentation provided by the EtherCAT Technology Group.

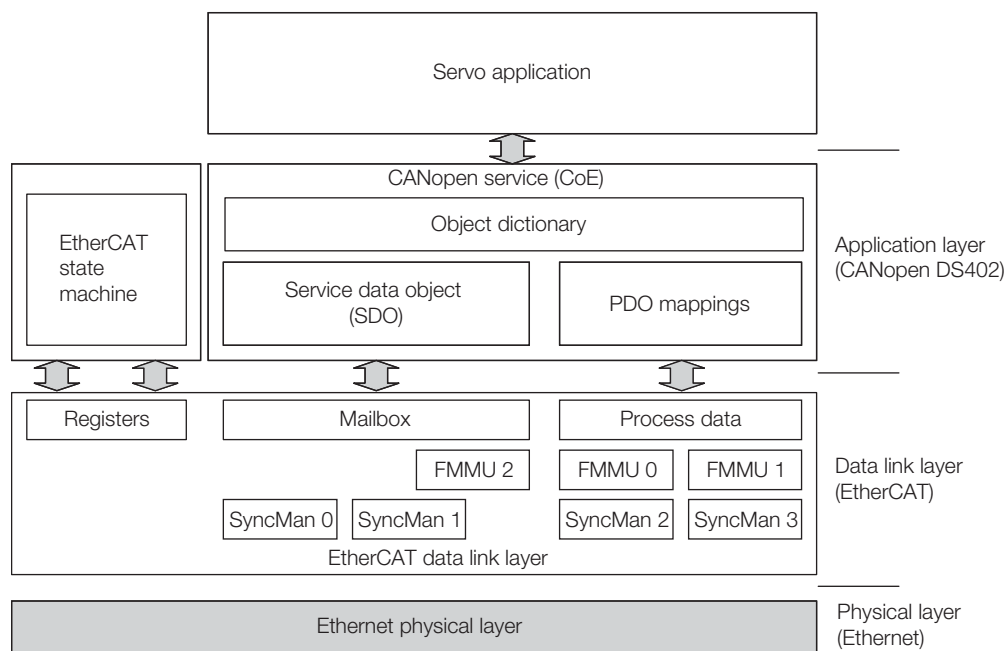

The object dictionary in the application layer includes parameters, application data, and PDO mapping information between the master and slaves.

The process data objects (PDOs) consist of the objects in the object dictionary that can be mapped to PDO mappings. The PDO mappings define the structure and contents of the process data.

1.2.3 Sending and Receiving Data in EtherCAT (CoE) Communications

Objects are used to send and receive data in EtherCAT (CoE) communications.

Reading and writing object data is performed in process data communications (PDO service), which transfers data cyclically, and in mailbox communications (SDO service), which transfers data non-cyclically.

Process data communications are used to read and write PDOs. Mailbox communications (SDO) are used to read and write object dictionary data entries.

1.2.4 CoE Terminology

The EtherCAT and CANopen terms that are used in this manual are described in the following table.

Term	Abbreviation	Description
CAN in Automation	CiA	A non-profit organization established in 1992 as a joint venture between companies to provide CAN technical information, product information, and marketing information.
Controller Area Network	CAN	Communications protocol for the physical layer and data link layer established for automotive LANs. It was established as an international standard as ISO 11898.
CANopen	CANopen	An upper-layer protocol based on the international CAN standard (EN 50325-4). It consists of profile specifications for the application layer, communications, applications, devices, and interfaces.
CANopen over EtherCAT	CoE	A network that uses Ethernet for the physical layer, EtherCAT for the data link layer, and CANopen for the application layer in a seven-layer OSI reference model.
Distributed Clocks	DC	A clock distribution mechanism that is used to synchronize the EtherCAT slaves with the EtherCAT master.
Electrically Erasable Programmable Read Only Memory	EEPROM	A ROM that can be electrically overwritten.
EtherCAT Slave Controller	ESC	A hardware chip that processes EtherCAT communications (such as loopbacks) and manages the distributed clock.
EtherCAT State Machine	ESM	A state machine in which the state of EtherCAT (the data link layer) changes according to transition conditions.
EtherCAT Technology Group	ETG	An international organization established in 2003 to provide support for developing EtherCAT technologies and to promote the spread of EtherCAT technologies.
Ethernet for Control Automation Technology	EtherCAT	An open network developed by Beckhoff Automation.
Fieldbus Memory Management Unit	FMMU	A unit that manages fieldbus memory.
INIT	INIT	The Init state in the EtherCAT state machine.
OPERATIONAL	OP	The Operational state in the EtherCAT state machine.
Object Dictionary	OD	A group of objects and structure supported by an EtherCAT SERVOPACK.
Process Data Object	PDO	Objects that are sent and received in cyclic communications.
Process Data Object Mapping	PDO mapping	Definitions of the applications objects that are sent with PDOs.
Service Data Object	SDO	Objects that are sent and received in mailbox communications.
PRE-OPERATIONAL	PREOP	The Pre-operational state in the EtherCAT state machine.
Process data	–	The data contained in application objects that are periodically transferred for measurements or controls.

Continued on next page.

Continued from previous page.

Term	Abbreviation	Description
SyncManager	–	The ESC unit that coordinates data exchange between the master and slaves.
Receive Process Data Object	RXPDO	The process data received by the ESC.
Transmit Process Data Object	TXPDO	The process data sent by the ESC.

1.2.5 Data Types

The following table lists the data types and ranges that are used in this manual.

Code	Data Type	Range
SINT	Signed 8-bit integer	-128 to 127
INT	Signed 16-bit integer	-32,768 to 32,767
DINT	Signed 32-bit integer	-2,147,483,648 to 2,147,483,627
USINT	Unsigned 8-bit integer	0 to 255
UINT	Unsigned 16-bit integer	0 to 65,535
UDINT	Unsigned 32-bit integer	0 to 4,294,967,295
STRING	Character string	–

1.2.6 Data Ranges

The following table lists the data units and notations that are used in this manual.

Notation	Description
Pos. unit	The user-defined position reference unit that is set in <i>position user unit</i> (2701h). 1 [Pos. unit] = 2701: 01h/2701: 02h [inc]
Vel. unit	The user-defined speed reference unit that is set in <i>velocity user unit</i> (2702h). 1 [Vel. unit] = 2702: 01h/2702: 02h [inc/s]
Acc. unit	The user-defined acceleration reference unit that is set in <i>acceleration user unit</i> (2703h). 1 [Acc. unit] = 2703: 01h/2703: 02h $\times 10^4$ [inc/s ²]
Trq. unit	The user-defined torque reference unit that is set in <i>torque user unit</i> (2704h). 1 [Trq. unit] = 2704: 01h/2704: 02h [%]
inc	This is the encoder pulse unit. For a 24-bit encoder, the resolution is $16,777,216 \times Pn210/Pn20E$ [inc] per rotation.

1.3 Interpreting the Nameplate

The following basic information is provided on the nameplate.

Connect ground with terminal marked with this symbol.
Connectez le fil de terre à la borne repérée par ce symbole.

SERVOPACK MODEL SGD7S-120DA0B026F64 IP10

INPUT	MAIN	3PH 380-480V 3PH:8.6A	50/60Hz	SURROUNDING AIR TEMPERATURE -5 to 55°C
	CONT.	DC24V±15% 1.2A		
OUTPUT	3PH 0-480V 0-500Hz			
	11.9A 3.0KW			

BTO/N
.....
O/N
S/N

UL CERTIFIED SURVIBUS-CA E147823
CE
15
TCV 800
1R EtherCAT

YASKAWA ELECTRIC CORPORATION
2-1 Kurosakishiroishi, Yahatanishi-ku,
Kitakyusyu 806-0004 Japan MADE IN UK

1.4 Part Names

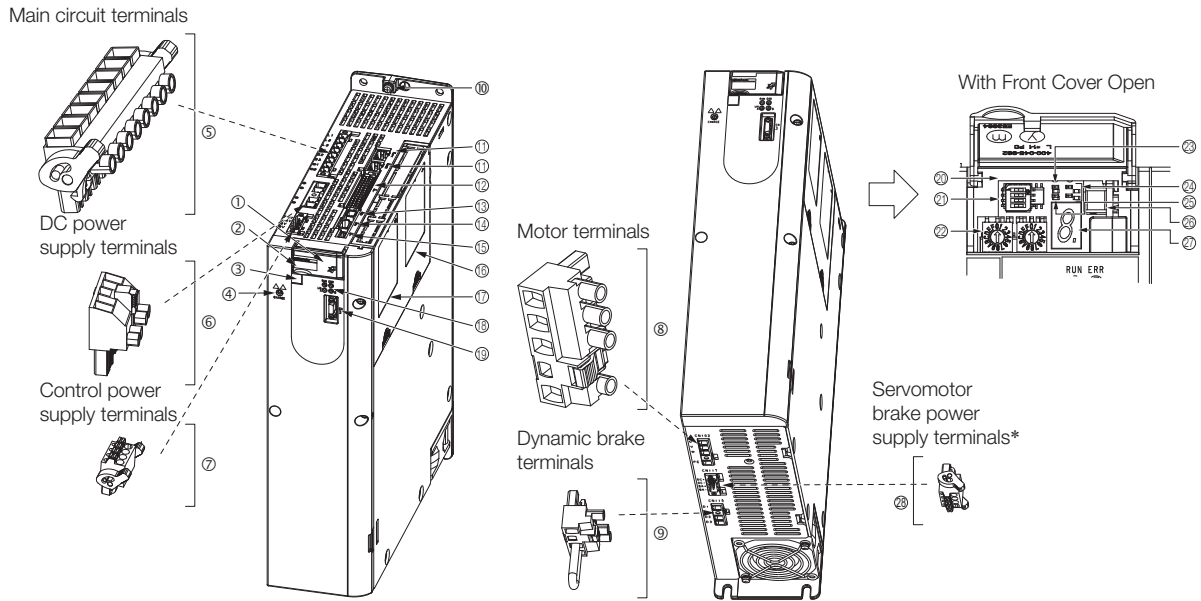

No.	Name	Description	Reference
①	Front Cover	—	—
②	Model	The model of the SERVOPACK.	page 1-10
③	QR Code	The QR code that is used by the MechatroCloud service.	—
④	CHARGE	Lit while the main circuit power is being supplied. Note: Even if you turn OFF the main circuit power supply, this indicator will be lit as long as the internal capacitor remains charged. Do not touch the main circuit or motor terminals while this indicator is lit. Doing so may result in electric shock.	—
⑤	Main Circuit Terminals	The terminals depend on the main circuit power supply input specifications of the SERVOPACK.	page 4-11
⑥	DC Power Supply Terminals	—	page 4-11
⑦	Control Power Supply Terminals	The connection terminals for the control power supply.	page 4-11
⑧	Servomotor Terminals (U, V, and W) and Ground Terminal (PE)	The connection terminals for the Servomotor Main Circuit Cable (power line).	page 4-19
⑨	Dynamic Brake Terminals	The connection terminals for a Dynamic Brake Resistor.	page 5-7
⑩	Ground Terminal (⊕)	The ground terminals to prevent electric shock. Always connect this terminal.	—
⑪	EtherCAT Communications Connectors (Input: CN6A, Output: CN6B)	Connect to EtherCAT devices.	page 4-39
⑫	I/O Signal Connector (CN1)	Connects to sequence I/O signals.	page 4-30
⑬	Safety Connector (CN8)	Connects to a safety function device.	page 4-37
⑭	Encoder Connector (CN2)	<ul style="list-style-type: none"> Rotary Servomotor: Connects to the encoder in the Servomotor. Linear Servomotor: Connects to a Serial Converter Unit or linear encoder. 	page 4-19
⑮	Computer Connector (CN7)	A USB connector to connect a computer.	page 4-41
⑯	Safety Option Module Connector	Connects to a Safety Option Module.	—
⑰	Feedback Option Module Connector	Connects to a Feedback Option Module.	—
⑱	Communications Status Indicators	Indicate the status of EtherCAT communications.	page 1-16

Continued on next page.

Continued from previous page.

No.	Name	Description	Reference
⑲	Serial Communications Connector (CN3)	Connects to the Digital Operator.	page 4-41
⑳	Serial Number	–	–
㉑	DIP Switch (S3)	Not used.	page 13-5
㉒	EtherCAT secondary address (S1 and S2)	Use these switches to set the device ID and address.	
㉓	PWR	Lights when the control power is being supplied.	–
㉔	CN	Not used.	–
㉕	L1 and L2		–
㉖	Analog Monitor Connector (CN5)	You can use a special cable (peripheral device) to monitor the motor speed, torque reference, or other values.	page 4-41
㉗	Panel Display	Displays the servo status with a seven-segment display.	–
㉘	Servomotor Brake Power Supply Terminals (CN117)*	Connect to the power supply for the Servomotor brake.	–

* SERVOPACKs without built-in Servomotor brake control do not have these terminals.

1.5 Model Designations

1.5.1 Interpreting SERVOPACK Model Numbers

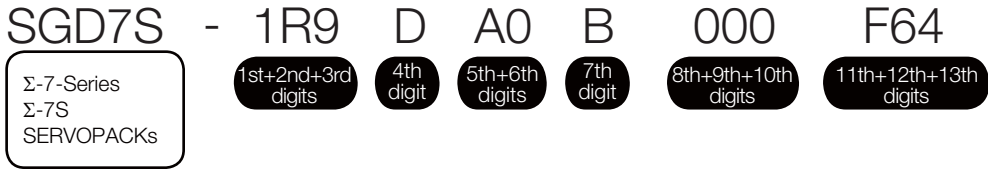

1st+2nd+3rd digits Maximum Applicable Motor Capacity

Voltage	Code	Specification
Three-Phase, 400 VAC	1R9	0.5 kW
	3R5	1.0 kW
	5R4	1.5 kW
	8R4	2.0 kW
	120	3.0 kW
	170	5.0 kW
	210	6.0 kW
	260	7.5 kW
	280	11.0 kW
370	15.0 kW	

4th digit Voltage

Code	Specification
D	400 VAC

5th+6th digits Interface*

Code	Specification
A0	EtherCAT communications reference

7th digit Design Revision Order

B

8th+9th+10th digits Hardware Options Specification

Code	Specification	Applicable Models
000	Without options	All models
026	Built-in Servomotor brake control	All models

11th+12th+13th digits FT/EX Specification

Code	Specification
F64	ZONE outputs

* The same SERVOPACKs are used for both Rotary Servomotors and Linear Servomotors.

1.5.2 Interpreting Servomotor Model Numbers

This section outlines the model numbers of Σ -7-series Servomotors. Refer to the relevant manual in the following list for details.

📖 Σ -7-Series Rotary Servomotor with 400 V-Input Power Product Manual (Manual No.: SIEP S800001 86)

📖 Σ -7-Series Linear Servomotor with 400 V-Input Power Product Manual (Manual No.: SIEP S800001 81)

Rotary Servomotors

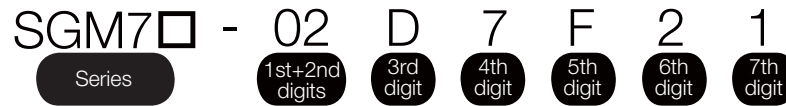

Series Σ -7-Series Servomotors

Code	Specifications
SGM7J	Medium inertia, high speed
SGM7A	Low inertia, high speed
SGM7G	Medium inertia, low speed, high torque
	Medium inertia, high speed, high torque

- 1st+2nd digits** Rated Output
- SGM7J: 200 W to 1.5 kW
 - SGM7A: 200 W to 7.0 kW
 - SGM7G: 450 W to 15 kW

- 3rd digit** Power Supply Voltage
- 400 VAC

- 4th digit** Serial Encoder Specification
- 24-bit absolute
 - 24-bit incremental

5th digit Design Revision Order

6th digit Shaft End Specification

- Straight without key
- Straight with key and tap

7th digit Options

- With holding brake
- With dust seal

Linear Servomotors



Series Σ -7-Series Servomotors

1st digit Servomotor Type

Code	Specification
F	Models with F-type iron core
T	Models with T-type iron core

2nd digit Moving Coil/Magnetic Way

Code	Specification
W	Moving Coil
W2	
M	Magnetic Way
M2	

3rd digit on

The specifications for the 3rd digit on depend on the Servomotor type.

1.6 Combinations of SERVOPACKs and Servomotors

1.6.1 Combinations of Rotary Servomotors and SERVOPACKs

Rotary Servomotor Model		Capacity	SERVOPACK Model
			SGD7S-
SGM7J Models (Medium Inertia, High Speed), Rated motor speed: 3,000 min ⁻¹	SGM7J-02D□F	200 W	1R9D
	SGM7J-04D□F	400 W	
	SGM7J-08D□F	750 W	3R5D
	SGM7J-15D□F	1.5 kW	5R4D
SGM7A Models (Low Inertia, High Speed), Rated motor speed: 3,000 min ⁻¹	SGM7A-02D□F	200 W	1R9D
	SGM7A-04D□F	400 W	
	SGM7A-08D□F	750 W	3R5D
	SGM7A-10D□F	1.0 kW	5R4D
	SGM7A-15D□F	1.5 kW	
	SGM7A-20D□F	2.0 kW	8R4D
	SGM7A-25D□F	2.5 kW	120D
	SGM7A-30D□F	3.0 kW	
	SGM7A-40D□F	4.0 kW	170D
	SGM7A-50D□F	5.0 kW	
SGM7A-70D□F	7.0 kW	260D	
SGM7G Models Standard Models (Medium Inertia, Low Speed, High Torque), Rated motor speed: 1,500 min ⁻¹	SGM7G-05D□F	450 W	1R9D
	SGM7G-09D□F	850 W	3R5D
	SGM7G-13D□F	1.3 kW	5R4D
	SGM7G-20D□F	1.8 kW	8R4D
	SGM7G-30D□F	2.9 kW	120D
	SGM7G-44D□F	4.4 kW	170D
	SGM7G-55D□F	5.5 kW	210D
	SGM7G-75D□F	7.5 kW	260D
	SGM7G-1AD□F	11.0 kW	280D
	SGM7G-1ED□F	15.0 kW	370D
SGM7G Models High-speed Models (Medium Inertia, High Speed, High Torque) Rated motor speed: 1,500 min ⁻¹	SGM7G-05D□R	450 W	3R5D
	SGM7G-09D□R	850 W	5R4D
	SGM7G-13D□R	1.3 kW	8R4D
	SGM7G-20D□R	1.8 kW	120D
	SGM7G-30D□R	2.9 kW	170D
	SGM7G-44D□R	4.4 kW	210D

1.6.2 Combinations of Linear Servomotors and SERVOPACKs

Linear Servomotor Model		Rated Force [N]	Instantaneous Maximum Force [N]	SERVOPACK Model
				SGD7S-
SGLF (Models with F-type Iron Cores)	SGLFW-35D120A	80	220	1R9D
	SGLFW-35D230A	160	440	1R9D
	SGLFW-50D200B	280	600	3R5D
	SGLFW-50D380B	560	1200	5R4D
	SGLFW-1ZD200B			
	SGLFW-1ZD380B	1120	2400	120D
	SGLFW2-30D070A	45	135	1R9D
	SGLFW2-30D120A	90	270	1R9D
	SGLFW2-30D230A	180	540	1R9D
	SGLFW2-45D200A	280	840	3R5D
	SGLFW2-45D380A	560	1680	8R4D
	SGLFW2-90D200A			5R4D
	SGLFW2-90D380A	1120	3360	120D
	SGLFW2-90D560A	1680	5040	170D
	SGLFW2-1DD380A	1680	5040	170D
	SGLFW2-1DD560A	2520	7560	260D
	SGLT (Models with T-type Iron Cores)	SGLTW-35D170H	300	600
SGLTW-35D320H		600	1200	8R4D
SGLTW-40D400B		670	2600	120D
SGLTW-40D600B		1000	4000	170D
SGLTW-50D170H		450	900	3R5D
SGLTW-50D320H		900	1800	8R4D
SGLTW-80D400B		1300	5000	170D
SGLTW-80D600B		2000	7500	260D

1.7 Functions

This section lists the functions provided by SERVOPACKs. Refer to the reference pages for details on the functions.

- **Functions Related to the Machine**

Function	Reference
Power Supply Type Settings for the Main Circuit and Control Circuit	page 6-12
Automatic Detection of Connected Motor	page 6-13
Motor Direction Setting	page 6-14
Linear Encoder Pitch Setting	page 6-15
Writing Linear Servomotor Parameters	page 6-16
Selecting the Phase Sequence for a Linear Servomotor	page 6-20
Polarity Sensor Setting	page 6-22
Polarity Detection	page 6-23
Overtravel Function and Settings	page 6-26
Holding Brake	page 6-32
Motor Stopping Methods for Servo OFF and Alarms	page 6-37
Resetting the Absolute Encoder	page 6-49
Setting the Origin of the Absolute Encoder	page 6-52
Setting the Regenerative Resistor Capacity	page 6-55
Operation for Momentary Power Interruptions	page 7-14
SEMI F47 Function	page 7-15
Setting the Motor Maximum Speed	page 7-17
Software Limits	page 7-25
Multiturn Limit Setting	page 7-36
Adjustment of Motor Current Detection Signal Offset	page 7-50
Forcing the Motor to Stop	page 7-55
Overheat Protection	page 7-63
Speed Ripple Compensation	page 9-59
Current Control Mode Selection	page 9-70
Current Gain Level Setting	page 9-71
Speed Detection Method Selection	page 9-71
Fully-Closed Loop Control	page 11-1
Safety Functions	page 12-1
Touch Probe	page 14-23

- **Functions Related to the Host Controller**

Function	Reference
Electronic Gear Settings	page 6-42
I/O Signal Allocations	page 7-4
ALM (Servo Alarm) Signal	page 7-7
/WARN (Warning) Signal	page 7-7
/TGON (Rotation Detection) Signal	page 7-8
/S-RDY (Servo Ready) Signal	page 7-8
/V-CMP (Speed Coincidence Detection) Signal	page 7-9
/COIN (Positioning Completion) Signal	page 7-10
/NEAR (Near) Signal	page 7-11

Continued on next page.

Continued from previous page.

Function	Reference
Speed Limit during Torque Control	page 7-12
/VLT (Speed Limit Detection) Signal	page 7-12
Encoder Divided Pulse Output	page 7-18
Selecting Torque Limits	page 7-26
Vibration Detection Level Initialization	page 7-46
Alarm Reset	page 16-42
Replacing the Battery	page 16-3
Setting the Position Deviation Overflow Alarm Level	page 9-8

- **Functions to Achieve Optimum Motions**

Function	Reference
Tuning-less Function	page 9-12
Autotuning without a Host Reference	page 9-23
Autotuning with a Host Reference	page 9-34
Custom Tuning	page 9-41
Anti-Resonance Control Adjustment	page 9-50
Vibration Suppression	page 9-55
Gain Selection	page 9-65
Friction Compensation	page 9-68
Backlash Compensation	page 9-72
Model Following Control	page 9-84
Compatible Adjustment Functions	page 9-87
Mechanical Analysis	page 9-91
Easy FFT	page 9-93

- **Functions for Trial Operation during Setup**

Function	Reference
Software Reset	page 7-44
Trial Operation for the Servomotor without a Load	page 8-7
Program Jogging	page 8-13
Origin Search	page 8-19
Test without a Motor	page 8-21
Monitoring Machine Operation Status and Signal Waveforms	page 10-7

- **Functions for Inspection and Maintenance**

Function	Reference
Write Prohibition Setting for Parameters	page 6-7
Initializing Parameter Settings	page 6-10
Automatic Detection of Connected Motor	page 6-13
Monitoring Product Information	page 10-2
Monitoring Product Life	page 10-2
Alarm History Display	page 16-43
Alarm Tracing	page 10-17

1.8 EtherCAT Communications LED Indicators

This diagram shows details of the EtherCAT communications LED indicators.

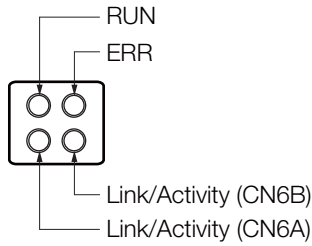

1.8.1 RUN

The RUN indicator shows the status of EtherCAT communications.

Status	LED Indicator		Description
	Status	Pattern	
Off	Constantly off.		EtherCAT communications are in INIT state.
Blinking	On Off		EtherCAT communications are in PRE-OPERATIONAL state.
Double flash	On Off		EtherCAT communications are in SAFE-OPERATIONAL state.
On	Constantly on.		EtherCAT communications are in OPERATIONAL state.
Flickering	On Off		EtherCAT communications have been started but are not yet in INIT state.

1.8.2 ERR

The ERR indicator shows the error status of EtherCAT communications.

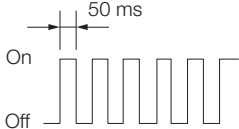
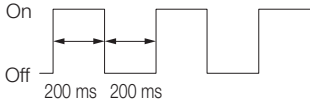
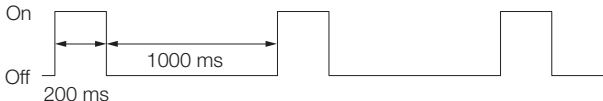
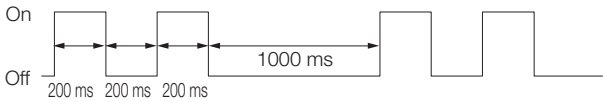
LED Indicator		Description
Status	Pattern	
Off	Constantly off.	The EtherCAT communications are in working condition.
Flickering		Booting Error was detected.
Blinking		State change commanded by master is impossible due to register or object settings.
Single flash		Synchronization Error, the EtherCAT Network Module enters SAFE-OPERATIONAL state automatically.
Double flash		An application (Sync Manager) watchdog timeout has occurred.
On	Constantly on.	A PDI Watchdog timeout has occurred.

1.8.3 Link/Activity

The Link/Activity indicators show whether Communications Cables are connected to the CN6A and CN6B connectors and whether communications are active.

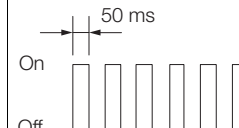
LED Indicator		Description
Status	Pattern	
Off	Constantly off.	A Communications Cable is not physically connected. A EtherCAT controller is not started up.
Flickering		Data are being exchanged.
On	Constantly on.	A Communications Cable is physically connected, but no data being exchanged.

Selecting a SERVOPACK

2

This chapter provides information required to select SERVOPACKs, such as specifications, block diagrams, dimensional drawings, and connection examples.

2.1	Ratings and Specifications	2-2
2.1.1	Ratings	2-2
2.1.2	SERVOPACK Overload Protection Characteristics	2-3
2.1.3	Specifications	2-4
2.2	Block Diagrams	2-8
2.2.1	SERVOPACKs without Built-in Servomotor Brake Control	2-8
2.2.2	SERVOPACKs with Built-in Servomotor Brake Control	2-11
2.3	External Dimensions	2-14
2.3.1	Front Cover Dimensions and Connector Specifications	2-14
2.3.2	SERVOPACK External Dimensions	2-16
2.4	Examples of Standard Connections between SERVOPACKs and Peripheral Devices . .	2-18

2.1 Ratings and Specifications

This section gives the ratings and specifications of SERVOPACKs.

2.1.1 Ratings

Three-Phase, 400 VAC

Model SGD7S-		1R9D	3R5D	5R4D	8R4D	120D	170D	210D	260D	280D	370D	
Maximum Applicable Motor Capacity [kW]		0.5	1	1.5	2	3	5	6	7.5	11	15	
Continuous Output Current [Arms]		1.9	3.5	5.4	8.4	11.9	16	20.8	25.7	28.1	37.2	
Instantaneous Maximum Output Current [Arms]		5.5	8.5	14	21	28	42	55	65	70	85	
Main Circuit	Power Supply	Three-phase, 380 VAC to 480 VAC, -15% to +10%, 50 Hz/60 Hz										
	Input Current [Arms]*	1.4	2.9	4.3	5.8	8.6	14.5	17.4	21.7	31.8	43.4	
Control Power Supply	Power Supply	24 VDC \pm 15%										
	Input Current [Arms]*	1.2						1.4		1.7		
Power Supply Capacity [kVA]*		1.1	2.3	3.5	4.5	7.1	11.7	12.4	14.4	21.9	30.6	
Power Loss*	Main Circuit Power Loss [W]	19.4	30.3	62.8	90.1	137.7	188.7	188.4	228.5	278.2	389.8	
	Control Circuit Power Loss [W]	21						22	28	32		
	Built-in Regenerative Resistor Power Loss [W]	14	14	28	28	28	36	(180)*		(240)*		
	Total Power Loss [W]	54.4	65.3	111.8	139.1	186.7	246.7	216.4	256.5	310.2	389.8	
Regenerative Resistor	Built-In Regenerative Resistor	Resistance [Ω]	75	75	75	43	43	27	-			
		Capacity [W]	70	70	140	140	140	180	-			
	Minimum Allowable External Resistance [Ω]	75	75	75	43	43	27	18	18	14.25	14.25	
Overvoltage Category		III										

* This is the net value at the rated load.

540 VDC

Model SGD7S-		1R9D	3R5D	5R4D	8R4D	120D	170D	210D	260D	280D	370D
Maximum Applicable Motor Capacity [kW]		0.5	1	1.5	2	3	5	6	7.5	11	15
Continuous Output Current [Arms]		1.9	3.5	5.4	8.4	11.9	16	20.8	25.7	28.1	37.2
Instantaneous Maximum Output Current [Arms]		5.5	8.5	14	21	28	42	55	65	70	85
Main Circuit	Power Supply	513 VDC to 648 VDC, -15% to +10%									
	Input Current [Arms]*	2	3.3	5.5	6.8	11	18	19.6	26.2	38.3	47.6
Control Power Supply	Power Supply	24 VDC \pm 15%									
	Input Current [Arms]*	1.2						1.4		1.7	
Power Supply Capacity [kVA]*		1.1	2.3	3.5	4.5	7.1	11.7	12.4	14.4	21.9	30.6
Power Loss*	Main Circuit Power Loss [W]	16.4	24.4	48.5	73.7	110.4	144.5	188.4	228.5	278.2	389.8
	Control Circuit Power Loss [W]	21						22	28	32	
	Total Power Loss [W]	37.4	45.4	69.5	94.7	131.4	166.5	216.4	228.5	310.2	389.8
Overvoltage Category		III									

* This is the net value at the rated load.

2.1.2 SERVOPACK Overload Protection Characteristics

The overload detection level is set for hot start conditions with a SERVOPACK surrounding air temperature of 55°C.

An overload alarm (A.710 or A.720) will occur if overload operation that exceeds the overload protection characteristics shown in the following diagram (i.e., operation on the right side of the applicable line) is performed.

The actual overload detection level will be the detection level of the connected SERVOPACK or Servomotor that has the lower overload protection characteristics.

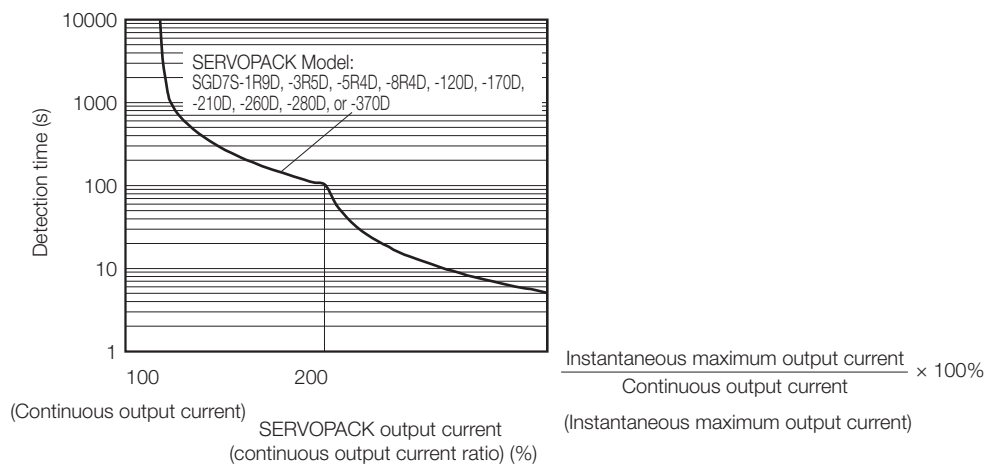

In most cases, that will be the overload protection characteristics of the Servomotor.



Note: The above overload protection characteristics do not mean that you can perform continuous duty operation with an output of 100% or higher.

For a Yaskawa-specified combination of SERVOPACK and Servomotor, maintain the effective torque within the continuous duty zone of the torque-motor speed characteristic of the Servomotor.

2.1.3 Specifications

Item		Specification
Control Method		IGBT-based PWM control, sine wave current drive
Feedback	With Rotary Servomotor	Serial encoder: 24 bits (incremental encoder/absolute encoder)
	With Linear Servomotor	<ul style="list-style-type: none"> Absolute linear encoder (The signal resolution depends on the absolute linear encoder.) Incremental linear encoder (The signal resolution depends on the incremental linear encoder or Serial Converter Unit.)
Environmental Conditions	Surrounding Air Temperature* ¹	-5°C to 55°C However, the range for the SGD7S-370D is -5°C to 40°C. (With derating, usage is possible between 55°C and 60°C. For the SGD7S-370D, however, usage is possible between 40°C to 60°C.) Refer to the following section for derating specifications.  3.6 Derating Specifications on page 3-7
	Storage Temperature	-20°C to 85°C
	Surrounding Air Humidity	95% relative humidity max. (with no freezing or condensation)
	Storage Humidity	95% relative humidity max. (with no freezing or condensation)
	Vibration Resistance	4.9 m/s ²
	Shock Resistance	19.6 m/s ²
	Degree of Protection	IP10
	Pollution Degree	2 <ul style="list-style-type: none"> Must be no corrosive or flammable gases. Must be no exposure to water, oil, or chemicals. Must be no dust, salts, or iron dust.
	Altitude	1,000 m or less. (With derating, usage is possible between 1,000 m and 2,000 m.) Refer to the following section for derating specifications.  3.6 Derating Specifications on page 3-7
Others	Do not use the SERVOPACK in the following locations: Locations subject to static electricity, noise, strong electromagnetic/magnetic fields, or radioactivity	
Compliant Standards		Refer to the following section for details.  Compliance with UL Standards, EU Directives, and Other Safety Standards on page xxi
Mounting		Base-mounted
Performance	Speed Control Range	1:5000 (At the rated torque, the lower limit of the speed control range must not cause the Servomotor to stop.)
	Coefficient of Speed Fluctuation* ²	±0.01% of rated speed max. (for a load fluctuation of 0% to 100%)
		0% of rated speed max. (for a voltage fluctuation of ±10%)
		±0.1% of rated speed max. (for a temperature fluctuation of 25°C ±25°C)
	Torque Control Precision (Repeatability)	±1%
Soft Start Time Setting	0 s to 10 s (Can be set separately for acceleration and deceleration.)	

Continued on next page.

Continued from previous page.

Item		Specification	
I/O Signals	Encoder Divided Pulse Output	Phase A, phase B, phase C: Line-driver output Number of divided output pulses: Any setting is allowed.	
	Linear Servomotor Overheat Protection Signal Input	Number of input points: 1 Input voltage range: 0 V to +5 V	
	Sequence Input Signals	Input Signals That Can Be Allocated	Allowable voltage range: 24 VDC \pm 20% Number of input points: 7 (Input method: Sink inputs or source inputs)
			Input Signals <ul style="list-style-type: none"> • P-OT (Forward Drive Prohibit) and N-OT (Reverse Drive Prohibit) signals • /Probe1 (Probe 1 Latch Input) signal • /Probe2 (Probe 2 Latch Input) signal • /Home (Home Switch Input) signal • /P-CL (Forward External Torque Limit) and /N-CL (Reverse External Torque Limit) signals • /DBANS (Dynamic Brake Answer) signal^{*3} • /SI0 and /SI3 (General-Purpose Input) signals A signal can be allocated and the positive and negative logic can be changed.
Sequence Output Signals	Output Signals That Can Be Allocated	Fixed Output	
		Output Signals	
Communications	RS-422A Communications (CN502)	Inter-faces	Digital Operator (JUSP-OP05A-1-E).
		1:N Communications	Up to N = 15 stations possible for RS-422A port
		Axis Address Setting	Set with parameters.
	USB Communications (CN7)	Interface	Personal computer (with SigmaWin+) The software version of the SigmaWin+ must be version 7.11 or higher.
Communications Standard		Conforms to USB2.0 standard (12 Mbps).	

Continued on next page.

2.1 Ratings and Specifications

2.1.3 Specifications

Continued from previous page.

Item		Specification
Displays/Indicators		CHARGE, PWR, RUN, ERR, and L/A (A and B) indicators, and one-digit seven-segment display
EtherCAT Communications Setting Switches		EtherCAT secondary address (S1 and S2), 16 positions
EtherCAT Communications	Compliant Communications Standards	IEC 61158 Type 12, IEC 61800-7 CiA402 Drive Profile
	Physical Layer	100BASE-TX (IEEE 802.3)
	Communications Connectors	CN6A (RJ45): EtherCAT signal input connector CN6B (RJ45): EtherCAT signal output connector
	Cable	Category 5, 4 shielded twisted pairs * The cable is automatically detected with AUTO MDIX.
	Sync Manager	SM0: Mailbox output, SM1: Mailbox input, SM2: Process data output, and SM3: Process data input
	FMMU	FMMU 0: Mapped in process data output (RxPDO) area. FMMU 1: Mapped in process data input (TxPDO) area. FMMU 2: Mapped to mailbox status.
	EtherCAT Commands (Data Link Layer)	APRD, FPRD, BRD, LRD, APWR, FPWR, BWR, LWR, ARMW, and FRMW (APRW, FPRW, BRW, and LRW commands are not supported.)
	Process Data	Assignments can be changed with PDO mapping.
	Mailbox (CoE)	Emergency messages, SDO requests, SDO responses, and SDO information (TxPDO/RxPDO and remote TxPDO/RxPDO are not supported.)
	Distributed Clocks	Free-Run Mode and DC Mode (Can be switched.) Applicable DC cycles: 125 μ s to 4 ms in 125- μ s increments
	Slave Information Interface	256 bytes (read-only)
Indicators	EtherCAT communications in progress: Link/Activity x 2 EtherCAT communications status: RUN x 1 EtherCAT error status: ERR x 1	
CiA402 Drive Profile		<ul style="list-style-type: none"> • Homing Mode • Profile Position Mode • Interpolated Position Mode • Profile Velocity Mode • Profile Torque Mode • Cyclic Synchronous Position Mode • Cyclic Synchronous Velocity Mode • Cyclic Synchronous Torque Mode • Touch Probe Function • Torque Limit Function
Analog Monitor (CN5)		Number of points: 2 Output voltage range: ± 10 VDC (effective linearity range: ± 8 V) Resolution: 16 bits Accuracy: ± 20 mV (Typ) Maximum output current: ± 10 mA Settling time ($\pm 1\%$): 1.2 ms (Typ)
Dynamic Brake (DB)*5		Activated when a servo alarm or overtravel (OT) occurs, or when the power supply to the main circuit or servo is OFF.
Regenerative Processing		Built-in Refer to the catalog for details.
Overtravel (OT) Prevention		Stopping with dynamic brake, deceleration to a stop, or coasting to a stop for the P-OT (Forward Drive Prohibit) or N-OT (Reverse Drive Prohibit) signal
Protective Functions		Overcurrent, overvoltage, low voltage, overload, regeneration error, etc.
Utility Functions		Gain adjustment, alarm history, jogging, origin search, etc.

Continued on next page.

Continued from previous page.

Item		Specification
Safety Functions	Inputs	/HWBB1 and /HWBB2: Base block signals for Power Modules
	Output	EDM1: Monitors the status of built-in safety circuit (fixed output).
	Compliant Standards*6	ISO13849-1 PLe (category 3), IEC61508 SIL3
Applicable Option Modules		Fully-closed Modules

*1. If you combine a Σ -7-Series SERVOPACK with a Σ -V-Series Option Module, the surrounding air temperature specification of the Σ -V-Series SERVOPACKs must be used, i.e., 0°C to 55°C. Also, the applicable surrounding range cannot be increased by derating.

*2. The coefficient of speed fluctuation for load fluctuation is defined as follows:

$$\text{Coefficient of speed fluctuation} = \frac{\text{No-load motor speed} - \text{Total-load motor speed}}{\text{Rated motor speed}} \times 100\%$$

*3. Usable only with SGD7S-210D, -260D, -280D, -370D SERVOPACKs.

*4. The /DBON signal can be used as positive logic.

*5. The SGD7S-210D, -260D, -280D, and -370D do not have a dynamic brake (DB). If a dynamic brake is necessary, create an external dynamic brake circuit.
Refer to the following chapter for details on the dynamic brake.

 *Chapter 5 Wiring and Settings for the Dynamic Brake*

*6. Always perform risk assessment for the system and confirm that the safety requirements are met.

2.2 Block Diagrams

This section provides a block diagram of the interior of the SERVOPACKs.

2.2.1 SERVOPACKs without Built-in Servomotor Brake Control

SGD7S-1R9D, -3R5D, -5R4D, -8R4D, -120D, and -170D

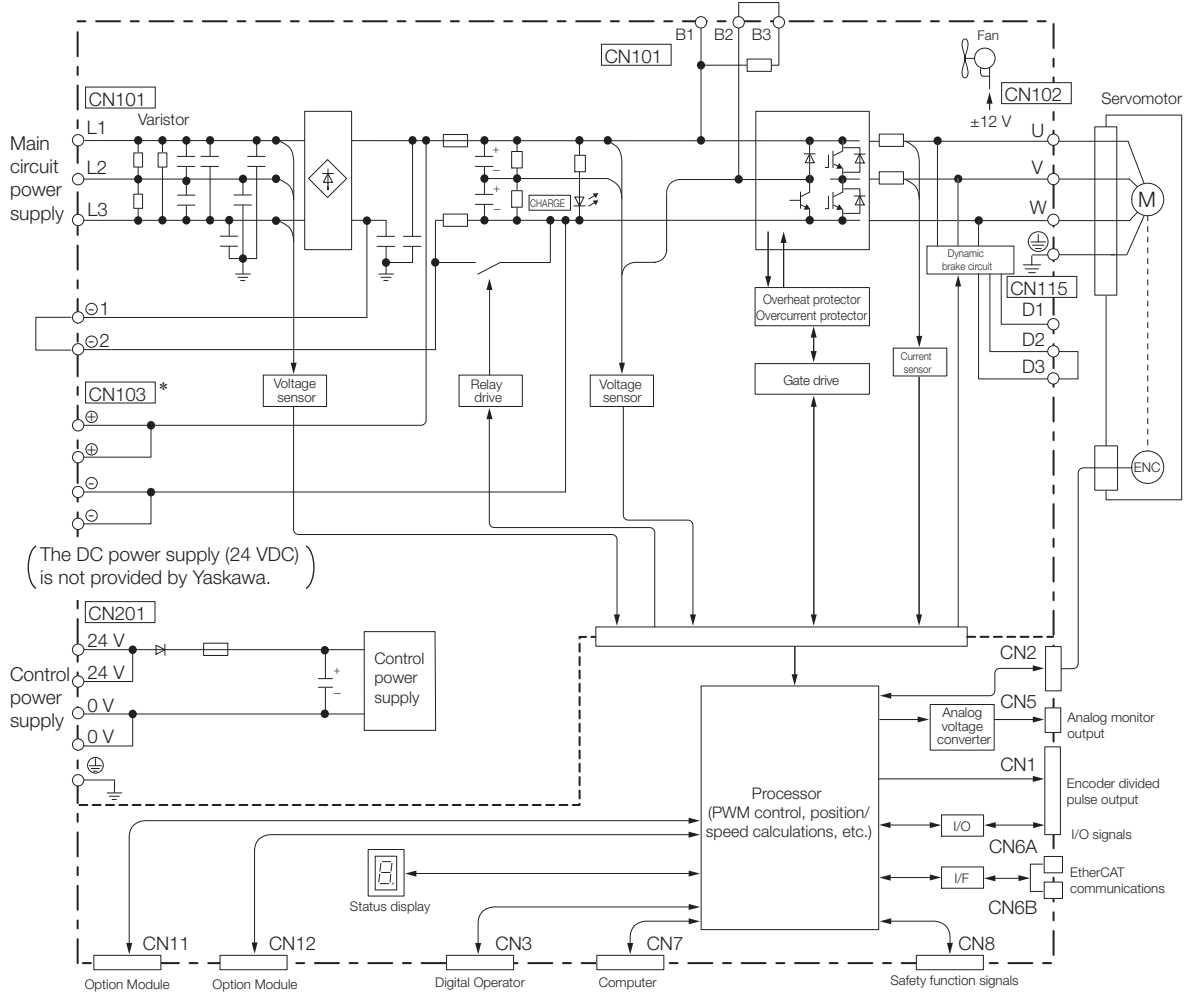

* If using these terminals, contact your YASKAWA representative.

SGD7S-210D and -260D

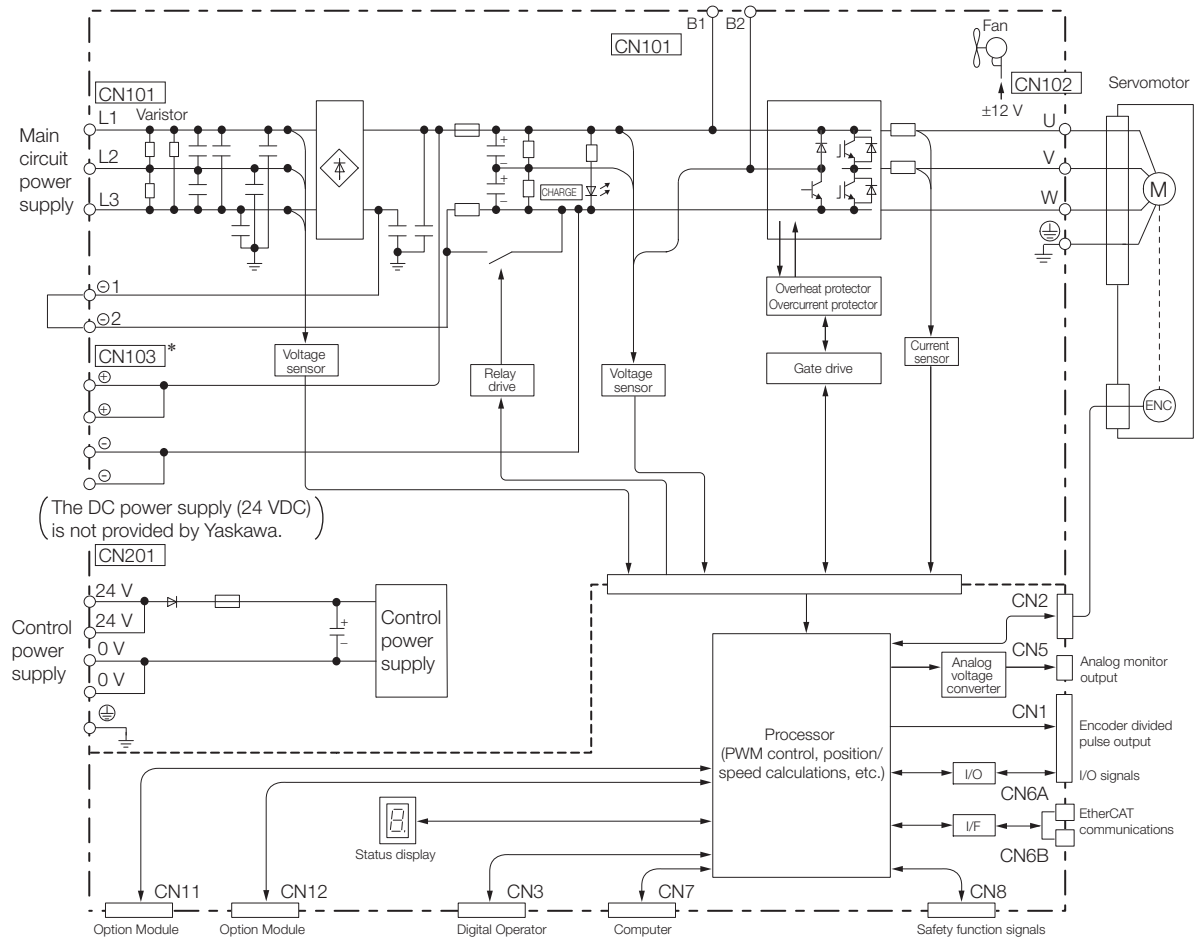

* If using these terminals, contact your YASKAWA representative.

2.2 Block Diagrams

2.2.1 SERVOPACKs without Built-in Servomotor Brake Control

SGD7S-280D and -370D

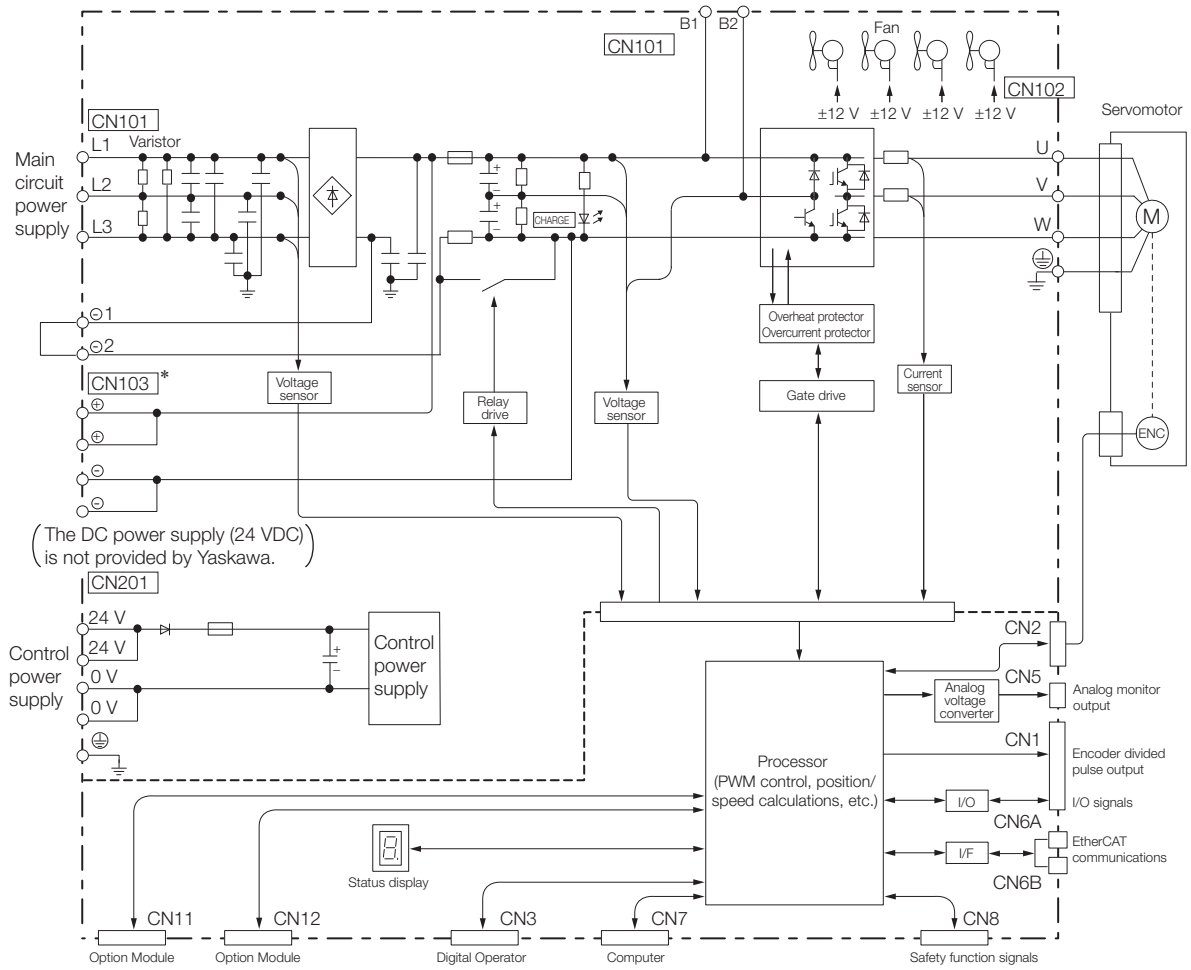

* If using these terminals, contact your YASKAWA representative.

2.2.2 SERVOPACKs with Built-in Servomotor Brake Control

SGD7S-1R9D, -3R5D, -5R4D, -8R4D, -120D, and -170D

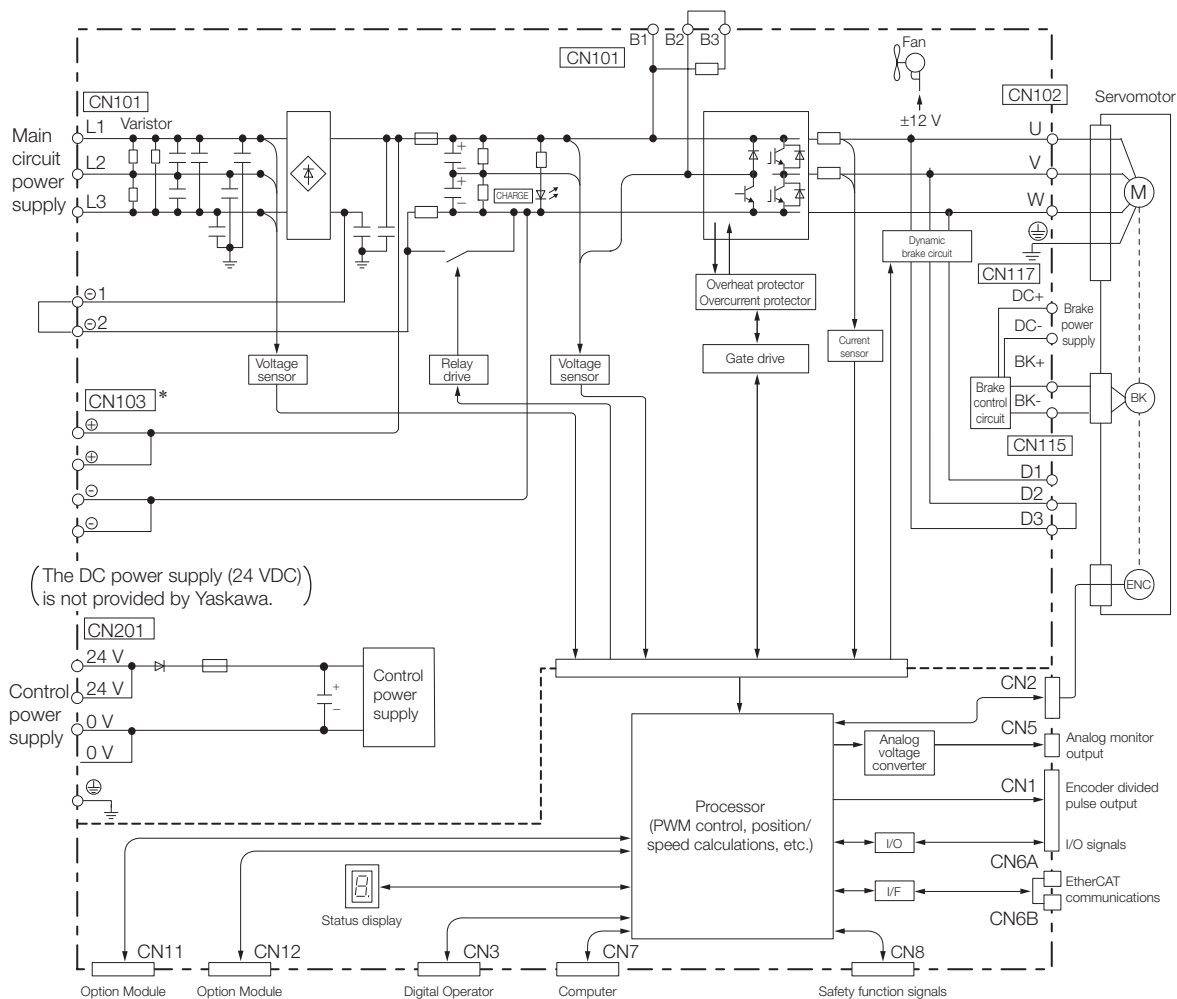

* If using these terminals, contact your YASKAWA representative.

2.2 Block Diagrams

2.2.2 SERVOPACKs with Built-in Servomotor Brake Control

SGD7S-210D and -260D

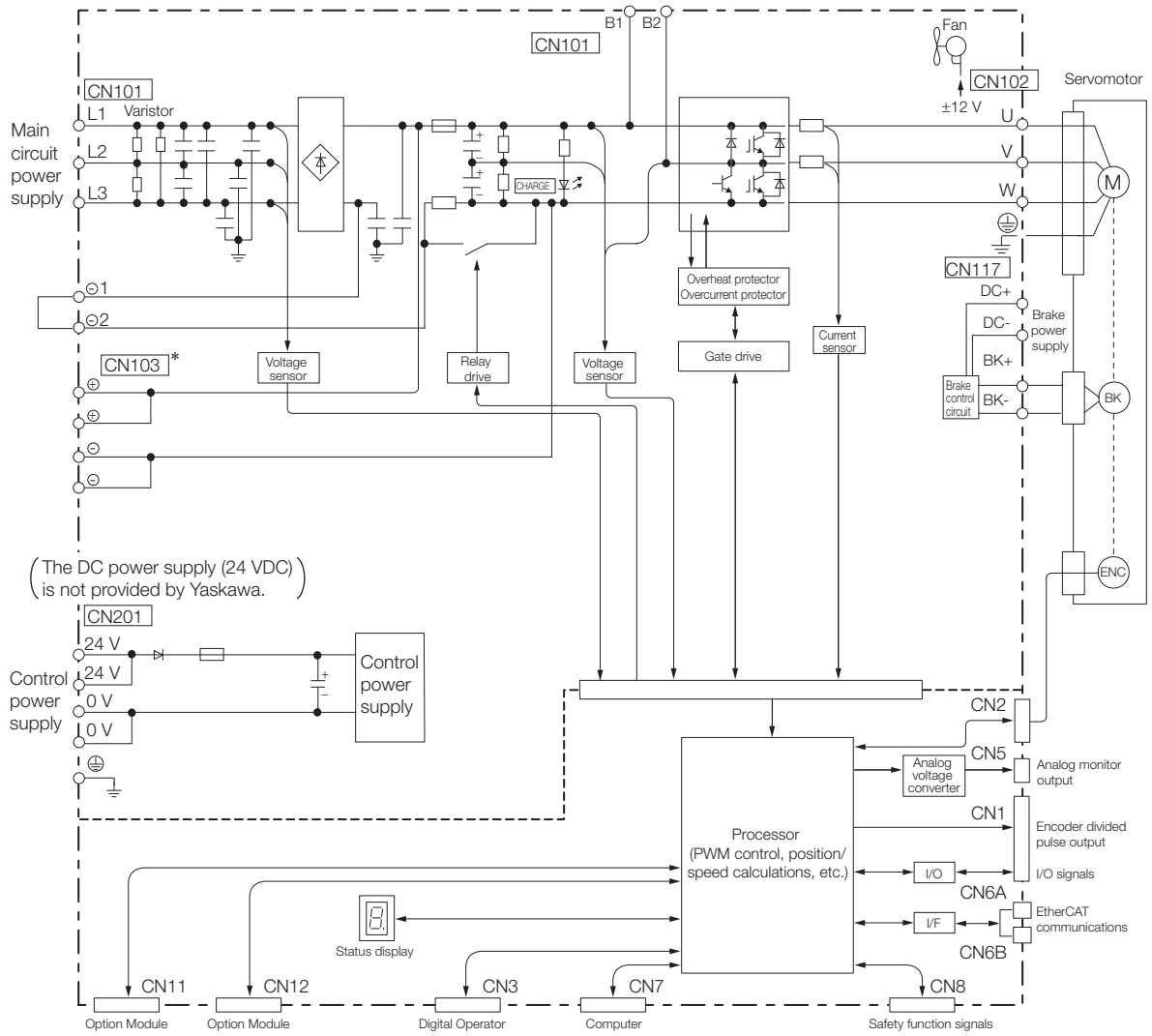

* If using these terminals, contact your YASKAWA representative.

SGD7S-280D and -370D

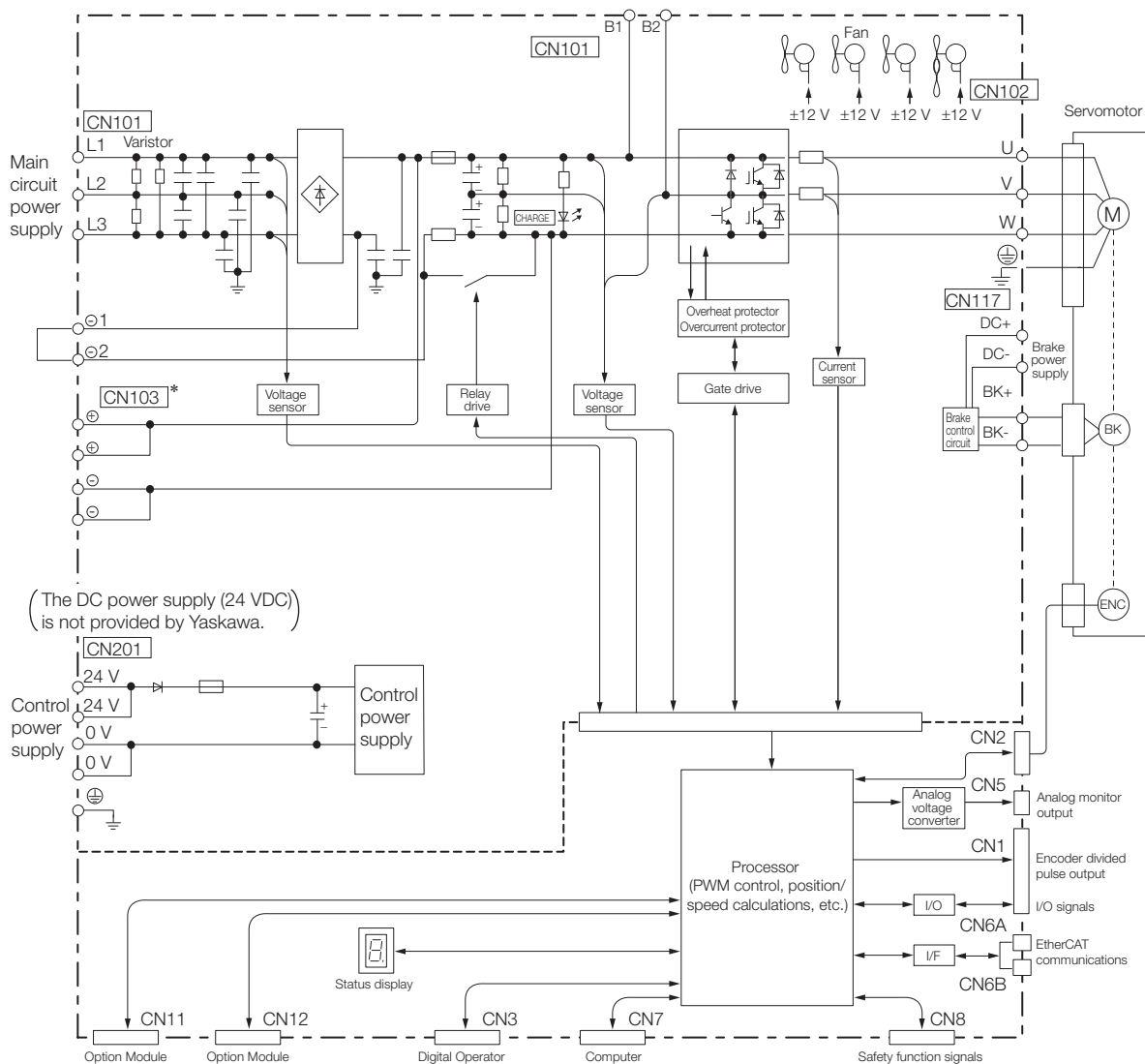

* If using these terminals, contact your YASKAWA representative.

2.3 External Dimensions

2.3.1 Front Cover Dimensions and Connector Specifications

The front cover dimensions and panel connector section are the same for all models. Refer to the following figures and table.

- Front Cover Dimensions and Connectors

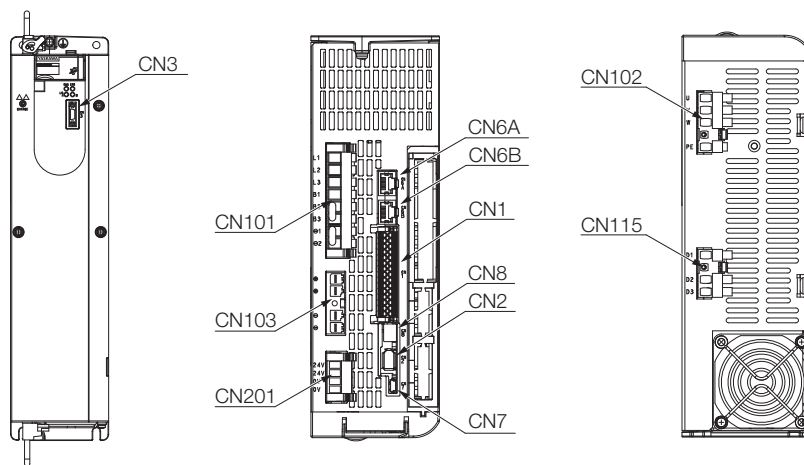
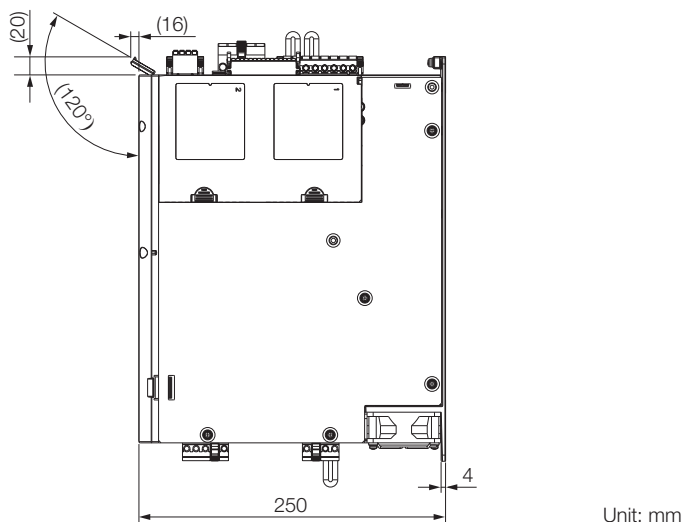

- Connector Specifications

Connector No.	Connector Model	Number of Pins	Manufacturer	SERVOPACK Model
CN1	DMC 1.5/15-G1F-3.5-LR-BK	30	Phoenix Contact	All models
CN2	3E106-0220KV	6	3M Japan Limited	All models
CN3	HDR-EC14LFD TN-SLD+	14	Honda Tsushin Kogyo Co., Ltd.	All models
CN6A/B	1-1734579-4	8	Tyco Electronics Japan G.K.	All models
CN7	2172034-1	5	Tyco Electronics Japan G.K.	All models
CN8	1903815-1	8	Tyco Electronics Japan G.K.	All models

Continued on next page.

Continued from previous page.

Connector No.	Connector Model	Number of Pins	Manufacturer	SERVOPACK Model
CN101	BLZ 7.62HP/08/180LR SN BK BX PRT	8	Weidmüller Interface GmbH & Co. KG	SGD7S-1R9D to -170D
	BUZ 10.16HP/07/180F AG BK BX LPR			SGD7S-210D to -370D
CN102	BLZ 7.62IT/04/180MF4 SN BK BX PRT	4	Weidmüller Interface GmbH & Co. KG	SGD7S-1R9D to -170D
	BUZ 10.16IT/04/180MF4 AG BK BX LPR			SGD7S-210D to -370D
CN103*	BVZ 7.62IT/04/180MF3 SN BK BX PRT	4	Weidmüller Interface GmbH & Co. KG	SGD7S-1R9D to -170D
	BUZ 10.16IT/04/180MF3 AG BK BX LPR			SGD7S-210D to -370D
CN115	BLZ 7.62IT/03/180MF2 SN BK BX PRT	3	Weidmüller Interface GmbH & Co. KG	SGD7S-1R9D to -170D
	None	–	–	SGD7S-210D to -370D
CN201	BLF 5.08HC/04/180LR SN OR BX SO	4	Weidmüller Interface GmbH & Co. KG	All models

* If using these terminals, contact your YASKAWA representative.

Note: The above connectors or their equivalents are used for the SERVOPACKs.

2.3.2 SERVOPACK External Dimensions

Base-mounted SERVOPACKs

- Three-Phase, 400 VAC: SGD7S-1R9D, -3R5D, -5R4D, -8R4D, and -120D

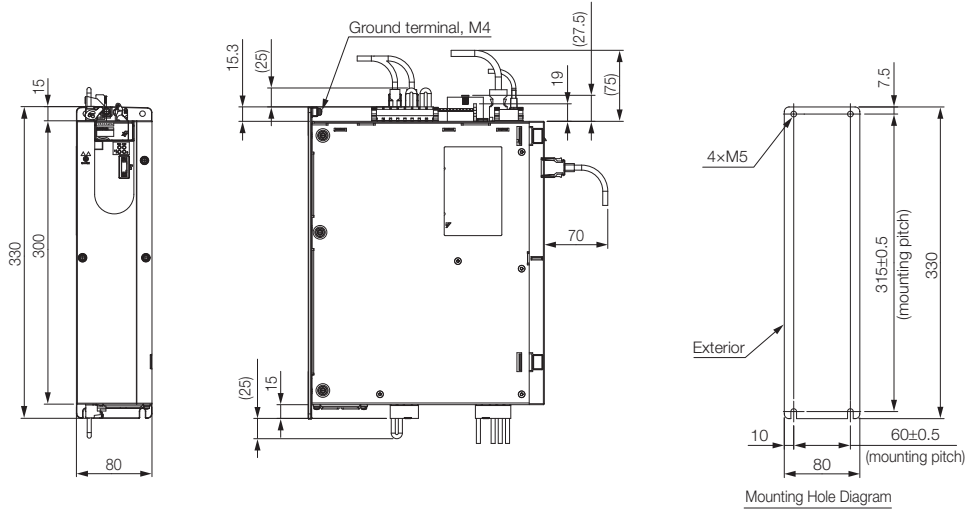

Mounting Hole Diagram

Approx. mass: SGD7S-1R9D, -3R5D, or -5R4D: 3.4 kg
 SGD7S-8R4D or -120D: 3.7 kg
 Unit: mm

- Three-Phase, 400 VAC: SGD7S-170D

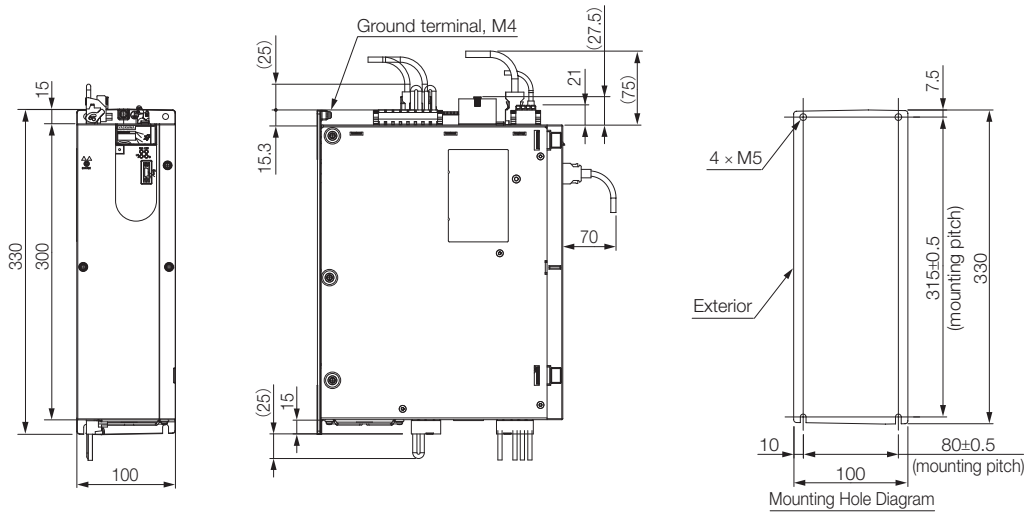

Mounting Hole Diagram

Approx. mass: 5.5 kg
 Unit: mm

• Three-Phase, 400 VAC: SGD7S-210D and -260D

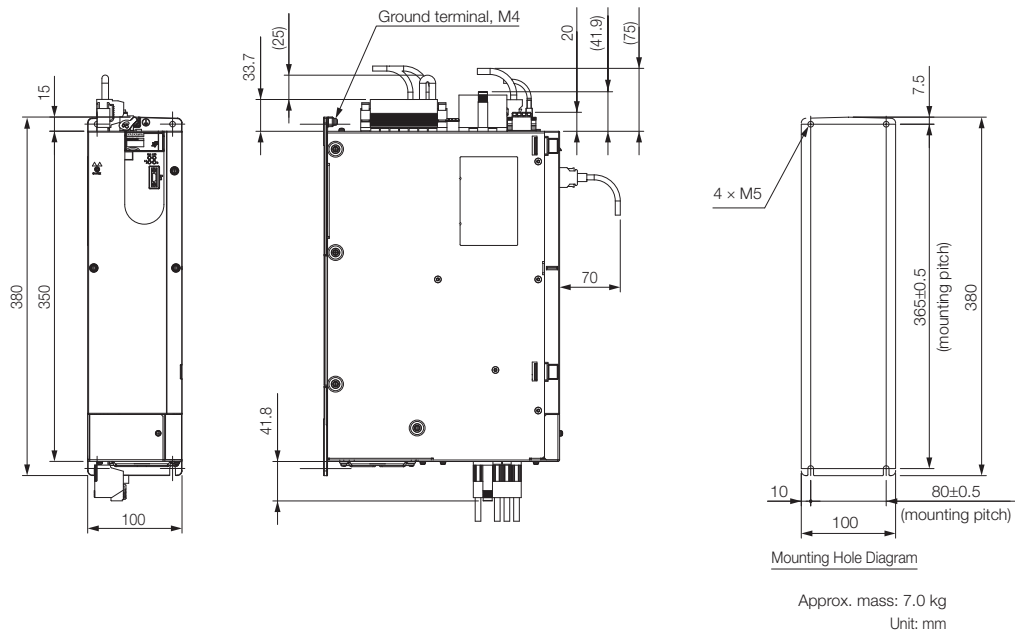

• Three-Phase, 400 VAC: SGD7S-280D and -370D

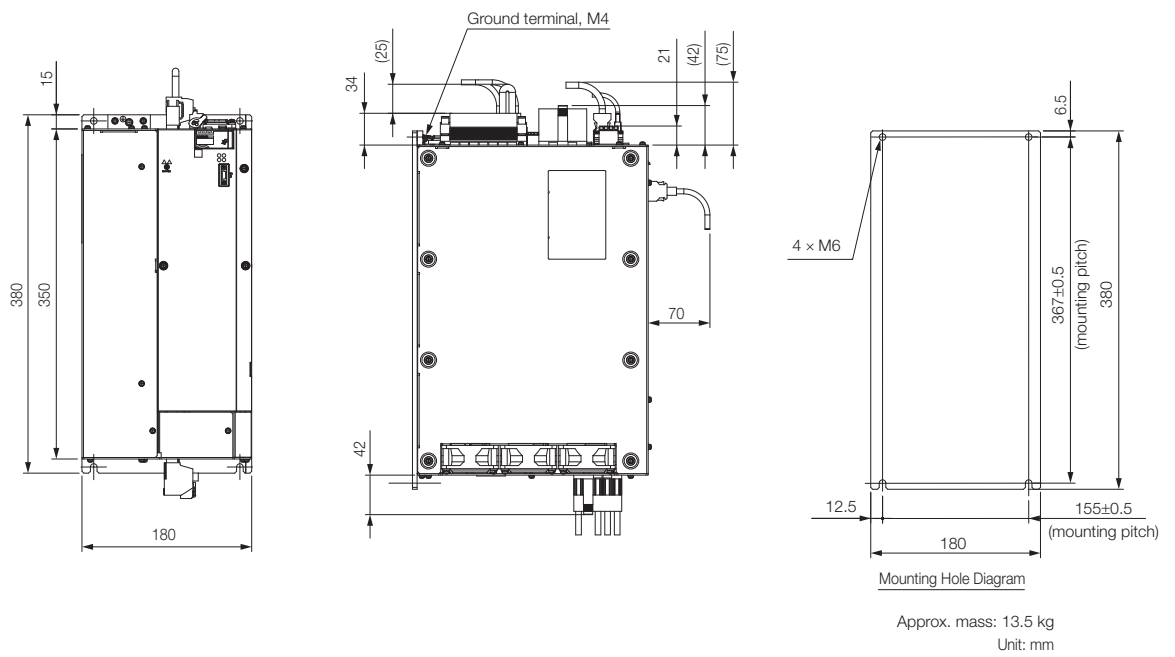

2.4 Examples of Standard Connections between SERVOPACKs and Peripheral Devices

• Rotary Servomotors

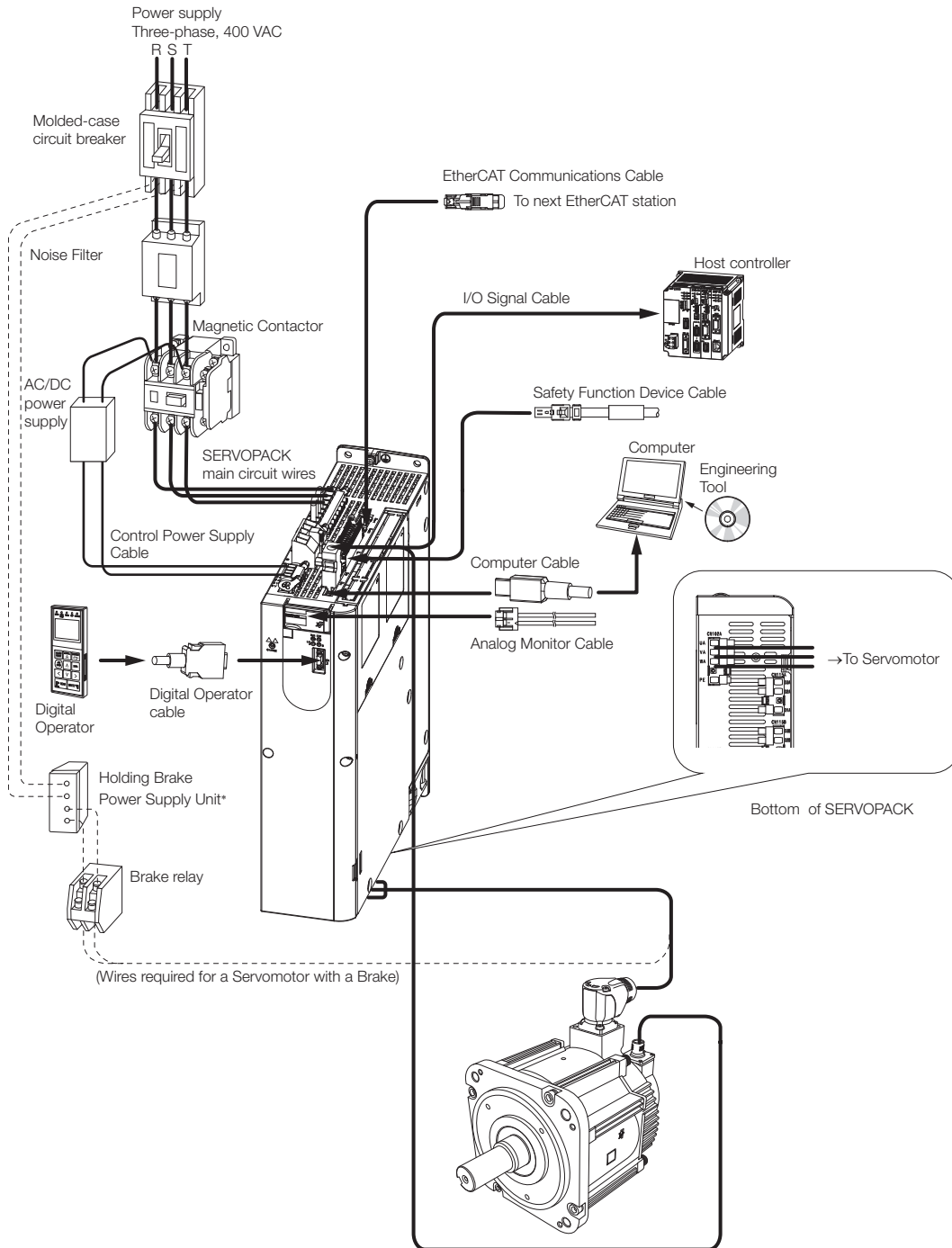

* The power supply for the holding brake is not provided by Yaskawa. Select a power supply based on the holding brake specifications.
 If you use a 24-V brake, install a separate power supply for the 24-VDC power supply from other power supplies, such as the one for the I/O signals of the CN1 connector.
 If the power supply is shared, the I/O signals may malfunction.

• Linear Servomotors

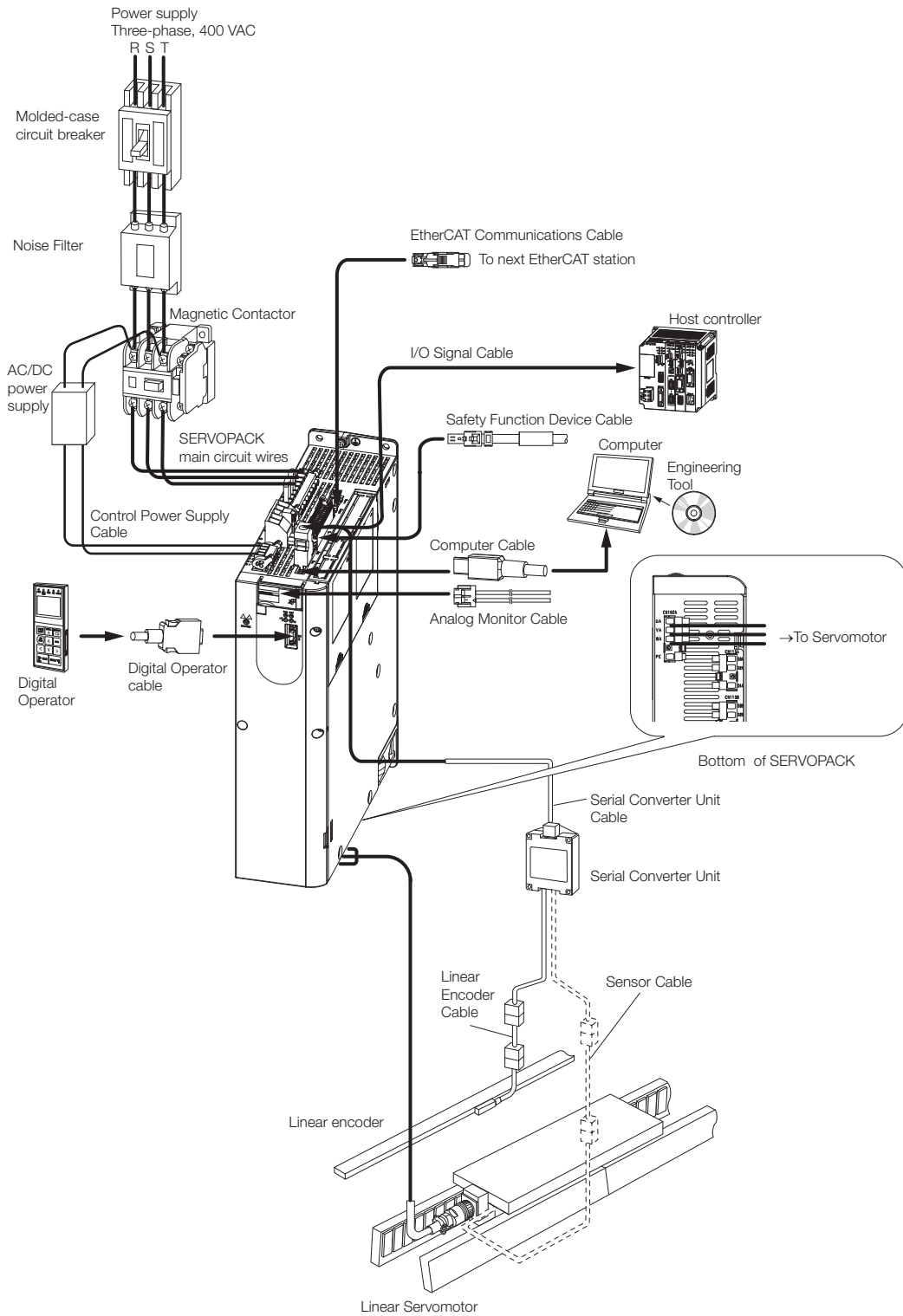

SERVOPACK Installation

3

This chapter provides information on installing SERVOPACKs in the required locations.

3.1	Installation Precautions	3-2
3.2	Mounting Types and Orientation	3-3
3.3	Mounting Hole Dimensions	3-4
3.4	Mounting Interval	3-5
	3.4.1 Installing One SERVOPACK in a Control Panel . .	3-5
	3.4.2 Installing More Than One SERVOPACK in a Control Panel	3-5
3.5	Monitoring the Installation Environment . . .	3-6
3.6	Derating Specifications	3-7
3.7	EMC Installation Conditions	3-8

3.1 Installation Precautions

Refer to the following section for the ambient installation conditions.

 2.1.3 Specifications on page 2-4

■ Installation Near Sources of Heat

Implement measures to prevent temperature increases caused by radiant or convection heat from heat sources so that the ambient temperature of the SERVOPACK meets the ambient conditions.

■ Installation Near Sources of Vibration

Install a vibration absorber on the mounting surface of the SERVOPACK so that the SERVOPACK will not be subjected to vibration.

■ Other Precautions

Do not install the SERVOPACK in a location subject to high temperatures, high humidity, water drops, cutting oil, excessive dust, excessive dirt, excessive iron powder, corrosive gasses, or radioactivity.

3.2 Mounting Types and Orientation

The SERVOPACKs are based mounted. Mount the SERVOPACK vertically, as shown in the following figures.

Also, mount the SERVOPACK so that the front panel is facing toward the operator.

Note: Prepare four mounting holes for the SERVOPACK and mount it securely in the mounting holes. (The number of mounting holes depends on the capacity of the SERVOPACK.)

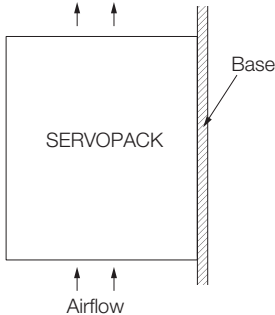

3.3 Mounting Hole Dimensions

Use mounting holes to securely mount the SERVOPACK to the mounting surface.

Note: To mount the SERVOPACK, you will need to prepare a screwdriver that is longer than the depth of the SERVOPACK.

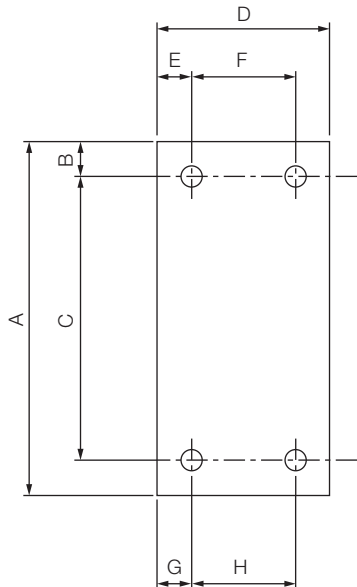

◆ Mounting Hole Dimensions

SERVOPACK Model		Dimensions (mm)								Screw Size	Number of Screws
		A	B	C	D	E	F	G	H		
SGD7S-	1R9D, 3R5D, 5R4D, 8R4D, 120D	330	7.5	315 ±0.5	80	10	60 ±0.5	10	60 ±0.5	M5	4
	170D	330	7.5	315 ±0.5	100	10	80 ±0.5	10	80 ±0.5	M5	4
	210D, 260D	380	7.5	365±0.5	100	10	80±0.5	10	80±0.5	M5	4
	280D, 370D	380	6.5	367±0.5	180	12.5	155±0.5	12.5	155±0.5	M6	4

3.4 Mounting Interval

3.4.1 Installing One SERVOPACK in a Control Panel

Provide the following spaces around the SERVOPACK.

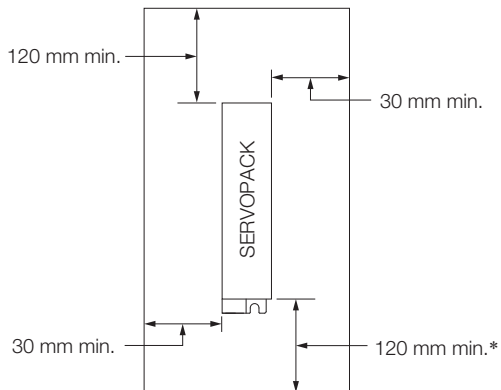

* For this dimension, ignore items protruding from the main body of the SERVOPACK.

3.4.2 Installing More Than One SERVOPACK in a Control Panel

When multiple SERVOPACKs are installed close together in an enclosed space, natural convection may provide insufficient air circulation to distribute heat uniformly through the space, resulting in the air surrounding the SERVOPACKs to locally exceed the surrounding air temperature range. In this case, you must take measures to disperse the localized hot spots, such as by using fans. When using fans, install them as shown below.

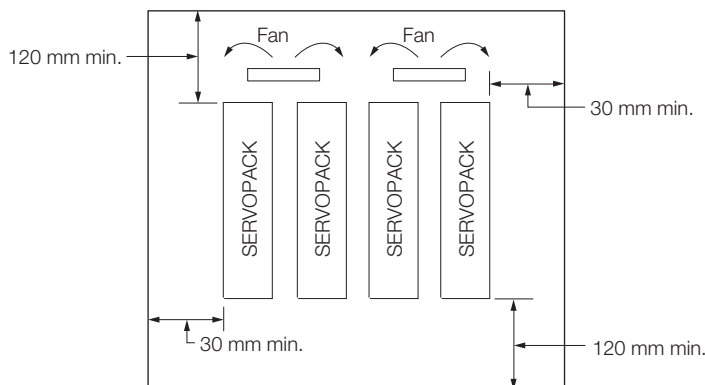

SERVOPACK model	Cooling Fan Installation Conditions	
	10 mm above SERVOPACK's Top Surface	
SGD7S- 1R9D, 3R5D, 5R4D, 8R4D, 120D, 170D, 210D, 260D, 280D, 370D	Air speed: 1.0 m/s min.	

Note: When option modules are mounted on SERVOPACKs, the SERVOPACK installation conditions will depend on the option modules that are mounted. For details, refer to the manual for option module.

3.5 Monitoring the Installation Environment

You can use the SERVOPACK Installation Environment Monitor parameter to check the operating conditions of the SERVOPACK in the installation environment.

You can check the SERVOPACK installation environment monitor with either of the following methods.

- Using the SigmaWin+: **Life Monitor - Installation Environment Monitor - SERVOPACK**
- Digital Operator: Un025 (Installation Environment Monitor [%])

Implement one or more of the following actions if the monitor value exceeds 100%.

- Lower the surrounding temperature.
- Decrease the load.

Information The value of the SERVOPACK Installation Environment Monitor parameter will increase by about 10% for each 10°C increase in the ambient temperature.



Important

Always observe the surrounding air temperature given in the SERVOPACK environment conditions. Even if the monitor value is 100% or lower, you cannot use a SERVOPACK in a location that exceeds the specified surrounding air temperature.

3.6 Derating Specifications

If you use the SERVOPACK at a surrounding air temperature of 55°C to 60°C or at an altitude of 1,000 m to 2,000 m, you must apply the derating rates given in the following graphs.

- SGD7S-1R9D, 3R5D, 5R4D, 8R4D, 120D, 170D, 210D, 260D, and 280D

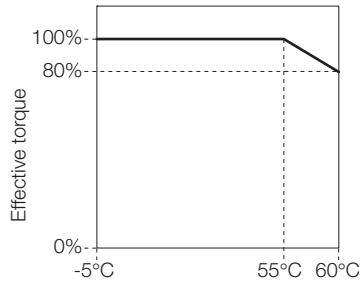

Surrounding air temperature

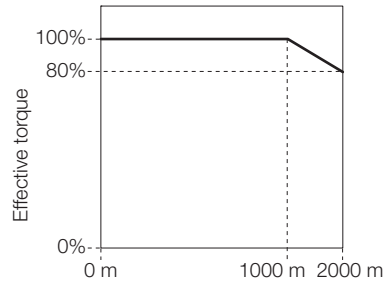

Altitude

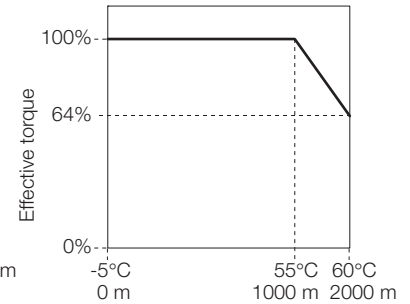

Surrounding air temperature and altitude

- SGD7S-370D

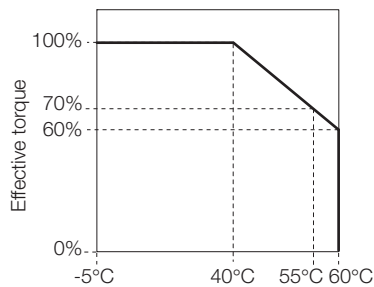

Surrounding air temperature

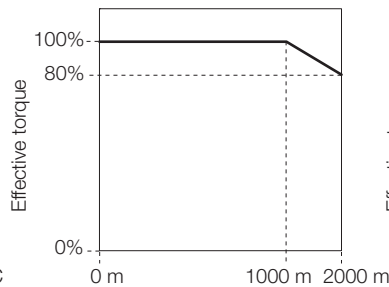

Altitude

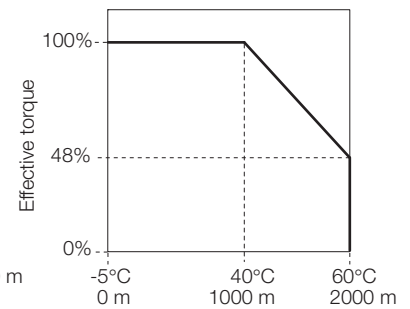

Surrounding air temperature and altitude

3.7 EMC Installation Conditions

This section gives the recommended installation conditions that were used for EMC certification testing.

The EMC installation conditions that are given here are the conditions that were used to pass testing criteria at Yaskawa. The EMC level may change under other conditions, such as the actual installation structure and wiring conditions. These Yaskawa products are designed to be built into equipment. Therefore, you must implement EMC measures and confirm compliance for the final equipment.

The compliant standards are EN 55011 group 1 class A, EN 61000-6-2, EN 61000-6-4, and EN 61800-3 (category C2, second environment).

⚠ WARNING

- In a domestic environment, this product may cause radio interference in which case supplementary mitigation measures may be required.

⚠ CAUTION

- This equipment is not intended for use in residential environments and may not provide adequate protection to radio reception in such environments.

- Three-Phase, 400 VAC

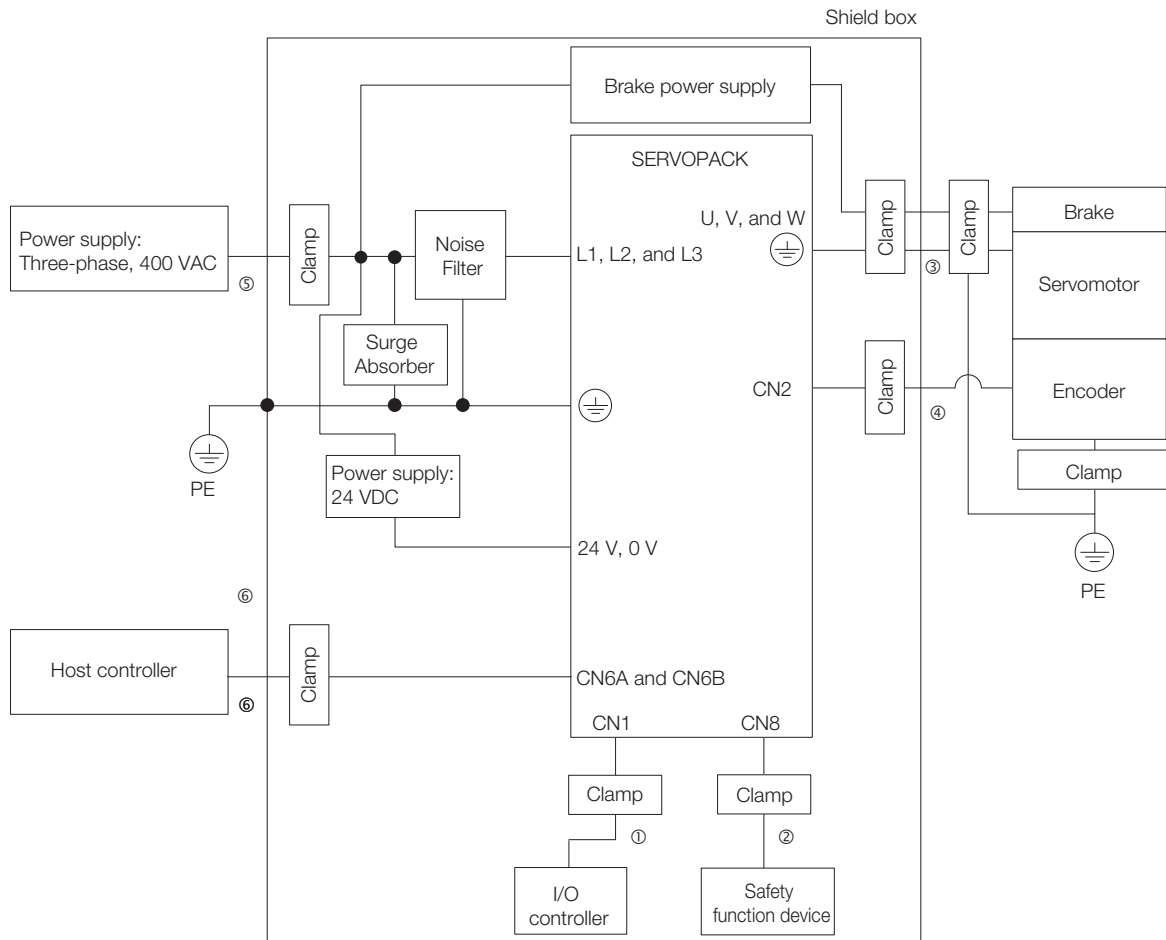

Symbol	Cable Name	Specification
①	I/O Signal Cable	Shielded cable
②	Safety Function Device Cable	Shielded cable
③	Servomotor Main Circuit Cable	Shielded cable
④	Encoder Cable	Shielded cable
⑤	Main Circuit Power Supply Cable	Shielded cable
⑥	EtherCAT Communications Cable	Shielded cable

Wiring and Connecting SERVOPACKs

4

This chapter provides information on wiring and connecting SERVOPACKs to power supplies and peripheral devices.

4.1	Wiring and Connecting SERVOPACKs	4-3
4.1.1	General Precautions	4-3
4.1.2	Countermeasures against Noise	4-5
4.1.3	Grounding	4-8
4.2	Basic Wiring Diagrams	4-9
4.3	Wiring the Power Supply to the SERVOPACK	4-11
4.3.1	Terminal Symbols and Terminal Names	4-11
4.3.2	Connector Wiring Procedure	4-13
4.3.3	Power ON Sequence	4-14
4.3.4	Power Supply Wiring Diagrams	4-15
4.3.5	Wiring Regenerative Resistors	4-18
4.3.6	Wiring Reactors for Harmonic Suppression	4-18
4.4	Wiring Servomotors	4-19
4.4.1	Terminal Symbols and Terminal Names	4-19
4.4.2	Pin Arrangement of Encoder Connector (CN2)	4-19
4.4.3	Wiring the SERVOPACK to the Encoder	4-20
4.4.4	Wiring the SERVOPACK to the Holding Brake	4-28
4.5	Connecting I/O Signals	4-30
4.5.1	I/O Signal Connector (CN1) Names and Functions	4-30
4.5.2	I/O Signal Connector (CN1) Pin Arrangement	4-32
4.5.3	I/O Signal Wiring Examples	4-33
4.5.4	I/O Circuits	4-35

4.6 Connecting Safety Function Signals4-37

- 4.6.1 Pin Arrangement of Safety Function Signals (CN8) . . 4-37
- 4.6.2 I/O Circuits4-37

4.7 Connecting EtherCAT Communications Cables . . 4-39

- 4.7.1 EtherCAT Connectors (RJ45) 4-39
- 4.7.2 Ethernet Communications Cables 4-40

4.8 Connecting the Other Connectors4-41

- 4.8.1 Serial Communications Connector (CN3)4-41
- 4.8.2 Computer Connector (CN7)4-41
- 4.8.3 Analog Monitor Connector (CN5)4-41

4.1 Wiring and Connecting SERVOPACKs

4.1.1 General Precautions



DANGER

- Do not change any wiring while power is being supplied.
There is a risk of electric shock or injury.



WARNING

- Wiring and inspections must be performed only by qualified engineers.
There is a risk of electric shock or product failure.
- Check all wiring and power supplies carefully.
Incorrect wiring or incorrect voltage application to the output circuits may cause short-circuit failures. If a short-circuit failure occurs as a result of any of these causes, the holding brake will not work. This could damage the machine or cause an accident that may result in death or injury.
- Connect the AC and DC power supplies to the specified SERVOPACK terminals.
 - Connect an AC power supply to the L1, L2, and L3 terminals on the SERVOPACK.
 - Connect a DC power supply to the B1 and $\ominus 2$ terminals and the 24 V and 0 V terminals on the SERVOPACK.
 There is a risk of failure or fire.



CAUTION

- Wait for six minutes after turning OFF the power supply and then make sure that the CHARGE indicator is not lit before starting wiring or inspection work. Do not touch the power supply terminals while the CHARGE lamp is lit after turning OFF the power supply because high voltage may still remain in the SERVOPACK.
There is a risk of electric shock.
- Observe the precautions and instructions for wiring and trial operation precisely as described in this document.
Failures caused by incorrect wiring or incorrect voltage application in the brake circuit may cause the SERVOPACK to fail, damage the equipment, or cause an accident resulting in death or injury.
- Check the wiring to be sure it has been performed correctly.
Connectors and pin layouts are sometimes different for different models. Always confirm the pin layouts in technical documents for your model before operation.
There is a risk of failure or malfunction.
- Connect wires to power supply terminals and motor connection terminals securely with the specified methods and tightening torque.
Insufficient tightening may cause wires and terminal blocks to generate heat due to faulty contact, possibly resulting in fire.
- Use shielded twisted-pair cables or screened unshielded multi-twisted-pair cables for I/O Signal Cables and Encoder Cables.
- The maximum wiring length is 10 m for Control Power Supply Cables (+24 V, 0 V), 3 m for I/O Signal Cables, and 50 m for Encoder Cables or Servomotor Main Circuit Cables.
- Observe the following precautions when wiring the SERVOPACK's main circuit terminals.
 - Turn ON the power supply to the SERVOPACK only after all wiring, including the main circuit terminals, has been completed.
 - If a connector is used for the main circuit terminals, remove the main circuit connector from the SERVOPACK before you wire it.
 - Insert only one wire per insertion hole in the main circuit terminals.
 - When you insert a wire, make sure that the conductor wire (e.g., whiskers) does not come into contact with adjacent wires.

Continued on next page.

Continued from previous page.

CAUTION

- Install molded-case circuit breakers and other safety measures to provide protection against short circuits in external wiring.
There is a risk of fire or failure.

NOTICE

- Whenever possible, use the Cables specified by Yaskawa.
If you use any other cables, confirm the rated current and application environment of your model and use the wiring materials specified by Yaskawa or equivalent materials.
- Securely tighten cable connector screws and lock mechanisms.
Insufficient tightening may result in cable connectors falling off during operation.
- Do not bundle power lines (e.g., the Main Circuit Cable) and low-current lines (e.g., the I/O Signal Cables or Encoder Cables) together or run them through the same duct. If you do not place power lines and low-current lines in separate ducts, separate them by at least 30 cm. If the cables are too close to each other, malfunctions may occur due to noise affecting the low-current lines.
- Install a battery at either the host controller or on the Encoder Cable.
If you install batteries both at the host controller and on the Encoder Cable at the same time, you will create a loop circuit between the batteries, resulting in a risk of damage or burning.
- When connecting a battery, connect the polarity correctly.
There is a risk of battery rupture or encoder failure.
- If you use an External Regenerative Resistor or External Dynamic Brake Resistor, use cable ties, clamps, or other means to secure the resistor so that the connectors or terminal blocks inside the SERVOPACK will not be affected even if the resistor is subjected to vibration or shock.
There is a risk of SERVOPACK damage.



Important

- Use a molded-case circuit breaker or fuse to protect the main circuit. The SERVOPACK connects directly to a commercial power supply; it is not isolated through a transformer or other device. Always use a molded-case circuit breaker or fuse to protect the Servo System from accidents involving different power system voltages or other accidents.
- Install an earth leakage breaker. The SERVOPACK does not have a built-in ground fault protective circuit. To configure a safer system, install a ground fault detector against overloads and short-circuiting, or install a ground fault detector combined with a molded-case circuit breaker.
- Do not turn the power supply ON and OFF more than necessary.
 - Do not use the SERVOPACK for applications that require the power supply to turn ON and OFF frequently. Such applications will cause elements in the SERVOPACK to deteriorate.
 - After you have started actual operation, allow at least one hour between turning the power supply ON and OFF (as a guideline).

To ensure safe, stable application of the Servo System, observe the following precautions when wiring.

- Use the Cables specified by Yaskawa. Design and arrange the system so that each cable is as short as possible.
Refer to the catalog for information on the specified cables.
- The signal cable conductors are as thin as 0.2 mm² or 0.3 mm². Do not subject them to excessive bending stress or tension.

4.1.2 Countermeasures against Noise



Important

The SERVOPACK is designed as an industrial device. It therefore provides no measures to prevent radio interference. The SERVOPACK uses high-speed switching elements in the main circuit. Therefore peripheral devices may be affected by switching noise.

If the equipment is to be used near private houses or if radio interference is a problem, take countermeasures against noise.

The SERVOPACK uses microprocessors. Therefore, it may be affected by switching noise from peripheral devices.

To prevent the noise from the SERVOPACK or the peripheral devices from causing malfunctions of any devices, take the following countermeasures against noise as required.

- Install the input reference device and Noise Filter as close to the SERVOPACK as possible.
- Always install a Surge Absorber for relays, solenoids, and Magnetic Contactor coils.
- Do not place the following cables in the same duct or bundle them together. Also, separate the cables from each other by at least 30 cm.
 - Main Circuit Cables and I/O Signal Cables
 - Main Circuit Cables and Encoder Cables
- Do not share the power supply with an electric welder or electrical discharge machine. If the SERVOPACK is placed near a high-frequency generator, install Noise Filters on the input side on the Main Circuit Power Supply Cable and Control Power Supply Cable even if the same power supply is not shared with the high-frequency generator. Refer to the following section for information on connecting Noise Filters.
 - 📖 *Noise Filters* on page 4-6
- Implement suitable grounding measures. Refer to the following section for information on grounding measures.
 - 📖 *4.1.3 Grounding* on page 4-8

Noise Filters

You must attach Noise Filters in appropriate places to protect the SERVOPACK from the adverse effects of noise. The following is an example of wiring for countermeasures against noise.

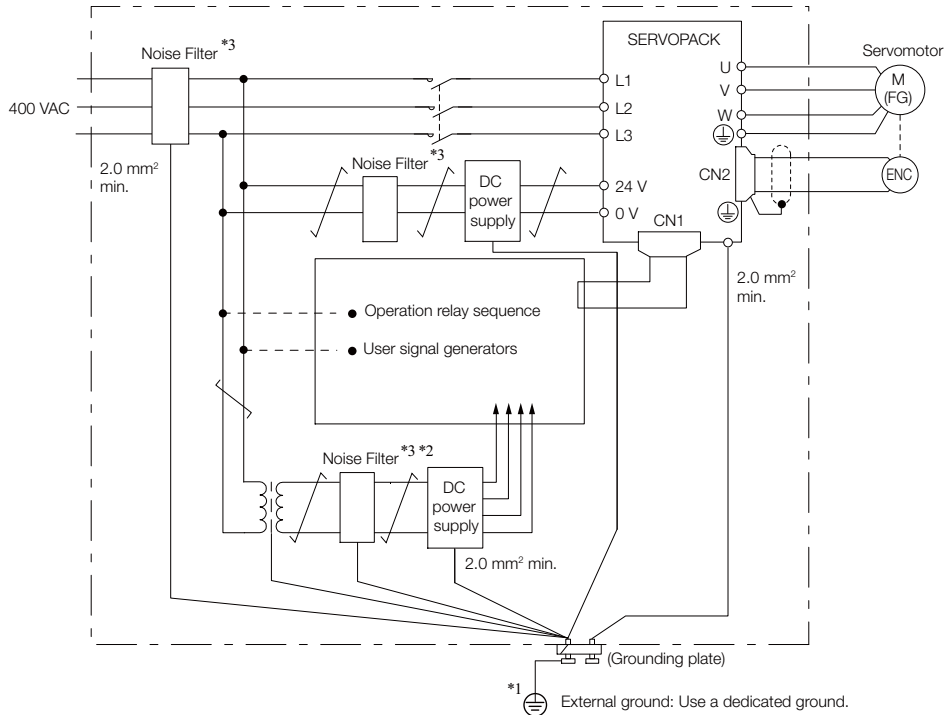

- *1. For the ground wire, use a wire with a thickness of at least 2.0 mm² (preferably, flat braided copper wire).
- *2. Whenever possible, use twisted-pair wires to wire all connections marked with .
- *3. Refer to the following section for precautions when using Noise Filters.
Noise Filter Wiring and Connection Precautions on page 4-7

Noise Filter Wiring and Connection Precautions

Always observe the following precautions when wiring or connecting Noise Filters.

- Separate input lines from output lines. Do not place input lines and output lines in the same duct or bundle them together.

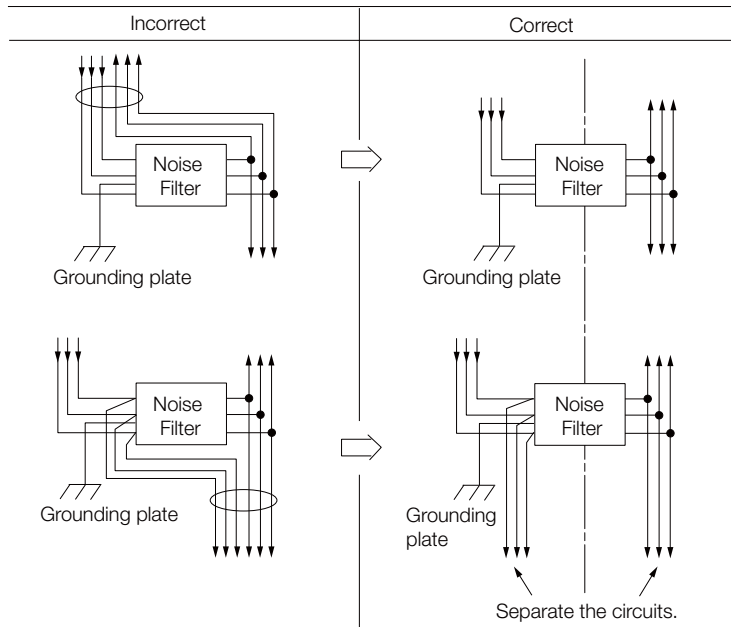

- Separate the Noise Filter ground wire from the output lines. Do not place the Noise Filter ground wire, output lines, and other signal lines in the same duct or bundle them together.

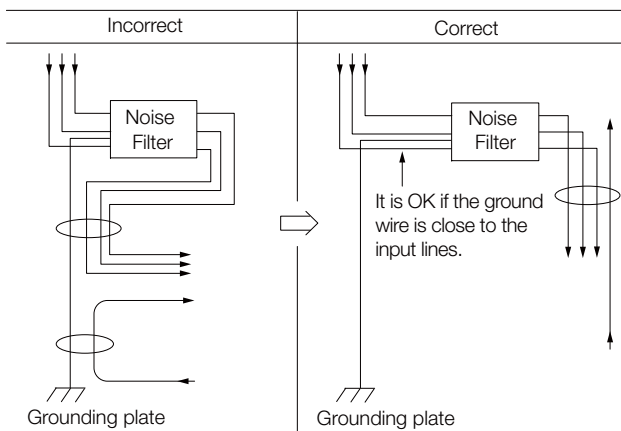

- Connect the Noise Filter ground wire directly to the grounding plate. Do not connect the Noise Filter ground wire to other ground wires.

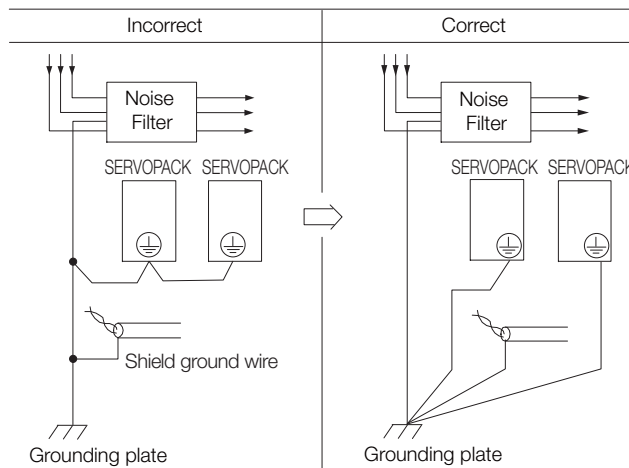

4.1.3 Grounding

- If a Noise Filter is located inside a control panel, first connect the Noise Filter ground wire and the ground wires from other devices inside the control panel to the grounding plate for the control panel, then ground the plate.

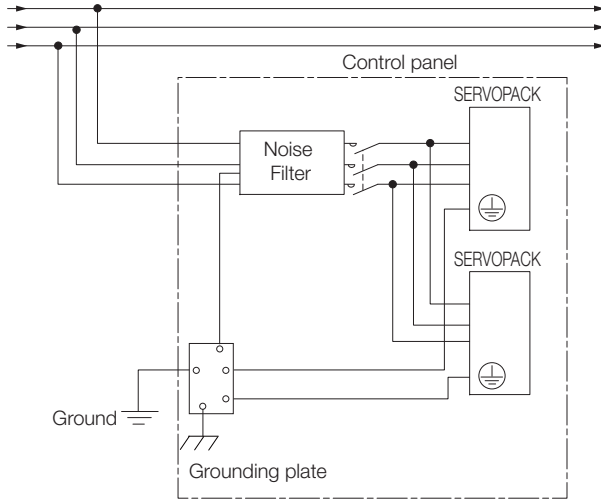

4.1.3 Grounding

Implement grounding measures as described in this section. Implementing suitable grounding measures will also help prevent malfunctions, which can be caused by noise.

Observe the following precautions when wiring the ground cable.

- Ground the SERVOPACK to a resistance of 10 Ω or less.
- Be sure to ground at one point only.
- Ground the Servomotor directly if the Servomotor is insulated from the machine.

Motor Frame Ground or Motor Ground

If you ground the Servomotor through the machine, a current resulting from switching noise can flow from the main circuit of the SERVOPACK through the stray capacitance of the Servomotor. To prevent this, always connect the motor frame terminal (FG) or ground terminal (FG) of the Servomotor to the ground terminal (⊕) on the SERVOPACK. Also be sure to ground the ground terminal (⊕).

Ground both the Moving Coil and Magnetic Way of a Linear Servomotor.

Noise on I/O Signal Cables

If noise enters the I/O Signal Cable, ground the shield of the I/O Signal Cable using a clamp or other means. If the Servomotor Main Circuit Cable is placed in a metal conduit, ground the conduit and its junction box. For all grounding, ground at one point only.

4.2 Basic Wiring Diagrams

This section provide the basic wiring diagrams. Refer to the reference sections given in the diagrams for details.

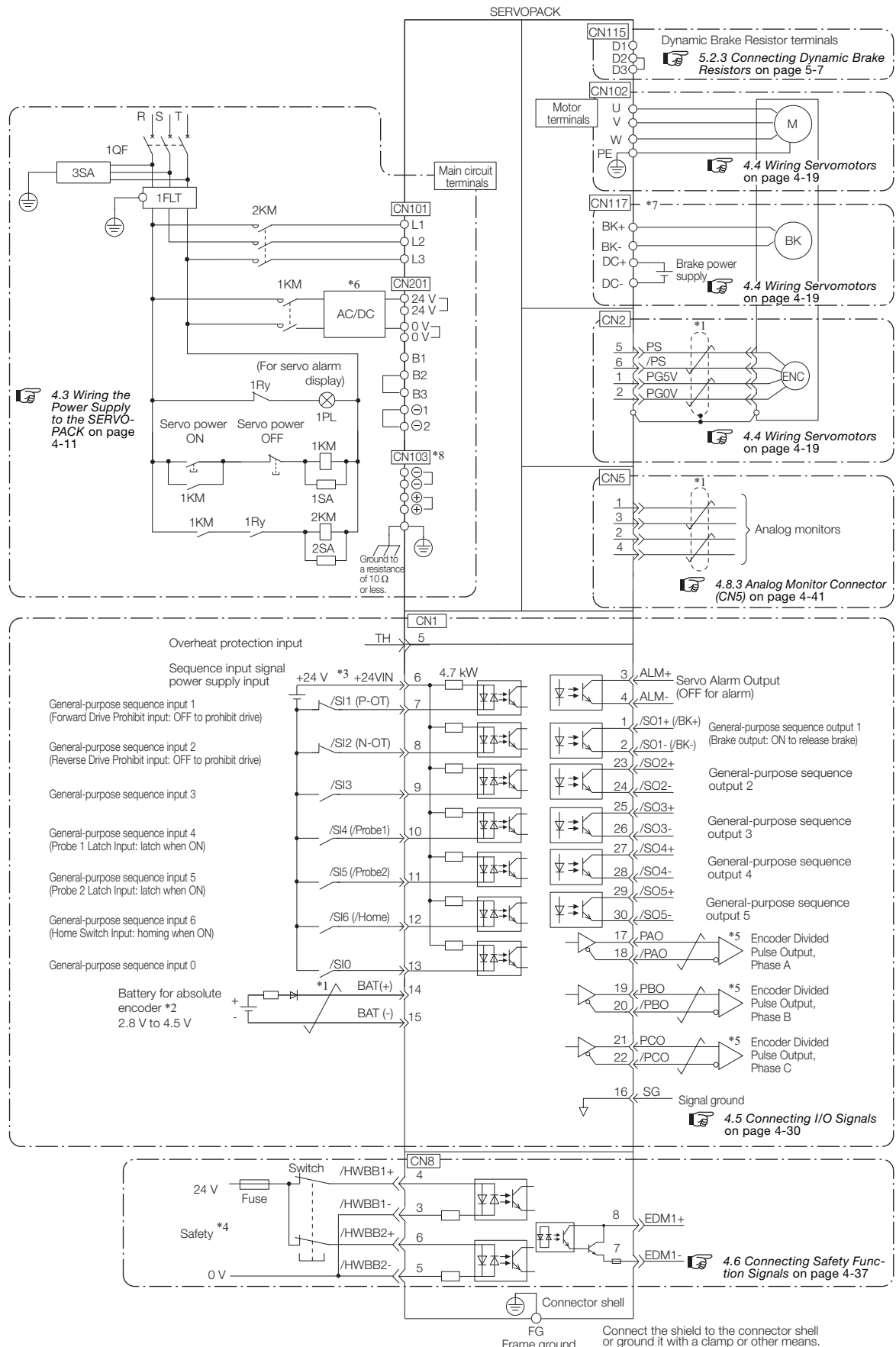

Wiring and Connecting SERVOPACKS

- *1.  represents twisted-pair wires.
- *2. Connect these when using an absolute encoder. If the Encoder Cable with a Battery Case is connected, do not connect a backup battery.
- *3. The 24-VDC power supply is not provided by Yaskawa. Use a 24-VDC power supply with double insulation or reinforced insulation.
- *4. Refer to the following chapter if you use a safety function device.

 **Chapter 12 Safety Functions**

If you do not use the safety function, insert the Safety Jumper Connector (provided as an accessory) into CN8 when you use the SERVOPACK.

- *5. Always use line receivers to receive the output signals.
- *6. Use an SELV-compliant power supply according to EN/IEC 60950-1 to input 24 VDC to the control power supply input terminals.
- *7. The CN117 connector is used for SERVOPACKs with built-in Servomotor brake control. SERVOPACKs without built-in Servomotor brake control do not have the CN117 connector.
- *8. If using these terminals, contact your YASKAWA representative.

Note: 1. You can use parameters to change the functions allocated to the /SI0, /SI3, P-OT, N-OT, /Probe1, /Probe2, and /Home input signals and the /SO1, /SO2, /SO3, /SO4, and /SO5 output signals. Refer to the following section for details.

 **7.1 I/O Signal Allocations on page 7-4**

- 2. If you use a 24-V brake, install a separate power supply for the 24-VDC power supply from other power supplies, such as the one for the I/O signals of the CN1 connector. If the power supply is shared, the I/O signals may malfunction.
- 3. Default settings are given in parentheses.

4.3

Wiring the Power Supply to the SERVOPACK

Refer to the catalog for information on cables and peripheral devices.

4.3.1

Terminal Symbols and Terminal Names



Use the main circuit connector on the SERVOPACK to wire the main circuit power supply and control circuit power supply to the SERVOPACK.

 **CAUTION**

- Wire all connections correctly according to the following table and specified reference information. There is a risk of SERVOPACK failure or fire if incorrect wiring is performed.

The SERVOPACKs have the following two types of main circuit power supply input specifications.

- Three-Phase, 400-VAC Power Supply Input

Terminal Symbols	Terminal Name	Specifications and Reference
L1, L2, L3	Main circuit power supply input terminals for AC power supply input	Three-phase, 380 VAC to 480 VAC, -15% to +10%, 50 Hz/60 Hz
24 V	Control power supply terminals*1	24 VDC, -15% to +15%
0 V		0 VDC
B1, B2, B3*2	Regenerative Resistor terminal	 4.3.5 Wiring Regenerative Resistors on page 4-18 If the internal regenerative resistor is insufficient, remove the lead or short bar between B2 and B3 and connect an External Regenerative Resistor between B1 and B2. The External Regenerative Resistor is not included. Obtain it separately.
⊖1, ⊖2	DC Reactor terminals for power supply harmonic suppression	 4.3.6 Wiring Reactors for Harmonic Suppression on page 4-18 These terminals are used to connect a DC Reactor for power supply harmonic suppression.
⊖, ⊕	–	None. (Do not connect anything to this terminal.)
U, V, W, PE	Servomotor terminals	These are the Σ -7S connection terminals for the Servomotor Main Circuit Cable (power line). Note: Do not connect the PE terminal to anything other than a ground terminal.
D1, D2, D3*3	Dynamic Brake Resistor terminals	In the following cases, remove the lead or short bar between D2 and D3 and connect a Dynamic Brake Resistor between D1 and D2. <ul style="list-style-type: none"> • To specify the brake torque when stopping with the dynamic brake • To use a larger load moment of inertia than in the standard specifications The Dynamic Brake Resistor is not included. Obtain it separately.
DC+*5	Servomotor brake power supply terminals*4	24 VDC
DC-*5		0 VDC
BK+, BK-*5	Servomotor brake terminals	Connect these terminals to the Servomotor's holding brake terminals. The holding brake terminals on the Servomotor do not have any polarity.
	Ground terminal	The ground terminals to prevent electric shock. Always connect this terminal.

*1. Use an SELV-compliant power supply according to EN/IEC 60950-1 to input 24 VDC to the control power supply input terminals.

*2. With the SGD7S-210D, -260D, -280D, or -370D, connect a External Regenerative Resistor between B1 and B2.

*3. The SGD7S-210D, -260D, -280D, and -370D do not have the D1, D2, and D3 terminals.

*4. Make sure you check the brake specifications of the Servomotor for the 24-VDC power supply input to the Servomotor brake power supply terminals.

*5. SERVOPACKs without built-in Servomotor brake control do not have these terminals.

4.3.1 Terminal Symbols and Terminal Names

• DC Power Supply Input

Terminal Symbols	Terminal Name	Specifications and Reference
24 V	Control power supply terminals*1	24 VDC, -15% to +15%
0 V		0 VDC
B1*2	Main circuit power supply input terminals for DC power supply input	513 VDC to 648 VDC, -15% to +10%
⊖2*2		0 VDC
L1, L2, L3, B2, B3, ⊖1, ⊕, ⊕	–	None. (Do not connect anything to these terminals.) Note: 1. SGD7S-470A to 780A do not have a B3 terminal. 2. SGD7S-330A to 780A do not have a ⊖ terminal.
U, V, W, PE	Servomotor terminals	These are the Σ-7S connection terminals for the Servomotor Main Circuit Cable (power line). Note: Do not connect the PE terminal to anything other than a ground terminal.
D1, D2, D3*3	Dynamic Brake Resistor terminals	In the following cases, remove the lead or short bar between D2 and D3 and connect a Dynamic Brake Resistor between D1 and D2. • To specify the brake torque when stopping with the dynamic brake • To use a larger load moment of inertia than in the standard specifications The Dynamic Brake Resistor is not included. Obtain it separately.
DC+*5	Servomotor brake power supply terminals*4	24 VDC
DC-*5		0 VDC
BK+, BK-*5	Servomotor brake terminals	Connect these terminals to the Servomotor's holding brake terminals. The holding brake terminals on the Servomotor do not have any polarity.
⊕	Ground terminal	This is the ground terminal to prevent electric shock. Always connect this terminal.

- *1. Use an SELV-compliant power supply according to EN/IEC 60950-1 to input 24 VDC to the control power supply input terminals.
- *2. If using these terminals, contact your YASKAWA representative.
- *3. The SGD7S-210D, -260D, -280D, and -370D do not have the D1, D2, and D3 terminals.
- *4. Make sure you check the brake specifications of the Servomotor for the 24-VDC power supply input to the Servomotor brake power supply terminals.
- *5. SERVOPACKs without built-in Servomotor brake control do not have these terminals.

If you use a DC power supply input to the SERVOPACK, make sure to set parameter Pn001 to n.□1□□ (DC power supply input supported) before inputting the power supply. Refer to the following section for details.

 6.2 Power Supply Type Settings for the Main Circuit on page 6-12

4.3.2 Connector Wiring Procedure

- Required Items: Phillips or flat-blade screwdriver

SERVOPACK model SGD7S-	Terminal Symbols	Screwdriver Type	Screwdriver End Dimensions Thickness × Width [mm]	Wire Stripping Length [mm]
1R9D, 3R5D, 5R4D, 8R4D, 120D, 170D	L1, L2, L3, B1, B2, B3, -1, -2	Flat-blade	0.6 × 3.5	7
	U, V, W, PE	Phillips or flat-blade		7
	24 V, 0 V	Flat-blade		10
210D, 260D, 280D, 370D	L1, L2, L3, B1, B2, B3, -1, -2	Phillips or flat-blade	1.0 × 5.5	12
	U, V, W, PE	Phillips or flat-blade		12
	24 V, 0 V	Flat-blade		10

1. Prepare the connector that was provided with the SERVOPACK.
2. Remove the sheath from the wire to connect.

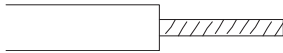

3. Open the wire insertion hole on the terminal connector with the screwdriver.

Main Circuit Terminals and Motor Terminals	Control Power Supply Terminals
<p>Insert the conductor of the wire into the wire insertion hole, insert the screwdriver into the screwdriver insertion hole, and tighten the screw.</p>	<p>Press the lever with a screwdriver or your fingertip and insert the conductor of the wire into the wire insertion hole. After you insert conductor, release the screwdriver or your fingertip.</p>

4. Make all other connections in the same way.
5. When you have completed wiring, attach the connector to the SERVOPACK.
6. Press the connector all the way to the back and lock it with the lock lever.

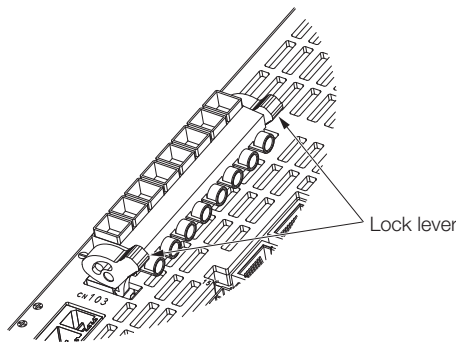

4.3.3 Power ON Sequence

Consider the following points when you design the power ON sequence.

- The ALM (Servo Alarm) signal is output for up to five seconds when the control power supply is turned ON. Take this into consideration when you design the power ON sequence, and turn ON the main circuit power supply to the SERVOPACK when the ALM signal is OFF (alarm cleared).

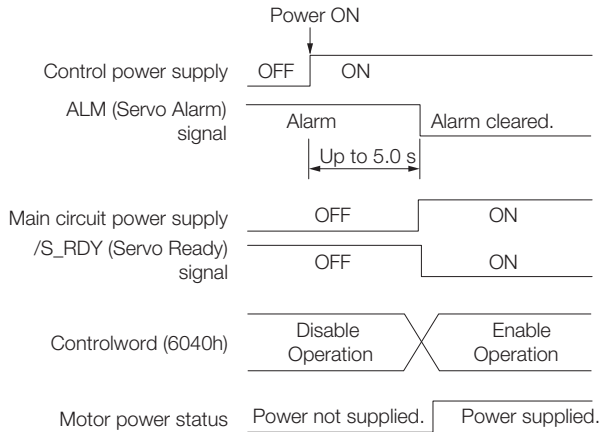

Information If the servo ON state cannot be achieved by inputting the Servo ON command (Enable Operation command), the /S_RDY signal is not ON. Check the status of the /S_RDY signal. Refer to the following section for details.

 [7.1.6 /S-RDY \(Servo Ready\) Signal on page 7-8](#)

- Design the power ON sequence so that main circuit power supply is turned OFF when an ALM (Servo Alarm) signal is output.
- Make sure that the power supply specifications of all parts are suitable for the input power supply.
- Allow at least 1 s after the power supply is turned OFF before you turn it ON again.



Important Turn ON the control power supply before the main circuit power supply, or turn ON the control power supply and the main circuit power supply at the same time. When turning OFF the power supply, turn OFF the main circuit power supply first, and then turn OFF the control power supply.



WARNING

- Even after you turn OFF the power supply, a high residual voltage may still remain in the SERVOPACK. To prevent electric shock, do not touch the power supply terminals after you turn OFF the power. When the voltage is discharged, the CHARGE indicator will turn OFF. Make sure the CHARGE indicator is OFF before you start wiring or inspection work.

4.3.4 Power Supply Wiring Diagrams

Using Only One SERVOPACK

- Wiring Example for Three-Phase, 400-VAC Power Supply Input: SGD7S-1R9D, -3R5D, -5R4D, -8R4D, -120D, and -170D

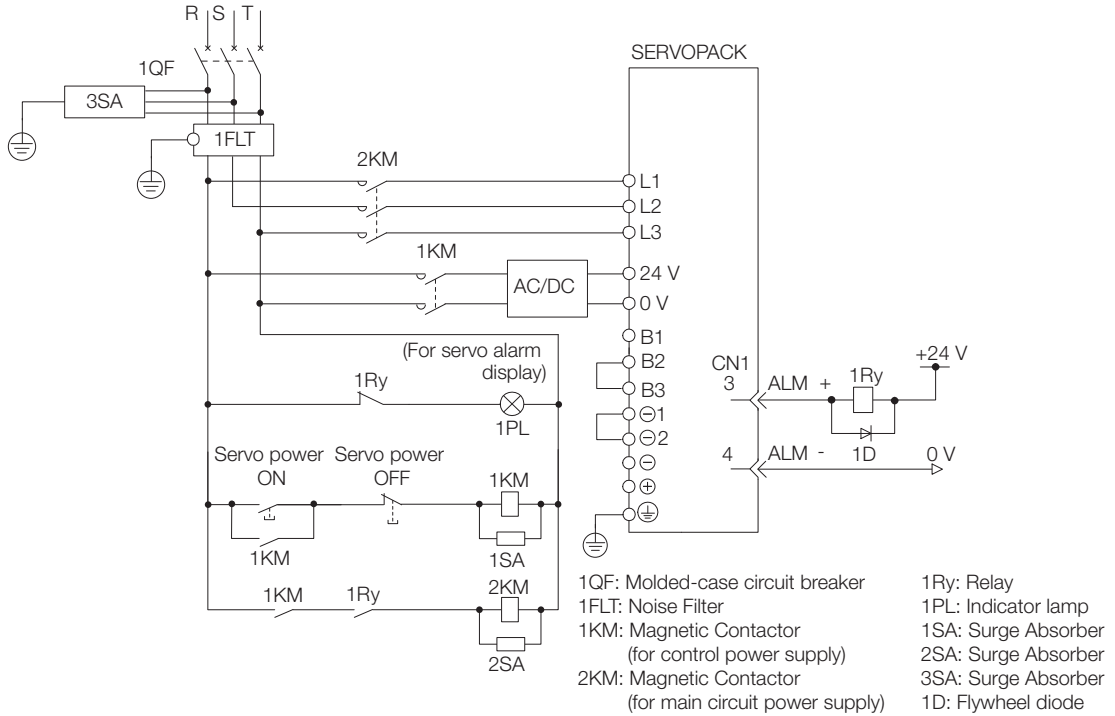

- Wiring Example for Three-Phase, 400-VAC Power Supply Input: SGD7S-210D, -260D, -280D, and -370D

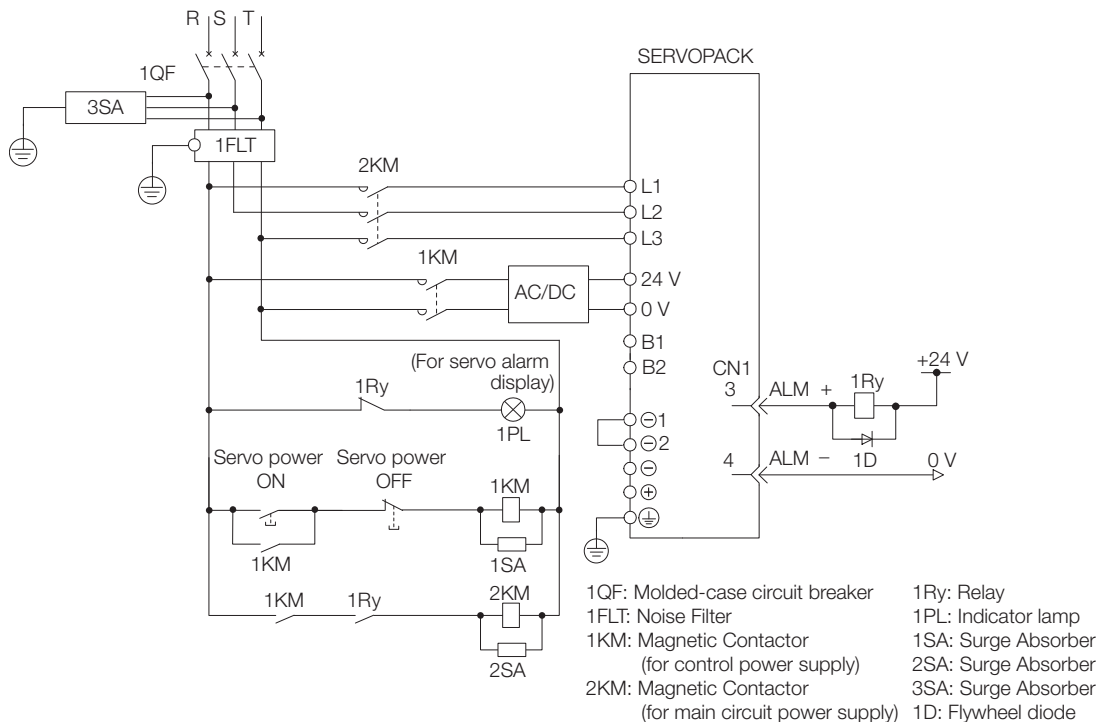

4.3 Wiring the Power Supply to the SERVOPACK

4.3.4 Power Supply Wiring Diagrams

- Wiring Example for DC Power Supply Input: SGD7S-1R9D, -3R5D, -5R4D, -8R4D, -120D, and -170D

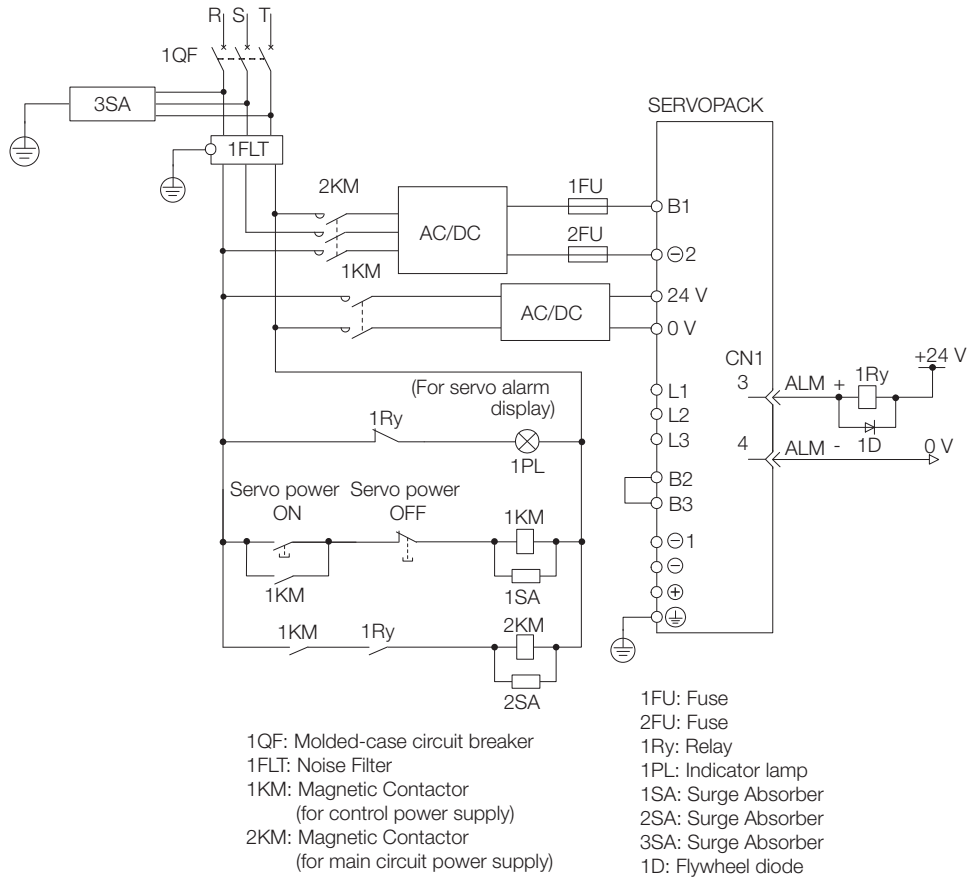

- Wiring Example for DC Power Supply Input: SGD7S-210D, -260D, -280D, and -370D

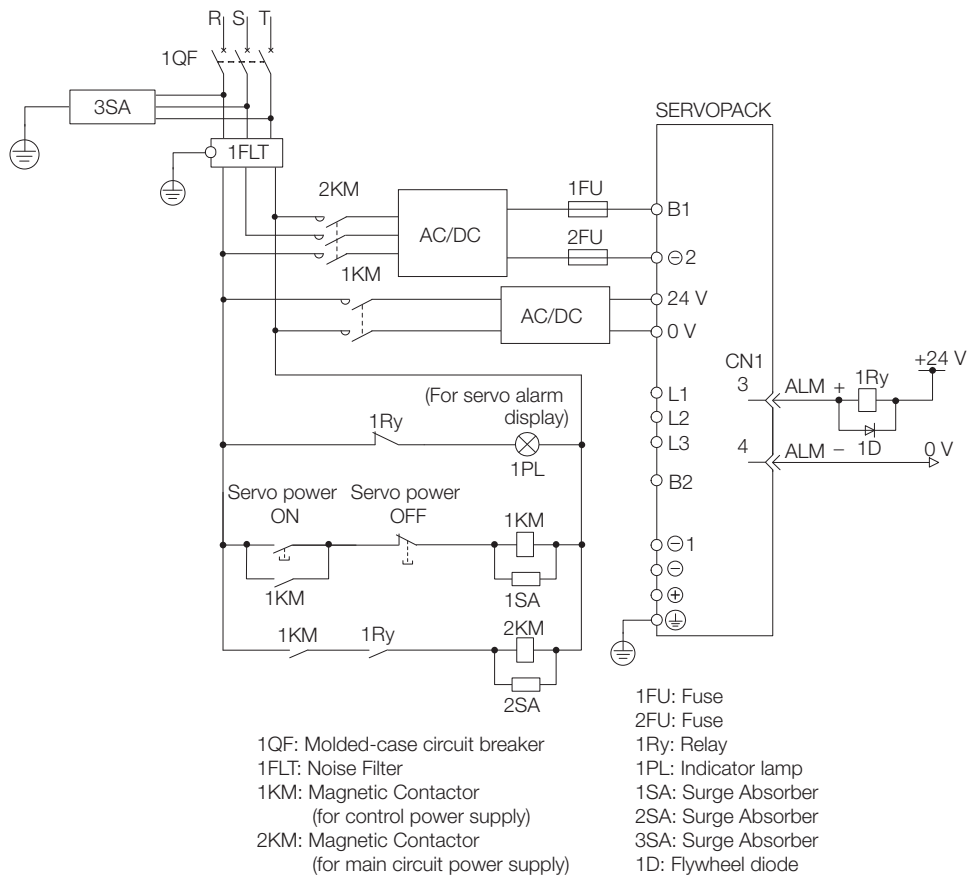

Using More Than One SERVOPACK

Connect the ALM (Servo Alarm) output for these SERVOPACKs in series to operate the alarm detection relay (1RY).

When a SERVOPACK alarm is activated, the ALM output signal transistor turns OFF.

The following diagram shows the wiring to stop all of the Servomotors when there is an alarm for any one SERVOPACK.

More than one SERVOPACK can share a single Noise Filter. However, always select a Noise Filter that has a large enough capacity to handle the total power supply capacity of all the SERVOPACKs. Be sure to consider the load conditions.

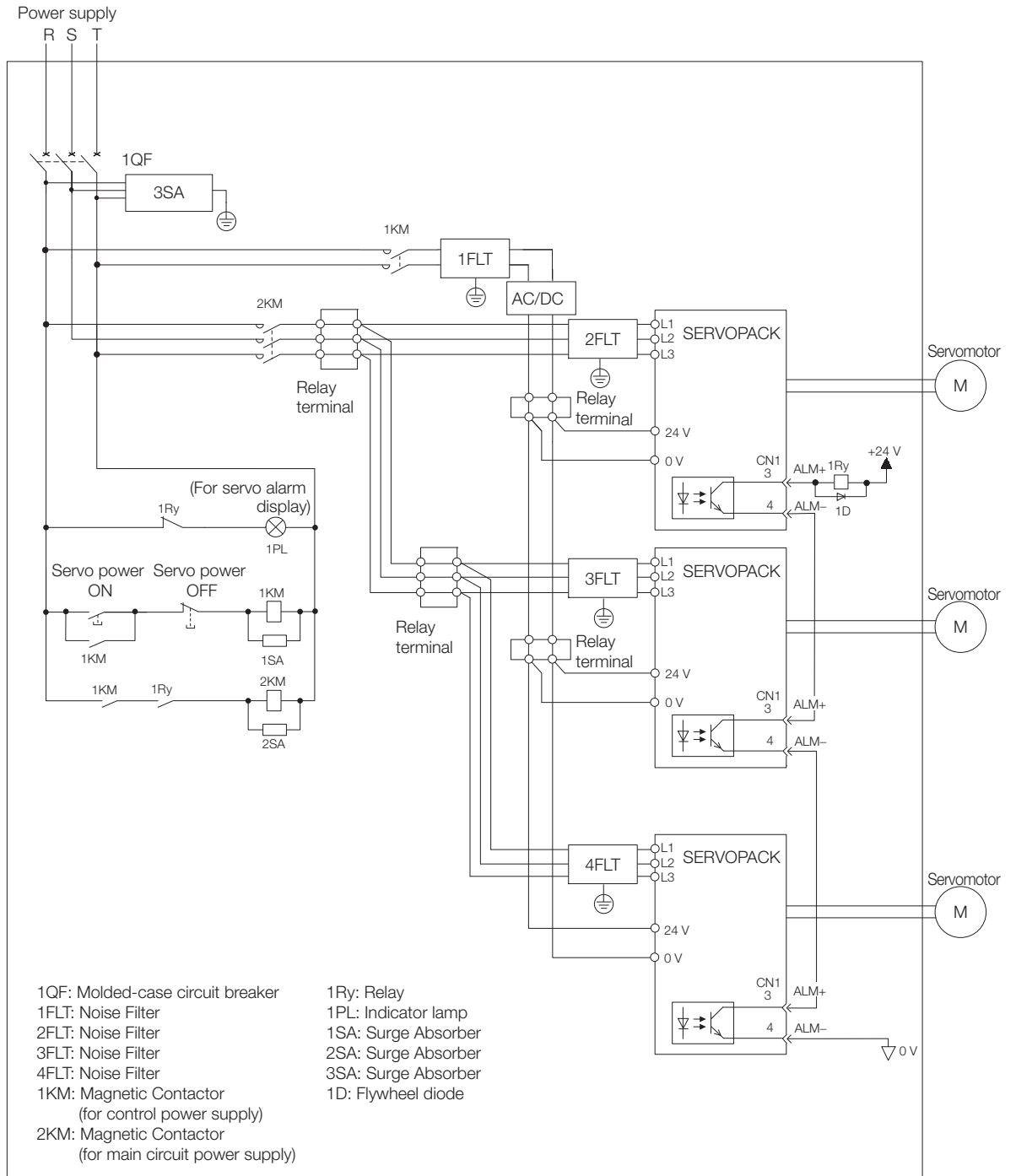

To comply with UL/cUL standards, you must install a branch circuit protective device at the power supply input section to each SERVOPACK. Refer to the following document for details.

Σ-7-Series Σ-7S and Σ-7W SERVOPACK with 400 V-Input Power Safety Precautions (Manual No.: TOMP C710828 02)

4.3.5 Wiring Regenerative Resistors

This section describes how to connect External Regenerative Resistors. Refer to the catalog to select External Regenerative Resistors.

 **WARNING**

- Be sure to wire Regenerative Resistors correctly. Do not connect B1/⊕ and B2. Doing so may result in fire or damage to the Regenerative Resistor or SERVOPACK.

Connecting Regenerative Resistors

1. Remove the wire connected between the B2 and B3 terminals.

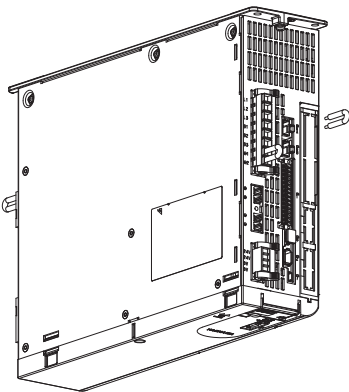

2. Connect the External Regenerative Resistor between the B1 and B2 terminals on the SERVOPACK.

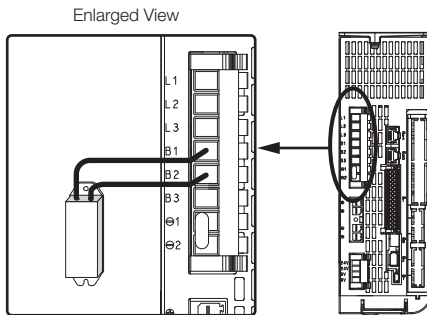

3. Set Pn600 (Regenerative Resistor Capacity) and Pn603 (Regenerative Resistor Resistance). Refer to the following section for details on the settings.

 6.17 Setting the Regenerative Resistor Capacity on page 6-55

4.3.6 Wiring Reactors for Harmonic Suppression

You can connect a reactor for harmonic suppression to the SERVOPACK when power supply harmonic suppression is required. Connection terminals ⊕1 and ⊕2 for a DC Reactor are connected when the SERVOPACK is shipped. Remove the lead wire and connect a DC Reactor as shown in the following diagram.

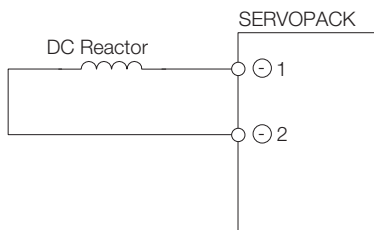

4.4 Wiring Servomotors

4.4.1 Terminal Symbols and Terminal Names

The SERVOPACK terminals or connectors that are required to connect the SERVOPACK to a Servomotor are given below.

Terminal/Connector Symbols	Terminal/Connector Name	Remarks
U, V, and W	Servomotor terminals	Refer to the following section for the wiring procedure.  4.3.2 Connector Wiring Procedure on page 4-13
PE	Ground terminal	–
CN2	Encoder connector	–

4.4.2 Pin Arrangement of Encoder Connector (CN2)

- When Using a Rotary Servomotor

Pin No.	Signal	Function
1	PG5V	Encoder power supply +5 V
2	PG0V	Encoder power supply 0 V
3	BAT (+)*	Battery for absolute encoder (+)
4	BAT (-)*	Battery for absolute encoder (-)
5	PS	Serial data (+)
6	/PS	Serial data (-)
Shell	Shield	–

* You do not need to wire these pins for an incremental encoder.

- When Using a Linear Servomotor

Pin No.	Signal	Function
1	PG5V	Linear encoder power supply +5 V
2	PG0V	Linear encoder power supply 0 V
3	–	– (Do not use.)
4	–	– (Do not use.)
5	PS	Serial data (+)
6	/PS	Serial data (-)
Shell	Shield	–

4.4.3 Wiring the SERVOPACK to the Encoder

When Using an Absolute Encoder

If you use an absolute encoder, use an Encoder Cable with a JUSP-BA01-E Battery Case or install a battery on the host controller.

Refer to the following section for the battery replacement procedure.

 16.1.3 Replacing the Battery on page 16-3

- Wiring Example When Installing a Battery on the Host Controller

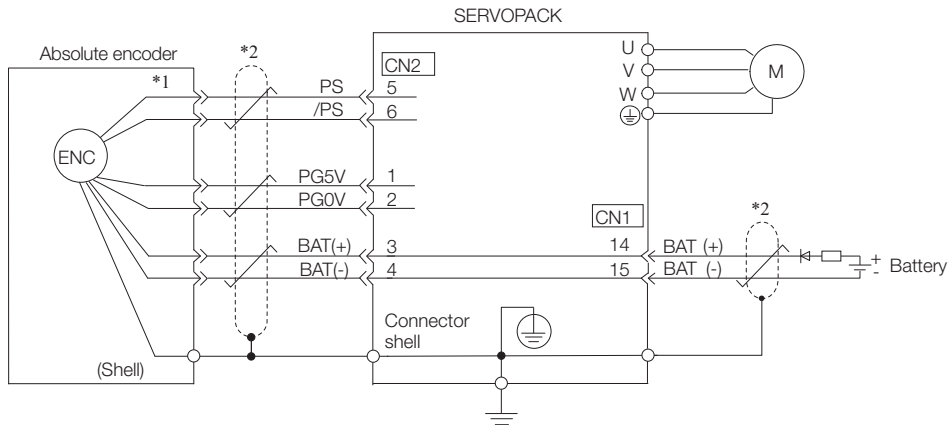

*1. The absolute encoder pin numbers for wiring the connector depend on the Servomotor that you use.

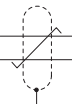
*2.  represents a shielded twisted-pair cable.

- Wiring Example When Using an Encoder Cable with a Battery Case

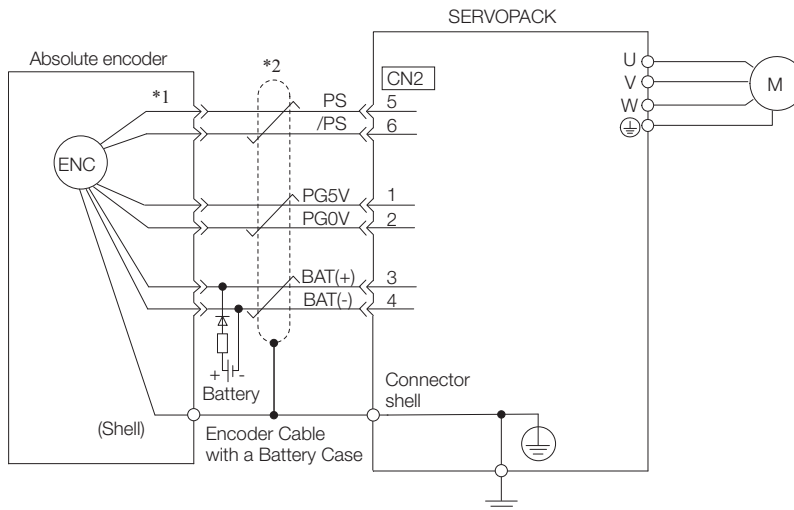

*1. The absolute encoder pin numbers for wiring the connector depend on the Servomotor that you use.

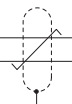
*2.  represents a shielded twisted-pair cable.



Important

- When Installing a Battery on the Encoder Cable Use the Encoder Cable with a Battery Case that is specified by Yaskawa. Refer to the catalog for details.
- When Installing a Battery on the Host Controller Insert a diode near the battery to prevent reverse current flow.

Circuit Example

Required Component Specifications

- Schottky Diode
 - Reverse Voltage: $V_r \geq 40\text{ V}$
 - Forward Voltage: $V_f \leq 0.37\text{ V}$
 - Reverse current: $I_r \leq 5\ \mu\text{A}$
 - Junction temperature: $T_j \geq 125^\circ\text{C}$
- Resistor
 - Resistance: $22\ \Omega$
 - Tolerance: $\pm 5\%$ max.
 - Rated power: 0.25 W min.

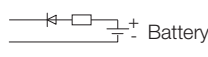

When Using an Incremental Encoder

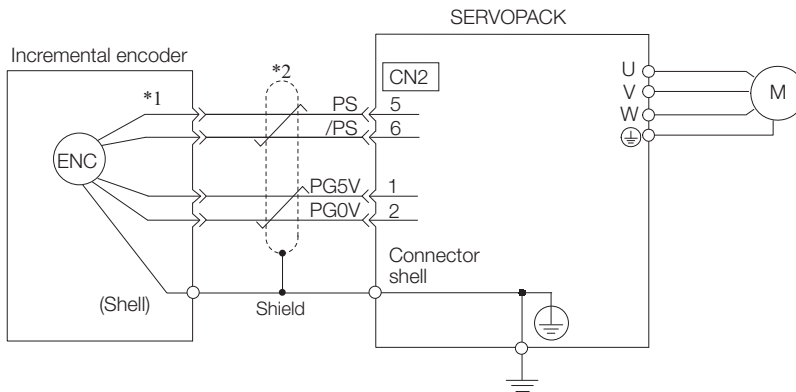

*1. The incremental encoder pin numbers for wiring the connector depend on the Servomotor that you use.

*2.  represents a shielded twisted-pair cable.

When Using an Absolute Linear Encoder

The wiring depends on the manufacturer of the linear encoder.

◆ Connections to Linear Encoder from Dr. JOHANNES HEIDENHAIN GmbH

■ LIC4100 Series, LIC2100 Series, LC115, and LC415

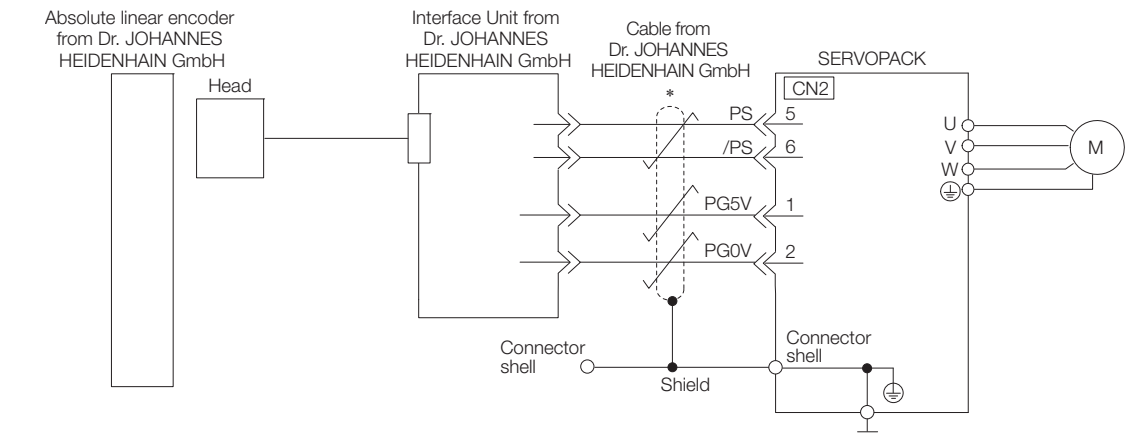

*  represents a shielded twisted-pair cable.

Information Sales of the interface unit EIB3391Y with the LIC4100 and LIC2100 series have ended due to the release of the LIC4190, LIC3190, and LIC2190 series.

■ LIC4190, LIC3190, and LIC2190 Series

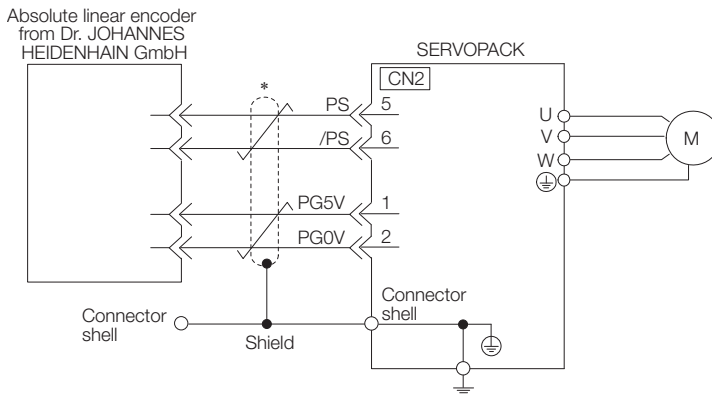

* represents a shielded twisted-pair cable.

◆ Connections to Linear Encoder from RSF Elektronik GmbH

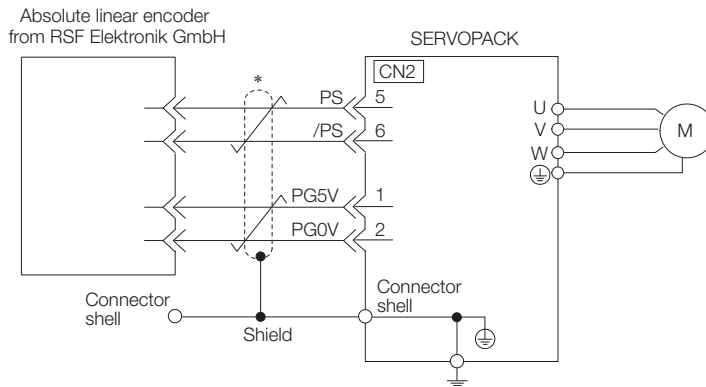

* represents a shielded twisted-pair cable.

◆ Connections to Linear Encoder from Mitutoyo Corporation

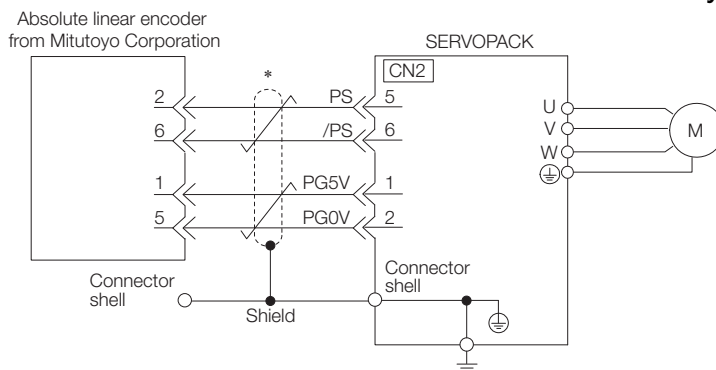

* represents a shielded twisted-pair cable.

◆ Connections to Absolute Linear Encoder from Renishaw PLC

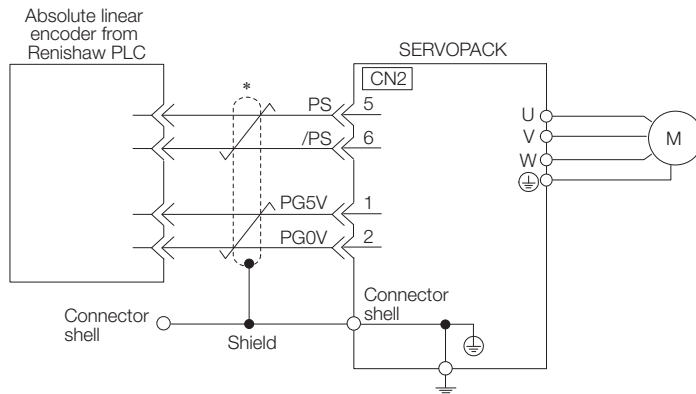

*  represents a shielded twisted-pair cable.

◆ Connections to Linear Encoder from RLS d.o.o.

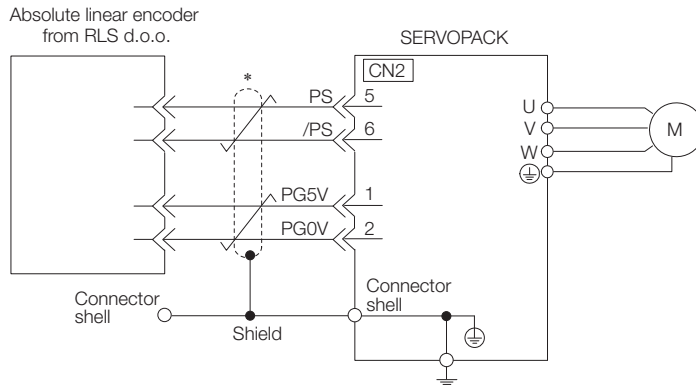

*  represents a shielded twisted-pair cable.

◆ Connections to Absolute Linear Encoder from Magnescale Co., Ltd.

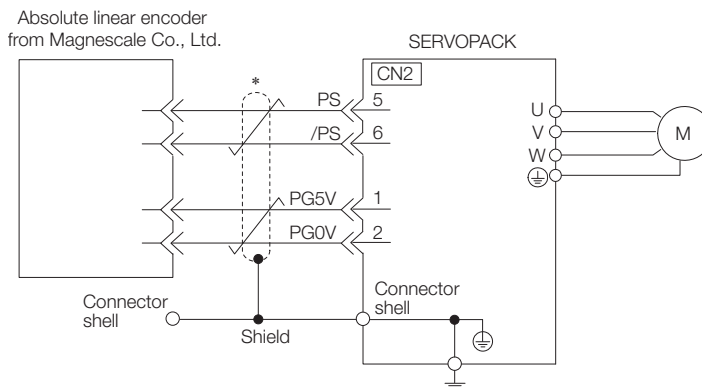

*  represents a shielded twisted-pair cable.

◆ Connections to Absolute Linear Encoder from Fagor Automation S. Coop.

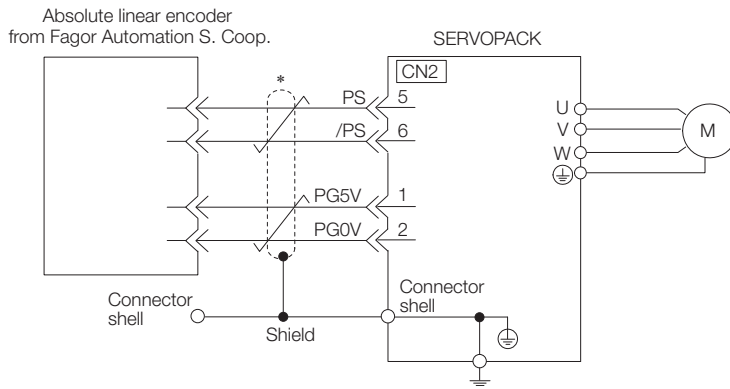

*  represents a shielded twisted-pair cable.

◆ Connections to Absolute Linear Encoder from Canon Precision Inc.

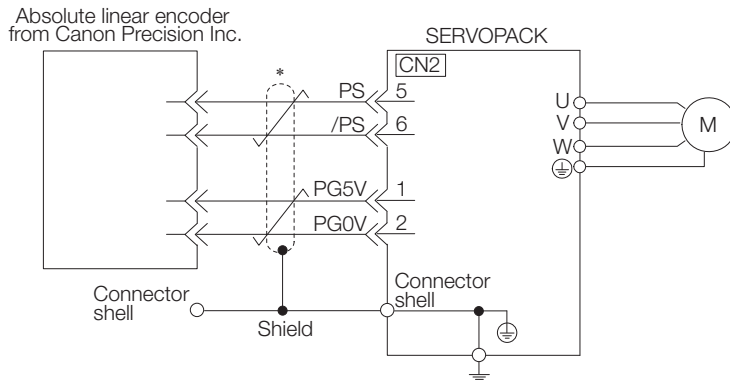

*  represents a shielded twisted-pair cable.

When Using an Incremental Linear Encoder

The wiring depends on the manufacturer of the linear encoder.

◆ Connections to Linear Encoder from Dr. JOHANNES HEIDENHAIN GmbH

Linear encoder from
Dr. JOHANNES
HEIDENHAIN GmbH

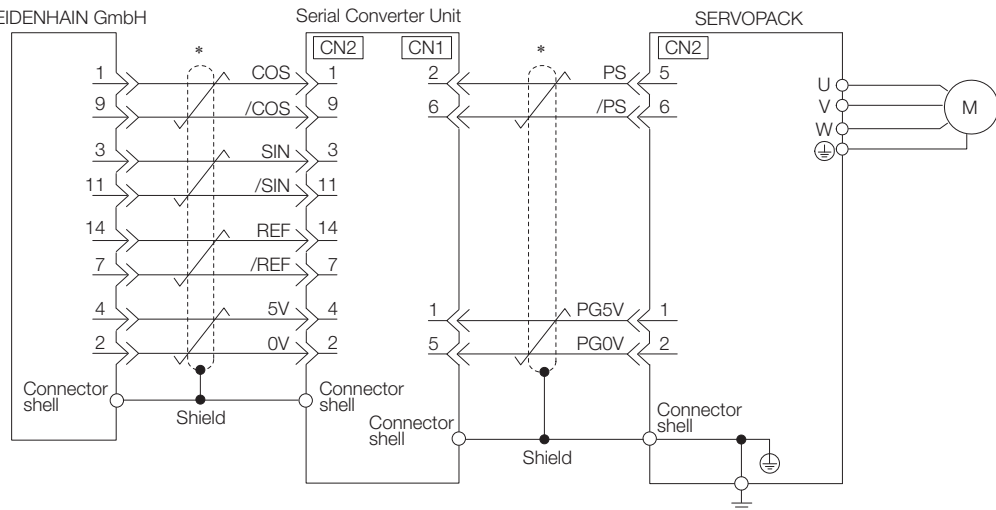

*  represents a shielded twisted-pair cable.

◆ Connections to Linear Encoder from Renishaw PLC

Linear encoder from
Renishaw PLC

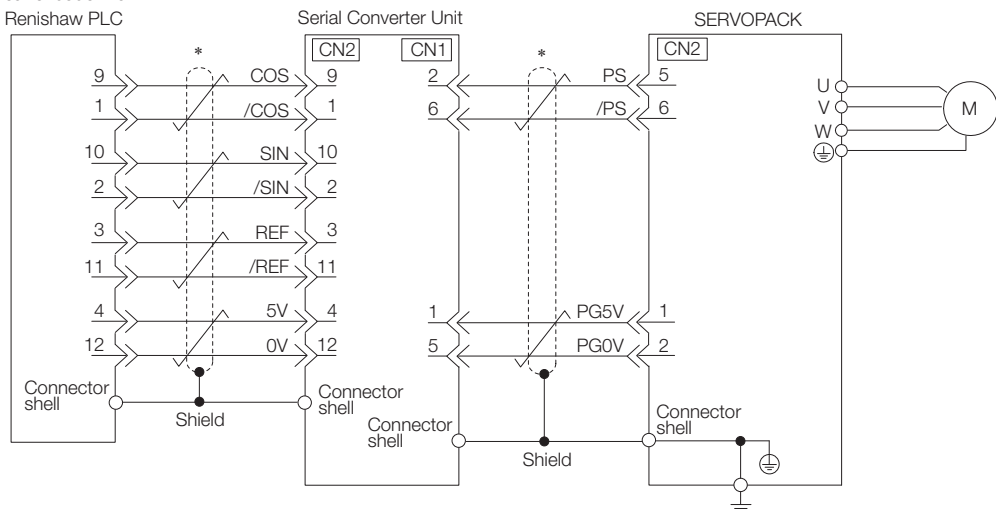

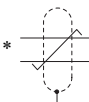
*  represents a shielded twisted-pair cable.

◆ **Connections to Linear Encoder from Magnescale Co., Ltd.**

If you use a linear encoder from Magnescale Co., Ltd., the wiring will depend on the model of the linear encoder.

■ **SR75 and SR85**

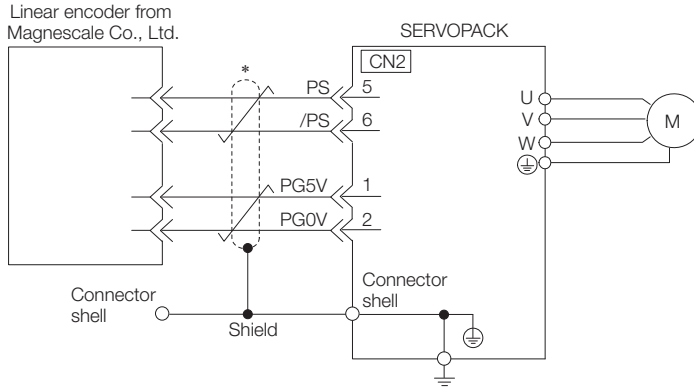

* represents a shielded twisted-pair cable.

■ **SL700, SL710, SL720, SL730, and SQ10**

- PL101-RY, MQ10-FLA, or MQ10-GLA Interpolator

The following table gives the Linear Encoder and Interpolator combinations.

Linear Encoder Model	Interpolator Model
SL700, SL710, SL720, and SL730	PL101-RY*1
SQ10	MQ10-FLA*2
	MQ10-GLA*2

*1. This is the model of the Head with Interpolator.

*2. This is the model of the Interpolator.

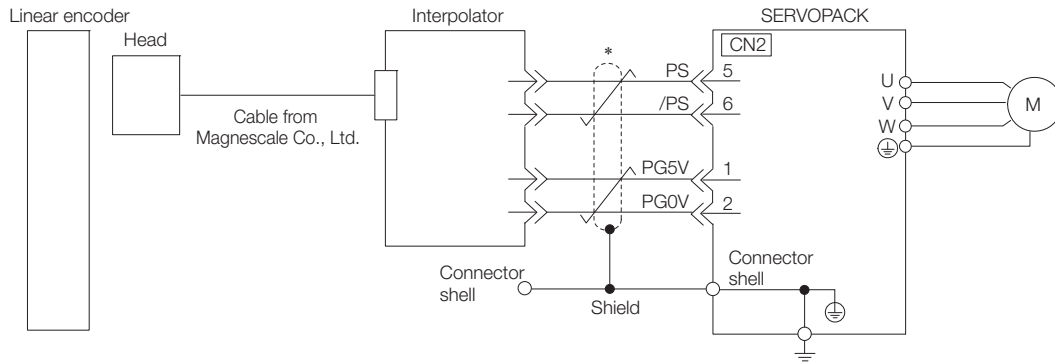

* represents a shielded twisted-pair cable.

- SL700, SL710, SL720, and SL730
- MJ620-T13 Interpolator

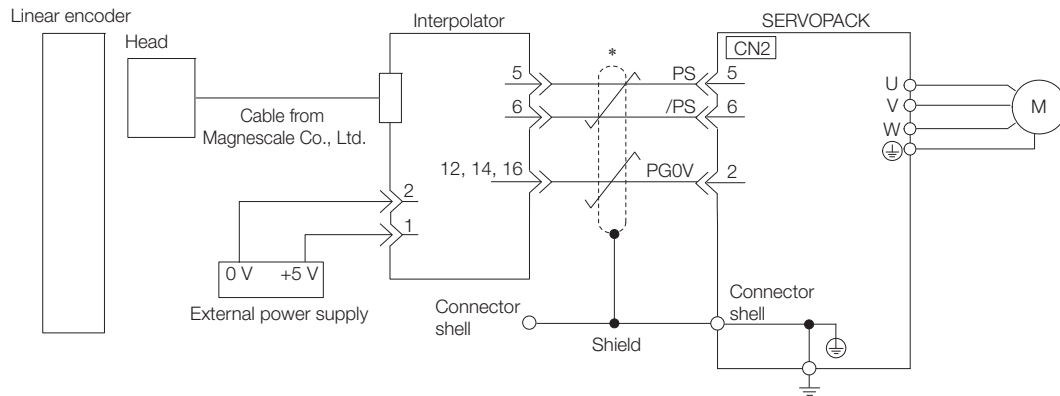

*  represents a shielded twisted-pair cable.

◆ Connections to Linear Encoder from Canon Precision Inc.

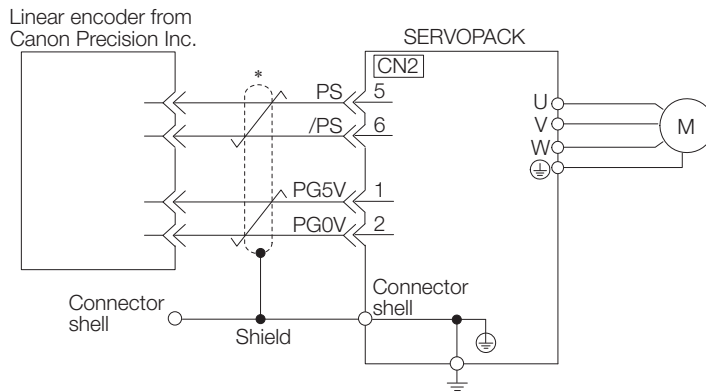

*  represents a shielded twisted-pair cable.

4.4.4 Wiring the SERVOPACK to the Holding Brake



Important

- If you use a Rotary Servomotor, select a Surge Absorber according to the brake current and brake power supply. Refer to the catalog for details.
- After the Surge Absorber is connected, check the time required to brake in your application. The Surge Absorber may affect the time required to brake. Configure the relay circuit to activate the holding brake for an emergency stop.

Relay Circuit Example

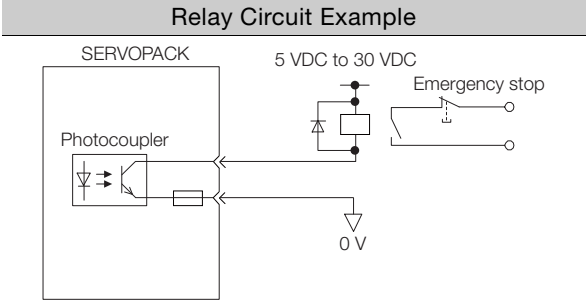

- You can change the output signal allocation of the /BK signal. Refer to the following section for details.
 - 🔗 *Allocating the /BK (Brake) Signal on page 6-34*
- If you use a 24-V brake, install a separate power supply for the 24-VDC power supply from other power supplies, such as the one for the I/O signals of the CN1 connector. If the power supply is shared, the I/O signals may malfunction.

SERVOPACKs without Built-in Servomotor Brake Control

A wiring example for SERVOPACKs without built-in Servomotor brake control is provided below.

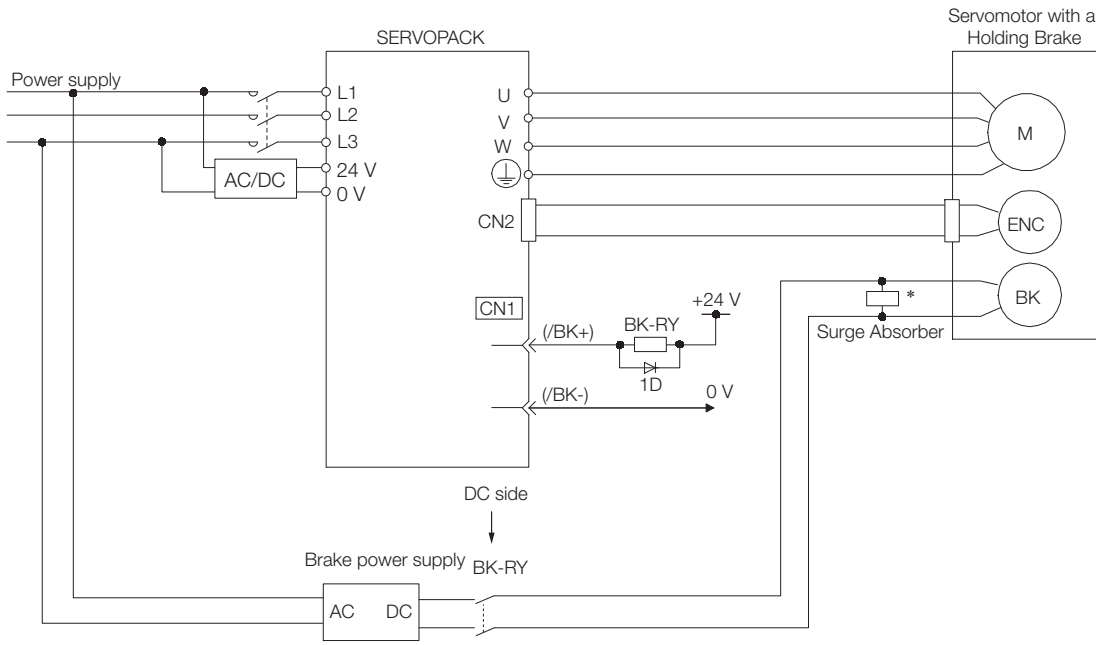

BK-RY: Brake control relay
 1D: Flywheel diode

* Install the Surge Absorber near the brake terminals on the Servomotor.

SERVOPACKs with Built-in Servomotor Brake Control

SERVOPACKs with built-in brake control contain a brake relay.

The wiring is different because of the built-in brake relays. The following figure shows a wiring example.

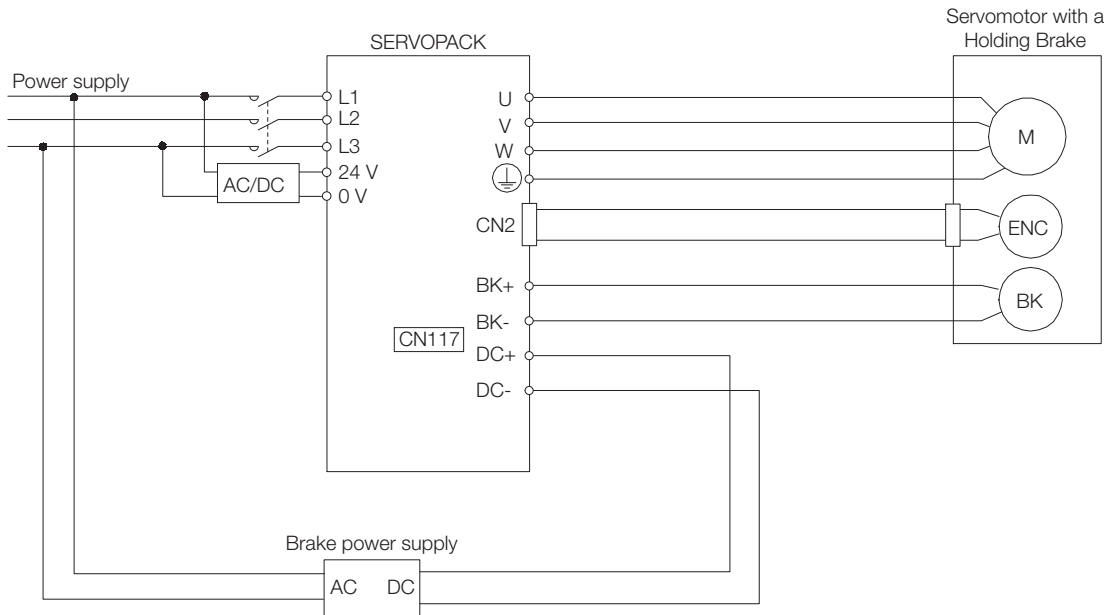

• Connector Specifications

Connector No.	Model	Number of Pins	Manufacturer
CN117	BLF 5.08HC/04/180LR SN BK BX SO	4	Weidmüller Interface GmbH & Co. KG

◆ Built-in Brake Relay Specifications

The specifications of the built-in brake relay are as follows:

- Service life (number of operations): 30,000 operations
- Allowable number of operations: 30 operations per minute max.

4.5 Connecting I/O Signals

4.5.1 I/O Signal Connector (CN1) Names and Functions

The following table gives the pin numbers, names, and functions the I/O signal pins for the default settings.

Input Signals

Default settings are given in parentheses.

Signal	Pin No.	Name	Function	Reference
/SI1* (P-OT)	7	General-purpose Sequence Input 1 (For- ward Drive Prohibit Input)	You can allocate the input signal to use with a parameter. (Stops Servomotor drive (to prevent over- travel) when the moving part of the machine exceeds the range of move- ment.)	page 6-26
/SI2* (N-OT)	8	General-purpose Sequence Input 2 (Reverse Drive Prohibit Input)		
/SI3*	9	General-purpose Sequence Input 3	You can allocate the input signal to use with parameters. (Used for general-purpose input.)	–
/SI4* (/Probe1)	10	General-purpose Sequence Input 4 (Probe 1 Latch Input)	You can allocate the input signals to use with parameters. (Connect the external signals that latch the current feedback pulse counter.)	–
/SI5* (/Probe2)	11	General-purpose Sequence Input 5 (Probe 2 Latch Input)		
/SI6* (/Home)	12	General-purpose Sequence Input 6 (Home Switch Input)	You can allocate the input signal to use with parameters. (Connect the switch that starts homing.)	–
/SI0*	13	General-purpose Sequence Input 0	You can allocate the input signal to use with a parameter. (Used for general-purpose input.)	–
+24VIN	6	Sequence Input Signal Power Supply Input	Inputs the sequence input signal power supply. Allowable voltage range: 24 VDC \pm 20% The 24-VDC power supply is not provided by Yaskawa.	–
BAT+	14	Battery for Absolute Encoder (+)	These are the pins to connect the abso- lute encoder backup battery. Do not connect these pins if you use the Encoder Cable with a Battery Case.	–
BAT-	15	Battery for Absolute Encoder (-)		
TH	5	Overheat Protection Input	Inputs the overheat protection signal from a Linear Servomotor or from a sensor attached to the machine.	–

* You can change the allocations. Refer to the following section for details.

 7.1.1 Input Signal Allocations on page 7-4

Note: If forward drive prohibition or reverse drive prohibition is used, the SERVOPACK is stopped by software con-
trols. If the application does not satisfy the safety requirements, add external safety circuits as required.

Output Signals

Default settings are given in parentheses.

Signal	Pin No.	Name	Function	Reference
ALM+	3	Servo Alarm Output	Turns OFF (opens) when an error is detected.	page 7-7
ALM-	4			
/SO1+* (/BK+)	1	General-purpose Sequence Output 1 (Brake Output)	You can allocate the output signal to use with a parameter. (Controls the brake. The brake is released when the signal turns ON (closes).)	page 6-32
/SO1-* (/BK-)	2			
/SO2+*	23	General-purpose Sequence Output 2	Used for general-purpose outputs. Set the parameters to allocate functions.	page 15-49
/SO2-*	24			
/SO3+*	25	General-purpose Sequence Output 3		
/SO3-*	26			
/SO4+*	27	General-purpose Sequence Output 4		
/SO4-*	28			
/SO5+*	29	General-purpose Sequence Output 5		
/SO5-*	30			
PAO	17	Encoder Divided Pulse Output, Phase A	Output the encoder divided pulse output signals with a 90° phase differential.	page 7-31 page 7-40
/PAO	18			
PBO	19	Encoder Divided Pulse Output, Phase B		
/PBO	20			
PCO	21	Encoder Divided Pulse Output, Phase C	Outputs the origin signal once every encoder rotation.	
/PCO	22			
SG	16	Signal ground	This is the 0-V signal for the control circuits.	–

* You can change the allocations. Refer to the following section for details.

 7.1.2 Output Signal Allocations on page 7-5

4.5.2 I/O Signal Connector (CN1) Pin Arrangement

The following figure gives the pin arrangement of the of the I/O signal connector (CN1) for the default settings.

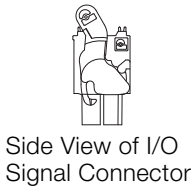
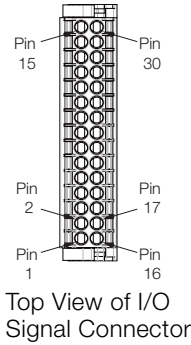

No	Signal	Specification	No	Signal	Specification
15	PG BAT-	Battery for absolute encoder (-)	30	/SO5-	General-purpose sequence output 5
14	PG BAT+	Battery for absolute encoder (+)	29	/SO5+	General-purpose sequence output 5
13	/SI0	General-purpose sequence input 0	28	/SO4-	General-purpose sequence output 4
12	/SI6 (/Home)	General-purpose sequence input 6	27	/SO4+	General-purpose sequence output 4
11	/SI5 (/Probe2)	General-purpose sequence input 5	26	/SO3-	General-purpose sequence output 3
10	/SI4 (/Probe1)	General-purpose sequence input 4	25	/SO3+	General-purpose sequence output 3
9	/SI3	General-purpose sequence input 3	24	/SO2-	General-purpose sequence output 2
8	/SI2 (N-OT)	General-purpose sequence input 2	23	/SO2+	General-purpose sequence output 2
7	/SI1 (P-OT)	General-purpose sequence input 1	22	/PCO	Encoder divided pulse output, phase C
6	+24VIN	Sequence input signal power supply input	21	PCO	Encoder divided pulse output, phase C
5	TH	Overheat protection input	20	/PBO	Encoder divided pulse output, phase B
4	ALM-	Servo alarm output	19	PBO	Encoder divided pulse output, phase B
3	ALM+	Servo alarm output	18	/PAO	Encoder divided pulse output, phase A
2	/SO1- (/BK-)	General-purpose sequence output 1	17	PAO	Encoder divided pulse output, phase A
1	/SO1+ (/BK+)	General-purpose sequence output 1	16	SG	Signal ground

4.5.3 I/O Signal Wiring Examples

Using a Rotary Servomotor

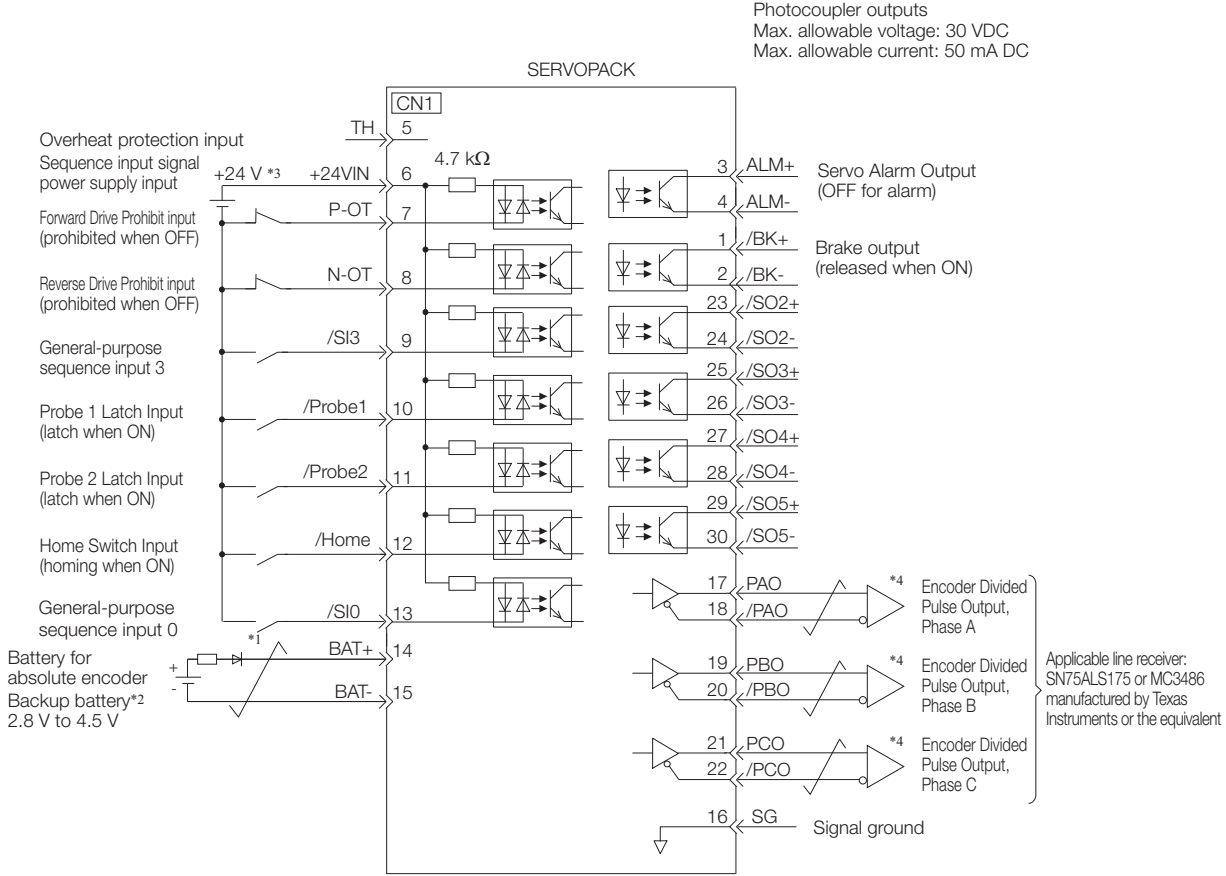

- *1. represents twisted-pair wires.
- *2. Connect these when using an absolute encoder. If the Encoder Cable with a Battery Case is connected, do not connect a backup battery.
- *3. The 24-VDC power supply is not provided by Yaskawa. Use a 24-VDC power supply with double insulation or reinforced insulation.
- *4. Always use line receivers to receive the output signals.

Note: 1. You can use parameters to change the functions allocated to the /SI0, /SI3, P-OT, N-OT, /Probe1, /Probe2, and /Home input signals and the /SO1, /SO2, /SO3, /SO4, and /SO5 output signals.

7.1 I/O Signal Allocations on page 7-4

- 2. If you use a 24-V brake, install a separate power supply for the 24-VDC power supply from other power supplies, such as the one for the I/O signals of the CN1 connector. If the power supply is shared, the I/O signals may malfunction.

Wiring and Connecting SERVOPACKS

Using a Linear Servomotor

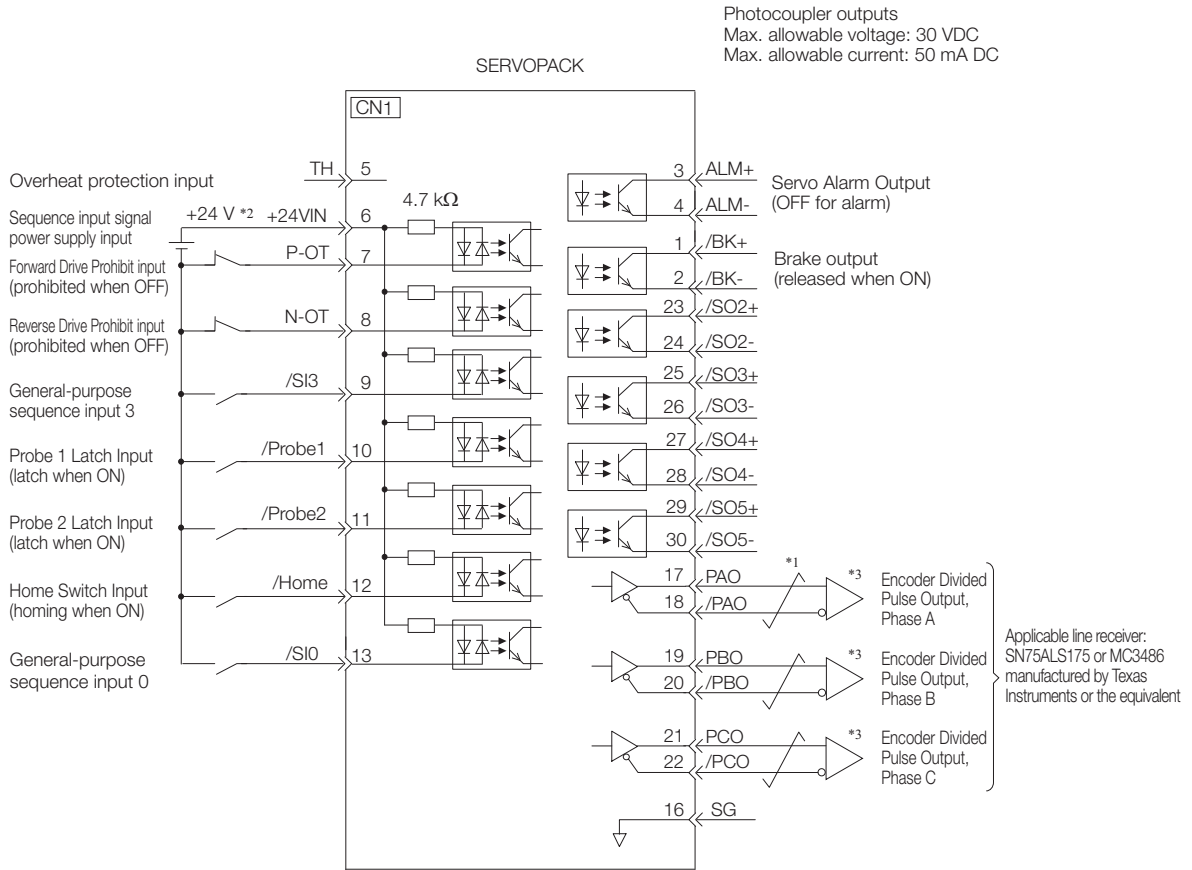

*1. represents twisted-pair wires.

*2. The 24-VDC power supply is not provided by Yaskawa. Use a 24-VDC power supply with double insulation or reinforced insulation.

*3. Always use line receivers to receive the output signals.

Note: 1. You can use parameters to change the functions allocated to the /SIO, /SI3, P-OT, N-OT, /Probe1, /Probe2, and /Home input signals and the /SO1, /SO2, /SO3, /SO4, and /SO5 output signals.

7.1 I/O Signal Allocations on page 7-4

2. If you use a 24-V brake, install a separate power supply for the 24-VDC power supply from other power supplies, such as the one for the I/O signals of the CN1 connector. If the power supply is shared, the I/O signals may malfunction.

4.5.4 I/O Circuits

Sequence Input Circuits

◆ Photocoupler Input Circuits

This section describes CN1 connector terminals 6 to 13.

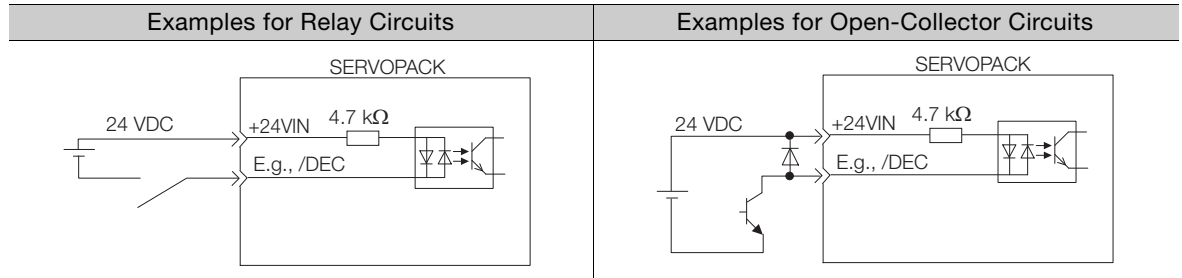

Note: The 24-VDC external power supply capacity must be 50 mA minimum.

The SERVOPACK input circuits use bidirectional photocouplers. Select either a sink circuit or source circuit according to the specifications required by the machine.

Note: The connection examples in 4.5.3 I/O Signal Wiring Examples on page 4-33 are for sink circuit connections.

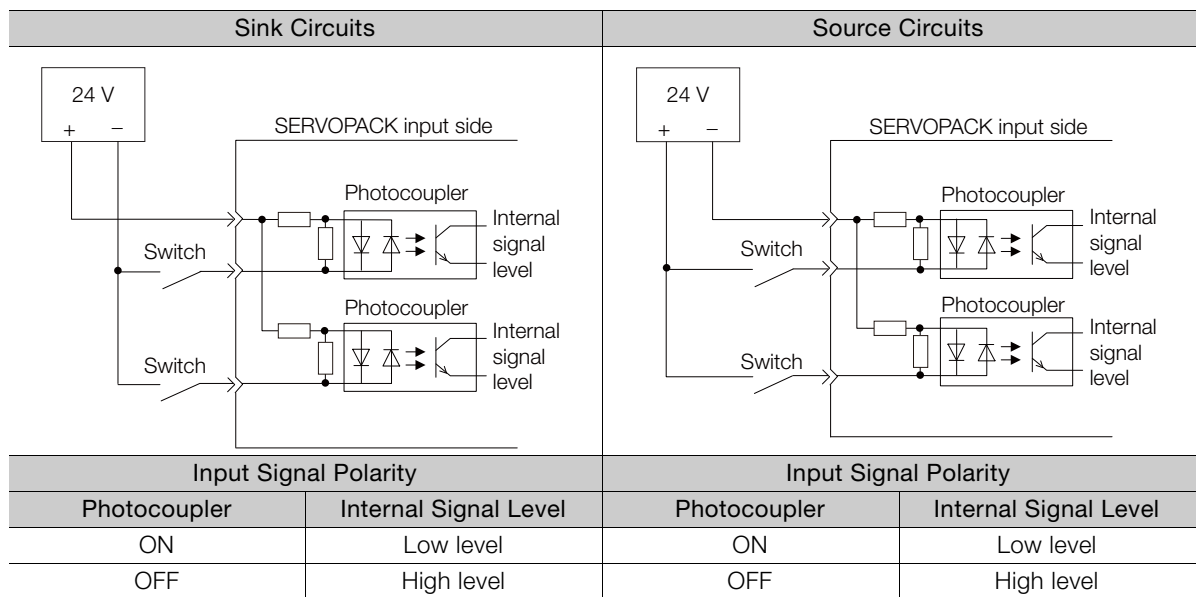

Sequence Output Circuits



Important

Incorrect wiring or incorrect voltage application to the output circuits may cause short-circuit failures.

If a short-circuit failure occurs as a result of any of these causes, the holding brake will not work. This could damage the machine or cause an accident that may result in death or injury.

◆ Photocoupler Output Circuits

Photocoupler output circuits are used for the ALM (Servo Alarm), /S-RDY (Servo Ready), and other sequence output signals. Connect a photocoupler output circuit to a relay or line-receiver circuit.

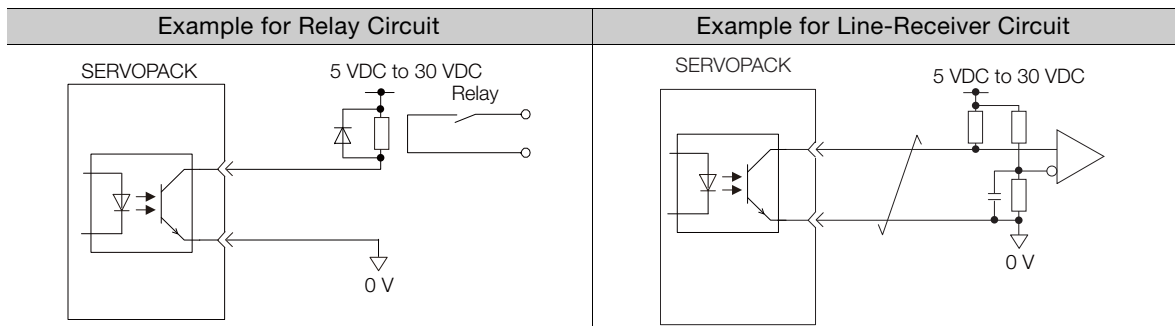

Note: The maximum allowable voltage and current range for photocoupler output circuits are as follows:

- Maximum allowable voltage: 30 VDC
- Current range: 5 mA to 50 mA DC

◆ Line-Driver Output Circuits

This section describes CN1 connector terminals 17-18 (Phase-A Signal), 19-20 (Phase-B Signal), and 21-22 (Phase-C Signal).

The serial data from the encoder is converted to two-phase (phases A and B) pulses. The resulting output signals (PAO, /PAO and PBO, /PBO) and origin pulse signal (PCO and /PCO) are output with line-driver output circuits. Connect the line-driver output circuits to line-receiver circuits at the host controller.

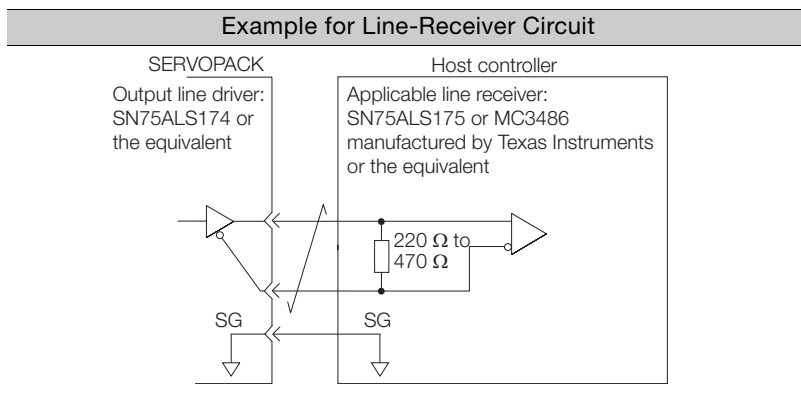

4.6

Connecting Safety Function Signals

This section describes the wiring required to use a safety function.

Refer to the following chapter for details on the safety function.

Chapter 12 Safety Functions

4.6.1 Pin Arrangement of Safety Function Signals (CN8)

Pin No.	Signal	Name	Function
1	-	- (Do not use these pins because they are connected to internal circuits.)	
2	-		
3	/HWBB1-	Hard Wire Base Block Input 1	For a hard wire base block input. The base block (motor power turned OFF) is in effect when the signal is OFF.
4	/HWBB1+		
5	/HWBB2-	Hard Wire Base Block Input 2	
6	/HWBB2+		
7	EDM1-	External Device Monitor Output	Turns ON when the /HWBB1 and the /HWBB2 signals are input and the SERVOPACK enters a base block state.
8	EDM1+		

4.6.2 I/O Circuits



Important

For safety function signal connections, the input signal is the 0-V common and the output signal is a source output. This is opposite to other signals described in this manual.

To avoid confusion, the ON and OFF status of signals for the safety function are defined as follows:

ON: The state in which the relay contacts are closed or the transistor is ON and current flows into the signal line.

OFF: The state in which the relay contacts are open or the transistor is OFF and no current flows into the signal line.

Safety Input Circuits

Use a 0-V common to connect the safety function signals. You must connect redundant input signals.

Input Signal Connection Example

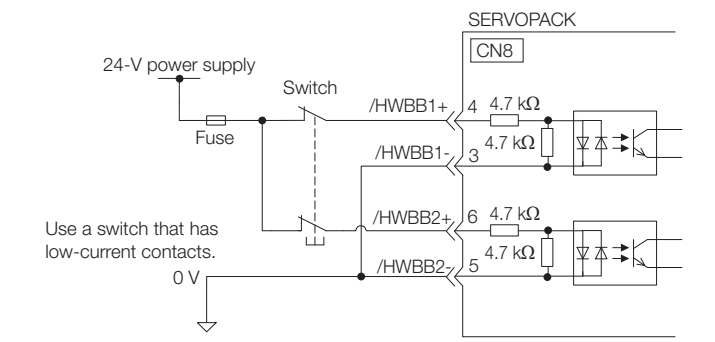

◆ Input (HWBB) Signal Specifications

Type	Signal	Connector Pin No.	Status	Meaning
Inputs	/HWBB1	CN8-4 CN8-3	ON (closed)	Does not activate the HWBB (normal operation).
			OFF (open)	Activates the HWBB (motor current shut-OFF request).
	/HWBB2	CN8-6 CN8-5	ON (closed)	Does not activate the HWBB (normal operation).
			OFF (open)	Activates the HWBB (motor current shut-OFF request).

The input (HWBB) signals have the following electrical characteristics.

Item	Characteristics	Remarks
Internal Impedance	4.7 kΩ	–
Operating Voltage Range	+24 V ±20%	–
Maximum Delay Time	8 ms	Time from /HWBB1 and /HWBB2 signals turning OFF until HWBB is activated

Diagnostic Output Circuits

The EDM1 output signal uses a source circuit. The following figure shows a connection example.

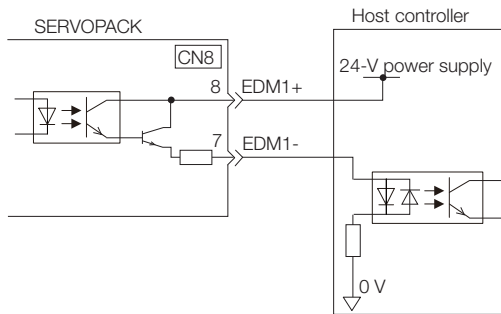

◆ EDM1 Output Signal Specifications

Type	Signal	Pin No.	Output Status	Meaning
Output	EDM1	CN8-8 CN8-7	ON	Both the /HWBB1 and /HWBB2 signals are operating normally.
			OFF	The /HWBB1 signal, the /HWBB2 signal, or both are not operating.

The electrical characteristics of the EDM1 signal are as follows:

Item	Characteristics	Remarks
Maximum Allowable Voltage	30 VDC	–
Maximum Allowable Current	50 mA DC	–
Maximum ON Voltage Drop	1.0 V	Voltage between EDM1+ and EDM1- when current is 50 mA
Maximum Delay Time	8 ms	Time from a change in /HWBB1 or /HWBB2 until a change in EDM1

4.7

Connecting EtherCAT Communications Cables

Connect the EtherCAT Communications Cables to the CN6A and CN6B connectors.

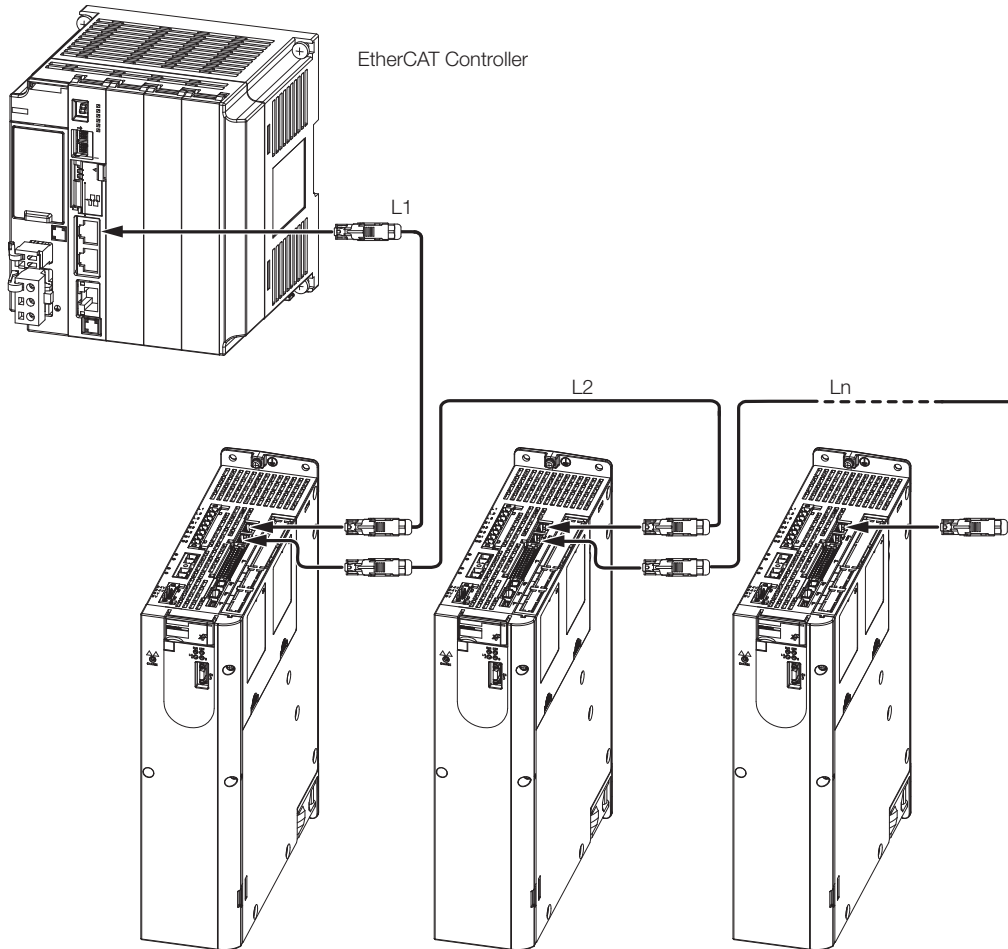

Note: The length of the cable between stations (L1, L2, ... Ln) must be 50 m or less.

4.7.1 EtherCAT Connectors (RJ45)

Connector	Description
CN6A	EtherCAT input signals
CN6B	EtherCAT output signals

■ Connector Pin Assignments

Pin	Signal	Remarks
1	TD+	Send data
2	TD-	
3	RD+	Receive data
4	-	N.C.*
5	-	N.C.*
6	RD-	Receive data
7	-	N.C.*
8	-	N.C.*

* These pins are not connected to any signals.

4.7.2 Ethernet Communications Cables

Use category 5e Ethernet communications cables to make the connections.

Use cables with the following specifications.

Shielded: S/STP or S/UTP

Length: 50 m max. (between nodes)

The following cable is recommended.

Manufacturer	Model
Beckhoff	ZB9020

4.8 Connecting the Other Connectors

4.8.1 Serial Communications Connector (CN3)

To use a Digital Operator or to connect a computer with an RS-422 cable, connect CN3 on the SERVOPACK.

Refer to the following manual for the operating procedures for the Digital Operator.

📖 Σ -7-Series Servo Drive Digital Operator Operating Manual (Manual No.: SIEP S800001 33)

4.8.2 Computer Connector (CN7)

To use the SigmaWin+ Engineering Tool, connect the computer on which the SigmaWin+ is installed to CN7 on the SERVOPACK.

Refer to the following manual for the operating procedures for the SigmaWin+.

📖 AC Servo Drive Engineering Tool SigmaWin+ Operation Manual (Manual No.: SIET S800001 34)



Use the Cable specified by Yaskawa for the Computer Cable. Operation may not be dependable with any other cable.

Refer to the catalog for details on the Computer Cable.

4.8.3 Analog Monitor Connector (CN5)

To use an analog monitor, connect CN5 on the SERVOPACK.

- Wiring Example

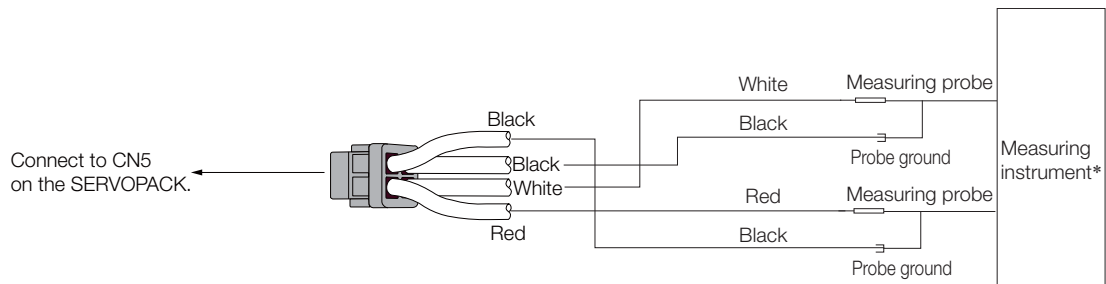

* The measuring instrument is not provided by Yaskawa.

Refer to the following section for information on the monitoring methods for an analog monitor.

📖 10.3 Monitoring Machine Operation Status and Signal Waveforms on page 10-7

Wiring and Settings for the Dynamic Brake

5

This chapter provides information on wiring and settings when using a dynamic brake with the SERVOPACK.

5.1	Introduction to the Dynamic Brake	5-2
5.1.1	SERVOPACK Models with a Built-In Dynamic Brake	5-2
5.1.2	SERVOPACK Models without a Built-In Dynamic Brake	5-2
5.2	SERVOPACK Models with a Built-In Dynamic Brake . . .	5-3
5.2.1	Using the Dynamic Brake	5-3
5.2.2	Selecting the Dynamic Brake Resistor	5-4
5.2.3	Connecting Dynamic Brake Resistors	5-7
5.2.4	Setting the Energy Consumption and Resistance of the Dynamic Brake Resistor	5-9
5.3	SERVOPACK Models without a Built-In Dynamic Brake . .	5-10
5.3.1	Using the Dynamic Brake	5-10
5.3.2	Selecting the Devices Required for the Dynamic Brake Circuit	5-12
5.3.3	Wiring the Dynamic Brake Circuit	5-15
5.3.4	Parameter Settings for the Dynamic Brake Circuit	5-16
5.4	Coasting Distances for Dynamic Braking . . .	5-18
5.4.1	Coasting Distance during Dynamic Braking . . .	5-18
5.4.2	Data for Calculating Coasting Distance	5-19

5.1 Introduction to the Dynamic Brake

Dynamic braking is a method in which the kinetic energy of the Servomotor is converted to electrical energy, and then this energy is consumed as thermal energy with a resistor to brake the motor.

The smaller the resistance of the Dynamic Brake Resistor, the faster the Servomotor can be stopped and the shorter the coasting distance will be. However, the larger the resistance of the Dynamic Brake Resistor, the more time will be required to stop the Servomotor and the longer the coasting distance will be.

Refer to the following section for details on the coasting distance.

 [5.4 Coasting Distances for Dynamic Braking on page 5-18](#)



Term

Coasting Distance
 During dynamic braking, the Servomotor rotates due to inertia until the electrical energy is consumed. The travel distance at this time is called the coasting distance.

Dynamic braking can be used when an alarm occurs, when the servo is turned OFF, during an emergency stop, and when overtravel occurs by setting Pn001 = n.□□□X (Motor Stopping Method for Servo OFF and Group 1 Alarms) to 0 or 1.

Parameter	Meaning	When Enabled	Classification
Pn001 (2001h)	n.□□□0 (default setting)	After restart	Setup
	n.□□□1		
	n.□□□2		

SERVOPACKs are available as models with a built-in dynamic brake (SGD7S-1R9D to 170D) and models without a built-in dynamic brake (SGD7S-210D to 370D).

5.1.1 SERVOPACK Models with a Built-In Dynamic Brake

SGD7S-1R9D to 170D SERVOPACKs are equipped with the built-in circuit required to use the dynamic brake. A Dynamic Brake Resistor is not required when operating the SERVOPACK within its rated range. However, an External Dynamic Brake Resistor must be connected to the SERVOPACK to operate the SERVOPACK in the following manner.

- When specifying the brake torque when stopping with the dynamic brake.
- When operating with a load moment of inertia that exceeds the rating.

Refer to the following section for how to connect the Dynamic Brake Resistor to the SERVOPACK.

 [5.2.3 Connecting Dynamic Brake Resistors on page 5-7](#)

5.1.2 SERVOPACK Models without a Built-In Dynamic Brake

SGD7S-210D to 370D SERVOPACKs are not equipped with a built-in dynamic brake.

To use dynamic braking, you must select the Resistor, create the circuit, and set the parameters.

Refer to the following section for details on the dynamic brake circuit.

 [5.3.3 Wiring the Dynamic Brake Circuit on page 5-15](#)

Refer to the following section for details on selecting the Dynamic Brake Resistor.

 [5.3.2 Selecting the Devices Required for the Dynamic Brake Circuit on page 5-12](#)

Refer to the following section for details on parameter settings for the dynamic brake.

 [5.3.4 Parameter Settings for the Dynamic Brake Circuit on page 5-16](#)

5.2

SERVOPACK Models with a Built-In Dynamic Brake

This section describes how to use the SERVOPACKs (SGD7S-1R9D to 170D) equipped with a built-in dynamic brake.

5.2.1 Using the Dynamic Brake

When using the SGD7S-1R9D to 170D, set up the SERVOPACK according to the following flowchart.

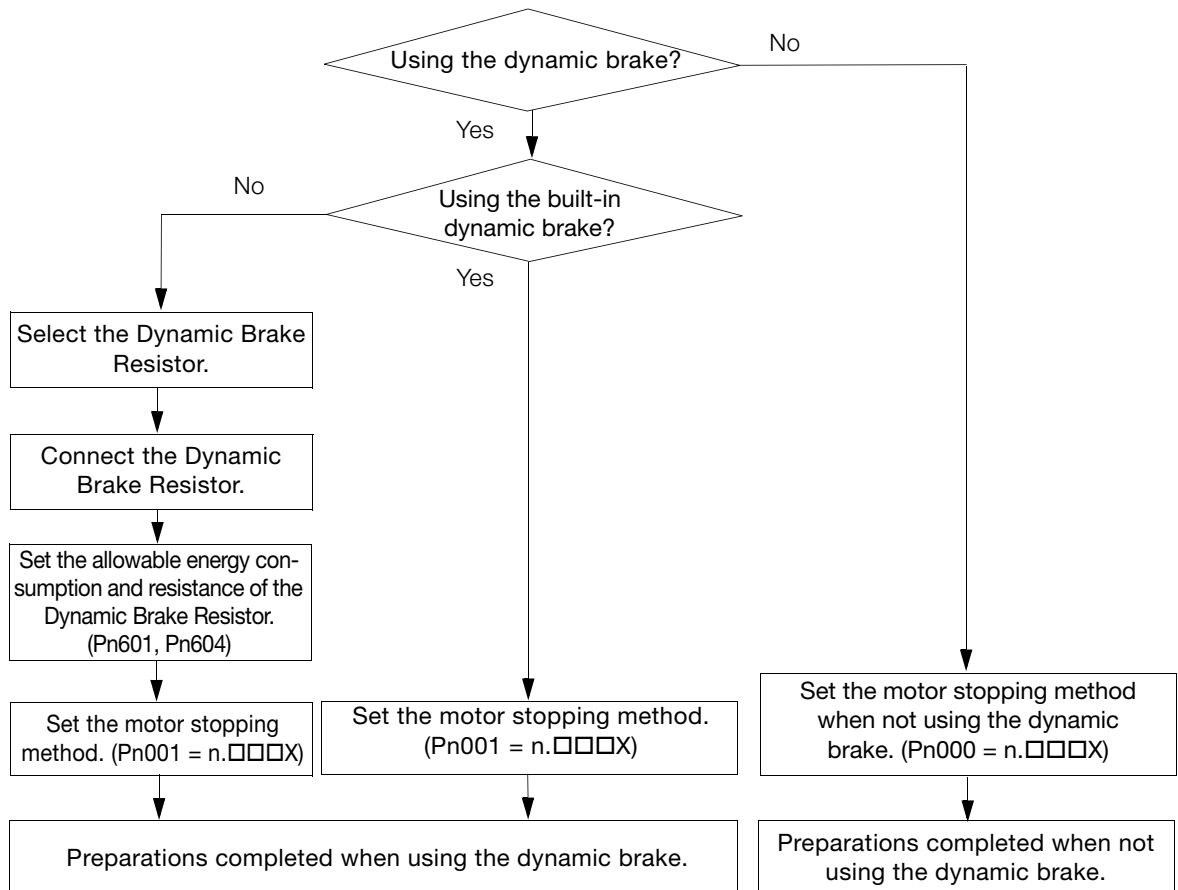

Setting When Not Using Dynamic Braking



When not using dynamic braking, set Pn001 = n.□□□X (Motor Stopping Method for Servo OFF and Group 1 Alarms) to 2.

Parameter	Meaning	When Enabled	Classification
Pn001 (2001h)	n.□□□0 (default setting)	After restart	Setup
	n.□□□1		
	n.□□□2		

Setting When Using Dynamic Braking

When using dynamic braking, set Pn001 = n.□□□X (Motor Stopping Method for Servo OFF and Group 1 Alarms) to 0 or 1.

You must complete the following items to use the dynamic brake.

- Selecting the Dynamic Brake Resistor
 5.2.2 *Selecting the Dynamic Brake Resistor* on page 5-4
- Connecting the Dynamic Brake Resistor
 5.2.3 *Connecting Dynamic Brake Resistors* on page 5-7
- Parameter Settings for the Dynamic Brake
 5.2.4 *Setting the Energy Consumption and Resistance of the Dynamic Brake Resistor* on page 5-9

Note: When using the dynamic brake built into the SERVOPACK, you do not need to connect a Dynamic Brake Resistor.

5.2.2 Selecting the Dynamic Brake Resistor

This section describes the selection of the Dynamic Brake Resistor.

To select the Dynamic Brake Resistor, you must calculate the resistance and energy consumption for the specifications of the machine.

 **WARNING**

- **Do not use dynamic braking for any application other than an emergency stop.**
 There is a risk of failure due to rapid deterioration of elements in the SERVOPACK and the risk of unexpected operation, machine damage, burning, or injury.
- **Use a Dynamic Brake Resistor matched to the specifications of the machine.**
 There is a risk of unexpected operation, machine damage, burning, or injury.
- **When using dynamic braking, implement suitable safety measures on the machine.**
 There is a risk of unexpected operation, machine damage, burning, or injury.
- **In situation where the motor will be rotated from the machine after it has been stopped, set the SERVOPACK to coast to stop instead of using dynamic braking.**
 There is a risk of burning in the equipment, damage to the machine, or injury.

Resistance

Based on the characteristic graphs of the Servomotor that will be used, you must determine the resistance that can satisfy the limit of instantaneous maximum brake torque.

 **CAUTION**

- **Do not select a resistor with resistance less than the minimum allowable resistance.**
 There is a risk of burning in the SERVOPACK or Servomotor, damage to the machine, or injury.

If it is not necessary to reduce the brake torque, select a Dynamic Brake Resistor with the following resistance.

Model		Minimum Allowable Resistance (±5%)
SGD7S	-1R9D, -3R5D	30 Ω
	-5R4D	20 Ω
	-8R4D, -120D	7.8 Ω
	-170D	6.6 Ω

If it is necessary to reduce the brake torque, determine the resistance based on the characteristic graphs.

The following graphs show the relationship between the instantaneous maximum brake torque of the Servomotor and the resistance of the dynamic brake.

◆ Rotary Servomotors

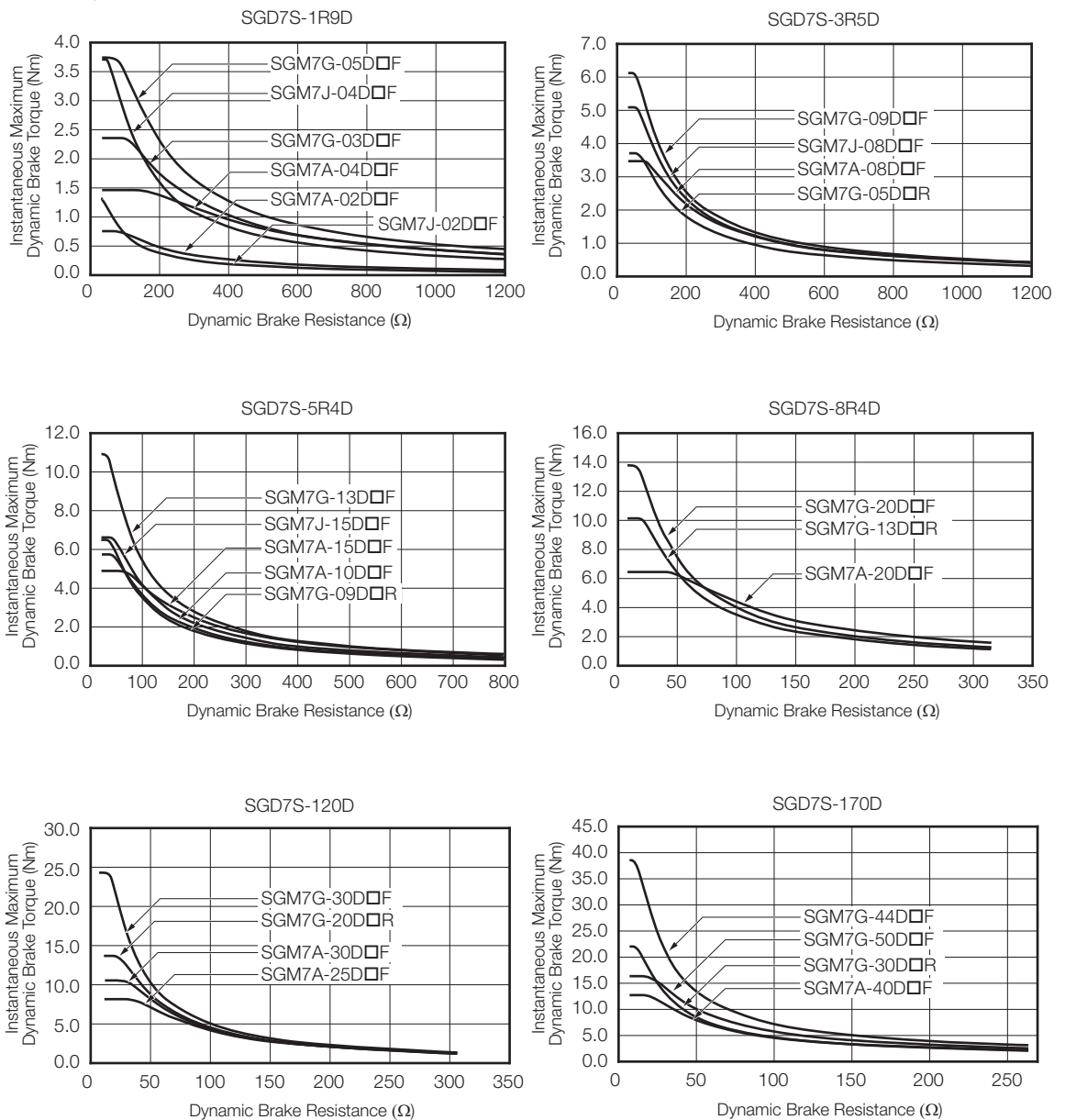

◆ Linear Servomotors

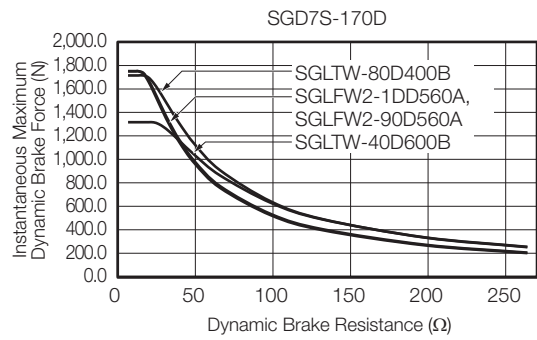
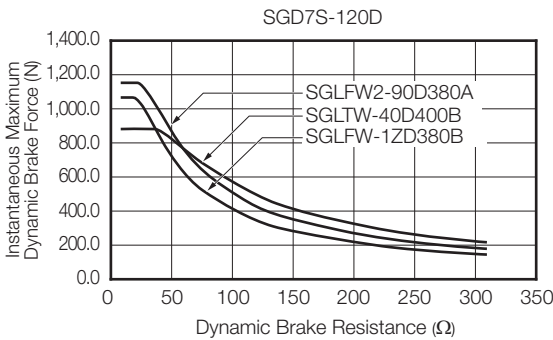
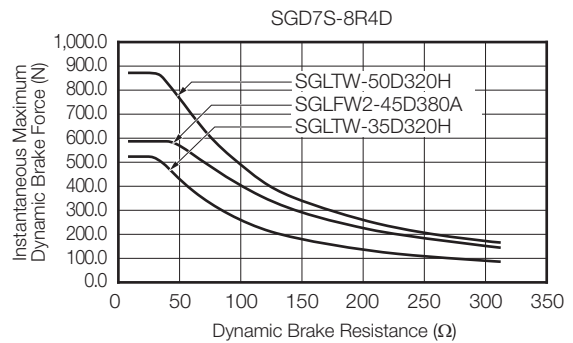
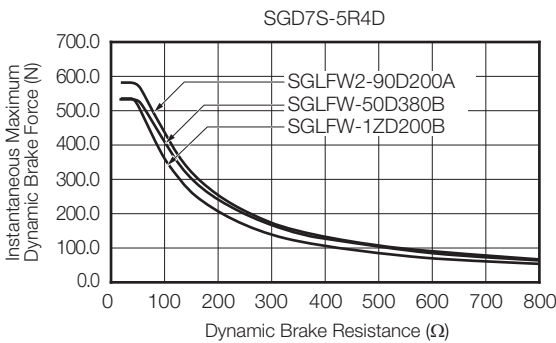
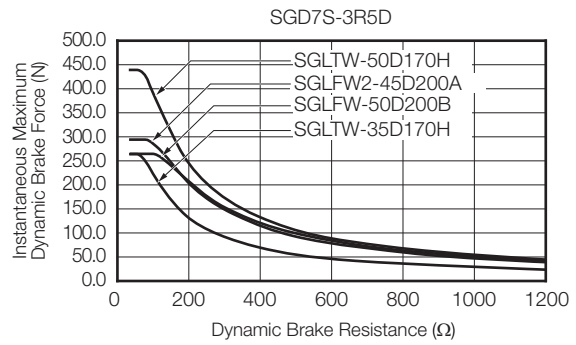
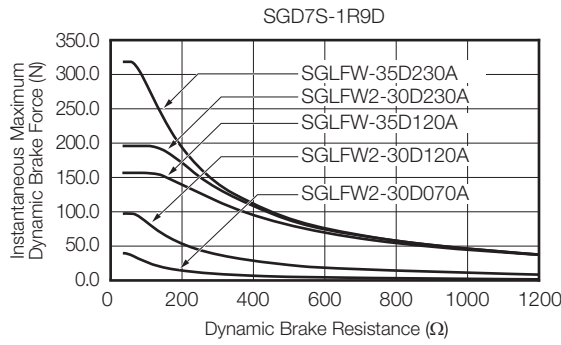

◆ Energy Consumption of the Dynamic Brake Resistor

Calculate the energy consumption required to stop the Servomotor using the Dynamic Brake Resistor.

To simplify the calculation of energy consumption, assume that all kinetic energy until the Servomotor stops is consumed by the Dynamic Brake Resistor and calculate energy consumption with the following formula.

Calculate energy consumption at the maximum value of kinetic energy of the Servomotor out of all anticipated operation patterns.

■ Rotary Servomotors

Energy consumption of Dynamic Brake Resistor: E_{DB} [J]

Motor moment of inertia: J_M [kg·m²]

Load moment of inertia: J_L [kg·m²]

Motor speed before dynamic braking: N [min⁻¹]

$$E_{DB} = 1/2 \times (J_M + J_L) \times (2\pi N/60)^2$$

Note: Refer to the catalog or product manual of the Servomotor for details on the motor moment of inertia.

■ Linear Servomotors

Energy consumption of Dynamic Brake Resistor: E_{DB} [J]

Moving Coil mass: M_M [kg]

Load mass: M_L [kg]

Movement speed before dynamic braking: V [m/s]

$$E_{DB} = 1/2 \times (M_M + M_L) \times V^2$$

Note: Refer to the catalog or product manual of the Servomotor for details on the Moving Coil mass.

◆ Specifications of the Dynamic Brake Resistor

Have the following specifications ready when purchasing the Dynamic Brake Resistor. In the blank cells of the table, write down the specifications of the Dynamic Brake Resistor that you are considering for purchase, and confirm these specifications with the manufacturer of the Resistor.

Item	Specification
Resistance (Ω)	
Energy consumption of resistor from dynamic braking (J)	
Number of operations of the dynamic brake (Number of times the dynamic brake will be used in the service life of the machine (reference data))	
Wire size	AWG14 (2.0 mm ²) to AWG18 (0.9 mm ²)

5.2.3 Connecting Dynamic Brake Resistors

A connector or terminal block is used to wire a Dynamic Brake Resistor.

This section describes the connection of the Dynamic Brake Resistor to a SERVOPACK with a built-in dynamic brake (SGD7S-1R9D to 170D).

Terminal Symbols and Terminal Names

CAUTION

- Wire all connections correctly according to the following table.
There is a risk of SERVOPACK failure or fire if incorrect wiring is performed.

SERVOPACK Model	Terminal Symbols	Terminal Name	Specification
SGD7S-1R9D, -3R5D, -5R4D, -8R4D, -120D, -170D	D1, D2	Dynamic Brake Resistor terminals	These terminals are connected to an External Dynamic Brake Resistor.

Note: The SGD7S-210D to 370D are not equipped with a connection terminal for a Dynamic Brake Resistor.

Connecting a Dynamic Brake Resistor

WARNING

- Wire the Dynamic Brake Resistor correctly. Do not connect the following terminals directly to each other: D1 and D2.
There is a risk of burning in the SERVOPACK or Servomotor, damage to the machine, or injury.

⚠ CAUTION

● Mount Dynamic Brake Resistors only on nonflammable materials. Do not mount them on or near any flammable material. There is a risk of fire.

• Required Items

Required Item	Remarks
Phillips or flat-blade screwdriver	Commercially available screwdriver with a tip thickness of 0.6 mm and tip width of 3.5 mm

1. Prepare the connector that is provided with the SERVOPACK.
2. Remove the lead wire from between D2 and D3.

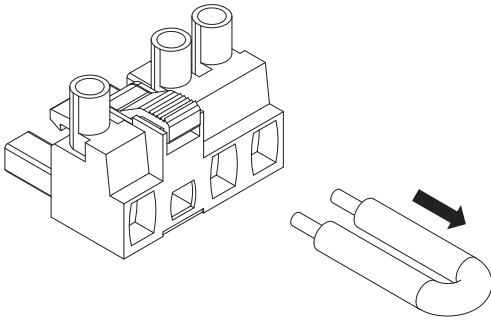

3. Remove the sheath from the wire to connect.

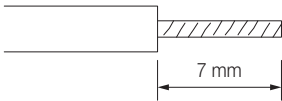

4. Open the wire insertion hole on the terminal connector with the screwdriver.
5. Insert the conductor of the wire into the wire insertion hole. After you insert the conductor, remove the screwdriver.

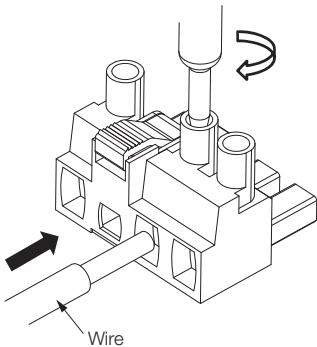

6. Connect the Dynamic Brake Resistor to the D1 and D2 terminals on the SERVOPACK.

Note: 1. The D1 and D2 are in the locations shown in the following figure. Do not connect anything to the D3 terminal.
 2. Terminal labels (D1 and D2) are provided on the Dynamic Brake Resistor connector.

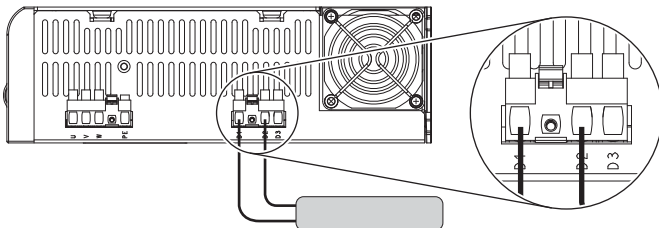

7. Set Pn601 (Dynamic Brake Resistor Allowable Energy Consumption) and Pn604 (Dynamic Brake Resistance).

Refer to the following section for details on the settings.

 5.2.4 *Setting the Energy Consumption and Resistance of the Dynamic Brake Resistor* on page 5-9

5.2.4 Setting the Energy Consumption and Resistance of the Dynamic Brake Resistor

If an External Dynamic Brake Resistor is connected, you must set Pn601 (Dynamic Brake Resistor Allowable Energy Consumption) and Pn604 (Dynamic Brake Resistance).

WARNING

- If you connect an External Dynamic Brake Resistor, set Pn601 and Pn604 to suitable values. Failure to set these parameters will cause an A.730 alarm (Dynamic Brake Overload) to be detected incorrectly and can destroy the External Dynamic Brake Resistor, cause unintended operation during an emergency stop, cause damage to the machine, and cause burning or injury.
- When you select an External Dynamic Brake Resistor, make sure that it has a suitable energy consumption and resistance. There is a risk of personal injury or fire.

CAUTION

- Mount Dynamic Brake Resistors only on nonflammable materials. Do not mount them on or near any flammable material. There is a risk of fire.

Pn601* ¹ (2601h)	Dynamic Brake Resistor Allowable Energy Consumption			[Speed]	[Position]	[Torque]
	Setting Range	Setting Unit	Default Setting	When Enabled	Classification	
	0 to 65,535	10 J	0	After restart	Setup	
Pn604* ² (2604h)	Dynamic Brake Resistance			[Speed]	[Position]	[Torque]
	Setting Range	Setting Unit	Default Setting	When Enabled	Classification	
	0 to 65,535	10 mΩ	0	After restart	Setup	

*1. SGD7S-210D to 370D SERVOPACKs require three Dynamic Brake Resistors. For this parameter setting, enter the total value of resistor capacity of the three resistors.

*2. SGD7S-210D to 370D SERVOPACKs require three Dynamic Brake Resistors. For this parameter setting, enter the resistance of one Dynamic Brake Resistor multiplied by $\sqrt{3}$.

Set Pn601 to the capacity of the Dynamic Brake Resistor that you calculated when selecting the connected External Dynamic Brake Resistor or the capacity of the Resistor as reported by the manufacturer.

Refer to the following section for details on the energy consumption of the Dynamic Brake Resistor.

  *Energy Consumption of the Dynamic Brake Resistor* on page 5-6

5.3 SERVOPACK Models without a Built-In Dynamic Brake

This section describes how to use the SERVOPACKs (SGD7S-210D to 370D) that are not equipped with a built-in dynamic brake.

5.3.1 Using the Dynamic Brake

The SGD7S-210D to 370D are not equipped with a built-in dynamic brake. When using the SGD7S-210D to 370D, set up the SERVOPACK according to the following flowchart.

With the SGD7S-210D to 370D, A.042 (Parameter Combination Error) will always occur when the power supply is first turned ON. This alarm occurs because the settings for the dynamic brake have not been configured. After you set the parameters according to the following flowchart, the A.042 alarm will be reset when the power supply is turned OFF and ON again.

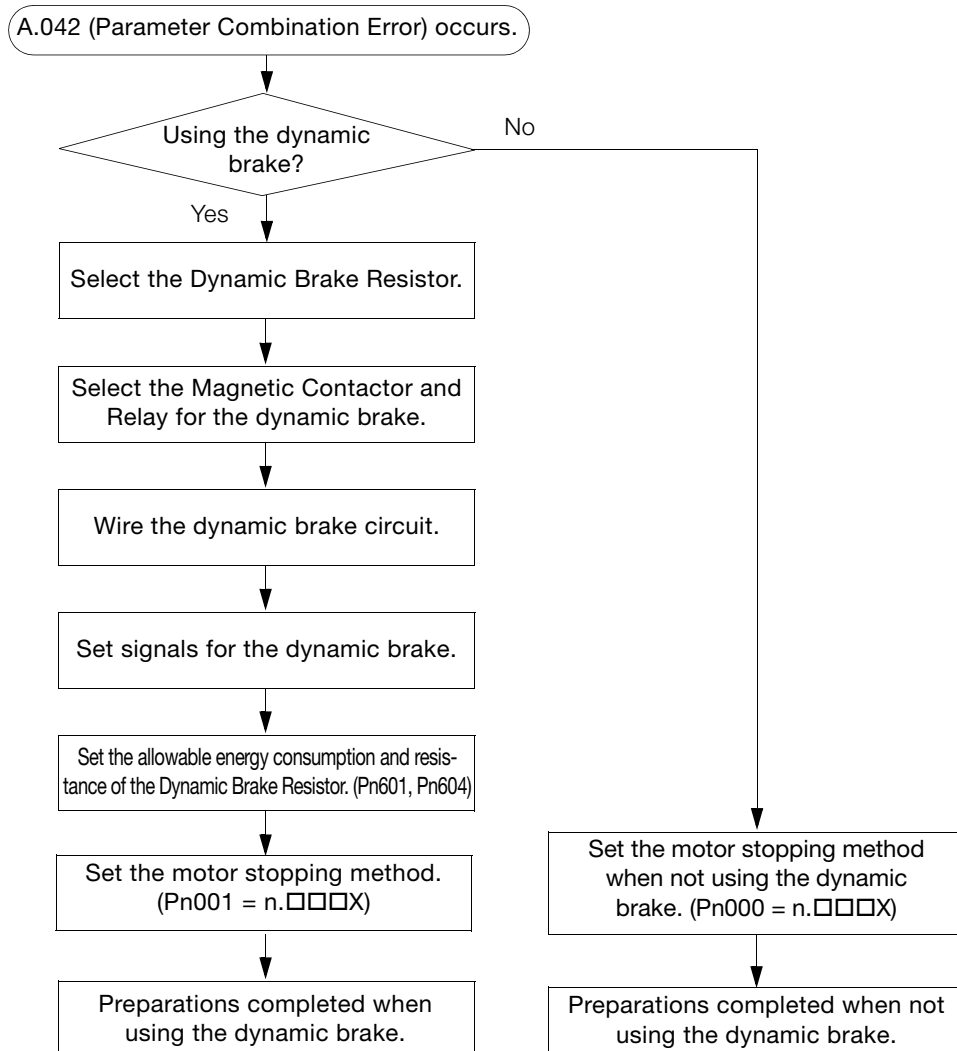

Setting When Not Using Dynamic Braking

When not using dynamic braking, set Pn001 = n.□□□X (Motor Stopping Method for Servo OFF and Group 1 Alarms) to 2.

The A.042 (Parameter Combination Error) alarm will be reset when you set Pn001 = n.□□□2 (Coast to a stop) and turn the power supply OFF and ON again.



	Parameter	Meaning	When Enabled	Classification
Pn001 (2001h)	n.□□□0 (default setting)	Stop the motor by applying the dynamic brake.	After restart	Setup
	n.□□□1	Stop the motor by the applying dynamic brake and then release the dynamic brake.		
	n.□□□2	Coast the motor to a stop without the dynamic brake.		

Setting When Using Dynamic Braking

When using dynamic braking, set Pn001 = n.□□□X (Motor Stopping Method for Servo OFF and Group 1 Alarms) to 0 or 1.

You must also create the dynamic brake circuit in order to perform dynamic braking. The A.042 (Parameter Combination Error) alarm will be reset when you turn the power supply OFF and ON again after the parameters for the dynamic brake circuit and stopping the Servomotor have been set.

You must complete the following items to use the dynamic brake.

- Selecting the Dynamic Brake Resistor
 5.3.2 *Selecting the Devices Required for the Dynamic Brake Circuit* on page 5-12
- Creating the Dynamic Brake Circuit
 5.3.3 *Wiring the Dynamic Brake Circuit* on page 5-15
- Parameter Settings for the Dynamic Brake
 5.3.4 *Parameter Settings for the Dynamic Brake Circuit* on page 5-16

5.3.2 Selecting the Devices Required for the Dynamic Brake Circuit

You must select the resistor, Magnetic Contactor, and relay to create the dynamic brake circuit.

Selecting the Dynamic Brake Resistor

To select the Dynamic Brake Resistor, you must calculate the resistance and energy consumption for the specifications of the machine.

WARNING

- Do not use dynamic braking for any application other than an emergency stop.
There is a risk of failure due to rapid deterioration of elements in the SERVOPACK and the risk of unexpected operation, machine damage, burning, or injury.
- Use a Dynamic Brake Resistor matched to the specifications of the machine.
There is a risk of unexpected operation, machine damage, burning, or injury.
- When using dynamic braking, implement suitable safety measures on the machine.
There is a risk of unexpected operation, machine damage, burning, or injury.
- In situation where the motor will be rotated from the machine after it has been stopped, set the SERVOPACK to coast to stop instead of using dynamic braking.
There is a risk of burning in the equipment, damage to the machine, or injury.

◆ Resistance

Based on the characteristic graphs of the Servomotor that will be used, you must determine the resistance that can satisfy the limit of instantaneous maximum brake torque.

CAUTION

- Do not select a resistor with resistance less than the minimum allowable resistance.
There is a risk of burning in the SERVOPACK or Servomotor, damage to the machine, or injury.

If it is not necessary to reduce the brake torque, select a Dynamic Brake Resistor with the following resistance. SGD7S-210D to 370D SERVOPACKs differ from SGD7S-1R9D to 170D in that three Dynamic Brake Resistors are required. Use resistors with the same resistance and capacity for the three Dynamic Brake Resistors. The following table gives the resistance per resistor.

	Model	Minimum Allowable Resistance ($\pm 5\%$)
SGD7S	-210D, -260D	1.1 Ω
	-280D, -370D	0.95 Ω

If it is necessary to reduce the brake torque, determine the resistance based on the characteristic graphs.

The following graphs show the relationship between the instantaneous maximum brake torque of the Servomotor and the resistance of the Dynamic Brake.

■ Rotary Servomotors

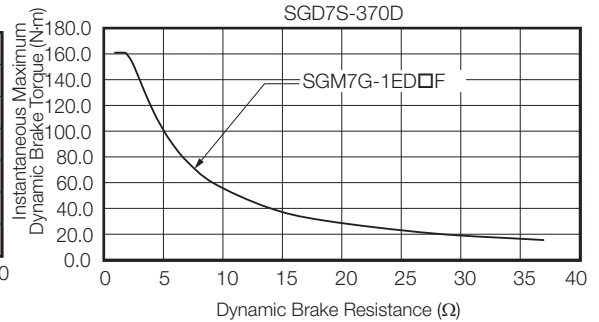
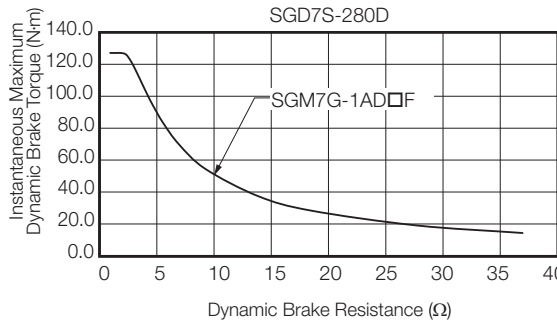
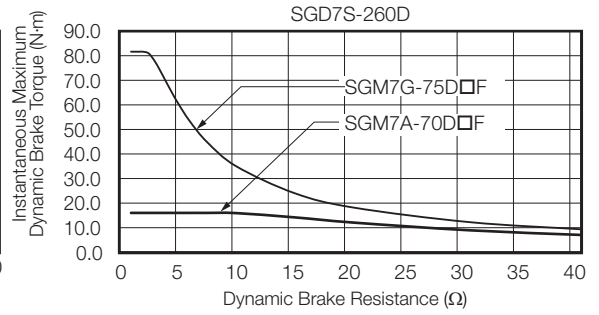
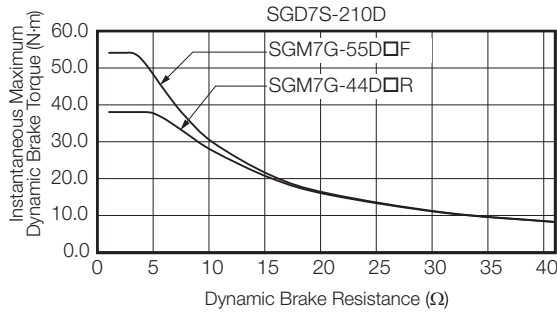

■ Linear Servomotors

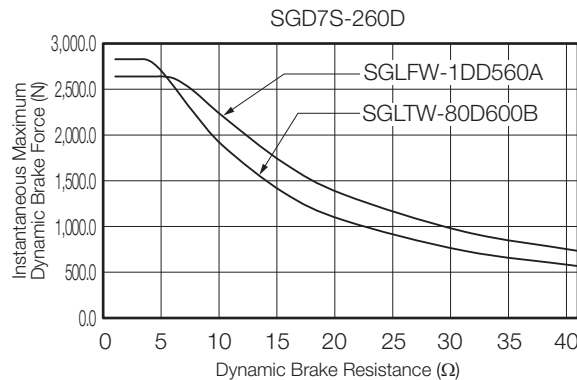

◆ Energy Consumption of the Dynamic Brake Resistor

Calculate the energy consumption required to stop the Servomotor using the Dynamic Brake Resistor.

To simplify the calculation of energy consumption, assume that all kinetic energy until the Servomotor stops is consumed by the Dynamic Brake Resistor and calculate energy consumption with the following formula.

Calculate energy consumption at the maximum value of kinetic energy of the Servomotor out of all anticipated operation patterns.

■ Rotary Servomotors

Energy consumption of Dynamic Brake Resistor: E_{DB} [J]

Motor moment of inertia: J_M [kg·m²]

Load moment of inertia: J_L [kg·m²]

Motor speed before dynamic braking: N [min⁻¹]

$$E_{DB} = 1/2 \times (J_M + J_L) \times (2\pi N/60)^2$$

Note: Refer to the catalog or product manual of the Servomotor for details on the motor moment of inertia.

■ Linear Servomotors

Energy consumption of Dynamic Brake Resistor: E_{DB} [J]

Moving Coil mass: M_M [kg]

Load mass: M_L [kg]

Movement speed before dynamic braking: V [m/s]

$$E_{DB} = 1/2 \times (M_M + M_L) \times V^2$$

Note: Refer to the catalog or product manual of the Servomotor for details on Moving Coil mass.

◆ Specifications of the Dynamic Brake Resistor

Have the following specifications ready when purchasing the Dynamic Brake Resistor. In the blank cells of the table, write down the specifications of the Dynamic Brake Resistor that you are considering for purchase, and confirm these specifications with the manufacturer of the Resistor.

Item	Specification
Resistance (Ω)	
Energy consumption of resistor from dynamic braking (J)*	
Number of operations of the dynamic brake (Number of times the dynamic brake will be used in the service life of the machine (reference data))	
Wire size	AWG14 (2.0 mm ²) to AWG18 (0.9 mm ²)

* SGD7S-210D to 370D SERVOPACKs require three Dynamic Brake Resistors. Therefore, the energy consumption required for one resistor will be one-third of the electrical energy that was calculated from the kinetic energy of the Servomotor.

Selecting the Magnetic Contactor and Relay

The following table gives the Magnetic Contactor and relay that must be used to create the dynamic brake circuit.

SERVOPACK Model SGD7S-	Part	Manufacturer	Manufacturer Model No.
210D, 260D, 280D, and 370D	Magnetic Contactor	Mitsubishi Electric Corporation	BD-N65 (24 VDC)
	Relay	OMRON Corporation	G6B-4BND
		Panasonic Corporation	ERZV09D390
	Surge Absorber	Okaya Electric Industries Co., Ltd.	XEB01010

5.3.3 Wiring the Dynamic Brake Circuit

This section shows how to wire the dynamic brake based on a wiring example that uses the recommended parts from the following section.

 *Selecting the Magnetic Contactor and Relay on page 5-14*

The /DBON (Dynamic Brake Operation Request Output) and /DBANS (Dynamic Brake Answer Input) signals must be allocated to sequence I/O signal terminals.

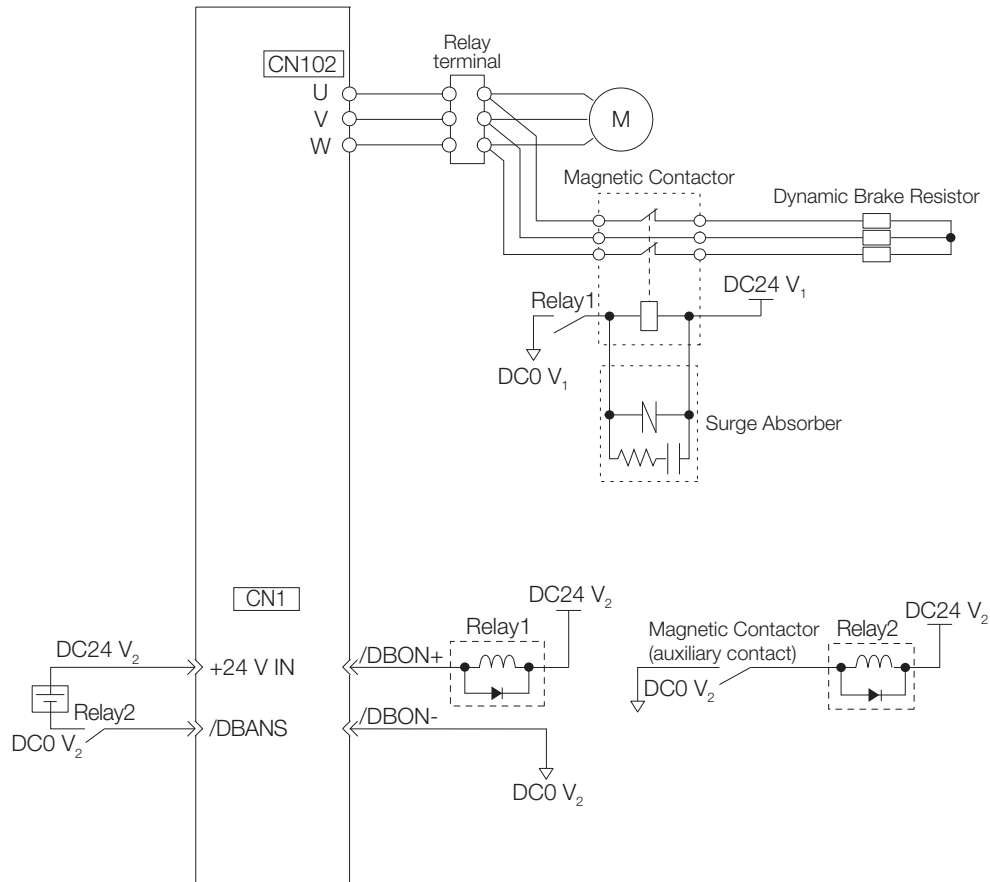

Note: 1. Separate the 24-VDC power supply for the Magnetic Contactor from the power supply for the I/O signals (CN1). If the same power supply is used, the I/O signals may malfunction.

2. The recommended relay (G6B-4BND) is a terminal relay equipped with four mini-relays. A single relay can be used for Relay1 and Relay2 in the above diagram.

5.3.4 Parameter Settings for the Dynamic Brake Circuit

You must set the following parameters to create the dynamic brake circuit.

Item to Set	Parameter	Reference
Allocation of /DBON (Dynamic Brake Operation Request Output) signal	Pn51A = n.□□X□	page 5-16
Allocation of /DBANS (Dynamic Brake Answer Input) signal	Pn515 = n.□X□□	page 5-16
Selection of motor stopping method	Pn001	page 5-2
Energy consumption of the Dynamic Brake Resistor	Pn601	page 5-9
Resistance of Dynamic Brake Resistor	Pn604	

/DBON (Dynamic Brake Operation Request Output) Signal

The /DBON signal is the trigger signal for executing dynamic braking.

Create the sequence so that the Magnetic Contactor in the dynamic brake circuit is excited when the /DBON signal is turned ON.



Important

1. If you allocate more than one signal to the same output connector pin, a logical OR of the signals is output. Set the /DBON signal so that it is not allocated to the same terminal as another output signal.
2. If the /DBON signal is allocated to the same terminal as another output signal, the A.F32 (Dynamic Brake Operation Request Output Signal Setting Error) alarm will occur to prevent unexpected operation. The A.F32 alarm will also occur when an output signal is allocated with the following objects to the same terminal as the /DBON signal.
 - Digital outputs (60FEh)
 - Objects related to ZONE outputs (2752h, 2753h)
 - Objects related to output signals (250Eh to 2510h, 2514h)

The /DBON signal is required to execute dynamic braking on SGD7S-210D to 370D SERVOPACKs. On SERVOPACKs other than SGD7S-210D to 370D, the /DBON signal cannot be allocated.

Type	Signal	Connector Pin No.	Signal Status	Meaning
Output	/DBON	Must be allocated.	ON (closed)	Do not execute dynamic braking.
			OFF (open)	Execute dynamic braking.

Note: Use Pn51A = n.□□X□ (/DBON (Dynamic Brake Operation Request Output) Signal Allocation) to allocate the /DBON signal to a connector pin. Refer to the following section for details.

 7.1.2 Output Signal Allocations on page 7-5

/DBANS (Dynamic Brake Answer Input) Signal

The /DBANS signal is used to check the operating status of the Magnetic Contactor in the dynamic brake circuit.

Type	Signal	Connector Pin No.	Signal Status	Meaning
Input	/DBANS	Must be allocated.	ON (closed)	Dynamic braking is not being executed.
			OFF (open)	Dynamic braking is being executed.

Note: Use Pn515 = n.□X□□ (/DBANS (Dynamic Brake Answer Input) Signal Allocation) to allocate the /DBANS signal to a connector pin. Refer to the following section for details.

 7.1.1 Input Signal Allocations on page 7-4

Always configure the parameter settings for the /DBANS and /DBON signals when using the External Dynamic Brake Resistor.

◆ Operating Time of the Dynamic Brake

The operating time of the dynamic brake is the total value of the operating times of the relay and Magnetic Contactor.

The operating times of the selected parts are given in the following table.

■ Operating Times of Selected Parts

Part	Model	Manufacturer	Operating Time*	Symbol
Relay (DBRy1)	G6B-4BND	OMRON Corporation	Operating time: 10 ms or less (actual value: approx. 3 ms)	T_{R11}
			Operating time: 15 ms or less (actual value: approx. 4 ms)	T_{R12}
Operating time: 10 ms or less (actual value: approx. 3 ms)			T_{R21}	
Operating time: 15 ms or less (actual value: approx. 4 ms)			T_{R22}	
Relay (DBRy2)				
Magnetic Contactor (DBKM)	BD-N65 (24 VDC)	Mitsubishi Electric Corporation	Time from coil ON to main contact (normally closed) OFF: 68 ms to 92 ms	T_{C1}
			Time from coil OFF to main contact (normally closed) ON: 13 ms to 29 ms	T_{C2}

* The operating time values are those listed in the manufacturers' catalogs. Refer to the materials from the manufacturers for details on the operating conditions.

■ Dynamic Brake Operating Time

Symbol	Description	Operating Time
T_{D1}	Time from when the /DBON signal is turned ON to when the Magnetic Contactor operates.	$T_{D1} = T_{R11} + T_{C2}$
T_{D2}	Time from when the /DBON signal is turned OFF to when the Magnetic Contactor opens.	$T_{D2} = T_{R12} + T_{C1}$
T_{D3}	Time from when the /DBON signal is turned ON to when the /DBANS signal turns ON.	$T_{D3} = T_{D1} + T_{R21}$
T_{D4}	Time from when the /DBON signal is turned OFF to when the /DBANS signal turns OFF.	$T_{D4} = T_{D2} + T_{R22}$

■ Timing Chart

The SERVOPACK monitors the status of the /DBON and /DBANS signals. The A.F30 (Dynamic Brake Circuit Error) alarm will occur if a disagreement in the status of the /DBON and /DBANS signals occurs for 0.14 s or longer.

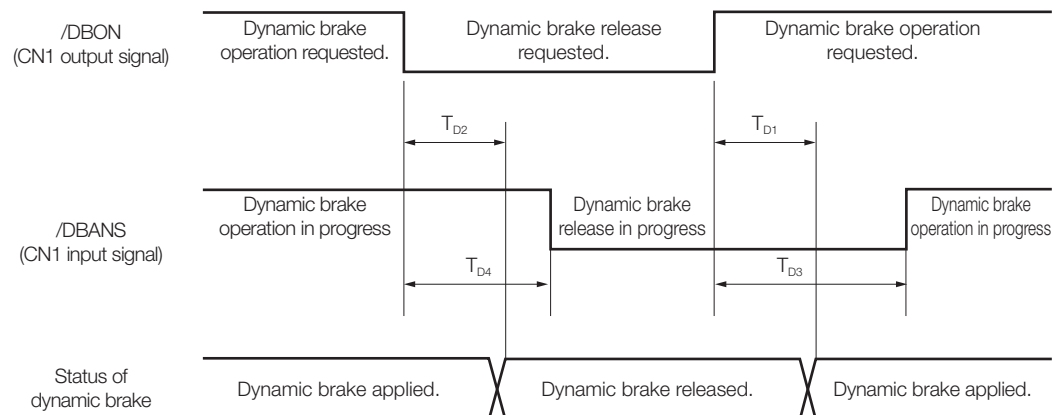

5.4 Coasting Distances for Dynamic Braking

During dynamic braking, the motor rotates due to inertia until the electrical energy is consumed. The travel distance at this time is called the coasting distance.

This section provides a method for calculating the coasting distance.

5.4.1 Coasting Distance during Dynamic Braking

CAUTION

- There will be a margin of error between the value calculated for the coasting distance and the actual distance. Therefore, evaluate the operation of the dynamic brake with the actual equipment or machine and confirm that the coasting distance is acceptable. There is a risk of machine damage or injury.

The coasting distance must be checked with the actual equipment, but it can be approximated with the following formulas.

Rotary Servomotors

The coasting distance can be calculated with the following formula.

$$\theta = J\{\alpha(R_D + Z_m)Nm_0 + (\beta \times N^3m_0) / (R_D + Z_m)\} + (Nm_0/60) \times T_{D1} \times 360 \text{ [deg]}$$



Calculate the coasting distance using the above formula based on the following conditions.

- θ [deg]: Coasting distance (mechanical angle)
- J [kgm²]: Moment of inertia (motor moment of inertia + load moment of inertia)
- R_D [Ω]: Resistance of Dynamic Brake Resistor
- Nm_0 [min⁻¹]: Motor speed before starting dynamic braking
- α, β : Coasting distance coefficients*¹
- Z_m : Characteristic impedance*¹
- T_{D1} [s]: Dynamic brake operating time*²

*1. Refer to the following section for details on the coasting distance coefficients and characteristic impedance.

 5.4.2 Data for Calculating Coasting Distance on page 5-19

*2. Refer to the following section for details on the dynamic brake operating time.

  Operating Time of the Dynamic Brake on page 5-17

Linear Servomotors

The coasting distance can be calculated with the following formula.

$$L_m = M\{\alpha(R_D + Z_m)Vm_0 + (\beta \times V^3m_0) / (R_D + Z_m)\} + Vm_0 \times T_{D1} \text{ [m]}$$



Calculate the coasting distance using the above formula based on the following conditions.

- L_m [m]: Coasting distance
- M [kg]: Conveyed mass (Moving Coil mass + load mass)
- R_D [Ω]: Resistance of Dynamic Brake Resistor
- Vm_0 [m/s]: Movement speed before starting dynamic braking
- α, β : Coasting distance coefficients*¹
- Z_m : Characteristic impedance*¹
- T_{D1} [s]: Dynamic brake operating time*²

*1. Refer to the following section for details on the coasting distance coefficients and characteristic impedance.

 5.4.2 Data for Calculating Coasting Distance on page 5-19

*2. Refer to the following section for details on the dynamic brake operating time.

  Operating Time of the Dynamic Brake on page 5-17

5.4.2 Data for Calculating Coasting Distance

This section provides the coasting distance coefficients and characteristic impedance required to calculate the coasting distance.

Coasting Distance Coefficients

The following tables give the relationship between the Servomotor and coasting distance coefficients α and β .

Motor Type	SERVOPACK Model	Servomotor Model	Coasting Distance Coefficients	
			α	β [$\times 10^{-6}$]
Rotary Servomotors	SGD7S-1R9D	SGM7G-03D□F	4.31	2027.37
		SGM7G-05D□F	3.56	980.46
		SGM7J-02D□F	48.85	588.19
		SGM7J-04D□F	11.15	317.05
		SGM7A-02D□F	33.65	2531.91
		SGM7A-04D□F	8.50	2710.91
	SGD7S-3R5D	SGM7G-09D□F	3.52	366.36
		SGM7J-08D□F	7.61	244.05
		SGM7A-08D□F	7.68	520.12
		SGM7G-05D□R	8.12	429.13
	SGD7S-5R4D	SGM7A-15D□F	6.85	301.37
		SGM7G-13D□F	3.27	133.17
		SGM7A-10D□F	9.05	168.32
		SGM7J-15D□F	8.07	143.11
		SGM7G-09D□R	8.24	146.05
	SGD7S-8R4D	SGM7A-20D□F	7.46	153.86
		SGM7G-20D□F	4.65	55.13
		SGM7G-13D□R	8.72	53.98
	SGD7S-120D	SGM7A-25D□F	7.87	92.05
		SGM7A-30D□F	7.68	56.19
		SGM7G-30D□F	3.61	23.52
		SGM7G-20D□R	6.51	40.29
	SGD7S-170D	SGM7A-40D□F	9.25	34.78
		SGM7A-50D□F	7.11	26.74
		SGM7G-44D□F	2.80	11.68
		SGM7G-30D□R	6.91	14.88
	SGD7S-210D	SGM7G-55D□F	3.20	5.21
		SGM7G-44D□R	4.79	7.04
SGD7S-260D	SGM7G-75D□F	2.83	2.59	
	SGM7A-70D□F	7.11	26.74	
SGD7S-280D	SGM7G-1AD□F	1.36	2.22	
SGD7S-370D	SGM7G-1ED□F	1.27	1.49	

Continued on next page.

Continued from previous page.

Motor Type	SERVOPACK Model	Servomotor Model	Coasting Distance Coefficients	
			α	β [$\times 10^{-6}$]
Linear Servomotors	SGD7-1R9D	SGLFW-35D120A	0.94	544.23
		SGLFW-35D230A	0.94	132.48
		SGLFW2-30D070A	15.62	487.67
		SGLFW2-30D120A	4.16	313.30
		SGLFW2-30D230A	1.04	313.30
	SGD7-3R5D	SGLFW-50D200B	0.95	183.90
		SGLTW-35D170H	1.75	100.60
		SGLTW-50D170H	0.74	87.00
	SGD7S-5R4D	SGLFW-50D380B	0.95	45.53
		SGLFW-1ZD200B	1.15	37.13
		SGLFW2-90D200A	0.73	49.83
	SGD7S-8R4D	SGLFW2-45D380A	0.93	38.73
		SGLTW-35D320H	1.75	25.57
		SGLTW-50D320H	0.74	22.18
	SGD7S-120D	SGLFW-1ZD380B	1.15	9.28
		SGLFW2-90D380A	0.73	12.46
		SGLTW-40D400B	0.45	34.53
	SGD7S-170D	SGLFW2-90D560A	0.73	5.52
		SGLFW2-1DD380A	0.65	6.18
		SGLTW-40D600B	0.45	15.86
SGLTW-80D400B		0.46	9.17	
SGD7S-260D	SGLTW-80A600B	0.65	2.72	
	SGLFW2-1DD560A	0.46	4.20	

Characteristic Impedance

The following graphs give the relationship between the characteristic impedance and speed of the Servomotors.

Refer to the graph of the Servomotor that will be used, and use characteristic impedance Z_m from the speed before starting dynamic braking.

◆ Rotary Servomotors

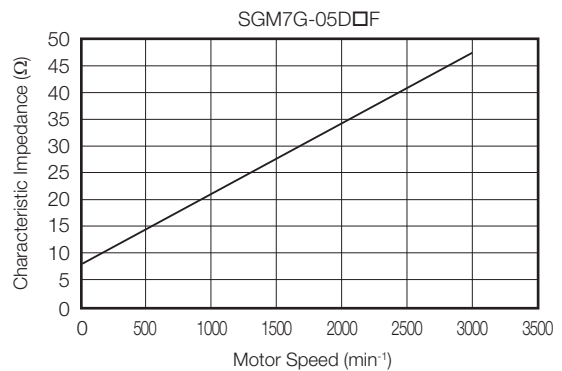
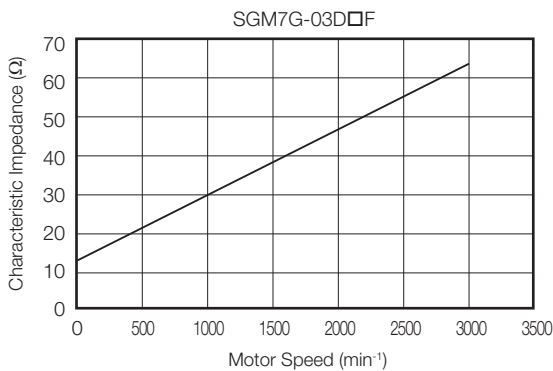

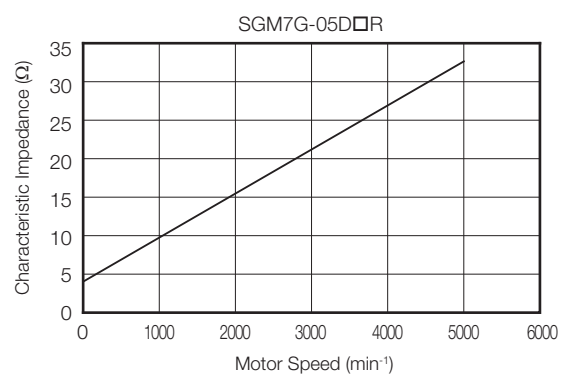
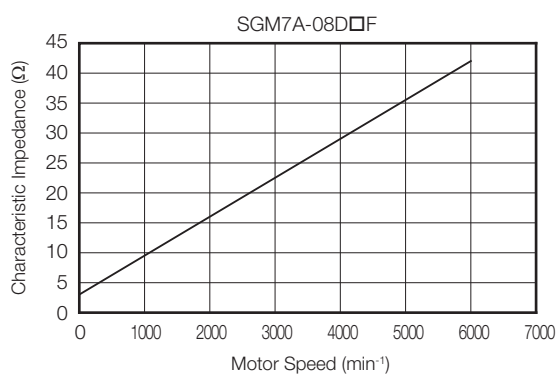
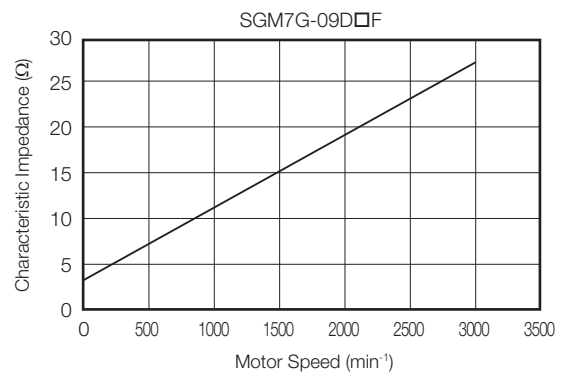
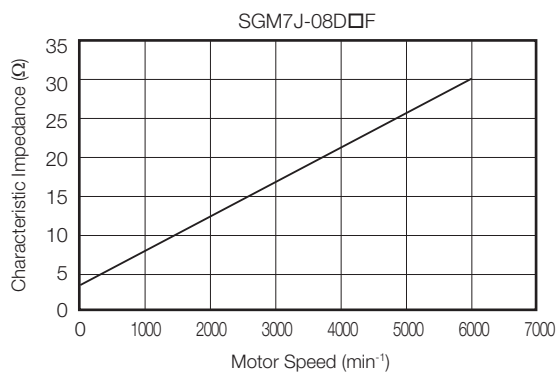
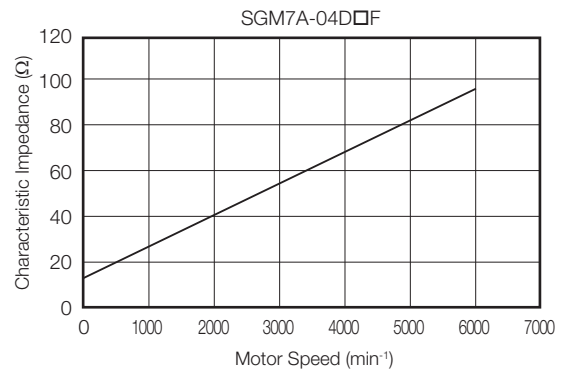
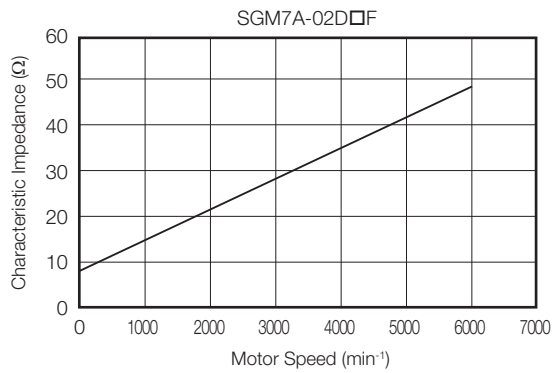
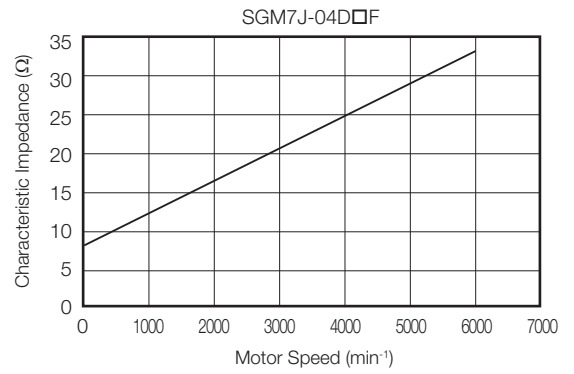
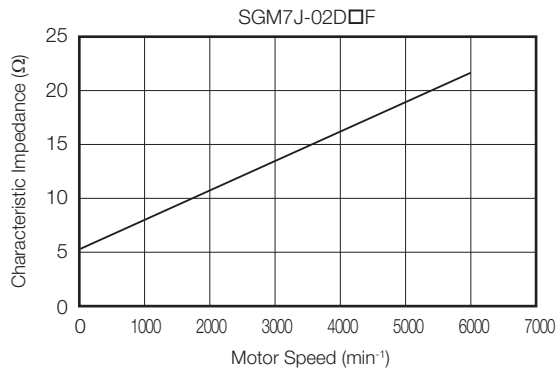

5.4 Coasting Distances for Dynamic Braking

5.4.2 Data for Calculating Coasting Distance

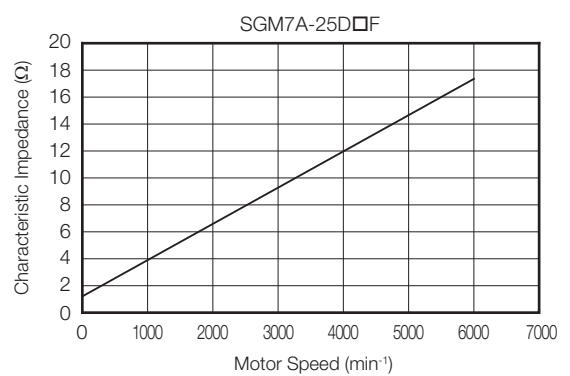
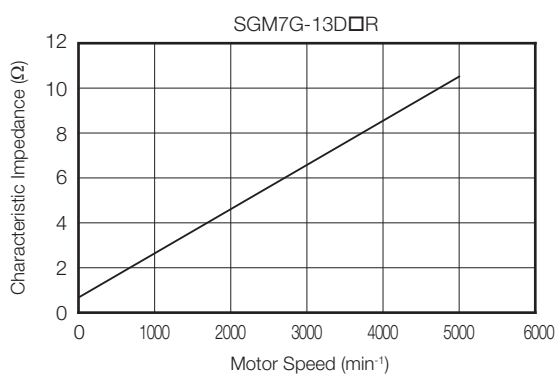
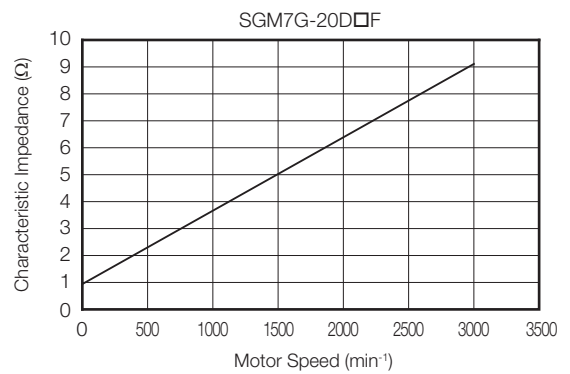
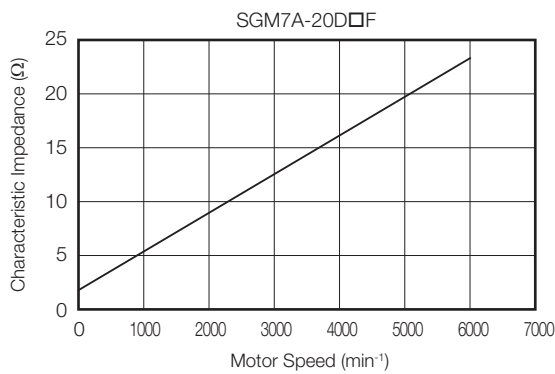
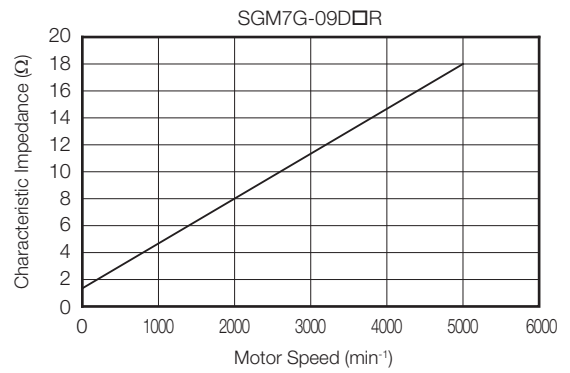
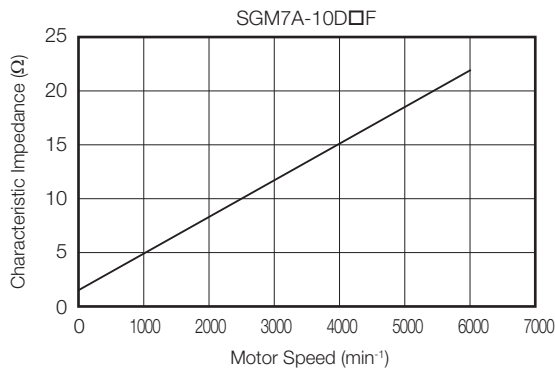
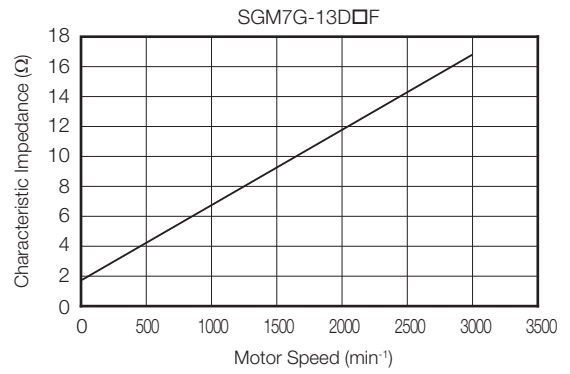
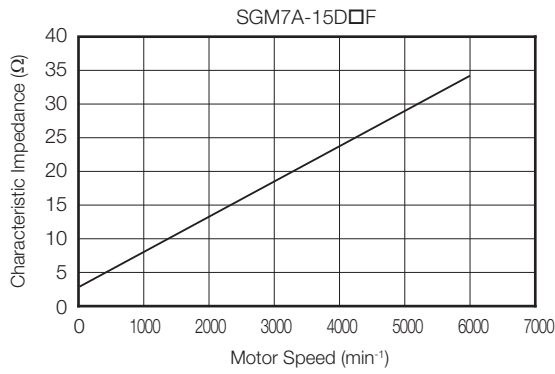

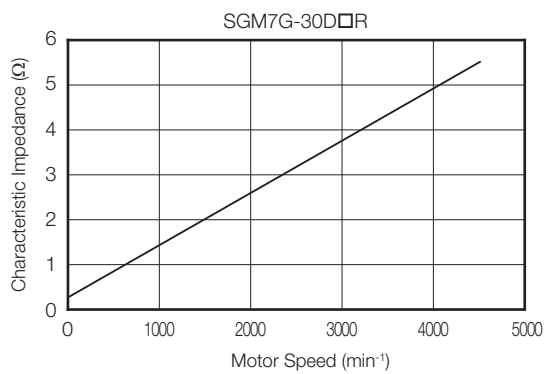
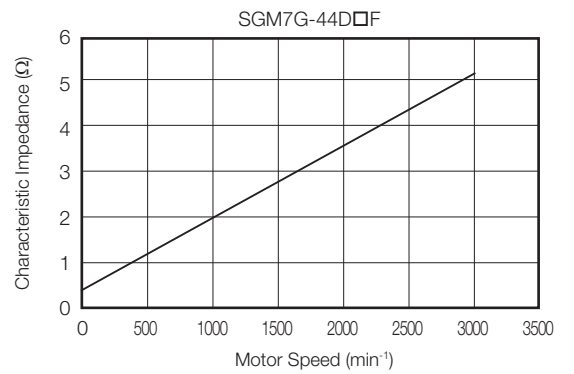
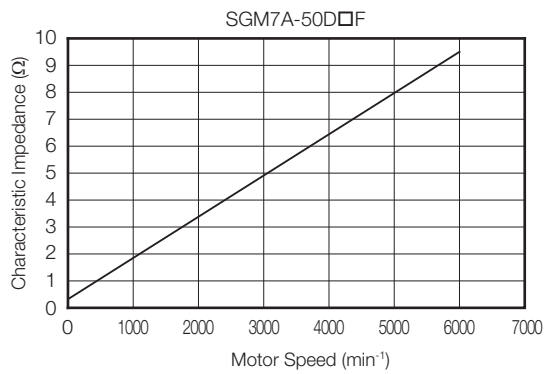
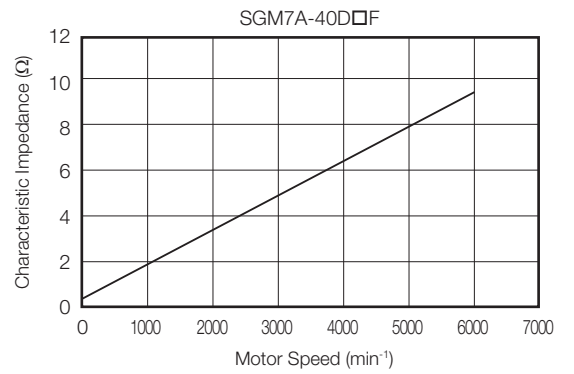
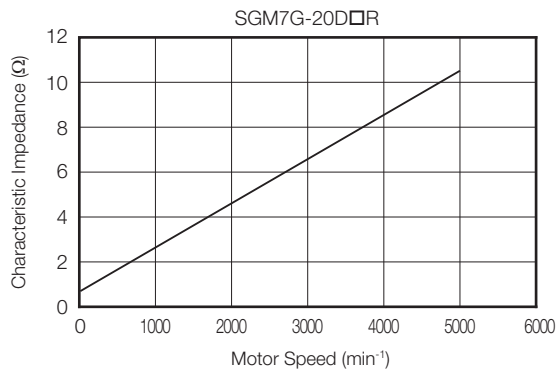
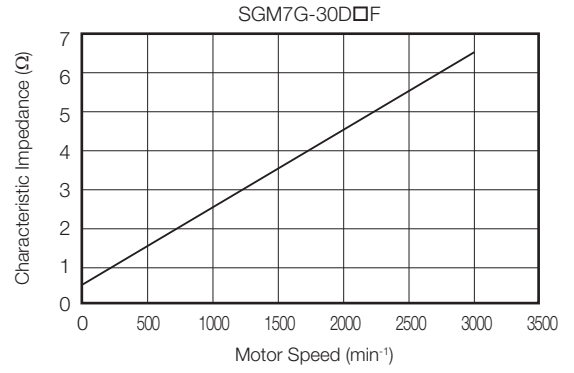
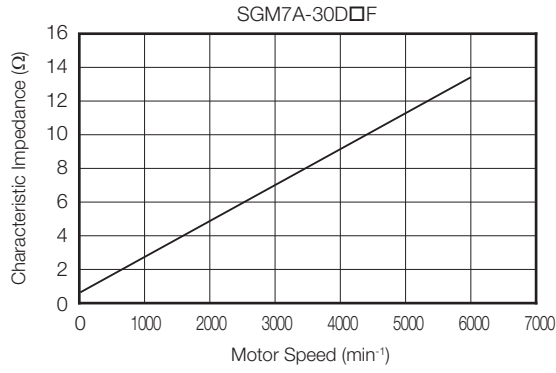

5.4 Coasting Distances for Dynamic Braking

5.4.2 Data for Calculating Coasting Distance

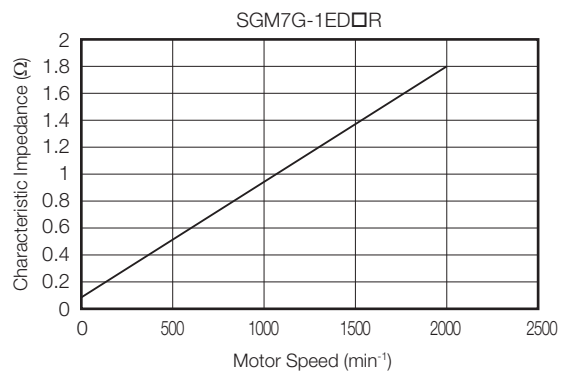
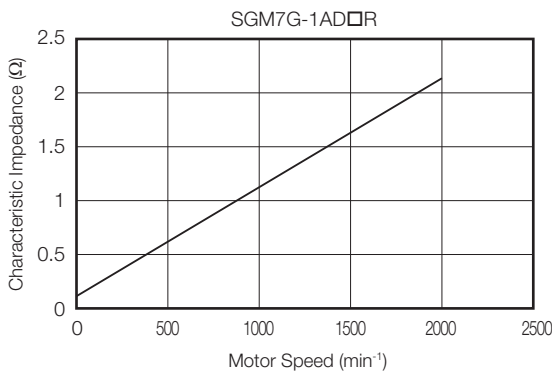
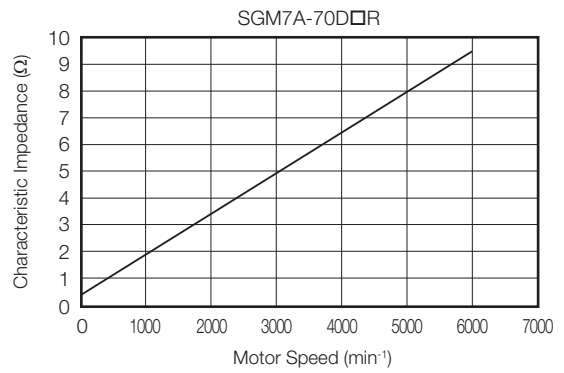
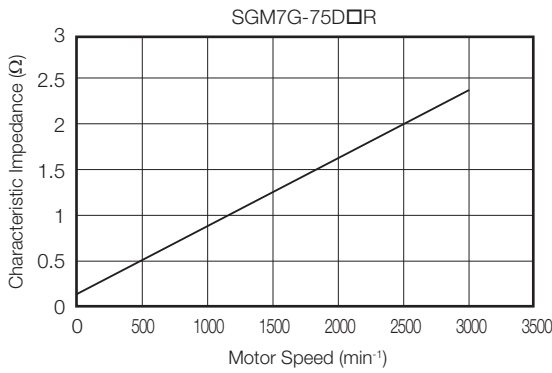
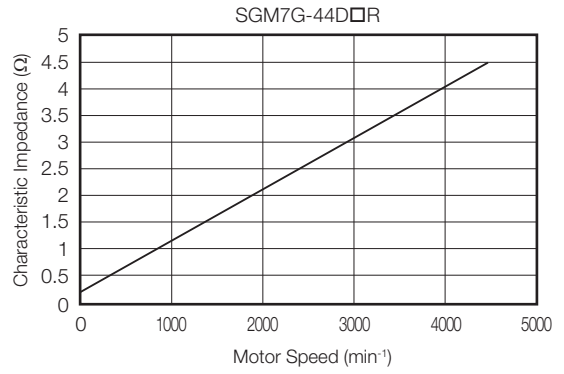
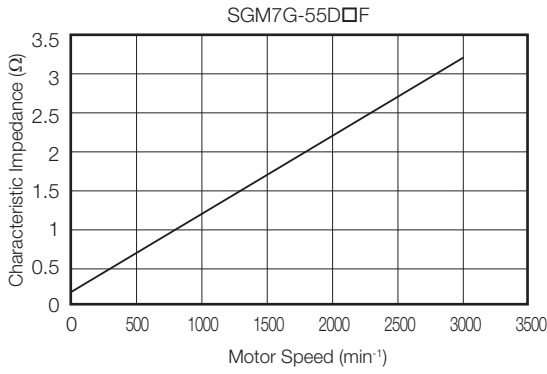

◆ Linear Servomotors

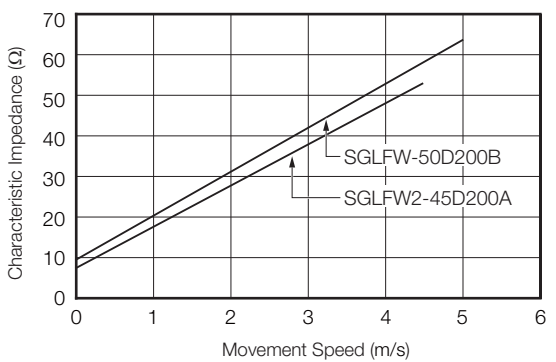
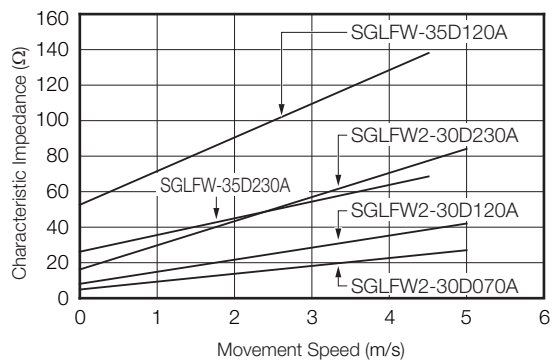

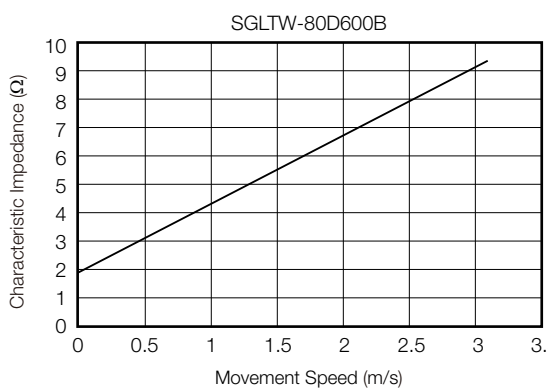
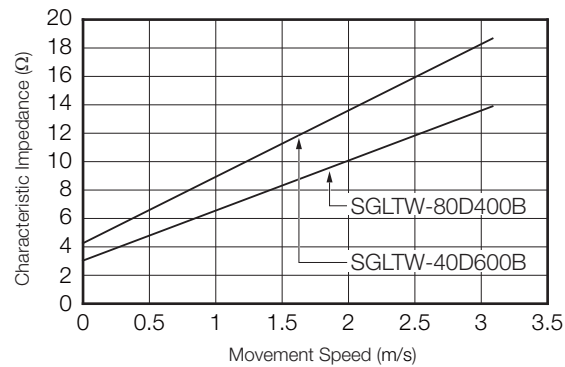
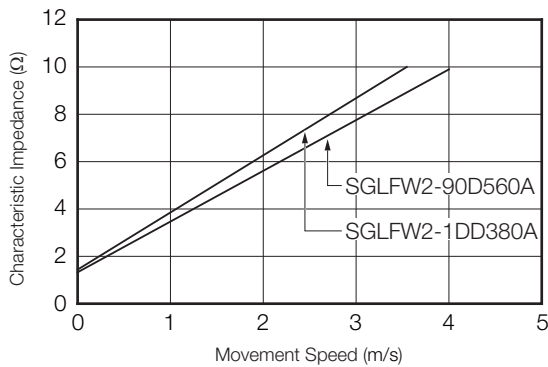
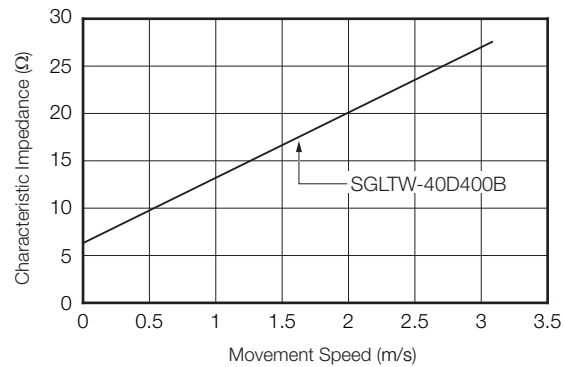
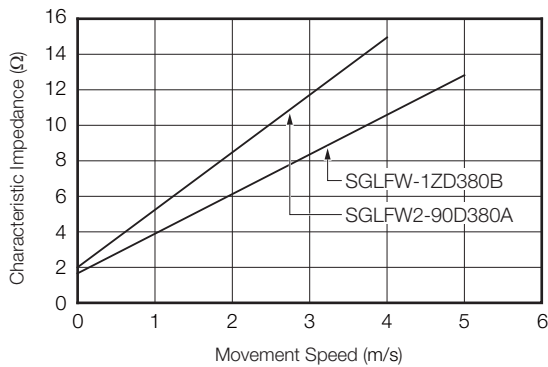
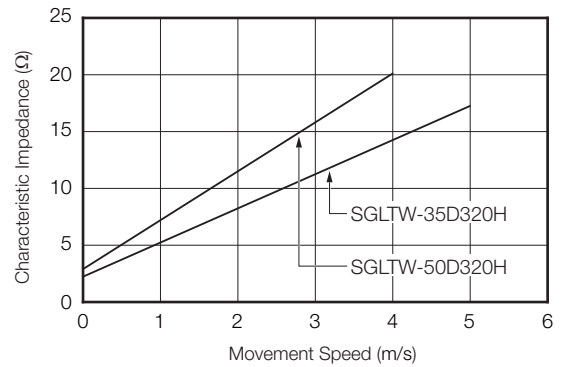
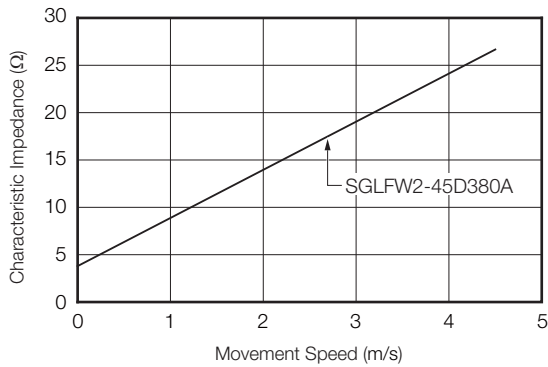
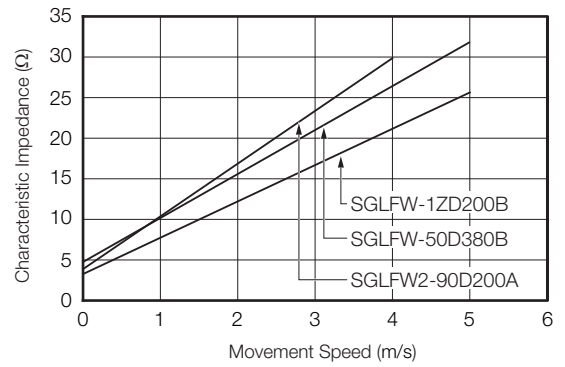
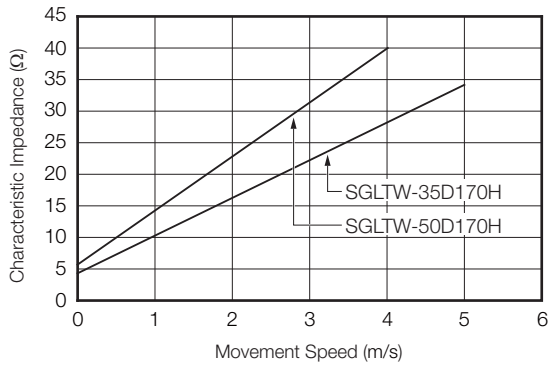

Basic Functions That Require Setting before Operation

6

This chapter describes the basic functions that must be set before you start Servo System operation. It also describes the setting methods.

6.1	Manipulating SERVOPACK Parameters (Pn□□□) . . . 6-3
6.1.1	Classifications of SERVOPACK Parameters 6-3
6.1.2	Notation for SERVOPACK Parameters 6-4
6.1.3	Setting Methods for SERVOPACK Parameters . . 6-5
6.1.4	Write Prohibition Setting for SERVOPACK Parameters 6-7
6.1.5	Initializing SERVOPACK Parameter Settings . . . 6-10
6.2	Power Supply Type Settings for the Main Circuit . .6-12
6.3	Automatic Detection of Connected Motor . . 6-13
6.4	Motor Direction Setting 6-14
6.5	Setting the Linear Encoder Pitch 6-15
6.6	Writing Linear Servomotor Parameters . . . 6-16
6.7	Selecting the Phase Sequence for a Linear Servomotor . . 6-20
6.8	Polarity Sensor Setting 6-22
6.9	Polarity Detection 6-23
6.9.1	Restrictions 6-23
6.9.2	Using the Servo ON Command (Enable Operation Command) to Perform Polarity Detection 6-24
6.9.3	Using a Tool Function to Perform Polarity Detection 6-25

6.10 Overtravel and Related Settings 6-26

- 6.10.1 Overtravel Signals 6-26
- 6.10.2 Setting to Enable/Disable Overtravel 6-27
- 6.10.3 Motor Stopping Method for Overtravel 6-27
- 6.10.4 Overtravel Warnings 6-29
- 6.10.5 Overtravel Release Method Selection 6-30
- 6.10.6 Overtravel Status 6-31
- 6.10.7 Overtravel Operation by Mode 6-31

6.11 Holding Brake 6-32

- 6.11.1 Brake Operating Sequence 6-32
- 6.11.2 /BK (Brake) Signal 6-33
- 6.11.3 Output Timing of /BK (Brake) Signal When the Servomotor Is Stopped 6-34
- 6.11.4 Output Timing of /BK (Brake) Signal When the Servomotor Is Operating 6-35
- 6.11.5 Built-in Brake Relay Usage Selection 6-36

6.12 Motor Stopping Methods for Servo OFF and Alarms . . 6-37

- 6.12.1 Stopping Method for Servo OFF 6-38
- 6.12.2 Servomotor Stopping Method for Alarms 6-38

6.13 Motor Overload Detection Level 6-40

- 6.13.1 Detection Timing for Overload Warnings (A.910) 6-40
- 6.13.2 Detection Timing for Overload Alarms (A.720) . . 6-41

6.14 Setting Unit Systems 6-42

- 6.14.1 Setting the Position Reference Unit 6-42
- 6.14.2 Setting the Speed Reference Unit 6-47
- 6.14.3 Setting the Acceleration Reference Unit 6-48
- 6.14.4 Setting the Torque Reference Unit 6-48
- 6.14.5 Setting the Encoder Resolution 6-48

6.15 Resetting the Absolute Encoder 6-49

- 6.15.1 Precautions on Resetting 6-49
- 6.15.2 Preparations 6-49
- 6.15.3 Applicable Tools 6-49
- 6.15.4 Operating Procedure 6-50

6.16 Setting the Origin of the Absolute Encoder . . 6-52

- 6.16.1 Absolute Encoder Origin Offset 6-52
- 6.16.2 Setting the Origin of the Absolute Linear Encoder 6-52

6.17 Setting the Regenerative Resistor Capacity . . . 6-55

6.1

Manipulating SERVOPACK Parameters (Pn□□□)

This section describes the classifications, notation, and setting methods for the SERVOPACK parameters given in this manual.

6.1.1 Classifications of SERVOPACK Parameters

There are the following two types of SERVOPACK parameters.

Classification	Meaning
Setup Parameters	Parameters for the basic settings that are required for operation.
Tuning Parameters	Parameters that are used to adjust servo performance.



Important

When you edit parameters with the SigmaWin+, setup parameters and tuning parameters are displayed.

When you edit parameters with a Digital Operator, only setup parameters are displayed by default. To edit tuning parameters, set Pn00B to n.□□□1 (Display all parameters).

Parameter	Meaning	When Enabled	Classification
Pn00B (200Bh)	n.□□□0 (default setting)	After restart	Setup
	n.□□□1		

The setting method for each type of parameter is described below.

Setup Parameters

You can use the Digital Operator, or SigmaWin+ to set the setup parameters individually.

Information

We recommend that you use the Setup Wizard of the SigmaWin+ to easily set the required setup parameters by setting the operating methods, machine specifications, and I/O signals according to on-screen Wizard instructions.

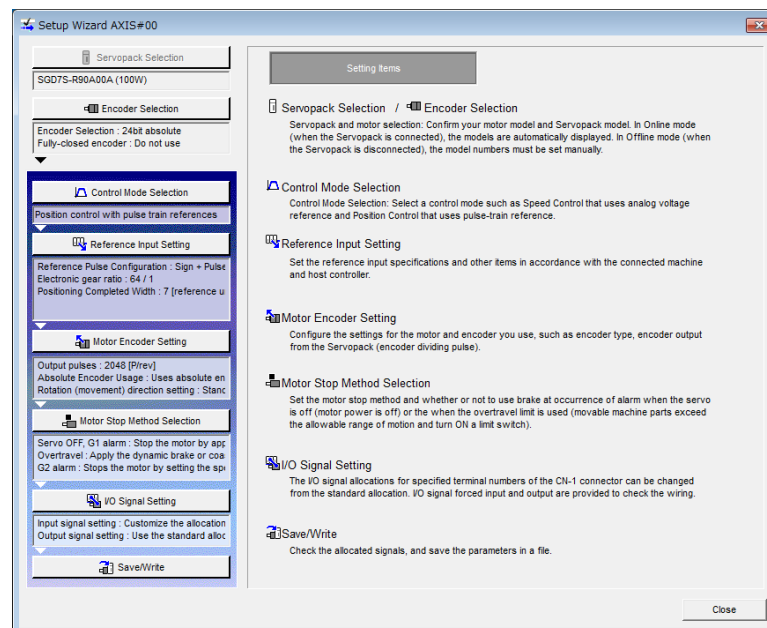

Tuning Parameters

Normally the user does not need to set the tuning parameters individually.

Use the various SigmaWin+ tuning functions to set the related tuning parameters to increase the response even further for the conditions of your machine. Refer to the following sections for details.

- 📖 9.6 Autotuning without Host Reference on page 9-23
- 📖 9.7 Autotuning with a Host Reference on page 9-34
- 📖 9.8 Custom Tuning on page 9-41

You can also set the tuning parameters individually to make adjustments. Refer to the following section for details.

- 📖 9.13 Manual Tuning on page 9-77

6.1.2 Notation for SERVOPACK Parameters

There are two types of notation used for SERVOPACK parameters that depend on whether the parameter requires a numeric setting (parameter for numeric setting) or requires the selection of a function (parameter for selecting a function).

Parameters for Numeric Settings

The control methods for which the parameters apply are given.
 [Speed]: Speed control [Position]: Position control [Torque]: Torque control

Pn100 (2100h)	Speed Loop Gain				
	Setting Range	Setting Unit	Default Setting	When Enabled	Classification
	10 to 20,000	0.1 Hz	400	Immediately	Tuning

Speed Position

Object index number used to access the parameter with EtherCAT (CoE) communications

This is the setting range for the parameter.

This is the minimum unit (setting increment) that you can set for the parameter.

This is the parameter setting before shipment.

This is when any change made to the parameter will become effective.

This is the parameter classification.

Parameters for Selecting Functions

Parameter number

Parameter	Meaning	When Enabled	Classification
Pn002 (2002h)	n.□0□□ (default setting)	After restart	Setup
	n.□1□□		
	n.□2□□		

Object index number used to access the parameter with EtherCAT (CoE) communications

The notation "n.□□□□" indicates a parameter for selecting functions. Each □ indicates the setting for one digit. The notation shown here means that the third digit from the right is set to 2.

This column explains the selections for the function.

6.1.3 Setting Methods for SERVOPACK Parameters

You can use the SigmaWin+ or a Digital Operator to set the SERVOPACK parameters. A sample operating procedure is given below.

Setting SERVOPACK Parameters with the SigmaWin+

1. Click the  Servo Drive Button in the workspace of the Main Window of the SigmaWin+.
2. Select **Edit Parameters** in the Menu Dialog Box. The Parameter Editing Dialog Box will be displayed.
3. Click the cell of the parameter to edit. If the parameter to edit is not displayed in the Parameter Editing Dialog Box, click the ▲ or ▼ Button to display the parameter to edit.

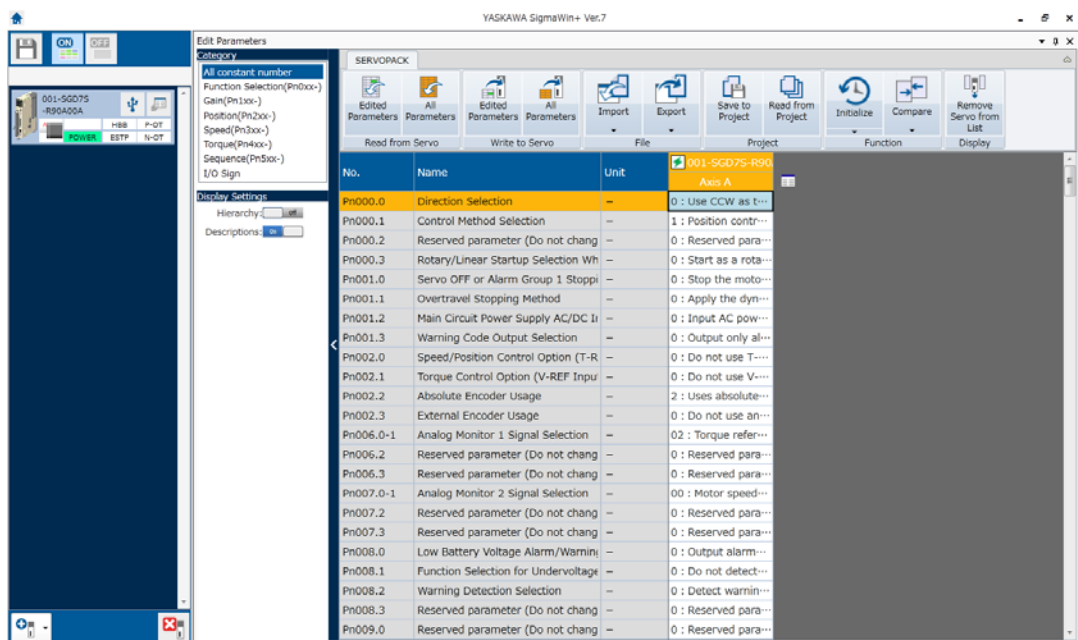

4. Change the setting of the parameter.

Information

 1. For a parameter for a numeric setting, input the numeric setting.
 2. If the parameter requires selection of a function, select the function from the list of selections.
5. Press the **Enter Key**. The background of the edited parameter cell will change to green.

6. Select Edited Parameters in the Write to Servo Group.

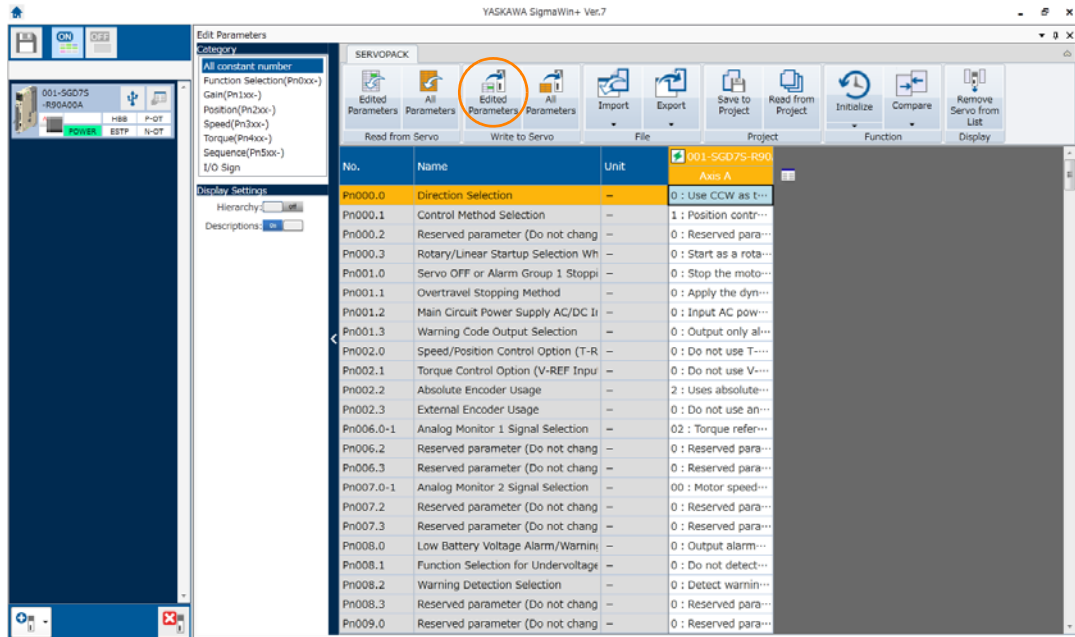

The edited parameters are written to the SERVOPACK and the backgrounds of the cells change to white.

7. Click the OK Button.

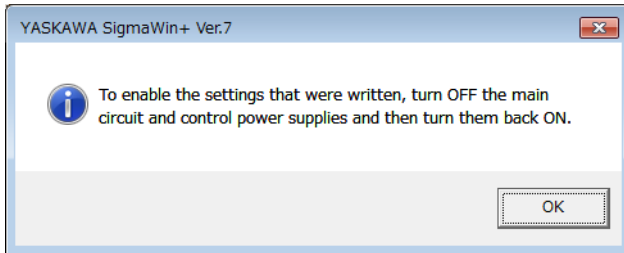

8. To enable changes to the settings, turn the power supply to the SERVOPACK OFF and ON again.

This concludes the procedure to set the parameters.

Setting SERVOPACK Parameters with a Digital Operator

Refer to the following manual for information on setting the SERVOPACK parameters with a Digital Operator.

📖 Σ-7-Series Digital Operator Operating Manual (Manual No.: SIEP S800001 33)

Setting SERVOPACK Parameters with EtherCAT (CoE) Communications

You can set objects 2000h to 26FFh with EtherCAT(CoE) communications to set the SERVOPACK parameters (Pn000 to Pn6FF).

Object index 2□□□h corresponds to SERVOPACK parameter number Pn□□□.

Example Index 2100h is the same as parameter number Pn100 (2100h = Pn100).

When you use EtherCAT (CoE) communications objects, you must write the SERVOPACK parameters to non-volatile memory.

To write the SERVOPACK parameters to non-volatile memory, set the *Store parameters field* (1010h) object.

Refer to the following section for information on *Store parameters field* (1010h).

📖 15.2 General Objects on page 15-5

6.1.4 Write Prohibition Setting for SERVOPACK Parameters

You can prohibit writing SERVOPACK parameters from a Digital Operator. Even if you do, you will still be able to change SERVOPACK parameter settings from the SigmaWin+ or with Ether-CAT (CoE) communications.

Preparations

No preparations are required.

Applicable Tools

The following table lists the tools that you can use to change the write prohibition setting for SERVOPACK parameters.

Tool	Fn No./Function Name	Reference
Digital Operator	Fn010	Σ -7-Series Digital Operator Operating Manual (Manual No.: SIEP S800001 33)
SigmaWin+	Others - Write Prohibited Setting	Operating Procedure on page 6-7

Operating Procedure

Use the following procedure to prohibit or permit writing parameters.

1. Click the Servo Drive Button in the workspace of the Main Window of the SigmaWin+.
2. Select **Write Prohibition Setting** in the Menu Dialog Box.
The Write Prohibition Setting Dialog Box will be displayed.
3. Press the or for the rightmost digit and set one of the following.
0000: Writing is permitted (default setting).
0001: Writing is prohibited.

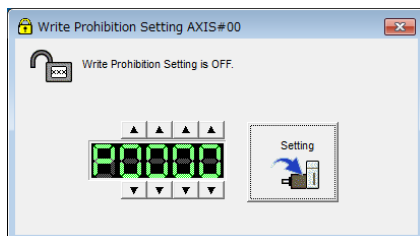

4. Click the **Setting** Button.

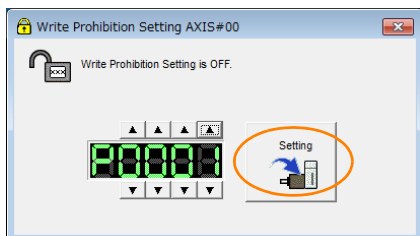

6.1.4 Write Prohibition Setting for SERVOPACK Parameters

5. Click the **OK** Button.

The setting will be written to the SERVOPACK.

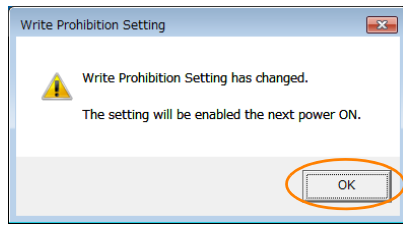

6. To enable the new setting, turn the power supply to the SERVOPACK OFF and ON again.

This concludes the procedure to prohibit or permit writing parameter settings.

Restrictions

If you prohibit writing parameter settings, you will no longer be able to execute some functions. Refer to the following table.

SigmaWin+		Digital Operator		When Writing Is Prohibited	Reference
Button in Menu Dialog Box	SigmaWin+ Function Name	Fn No.	Utility Function Name		
Basic Functions	Initialize *1	Fn005	Initializing Parameters	Cannot be executed.	page 6-10
	Software Reset	Fn030	Software Reset	Can be executed.	page 7-44
	Product Information	Fn011	Display Servomotor Model	Can be executed.	page 10-2
		Fn012	Display Software Version	Can be executed.	
		Fn01E	Display SERVOPACK and Servomotor IDs	Can be executed.	
Fn01F		Display Servomotor ID from Feedback Option Module	Can be executed.		
Encoder Setting	Absolute Encoder Reset	Fn008	Reset Absolute Encoder	Cannot be executed.	page 6-50
	Multi-turn Limit Setup	Fn013	Multiturn Limit Setting after Multiturn Limit Disagreement Alarm	Cannot be executed.	page 7-37
	Search Origin *2	Fn003	Origin Search	Cannot be executed.	page 8-19
	Zero Point Position Setting	Fn020	Set Absolute Linear Encoder Origin	Cannot be executed.	page 6-52
	Polarity Detection	Fn080	Polarity Detection	Cannot be executed.	page 6-25
Trouble-shooting	Display Alarm	Fn000	Display Alarm History	Can be executed.	page 16-43
		Fn006	Clear Alarm History	Cannot be executed.	page 16-44
		Fn014	Reset Option Module Configuration Error	Cannot be executed.	page 16-45
	Reset Motor Type Alarm	Fn021	Reset Motor Type Alarm	Cannot be executed.	page 6-13
Operation	Jog	Fn002	Jog	Cannot be executed.	page 8-7
	Program JOG Operation	Fn004	Jog Program	Cannot be executed.	page 8-13
Tuning	Tuning - Autotuning without Host Reference	Fn201	Advanced Autotuning without Reference	Cannot be executed.	page 9-23
	Tuning - Autotuning with Host Reference	Fn202	Advanced Autotuning with Reference	Cannot be executed.	page 9-34
	Tuning - Custom Tuning	Fn203	One-Parameter Tuning	Cannot be executed.	page 9-41
	Tuning - Custom Tuning - Adjust Anti-resonance Control	Fn204	Adjust Anti-resonance Control	Cannot be executed.	page 9-50
	Tuning - Custom Tuning - Vibration Suppression	Fn205	Vibration Suppression	Cannot be executed.	page 9-55
	Response Level Setting	Fn200	Tuning-less Level Setting	Cannot be executed.	page 9-16
Diagnostic	Easy FFT	Fn206	Easy FFT	Cannot be executed.	page 9-93

Continued on next page.

Continued from previous page.

SigmaWin+		Digital Operator		When Writing Is Prohibited	Reference
Button in Menu Dialog Box	SigmaWin+ Function Name	Fn No.	Utility Function Name		
Others	Adjust the Analog Monitor Output	Fn00C	Adjust Analog Monitor Output Offset	Cannot be executed.	page 10-10
		Fn00D	Adjust Analog Monitor Output Gain	Cannot be executed.	
	Adjust the Motor Current Detection Offsets	Fn00E	Autotune Motor Current Detection Signal Offset	Cannot be executed.	page 7-50
		Fn00F	Manually Adjust Motor Current Detection Signal Offset	Cannot be executed.	
	Initialize Vibration Detection Level	Fn01B	Initialize Vibration Detection Level	Cannot be executed.	page 7-46
Write Prohibited Setting	Fn010	Write Prohibition Setting	Can be executed.	page 6-7	

*1. An **Initialize** Button will be displayed in the Parameter Editing Dialog Box.

*2. Cannot be used when connecting a Linear Servomotor.

6.1.5 Initializing SERVOPACK Parameter Settings

You can return the SERVOPACK parameters to their default settings.

This function will not initialize the settings of the parameters that are adjusted for the Fn00C, Fn00D, Fn00E, and Fn00F utility functions.



To enable the new settings, turn the power supply to the SERVOPACK OFF and ON again after you complete the operation.

Preparations

Check the following settings before you initialize the SERVOPACK parameter settings.

- The SERVOPACK parameters must not be write prohibited.
- The servo must be OFF.

Applicable Tools

The following table lists the tools that you can use to initialize the SERVOPACK parameter settings.

Tool	Fn No./Function Name	Reference
Digital Operator	Fn005	Σ -7-Series Digital Operator Operating Manual (Manual No.: SIEP S800001 33)
SigmaWin+	Basic Functions - Edit Parameters	Operating Procedure on page 6-11
EtherCAT Communications	Restore Default Parameters (1011h)	Restore Default Parameters (1011h) on page 15-7

Operating Procedure

Use the following procedure to initialize the parameter settings.

1. Click the  Servo Drive Button in the workspace of the Main Window of the SigmaWin+.
2. Select **Edit Parameters** in the Menu Dialog Box.
The Parameter Editing Dialog Box will be displayed.
3. Select any parameter of the axis to initialize.
4. Click the **Initialize** Button.

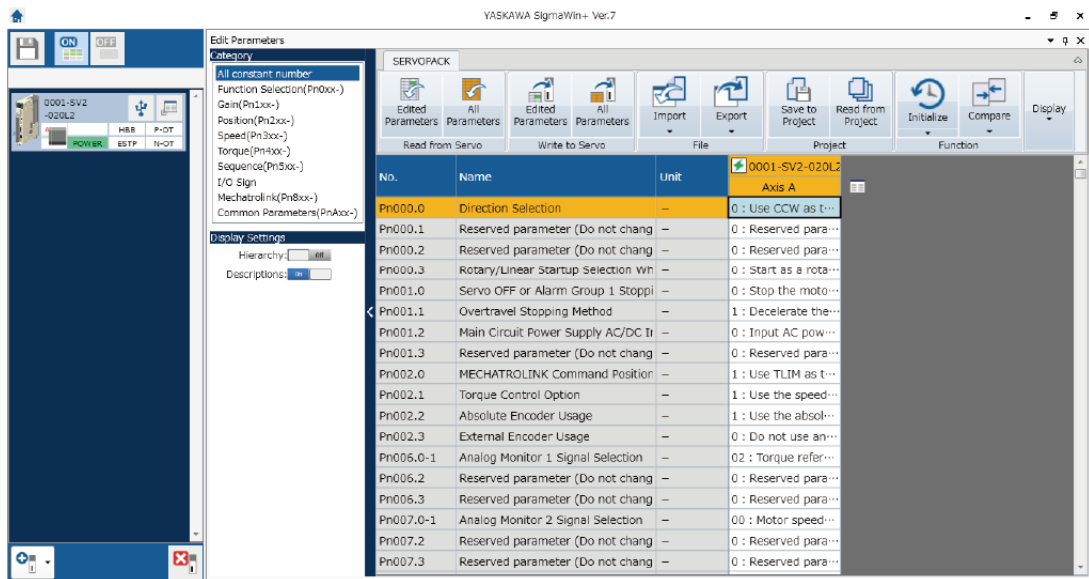

5. Click the **OK** Button.

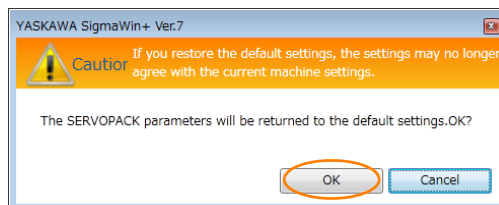

Click the **Cancel** Button to cancel initialization. The Parameter Editing Dialog Box will return.

6. Click the **OK** Button.

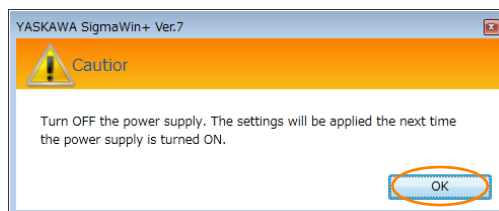

7. Turn the power supply to the SERVOPACK OFF and ON again after the parameter settings have been initialized.

This concludes the procedure to initialize the parameter settings.

6.2 Power Supply Type Settings for the Main Circuit

A SERVOPACK can operate on either an AC power supply input or DC power supply input to the main circuits. This section describes the settings related to the power supply.

Set Pn001 = n.□X□□ (Main Circuit Power Supply AC/DC Input Selection) to specify whether to use an AC or DC power supply input for the main circuit power supply to the SERVOPACK.

If the setting of Pn001 = n.□X□□ does not agree with the actual power supply input, an A.330 alarm (Main Circuit Power Supply Wiring Error) will occur.

- Example** Examples of When an A.330 Alarm (Main Circuit Power Supply Wiring Error) Occurs
- A DC power supply is connected between the B1 and ⊖2 terminals, but an AC power supply input is specified (Pn001 = n.□0□□).
 - An AC power supply is input to the L1, L2, and L3 terminals, but a DC power supply is specified (Pn001 = n.□1□□).

Parameter		Meaning	When Enabled	Classification
Pn001 (2001h)	n.□0□□ (default setting)	Use an AC power supply input.	After restart	Setup
	n.□1□□	Use a DC power supply input.		

WARNING

- Connect the AC or DC power supplies to the specified SERVOPACK terminals.
 - Connect an AC power supply to the L1, L2, and L3 terminals on the SERVOPACK.
 - Connect a DC power supply to the B1 and ⊖2 terminals and the 24 V and 0 V terminals on the SERVOPACK.

There is a risk of failure or fire.
- Always specify a DC power supply input (Pn001 = n.□1□□) before you input DC power for the main circuit power supply.
If you input DC power without specifying a DC power supply input (i.e., without setting Pn001 to n.□1□□), the SERVOPACK's internal elements may burn and may cause fire or damage to the equipment.
- With a DC power supply input, time is required to discharge electricity after the main power supply is turned OFF. A high residual voltage may remain in the SERVOPACK after the power supply is turned OFF. Be careful not to get an electric shock.
- Install fuses on the power supply line if you use DC power.
- The Servomotor returns regenerative energy to the power supply. If you use a SERVOPACK with a DC power supply input, regenerative energy is not processed. Process the regenerative energy at the power supply.

Refer to the following section for information on wiring the SERVOPACK.

 4.3.4 Power Supply Wiring Diagrams on page 4-15

6.3

Automatic Detection of Connected Motor

You can use a SERVOPACK to operate either a Rotary Servomotor or a Linear Servomotor. If you connect the Servomotor encoder to the CN2 connector on the SERVOPACK, the SERVOPACK will automatically determine which type of Servomotor is connected. Therefore, you normally do not need to specify the motor type.

Information If an encoder is not connected, e.g., for a test without a motor, you can specify a Rotary Servomotor or a Linear Servomotor in Pn000 = n.X□□□ (Rotary/Linear Startup Selection When Encoder Is Not Connected). If you specify either a Rotary or Linear Servomotor, only the parameters, monitors, alarms, and functions for the specified motor type will be enabled.

Parameter		Meaning	When Enabled	Classification
Pn000 (2000h)	n.0□□□ (default setting)	When an encoder is not connected, start as SERVOPACK for Rotary Servomotor.	After restart	Setup
	n.1□□□	When an encoder is not connected, start as SERVOPACK for Linear Servomotor.		

6.4 Motor Direction Setting







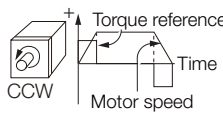

You can reverse the direction of Servomotor rotation by changing the setting of Pn000 = n.□□□X (Direction Selection) without changing the polarity of the speed or position reference. This causes the rotation direction of the motor to change, but the polarity of the signals, such as encoder output pulses, output from the SERVOPACK do not change. Set the appropriate direction for your system.

Refer to the following section for details on the encoder divided pulse output.

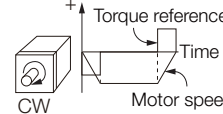
 7.5 Encoder Divided Pulse Output on page 7-18

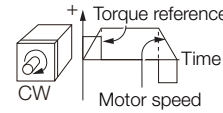
• Rotary Servomotors

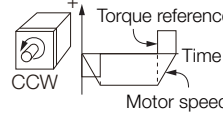





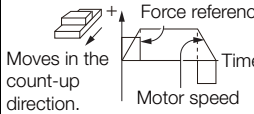

The default setting for forward rotation is counterclockwise (CCW) as viewed from the load end of the Servomotor.

Parameter		Forward/Reverse Reference	Motor Direction and Encoder Divided Pulse Outputs		Applicable Overtravel Signal (OT)
Pn000 (2000h)	n.□□□0 Use CCW as the forward direction. (default setting)	Forward reference		Encoder Divided Pulse Outputs PAO  PBO  Phase-B lead	P-OT (Forward Drive Prohibit) signal
		Reverse reference		Encoder Divided Pulse Outputs PAO  PBO  Phase-A lead	N-OT (Reverse Drive Prohibit) signal
	n.□□□1 Use CW as the forward direction. (Reverse Rotation Mode)	Forward reference		Encoder Divided Pulse Outputs PAO  PBO  Phase-B lead	P-OT (Forward Drive Prohibit) signal
		Reverse reference		Encoder Divided Pulse Outputs PAO  PBO  Phase-A lead	N-OT (Reverse Drive Prohibit) signal

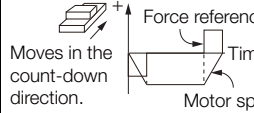
Note: The trace waveforms of the SigmaWin+ are shown in the above table for the torque reference and motor speed diagrams. If you measure them on a measuring instrument, e.g., with an analog monitor, the polarity will be reversed.

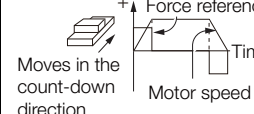
• Linear Servomotors

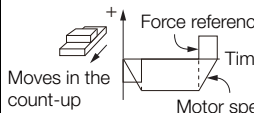
Before you set this parameter, make sure that Pn080 = n.□□X□ (Motor Phase Sequence Selection) is set correctly.

Parameter		Forward/Reverse Reference	Motor Moving Direction and Encoder Divided Pulse Outputs		Applicable Overtravel Signal (OT)
Pn000 (2000h)	n.□□□0 Use the direction in which the linear encoder counts up as the forward direction. (default setting)	Forward reference		Encoder Divided Pulse Outputs PAO  PBO  Phase-B lead	P-OT (Forward Drive Prohibit) signal
		Reverse reference		Encoder Divided Pulse Outputs PAO  PBO  Phase-A lead	N-OT (Reverse Drive Prohibit) signal
	n.□□□1 Use the direction in which the linear encoder counts down as the forward direction.	Forward reference		Encoder Divided Pulse Outputs PAO  PBO  Phase-B lead	P-OT (Forward Drive Prohibit) signal
		Reverse reference		Encoder Divided Pulse Outputs PAO  PBO  Phase-A lead	N-OT (Reverse Drive Prohibit) signal

Note: The trace waveforms of the SigmaWin+ are shown in the above table for the force reference and motor speed diagrams. If you measure them on a measuring instrument, e.g., with an analog monitor, the polarity will be reversed.

6.5

Setting the Linear Encoder Pitch

If you connect a linear encoder to the SERVOPACK through a Serial Converter Unit, you must set the scale pitch of the linear encoder in Pn282.

If a Serial Converter Unit is not connected, the setting of the Pn282 is disabled.



Term

Serial Converter Unit

The Serial Converter Unit converts the signal from the linear encoder into a form that can be read by the SERVOPACK.

Scale Pitch

A linear encoder has a scale for measuring lengths (positions). The length of one division on this scale is the scale pitch.

Pn282 (2282h)	Linear Encoder Pitch				Speed	Position	Force
	Setting Range	Setting Unit	Default Setting	When Enabled	Classification		
	0 to 6,553,600	0.01 μm	0	After restart	Setup		

You will not be able to control the Linear Servomotor if Pn282 is not set correctly. Check the above table and always set the correct value before you operate the Linear Servomotor.

Type of Linear Encoder	Manufacturer	Model	Serial Converter Unit Model	Linear Encoder Pitch [μm]
Incremental	Dr. JOHANNES HEIDENHAIN GmbH	LIDA48□	JZDP-H003-□□□-E	20
			JZDP-J003-□□□-E	
		LIF48□	JZDP-H003-□□□-E	4
			JZDP-J003-□□□-E	
	Renishaw PLC	RGH22B	JZDP-H005-□□□-E	20
			JZDP-J005-□□□-E	

The first time you supply power to the SERVOPACK, the panel display on the front of the Servomotor will display an A.080 alarm (Linear Encoder Pitch Setting Error). The A.080 alarm is displayed because the setting of Pn282 has not been changed. The A.080 alarm will be cleared when you change the setting of Pn282 and then turn the power supply OFF and ON again.

Information**Linear Encoder Pitch**

If you do not use a Serial Converter Unit, the linear encoder pitch is automatically set and the setting of the Pn282 is disabled. Refer to the following section for details.

Feedback Resolution of Linear Encoder on page 6-44

6.6 Writing Linear Servomotor Parameters

If you connect a linear encoder to the SERVOPACK without going through a Serial Converter Unit, you must use the SigmaWin+ to write the motor parameters to the linear encoder. The motor parameters contain the information that is required by the SERVOPACK to operate the Linear Servomotor.

 **WARNING**

- Check the motor and linear encoder information before you write the motor parameters. If you do not write the correct motor parameters, the motor may run out of control or burning may occur, possibly resulting in equipment damage or fire.

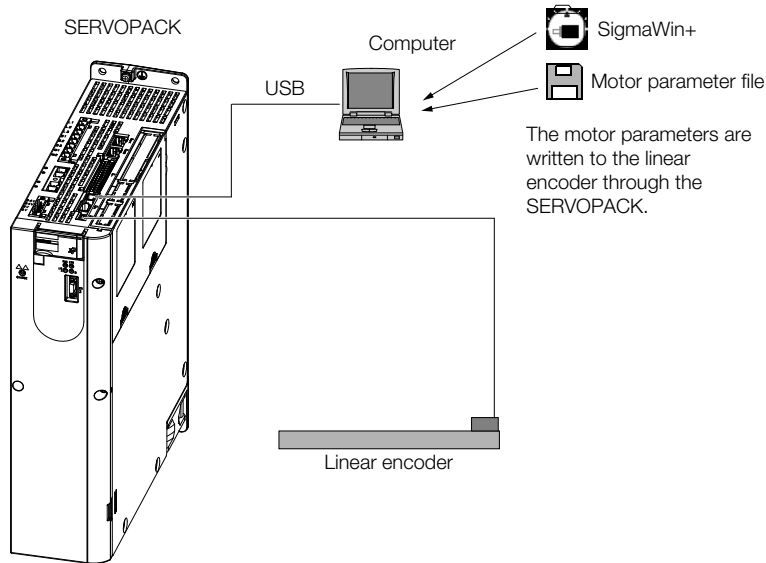

 **Important** Serial number information is not included in the motor parameters. You cannot use the monitor functions of the SERVOPACK to monitor the serial number. If you attempt to monitor the serial number, ***** will be displayed.

Precautions

- If the encoder parameters are not written to the linear encoder, an A.CA0 alarm (Encoder Parameter Error) will occur. Consult the manufacturer of the linear encoder.
- If the motor parameters are not written to the linear encoder, an A.CA0 alarm (Encoder Parameter Error) will not occur, but the following alarms will occur.
 A.040 (Parameter Setting Error), A.041 (Encoder Output Pulse Setting Error),
 A.050 (Combination Error), A.051 (Unsupported Device Alarm),
 A.550 (Maximum Speed Setting Error), A.710 (Instantaneous Overload),
 A.720 (Continuous Overload), and A.C90 (Encoder Communications Error)

Applicable Tools

The following table lists the tools that you can use to write the parameters to the Linear Servomotor.

Tool	Fn No./Function Name	Reference
Digital Operator	You cannot write Linear Servomotor parameters from the Digital Operator.	
SigmaWin+	Encoder Setting - Motor Parameters	 Operating Procedure on page 6-17

Operating Procedure

Use the following procedure to write the motor parameters to the linear encoder.

1. Prepare the motor parameter file to write to the linear encoder.
2. Click the  Servo Drive Button in the workspace of the Main Window of the SigmaWin+.
3. Select **Motor Parameter Scale Write** in the Menu Dialog Box. The Motor Parameter Scale Write Dialog Box will be displayed.
4. Click the **OK** Button.

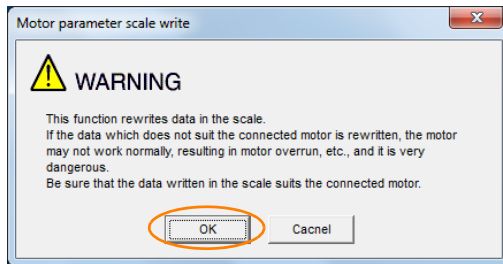

Click the **Cancel** Button to cancel writing the motor parameters to the linear encoder. The Main Window will return.

If the write is completed normally, the Motor Parameter Scale Write - File Select Dialog Box will be displayed.

5. Click the **Ref.** Button.

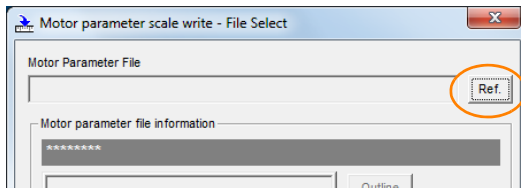

6. Select the motor parameter file that you prepared and click the **Open** Button.

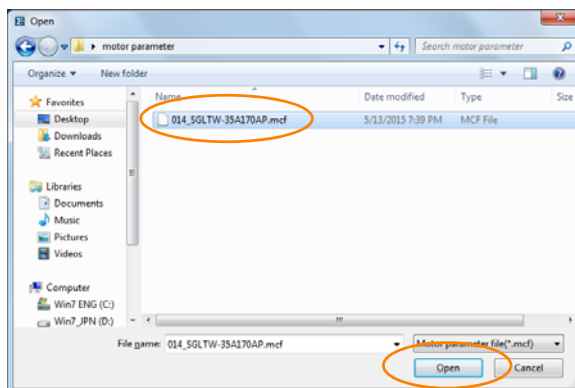

7. Confirm that the motor parameter file information that is displayed is suitable for your motor, and then click the **Next Button**.

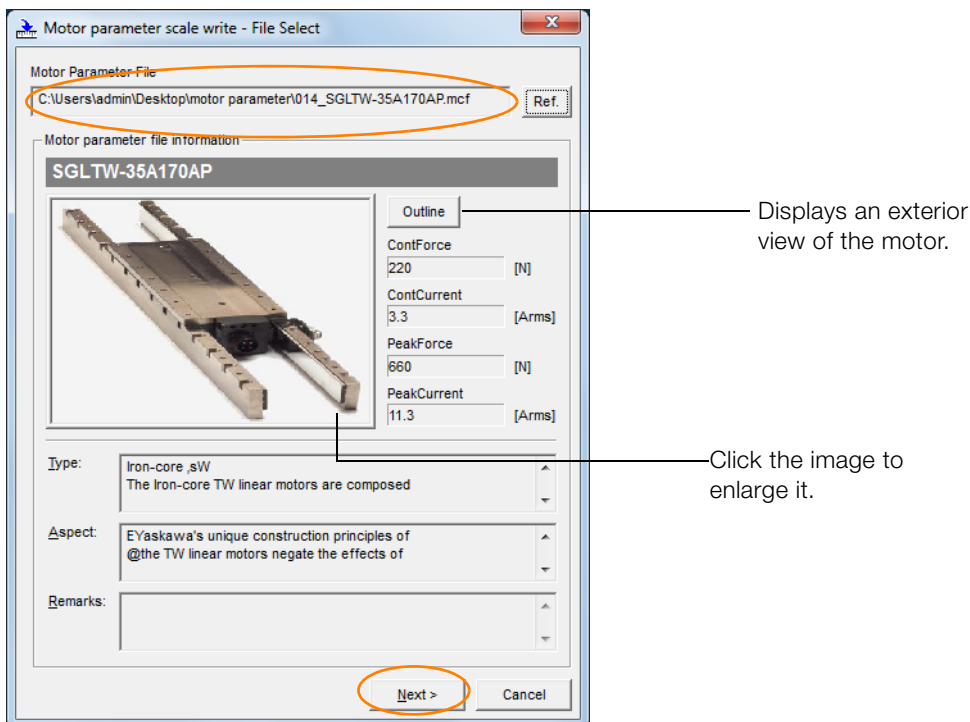

Click the **Cancel** Button to cancel writing the motor parameters to the linear encoder. The Main Window will return.

8. Click the **Write Button**.

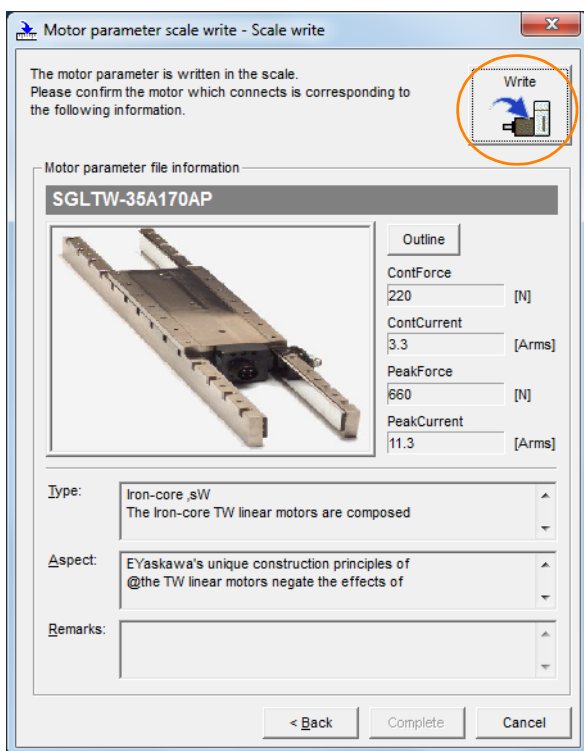

9. Click the Yes Button.

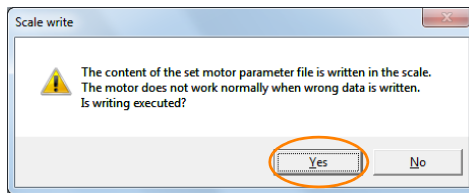

Click the **No** Button to cancel writing the motor parameters to the linear encoder.

If you click the **Yes** Button, writing the motor parameter scale will start.

10. Click the Complete Button.

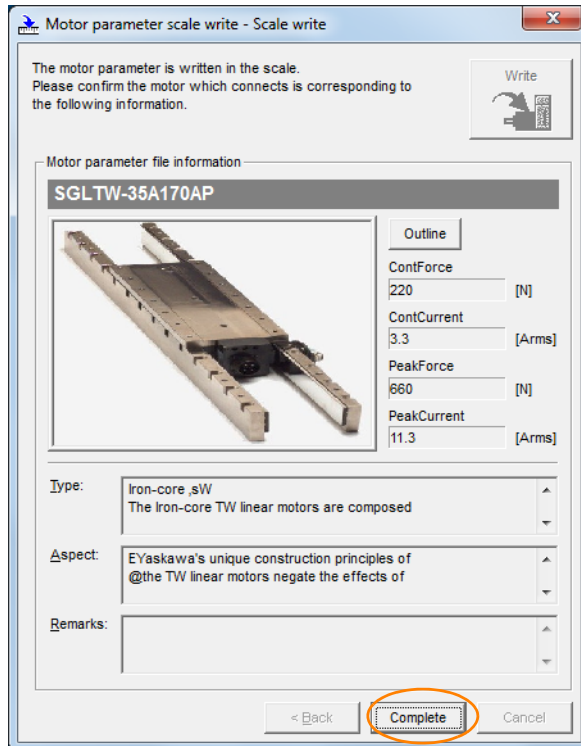

11. Click the OK Button.

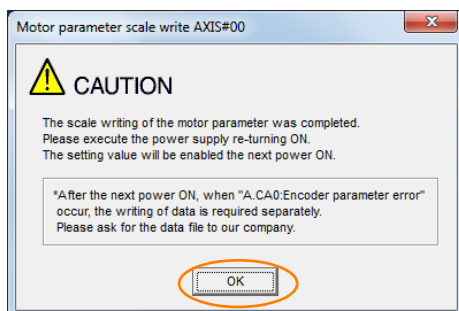

12. Turn the power supply to the SERVOPACK OFF and ON again.

This concludes the procedure to write the motor parameters.

Confirming If the Motor Parameters Have Been Written

After you write the motor parameters, you can use a monitor function to confirm that the motor parameters are in the encoder.

If the motor parameters have not been written, no information on the Servomotor will be displayed.

10.1 Monitoring Product Information on page 10-2

6.7 Selecting the Phase Sequence for a Linear Servomotor

You must select the phase sequence of the Linear Servomotor so that the forward direction of the Linear Servomotor is the same as the encoder's count-up direction.

Before you set the Linear Servomotor phase sequence (Pn080 = n.□□X□), check the following items.

- Confirm that the signal from the linear encoder is being received normally.
- Make sure that the forward direction of the Linear Servomotor and the count-up direction of the linear encoder are in the same direction.



Important If you do not confirm the above items before you attempt to operate the motor, the motor may not operate or it may run out of control. Always confirm these items before you operate the motor.

Related Parameters

Parameter	Meaning	When Enabled	Classification
Pn080 (2080h)	n.□□0□ (default setting)	After restart	Setup
	n.□□1□		

Setting Procedure

Use the following procedure to select the phase sequence for a Linear Servomotor.

- 1. Set Pn000 to n.□□□0 (Set a phase-A lead as a phase sequence of U, V, and W).**
This setting is to make following confirmation work easier to understand.
- 2. Select Monitor in the Menu Dialog Box.**
The Operation Pane will be displayed so that you can check the feedback pulse counter.
To check the feedback pulse counter with the Digital Operator, use Un00D (Feedback Pulse Counter).
- 3. Manually move the Moving Coil from one end to the other of the stroke and confirm that only the correct number of feedback pulses is returned.**
If the correct number and only the correct number of pulses is returned, the signal is being received correctly from the linear encoder.

Example In this example, assume that a linear encoder with a scale pitch of 20 μm and a resolution of 256 is used. If you manually move the Moving Coil 1 cm in the count-up direction of the linear encoder, the number of feedback pulses would be as follows:
 $1 \text{ cm} / (20 \text{ μm} / 256) = 128,000 \text{ pulses}$

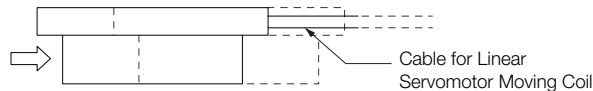

If there are 128,000 pulses on the feedback pulse counter after you manually move the Moving Coil in the direction of the cable, you have completed the confirmation.

Note: The actual monitor display will be offset by the error in the travel distance. There is no problem as long as the above value is close to the calculated value.

Information

If the correct value is not displayed for the feedback pulse counter, the following conditions may exist. Check the situation and correct any problems.

- The linear encoder pitch is not correct.
If the scale pitch that is set in Pn282 does not agree with the actual scale pitch, the expected number of feedback pulses will not be returned. Check the specifications of the linear encoder.
- The linear encoder is not adjusted properly.
If the linear encoder is not adjusted properly, the output signal level from the linear encoder will drop and the correct number of pulses will not be counted. Check the adjustment of the linear encoder. Contact the manufacturer of the linear encoder for details.
- There is a mistake in the wiring between the linear encoder and the Serial Converter Unit.
If the wiring is not correct, the correct number of pulses will not be counted. Correct the wiring.

4. Manually move the Moving Coil in the direction of the cable and check the value of the feedback pulse counter in the Operation Pane to confirm that it is counting up.
If the pulses are counted up, the forward direction of the Linear Servomotor is the same as the count-up direction of the linear encoder.

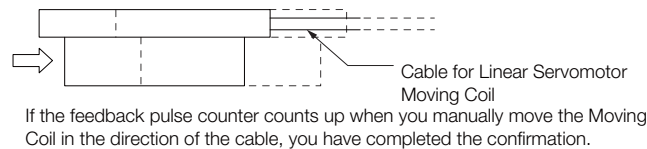

5. If the feedback pulse counter counts down, set a phase-B lead as a phase sequence of U, V, and W (Pn080 = n.□□1□) and turn the power supply OFF and ON again.
6. If necessary, return Pn000 = n.□□□X (Direction Selection) to its original setting.

This concludes the procedure to set the phase sequence of the Linear Servomotor.

6.8 Polarity Sensor Setting

The polarity sensor detects the polarity of the Servomotor. You must set a parameter to specify whether the Linear Servomotor that is connected to the SERVOPACK has a polarity sensor. Specify whether there is a polarity sensor in Pn080 = n.□□□X (Polarity Sensor Selection).

If the Linear Servomotor has a polarity sensor, set Pn080 to n.□□□0 (Use polarity sensor) (default setting).

If the Linear Servomotor does not have a polarity sensor, set Pn080 to n.□□□1 (Do not use polarity sensor). Turn the power supply OFF and ON again to enable the new setting.

Parameter		Meaning	When Enabled	Classification
Pn080 (2080h)	n.□□□0 (default setting)	Use polarity sensor.	After restart	Setup
	n.□□□1	Do not use polarity sensor.		

Information If you set Pn080 to n.□□□0 (Use polarity sensor) and the Linear Servomotor that is connected to the SERVOPACK does not have a polarity sensor, an A.C21 alarm (Polarity Sensor Error) will occur when you turn the power supply OFF and ON again.

6.9 Polarity Detection

If you use a Linear Servomotor that does not have a polarity sensor, then you must detect the polarity.

Detecting the polarity means that the position of the electrical angle phase on the electrical angle coordinates of the Servomotor is detected. The SERVOPACK cannot control the Servomotor correctly unless it accurately knows the position of the electrical angle coordinate of the Servomotor.

The execution timing and execution method for polarity detection depend on the encoder specification as described in the following table.

Encoder Specification	Polarity Detection Execution Timing	Polarity Detection Execution Method
Incremental encoder	Each time the control power supply to the SERVOPACK is turned ON (Even after you execute polarity detection, the position of the polarity will be lost the next time the control power supply to the SERVOPACK is turned OFF.)	<ul style="list-style-type: none"> • Use the Servo ON command (Enable Operation command). • Use the polarity detection function of the SigmaWin+. • Execute the Fn080 (Polarity Detection) utility function from the Digital Operator.
Absolute encoder	Only for initial setup, or after the SERVOPACK, linear encoder, or motor has been replaced (The results of polarity detection is stored in the absolute encoder, so the polarity position is not lost when the control power supply is turned OFF.)	<ul style="list-style-type: none"> • Use the polarity detection function of the SigmaWin+. • Execute the Fn080 (Polarity Detection) utility function from the Digital Operator.

Information If you use a Linear Servomotor that does not have a polarity sensor, you will not be able to turn ON the servo until polarity detection has been completed.

6.9.1 Restrictions

Assumed Conditions

The Servomotor will move when you execute polarity detection. The following conditions must be met before you start.

- It must be OK to move the Moving Coil about 10 mm. (If polarity detection fails, the Moving Coil may move approximately 5 cm. The amount of movement depends on conditions.)
- The linear encoder pitch must be 100 μm or less. (We recommend a pitch of 40 μm or less for an incremental encoder.)
- As much as possible, the motor must not be subjected to an imbalanced external force. (We recommend 5% or less of the rated force.)
- The mass ratio must be 50x or less.
- The axis must be horizontal.
- There must be friction equivalent to a few percent of the rated force applied to the guides. (Air sliders cannot be used.)

Preparations

Check the following settings before you execute polarity detection.

- Not using a polarity sensor must be specified (Pn080 = n.□□□1).
- The servo must be OFF.
- The main circuit power supply must be ON.
- There must be no hard wire base block (HWBB).
- There must be no alarms except for an A.C22 alarm (Phase Information Disagreement).

6.9.2 Using the Servo ON Command (Enable Operation Command) to Perform Polarity Detection

- The parameters must not be write prohibited. (This item applies only when using the SigmaWin+ or Digital Operator.)
- The test without a motor function must be disabled (Pn00C = n.□□□0).
- There must be no overtravel.
- If the motor parameters have been written or the origin of the absolute linear encoder has been set, the power supply to the SERVOPACK must be turned OFF and ON again after completion of the writing or setting operation.



Important

1. Power is supplied to the Servomotor during polarity detection. Be careful not to get an electric shock. Also, the Moving Coil of the Linear Servomotor may greatly move during detection. Do not approach the moving parts of the Servomotor.
2. Polarity detection is affected by many factors. For example, polarity detection may fail if the mass ratio or friction is too large or the cable tension is too strong.

6.9.2 Using the Servo ON Command (Enable Operation Command) to Perform Polarity Detection

You can use the Servo ON command (Enable Operation command) to perform polarity detection only with an incremental linear encoder.

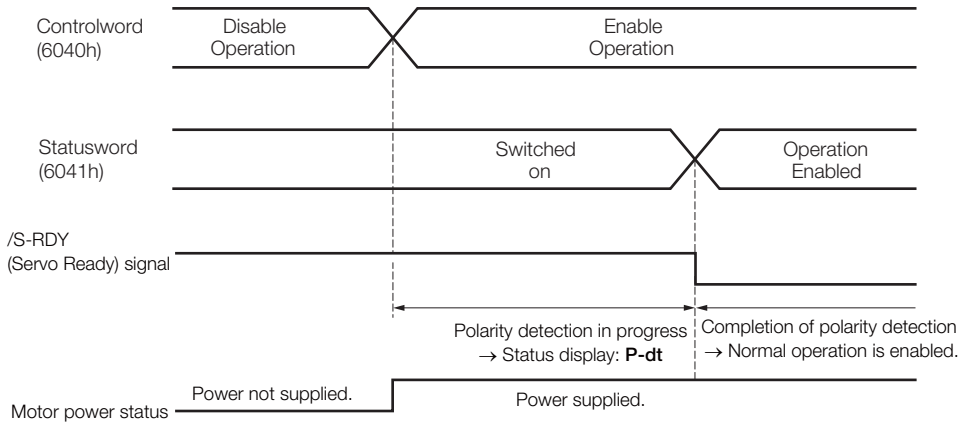

Polarity detection will start simultaneously with execution of the Servo ON command (Enable Operation command). As soon as polarity detection is completed, the /S-RDY will turn ON and the servo will change to ON status (*statusword* = *operation enabled*).



6.9.3 Using a Tool Function to Perform Polarity Detection

Applicable Tools

The following table lists the tools that you can use to perform polarity detection.

Tool	Fn No./Function Name	Reference
Digital Operator	Fn080	 Σ -7-Series Digital Operator Operating Manual (Manual No.: SIEP S800001 33)
SigmaWin+	<i>Encoder Setting - Polarity Detection</i>	 <i>Operating Procedure</i> on page 6-25

Operating Procedure

Use the following procedure to perform polarity detection.

1. Click the  Servo Drive Button in the workspace of the Main Window of the SigmaWin+.
2. Select **Polarity Detection** in the Menu Dialog Box.
The Polarity Detection Dialog Box will be displayed.
3. Click the **Continue** Button.

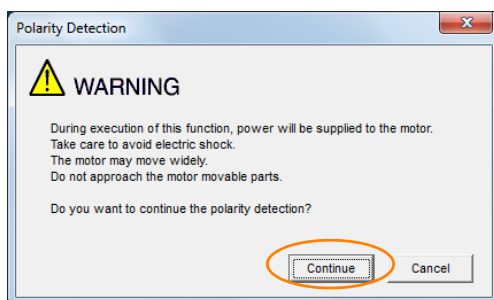

Click the **Cancel** Button to cancel polarity detection. The Main Window will return.

4. Click the **Start** Button.
Polarity detection will be executed.

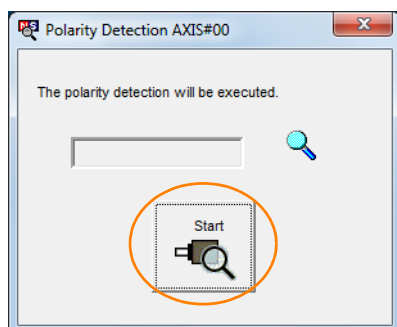

This concludes the polarity detection procedure.

6.10 Overtravel and Related Settings

Overtravel is a function of the SERVOPACK that forces the Servomotor to stop in response to a signal input from a limit switch that is activated when a moving part of the machine exceeds the safe range of movement.

The overtravel signals include the P-OT (Forward Drive Prohibit) and the N-OT (Reverse Drive Prohibit) signals.

You use the P-OT and N-OT signals to stop the machine by installing limit switches at the positions where you want to stop the machine that is operated by the Servomotor.

A SERVOPACK wiring example is provided below.

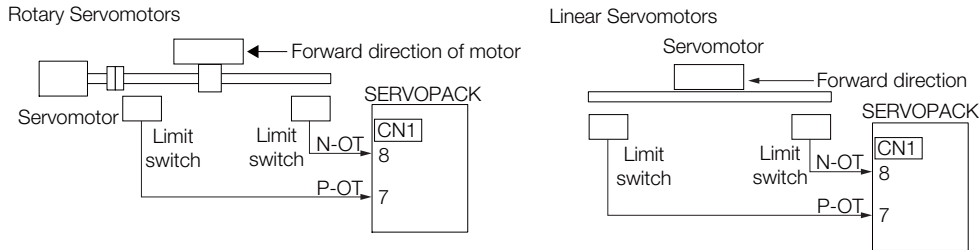

Using the overtravel function is not necessary for rotating applications such as rotary tables and conveyors. No wiring for overtravel input signals is required.

This section describes the parameters settings related to overtravel.

CAUTION

- To prevent accidents that may result from contact faults or disconnections, use normally closed limit switches.
Do not change the default settings of the polarity of the overtravel signals (P-OT and N-OT).
- If you use a Servomotor for a vertical axis, the /BK (Brake) signal will remain ON (i.e., the brake will be released) when overtravel occurs. This may result in the workpiece falling when overtravel occurs. To prevent the workpiece from falling, set Pn001 to n.□□1□ to place the Servomotor in a zero-clamped state when it stops.
- A base block state is entered after stopping for overtravel. This may cause the Servomotor to be pushed back by an external force on the load shaft. To prevent the Servomotor from being pushed back, set Pn001 to n.□□1□ to place the Servomotor in a zero-clamped state when it stops.

6.10.1 Overtravel Signals

The overtravel signals include the P-OT (Forward Drive Prohibit) and the N-OT (Reverse Drive Prohibit) signals.

Type	Signal	Connector Pin No.	Signal Status	Meaning
Input	P-OT	CN1-7	ON	Forward drive is enabled (actual operation).
			OFF	Forward drive is prohibited (forward overtravel).
	N-OT	CN1-8	ON	Reverse drive is enabled (actual operation).
			OFF	Reverse drive is prohibited (reverse overtravel).

You can operate the Servomotor in the opposite direction during overtravel by inputting a reference.

6.10.2 Setting to Enable/Disable Overtravel

You can use Pn50A = n.X□□□ (P-OT (Forward Drive Prohibit) Signal Allocation) and Pn50B = n.□□□X (N-OT (Reverse Drive Prohibit) Signal Allocation) to enable and disable the overtravel function.

You do not need to wire the overtravel input signals if you are not going to use the overtravel function.

Parameter		Meaning	When Enabled	Classification
Pn50A (250Ah)	n.1□□□ (default setting)	The forward overtravel function is enabled and the P-OT (Forward Drive Prohibit) signal is input from CN1-7.	After restart	Setup
	n.8□□□	The reverse overtravel function is disabled. Forward drive is always enabled.		
Pn50B (250Bh)	n.□□□2 (default setting)	The reverse overtravel function is enabled and the N-OT (Reverse Drive Prohibit) signal is input from CN1-8.		
	n.□□□8	The reverse overtravel function is disabled. Reverse drive is always enabled.		

You can allocate the P-OT and N-OT signals to other connector pins. Refer to the following section for details.

 7.1.1 Input Signal Allocations on page 7-4

6.10.3 Motor Stopping Method for Overtravel

You can set the stopping method of the Servomotor when overtravel occurs in Pn001 = n.□□XX (Servo OFF or Alarm Group 1 Stopping Method and Overtravel Stopping Method).

Parameter		Motor Stopping Method*	Status after Stopping	When Enabled	Classification
Pn001 (2001h)	n.□□00 (default setting)	Dynamic brake	Coasting	After restart	Setup
	n.□□01				
	n.□□02	Coasting			
	n.□□1□	Deceleration according to setting of Pn406 (2406h)	Zero clamp		
	n.□□2□	Deceleration according to setting of Pn406 (2406h)	Coasting		
	n.□□3□	Deceleration according to setting of Pn30A (230Ah)	Zero clamp		
	n.□□4□	Deceleration according to setting of Pn30A (230Ah)	Coasting		

* You cannot decelerate a Servomotor to a stop during torque control. For torque control, the Servomotor will be stopped with the dynamic braking or coast to a stop (according to the setting of Pn001 = n.□□□X (Servo OFF or Alarm Group 1 Stopping Method)), and then the Servomotor will enter a coasting state.

Refer to the following section for information on stopping methods other than those for overtravel.

 6.12.1 Stopping Method for Servo OFF on page 6-38

Stopping the Servomotor by Setting Emergency Stop Torque

To stop the Servomotor by setting emergency stop torque, set Pn406 (Emergency Stop Torque).

If Pn001 = n.□□X□ is set to 1 or 2, the Servomotor will be decelerated to a stop using the torque set in Pn406 as the maximum torque.

The default setting is 800%. This setting is large enough to allow you to operate the Servomotor at the maximum torque. However, the maximum emergency stop torque that you can actually use is the maximum torque of the Servomotor.

Pn406 (2406h)	Emergency Stop Torque			Speed	Position
	Setting Range	Setting Unit	Default Setting	When Enabled	Classification
	0 to 800	1%*	800	Immediately	Setup

* Set a percentage of the motor rated torque.

Stopping the Servomotor by Setting the Deceleration Time

To specify the Servomotor deceleration time and use it to stop the Servomotor, set Pn30A (Deceleration Time for Servo OFF and Forced Stops).

Pn30A (230Ah)	Deceleration Time for Servo OFF and Forced Stops			Speed	Position
	Setting Range	Setting Unit	Default Setting	When Enabled	Classification
	0 to 10,000	1 ms	0	Immediately	Setup

If you set Pn30A to 0, the Servomotor will be stopped with a zero speed.

The deceleration time that you set in Pn30A is the time to decelerate the motor from the maximum motor speed.

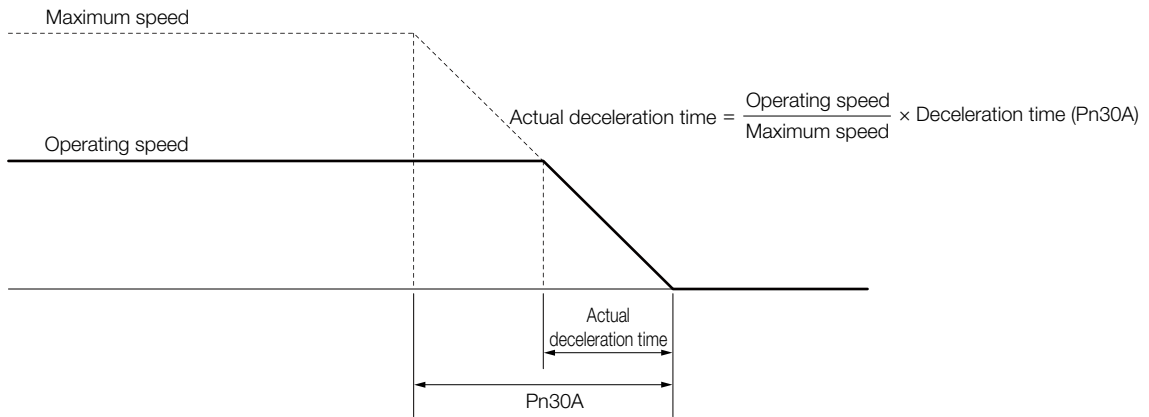

6.10.4 Overtravel Warnings

You can set the system to detect an A.9A0 warning (Overtravel) if overtravel occurs while the servo is ON. This allows the SERVOPACK to notify the host controller with a warning even when the overtravel signal is input only momentarily. An alarm occurs only if overtravel occurs while the servo is ON. An overtravel warning will not be detected when the servo is OFF, even if overtravel occurs.



Important

1. The occurrence of an A.9A0 warning will not stop the motor or have any effect on host controller motion operations. The next step (e.g., the next motion or command) can be executed even if an overtravel warning exists. However, depending on the processing specifications and programming for warnings in the host controller, operation may be affected when an overtravel warning occurs (e.g., motion may stop or not stop). Confirm the specifications and programming in the host controller.
2. When overtravel occurs, the SERVOPACK will perform stop processing for overtravel. Therefore, when an A.9A0 warning occurs, the Servomotor may not reach the target position specified by the host controller. Check the feedback position to make sure that the axis is stopped at a safe position.

The following parameter is set for this function.

Parameter	Meaning	When Enabled	Classification
Pn00D (200Dh)	n.0□□□ (default setting)	Immediately	Setup
	n.1□□□		

A timing chart for warning detection is provided below.

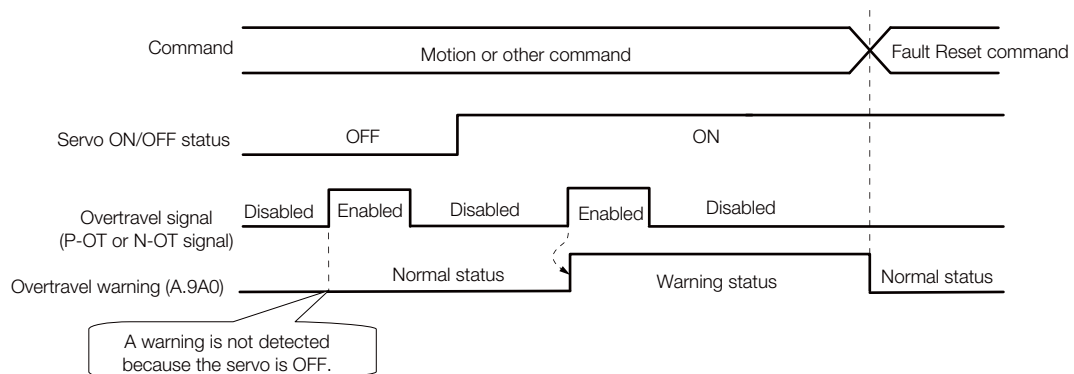

Information

1. Warnings are detected for overtravel in the same direction as the reference.
2. Warnings are not detected for overtravel in the opposite direction from the reference. Example: A warning will not be output for a forward reference even if the N-OT signal turns ON.
3. A warning can be detected in either the forward or reverse direction if there is no reference.
4. A warning will not be detected when the servo is turned ON even if overtravel status exists.
5. You can use the ALM_CLR (Clear Alarms and Warnings) command to clear the warning regardless of the servo ON/OFF status and overtravel signal status.
6. If you clear the warning with the Fault Reset command during overtravel status, a warning will not be detected again until the overtravel status is left.
7. An overtravel warning will be detected even when the software limit has been detected.

6.10.5 Overtravel Release Method Selection

You can set Pn022 = n.□□□X (Overtravel Release Method Selection) to release overtravel. *Internal limit active* (bit 11) in *statusword* changes to 1 during overtravel. The motor will not be driven if there is overtravel in the same direction as the reference.

Parameter	Meaning	When Enabled	Classification
Pn022 (2022h)	n.□□□0 (default setting)	After restart	Setup
	n.□□□1		

* Here, "separated" means a position that is further in the positive direction than the P-OT signal or a position that is further in the negative direction than the N-OT signal.

When Pn022 Is Set to n.□□□0

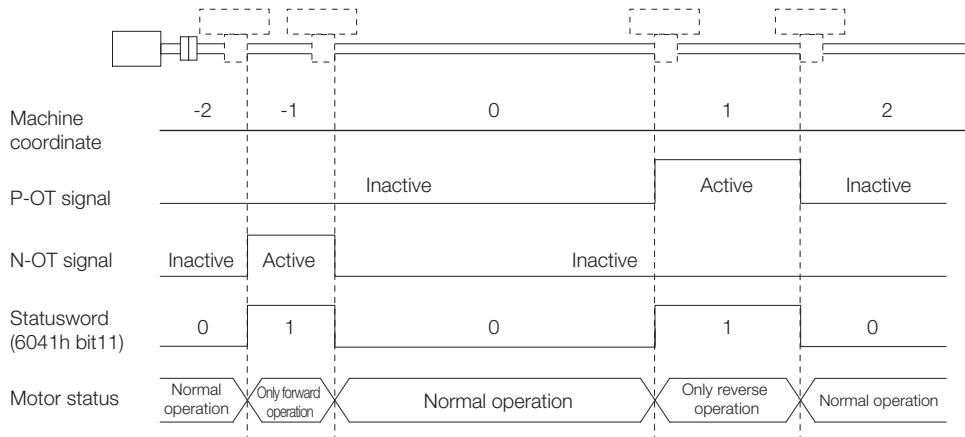

When Pn022 Is Set to n.□□□1

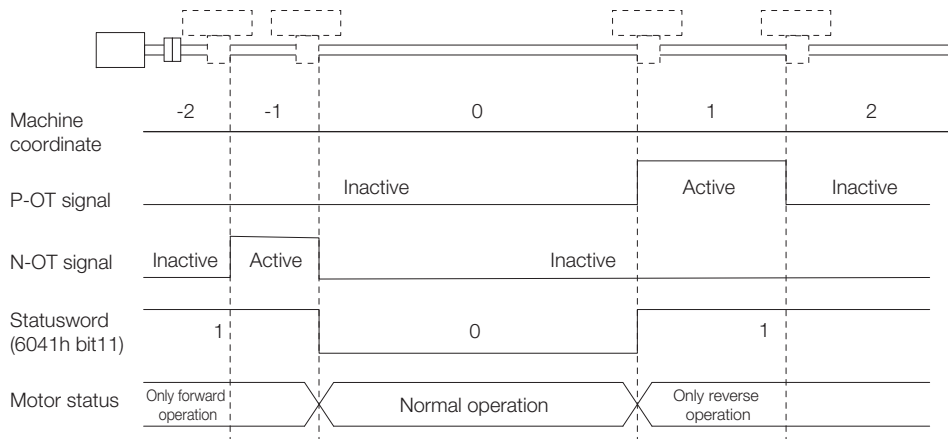

6.10.6 Overtravel Status

If an overtravel signal is input, the following SERVOPACK status will change to 1 and the Servo-motor will be stopped according to the overtravel stopping method set in Pn001. When the overtravel signal is reset, the status changes to 0.

Internal limit active (bit 11) in *statusword* (6041h)

Negative limit switch (bit 0) or *positive limit switch* (bit 1) in *digital inputs* (60FDh)

6.10.7 Overtravel Operation by Mode

Operation Mode	Operation
Profile position mode	<ul style="list-style-type: none"> If an overtravel signal is input, the positioning operation to the current target position will be canceled and, after the motor stops, <i>target reached</i> in <i>statusword</i> will be reset. A positioning operation (return operation) is started only when a movement reference to a target position in the opposite direction from the overtravel signal is specified in the current Position Actual Value (e.g., a negative movement reference if the P-OT signal is input).
Homing mode	<ul style="list-style-type: none"> For Homing Method 1, 11, 12, 13, 14, 28, or 34: If the P-OT signal is input, <i>homing error</i> (bit 13) in <i>statusword</i> (6041h) changes to 1 and the homing operation is canceled. For Homing Method 2, 7, 8, 9, 10, 24, or 33: If the N-OT signal is input, <i>homing error</i> (bit 13) in <i>statusword</i> (6041h) changes to 1 and the homing operation is canceled.
Interpolated position mode, Cyclic synchronous position mode	<ul style="list-style-type: none"> If an overtravel signal is input, the positioning operation to the current target position will be canceled and, after the motor stops, <i>target reached</i> in <i>statusword</i> will be reset. A positioning operation (return operation) is started only when a movement reference to a target position in the opposite direction from the overtravel signal is specified in the current <i>position actual value</i> (e.g., a negative movement references if the P-OT signal is input).
Profile velocity mode, Cyclic synchronous velocity mode	<ul style="list-style-type: none"> During overtravel, the motor is operated only when a speed in the direction opposite from the overtravel signal is specified (e.g., a negative target speed when the P-OT signal is input).
Profile torque mode, Cyclic synchronous torque mode	<ul style="list-style-type: none"> During overtravel, torque is applied only when a torque in the direction opposite from the overtravel signal is specified (e.g., a negative torque when the P-OT signal is input).

6.11 Holding Brake

A holding brake is used to hold the position of the moving part of the machine when the SERVOPACK is turned OFF so that moving part does not move due to gravity or an external force. You can use the brake that is built into a Servomotor with a Brake, or you can provide one on the machine.

The holding brake is used in the following cases.

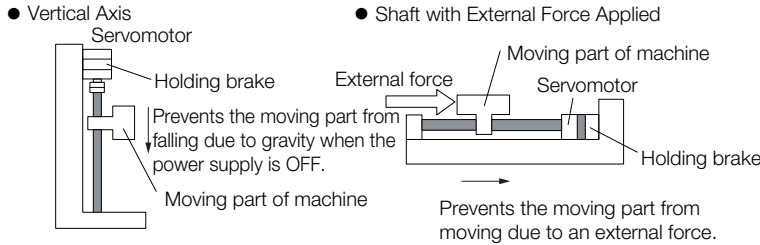

Important The brake built into a Servomotor with a Brake is a de-energization brake. It is used only to hold the Servomotor and cannot be used for braking. Use the holding brake only to hold a Servomotor that is already stopped.

6.11.1 Brake Operating Sequence

You must consider the time required to release the brake and the time required to brake to determine the brake operation timing, as described below.

Term

Time Required to Release Brake
The time from when the /BK (Brake) signal is turned ON until the brake is actually released.

Time Required to Brake
The time from when the /BK (Brake) signal is turned OFF until the brake actually operates.

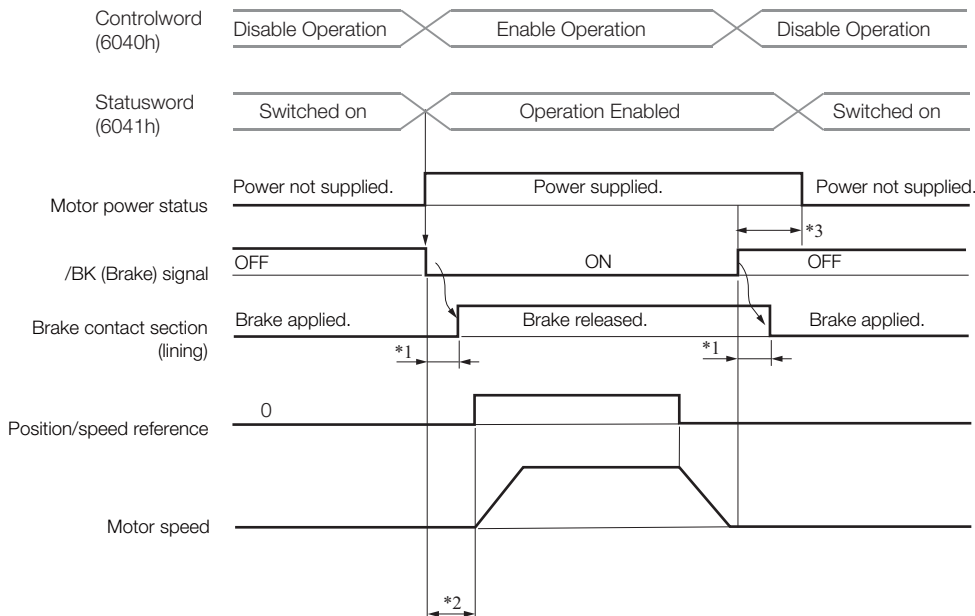

*1. Rotary Servomotors: The brake delay times for Servomotors with Holding Brakes are given in the following table. The operation delay times in the following table are examples for when the power supply is switched on the DC side. You must evaluate the actual brake delay times on the actual equipment before using the application.

Model	Voltage	Time Required to Release Brake [ms]	Time Required to Brake [ms]
SGM7J-02, -04	24 VDC	60	100
SGM7J-08, -15		80	
SGM7A-02, -04		60	
SGM7A-08, -10		80	
SGM7A-15 to -25		170	80
SGM7A-30 to -50		100	
SGM7G-05 to -20		100	
SGM7G-30, -44		170	

Linear Servomotors: The brake delay times depend on the brake that you use. Set the parameters related to /BK signal output timing according to the delay times for the brake that you will actually use.

- *2. Before you output a reference from the host controller to the SERVOPACK, wait for at least 50 ms plus the time required to release the brake after you send the Servo ON command (Enable Operation command).
- *3. Use the following parameters to set the timing of when the brake will operate and when the servo will be turned OFF.
 - Rotary Servomotors: Pn506 (Brake Reference-Servo OFF Delay Time), Pn507 (Brake Reference Output Speed Level), and Pn508 (Servo OFF-Brake Reference Waiting Time)
 - Linear Servomotors: Pn506 (Brake Reference-Servo OFF Delay Time), Pn508 (Servo OFF-Brake Reference Waiting Time), and Pn583 (Brake Reference Output Speed Level)

Note: The brake operation delay time on SERVOPACKs with built-in Servomotor brake control is somewhat longer than the time required on SERVOPACKs without built-in Servomotor brake control. Consider the brake operation delay time when you design the system.

Connection Examples

Refer to the following section for information on brake wiring.

 4.4.4 Wiring the SERVOPACK to the Holding Brake on page 4-28

6.11.2 /BK (Brake) Signal

The following settings are for the output signal that controls the brake. You can change the connector pin that is allocated. For details, refer to *Allocating the /BK (Brake) Signal*.

The /BK signal is turned OFF (to operate the brake) when the servo is turned OFF or when an alarm is detected. You can adjust the timing of brake operation (i.e., the timing of turning OFF the /BK signal) with the servo OFF delay time (Pn506).

Type	Signal	Connector Pin No.	Signal Status	Meaning
Output	/BK	CN1-1, CN1-2	ON (closed)	Releases the brake.
			OFF (open)	Activates the brake.

Information The /BK signal will remain ON during overtravel. The brake will not be applied.

Allocating the /BK (Brake) Signal

Set the allocation for the /BK signal in Pn50F = n.□X□□ (/BK (Brake Output) Signal Allocation).

Parameter	Connector Pin No.		Meaning	When Enabled	Classification	
	+ Pin	- Pin				
Pn50F (250Fh)	n.□0□□	-	-	The /BK signal is not used.	After restart	Setup
	n.□1□□ (default setting)	CN1-1	CN1-2	The /BK signal is output from CN1-1 and CN1-2.		
	n.□2□□	CN1-23	CN1-24	The /BK signal is output from CN1-23 and CN1-24.		
	n.□3□□	CN1-25	CN1-26	The /BK signal is output from CN1-25 and CN1-26.		



Important If you allocate more than one signal to the same output connector pin, a logical OR of the signals is output. Allocate the /BK signal to its own output connector pin, i.e., do not use the same output terminal for another signal. For example, never allocate the /TGON (Rotation Detection) signal and /BK signal to the same output connector pin. If you did so, the /TGON signal would be turned ON by the falling speed on a vertical axis, and the brake would not operate.

6.11.3 Output Timing of /BK (Brake) Signal When the Servomotor Is Stopped

When the Servomotor is stopped, the /BK signal turns OFF as soon as the Servo OFF command (Disable Operation command) is received. Use the servo OFF delay time (Pn506) to change the timing to turn OFF power supply to the motor after the Servo OFF command (Disable Operation command) is input.

Pn506 (2506h)	Brake Reference-Servo OFF Delay Time			Speed	Position	Torque
	Setting Range	Setting Unit	Default Setting	When Enabled	Classification	
	0 to 50	10 ms	0*	Immediately	Setup	

* The default setting is 32 for a SERVOPACK with built-in Servomotor brake control.

- When the Servomotor is used to control a vertical axis, the machine moving part may move slightly due to gravity or an external force. You can eliminate this slight motion by setting the servo OFF delay time (Pn506) so that power supply to the motor is stopped after the brake is applied.
- This parameter sets the timing of stopping power supply to the Servomotor while the Servomotor is stopped.

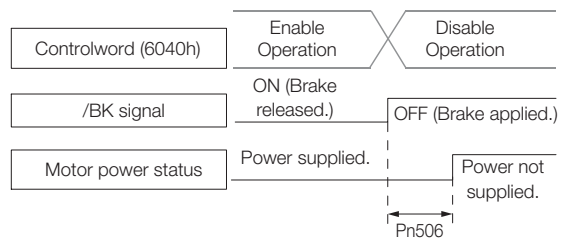



Important Power supply to the Servomotor will be stopped immediately when an alarm occurs, regardless of the setting of this parameter. The machine moving part may move due to gravity or an external force before the brake is applied.

6.11.4 Output Timing of /BK (Brake) Signal When the Servomotor Is Operating

If an alarm occurs while the Servomotor is operating, the Servomotor will start stopping and the /BK signal will be turned OFF. You can adjust the timing of /BK signal output by setting the brake reference output speed level (Rotary Servomotors: Pn507, Linear Servomotors: Pn583) and the servo OFF-brake reference waiting time (Pn508).

Note: If zero-speed stopping is set as the stopping method for alarms, the setting of Pn506 (Brake Reference-Servo OFF Delay Time) is used after the motor stops.

- Rotary Servomotors

Pn507 (2507h)	Brake Reference Output Speed Level			Speed	Position	Torque
	Setting Range	Setting Unit	Default Setting	When Enabled	Classification	
	0 to 10,000	1 min ⁻¹	100	Immediately	Setup	

Pn508 (2508h)	Servo OFF-Brake Reference Waiting Time			Speed	Position	Torque
	Setting Range	Setting Unit	Default Setting	When Enabled	Classification	
	10 to 100	10 ms	50	Immediately	Setup	

- Linear Servomotors

Pn583 (2583h)	Brake Reference Output Speed Level			Speed	Position	Force
	Setting Range	Setting Unit	Default Setting	When Enabled	Classification	
	0 to 10,000	1 mm/s	10	Immediately	Setup	

Pn508 (2508h)	Servo OFF-Brake Reference Waiting Time			Speed	Position	Force
	Setting Range	Setting Unit	Default Setting	When Enabled	Classification	
	10 to 100	10 ms	50	Immediately	Setup	

The brake operates when either of the following conditions is satisfied:

- When the Motor Speed Goes below the Level Set in Pn507 for a Rotary Servomotor or in Pn583 for a Linear Servomotor after the Power Supply to the Motor Is Stopped

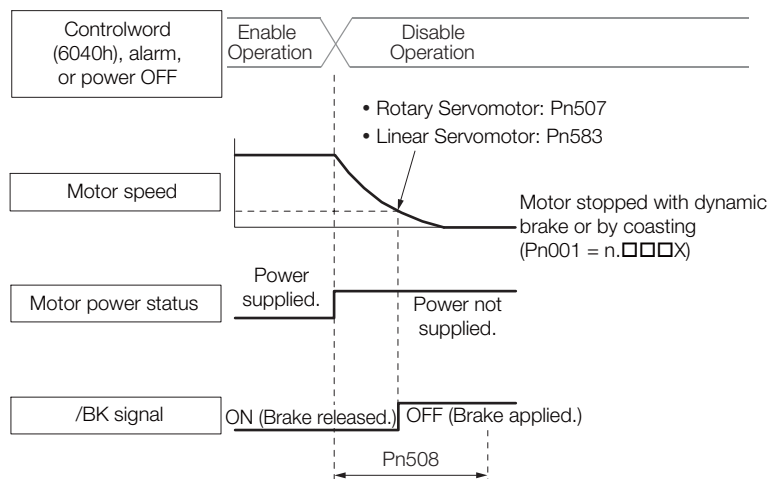

6.11.5 Built-in Brake Relay Usage Selection

- When the Time Set In Pn508 Elapses after the Power Supply to the Motor Is Stopped

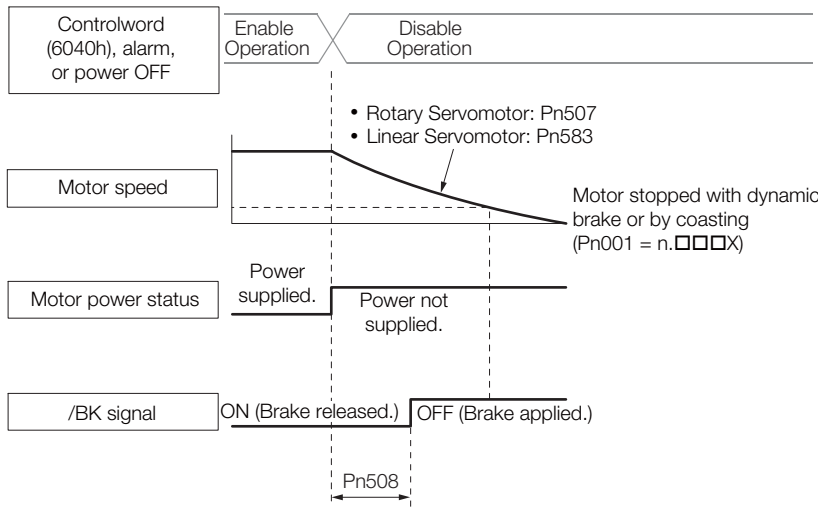

The Servomotor will be limited to its maximum speed even if the brake reference output speed level (Rotary Servomotor: Pn507, Linear Servomotor: Pn583) is higher than the maximum speed.

6.11.5 Built-in Brake Relay Usage Selection

SERVOPACKs with built-in brake control contain a brake relay.

Set Pn023 = n.□□□X (Built-in Brake Relay Usage Selection) to specify whether to use the built-in brake relays.

Parameter	Description	When Enabled	Classification
Pn023 (2023h)	n.□□□0 (default setting)	After restart	Setup
	n.□□□1		

You can use Pn023 = n.□□X□ (Built-in Brake Relay Life Alarm Enable Selection) to select whether to detect or not detect the built-in brake relay life alarm (alarm code: 232h). Refer to the following section for details.

10.4.3 Preventative Maintenance on page 10-15

6.12 Motor Stopping Methods for Servo OFF and Alarms

You can use the following methods to stop the Servomotor when the servo is turned OFF or an alarm occurs.

There are the following four stopping methods.

Motor Stopping Method	Meaning
Stopping by Applying the Dynamic Brake	The electric circuits are internally connected to stop the Servomotor quickly.
Coasting to a Stop	The motor stops naturally due to friction during operation.
Zero Clamping	The speed reference is set to 0 to stop the Servomotor quickly.
Decelerating to a Stop	Emergency stop torque is used to decelerate the motor to a stop.

There are the following three conditions after stopping.

Status after Stopping	Meaning
Dynamic Brake Applied	The electric circuits are internally connected to hold the Servomotor.
Coasting	The SERVOPACK does not control the Servomotor. (The machine will move in response to a force from the load.)
Zero Clamping	A position loop is created and the Servomotor remains stopped at a position reference of 0. (The current stop position is held.)



Important

- The dynamic brake is used for emergency stops. The dynamic brake circuit will operate frequently if the power supply is turned ON and OFF or the servo is turned ON and OFF while a reference input is applied to start and stop the Servomotor. This may result in deterioration of the internal elements in the SERVOPACK. Use speed input references or position references to start and stop the Servomotor.
- If you turn OFF the main circuit power supply or control power supply during operation before you turn OFF the servo, the Servomotor stopping method depends on the SERVOPACK model as shown in the following table.

Condition	Servomotor Stopping Method	
	SGD7S-1R9D, -3R5D, -5R4D, -8R4D, -120D, or -170D	SGD7S-210D, -260D, -280D, or -370D
Main circuit power supply turned OFF before turning OFF the servo	Stopping with dynamic brake	Coasting to a stop
Control power supply turned OFF before turning OFF the servo		

Note: The SGD7S-210D, -260D, -280D, and -370D do not have a built-in dynamic brake. They will always coast to a stop. To perform dynamic braking, you must create the dynamic brake circuit. Refer to the following chapter for details on the dynamic brake circuit.

 [Chapter 5 Wiring and Settings for the Dynamic Brake](#)

- To minimize the coasting distance of the Servomotor to come to a stop when an alarm occurs, zero-speed stopping is the default method for alarms to which it is applicable. However, depending on the application, stopping with the dynamic brake may be more suitable than zero-speed stopping.
For example, when coupling two shafts (twin-drive operation), machine damage may occur if a zero-speed stopping alarm occurs for one of the coupled shafts and the other shaft stops with a dynamic brake. In such cases, change the stopping method to the dynamic brake.

6.12.1 Stopping Method for Servo OFF

Set the stopping method for when the servo is turned OFF in Pn001 = n.□□□X (Servo OFF or Alarm Group 1 Stopping Method).

To use the dynamic brake to stop the motor, set Pn001 to n.□□□0 or n.□□□1.

If you do not connect an external dynamic brake, set Pn001 to n.□□□2 (Coast the motor to a stop without the dynamic brake).

Parameter		Servomotor Stopping Method	Status after Servomotor Stops	When Enabled	Classification
Pn001 (2001h)	n.□□□0 (default setting)	Dynamic brake *	Dynamic brake *	After restart	Setup
	n.□□□1		Coasting		
	n.□□□2	Coasting	Coasting		

* The Servomotor will coast to a stop when the SERVOPACK is not equipped with a built-in Dynamic Brake Resistor or an External Dynamic Brake Resistor is not connected.

Note: If Pn001 is set to n.□□□0 (Stop the motor by applying the dynamic brake) and the Servomotor is stopped or operates at a low speed, braking force may not be generated, just like it is not generated for coasting to a stop.



Important

When connecting an external dynamic brake circuit to SGD7S-210D, -260D, -280D, and -370D SERVOPACKs, set the /DBANS (Dynamic Brake Answer Input) and /DBON (Dynamic Brake Operation Request Output) signals regardless of the setting of Pn001 = n.□□□X. The A.F30 (Dynamic Brake Circuit Error) alarm will occur if the /DBANS and /DBON signals are not connected to I/O signal terminals.

6.12.2 Servomotor Stopping Method for Alarms

There are two types of alarms, group 1 (Gr. 1) alarms and group 2 (Gr. 2) alarms. A different parameter is used to set the stopping method for alarms for each alarm type.

Refer to the following section to see which alarms are in group 1 and which are in group 2.

 16.2.1 List of Alarms on page 16-5

Motor Stopping Method for Group 1 Alarms

When a group 1 alarm occurs, the Servomotor will stop according to the setting of Pn001 = n.□□□X. The default setting is to stop by applying the dynamic brake.

Refer to the following section for details.

 6.12.1 Stopping Method for Servo OFF on page 6-38

Motor Stopping Method for Group 2 Alarms

When a group 2 alarm occurs, the Servomotor will stop according to the settings of the following three parameters. The default setting is for zero clamping.



- Pn001 = n.□□□X (Servo OFF or Alarm Group 1 Stopping Method)
- Pn00A = n.□□□X (Motor Stopping Method for Group 2 Alarms)
- Pn00B = n.□□X□ (Motor Stopping Method for Group 2 Alarms)

However, during torque control, the group 1 stopping method is always used.

If you set Pn00B to n.□□1□ (Apply dynamic brake or coast Servomotor to a stop), you can use the same stopping method as group 1. If you are coordinating a number of Servomotors, you can use this stopping method to prevent machine damage that may result because of differences in the stopping method.

The following table shows the combinations of the parameter settings and the resulting stopping methods.

Parameter			Servomotor Stopping Method	Status after Servomotor Stops	When Enabled	Classification
Pn00B (200Bh)	Pn00A (200Ah)	Pn001 (2001h)				
n.□□□□ (default setting)	-	n.□□□□0 (default setting)	Zero-speed stopping	Dynamic brake	After restart	Setup
		n.□□□□1		Coasting		
		n.□□□□2				
n.□□□□□	-	n.□□□□0 (default setting)	Dynamic brake	Dynamic brake		
		n.□□□□1	Coasting	Coasting		
		n.□□□□2	Coasting			
n.□□□□□	n.□□□□0 (default setting)	n.□□□□0 (default setting)	Dynamic brake	Dynamic brake		
		n.□□□□1		Coasting		
		n.□□□□2	Coasting			
	n.□□□□1	-	n.□□□□0 (default setting)	Motor is decelerated using the torque set in Pn406 (2406h) as the maximum torque.		
			n.□□□□1		Coasting	
			n.□□□□2		Coasting	
	n.□□□□2	-	n.□□□□0 (default setting)		Coasting	
			n.□□□□1			
			n.□□□□2			
	n.□□□□3	-	n.□□□□0 (default setting)	Motor is decelerated according to setting of Pn30A (230Ah).	Dynamic brake	
			n.□□□□1		Coasting	
			n.□□□□2		Coasting	
n.□□□□4	-	n.□□□□0 (default setting)	Coasting			
		n.□□□□1				
		n.□□□□2				

- Note: 1. The setting of Pn00A is ignored if Pn001 is set to n.□□□□□ or n.□□□□□.
2. The setting of Pn00A = n.□□□□X is enabled for position control and speed control. During torque control, the setting of Pn00A = n.□□□□X will be ignored and only the setting of Pn001 = n.□□□□X will be used.
3. Refer to the following section for details on Pn406 (Emergency Stop Torque).
 *Stopping the Servomotor by Setting Emergency Stop Torque on page 6-28*
4. Refer to the following section for details on Pn30A (Deceleration Time for Servo OFF and Forced Stops).
 *Stopping the Servomotor by Setting the Deceleration Time on page 6-28*

6.13 Motor Overload Detection Level

The motor overload detection level is the threshold used to detect overload alarms and overload warnings when the Servomotor is subjected to a continuous load that exceeds the Servomotor ratings.

It is designed to prevent Servomotor overheating.

You can change the detection timing for A.910 warnings (Overload) and A.720 alarms (Continuous Overload). You cannot change the detection level for A.710 alarms (Instantaneous Overload).

6.13.1 Detection Timing for Overload Warnings (A.910)

With the default setting for overload warnings, an overload warning is detected in 20% of the time required to detect an overload alarm. You can change the time required to detect an overload warning by changing the setting of the overload warning level (Pn52B). You can increase safety by using overload warning detection as an overload protection function matched to the system.

The following graph shows an example of the detection of overload warnings when the overload warning level (Pn52B) is changed from 20% to 50%. An overload warning is detected in half of the time required to detect an overload alarm.

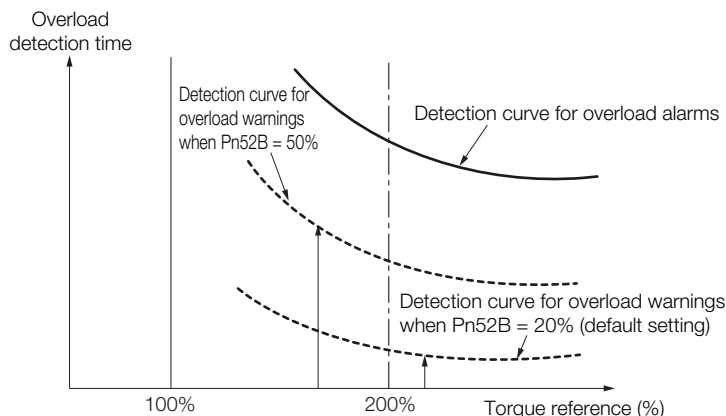

Pn52B (252Bh)	Overload Warning Level			Speed	Position	Torque
	Setting Range	Setting Unit	Default Setting	When Enabled	Classification	
	1 to 100	1%	20	Immediately	Setup	

6.13.2 Detection Timing for Overload Alarms (A.720)

If Servomotor heat dissipation is insufficient (e.g., if the heat sink is too small), you can lower the overload alarm detection level to help prevent overheating.

To reduce the overload alarm detection level, change the setting of Pn52C (Base Current Derating at Motor Overload Detection).

Pn52C (252Ch)	Base Current Derating at Motor Overload Detection			Speed	Position	Torque
	Setting Range	Setting Unit	Default Setting	When Enabled	Classification	
	10 to 100	1%	100	After restart	Setup	

An A.720 alarm (Continuous Overload) can be detected earlier to protect the Servomotor from overloading.

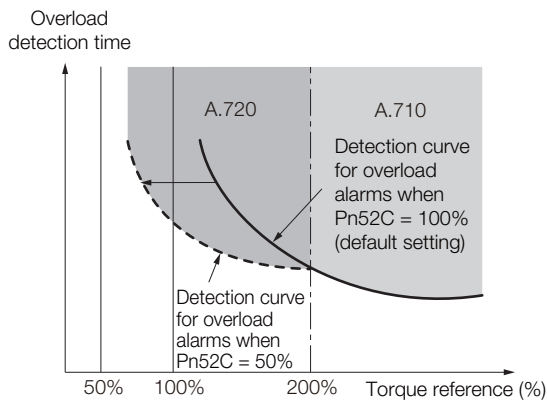

Note: The gray areas in the above graph show where A.710 and A.720 alarms occur.

Refer to the relevant manual given below for a diagram that shows the relationships between the motor heat dissipation conditions (heat sink size, surrounding air temperature, and derating). You can protect the motor from overloads more effectively by setting this derating value in Pn52C.

📖 Σ -7-Series Rotary Servomotor with 400 V-Input Power Product Manual (Manual No.: SIEP S800001 86)

📖 Σ -7-Series Linear Servomotor with 400 V-Input Power Product Manual (Manual No.: SIEP S800001 81)

6.14 Setting Unit Systems

You can set the SERVOPACK reference units with EtherCAT (CoE) communications. You can set the following four reference units with EtherCAT communications.

- Position reference unit
- Speed reference unit
- Acceleration reference unit
- Torque reference unit

The setting procedures are given below.

6.14.1 Setting the Position Reference Unit

Set the position reference unit in *position user unit* (2701h). The position reference unit setting will be used for the electronic gear ratio setting.



Important

- For a Rotary Servomotor with an encoder resolution of 24 bits (16,777,216), Pn20E (Electronic Gear Ratio (Numerator)) is automatically set to 16 and Pn210 (Electronic Gear Ratio (Denominator)) is automatically set to 1. Therefore, the encoder resolution will be equivalent to 20 bits (1,048,576). Consider this when you set the position reference unit in *position user unit* (2701h).
- Set the position reference unit within the following range.
 $1/4,096 < \text{Numerator/Denominator} < 65,536$
 If the setting range is exceeded, an A.A20 alarm (Parameter Setting Error) will occur.

Index	Sub-index	Name	Data Type	Access	PDO Mappings	Value	Saving to EEPROM
2701h	0	Number of entries	USINT	RO	No	2	No
	1	Numerator	UDINT	RW	No	1 to 1,073,741,823 (default: 1)	Yes
	2	Denominator	UDINT	RW	No	1 to 1,073,741,823 (default: 1)	Yes

Note: Refer to the following section for information on *position user unit* (2701h).
 *Position User Unit (2701h)* on page 15-17

The minimum unit of the position data that is used to move a load is called the reference unit. The reference unit is used to give travel amounts, not in pulses, but rather in distances or other physical units (such as μm or $^\circ$) that are easier to understand.

The electronic gear is used to convert the travel distances that are specified in reference units to pulses, which are required for actual movements.

With the electronic gear, one reference unit is equal to the workpiece travel distance per reference pulse input to the SERVOPACK. In other words, if you use the SERVOPACK's electronic gear, pulses can be read as reference units.

The difference between using and not using the electronic gear is shown below.

• Rotary Servomotors

In this example, the following machine configuration is used to move the workpiece 10 mm.

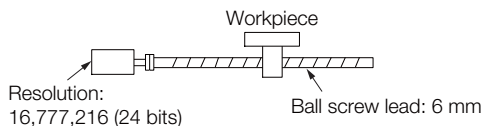

When the Electronic Gear Is Not Used

To move a workpiece 10 mm:
 ① Calculate the number of revolutions.
 The motor will move 6 mm for each revolution, so 10/6 revolutions are required to move 10 mm.
 ② Calculate the required number of reference pulses.
 One revolution is 1,048,576 pulses, therefore $10/6 \times 1,048,576 = 1,747,626.66$ pulses.
 ③ Input 1,747,627 pulses as the reference.

Calculating the number of reference pulses for each reference is troublesome.

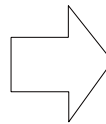

When the Electronic Gear Is Used

If you use reference units to move the workpiece when one reference unit is set to 1 μm, the travel distance is 1 μm per pulse.
 To move the workpiece 10 mm (10,000 μm), $10,000 \div 1 = 10,000$ pulses, so 10,000 pulses would be input.

Calculating the number of reference pulses for each reference is not necessary.

• Linear Servomotors

In this example, the following machine configuration is used to move the load 10 mm. We'll assume that the resolution of the Serial Converter Unit is 256 and that the linear encoder pitch is 20 μm.

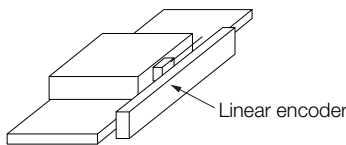

When the Electronic Gear Is Not Used

To move the load 10 mm:
 $10 \times 1000 \div 20 \times 256 = 128,000$ pulses, so 128,000 pulses are input as the reference.

Calculating the number of reference pulses for each reference is troublesome.

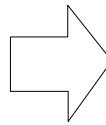

When the Electronic Gear Is Used

To use reference units to move the load 10 mm:
 If we set the reference unit to 1 μm, the travel distance is 1 μm per pulse. To move the load 10 mm (10,000 μm), $10,000/1 = 10,000$ pulses, so 10,000 pulses would be input as the reference.

Calculating the number of reference pulses for each reference is not necessary.

Calculating the Settings for the Electronic Gear Ratio

◆ Rotary Servomotors

If the gear ratio between the Servomotor shaft and the load is given as n/m, where n is the number of load rotations for m Servomotor shaft rotations, the settings for the electronic gear ratio can be calculated as follows:

$$\text{Electronic gear ratio } \frac{B}{A} = \frac{\text{Numerator}}{\text{Denominator}} = \frac{\text{Encoder resolution}}{\text{Travel distance per load shaft revolution (reference units)}} \times \frac{m}{n}$$

Information For a Rotary Servomotor with an encoder resolution of 24 bits (16,777,216), Pn20E (Electronic Gear Ratio (Numerator)) is automatically set to 16 and Pn210 (Electronic Gear Ratio (Denominator)) is automatically set to 1. Therefore, the encoder resolution will be equivalent to 20 bits (1,048,576). Consider this when you set the position reference unit in *position user unit* (2701h).

■ Encoder Resolution

You can check the encoder resolution in the Servomotor model number.

SGM7J, SGM7A,
 or SGM7G - □□□□□□

Code	Specification	Encoder Resolution
7	24-bit multiturn absolute encoder	16,777,216
F	24-bit incremental encoder	16,777,216

◆ Linear Servomotors

You can calculate the settings for the electronic gear ratio with the following equation:

When Not Using a Serial Converter Unit

Use the following formula if the linear encoder and SERVOPACK are connected directly or if a linear encoder that does not require a Serial Converter Unit is used.

$$\text{Electronic gear ratio } \frac{B}{A} = \frac{\text{Numerator}}{\text{Denominator}} = \frac{\text{Travel distance per reference unit (reference units)} \times \text{Linear encoder resolution}}{\text{Linear encoder pitch (the value from the following table)}}$$

When Using a Serial Converter Unit

$$\text{Electronic gear ratio } \frac{B}{A} = \frac{\text{Numerator}}{\text{Denominator}} = \frac{\text{Travel distance per reference unit (reference units)} \times \text{Resolution of the Serial Converter Unit}}{\text{Linear encoder pitch (setting of Pn282)}}$$

■ Feedback Resolution of Linear Encoder

The linear encoder pitches and resolutions are given in the following table.

Calculate the electronic gear ratio using the values in the following table.

Type of Linear Encoder	Manufacturer	Linear Encoder Model	Linear Encoder Pitch [μm] ^{*1}	Relay Device Model between SERVOPACK and Linear Encoder	Resolution	Resolution
Incremental	Dr. JOHANNES HEIDENHAIN GmbH	LIDA48□	20	JZDP-H003-□□□-E ^{*2}	256	0.078 μm
				JZDP-J003-□□□-E ^{*2}	4,096	0.0049 μm
		LIF48□	4	JZDP-H003-□□□-E ^{*2}	256	0.016 μm
				JZDP-J003-□□□-E ^{*2}	4,096	0.00098 μm
	Renishaw PLC	RGH22B	20	JZDP-H005-□□□-E ^{*2}	256	0.078 μm
				JZDP-J005-□□□-E ^{*2}	4,096	0.0049 μm
	Magnescale Co., Ltd.	SR75-□□□□□LF ^{*3}	80	–	8,192	0.0098 μm
				–	1,024	0.078 μm
				–	8,192	0.0098 μm
				–	1,024	0.078 μm
		SL700 ^{*3} , SL710 ^{*3} , SL720 ^{*3} , SL730 ^{*3}	800	PL101-RY ^{*4}	8,192	0.0977 μm
				MJ620-T13 ^{*5}		
	SQ10	400	MQ10-FLA ^{*5}	8,192	0.0488 μm	
			MQ10-GLA ^{*5}			
	Canon Precision Inc.	PH03-36110	128	–	2,048	0.0625 μm
				PH03-36120	128	2,048
Absolute	Dr. JOHANNES HEIDENHAIN GmbH	LIC4100 Series ^{*6}	20.48	EIB3391Y ^{*7}	4,096	0.005 μm
		LIC2100 Series ^{*6}	204.8	EIB3391Y ^{*7}	4,096	0.05 μm
			409.6	EIB3391Y ^{*7}	4,096	0.1 μm
		LIC4190 Series	40.96	–	4,096	0.01 μm
			20.48	–	4,096	0.005 μm
		LIC3190 Series	4.096	–	4,096	0.001 μm
			40.96	–	4,096	0.01 μm
		LIC2190 Series	409.6	–	4,096	0.1 μm
			204.8	–	4,096	0.05 μm
		LC115	40.96	EIB3391Y ^{*7}	4,096	0.01 μm
		LC415	40.96	EIB3391Y ^{*7}	4,096	0.01 μm
		RSF Elektronik GmbH	MC15Y Series	409.6	–	4,096
	204.8			–	4,096	0.05 μm

Continued on next page.

Continued from previous page.

Type of Linear Encoder	Manufacturer	Linear Encoder Model	Linear Encoder Pitch [μm] ^{*1}	Relay Device Model between SERVOPACK and Linear Encoder	Resolution	Resolution
Absolute	Mitutoyo Corporation	ST781A/ST781AL	256	–	512	0.5 μm
		ST782A/ST782AL	256	–	512	0.5 μm
		ST783/ST783AL	51.2	–	512	0.1 μm
		ST784/ST784AL	51.2	–	512	0.1 μm
		ST788A/ST788AL	51.2	–	512	0.1 μm
		ST789A/ST789AL	25.6	–	512	0.05 μm
		ST1381	5.12	–	512	0.01 μm
		ST1382	0.512	–	512	0.001 μm
	Renishaw PLC	EL36Y□□050F□□□	12.8	–	256	0.05 μm
		EL36Y□□100F□□□	25.6	–	256	0.1 μm
		EL36Y□□500F□□□	128	–	256	0.5 μm
		RL36Y□□050□□□□	12.8	–	256	0.05 μm
		RL36Y□□001□□□□	0.256	–	256	0.001 μm
	RLS d.o.o.	LA11YA Series	2,000	–	2,048	0.9765 μm
			2,000	–	4,096	0.4882 μm
			2,000	–	8,192	0.2441 μm
	Magnescale Co., Ltd.	SR77-□□□□□LF ^{*3}	80	–	8,192	0.0098 μm
		SR77-□□□□□MF	80	–	1,024	0.078 μm
		SR87-□□□□□LF ^{*3}	80	–	8,192	0.0098 μm
		SR87-□□□□□MF	80	–	1,024	0.078 μm
		SQ47/SQ57-□□□□□SF□□□	20.48	–	4,096	0.005 μm
		SQ47/SQ57-□□□□□TF□□□	20.48	–	4,096	0.005 μm
	SQ47/SQ57-□□□□□AF□□□	40.96	–	4,096	0.01 μm	
	SQ47/SQ57-□□□□□FF□□□	40.96	–	4,096	0.01 μm	
	Fagor Automation S. Coop.	L2AK208	20	–	256	0.078 μm
		L2AK211	20	–	2,048	0.0098 μm
		LAK209	40	–	512	0.078 μm
		LAK212	40	–	4,096	0.0098 μm
		S2AK208	20	–	256	0.078 μm
		SV2AK208	20	–	256	0.078 μm
		G2AK208	20	–	256	0.078 μm
		S2AK211	20	–	2,048	0.0098 μm
		SV2AK211	20	–	2,048	0.0098 μm
G2AK211		20	–	2,048	0.0098 μm	
Canon Precision Inc.	PH03-36E00	128	–	2,048	0.0625 μm	

*1. These are reference values for setting SERVOPACK parameters. Contact the manufacturer for actual linear encoder scale pitches.

*2. This is the model of the Serial Converter Unit.

*3. If you use an encoder pulse output with this linear encoder, the setting range of the encoder output resolution (Pn281) is restricted. Refer to the following section for details on the encoder output resolution (Pn281).

 7.5.2 Setting for the Encoder Divided Pulse Output on page 7-23

*4. This is the model of the Head with Interpolator.

*5. This is the model of the Interpolator.

*6. Sales of the interface unit EIB3391Y with the LIC4100 and LIC2100 series have ended due to the release of the LIC4190, LIC3190, and LIC2190 series.

*7. This is the model of the Interface Unit.

Information

Resolution

You can calculate the resolution that is used inside the SERVOPACK (i.e., the travel distance per feedback pulse) with the following formula.

$$\text{Resolution (travel distance per feedback pulse)} = \frac{\text{Linear encoder pitch}}{\text{Resolution of Serial Converter Unit or linear encoder}}$$

The SERVOPACK uses feedback pulses as the unit to control a Servomotor.

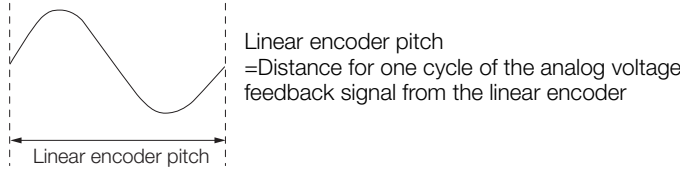

Electronic Gear Ratio Setting Examples

Setting examples are provided in this section.

- Rotary Servomotors

Step	Description	Machine Configuration		
		Ball Screw	Rotary Table	Belt and Pulley
		<p>Reference unit: 0.001 mm Load shaft Encoder: 24 bits Ball screw lead: 6 mm</p>	<p>Reference unit: 0.01° Gear ratio: 1/100 Encoder: 24 bits</p>	<p>Reference unit: 0.005 mm Load shaft Gear ratio: 1/50 Pulley dia.: 100 mm Encoder: 24 bits</p>
1	Machine Specifications	<ul style="list-style-type: none"> • Ball screw lead: 6 mm • Gear ratio: 1/1 	<ul style="list-style-type: none"> • Rotation angle per revolution: 360° • Gear ratio: 1/100 	<ul style="list-style-type: none"> • Pulley dia.: 100 mm (Pulley circumference: 314 mm) • Gear ratio: 1/50
2	Encoder Resolution	16,777,216 (24 bits)	16,777,216 (24 bits)	16,777,216 (24 bits)
3	Reference Unit	0.001 mm (1 μm)	0.01°	0.005 mm (5 μm)
4	Travel Distance per Load Shaft Revolution (Reference Units)	6 mm/0.001 mm = 6,000	360°/0.01° = 36,000	314 mm/0.005 mm = 62,800
5	Electronic Gear Ratio*	$\frac{B}{A} = \frac{16,777,216}{6,000} \times \frac{1}{16} \times \frac{1}{1}$	$\frac{B}{A} = \frac{16,777,216}{36,000} \times \frac{1}{16} \times \frac{100}{1}$	$\frac{B}{A} = \frac{16,777,216}{36,000} \times \frac{1}{16} \times \frac{50}{1}$
6	Position User Unit (2701h)	Numerator: 1,048,576	Numerator: 104,857,600	Numerator: 52,428,800
		Denominator: 6,000	Denominator: 36,000	Denominator: 62,800

* For a Rotary Servomotor with an encoder resolution of 24 bits (16,777,216), Pn20E (Electronic Gear Ratio (Numerator)) is automatically set to 16 and Pn210 (Electronic Gear Ratio (Denominator)) is automatically set to 1. Therefore, the encoder resolution will be equivalent to 20 bits (1,048,576). Consider this when you set the position reference unit in *position user unit* (2701h).

- Linear Servomotors

A setting example for a Serial Converter Unit resolution of 256 is given below.

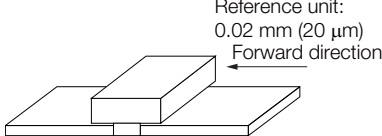
Step	Description	Machine Configuration
		 <p>Reference unit: 0.02 mm (20 μm) Forward direction</p>
1	Linear Encoder Pitch	0.02 mm (20 μm)
2	Reference Unit	0.001 mm (1 μm)
3	Electronic Gear Ratio*	$\frac{B}{A} = \frac{1 (\mu\text{m})}{20 (\mu\text{m})} \times \frac{1}{1}$
4	Position User Unit (2701h)	Numerator: 256
		Denominator: 20

* For a Linear Servomotor, both Pn20E (Electronic Gear Ratio (Numerator)) and Pn210 (Electronic Gear Ratio (Denominator)) are automatically set to 1. Consider this when you set the position reference unit in *position user unit* (2701h).

6.14.2 Setting the Speed Reference Unit

Set the speed reference unit [Vel Unit] in *velocity user unit* (2702h).



Important

For a Rotary Servomotor with an encoder resolution of 24 bits (16,777,216), Pn20E (Electronic Gear Ratio (Numerator)) is automatically set to 16 and Pn210 (Electronic Gear Ratio (Denominator)) is automatically set to 1. Therefore, the encoder resolution will be equivalent to 20 bits (1,048,576). Consider this when you set the position reference unit in *position user unit* (2701h).

Index	Sub-index	Name	Data Type	Access	PDO Mappings	Value	Saving to EEPROM
2702h	0	Number of entries	USINT	RO	No	2	No
	1	Numerator	UDINT	RW	No	1 to 1,073,741,823 (default: 1)	Yes
	2	Denominator	UDINT	RW	No	1 to 1,073,741,823 (default: 1)	Yes

Setting range: $1/128 \leq \text{Numerator/Denominator} \leq 8,388,608$

(Alarm A.A20 will be detected if the setting exceeds the setting range.)

Example

Speed Reference Unit Setting Example (Electronic Gear Ratio Setting Example for a Ball Screw)

- Velocity User Unit (2702h)

Converting one user-defined velocity reference unit [0.1 mm/s] into [inc/s]:

$$\begin{aligned}
 & 1 \text{ [Vel unit]} \\
 &= \frac{16,777,216 \text{ [inc]} \times (1/16)}{6 \text{ [mm]}} \times 0.1 \text{ [mm/s]} \\
 &= \frac{1,048,576}{60} \text{ [inc/s]}
 \end{aligned}$$

Therefore, the objects are set as follows:

Object 2702h: 01 (Numerator) = 1,048,576

Object 2702h: 02 (Denominator) = 60

6.14.3 Setting the Acceleration Reference Unit

Set the acceleration reference unit [Acc Unit] in *acceleration user unit* (2703h).



For a Rotary Servomotor with an encoder resolution of 24 bits (16,777,216), Pn20E (Electronic Gear Ratio (Numerator)) is automatically set to 16 and Pn210 (Electronic Gear Ratio (Denominator)) is automatically set to 1. Therefore, the encoder resolution will be equivalent to 20 bits (1,048,576). Consider this when you set the position reference unit in *position user unit* (2701h).

Index	Sub-index	Name	Data Type	Access	PDO Mappings	Value	Saving to EEPROM
2703h	0	Number of entries	USINT	RO	No	2	No
	1	Numerator	UDINT	RW	No	1 to 1,073,741,823 (default: 1)	Yes
	2	Denominator	UDINT	RW	No	1 to 1,073,741,823 (default: 1)	Yes

Setting range: $1/128 \leq \text{Numerator/Denominator} \leq 262,144$

(Alarm A.A20 will be detected if the setting exceeds the setting range.)

Example Acceleration Reference Unit Setting Example (Electronic Gear Ratio Setting Example for a Ball Screw)

- Acceleration User Unit (2703h)

Converting one user-defined acceleration reference unit [0.1 mm/s²] into [10⁴ inc/s²]:

$$\begin{aligned}
 & 1 \text{ [Acc unit]} \\
 &= \frac{16,777,216 \text{ [inc]} \times (1/16)}{6 \text{ [mm]}} \times 0.1 \text{ [mm/s}^2\text{]} \times 10^{-4} \\
 &= \frac{1,048,576}{6 \times 10^5} \text{ [10}^4 \text{ inc/s}^2\text{]}
 \end{aligned}$$

Therefore, the objects are set as follows:

Object 2703h: 01 (Numerator) = 1,048,576

Object 2703h: 02 (Denominator) = 600,000

6.14.4 Setting the Torque Reference Unit

Set the torque reference unit [Torque Unit] in *torque user unit* (2704h).

Index	Sub-index	Name	Data Type	Access	PDO Mappings	Value	Saving to EEPROM
2704h	0	Number of entries	USINT	RO	No	2	No
	1	Numerator	UDINT	RW	No	1 to 1,073,741,823 (default: 1)	Yes
	2	Denominator	UDINT	RW	No	1 to 1,073,741,823 (default: 10)	Yes

Setting range: $1/256 \leq \text{Numerator/Denominator} \leq 1$

(Alarm A.A20 will be detected if the setting exceeds the setting range.)

6.14.5 Setting the Encoder Resolution

If you use an SGM7J, SGM7A, or SGM7G Servomotor, you can set the resolution of the encoder to 20 bits or 24 bits.

Set the encoder resolution in *encoder selection* (2705h).

Index	Sub-index	Name	Data Type	Access	PDO Mappings	Value	Saving to EEPROM
2705h	0	Encoder Selection	USINT	RW	No	0000h (20 bits), 0001h (24 bits) (default: 0000h)	Yes

6.15 Resetting the Absolute Encoder

In a system that uses an absolute encoder, the multiturn data must be reset at startup. An alarm related to the absolute encoder (A.810 or A.820) will occur when the absolute encoder must be reset, such as when the power supply is turned ON.

When you reset the absolute encoder, the multiturn data is reset and any alarms related to the absolute encoder are cleared.

Reset the absolute encoder in the following cases.

- When an A.810 alarm (Encoder Backup Alarm) occurs
- When an A.820 alarm (Encoder Checksum Alarm) occurs
- When starting the system for the first time
- When you want to reset the multiturn data in the absolute encoder
- When the Servomotor has been replaced

CAUTION

- The multiturn data will be reset to a value between -2 and +2 rotations when the absolute encoder is reset. The reference position of the machine system will change. Adjust the reference position in the host controller to the position that results from resetting the absolute encoder.
If the machine is started without adjusting the position in the host controller, unexpected operation may cause personal injury or damage to the machine.

Information

When the encoder is set to be used as a single-turn absolute encoder (Pn002 = n.□2□□), the multiturn data will always be zero. It is not necessary to reset the absolute encoder. Also, an alarm related to the absolute encoder (A.810 or A.820) will not occur.

6.15.1 Precautions on Resetting

- You cannot use the ALM_CLR (Clear Alarm) command from the SERVOPACK to clear the A.810 alarm (Encoder Backup Alarm) or the A.820 alarm (Encoder Checksum Alarm). Always use the operation to reset the absolute encoder to clear these alarms.
- If an A.8□□ alarm (Internal Encoder Monitoring Alarm) occurs, turn OFF the power supply to reset the alarm.



6.15.2 Preparations

Always check the following before you reset an absolute encoder.

- The parameters must not be write prohibited.
- The servo must be OFF.

6.15.3 Applicable Tools

The following table lists the tools that you can use to reset the absolute encoder.

Tool	Fn No./Function Name	Reference
Digital Operator	Fn008	 Σ -7-Series Digital Operator Operating Manual (Manual No.: SIEP S800001 33)
SigmaWin+	Encoder Setting - Reset Absolute Encoder	 6.15.4 Operating Procedure on page 6-50
EtherCAT (CoE) communications	SERVOPACK Adjusting Command (2710h)	 <i>SERVOPACK Adjusting Command (2710h)</i> on page 15-19

6.15.4 Operating Procedure

Use the following procedure to reset the absolute encoder.

1. Confirm that the servo is OFF.
2. Click the  Servo Drive Button in the workspace of the Main Window of the SigmaWin+.
3. Select **Absolute Encoder Reset** in the Menu Dialog Box.
The Absolute Encoder Reset Dialog Box will be displayed.
4. Click the **Continue** Button.

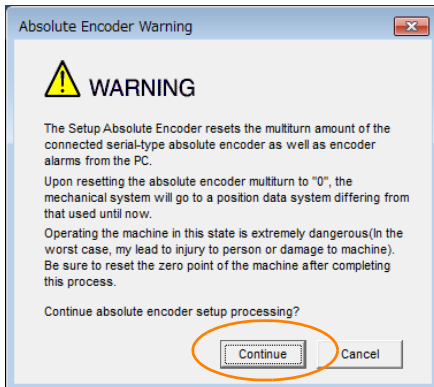

Click the **Cancel** Button to cancel resetting the absolute encoder. The Main Window will return.

5. Click the **Execute setting** Button.

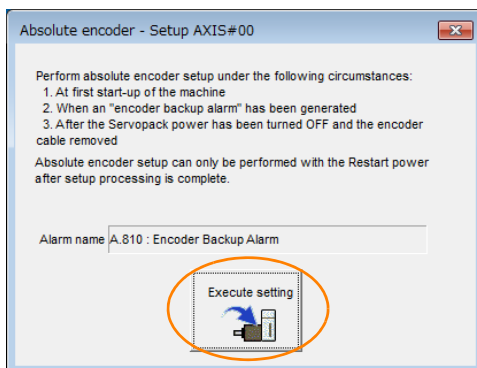

The current alarm code and name will be displayed in the **Alarm name** Box.

6. Click the **Continue** Button.

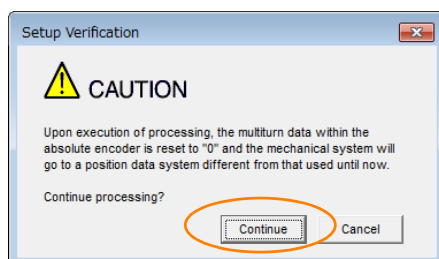

Click the **Cancel** Button to cancel resetting the absolute encoder. The previous dialog box will return.

7. Click the OK Button.

The absolute encoder will be reset.

When Resetting Fails

If you attempted to reset the absolute encoder when the servo was ON in the SERVOPACK, the following dialog box will be displayed and processing will be canceled.

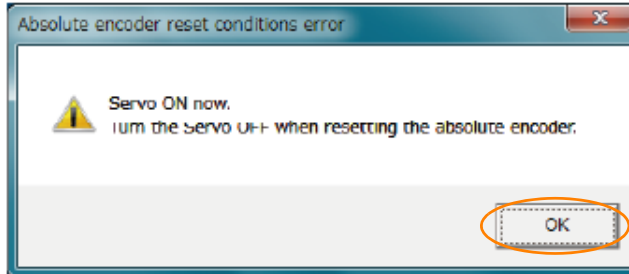

Click the **OK** Button. The Main Window will return. Turn OFF the servo and repeat the procedure from step 1.

When Resetting Is Successful

The following dialog box will be displayed when the absolute encoder has been reset.

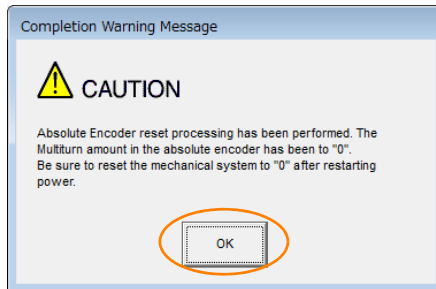

The Main Window will return.

8. To enable the change to the settings, turn the power supply to the SERVOPACK OFF and ON again.

This concludes the procedure to reset the absolute encoder.

6.16 Setting the Origin of the Absolute Encoder

6.16.1 Absolute Encoder Origin Offset

The origin offset of the absolute encoder is a correction that is used to set the origin of the machine coordinate system in addition to the origin of the absolute encoder. Set the offset between the absolute encoder origin and the machine coordinate system position in *home offset* (607Ch).

The offset is added to *position actual value* (6064h) after the parameters are enabled when the power supply is turned ON or with *user parameter configuration* (2700h).

Index	Subindex	Name	Data Type	Access	Data Ranges	Default Value	Saving to EEPROM
607Ch	0	Home offset	DINT	RW	-536,870,912 to 536,870,911	0	Yes

Example If the encoder position (X) is at the origin (0), then *home offset* (607Ch) would be set to the value of -X.

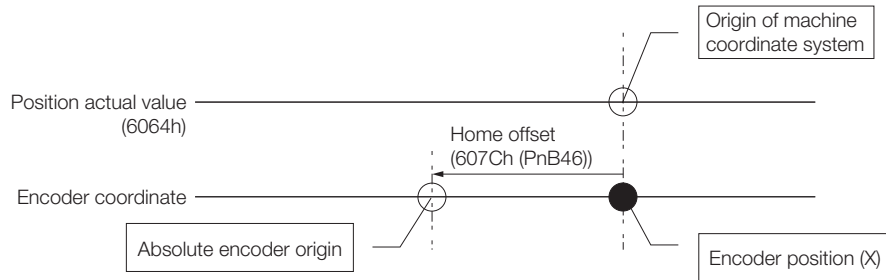

6.16.2 Setting the Origin of the Absolute Linear Encoder

You can set any position as the origin in the following linear encoders.

- Dr. JOHANNES HEIDENHAIN GmbH
LIC4190, LIC3190, or LIC2190 Series
- RSF Elektronik GmbH
MC15Y Series
- Mitutoyo Corporation
ABS ST780A Series or ST1300 Series
Models: ABS ST78□A/ST78□AL/ST13□□
- Renishaw PLC
EVOLUTE Series
Models: EL36Y□□□□□□□□
- Renishaw PLC
RESOLUTE Series
Models: RL36Y□□□□□□□□
- RLS d.o.o
LA11YA Series
- Canon Precision Inc.
Model: PH03-36E00



Important

1. After you set the origin, the /S-RDY (Servo Ready) signal will become inactive because the system position data was changed. Always turn the SERVOPACK power supply OFF and ON again.
2. After you set the origin, the Servomotor phase data in the SERVOPACK will be discarded. If you are using a Linear Servomotor without a Polarity Sensor, execute polarity detection again to save the Servomotor phase data in the SERVOPACK.



Preparations

The following conditions must be met to set the origin of the absolute linear encoder.

- The parameters must not be write prohibited.
- The servo must be OFF.

Applicable Tools

The following table lists the tools that you can use to set the origin of the absolute linear encoder.

Tool	Fn No./Function Name	Reference
Digital Operator	Fn020	 Σ -7-Series Digital Operator Operating Manual (Manual No.: SIEP S800001 33)
SigmaWin+	Setup - Set Origin	 <i>Operating Procedure</i> on page 6-53

Operating Procedure

Use the following procedure to set the origin of an absolute linear encoder.

1. Click the  Servo Drive Button in the workspace of the Main Window of the SigmaWin+.
2. Select **Set Origin** in the Menu Dialog Box.
The Set Origin Dialog Box will be displayed.
3. Click the **Continue** Button.

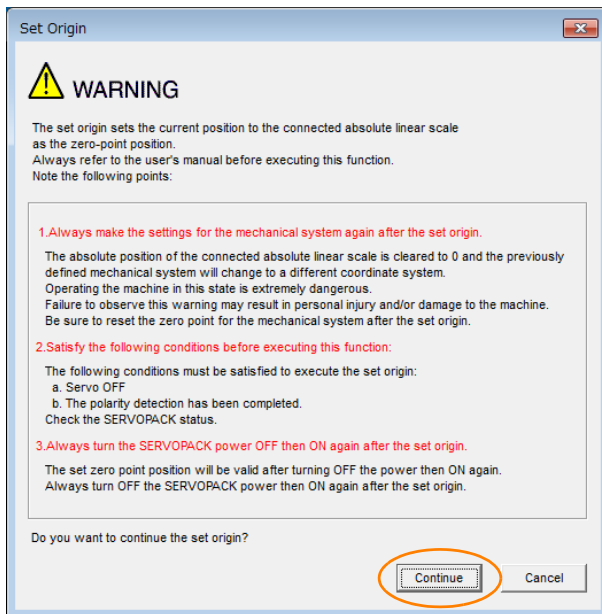

4. Click the **Execute** Button.

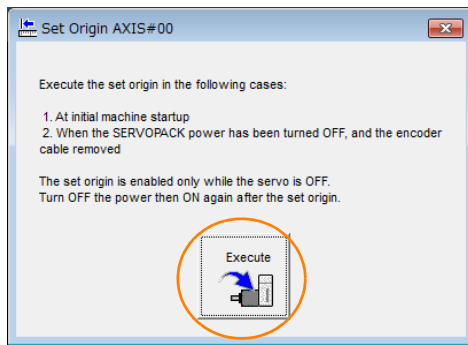

5. Click the **Continue** Button.

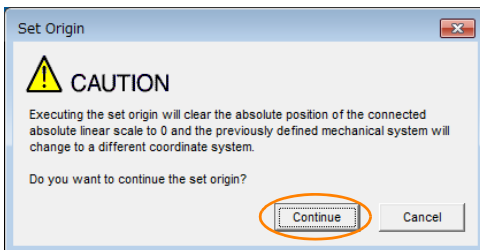

Click the **Cancel** Button to cancel setting the origin of the absolute linear encoder. The previous dialog box will return.

6. Click the **OK** Button.



7. Turn the power supply to the SERVOPACK OFF and ON again.

8. If you use a Linear Servomotor that does not have a polarity sensor, perform polarity detection.

Refer to the following section for details on the polarity detection.

 [6.9 Polarity Detection](#) on page 6-23

This concludes the procedure to set the origin of the absolute linear encoder.

6.17 Setting the Regenerative Resistor Capacity

The Regenerative Resistor consumes regenerative energy that is generated by the Servomotor, e.g., when the Servomotor decelerates.

If an External Regenerative Resistor is connected, you must set Pn600 (Regenerative Resistor Capacity) and Pn603 (Regenerative Resistor Resistance).

Note: When using the SERVOPACK's built-in regenerative resistor (not using an External Regenerative Resistor), use the default setting of 0 for Pn600 and Pn603.



WARNING

- If you connect an External Regenerative Resistor, set Pn600 and Pn603 to suitable values. If a suitable value is not set, A.320 alarms (Regenerative Overload) will not be detected correctly, and the External Regenerative Resistor may be damaged or personal injury or fire may result.
- When you select an External Regenerative Resistor, make sure that it has a suitable capacity. There is a risk of personal injury or fire.

Pn600 (2600h)	Regenerative Resistor Capacity				
	Setting Range	Setting Unit	Default Setting	When Enabled	Classification
	0 to SERVOPACK's maximum applicable motor capacity	10 W	0	Immediately	Setup

Pn603 (2603h)	Regenerative Resistor Resistance				
	Setting Range	Setting Unit	Default Setting	When Enabled	Classification
	0 to 65,535	10 mΩ	0	Immediately	Setup

Set the Regenerative Resistor capacity to a value that is consistent with the allowable capacity of the External Regenerative Resistor. The setting depends on the cooling conditions of the External Regenerative Resistor.

- For self-cooling (natural convection cooling): Set the parameter to a maximum 20% of the capacity (W) of the actually installed Regenerative Resistor.
- For forced-air cooling: Set the parameter to a maximum 50% of the capacity (W) of the actually installed Regenerative Resistor.

Example For a self-cooling 100-W External Regenerative Resistor, set Pn600 to 2 ($\times 10$ W) ($100 \text{ W} \times 20\% = 20 \text{ W}$).

Note: An A.320 alarm will be displayed if the setting is not suitable.



Important

1. When an External Regenerative Resistor is used at the normal rated load ratio, the resistor temperature increases to between 200°C and 300°C. Always apply derating. Consult the manufacturer for the resistor's load characteristics.
2. For safety, use an External Regenerative Resistor with a thermoswitch.

Application Functions



This chapter describes the application functions that you can set before you start Servo System operation. It also describes the setting methods.

7.1	I/O Signal Allocations	7-4
7.1.1	Input Signal Allocations	7-4
7.1.2	Output Signal Allocations	7-5
7.1.3	ALM (Servo Alarm) Signal	7-7
7.1.4	/WARN (Warning) Signal	7-7
7.1.5	/TGON (Rotation Detection) Signal	7-8
7.1.6	/S-RDY (Servo Ready) Signal	7-8
7.1.7	/V-CMP (Speed Coincidence Detection) Signal	7-9
7.1.8	/COIN (Positioning Completion) Signal	7-10
7.1.9	/NEAR (Near) Signal	7-11
7.1.10	Speed Limit during Torque Control	7-12
7.2	Operation for Momentary Power Interruptions	7-14
7.3	SEMI F47 Function	7-15
7.4	Setting the Motor Maximum Speed	7-17
7.5	Encoder Divided Pulse Output	7-18
7.5.1	Encoder Divided Pulse Output Signals	7-18
7.5.2	Setting for the Encoder Divided Pulse Output	7-23
7.6	Software Limits	7-25
7.7	Selecting Torque Limits	7-26
7.7.1	Internal Torque Limits	7-26
7.7.2	External Torque Limits	7-27
7.7.3	/CLT (Torque Limit Detection) Signal	7-30

7.8 Absolute Encoders 7-31

- 7.8.1 Connecting an Absolute Encoder 7-31
- 7.8.2 Structure of the Position Data of the Absolute Encoder 7-32
- 7.8.3 Output Ports for the Position Data from the Absolute Encoder 7-32
- 7.8.4 Reading the Position Data from the Absolute Encoder 7-33
- 7.8.5 Transmission Specifications 7-34
- 7.8.6 Calculating the Current Position in Machine Coordinates 7-35
- 7.8.7 Multiturn Limit Setting 7-36
- 7.8.8 Multiturn Limit Disagreement Alarm (A.CC0) . . . 7-37

7.9 Absolute Linear Encoders 7-40

- 7.9.1 Connecting an Absolute Linear Encoder 7-40
- 7.9.2 Structure of the Position Data of the Absolute Linear Encoder 7-40
- 7.9.3 Output Ports for the Position Data from the Absolute Linear Encoder 7-41
- 7.9.4 Reading the Position Data from the Absolute Linear Encoder 7-42
- 7.9.5 Transmission Specifications 7-42
- 7.9.6 Calculating the Current Position in Machine Coordinates 7-43

7.10 Software Reset 7-44

- 7.10.1 Preparations 7-44
- 7.10.2 Applicable Tools 7-44
- 7.10.3 Operating Procedure 7-45

7.11 Initializing the Vibration Detection Level . . 7-46

- 7.11.1 Preparations 7-46
- 7.11.2 Applicable Tools 7-47
- 7.11.3 Operating Procedure 7-47
- 7.11.4 Related Parameters 7-49

7.12 Adjusting the Motor Current Detection Signal Offset . . 7-50

- 7.12.1 Automatic Adjustment 7-50
- 7.12.2 Manual Adjustment 7-53

7.13 Forcing the Motor to Stop 7-55

- 7.13.1 FSTP (Forced Stop Input) Signal 7-55
- 7.13.2 Stopping Method Selection for Forced Stops . . 7-55
- 7.13.3 Resetting Method for Forced Stops 7-57

7.14 ZONE Outputs (FT64 Specification)7-58

- 7.14.1 ZONE Table and ZONE Signals 7-58
- 7.14.2 ZONE Table Settings 7-59
- 7.14.3 ZONE Signals 1 to 4 Outputs
(/ZONE0 to /ZONE3) 7-60
- 7.14.4 nZONE Signal Output 7-61
- 7.14.5 ZONE Output Application Example 7-62

7.15 Overheat Protection7-63

- 7.15.1 Connecting the Overheat Protection
Input (TH) Signal 7-63
- 7.15.2 Overheat Protection Selections 7-63

7.1 I/O Signal Allocations

Functions are allocated to the pins on the I/O signal connector (CN1) in advance. You can change the allocations and the polarity for some of the connector pins. Function allocations and polarity settings are made with parameters.

This section describes the I/O signal allocations.

7.1.1 Input Signal Allocations



Important

- If you change the default polarity settings for the P-OT (Forward Drive Prohibit) or N-OT (Reverse Drive Prohibit) signal, the overtravel function will not operate if there are signal line disconnections or other problems. If you must change the polarity of one of these signals, verify operation and make sure that no safety problems will exist.
- If you allocate two or more signals to the same input circuit, a logical OR of the inputs will be used and all of the allocated signals will operate accordingly. This may result in unexpected operation.

The input signals that you can allocate to the pins on the I/O signal connector (CN1) and the related parameters are given in the following table.

Input Signal	Input Signal Name	Parameter
P-OT	Forward Drive Prohibit	Pn50A (250Ah) = n.X□□□
N-OT	Reverse Drive Prohibit	Pn50B (250Bh) = n.□□□X
/P-CL	Forward External Torque Limit	Pn50B (250Bh) = n.□X□□
/N-CL	Reverse External Torque Limit	Pn50B (250Bh) = n.X□□□
/Probe1	Probe 1 Latch Input	Pn511 (2511h) = n.□□X□
/Probe2	Probe 2 Latch Input	Pn511 (2511h) = n.□X□□
/Home	/Home Input	Pn511 (2511h) = n.X□□□
/DBANS	Dynamic Brake Answer Input	Pn515 (2515h) = n.□X□□
FSTP	Forced Stop	Pn516 (2516h) = n.□□□X

◆ Relationship between Parameter Settings, Allocated Pins, and Polarities

The following table shows the relationship between the input signal parameter settings, the pins on the I/O signal connector (CN1), and polarities.

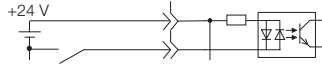
Parameter Setting	Pin No.	Description
0	13	 <p>A reverse signal (a signal with “/” before the signal abbreviation, such as the /P-CL signal) is active when the contacts are ON (closed). A signal that does not have “/” before the signal abbreviation (such as the P-OT signal) is active when the contacts are OFF (open).</p>
1	7	
2	8	
3	9	
4	10	
5	11	
6	12	
7	–	The input signal is not allocated to a connector pin and it is always active. If the signal is processed on a signal edge, then it is always inactive.
8	–	The input signal is not allocated to a connector pin and it is always inactive. Set the parameter to 8 if the signal is not used.

Continued on next page.

Continued from previous page.

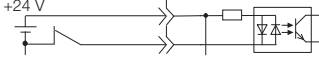
Parameter Setting	Pin No.	Description
9	13	 <p>A reverse signal (a signal with "/" before the signal abbreviation, such as the /P-CL signal) is active when the contacts are OFF (open). A signal that does not have "/" before the signal abbreviation (such as the P-OT signal) is active when the contacts are ON (closed).</p>
A	7	
B	8	
C	9	
D	10	
E	11	
F	12	

Note: 1. You can allocate the /Probe1, /Probe2, and /Home input signals only to pins 10 to 12 on the I/O signal connector (CN1).

2. Refer to the following section for details on input signal parameter settings.

 17.1.2 List of Parameters on page 17-3

Example of Changing Input Signal Allocations

The following example shows reversing the P-OT (Forward Drive Prohibit) signal allocated to CN1-7 and the /DEC (Origin Return Deceleration Switch) signal allocated to CN1-9.

Pn50A = n.1□□1 Pn511 = n.□□□3 Before change

↓

↓

Pn50A = n.3□□1 Pn511 = n.□□□1 After change

Refer to the following section for the parameter setting procedure.

 6.1.3 Setting Methods for SERVOPACK Parameters on page 6-5

Confirming the Allocation Status of Input Signals

You can confirm the allocation status of input signals with the I/O Signal Allocations Window of the SigmaWin+. Refer to the following section for details.

 10.2.3 I/O Signals Status Monitor on page 10-5

7.1.2 Output Signal Allocations

You can allocate the desired output signals to pins 1, 2, and 23 to 30 on the I/O signal connector (CN1). You set the allocations in the following parameters: Pn50E, Pn50F, Pn510, Pn514, Pn51A, PnBA0, and PnBA1.



Important

- The signals that are not detected are considered to be OFF. For example, the /COIN (Positioning Completion) signal is considered to be OFF during speed control.
- Reversing the polarity of the /BK (Brake) signal, i.e., changing it to positive logic, will prevent the holding brake from operating if its signal line is disconnected. If you must change the polarity of this signal, verify operation and make sure that no safety problems will exist.
- If you allocate more than one signal to the same output circuit, a logical OR of the signals will be output.

The following table shows the relationship between the parameters and the output signals that can be allocated to the pins on the I/O signal connector (CN1).

Output Signals	Output Signal Name	Parameter
/COIN	Positioning Completion	Pn50E (250Eh) = n.□□□X
/V-CMP	Speed Coincidence Detection	Pn50E (250Eh) = n.□□X□
/TGON	Rotation Detection	Pn50E (250Eh) = n.□X□□
/S-RDY	Servo Ready	Pn50E (250Eh) = n.X□□□
/CLT	Torque Limit Detection	Pn50F (250Fh) = n.□□□X
/VLT	Speed Limit Detection	Pn50F (250Fh) = n.□□X□
/BK	Brake	Pn50F (250Fh) = n.□X□□
/WARN	Warning	Pn50F (250Fh) = n.X□□□
/NEAR	Near	Pn510 (2510h) = n.□□□X
/PM	Preventative Maintenance	Pn514 (2514h) = n.□X□□
/DBON	Dynamic Brake Operation Request	Pn51A (251Ah) = n.□□X□
/ZONE0	ZONE Signal 1	PnBA0 (2752h) = n.□□□X
/ZONE1	ZONE Signal 2	PnBA0 (2752h) = n.□□X□
/ZONE2	ZONE Signal 3	PnBA0 (2752h) = n.□X□□
/ZONE3	ZONE Signal 4	PnBA0 (2752h) = n.X□□□
/nZONE	nZONE Signal	PnBA1 (2753h) = n.□□□X

◆ Relationship between Parameter Settings and Allocated Pin Numbers

The following table shows the relationship between the output signal parameter settings and the pin numbers on the I/O signal connector (CN1).

Parameter Setting	Pin No.	Description
0	–	Disable (signal output is not used)
1	1 or 2	Output the allocated signal from the CN1-1 or CN1-2 output terminal.
2	23 or 24	Output the allocated signal from the CN1-23 or CN1-24 output terminal.
3	25 or 26	Output the allocated signal from the CN1-25 or CN1-26 output terminal.
4	27 or 28	Output the allocated signal from the CN1-27 or CN1-28 output terminal.
5	29 or 30	Output the allocated signal from the CN1-29 or CN1-30 output terminal.
6	–	Reserved setting (Do not use.)

◆ Output Signal Polarity Switching

The polarity of output signals is switched using Pn512 and Pn513.

Parameter		Pin No.	Description	
Parameter No.	Setting Value			
Pn512 (2512h)	n.□□□X	1 or 2	0	The signal is not inverted.
			1	The signal is inverted.
	n.□□X□	23 or 24	0	The signal is not inverted.
			1	The signal is inverted.
	n.□X□□	25 or 26	0	The signal is not inverted.
			1	The signal is inverted.
n.X□□□	27 or 28	0	The signal is not inverted.	
		1	The signal is inverted.	
Pn513 (2513h)	n.□□□X	29 or 30	0	The signal is not inverted.
			1	The signal is inverted.

Example of Changing Output Signal Allocations

The following example shows disabling the /COIN (Positioning Completion) signal allocated to CN1-25 and CN1-26 and allocating the /SRDY (Servo Ready) signal.

Pn50E = n.0□□3 Before change



Pn50E = n.3□□0 After change

Refer to the following section for the parameter setting procedure.

 6.1.3 *Setting Methods for SERVOPACK Parameters* on page 6-5

Confirming the Allocation Status of Output Signals

You can confirm the allocation status of output signals with the I/O Signal Allocation Window of the SigmaWin+. Refer to the following section for details.

 10.2.3 *I/O Signals Status Monitor* on page 10-5

7.1.3 ALM (Servo Alarm) Signal

This signal is output when the SERVOPACK detects an error.



Configure an external circuit so that this alarm output turns OFF the main circuit power supply to the SERVOPACK whenever an error occurs.

Important

Type	Signal	Connector Pin No.	Signal Status	Meaning
Output	ALM	CN1-3 and CN1-4	ON (closed)	Normal SERVOPACK status
			OFF (open)	SERVOPACK alarm

Alarm Reset Methods

Refer to the following section for information on the alarm reset methods.

 16.2.3 *Resetting Alarms* on page 16-42

7.1.4 /WARN (Warning) Signal

Both alarms and warnings are generated by the SERVOPACK. Alarms indicate errors in the SERVOPACK for which operation must be stopped immediately. Warnings indicate situations that may result in alarms but for which stopping operation is not yet necessary.

The /WARN (Warning) signal indicates that a condition exists that may result in an alarm.

Type	Signal	Connector Pin No.	Signal Status	Meaning
Output	/WARN	Must be allocated.	ON (closed)	Warning
			OFF (open)	Normal status

Note: You must allocate the /WARN signal to use it. Use Pn50F = n.X□□□ (/WARN (Warning Output) Signal Allocation) to allocate the signal to a connector pin. Refer to the following section for details.

 7.1.2 *Output Signal Allocations* on page 7-5

7.1.5 /TGON (Rotation Detection) Signal

The /TGON signal indicates that the Servomotor is operating.

This signal is output when the shaft of the Servomotor rotates at the setting of Pn502 (Rotation Detection Level) or faster or the setting of Pn581 (Zero Speed Level) or faster.

Type	Signal	Connector Pin No.	Signal Status	Servomotor	Meaning
Output	/TGON	Must be allocated.	ON (closed)	Rotary Servomotors	The Servomotor is operating at the setting of Pn502 or faster.
				Linear Servomotors	The Servomotor is operating at the setting of Pn581 or faster.
			OFF (open)	Rotary Servomotors	The Servomotor is operating at a speed that is slower than the setting of Pn502.
				Linear Servomotors	The Servomotor is operating at a speed that is slower than the setting of Pn581.

Note: You must allocate the /TGON signal to use it. Use Pn50E = n.X□□□ (/TGON (Rotation Detection Output) Signal Allocation) to allocate the signal to a connector pin. Refer to the following section for details.

7.1.2 Output Signal Allocations on page 7-5

Setting the Rotation Detection Level

Use the following parameter to set the speed detection level at which to output the /TGON signal.

- Rotary Servomotors

Pn502 (2502h)	Rotation Detection Level			Speed	Position	Torque
	Setting Range	Setting Unit	Default Setting	When Enabled	Classification	
	1 to 10,000	1 min ⁻¹	20	Immediately	Setup	

- Linear Servomotors

Pn581 (2581h)	Zero Speed Level			Speed	Position	Force
	Setting Range	Setting Unit	Default Setting	When Enabled	Classification	
	1 to 10,000	1 mm/s	20	Immediately	Setup	

7.1.6 /S-RDY (Servo Ready) Signal

The /S-RDY (Servo Ready) signal turns ON when the SERVOPACK is ready to accept the Servo ON command (Enable Operation command).

The /S-RDY signal is turned ON under the following conditions.

- Main circuit power supply is ON.
- There is no hard wire base block state.
- There are no alarms.
- If a Servomotor without a polarity sensor is used, polarity detection has been completed.*

* Do not include this condition if the Servo ON command (Enable Operation command) is input for the first time after the control power supply was turned ON. In that case, when the first Servo ON command (Enable Operation command) is input, polarity detection is started immediately and the /S-RDY signal turns ON at the completion of polarity detection.

Type	Signal	Connector Pin No.	Signal Status	Meaning
Output	/S-RDY	Must be allocated.	ON (closed)	Ready to receive Servo ON command (Enable Operation command).
			OFF (open)	Not ready to receive Servo ON command (Enable Operation command).

Note: 1. You must allocate the /S-RDY signal to use it. Use Pn50E = n.X□□□ (/S-RDY (Servo Ready) Signal Allocation) to allocate the signal to a connector pin. Refer to the following section for details.

7.1.2 Output Signal Allocations on page 7-5

2. Refer to the following section for information on the hard wire base block and the /S-RDY signal.

12.2.8 /S-RDY (Servo Ready Output) Signal on page 12-10

7.1.7 /V-CMP (Speed Coincidence Detection) Signal

The /V-CMP (Speed Coincidence Detection Output) signal is output when the Servomotor speed is the same as the reference speed. This signal is used, for example, to interlock the SERVOPACK and the host controller. You can use this output signal only during speed control.

The /V-CMP signal is described in the following table.

Type	Signal	Connector Pin No.	Signal Status	Meaning
Output	/V-CMP	Must be allocated.	ON (closed)	The speed coincides.
			OFF (open)	The speed does not coincide.

Note: You must allocate the /V-CMP signal to use it. Use Pn50E = n.□□X□ (/V-CMP (Speed Coincidence Detection Output) Signal Allocation) to allocate the signal to connector pins. Refer to the following section for details on allocations.

☞ 7.1.2 Output Signal Allocations on page 7-5

You can set the speed detection width for the /V-CMP signal in Pn503 (Speed Coincidence Signal Detection Width) for a Rotary Servomotor or in Pn582 (Speed Coincidence Signal Detection Width) for a Linear Servomotor.

- Rotary Servomotors

Pn503 (2503h)	Speed Coincidence Signal Detection Width				
	Speed				
	Setting Range	Setting Unit	Default Setting	When Enabled	Classification
	0 to 100	1 min ⁻¹	10	Immediately	Setup

The signal is output when the difference between the reference speed and motor speed is equal or less than the setting.

Example If Pn503 is set to 100 and the speed reference is 2,000 min⁻¹, the signal would be output when the motor speed is between 1,900 and 2,100 min⁻¹.

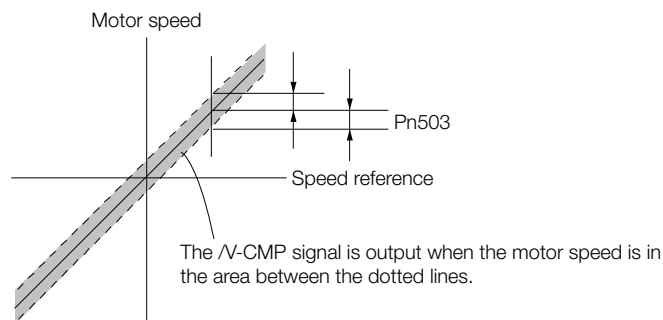

- Linear Servomotors

Pn582 (2582h)	Speed Coincidence Signal Detection Width				
	Speed				
	Setting Range	Setting Unit	Default Setting	When Enabled	Classification
	0 to 100	1 mm/s	10	Immediately	Setup

The signal is output when the difference between the reference speed and motor speed is equal or less than the setting.

Example If Pn582 is set to 100 and the speed reference is 2,000 mm/s the signal would be output when the motor speed is between 1,900 and 2,100 mm/s.

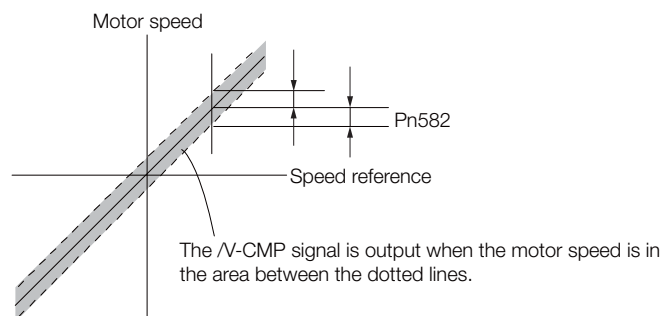

7.1.8 /COIN (Positioning Completion) Signal

The /COIN (Positioning Completion) signal indicates that Servomotor positioning has been completed during position control.

The /COIN signal is output when the difference between the reference position output by the host controller and the current position of the Servomotor (i.e., the position deviation as given by the value of the deviation counter) is equal to or less than the setting of the positioning completed width (Pn522).

Use this signal to check the completion of positioning from the host controller.

Type	Signal	Connector Pin No.	Signal Status	Meaning
Output	/COIN	Must be allocated.	ON (closed)	Positioning has been completed.
			OFF (open)	Positioning has not been completed.

Note: You must allocate the /COIN signal to use it. Use Pn50E = n.□□□X (/COIN (Positioning Completion Output) Signal Allocation) to allocate the signal to connector pins. Refer to the following section for details on allocations.

 7.1.2 Output Signal Allocations on page 7-5

Setting the Positioning Completed Width

The /COIN signal is output when the difference between the reference position and the current position (i.e., the position deviation as given by the value of the deviation counter) is equal to or less than the setting of the positioning completed width (Pn522).

Pn522 (2522h)	Positioning Completed Width				Position
	Setting Range	Setting Unit	Default Setting	When Enabled	Classification
	0 to 1,073,741,824	1 reference unit	7	Immediately	Setup

The setting of the positioning completed width has no effect on final positioning accuracy.

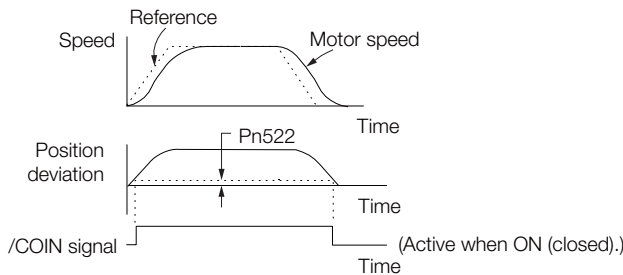

Note: If the parameter is set to a value that is too large, the /COIN signal may be output when the position deviation is low during a low-speed operation. If that occurs, reduce the setting until the signal is no longer output.

Setting the Output Timing of the /COIN (Positioning Completion Output) Signal

You can add a reference input condition to the output conditions for the /COIN signal to change the signal output timing.

If the position deviation is always low and a narrow positioning completed width is used, change the setting of Pn207 = n.X□□□ (/COIN (Positioning Completion Output) Signal Output Timing) to change output timing for the /COIN signal.

Parameter	Description	When Enabled	Classification	
Pn207 (2207h)	n.0□□□ (default setting)	Output the /COIN signal when the absolute value of the position deviation is the same or less than the setting of Pn522 (Positioning Completed Width).	After restart	Setup
	n.1□□□	Output the /COIN signal when the absolute value of the position deviation is the same or less than the setting of Pn522 (Positioning Completed Width) and the reference after the position reference filter is 0.		
	n.2□□□	Output the /COIN signal when the absolute value of the position deviation is the same or less than the setting of Pn522 (Positioning Completed Width) and the reference input is 0.		

7.1.9 /NEAR (Near) Signal

The /NEAR (Near) signal indicates when positioning completion is being approached.

The host controller receives the NEAR signal before it receives the /COIN (Positioning Completion) signal, it can start preparations for the operating sequence to use after positioning has been completed. This allows you to reduce the time required for operation when positioning is completed.

The NEAR signal is generally used in combination with the /COIN signal.

Type	Signal	Connector Pin No.	Signal Status	Meaning
Output	/NEAR	Must be allocated.	ON (closed)	The Servomotor has reached a point near to positioning completion.
			OFF (open)	The Servomotor has not reached a point near to positioning completion.

Note: You must allocate the /NEAR signal to use it. Use Pn510 = n.□□□X (/NEAR (Near) Signal Allocation) to allocate the signal to a connector pin. Refer to the following section for details.

 7.1.2 Output Signal Allocations on page 7-5

/NEAR (Near) Signal Setting

You set the condition for outputting the /NEAR (Near) signal (i.e., the near signal width) in Pn524 (Near Signal Width). The /NEAR signal is output when the difference between the reference position and the current position (i.e., the position deviation as given by the value of the deviation counter) is equal to or less than the setting of the near signal width (Pn524).

Pn524 (2524h)	Near Signal Width				Position	Classification
	Setting Range	Setting Unit	Default Setting	When Enabled		
	1 to 1,073,741,824	1 reference unit	1,073,741,824	Immediately	Setup	

7.1.10 Speed Limit during Torque Control

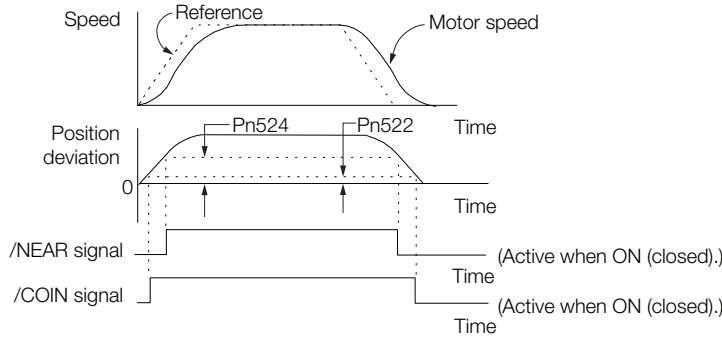

Note: Normally, set Pn524 to a value that is larger than the setting of Pn522 (Positioning Completed Width).

7.1.10 Speed Limit during Torque Control

You can limit the speed of the Servomotor to protect the machine.

When you use a Servomotor for torque control, the Servomotor is controlled to output the specified torque, but the motor speed is not controlled. Therefore, if a reference torque is input that is larger than the machine torque, the speed of the Servomotor may increase greatly. If that may occur, use this function to limit the speed.

Note: The actual limit of motor speed depends on the load conditions on the Servomotor.

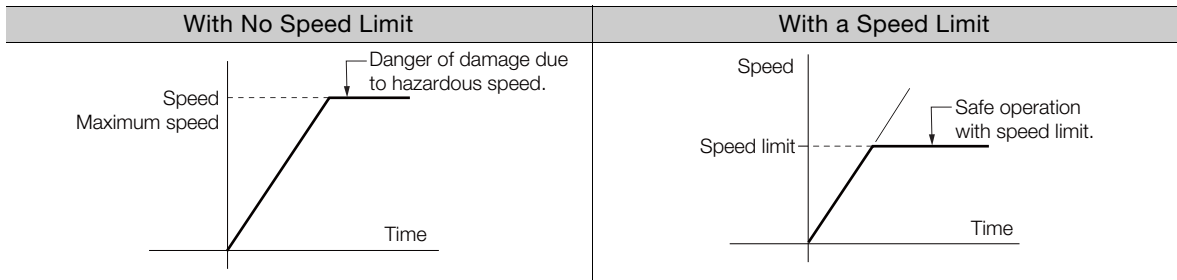

/VLT (Speed Limit Detection) Signal

The signal that is output when the motor speed is being limited by the speed limit is described in the following table.

Type	Signal	Connector Pin No.	Signal Status	Meaning
Output	/VLT	Must be allocated.	ON (closed)	The Servomotor speed is being limited.
			OFF (open)	The Servomotor speed is not being limited.

Note: You must allocate the /VLT signal to use it. Use Pn50F = n.□□X□ (/VLT (Speed Limit Detection) Signal Allocation) to allocate the signal to a connector pin. Refer to the following section for details.

7.1.2 Output Signal Allocations on page 7-5

Internal Speed Limiting

Set the speed limit for the motor in Pn407 (Speed Limit during Torque Control) or Pn480 (Speed Limit during Force Control). Also set Pn408 = n.□□X□ (Speed Limit Selection) to specify using the maximum motor speed or the overspeed alarm detection speed as the speed limit. Select the overspeed alarm detection speed to limit the speed to the equivalent of the maximum motor speed.

Parameter	Meaning	When Enabled	Classification
Pn408 (2408h)	n.□□0□ (default setting)	After restart	Setup
	n.□□1□		

Note: If you are using a Rotary Servomotor, set Pn407 (Speed Limit during Torque Control). If you are using a Linear Servomotor, set Pn480 (Speed Limit during Force Control).

- Rotary Servomotors

Pn407 (2407h)	Speed Limit during Torque Control Torque				
	Setting Range	Setting Unit	Default Setting	When Enabled	Classification
	0 to 10,000	1 min ⁻¹	10000	Immediately	Setup

- Linear Servomotors

Pn480 (2480h)	Speed Limit during Force Control Force				
	Setting Range	Setting Unit	Default Setting	When Enabled	Classification
	0 to 10,000	1 mm/s	10000	Immediately	Setup

Note: If the parameter setting exceeds the maximum speed of the Servomotor, the Servomotor's maximum speed or the overspeed alarm detection speed will be used.

7.2 Operation for Momentary Power Interruptions

Even if the main power supply to the SERVOPACK is interrupted momentarily, power supply to the motor (servo ON status) will be maintained for the time set in Pn509 (Momentary Power Interruption Hold Time).

Pn509 (2509h)	Momentary Power Interruption Hold Time			Speed	Position	Torque
	Setting Range	Setting Unit	Default Setting	When Enabled	Classification	
	20 to 50,000	1 ms	20	Immediately	Setup	

If the momentary power interruption time is equal to or less than the setting of Pn509, power supply to the motor will be continued. If it is longer than the setting, power supply to the motor will be stopped. Power will be supplied to the motor again when the main circuit power supply recovers.

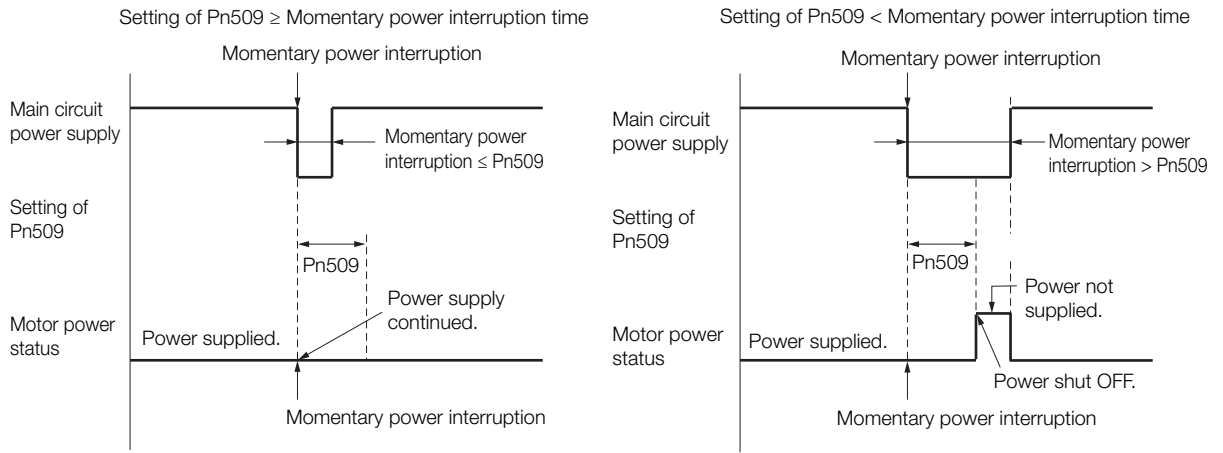

Information

1. If the momentary power interruption time exceeds the setting of Pn509, the /S-RDY (Servo Ready) signal will turn OFF.
2. If uninterruptible power supplies are used for the control power supply and main circuit power supply, the SERVOPACK can withstand a power interruption that lasts longer than 50,000 ms.
3. The holding time of the SERVOPACK control power supply (24 VDC) depends on the specifications of the 24-VDC power supply. Confirm the holding time yourself. If control operations become impossible during a momentary power interruption of the control power supply, the setting of Pn509 will be ignored and the same operation will be performed as for when the power supply is turned OFF normally.



Important

The holding time of the main circuit power supply depends on the output from the SERVOPACK. If the load on the Servomotor is large and an A.410 alarm (Undervoltage) occurs, the setting of Pn509 will be ignored.

7.3 SEMI F47 Function

The SEMI F47 function detects an A.971 warning (Undervoltage) and limits the output current if the DC main circuit power supply voltage to the SERVOPACK drops to a specified value or lower because the power was momentarily interrupted or the main circuit power supply voltage was temporarily reduced.

This function complies with the SEMI F47 standards for semiconductor manufacturing equipment.

You can combine this function with the momentary power interruption hold time (Pn509) to allow the Servomotor to continue operating without stopping for an alarm or without recovery work even if the power supply voltage drops.

Execution Sequence

This function can be executed either with the host controller or with the SERVOPACK. Use Pn008 = n.□□X□ (Function Selection for Undervoltage) to specify whether the function is executed by the host controller or by the SERVOPACK.

◆ Execution with the Host Controller (Pn008 = n.□□1□)

The host controller limits the torque in response to an A.971 warning (Undervoltage).

The host controller removes the torque limit after the Undervoltage warning is cleared.

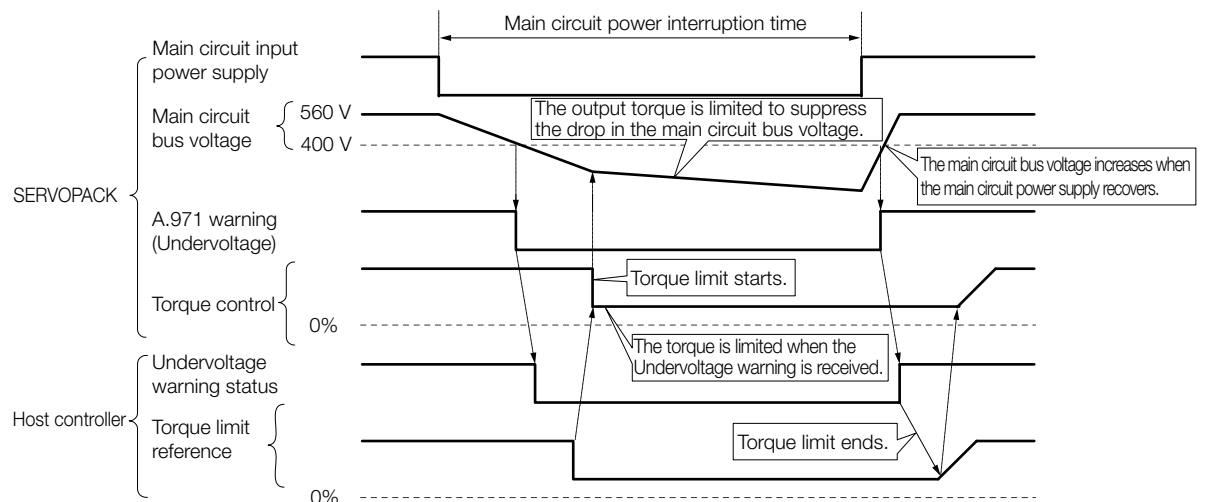

◆ Execution with the SERVOPACK (Pn008 = n.□□2□)

The torque is limited in the SERVOPACK in response to an Undervoltage warning.

The SERVOPACK controls the torque limit for the set time after the Undervoltage warning is cleared.

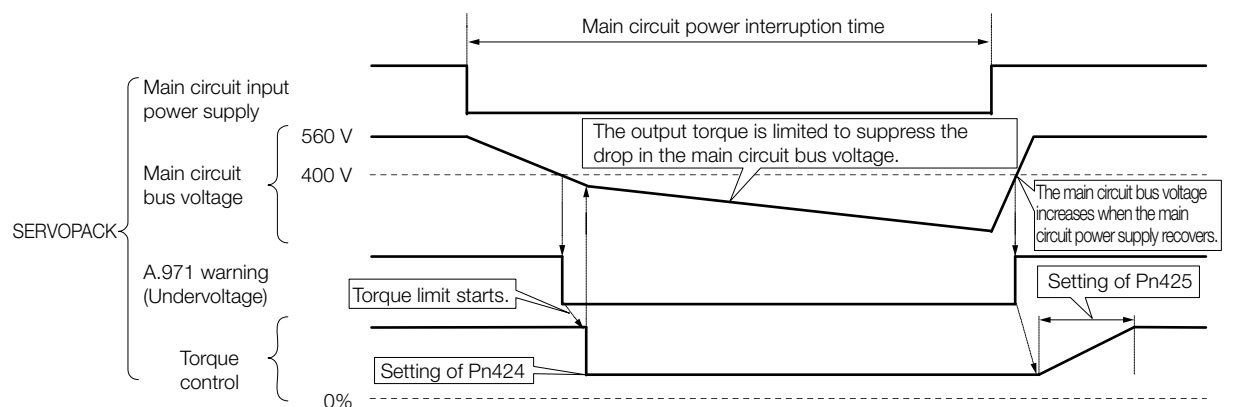

Setting for A.971 Warnings (Undervoltage)

You can set whether or not to detect A.971 warnings (Undervoltage).

Parameter		Meaning	When Enabled	Classification
Pn008 (2008h)	n.□□0□ (default setting)	Do not detect undervoltage warning.	After restart	Setup
	n.□□1□	Detect undervoltage warning and limit torque at host controller.		
	n.□□2□	To detect undervoltage warnings, use Pn424 (Torque Limit at Main Circuit Voltage Drop) and Pn425 (Release Time for Torque Limit at Main Circuit Voltage Drop). (i.e., only in SERVOPACK).		

◆ Related Parameters

The following parameters are related to the SEMI F47 function.

Pn424 (2424h)	Torque Limit at Main Circuit Voltage Drop			Speed	Position	Torque
	Setting Range	Setting Unit	Default Setting	When Enabled	Classification	
	0 to 100	1%*	50	Immediately	Setup	
Pn425 (2425h)	Release Time for Torque Limit at Main Circuit Voltage Drop			Speed	Position	Torque
	Setting Range	Setting Unit	Default Setting	When Enabled	Classification	
	0 to 1,000	1 ms	100	Immediately	Setup	
Pn509 (2509h)	Momentary Power Interruption Hold Time			Speed	Position	Torque
	Setting Range	Setting Unit	Default Setting	When Enabled	Classification	
	20 to 50,000	1 ms	20	Immediately	Setup	

* Set a percentage of the motor rated torque.

Note: If you will use the SEMI F47 function, set the time to 1,000 ms.



Important

- This function handles momentary power interruptions for the voltage and time ranges stipulated in SEMI F47. An uninterruptible power supply (UPS) is required as a backup for momentary power interruptions that exceed these voltage and time ranges.
- Set the host controller or SERVOPACK torque limit so that a torque reference that exceeds the specified acceleration torque will not be output when the power supply for the main circuit is restored.
- For a vertical axis, do not limit the torque to a value that is lower than the holding torque.
- This function limits torque within the range of the SERVOPACK's capability for power interruptions. It is not intended for use under all load and operating conditions. Set the parameters while monitoring operation on the actual machine.
- You can set the momentary power interruption hold time to increase the amount of time from when the power supply is turned OFF until power supply to the motor is stopped. To stop the power supply to the motor immediately, use the Servo OFF command (Disable Operation command).

7.4

Setting the Motor Maximum Speed

You can set the maximum speed of the Servomotor with the following parameter.

- Rotary Servomotors

Pn316 (2316h)	Maximum Motor Speed					
				[Speed]	[Position]	[Torque]
	Setting Range	Setting Unit	Default Setting	When Enabled	Classification	
	0 to 65,535	1 min ⁻¹	10,000	After restart	Setup	

- Linear Servomotors



Pn385 (2385h)	Maximum Motor Speed					
				[Speed]	[Position]	[Force]
	Setting Range	Setting Unit	Default Setting	When Enabled	Classification	
	1 to 100	100 mm/s	50	After restart	Setup	

You can achieve the following by lowering the maximum speed of the Servomotor.

- If the motor speed exceeds the setting, an A.510 alarm (Overspeed) will occur.
- With a Linear Servomotor, you can increase the upper limit for the setting of Pn281 (Encoder Output Resolution). Refer to the following section for details.

 7.5 Encoder Divided Pulse Output on page 7-18

Changing the setting of the parameter is effective in the following cases.

- To protect the machine by stopping machine operation with an alarm when the set speed is reached or exceeded
- To limit the speed so that the load is not driven beyond the allowable moment of inertia
Refer to relevant manual from the following list for the relationship between the speed and the allowable moment of inertia.
 -  Σ -7-Series Rotary Servomotor with 400 V-Input Power Product Manual (Manual No.: SIEP S800001 86)
 -  Σ -7-Series Linear Servomotor with 400 V-Input Power Product Manual (Manual No.: SIEP S800001 81)
- To increase the encoder output resolution and increase the position resolution managed by the host controller (for a Linear Servomotor)

7.5 Encoder Divided Pulse Output

The encoder divided pulse output is a signal that is output from the encoder and processed inside the SERVOPACK. It is then output externally in the form of two phase pulse signals (phases A and B) with a 90° phase differential. At the host controller, it is used as the position feedback.

The following table describes the signals and output phase forms.

7.5.1 Encoder Divided Pulse Output Signals

Type	Signal	Connector Pin No.	Name	Remarks	
Output	PAO	CN1-17	Encoder Divided Pulse Output, Phase A	<ul style="list-style-type: none"> • Rotary Servomotors These encoder divided pulse output pins output the number of pulses per motor resolution that is set in Pn212 (Number of Encoder Output Pulses). The phase difference between phase A and phase B is an electric angle of 90°. • Linear Servomotors These encoder divided pulse output pins output pulses at the resolution that is set in Pn281 (Encoder Output Resolution). The phase difference between phase A and phase B is an electric angle of 90°. 	
	/PAO	CN1-18			
	PBO	CN1-19	Encoder Divided Pulse Output, Phase B		
	/PBO	CN1-20			
	PCO	CN1-21	Encoder Divided Pulse Output, Phase C*		These pins output one pulse every motor rotation.
	/PCO	CN1-22			

* Refer to the following section for information on the origin within one encoder rotation.

◆ Relation between Renishaw PLC Incremental Linear Encoders and Encoder Output Pulse Signal from the SERVOPACK When Using a RGS20 Scale and RGH22B Sensor Head on page 7-19

- Rotary Servomotor

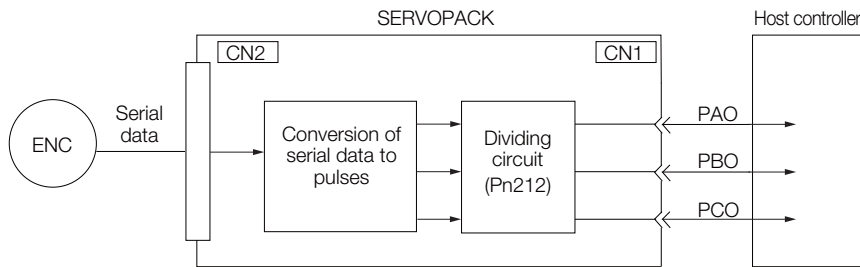

- Linear Servomotors

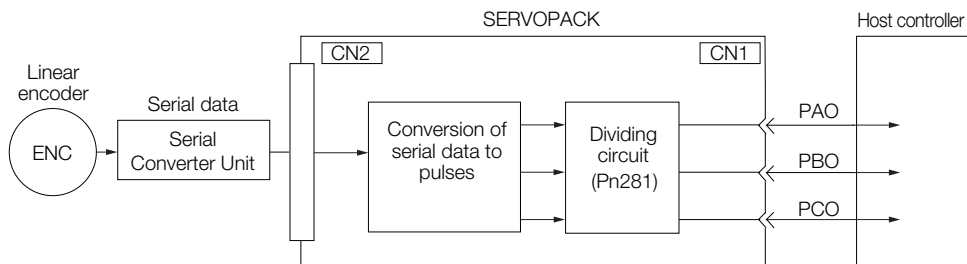

Output Phase Forms

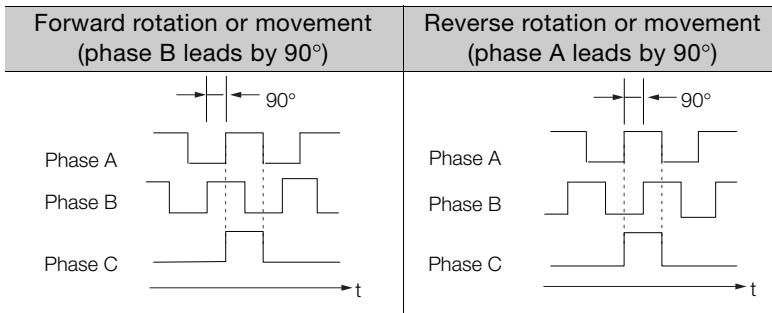

Note: The pulse width of the origin within one encoder rotation depends on the setting of number of encoder output pulses (Pn212) or the encoder output resolution (Pn281). It is the same as the width of phase A. Even for reverse operation (Pn000 = n.□□□1), the output phase form is the same as shown above.



If you use the SERVOPACK's phase-C pulse output for an origin return, rotate the Servomotor two or more rotations before you start an origin return. If the Servomotor cannot be rotated two or more times, perform an origin return operation at a motor speed of 600 min⁻¹ or lower. If the motor speed is higher than 600 min⁻¹, the phase-C pulse may not be output correctly.

Linear Encoder Application Precautions

The following precautions apply to the encoder output pulses when an external linear encoder is used.

◆ Relation between Renishaw PLC Incremental Linear Encoders and Encoder Output Pulse Signal from the SERVOPACK When Using a RGS20 Scale and RGH22B Sensor Head

The output position of the origin signal (Ref) will depend on the direction of movement for some models of incremental linear encoders from Renishaw PLC.

In that case, the phase-C pulse of the SERVOPACK is output at two positions.

For detailed specifications on the origin signal, refer to the manual for the Renishaw PLC incremental linear encoder.

■ When Passing the First Origin Signal (Ref) in the Forward Direction and Returning after Turning ON the Power Supply

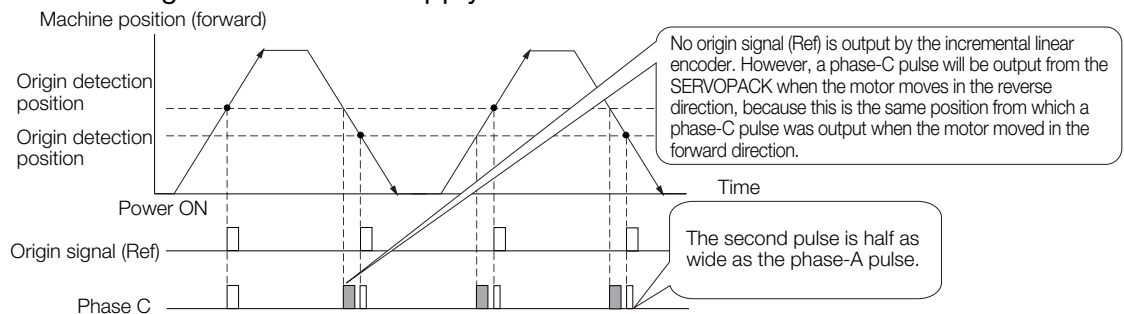

■ When Passing the First Origin Signal (Ref) in the Reverse Direction and Returning after Turning ON the Power Supply

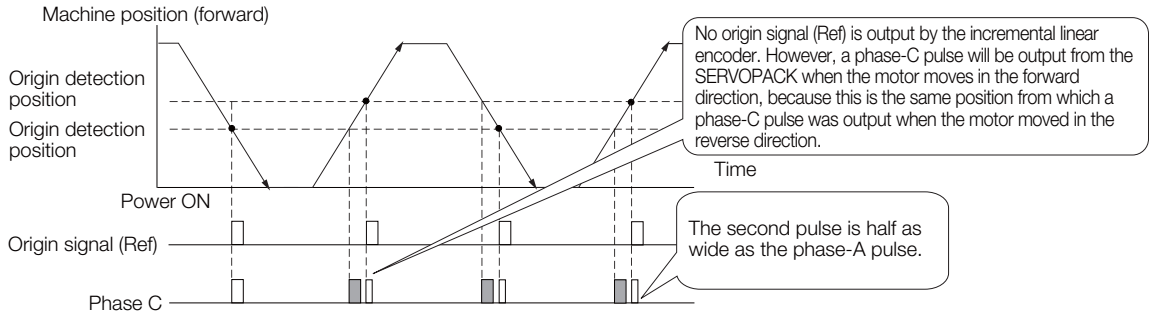

◆ Precautions When Using a Linear Incremental Encoder from Magnescale Co., Ltd.

■ Encoder Divided Phase-C Pulse Output Selection

You can also output the encoder's phase-C pulse for reverse movement. To do so, set Pn081 to n.□□□1.

Parameter	Meaning	When Enabled	Classification
Pn081 (2081h)	n.□□□0 (default setting)	After restart	Setup
	n.□□□1		



Important

Precautions on Setting the Phase-C Pulse Output Selection (Pn081 = n.□□□X)

- If you set Pn081 to n.□□□1 (Output phase-C pulses in both the forward and reverse directions), the width of the phase-C pulse output may be narrower than the width of the phase-A pulse.
- There is a difference of 1/8th of the scale pitch in the phase-C detection position for the encoder's phase-C pulse output position, origin return command, or phase-C latch between when Pn081 = n.□□□X is set to 0 (Output phase-C pulses only in the forward direction) and when it is set to 1 (Output phase-C pulses in both the forward and reverse directions).

Movement in the forward direction →

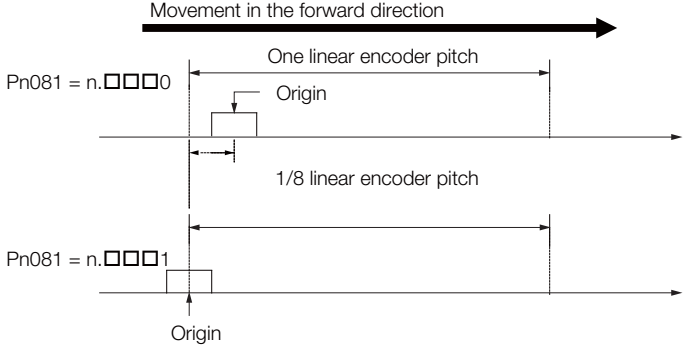

Observe the following precaution if you set Pn081 to n.□□□0 (Output phase-C pulses only in the forward direction).

When a linear incremental encoder from Magnescale Co., Ltd. is used, the count direction of the encoder determines how the phase-C pulse (CN1-21 and CN1-22) is output.

Note: The count direction (up or down) of the linear encoder determines whether a phase-C pulse is output. The output of the pulse does not depend on the setting of the movement direction (Pn000 = n.□□□1).

Encoder Model	Interpolator	Linear Encoder Pitch [μm]
SL710	PL101-RY MJ620-T13	800
SL720		800
SL730		800
	SR75	80
	SR85	80
SQ10	MQ10-FLA	400
	MQ10-GLA	

■ When First Passing the Origin Signal in the Forward Direction and Returning after Turning ON the Power Supply

The encoder's phase-C pulse (CN1-21 and CN1-22) is output when the origin detection position is passed for the first time in the forward direction after the power supply is turned ON.

After that, the phase-C pulse is output whenever the origin detection position is passed in the forward or reverse direction.

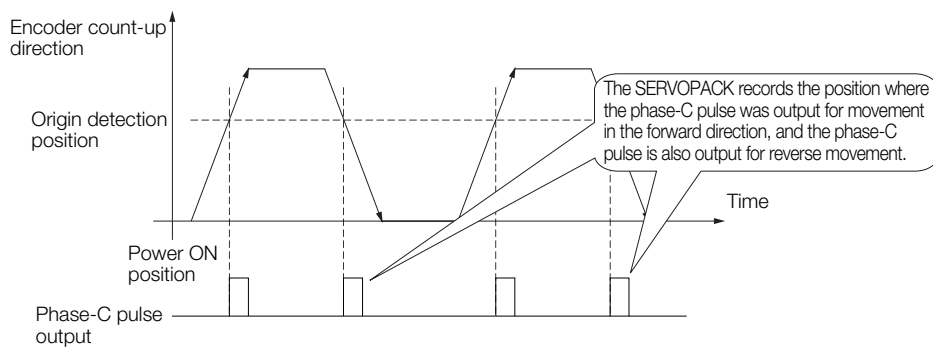

■ When First Passing the Origin Signal in the Reverse Direction and Returning after Turning ON the Power Supply

The encoder's phase-C pulse (CN1-19 and CN1-20) is not output when the origin detection position is passed for the first time in the reverse direction after the power supply is turned ON.

However, after the origin detection position is passed in the forward direction and the encoder's phase-C pulse is output, it will then also be output when the origin detection point is passed in the reverse direction.

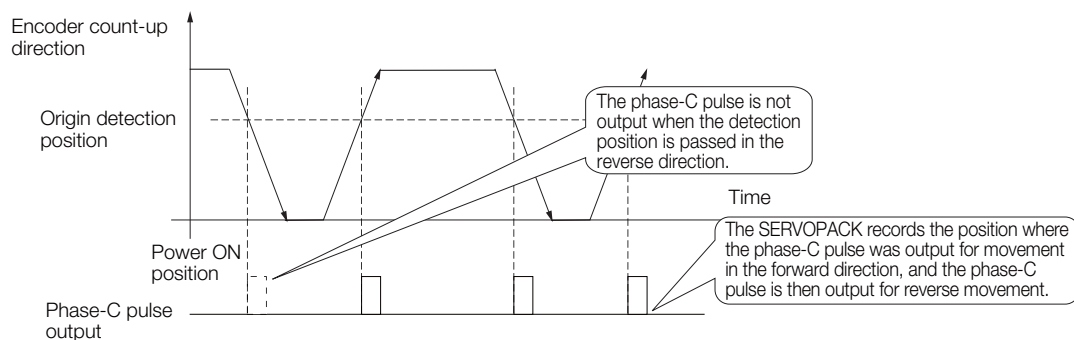

■ When Using a Linear Encoder with Multiple Origins and First Passing the Origin Position in the Forward Direction and Returning after Turning ON the Power Supply

The encoder's phase-C pulse is output when the origin detection position is passed for the first time in the forward direction after the power supply is turned ON. After that, the phase-C pulse is output whenever the origin detection position is passed in the forward or reverse direction.

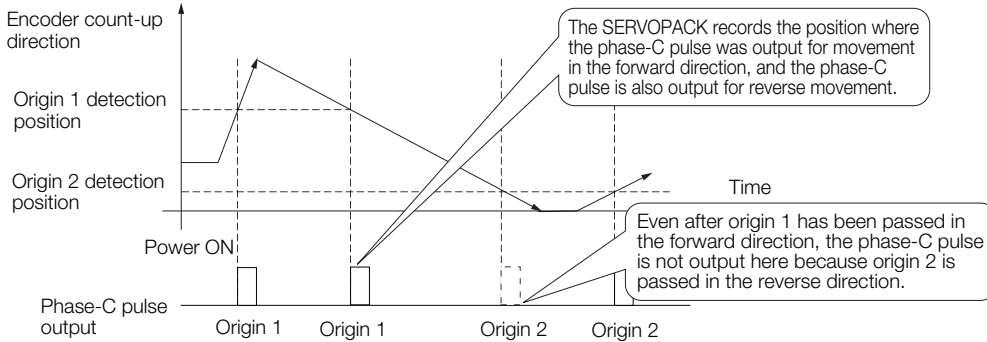

■ When Using a Linear Encoder with Multiple Origins and First Passing the Origin Position in the Reverse Direction after Turning ON the Power Supply

The encoder's phase-C pulse is not output when the origin detection position is passed for the first time in the reverse direction after the power supply is turned ON. However, after the origin detection position is passed in the forward direction and the encoder's phase-C pulse is output, it will then also be output when the origin detection point is passed in the reverse direction.

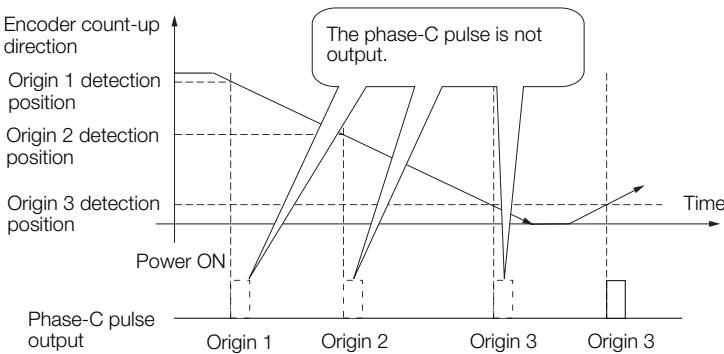

7.5.2 Setting for the Encoder Divided Pulse Output

This section describes the setting for the encoder divided pulse output for a Rotary Servomotor or Linear Servomotor.

Encoder Divided Pulse Output When Using a Rotary Servomotor

If you will use a Rotary Servomotor, set the number of encoder output pulses (Pn212).

Pn212 (2212h)	Number of Encoder Output Pulses					
				Speed	Position	Torque
	Setting Range	Setting Unit	Default Setting	When Enabled	Classification	
	16 to 1,073,741,824	1 P/Rev	2,048	After restart	Setup	

The number of pulses from the encoder per rotation are processed inside the SERVOPACK, divided by the setting of Pn212, and then output.

Set the number of encoder divided output pulses according to the system specifications of the machine or host controller.

The setting of the number of encoder output pulses is limited by the resolution of the encoder.

Setting of the Number of Encoder Output Pulses [P/Rev]	Setting Increment	Encoder Resolution	Upper Limit of Servomotor Speed for Set Number of Encoder Output Pulses [min^{-1}]
		24 bits (16,777,216 pulses)	
16 to 16,384	1	○	6,000
16,386 to 32,768	2	○	3,000
32,772 to 65,536	4	○	1,500
65,544 to 131,072	8	○	750
131,088 to 262,144	16	○	375
262,176 to 524,288	32	○	187
524,352 to 1,048,576	64	○	93
1,048,704 to 2,097,152	128	○*	46
2,097,408 to 4,194,304	256	○*	23

* Available only for incremental encoder

Note: 1. The setting range of the number of encoder output pulses (Pn212) depends on the resolution of the Servomotor encoder. An A.041 alarm (Encoder Output Pulse Setting Error) will occur if the above setting conditions are not met.

Correct setting example: Pn212 can be set to 25,000 [P/Rev].

Incorrect setting example: Pn212 cannot be set to 25,001 (P/Rev) because the setting increment in the above table is not used.

2. The upper limit of the pulse frequency is approximately 1.6 Mpps. The Servomotor speed will be limited if the setting of the number of encoder output pulses is too high.

An A.511 alarm (Encoder Output Pulse Overspeed) will occur if the upper limit of the motor speed is exceeded.

Output example: An output example is given below for the PAO (Encoder Pulse Output Phase A) signal and the PBO (Encoder Pulse Output Phase B) signal when Pn212 is set to 16 (16 pulses output per revolution).

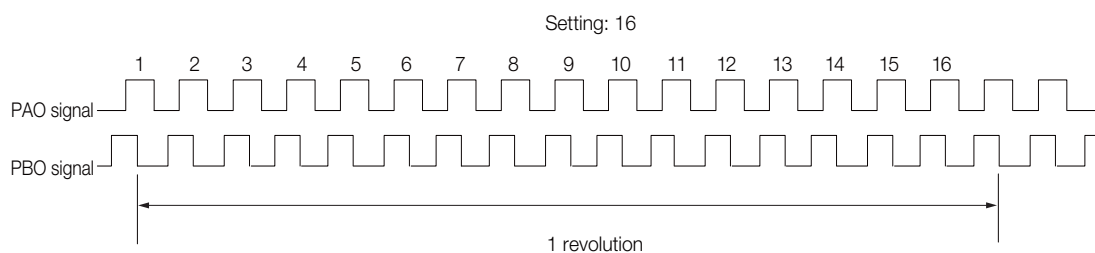

Encoder Divided Pulse Output When Using a Linear Servomotor

If you will use a Linear Servomotor, set the encoder output resolution (Pn281).

Pn281 (2281h)	Encoder Output Resolution				Speed	Position	Force
	Setting Range	Setting Unit	Default Setting	When Enabled	Classification		
	1 to 4,096	1 edge/pitch	20	After restart	Setup		

- Note: 1. The maximum setting for the encoder output resolution is 4,096. Pulse output at a linear encoder resolution of 4,096 or higher is not possible.
 2. If the setting of Pn281 exceeds the resolution of the external encoder, the A.041 alarm (Encoder Output Pulse Setting Error) will be output.

Set the encoder output resolution for the encoder pulse output signals (PAO, /PAO, PBO, and /PBO) from the SERVOPACK to the host controller.

The number of feedback pulses per linear encoder pitch is divided by the setting of Pn281 (after multiplication by 4) inside the SERVOPACK and then the resulting number of pulses is output. Set the parameter according to the system specifications of the machine or host controller.

The setting range depends on the Servomotor’s maximum speed (Pn385) and the linear scale pitch (Pn282). * You can calculate the upper limit of the setting of Pn281 with the following formula.

$$\text{Upper limit of Pn281} = \frac{\text{Linear Encoder Pitch} \times 100}{\text{Pn385}} \times 72$$

* The value depends on whether a Serial Converter Unit is used.

Using a Serial Converter Unit	Setting of Pn282
Not Using a Serial Converter Unit (when the linear encoder and SERVOPACK are connected directly or when a linear encoder that does not require a Serial Converter Unit is used)	The linear encoder pitch is automatically detected by the SERVOPACK, so the setting of Pn282 is disabled.

Information When the linear encoder pitch is 4 μm, the maximum motor speed is limited to 1 m/s because of the maximum response frequency of the Serial Converter Unit. If the setting is out of range or does not satisfy the setting conditions, an A.041 alarm (Encoder Output Pulse Setting Error) will be output. If the motor speed exceeds the upper limit for the set encoder output resolution, an A.511 alarm (Encoder Output Pulse Overspeed) will be output. The upper limit of the encoder output resolution is restricted by the dividing specifications of the Serial Converter Unit.

Example **Setting Example**
 Correct setting for a linear encoder pitch of 20 μm and a maximum motor speed of 5 m/s (Pn385 = 50): Pn281 = 28 (edges/pitch)
 Incorrect setting: Pn281 = 29 (edges/pitch) (An A.041 alarm would be output.)

Example **Pulse Output Example**
 When Pn281 = 20 (20-edge output (5-pulse output) per linear encoder pitch)

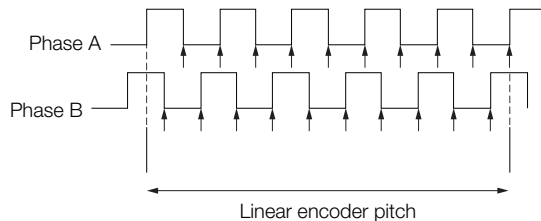

7.6 Software Limits

You can set limits in the software for machine movement that do not use the overtravel signals (P-OT and N-OT). If a software limit is exceeded, an emergency stop will be executed in the same way as it is for overtravel.

Refer to the following section for details on this function.

 *Software Position Limits (607Dh)* on page 15-31

7.7 Selecting Torque Limits

You can limit the torque that is output by the Servomotor.

There are four different ways to limit the torque. These are described in the following table.

Limit Method	Outline	Control Method	Reference
Internal Torque Limits	The torque is always limited with the setting of a parameter.	Speed control, position control, or torque control	7.7.1
External Torque Limits	The torque is limited with an input signal from the host computer.		7.7.2
Limiting Torque with <i>controlword</i> (6040h)	A command from the Controller enables the torque limit that is set in a parameter.	Speed control or position control	15.6
Limiting Torque with <i>positive torque limit value</i> (60E0h) and <i>negative torque limit value</i> (60E1h)	Torque is controlled with torque limits from the Controller.		14.7

Note: If you set a value that exceeds the maximum torque of the Servomotor, the torque will be limited to the maximum torque of the Servomotor.

7.7.1 Internal Torque Limits

If you use internal torque limits, the maximum output torque will always be limited to the specified forward torque limit (Pn402) and reverse torque limit (Pn403).

- Rotary Servomotors

Pn402 (2402h)	Forward Torque Limit			<input type="checkbox"/> Speed	<input type="checkbox"/> Position	<input type="checkbox"/> Torque
	Setting Range	Setting Unit	Default Setting	When Enabled	Classification	
	0 to 800	1%*	800	Immediately	Setup	
Pn403 (2403h)	Reverse Torque Limit			<input type="checkbox"/> Speed	<input type="checkbox"/> Position	<input type="checkbox"/> Torque
	Setting Range	Setting Unit	Default Setting	When Enabled	Classification	
	0 to 800	1%*	800	Immediately	Setup	

* Set a percentage of the rated motor torque.

Note: If the setting of Pn402 or Pn403 is too low, the torque may be insufficient for acceleration or deceleration of the Servomotor.

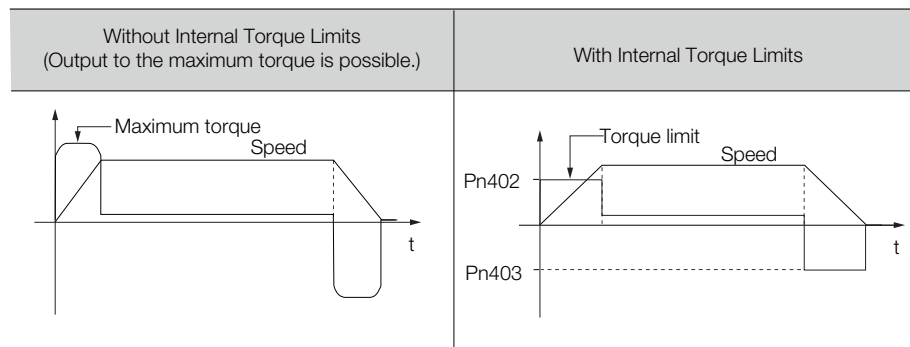

- Linear Servomotors

Pn483 (2483h)	Forward Force Limit			Speed	Position	Force
	Setting Range	Setting Unit	Default Setting	When Enabled	Classification	
	0 to 800	1%*	30	Immediately	Setup	
Pn484 (2484h)	Reverse Force Limit			Speed	Position	Force
	Setting Range	Setting Unit	Default Setting	When Enabled	Classification	
	0 to 800	1%*	30	Immediately	Setup	

* Set a percentage of the rated motor force.

Note: If the setting of Pn483 or Pn484 is too low, the force may be insufficient for acceleration or deceleration of the Servomotor.

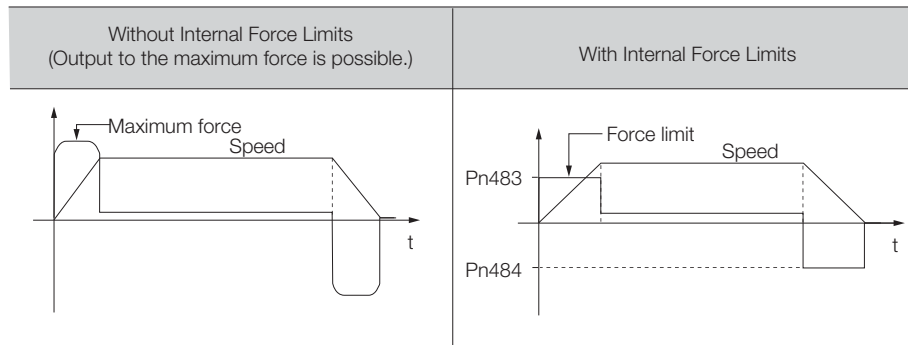

7.7.2 External Torque Limits

You can limit the torque only when required by the operating conditions of the machine by turning a signal ON and OFF.

You can use this for applications such as stopping on physical contact, or holding a workpiece with a robot.

External Torque Limit Reference Signals

The /P-CL (Forward External Torque Limit) and /N-CL (Reverse External Torque Limit) signals are used as the external torque limit reference signals. The /P-CL signal is used for the forward torque limit and the /N-CL signal is used for the reverse torque limit.

Type	Signal	Connector Pin No.	Signal Status	Meaning
Input	/P-CL	Must be allocated.	ON (closed)	Applies the forward external torque limit. The torque is limited to the smaller of the settings of Pn402*1 and Pn404.
			OFF (open)	Cancels the forward external torque limit. The torque is limited to the setting of Pn402*1.
Input	/N-CL	Must be allocated.	ON (closed)	Applies the reverse external torque limit. The torque is limited to the smaller of the settings of Pn403*2 and Pn404.
			OFF (open)	Cancels the reverse external torque limit. The torque is limited to the setting of Pn403*2.

*1. Pn483 is used for a Linear Servomotor.

*2. Pn484 is used for a Linear Servomotor.

Note: You must allocate the /P-CL and /N-CL signals to use them. You can use the following parameters to allocate the signal to a terminal.

- Pn50B = n.X□□□ (/P-CL (Forward External Torque Limit Input) Signal Allocation)
- Pn50B = n.X□□□ (/N-CL (Reverse External Torque Limit Input) Signal Allocation)

Refer to the following section for details.

7.1.1 Input Signal Allocations on page 7-4

Setting the Torque Limits

The parameters that are related to setting the torque limits are given below.

- Rotary Servomotors

If the setting of Pn402 (Forward Torque Limit), Pn403 (Reverse Torque Limit), Pn404 (Forward External Torque Limit), or Pn405 (Reverse External Torque Limit) is too low, the torque may be insufficient for acceleration or deceleration of the Servomotor.

Pn402 (2402h)	Forward Torque Limit				<input type="checkbox"/> Speed	<input type="checkbox"/> Position	<input type="checkbox"/> Torque
	Setting Range	Setting Unit	Default Setting	When Enabled	Classification		
	0 to 800	1%*	800	Immediately	Setup		
Pn403 (2403h)	Reverse Torque Limit				<input type="checkbox"/> Speed	<input type="checkbox"/> Position	<input type="checkbox"/> Torque
	Setting Range	Setting Unit	Default Setting	When Enabled	Classification		
	0 to 800	1%*	800	Immediately	Setup		
Pn404 (2404h)	Forward External Torque Limit				<input type="checkbox"/> Speed	<input type="checkbox"/> Position	<input type="checkbox"/> Torque
	Setting Range	Setting Unit	Default Setting	When Enabled	Classification		
	0 to 800	1%*	100	Immediately	Setup		
Pn405 (2405h)	Reverse External Torque Limit				<input type="checkbox"/> Speed	<input type="checkbox"/> Position	<input type="checkbox"/> Torque
	Setting Range	Setting Unit	Default Setting	When Enabled	Classification		
	0 to 800	1%*	100	Immediately	Setup		

* Set a percentage of the rated motor torque.

- Linear Servomotors

If the setting of Pn483 (Forward Force Limit), Pn484 (Reverse Force Limit), Pn404 (Forward External Force Limit), or Pn405 (Reverse External Force Limit) is too low, the force may be insufficient for acceleration or deceleration of the Servomotor.

Pn483 (2483h)	Forward Force Limit				<input type="checkbox"/> Speed	<input type="checkbox"/> Position	<input type="checkbox"/> Force
	Setting Range	Setting Unit	Default Setting	When Enabled	Classification		
	0 to 800	1%*	30	Immediately	Setup		
Pn484 (2484h)	Reverse Force Limit				<input type="checkbox"/> Speed	<input type="checkbox"/> Position	<input type="checkbox"/> Force
	Setting Range	Setting Unit	Default Setting	When Enabled	Classification		
	0 to 800	1%*	30	Immediately	Setup		
Pn404 (2404h)	Forward External Force Limit				<input type="checkbox"/> Speed	<input type="checkbox"/> Position	<input type="checkbox"/> Force
	Setting Range	Setting Unit	Default Setting	When Enabled	Classification		
	0 to 800	1%*	100	Immediately	Setup		
Pn405 (2405h)	Reverse External Force Limit				<input type="checkbox"/> Speed	<input type="checkbox"/> Position	<input type="checkbox"/> Force
	Setting Range	Setting Unit	Default Setting	When Enabled	Classification		
	0 to 800	1%*	100	Immediately	Setup		

* Set a percentage of the rated motor force.

Changes in the Output Torque for External Torque Limits

The following table shows the changes in the output torque when the internal torque limit is set to 800%.

- Rotary Servomotors

It is assumed that counterclockwise is set as the forward direction of motor rotation (Pn000 = n.□□□0).

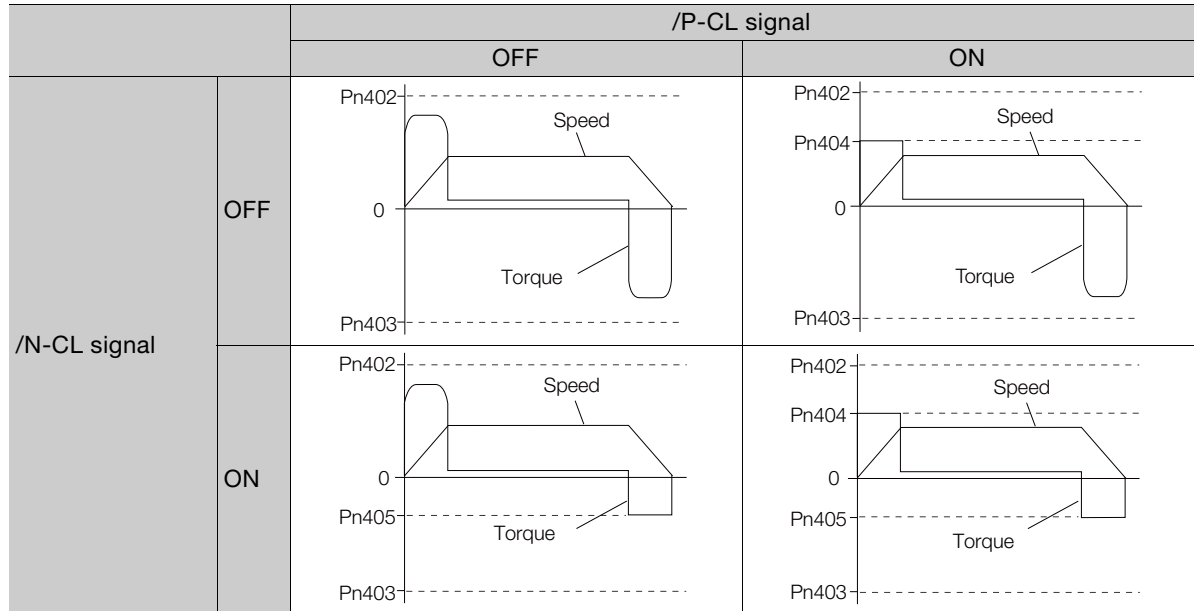

- Linear Servomotors

It is assumed that the linear encoder count-up direction is set as the forward direction of motor movement (Pn000 = n.□□□0).

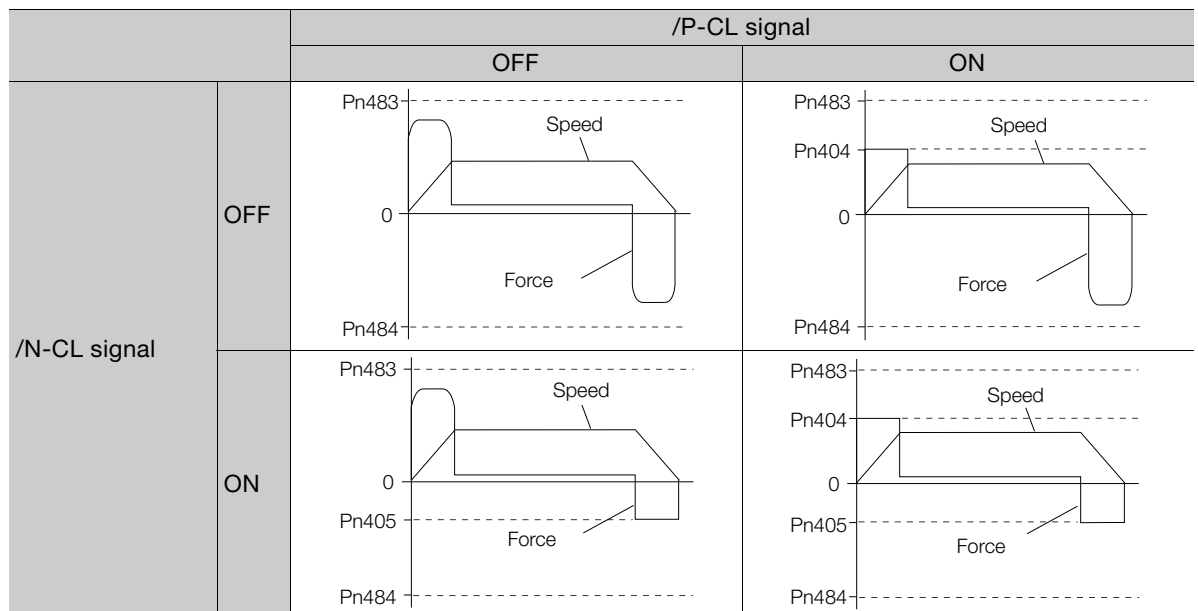

7.7.3 /CLT (Torque Limit Detection) Signal

This section describes the /CLT signal, which indicates the status of limiting the motor output torque.

Type	Signal	Connector Pin No.	Signal Status	Meaning
Output	/CLT	Must be allocated.	ON (closed)	The motor output torque is being limited.
			OFF (open)	The motor output torque is not being limited.

Note: You must allocate the /CLT signal to use it. Use Pn50F = n.□□□X (/CLT (Torque Limit Detection) Signal Allocation) to allocate the signal to a connector pin. Refer to the following section for details.

 [7.1.2 Output Signal Allocations](#) on page 7-5

7.8 Absolute Encoders

The absolute encoder records the current position of the stop position even when the power supply is OFF.

With a system that uses an absolute encoder, the host controller can monitor the current position. Therefore, it is not necessary to perform an origin return operation when the power supply to the system is turned ON.

There are two types of encoders for Rotary Servomotors. The usage of the encoder is specified in Pn002 = n.□X□□.

Refer to the following section for encoder models.

 **Encoder Resolution** on page 6-43

• Parameter Settings When Using an Incremental Encoder

Parameter	Meaning	When Enabled	Classification
Pn002 (2002h)	n.□0□□ (default setting)	After restart	Setup
	n.□1□□		
	n.□2□□		

• Parameter Settings When Using a Multiturn Absolute Encoder

Parameter	Meaning	When Enabled	Classification
Pn002 (2002h)	n.□0□□ (default setting)	After restart	Setup
	n.□1□□		
	n.□2□□		

NOTICE

- **Install a battery at either the host controller or on the Encoder Cable.**
If you install batteries both at the host controller and on the Encoder Cable at the same time, you will create a loop circuit between the batteries, resulting in a risk of damage or burning.

7.8.1 Connecting an Absolute Encoder

You can get the position data from the absolute encoder with EtherCAT communications. Therefore, it is not necessary to wire the PAO, PBO, and PCO (Encoder Divided Pulse Output) signals.

If they need to be wired, refer to the following section.

 **4.4.3 Wiring the SERVOPACK to the Encoder** on page 4-20

 **4.5.3 I/O Signal Wiring Examples** on page 4-33

7.8.2 Structure of the Position Data of the Absolute Encoder

The position data of the absolute encoder is the position coordinate from the origin of the absolute encoder.

The position data from the absolute encoder contains the following two items.

- The number of rotations from the origin of the encoder coordinate system (called the multiturn data)
- The position (number of pulses) within one rotation

The position data of the absolute encoder is as follows:

Position data of absolute encoder = Multiturn data × Number of pulses within one encoder rotation (setting of Pn212) + Position (number of pulses) within one rotation.

For a single-turn absolute encoder, the multiturn data is 0.

7.8.3 Output Ports for the Position Data from the Absolute Encoder

You can read the position data of the absolute encoder from the PAO, PBO, and PCO (Encoder Divided Pulse Output) signals.

The output method and timing for the position data of the absolute encoder are different in each case.

A conceptual diagram of the connections of the PAO, PBO, and PCO (Encoder Divided Pulse Output) signals to the host controller is provided below.

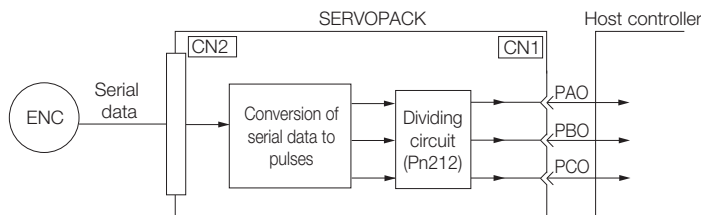

Signal	Status	Signal Contents
		When Using an Absolute Encoder
PAO	First signal	Multiturn data position within one rotation (pulse train)
	During normal operation	Incremental pulses
PBO	First signal	Position within one rotation (pulse train)
	During normal operation	Incremental pulses
PCO	Always	Origin pulse

The PAO (Encoder Divided Pulse Output) signal outputs the position data from the absolute encoder after the control power supply is turned ON.

The position data of the absolute encoder is the current stop position. The absolute encoder outputs the multiturn data with the specified protocol. The absolute encoder outputs the position within one rotation as a pulse train. It then outputs pulses as an incremental encoder (incremental operation status).

The host controller must have a reception circuit (e.g., UART) for the position data from the absolute encoder. The pulse counter at the host controller will not count pulses when the multiturn data (communications message) is input because only phase A is input. Counting starts from the position of the absolute encoder within one rotation.

The output circuits for the PAO, PBO, and PCO signals use line drivers. Refer to the following section for details on line drivers.

4.5.4 I/O Circuits on page 4-35

7.8.4 Reading the Position Data from the Absolute Encoder

The sequence to read the position data from the absolute encoder of a Rotary Servomotor is given below.

The multiturn data is sent according to the transmission specifications.

The position of the absolute encoder within one rotation is output as a pulse train.

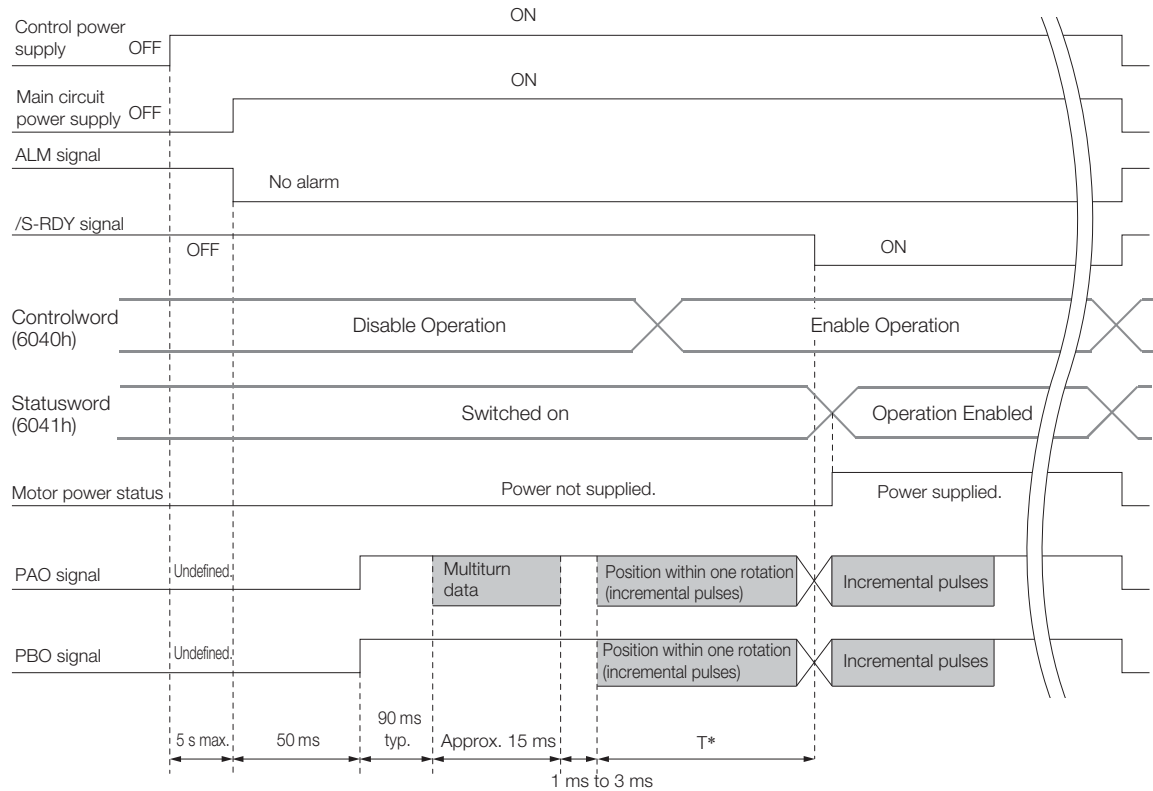

* The pulse output time T for the position of the absolute encoder within one rotation depends on the setting of Pn212 (Number of Encoder Output Pulses). Refer to the following table.

Setting of Pn212	Calculation of the Pulse Output Speed for the Position of the Absolute Encoder within One Rotation	Calculation of the Pulse Output Time T for the Position of the Absolute Encoder within One Rotation
16 to 16,384	$680 \times \text{Pn212}/16,384$ [kpps]	25 ms max.
16,386 to 32,768	$680 \times \text{Pn212}/32,768$ [kpps]	50 ms max.
32,722 to 65,536	$680 \times \text{Pn212}/65,536$ [kpps]	100 ms max.
65,544 to 131,072	$680 \times \text{Pn212}/131,072$ [kpps]	200 ms max.
131,088 to 262,144	$680 \times \text{Pn212}/262,144$ [kpps]	400 ms max.
262,176 to 524,288	$680 \times \text{Pn212}/524,288$ [kpps]	800 ms max.
524,352 to 1,048,576	$680 \times \text{Pn212}/1,048,576$ [kpps]	1,600 ms max.

7.8.5 Transmission Specifications

The position data transmission specifications for the PAO (Encoder Divided Pulse Output) signal are given in the following table.

The PAO signal sends only the multiturn data.

Refer to the following section for the timing of sending the position data from the absolute encoder.

 [7.8.4 Reading the Position Data from the Absolute Encoder](#) on page 7-33

Item	PAO signal
Synchronization Method	Start-stop synchronization (ASYNC)
Baud Rate	9,600 bps
Start Bits	1 bit
Stop Bits	1 bit
Parity	Even
Character Code	ASCII, 7 bits
Data Format	Refer to <i>Data Format of PAO Signal</i> .
Data Output Period	Only once after the control power supply is turned ON

Data Format of PAO Signal

As shown below, the message format consists of eight characters: "P," the sign, the 5-digit multiturn data, and "CR" (which indicates the end of the message).

P	Multiturn data (5 digits)
+ or -	
0 to 9	
0 to 9	
0 to 9	
0 to 9	
CR	

7.8.6 Calculating the Current Position in Machine Coordinates

When you reset the absolute encoder, the reset position becomes the reference position.

The host controller reads the coordinate P_S from the origin of the encoder coordinate system. The host controller must record the value of coordinate P_S .

This section describes the reference position in the machine coordinate system.

The method to calculate the coordinate value of the present position from the origin of the machine coordinate system is given below.

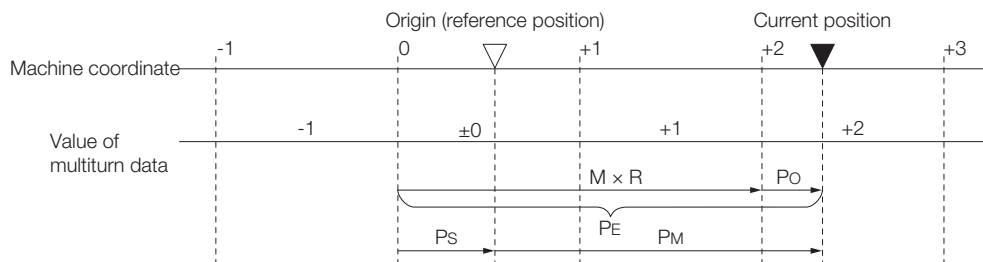

The current position P_M in the machine coordinate system is calculated as follows:

$$P_M = P_E - P_S$$

$$P_E = M \times R + P_O$$

$$P_S = M_S \times R + P_S'$$

Symbol	Meaning
P_E	Position data for the current position of the absolute encoder
M	Current position of the multiturn data of the absolute encoder
P_O	Position of the current position within one rotation
P_S	Position data of the absolute encoder when absolute encoder was reset
M_S	Multiturn data of the absolute encoder when absolute encoder was reset
P_S'	Position of the absolute encoder within one rotation when absolute encoder was reset
P_M	Current position in machine coordinate system
R	Pulses output per encoder rotation (value after dividing; setting of Pn212)



Note: The following formulas apply in Reverse Rotation Mode (Pn000 = n.□□□1).

$$P_M = P_E - P_S$$

$$P_E = -M \times R + P_O$$

$$P_S = M_S \times R + P_S'$$

Information

- If you are using a Rotary Servomotor, you must reset the absolute encoder. Refer to the following section for information on resetting the absolute encoder.
 [6.15 Resetting the Absolute Encoder](#) on page 6-49
- You can set the origin to a different position from the reset position. Refer to the following section for information on the origin position offset.
 [6.16 Setting the Origin of the Absolute Encoder](#) on page 6-52

7.8.7 Multiturn Limit Setting

The multiturn limit is used in position control for a turntable or other rotating body. For example, consider a machine that moves the turntable shown in the following diagram in only one direction.

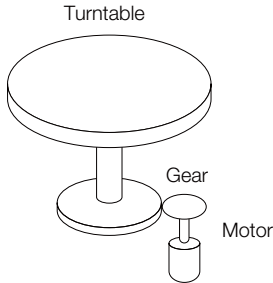

Because the turntable moves in only one direction, the upper limit to the number of rotations that can be counted by an absolute encoder will eventually be exceeded. The multiturn limit is used in cases like this to prevent fractions from being produced by the integer ratio of the number of Servomotor rotations and the number of turntable rotations.

For a machine with a gear ratio of n:m, as shown above, the value of m minus 1 will be the setting for the multiturn limit setting (Pn205).

$$\text{Multiturn limit (Pn205)} = m - 1$$

The relationship between the number of turntable revolutions and the number of motor revolutions is shown in the following graph for when m is 100 and n is 3.

Set Pn205 to 99.

$$\text{Pn205} = 100 - 1 = 99$$

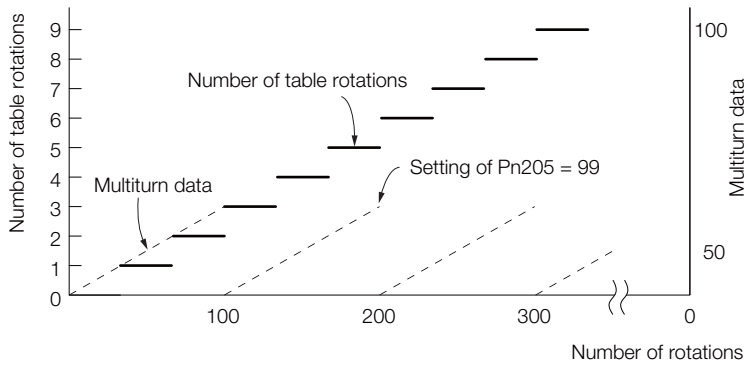

Pn205 (2205h)	Multiturn Limit			Speed	Position	Torque
	Setting Range	Setting Unit	Default Setting	When Enabled	Classification	
	0 to 65,535	1 Rev	65,535	After restart	Setup	

Note: This parameter is enabled when you use an absolute encoder.

The data will change as shown below when this parameter is set to anything other than the default setting.

- If the motor operates in the reverse direction when the multiturn data is 0, the multiturn data will change to the value set in Pn205.
- If the motor operates in the forward direction when the multiturn data is at the value set in Pn205, the multiturn data will change to 0.

Set Pn205 to one less than the desired multiturn data.

If you change the multiturn limit in Pn205, an A.CC0 alarm (Multiturn Limit Disagreement) will be displayed because the setting disagrees with the value in the encoder. Refer to the following section for the procedure to change the multiturn limit settings in the encoder.

7.8.8 Multiturn Limit Disagreement Alarm (A.CC0) on page 7-37

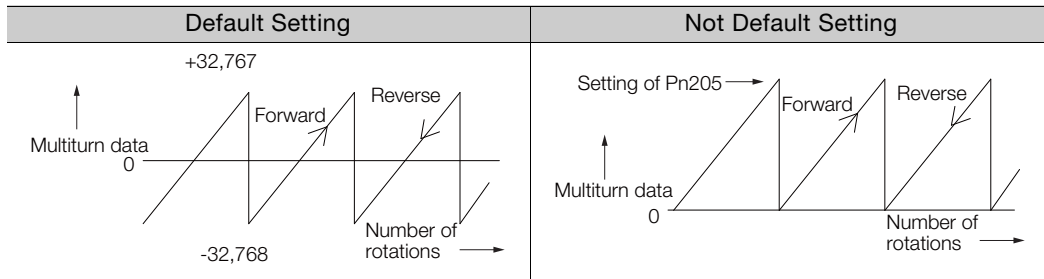

Information When the encoder is set to be used as a single-turn absolute encoder (Pn002 = n.□2□□), the multiturn data will always be zero. It is not necessary to reset the absolute encoder. Also, an alarm related to the absolute encoder (A.810 or A.820) will not occur.

7.8.8 Multiturn Limit Disagreement Alarm (A.CC0)

If you change the multiturn limit in Pn205 (Multiturn Limit), an A.CC0 alarm (Multiturn Limit Disagreement) will be displayed because the setting disagrees with the value in the encoder.

Display	Name	Meaning
A.CC0	Multiturn Limit Disagreement	Different multiturn limits are set in the encoder and SERVOPACK.

If this alarm is displayed, use the following procedure to change the multiturn limit in the encoder to the same value as the setting of Pn205.

Applicable Tools

The following table lists the tools that you can use to set the multiturn limit.

Tool	Fn No./Function Name	Operating Procedure Reference
Digital Operator	Fn013	📖 Σ -7-Series Digital Operator Operating Manual (Manual No.: SIEP S800001 33)
SigmaWin+	Encoder Setting - Multi-turn Limit Setup	👉 Operating Procedure on page 7-38
EtherCAT communications	SERVOPACK Adjusting Command (2710h)	👉 <i>SERVOPACK Adjusting Command (2710h)</i> on page 15-19

Operating Procedure

Use the following procedure to adjust the multiturn limit setting.

1. Click the  Servo Drive Button in the workspace of the Main Window of the SigmaWin+.
2. Select **Multiturn Limit Setting** in the Menu Dialog Box.
The Multiturn Limit Setting Dialog Box will be displayed.
3. Click the **Continue** Button.

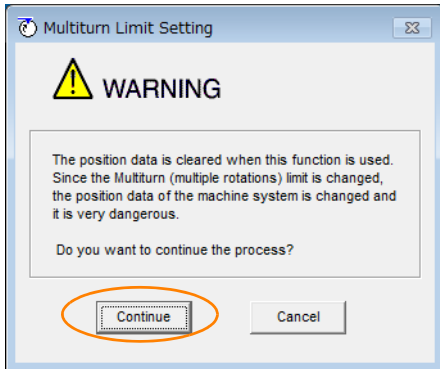

Click the **Cancel** Button to cancel setting the multiturn limit.
The Main Window will return.

4. Change the setting.

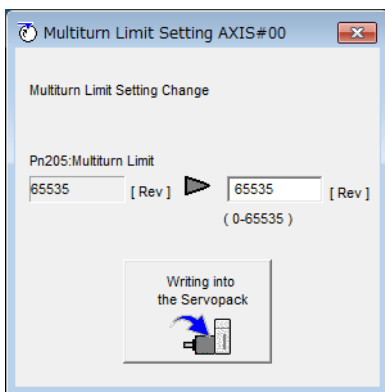

5. Click the **Writing into the Servopack** Button.
6. Click the **OK** Button.

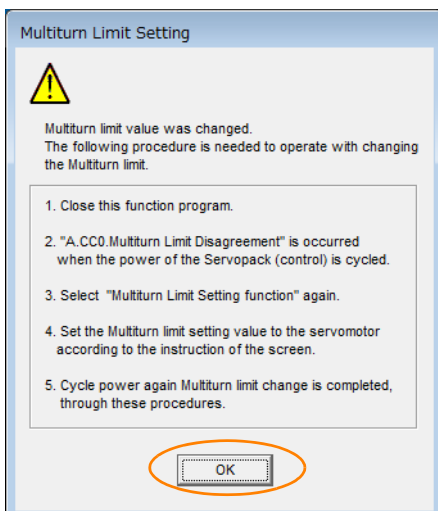

7. Turn the power supply to the SERVOPACK OFF and ON again.
An A.CC0 alarm (Multiturn Limit Disagreement) will occur because setting the multiturn limit in the Servomotor is not yet completed even though the setting has been changed in the SERVOPACK.
8. Display the Multiturn Limit Setting in the Menu Dialog Box.
9. Click the **Continue** Button.

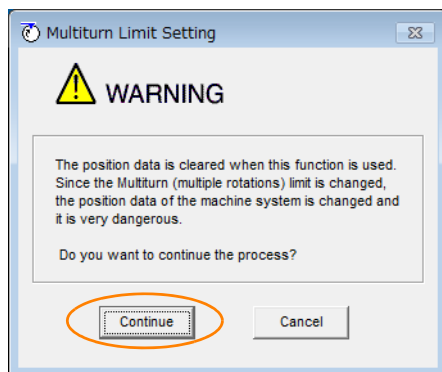

10. Click the **Writing into the Motor** Button.

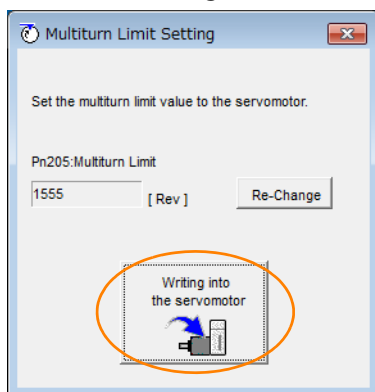

Click the **Re-change** Button to change the setting.

11. Click the **OK** Button.

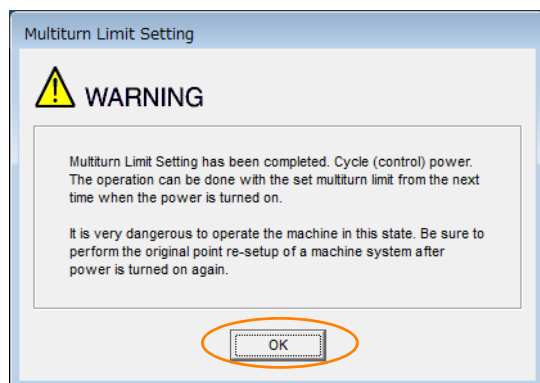

This concludes the procedure to set the multiturn limit.

7.9 Absolute Linear Encoders

The absolute linear encoder records the current position of the stop position even when the power supply is OFF.

With a system that uses an absolute linear encoder, the host controller can monitor the current position. Therefore, it is not necessary to perform an origin return operation when the power supply to the system is turned ON.

There are two types of linear encoders for Linear Servomotors. The usage of the linear encoder is specified in Pn002 = n.□X□□.

Refer to the following section for linear encoder models.

 **Feedback Resolution of Linear Encoder** on page 6-44

• **Parameter Settings When Using an Incremental Linear Encoder**

Parameter		Meaning	When Enabled	Classification
Pn002 (2002h)	n.□0□□ (default setting)	Use the encoder as an incremental linear encoder.	After restart	Setup
	n.□1□□	Use the encoder as an incremental linear encoder.		

• **Parameter Settings When Using an Absolute Linear Encoder**

Parameter		Meaning	When Enabled	Classification
Pn002 (2002h)	n.□0□□ (default setting)	Use the encoder as an absolute linear encoder.	After restart	Setup
	n.□1□□	Use the encoder as an incremental linear encoder.		

7.9.1 Connecting an Absolute Linear Encoder

You can get the position data from the absolute linear encoder with EtherCAT communications. Therefore, it is not necessary to wire the PAO, PBO, and PCO (Encoder Divided Pulse Output) signals.

If they need to be wired, refer to the following section.

 **4.4.3 Wiring the SERVOPACK to the Encoder** on page 4-20

 **4.5.3 I/O Signal Wiring Examples** on page 4-33

7.9.2 Structure of the Position Data of the Absolute Linear Encoder

The position data of the absolute linear encoder is the distance (number of pulses) from the origin of the absolute linear encoder.

The position data is signed 36-bit data.

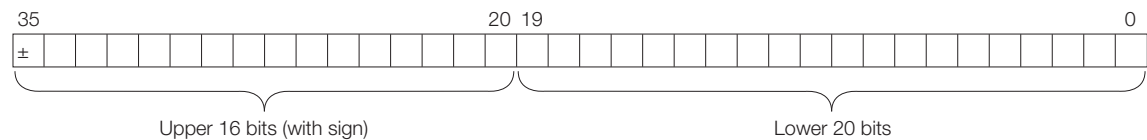

When the SERVOPACK sends the position data, it sends the upper 16-bit data (with sign) separately from the lower 20-bit data.

7.9.3 Output Ports for the Position Data from the Absolute Linear Encoder

You can read the position data of the absolute linear encoder from the PAO, PBO, and PCO (Encoder Divided Pulse Output) signals.

The output method and timing for the position data of the absolute linear encoder are different in each case.

A conceptual diagram of the connections of the PAO, PBO, and PCO (Encoder Divided Pulse Output) ports to the host controller is provided below.

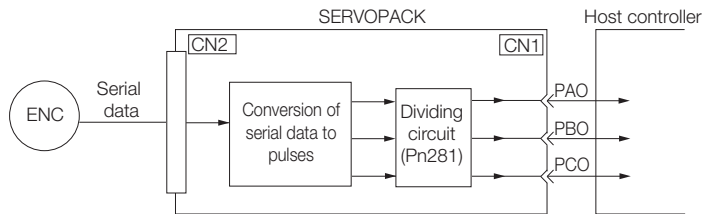

Signal	Status	Signal Contents
		When Using an Absolute Linear Encoder
PAO	First signal	Upper 16-bit data (with sign) Lower 20-bit data (pulse train)
	During normal operation	Incremental pulses
PBO	First signal	Lower 20-bit data (pulse train)
	During normal operation	Incremental pulses
PCO	Always	Origin pulse

The PAO (Encoder Divided Pulse Output) signal outputs the position data from the absolute linear encoder after the control power supply is turned ON.

The position data of the absolute linear encoder is the current stop position. The absolute linear encoder outputs the upper 16-bit data (with sign) according to the specified protocol. The absolute linear encoder outputs the lower 20-bit data as a pulse train. It then outputs pulses as an incremental linear encoder (incremental operation status).

The host controller must have a reception circuit (e.g., UART) for the position data from the absolute linear encoder. The pulse counter at the host controller will not count pulses when the upper 16-bit data (with sign) (communications message) is input because only phase A is input.

The output circuits for the PAO, PBO, and PCO signals use line drivers. Refer to the following section for details on line drivers.

 [4.5.4 I/O Circuits on page 4-35](#)

7.9.4 Reading the Position Data from the Absolute Linear Encoder

The sequence to read the position data from the absolute linear encoder of a Linear Servomotor is given below.

The upper 16-bit position data (with sign) are sent according to the transmission specifications.

The lower 20-bit data is output as a pulse train.

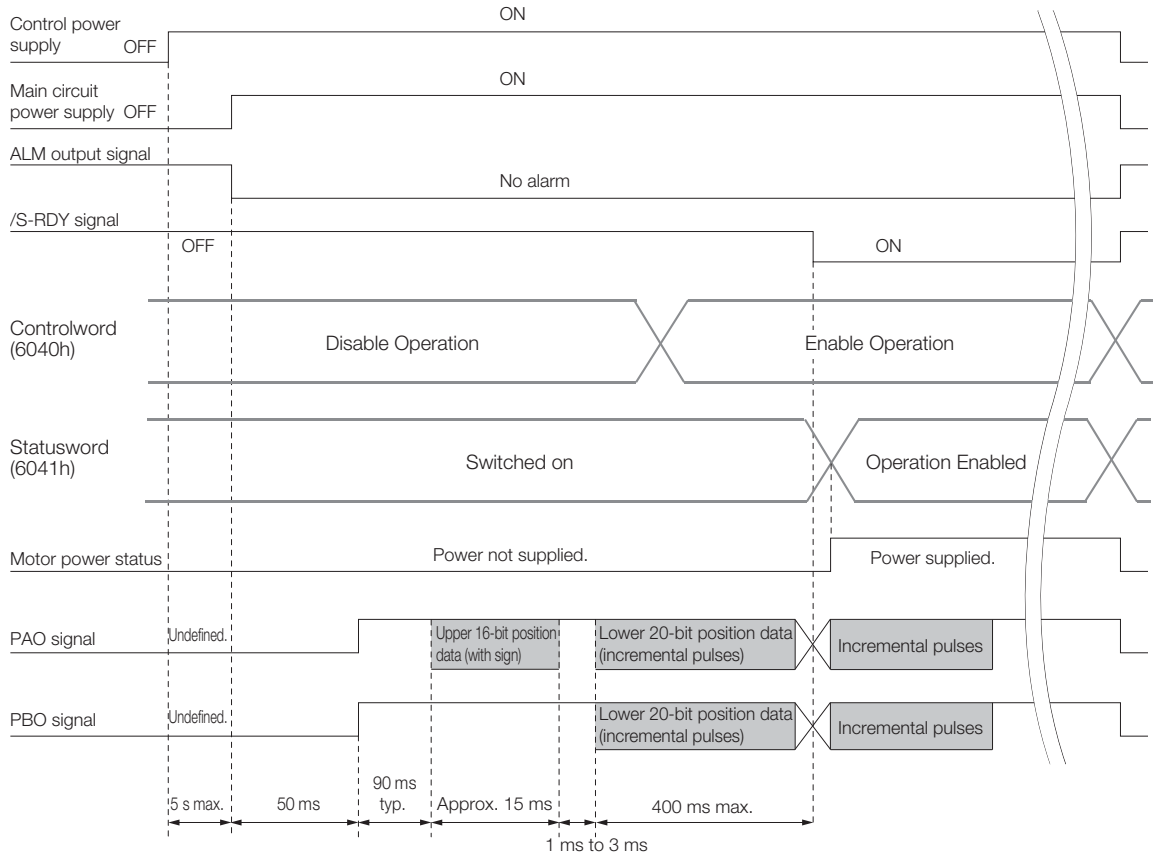

7.9.5 Transmission Specifications

The position data transmission specifications for the PAO (Encoder Divided Pulse Output) signal are given in the following table.

The PAO signal sends only the 16-bit data (with sign).

Refer to the following section for the timing of sending the position data from the absolute encoder.

7.9.4 Reading the Position Data from the Absolute Linear Encoder on page 7-42

Item	PAO signal
Synchronization Method	Start-stop synchronization (ASYNCR)
Baud Rate	9,600 bps
Start Bits	1 bit
Stop Bits	1 bit
Parity	Even
Character Code	ASCII, 7 bits
Data Format	Refer to <i>Data Format of PAO Signal</i> .
Data Output Period	Only once after the control power supply is turned ON

Data Format of PAO Signal

As shown below, the message format consists of eight characters: “P,” the sign, the 5-digit upper 15-bit position data, and “CR” (which indicates the end of the message).

P
+ or -
0 to 9
0 to 9
0 to 9
0 to 9
0 to 9
CR

Upper 15 bits
of position data

7.9.6 Calculating the Current Position in Machine Coordinates

With an absolute linear encoder, you must set the position of the origin (i.e., the origin of the machine coordinate system).

The host controller reads the coordinate from the origin of the encoder coordinate system. The host controller must record the value of this coordinate.

The method to calculate the coordinate value of the present position from the origin of the machine coordinate system is given below.

The position data from the absolute linear encoder is signed 36-bit data, but the upper 16 bits (with sign) and the lower 20 bits are output separately.

For the upper 16-bit data (with sign), the upper bits (16 bits, including the sign) of the current position after dividing by the setting of Pn281 are output with serial communications according to the transmission specifications.

For the lower 20-bit data, the lower bits (20 bits) of the current position after dividing by the setting of Pn281 are output as a pulse train.

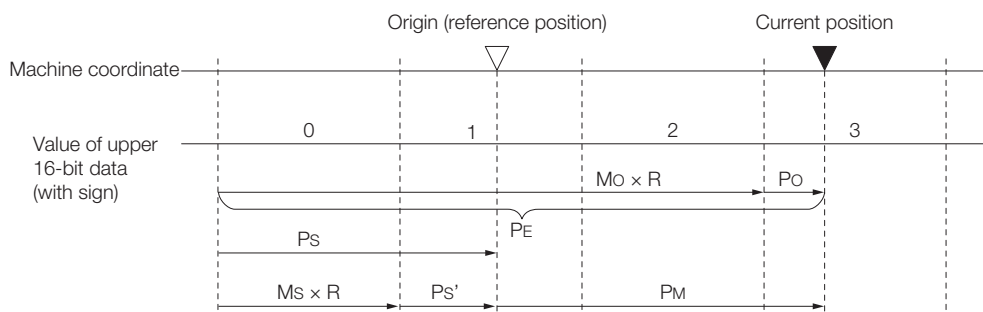

The current position P_M in the machine coordinate system is calculated as follows:

$$P_M = P_E - P_S$$

$$P_E = M_O \times R + P_O$$

$$P_S = M_S \times R + P_S'$$

Symbol	Meaning
P_E	Position data for the current position of the absolute linear encoder
M_O	Upper 16 bits (with sign) of the position data for the current position of the absolute linear encoder
P_O	Lower 20 bits of the position data for the current position of the absolute linear encoder
P_S	Position data of the origin
M_S	Upper 16 bits (with sign) of the position data of the origin
P_S'	Lower 20 bits of the position data of the origin
P_M	Current position in machine coordinate system
R	1048576 ($=2^{20}$)

Note: The above formulas also apply in reverse movement mode ($Pn000 = n.\square\square\square 1$).

Information

If you are using a Linear Servomotor, you do not need to reset the absolute linear encoder to define the origin. (Some absolute linear encoders also allow you to set any position as the origin.)

7.10 Software Reset

You can reset the SERVOPACK internally with the software. A software reset is used when resetting alarms and changing the settings of parameters that normally require turning the power supply to the SERVOPACK OFF and ON again. This can be used to change those parameters without turning the power supply to the SERVOPACK OFF and ON again.

Information

1. Always confirm that the servo is OFF and that the Servomotor is stopped before you start a software reset.
2. This function resets the SERVOPACK independently of the host controller. The SERVOPACK carries out the same processing as when the power supply is turned ON and outputs the ALM (Servo Alarm) signal. The status of other output signals may be forcibly changed.
3. When you execute a software reset, the SERVOPACK will not respond for approximately five seconds.
Before you execute a software reset, check the status of the SERVOPACK and Servomotor and make sure that no problems will occur.



7.10.1 Preparations

Always check the following before you perform a software reset.

- The servo must be OFF.
- The motor must be stopped.

7.10.2 Applicable Tools

The following table lists the tools that you can use to perform a software reset.

Tool	Fn No./Function Name	Operating Procedure Reference
Digital Operator	Fn030	 Σ -7-Series Digital Operator Operating Manual (Manual No.: SIEP S800001 33)
SigmaWin+	Basic Functions - Software Reset	 7.10.3 Operating Procedure on page 7-45

7.10.3 Operating Procedure

Use the following procedure to perform a software reset.

1. Click the  Servo Drive Button in the workspace of the Main Window of the SigmaWin+.
2. Select **Software Reset** in the Menu Dialog Box.
The Software Reset Dialog Box will be displayed.
3. Click the **Execute** Button.

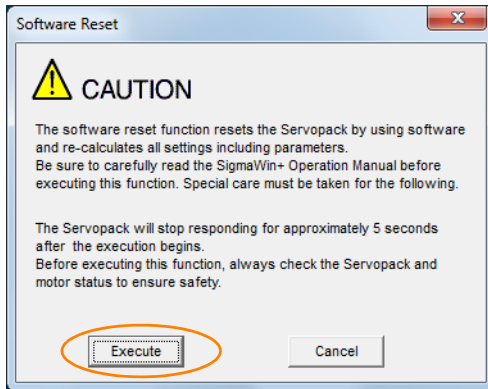

Click the **Cancel** Button to cancel the software reset. The Main Window will return.

4. Click the **Execute** Button.

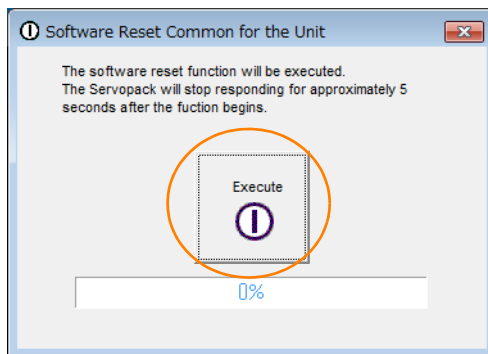

5. Click the **OK** Button to end the software reset operation.
All settings including parameters will have been re-calculated. When you finish this operation, disconnect the SigmaWin+ from the SERVOPACK, and then connect it again.



This concludes the procedure to reset the software.

7.11 Initializing the Vibration Detection Level

You can detect machine vibration during operation to automatically adjust the settings of Pn312 or Pn384 (Vibration Detection Level) to detect A.520 alarms (Vibration Alarm) and A.911 warnings (Vibration Warning) more precisely.

This function detects specific vibration components in the Servomotor speed.

Parameter		Meaning	When Enabled	Classification
Pn310 (2310h)	n.□□□0 (default setting)	Do not detect vibration.	Immediately	Setup
	n.□□□1	Output a warning (A.911) if vibration is detected.		
	n.□□□2	Output an alarm (A.520) if vibration is detected.		

If the vibration exceeds the detection level calculated with the following formula, an alarm or warning occurs according to Pn310 (Vibration Detection Selection).

- Rotary Servomotors

$$\text{Detection level} = \frac{\text{Vibration detection level (Pn312 [min-1])} \times \text{Vibration detection sensitivity (Pn311 [\%])}{100}$$

- Linear Servomotors

$$\text{Detection level} = \frac{\text{Vibration detection level (Pn384 [mm/s])} \times \text{Vibration detection sensitivity (Pn311 [\%])}{100}$$

Use this function only if A.520 or A.911 alarms are not output at the correct times when vibration is detected with the default vibration detection level (Pn312 or Pn384).

There will be discrepancies in the detection sensitivity for vibration alarms and warnings depending on the condition of your machine. If there is a discrepancy, use the above formula to adjust Pn311 (Vibration Detection Sensitivity).

Pn311 (2311h)	Vibration Detection Sensitivity			Speed	Position	Torque
	Setting Range	Setting Unit	Default Setting	When Enabled	Classification	
	50 to 500	1%	100	Immediately	Tuning	

Information

1. Vibration may not be detected because of unsuitable servo gains. Also, not all kinds of vibrations can be detected.
2. Set a suitable moment of inertia ratio (Pn103). An unsuitable setting may result in falsely detecting or not detecting vibration alarms or vibration warnings.
3. To use this function, you must input the actual references that will be used to operate your system.
4. Execute this function under the operating conditions for which you want to set the vibration detection level.
5. Execute this function while the motor is operating at 10% of its maximum speed or faster.



7.11.1 Preparations

Always check the following before you initialize the vibration detection level.

- The parameters must not be write prohibited.
- The test without a motor function must be disabled (Pn00C = n.□□□0).

7.11.2 Applicable Tools

The following table lists the tools that you can use to initialize the vibration detection level.

Tool	Fn No./Function Name	Operating Procedure Reference
Digital Operator	Fn01B	 Σ -7-Series Digital Operator Operating Manual (Manual No.: SIEP S800001 33)
SigmaWin+	<i>Others - Initialize Vibration Detection Level</i>	 7.11.3 Operating Procedure on page 7-47

7.11.3 Operating Procedure

Use the following procedure to initialize the vibration detection level.

1. Click the  Servo Drive Button in the workspace of the Main Window of the SigmaWin+.
2. Select **Initialize Vibration Detection Level** in the Menu Dialog Box.
The Initialize Vibration Detection Level Dialog Box will be displayed.
3. Select **Pn311: Vibration Detection Sensitivity** and **Pn310: Vibration Detection Selections** and then click the **Detection Start** Button.
A setting execution standby mode will be entered.

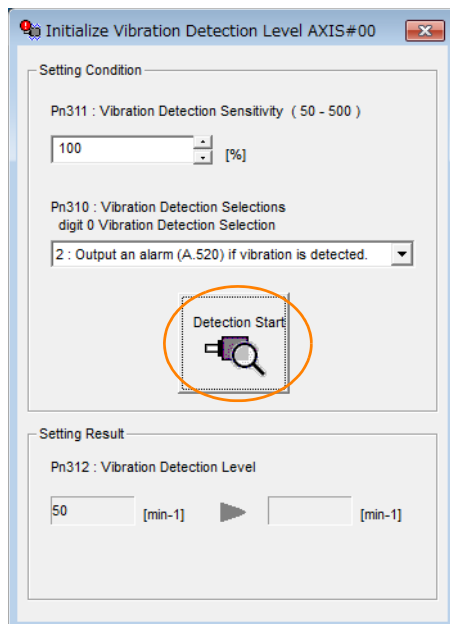

4. Click the **Execute** Button.

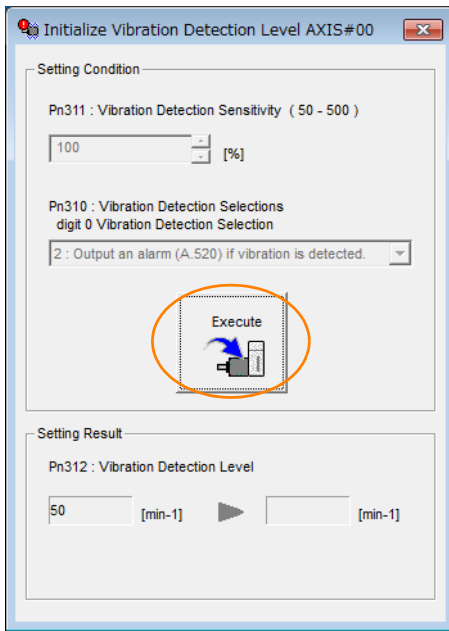

The newly set vibration detection level will be displayed and the value will be saved in the SERVO-PACK.

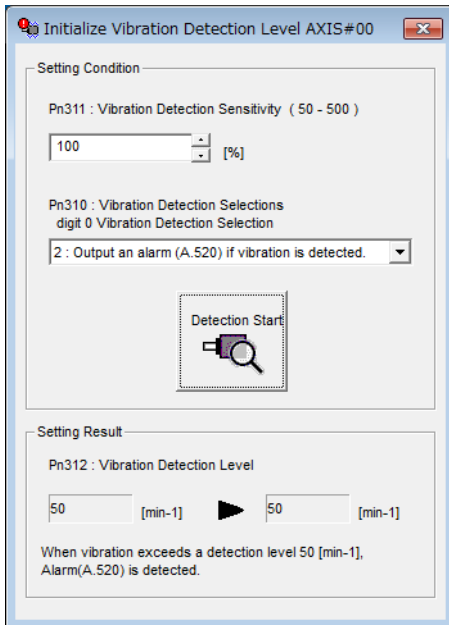

This concludes the procedure to initialize the vibration detection level.

7.11.4 Related Parameters

The following three items are given in the following table.

- Parameters Related to this Function
These are the parameters that are used or referenced when this function is executed.
- Changes during Function Execution
Not allowed: The parameter cannot be changed using the SigmaWin+ or other tool while this function is being executed.
Allowed: The parameter can be changed using the SigmaWin+ or other tool while this function is being executed.
- Automatic Changes after Function Execution
Yes: The parameter is automatically set or adjusted after execution of this function.
No: The parameter is not automatically set or adjusted after execution of this function.

Parameter	Name	Setting Changes	Automatic Changes
Pn311 (2311h)	Vibration Detection Sensitivity	Allowed	No
Pn312 (2312h)	Vibration Detection Level	Not allowed	Yes
Pn384 (2384h)	Vibration Detection Level	Not allowed	Yes

7.12 Adjusting the Motor Current Detection Signal Offset

The motor current detection signal offset is used to reduce ripple in the torque. You can adjust the motor current detection signal offset either automatically or manually.

7.12.1 Automatic Adjustment

Perform this adjustment only if highly accurate adjustment is required to reduce torque ripple. It is normally not necessary to adjust this offset.



Execute the automatic offset adjustment if the torque ripple is too large when compared with other SERVOPACKs.

Important

Information The offset does not use a parameter, so it will not change even if the parameter settings are initialized.



Preparations

Always check the following before you automatically adjust the motor current detection signal offset.

- The parameters must not be write prohibited.
- The servo must be in ready status.
- The servo must be OFF.

Applicable Tools

The following table lists the tools that you can use to automatically adjust the offset.

Tool	Fn No./Function Name	Operating Procedure Reference
Digital Operator	Fn00E	 Σ -7-Series Digital Operator Operating Manual (document No. SIEP S800001 33)
SigmaWin+	Others - Adjust the Motor Current Detection Offsets	 Operating Procedure on page 7-51
EtherCAT communications	SERVOPACK Adjusting Command (2710h)	 SERVOPACK Adjusting Command (2710h) on page 15-19

Operating Procedure

Use the following procedure to automatically adjust the motor current detection signal offset.

1. Click the  Servo Drive Button in the workspace of the Main Window of the SigmaWin+.
2. Select **Adjust the Motor Current Detection Signal Offsets** in the Menu Dialog Box. The Adjust the Motor Current Detection Signal Offsets Dialog Box will be displayed.
3. Click the **Continue** Button.

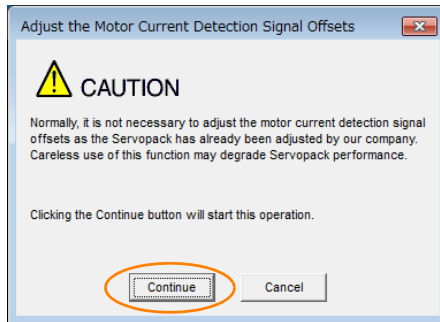

4. Click the **Automatic Adjustment** Tab in the Adjust the Motor Current Detection Signal Offsets Dialog Box.

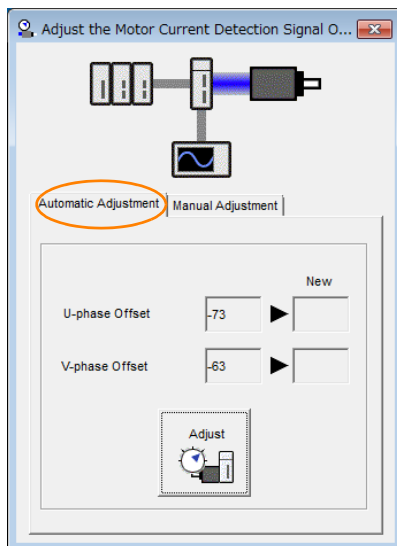

5. Click the **Adjust** Button.

The values that result from automatic adjustment will be displayed in the **New** Boxes.

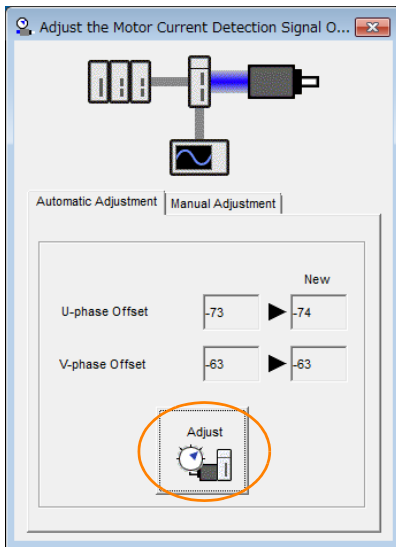

This concludes the procedure to automatically adjust the motor current detection signal offset.

7.12.2 Manual Adjustment

You can use this function if you automatically adjust the motor current detection signal offset and the torque ripple is still too large.



Important

If the offset is incorrectly adjusted with this function, the Servomotor characteristics may be adversely affected.

Observe the following precautions when you manually adjust the offset.

- Operate the Servomotor at a speed of approximately 100 min⁻¹.
- Adjust the offset while monitoring the torque reference with the analog monitor until the ripple is minimized.
- Adjust the offsets for the phase-U current and phase-V current of the Servomotor so that they are balanced. Alternately adjust both offsets several times.

Information

The offset does not use a parameter, so it will not change even if the parameter settings are initialized.

Preparations

Always check the following before you manually adjust the motor current detection signal offset.

- The parameters must not be write prohibited.

Applicable Tools

The following table lists the tools that you can use to manually adjust the offset.

Tool	Fn No./Function Name	Operating Procedure Reference
Digital Operator	Fn00F	Σ-7-Series Digital Operator Operating Manual (Manual No.: SIEP S800001 33)
SigmaWin+	Others - Adjust the Motor Current Detection Offsets	Operating Procedure on page 7-53

Operating Procedure

Use the following procedure to manually adjust the motor current detection signal offset.

1. Operate the motor at approximately 100 min⁻¹.
2. Click the Servo Drive Button in the workspace of the Main Window of the SigmaWin+.
3. Select **Adjust the Motor Current Detection Signal Offsets** in the Menu Dialog Box. The Adjust the Motor Current Detection Signal Offsets Dialog Box will be displayed.
4. Click the **Continue** Button.

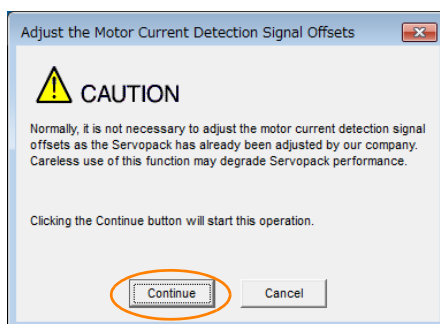

5. Click the **Manual Adjustment** Tab in the Adjust the Motor Current Detection Signal Offsets Dialog Box.

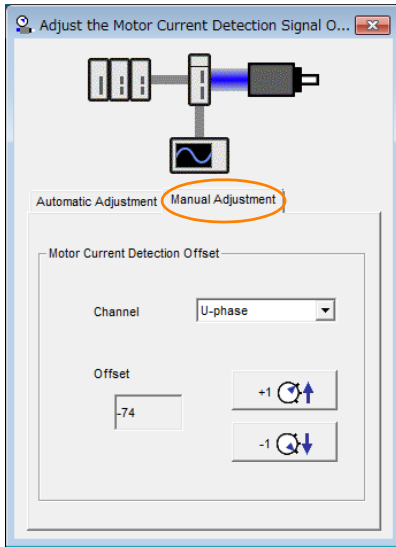

6. Set the **Channel** Box in the **Motor Current Detection Offset** Area to **U-phase**.
7. Use the **+1** and **-1** Buttons to adjust the offset for phase U.
Change the offset by about 10 in the direction that reduces the torque ripple.
Adjustment range: -512 to +511
8. Set the **Channel** Box in the **Motor Current Detection Offset** Area to **V-phase**.
9. Use the **+1** and **-1** Buttons to adjust the offset for phase V.
Change the offset by about 10 in the direction that reduces the torque ripple.
10. Repeat steps 6 to 9 until the torque ripple cannot be improved any further regardless of whether you increase or decrease the offsets.
11. Reduce the amount by which you change the offsets each time and repeat steps 6 to 9.

This concludes the procedure to manually adjust the motor current detection signal offset.

7.13 Forcing the Motor to Stop

You can force the Servomotor to stop for a signal from the host controller or an external device.

To force the motor to stop, you must allocate the FSTP (Forced Stop Input) signal in Pn516 = n.□□□X. You can specify one of the following stopping methods: dynamic brake (DB), coasting to a stop, or decelerating to a stop.

Note: Forcing the motor to stop is not designed to comply with any safety standard. In this respect, it is different from the hard wire base block (HWBB).

Information Panel Operator and Digital Operator Displays
When a forced stop is performed, the panel and the Digital Operator will display FSTP.

CAUTION

- To prevent accidents that may result from contact faults or disconnections, use a normally closed switch for the Forced Stop Input signal.

7.13.1 FSTP (Forced Stop Input) Signal

Classification	Signal	Connector Pin No.	Signal Status	Description
Input	FSTP	Must be allocated.	ON (closed)	Drive is enabled (normal operation).
			OFF (open)	The motor is stopped.

Note: You must allocate the FSTP signal to use it. Use Pn516 = n.□□□X (FSTP (Forced Stop Input) Signal Allocation) to allocate the FSTP signal to a connector pin. Refer to the following section for details.

 7.1.1 Input Signal Allocations on page 7-4

7.13.2 Stopping Method Selection for Forced Stops

Use Pn00A = n.□□X□ (Stopping Method for Forced Stops) to set the stopping method for forced stops.

Parameter	Description	When Enabled	Classification	
Pn00A (200Ah)	n.□□0□	After restart	Setup	
	n.□□1□ (default setting)			Apply the dynamic brake or coast the motor to a stop (use the stopping method set in Pn001 = n.□□□X).
	n.□□2□			Decelerate the motor to a stop using the torque set in Pn406 as the maximum torque. Use the setting of Pn001 = n.□□□X for the status after stopping.
	n.□□3□			Decelerate the motor to a stop using the torque set in Pn406 as the maximum torque and then let the motor coast.
	n.□□4□			Decelerate the motor to a stop using the deceleration time set in Pn30A. Use the setting of Pn001 = n.□□□X for the status after stopping.
	Decelerate the motor to a stop using the deceleration time set in Pn30A and then let the motor coast.			

Note: You cannot decelerate a Servomotor to a stop during torque control. For torque control, the Servomotor will be stopped with the dynamic braking or coast to a stop according to the setting of Pn001 = n.□□□X (Servo OFF or Alarm Group 1 Stopping Method).

Stopping the Servomotor by Setting Emergency Stop Torque (Pn406)

To stop the Servomotor by setting emergency stop torque, set Pn406 (Emergency Stop Torque).

If Pn00A = n.□□X□ is set to 1 or 2, the Servomotor will be decelerated to a stop using the torque set in Pn406 as the maximum torque.

The default setting is 800%. This setting is large enough to allow you to operate the Servomotor at the maximum torque. However, the maximum emergency stop torque that you can actually use is the maximum torque of the Servomotor.

Pn406 (2406h)	Emergency Stop Torque			Speed	Position
	Setting Range	Setting Unit	Default Setting	When Enabled	Classification
	0 to 800	1%*	800	Immediately	Setup

* Set a percentage of the motor rated torque.

Stopping the Servomotor by Setting the Deceleration Time for Servo OFF and Forced Stops (Pn30A)

To specify the Servomotor deceleration time and use it to stop the Servomotor, set Pn30A (Deceleration Time for Servo OFF and Forced Stops).

Pn30A (230Ah)	Deceleration Time for Servo OFF and Forced Stops			Speed	Position
	Setting Range	Setting Unit	Default Setting	When Enabled	Classification
	0 to 10,000	1 ms	0	Immediately	Setup

If you set Pn30A to 0, the Servomotor will be stopped with a zero speed.

The deceleration time that you set in Pn30A is the time to decelerate the motor from the maximum motor speed.

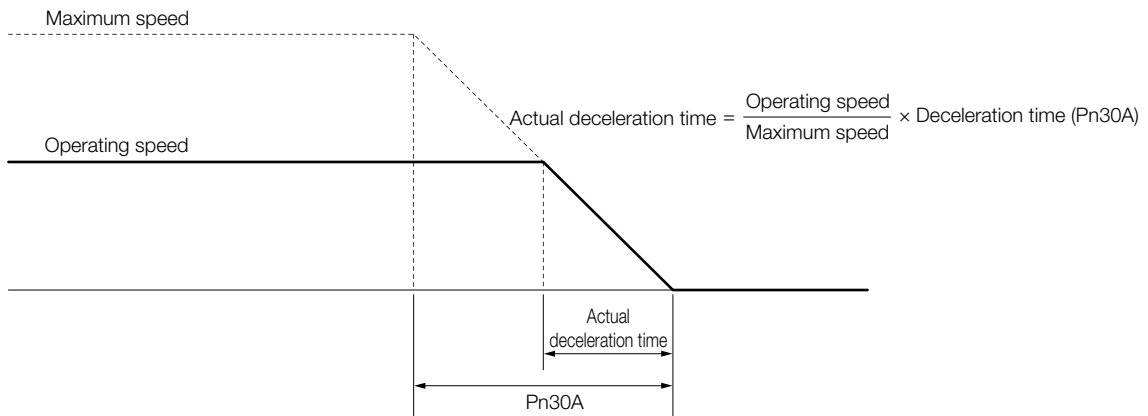

7.13.3 Resetting Method for Forced Stops

This section describes the reset methods that can be used after stopping operation for an FSTP (Forced Stop Input) signal.

If the FSTP (Forced Stop Input) signal is OFF and the Servo ON command (Enable Operation command) is input, the forced stop state will be maintained even after the FSTP signal is turned ON.

Send the Servo OFF command (Disable Operation command) to place the SERVOPACK in the base block (BB) state and then send the Servo ON command (Enable Operation command).

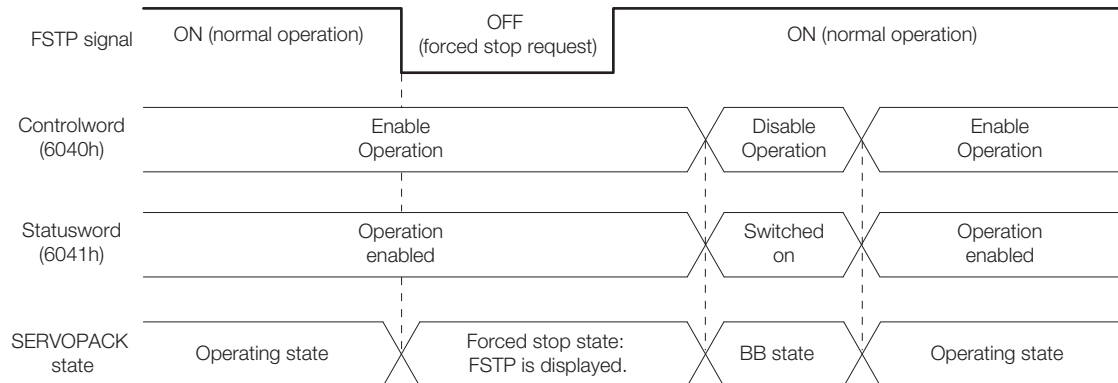

7.14 ZONE Outputs (FT64 Specification)

You can use ZONE signals to output a ZONE number to indicate when the current value is within a registered zone.

The ZONE signals (/ZONE0 to /ZONE3) are assigned to output signals (/SO1 to /SO5) on CN1.

7.14.1 ZONE Table and ZONE Signals

You can register the desired zones in the ZONE table. The ZONE table consists of settings for the ZONE numbers (ZONE), ZONE N values (ZONE N), and ZONE P values (ZONE P). You can register up to 16 zones.

The ZONE numbers identify the registered zones.

ZONE N is the lower limit of the ZONE and ZONE P is the upper limit of the ZONE. The setting conditions for ZONE N and ZONE P are given in the following table.

Setting Range	Setting Unit	Default Setting	When Enabled
-2,147,483,648 to 2,147,483,647	Pos unit	0	Immediately

The ZONE signals indicate the ZONE number. If the current value is within a zone registered in the ZONE table, the corresponding ZONE number is output on the ZONE signals.

You can use the ZONE signals as required, e.g., to trigger operations related to positioning.

ZONE Table			ZONE Signals			
ZONE Number (ID)	ZONE N [Pos unit]	ZONE P [Pos unit]	/ZONE3	/ZONE2	/ZONE1	/ZONE0
0	±nnnnnnnnnn	±nnnnnnnnnn	0	0	0	0
1	±nnnnnnnnnn	±nnnnnnnnnn	0	0	0	1
2	±nnnnnnnnnn	±nnnnnnnnnn	0	0	1	0
3	±nnnnnnnnnn	±nnnnnnnnnn	0	0	1	1
4	±nnnnnnnnnn	±nnnnnnnnnn	0	1	0	0
5	±nnnnnnnnnn	±nnnnnnnnnn	0	1	0	1
6	±nnnnnnnnnn	±nnnnnnnnnn	0	1	1	0
7	±nnnnnnnnnn	±nnnnnnnnnn	0	1	1	1
8	±nnnnnnnnnn	±nnnnnnnnnn	1	0	0	0
9	±nnnnnnnnnn	±nnnnnnnnnn	1	0	0	1
10	±nnnnnnnnnn	±nnnnnnnnnn	1	0	1	0
11	±nnnnnnnnnn	±nnnnnnnnnn	1	0	1	1
12	±nnnnnnnnnn	±nnnnnnnnnn	1	1	0	0
13	±nnnnnnnnnn	±nnnnnnnnnn	1	1	0	1
14	±nnnnnnnnnn	±nnnnnnnnnn	1	1	1	0
15	±nnnnnnnnnn	±nnnnnnnnnn	1	1	1	1

Note: 1: Signal is ON (active), 0: Signal is OFF (inactive).

ZONE Table Settings and ZONE Numbers

The relationship between the ZONE table settings and the ZONE numbers is shown below.

- **ZONE N ≤ ZONE P**

The ZONE signals for the corresponding ZONE number is output if the current value is between ZONE N and ZONE P, inclusive (the shaded part in the following figure).



- **ZONE P < ZONE N**

The ZONE signals for the corresponding ZONE number is output if the current value is less than or equal to ZONE P or greater than or equal to ZONE N (the shaded parts in the following figure).



- **Duplicated Settings in the ZONE Table**

The smaller ZONE number is output.

- **ZONE N and ZONE P = 0**

The ZONE number is disabled.

- **When the Current Value Is Not In Any ZONE**

All of the ZONE signals will be OFF (0).

7.14.2 ZONE Table Settings

The ZONE table is set by setting the *ZONE table positive side boundary position (ZONE P)* (2750h) and the *ZONE table negative side boundary position (ZONE N)* (2751h).

Index	Subindex	Name	Access	PDO Mapping	Unit	Data Type	Parameter No.
2750h	ZONE table Positive side boundary position (ZONE P)						
	1	ZONE ID 0	RW	No	Pos.unit	DINT	PnA00
	2	ZONE ID 1	RW	No	Pos.unit	DINT	PnA04
	3	ZONE ID 2	RW	No	Pos.unit	DINT	PnA08
	4	ZONE ID 3	RW	No	Pos.unit	DINT	PnA0C
	5	ZONE ID 4	RW	No	Pos.unit	DINT	PnA10
	6	ZONE ID 5	RW	No	Pos.unit	DINT	PnA14
	7	ZONE ID 6	RW	No	Pos.unit	DINT	PnA18
	8	ZONE ID 7	RW	No	Pos.unit	DINT	PnA1C
	9	ZONE ID 8	RW	No	Pos.unit	DINT	PnA20
	10	ZONE ID 9	RW	No	Pos.unit	DINT	PnA24
	11	ZONE ID 10	RW	No	Pos.unit	DINT	PnA28
	12	ZONE ID 11	RW	No	Pos.unit	DINT	PnA2C
	13	ZONE ID 12	RW	No	Pos.unit	DINT	PnA30
	14	ZONE ID 13	RW	No	Pos.unit	DINT	PnA34
	15	ZONE ID 14	RW	No	Pos.unit	DINT	PnA38
16	ZONE ID 15	RW	No	Pos.unit	DINT	PnA3C	

Continued on next page.

Continued from previous page.

Index	Subindex	Name	Access	PDO Mapping	Unit	Data Type	Parameter No.
2751h	ZONE table Negative side boundary position (ZONE N)						
	1	ZONE ID 0	RW	No	Pos.unit	DINT	PnA02
	2	ZONE ID 1	RW	No	Pos.unit	DINT	PnA06
	3	ZONE ID 2	RW	No	Pos.unit	DINT	PnA0A
	4	ZONE ID 3	RW	No	Pos.unit	DINT	PnA0E
	5	ZONE ID 4	RW	No	Pos.unit	DINT	PnA12
	6	ZONE ID 5	RW	No	Pos.unit	DINT	PnA16
	7	ZONE ID 6	RW	No	Pos.unit	DINT	PnA1A
	8	ZONE ID 7	RW	No	Pos.unit	DINT	PnA1E
	9	ZONE ID 8	RW	No	Pos.unit	DINT	PnA22
	10	ZONE ID 9	RW	No	Pos.unit	DINT	PnA26
	11	ZONE ID 10	RW	No	Pos.unit	DINT	PnA2A
	12	ZONE ID 11	RW	No	Pos.unit	DINT	PnA2E
	13	ZONE ID 12	RW	No	Pos.unit	DINT	PnA32
	14	ZONE ID 13	RW	No	Pos.unit	DINT	PnA36
	15	ZONE ID 14	RW	No	Pos.unit	DINT	PnA3A
16	ZONE ID 15	RW	No	Pos.unit	DINT	PnA3E	

7.14.3 ZONE Signals 1 to 4 Outputs (/ZONE0 to /ZONE3)

The /ZONE0 to /ZONE3 signals indicate when the current value is within a zone registered in the ZONE table.

Type	Signal	Connector Pin No.	Signal Status	Meaning
Outputs	/ZONE0	Must be allocated.	ON (closed)	The current value is within a zone in the ZONE table and /ZONE0 is active.
			OFF (open)	The current value is not within a zone in the ZONE table or /ZONE0 is inactive.
	/ZONE1	Must be allocated.	ON (closed)	The current value is within a zone in the ZONE table and /ZONE1 is active.
			OFF (open)	The current value is not within a zone in the ZONE table or /ZONE1 is inactive.
	/ZONE2	Must be allocated.	ON (closed)	The current value is within a zone in the ZONE table and /ZONE2 is active.
			OFF (open)	The current value is not within a zone in the ZONE table or /ZONE2 is inactive.
	/ZONE3	Must be allocated.	ON (closed)	The current value is within a zone in the ZONE table and /ZONE3 is active.
			OFF (open)	The current value is not within a zone in the ZONE table or /ZONE3 is inactive.

Note: You must allocate the /ZONE0 to /ZONE3 signals to use them. Use PnBA0 (ZONE Output Signal Selection 1) to allocate them to connector pins. Refer to the following sections for details.

 7.1.2 Output Signal Allocations on page 7-5

7.14.4 nZONE Signal Output

The /nZONE signal indicates when the current value is within a zone registered in the ZONE table.

Type	Signal	Connector Pin No.	Signal Status	Meaning
Output	/nZONE	Must be allocated.	ON (closed)	The current value is within a zone registered in the ZONE table.
			OFF (open)	The current value is not within a zone registered in the ZONE table.

Note: You must allocate the /nZONE signal to use it. Use PnBA1 = n.□□□X (/nZONE (nZONE Signal Output) Signal Allocation) to allocate the signal to connector pins. Refer to the following sections for details.

 7.1.2 Output Signal Allocations on page 7-5

The relationship between the ZONE table and /nZONE signal is shown in the following table.

ZONE Table			/nZONE
ZONE Number (ID)	ZONE N [Reference Units]	ZONE P [Reference Units]	
0	±0000000000	±0000000000	1
1	±0000000000	±0000000000	1
2	±0000000000	±0000000000	1
3	±0000000000	±0000000000	1
4	±0000000000	±0000000000	1
5	±0000000000	±0000000000	1
6	±0000000000	±0000000000	1
7	±0000000000	±0000000000	1
8	±0000000000	±0000000000	1
9	±0000000000	±0000000000	1
10	±0000000000	±0000000000	1
11	±0000000000	±0000000000	1
12	±0000000000	±0000000000	1
13	±0000000000	±0000000000	1
14	±0000000000	±0000000000	1
15	±0000000000	±0000000000	1

Note: The /nZONE signal will be 0 (OFF) if both ZONE N and ZONE P are zero.

7.14.5 ZONE Output Application Example

Using the ZONE Outputs as Zone Signals

The ZONE signals are output when the current value is within a zone registered in the ZONE table. The relationship between the ZONE table and ZONE signals is shown in the following table.

The ZONE table is given below.

ZONE Number (ID)	ZONE N	ZONE P
0	0	0
1	-1000	+1000
2	+99000	+101000
3	0	0
4	+199000	+201000
5	0	0
6	0	0
7	0	0
8	+299000	+301000
9	0	0
10	0	0
11	0	0
12	0	0
13	0	0
14	0	0
15	0	0

The relationship between the operation pattern and ZONE signals is shown in the following diagrams.



Important The ZONE outputs operate independently of the Digital outputs (60FEh). If you use these functions, set them carefully according to the application.

◆ ZONE Signals

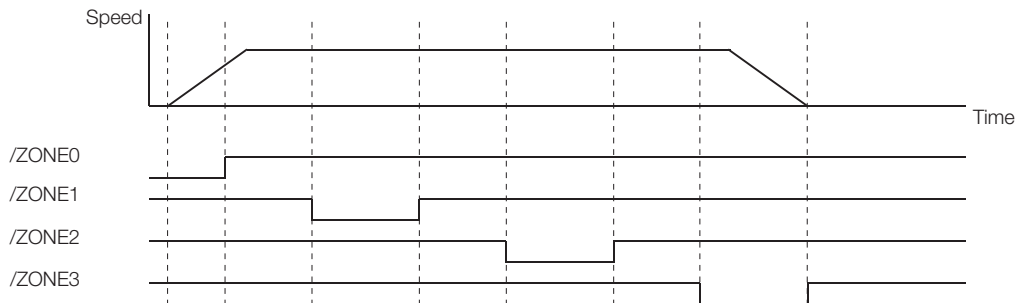

◆ nZONE Signal

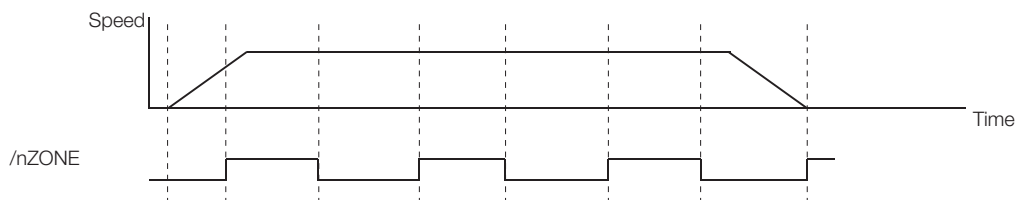

7.15 Overheat Protection

Overheat protection detects an A.93B warning (Overheat Warning) and an A.862 alarm (Overheat Alarm) by monitoring the overheat protection input signal (TH) from a Yaskawa SGLFW2 Linear Servomotor or from a sensor attached to the machine.

SERVOPACKs with software version 0023 or higher support overheat protection.

When you use overheat protection, you must wire the overheat protection input (TH) signal and select overheat protection (Pn61A = n.□□□X).

7.15.1 Connecting the Overheat Protection Input (TH) Signal

To use overheat protection, you must connect an overheat protection input (TH) signal to the SERVOPACK. This section describes the connection methods for the overheat protection input (TH) signal.

Using Overheat Protection in the Linear Servomotor

- If you use a Serial Converter Unit, connect the connector for the polarity sensor and thermostat cable of the Linear Servomotor to the Serial Converter Unit.
- If you do not use a Serial Converter Unit, connect the thermostat cable of the Linear Servomotor to CN1-5.

Using Overheat Protection for the Machine

To use overheat protection for the machine, connect the overheat protection input (an analog voltage input) from the sensor mounted to the machine to the CN1-5.

7.15.2 Overheat Protection Selections

The overheat protection function is selected with Pn61A = n.□□□X (Overheat Protection Selections).

Parameter		Meaning	When Enabled	Classification
Pn61A (261Ah)	n.□□□0 (default setting)	Disable overheat protection.	After restart	Setup
	n.□□□1	Use overheat protection in the Yaskawa Linear Servomotor.*		
	n.□□□2	Monitor a negative voltage input from a sensor attached to the machine and use overheat protection.		
	n.□□□3	Monitor a positive voltage input from a sensor attached to the machine and use overheat protection.		

* The SGLFW2 is the only Yaskawa Linear Servomotor that supports this function.

Using Overheat Protection in the Yaskawa Linear Servomotor

To use the overheat protection in a Yaskawa Linear Servomotor (SGLFW2), set Pn61A to n.□□□1.

An A.93B warning (Overheat Warning) will be detected if the overheat protection input (TH) signal from the Yaskawa SGLFW2 Linear Servomotor exceeds the warning temperature.

An A.862 alarm (Overheat Alarm) will be detected if the overheat protection input (TH) signal from the Yaskawa SGLFW2 Linear Servomotor exceeds the alarm temperature.



Important

- If the overheat protection input signal line is disconnected or short-circuited, an A.862 alarm will occur.
- If you set Pn61A to n.□□□1 (Use overheat protection in the Yaskawa Linear Servomotor), the parameters in the Servomotor are enabled and the following parameters are disabled.
 - Overheat Alarm Level (Pn61B)
 - Overheat Warning Level (Pn61C)
 - Overheat Alarm Filter Time (Pn61D)

Monitoring the Machine's Temperature and Using Overheat Protection

Set Pn61A = n.□□□X to 2 or 3 to use overheat protection for the machine.

Set the following parameters as required.

Pn61B (261Bh)	Overheat Alarm Level			Speed	Position	Torque
	Setting Range	Setting Unit	Default Setting	When Enabled	Classification	
	0 to 500	0.01 V	250	Immediately	Setup	
Pn61C (261Ch)	Overheat Warning Level			Speed	Position	Torque
	Setting Range	Setting Unit	Default Setting	When Enabled	Classification	
	0 to 100	1%	100	Immediately	Setup	
Pn61D (261Dh)	Overheat Alarm Filter Time			Speed	Position	Torque
	Setting Range	Setting Unit	Default Setting	When Enabled	Classification	
	0 to 65,535	1 s	0	Immediately	Setup	



Important

- When Pn61A is set to n.□□□2, an A.862 alarm will occur if the overheat protection input signal line is disconnected or short-circuited.
- When Pn61A is set to n.□□□3, an A.862 alarm will not occur if the overheat protection input signal line is disconnected or short-circuited. To ensure safety, we recommend that you connect the external circuits so that you can use a negative voltage input for the overheat protection input (an analog voltage input).

Trial Operation and Actual Operation

8

This chapter provides information on the flow and procedures for trial operation and convenient functions to use during trial operation.





8.1	Flow of Trial Operation	8-2
8.1.1	Flow of Trial Operation for Rotary Servomotors . .	8-2
8.1.2	Flow of Trial Operation for Linear Servomotors . .	8-4
8.2	Inspections and Confirmations before Trial Operation . .	8-6
8.3	Trial Operation for the Servomotor without a Load . .	8-7
8.3.1	Preparations	8-7
8.3.2	Applicable Tools	8-8
8.3.3	Operating Procedure	8-8
8.4	Trial Operation with EtherCAT (CoE) Communications . .	8-10
8.5	Trial Operation with the Servomotor Connected to the Machine . .	8-11
8.5.1	Precautions	8-11
8.5.2	Preparations	8-11
8.5.3	Operating Procedure	8-12
8.6	Convenient Function to Use during Trial Operation . .	8-13
8.6.1	Program Jogging	8-13
8.6.2	Origin Search	8-19
8.6.3	Test without a Motor	8-21

8.1 Flow of Trial Operation







8.1.1 Flow of Trial Operation for Rotary Servomotors

The procedure for trial operation is given below.

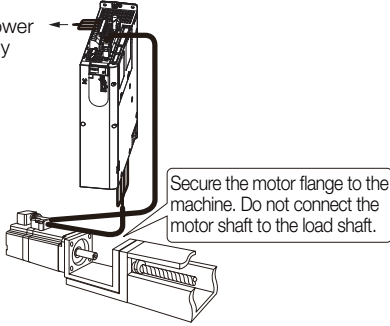
- Preparations for Trial Operation

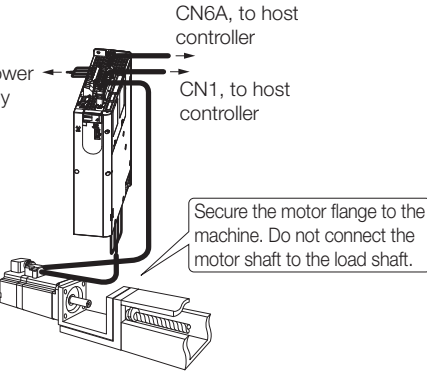
Step	Meaning	Reference
1	Installation Install the Servomotor and SERVOPACK according to the installation conditions. First, operation is checked with no load. Do not connect the Servomotor to the machine.	 <i>Chapter 3 SERVOPACK Installation</i>
2	Wiring and Connections Wire and connect the SERVOPACK. First, Servomotor operation is checked without a load. Do not connect the CN1 connector on the SERVOPACK.	 <i>Chapter 4 Wiring and Connecting SERVOPACKs</i>
3	Confirmations before Trial Operation	 <i>8.2 Inspections and Confirmations before Trial Operation on page 8-6</i>
4	Power ON	–
5	Resetting the Absolute Encoder This step is necessary only for a Servomotor with an Absolute Encoder.	 <i>6.15 Resetting the Absolute Encoder on page 6-49</i>

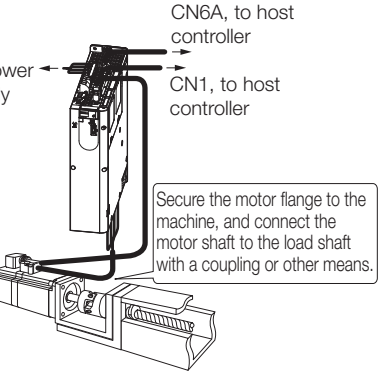



• Trial Operation

Step	Meaning	Reference
1	<p>Trial Operation for the Servomotor without a Load</p> 	<p> 8.3 Trial Operation for the Servomotor without a Load on page 8-7</p>
2	<p>Trial Operation with EtherCAT (CoE) Communications</p> 	<p> 8.4 Trial Operation with EtherCAT (CoE) Communications on page 8-10</p>
3	<p>Trial Operation with the Servomotor Connected to the Machine</p> 	<p> 8.5 Trial Operation with the Servomotor Connected to the Machine on page 8-11</p>







8.1.2 Flow of Trial Operation for Linear Servomotors

The procedure for trial operation is given below.

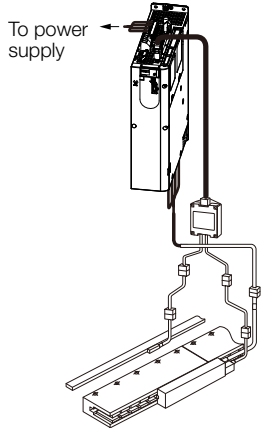
- Preparations for Trial Operation

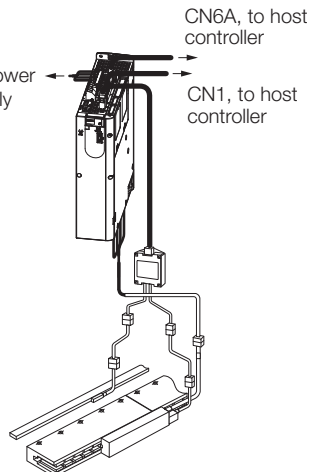
Step	Meaning	Reference			
1	Installation Install the Servomotor and SERVOPACK according to the installation conditions. First, operation is checked with no load. Do not connect the Servomotor to the machine.	 Chapter 3 SERVOPACK Installation			
2	Wiring and Connections Wire and connect the SERVOPACK. First, Servomotor operation is checked without a load. Do not connect the CN1 connector on the SERVOPACK.	 Chapter 4 Wiring and Connecting SERVOPACKs			
3	Confirmations before Trial Operation	 8.2 Inspections and Confirmations before Trial Operation on page 8-6			
4	Power ON	–			
5	Setting Parameters in the SERVOPACK				
	Step	No. of Parameter to Set	Description	Remarks	Reference
	5-1	Pn282 (2282h)	Linear Encoder Pitch	Set this parameter only if you are using a Serial Converter Unit.	page 6-15
	5-2	–	Writing Parameters to the Linear Servomotor	Set this parameter only if you are not using a Serial Converter Unit.	page 6-16
	5-3	Pn080 (2080h) = n.□□X□	Motor Phase Sequence Selection	–	page 6-20
	5-4	Pn080 (2080h) = n.□□□X	Polarity Sensor Selection	–	page 6-22
	5-5	–	Polarity Detection	This step is necessary only for a Linear Servomotor without a Polarity Sensor.	page 6-23
	5-6	Pn50A (250Ah) = n.X□□□ and Pn50B (250Bh) = n.□□□X	Overtravel Signal Allocations	–	page 6-26
	5-7	Pn483 (2483h), Pn484 (2484h)	Force Control	–	page 7-26
6	Setting the Origin of the Absolute Linear Encoder	 6.16.2 Setting the Origin of the Absolute Linear Encoder on page 6-52			

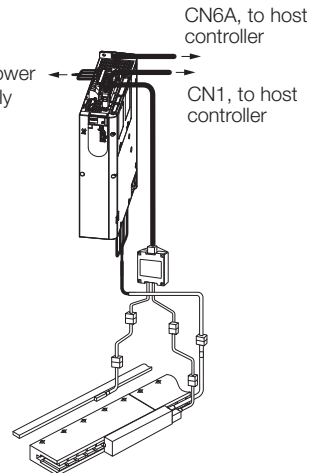
• Trial Operation

Step	Meaning	Reference
1	<p>Trial Operation for the Servomotor without a Load</p> 	<p> 8.3 Trial Operation for the Servomotor without a Load on page 8-7</p>
2	<p>Trial Operation with EtherCAT (CoE) Communications</p> 	<p> 8.4 Trial Operation with EtherCAT (CoE) Communications on page 8-10</p>
3	<p>Trial Operation with the Servomotor Connected to the Machine</p> 	<p> 8.5 Trial Operation with the Servomotor Connected to the Machine on page 8-11</p>

8.2 Inspections and Confirmations before Trial Operation

To ensure safe and correct trial operation, check the following items before you start trial operation.

- Make sure that the SERVOPACK and Servomotor are installed, wired, and connected correctly.
- Make sure that the correct power supply voltage is supplied to the SERVOPACK.
- Make sure that there are no loose parts in the Servomotor mounting.
- If you are using a Servomotor with an Oil Seal, make sure that the oil seal is not damaged. Also make sure that oil has been applied.
- If you are performing trial operation on a Servomotor that has been stored for a long period of time, make sure that all Servomotor inspection and maintenance procedures have been completed.

Refer to the manual for your Servomotor for Servomotor maintenance and inspection information.

- If you are using a Servomotor with a Holding Brake, make sure that the brake is released in advance. To release the brake, you must apply the specified voltage of 24 VDC to the brake. A circuit example for trial operation is provided below.

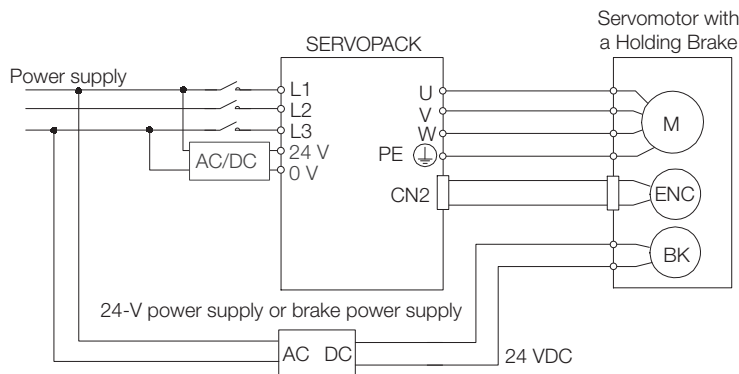

8.3

Trial Operation for the Servomotor without a Load

You use jogging for trial operation of the Servomotor without a load.

Jogging is used to check the operation of the Servomotor without connecting the SERVOPACK to the host controller. The Servomotor is moved at the preset jogging speed.

 **CAUTION**

- During jogging, the overtravel function is disabled. Consider the range of motion of your machine when you jog the Servomotor.



The tuning-less function is enabled as the default setting. If the tuning-less function is enabled, gain may increase and vibrations may occur with no load. If vibrations occur, disable the tuning-less function (Pn170=n.□□□0).

8.3.1 Preparations

Confirm the following conditions before you jog the Servomotor.

- The parameters must not be write prohibited.
- The main circuit power supply must be ON.
- There must be no alarms.
- There must be no hard wire base block (HWBB).
- The servo must be OFF.
- The jogging speed must be set considering the operating range of the machine.
The jogging speed is set with the following parameters.

- Rotary Servomotors

Pn304 (2304h)	Jogging Speed [Speed] [Position] [Torque]				
	Setting Range	Setting Unit	Default Setting	When Enabled	Classification
	0 to 10,000	1 min ⁻¹	500	Immediately	Setup
Pn305 (2305h)	Soft Start Acceleration Time [Speed]				
	Setting Range	Setting Unit	Default Setting	When Enabled	Classification
	0 to 10,000	1 ms	0	Immediately	Setup
Pn306 (2306h)	Soft Start Deceleration Time [Speed]				
	Setting Range	Setting Unit	Default Setting	When Enabled	Classification
	0 to 10,000	1 ms	0	Immediately	Setup

- Linear Servomotors

Pn383 (2383h)	Jogging Speed [Speed] [Position] [Force]				
	Setting Range	Setting Unit	Default Setting	When Enabled	Classification
	0 to 10,000	1 mm/s	50	Immediately	Setup
Pn305 (2305h)	Soft Start Acceleration Time [Speed]				
	Setting Range	Setting Unit	Default Setting	When Enabled	Classification
	0 to 10,000	1 ms	0	Immediately	Setup
Pn306 (2306h)	Soft Start Deceleration Time [Speed]				
	Setting Range	Setting Unit	Default Setting	When Enabled	Classification
	0 to 10,000	1 ms	0	Immediately	Setup

8.3.2 Applicable Tools

The following table lists the tools that you can use to perform jogging.

Tool	Fn No./Function Name	Operating Procedure Reference
Digital Operator	Fn002	Σ-7-Series Digital Operator Operating Manual (Manual No.: SIEP S800001 33)
SigmaWin+	Operation - Jog	Operating Procedure on page 8-8

8.3.3 Operating Procedure

Use the following procedure to jog the motor.

1. Click the Servo Drive Button in the workspace of the Main Window of the SigmaWin+.
2. Select **JOG Operation** in the Menu Dialog Box.
The Jog Operation Dialog Box will be displayed.
3. Read the warnings and then click the **OK** Button.

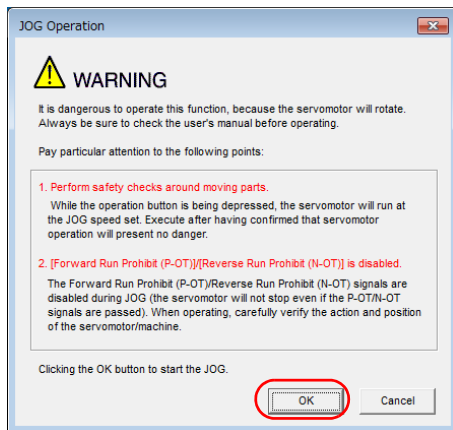

4. Check the jogging speed and then click the **Servo ON** Button.

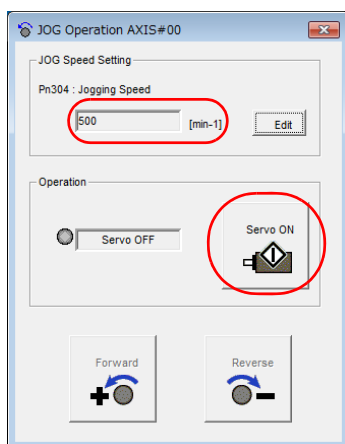

The display in the **Operation** Area will change to **Servo ON**.

Information To change the speed, click the **Edit** Button and enter the new speed.

5. Click the Forward Button or the Reverse Button.

Jogging will be performed only while you hold down the mouse button.

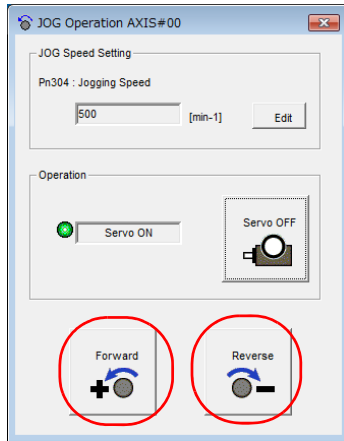
**6. After you finish jogging, turn the power supply to the SERVOPACK OFF and ON again.**

This concludes the jogging procedure.

8.4 Trial Operation with EtherCAT (CoE) Communications

A trial operation example for EtherCAT (CoE) communications is given below.

In this example, operation in Profile Position Mode is described.

Refer to the following chapter for details on operation with EtherCAT (CoE) communications.

Chapter 14 CiA402 Drive Profile

1. Confirm that the wiring is correct, and then connect the I/O signal connector (CN1) and EtherCAT communications connector (CN6A).

Refer to the following chapter for details on wiring.

Chapter 4 Wiring and Connecting SERVOPACKs

2. Set the EtherCAT (CoE) communications station address and PDO mappings.

Refer to the following chapter for details on PDO mappings.

13.4 PDO Mappings on page 13-6

3. Turn ON the power supplies to the SERVOPACK.

If power is being supplied correctly, the CHARGE indicator on the SERVOPACK will light.

Note: If the COM indicator does not light, recheck the settings of EtherCAT setting switches (S1 and S2) and then turn the power supply OFF and ON again.

4. Place the EtherCAT communications in the Operational state.

Refer to the following chapter for details on the EtherCAT communications status.

13.2 EtherCAT State Machine on page 13-3

5. Set the modes of operation to Profile Position Mode.

Refer to the following section for details on modes of operation.

Modes of Operation (6060h) on page 15-29

6. Change the *controlword* to supply power to the motor.

When *statusword* shows the Operation Enabled state, power is supplied to the motor.

Note: Manipulate the objects that were mapped to PDOs.
Values will not be written if you manipulate SDOs.

7. Set *target position*, *profile velocity*, *profile acceleration*, and *profile deceleration*, and then manipulate *controlword* to start positioning.

Note: Manipulate the objects that were mapped to PDOs.
Values will not be written if you manipulate SDOs.

8. While operation is in progress for step 6, confirm the following items.

Confirmation Item	Reference
Confirm that the rotational direction of the Servomotor agrees with the forward or reverse reference. If they do not agree, correct the rotation direction of the Servomotor.	6.4 Motor Direction Setting on page 6-14
Confirm that no abnormal vibration, noise, or temperature rise occurs. If any abnormalities are found, implement corrections.	16.4 Troubleshooting Based on the Operation and Conditions of the Servomotor on page 16-55

Note: If the load machine is not sufficiently broken in before trial operation, the Servomotor may become overloaded.

8.5

Trial Operation with the Servomotor Connected to the Machine

This section provides the procedure for trial operation with both the machine and Servomotor.

8.5.1

Precautions

**WARNING**

- Operating mistakes that occur after the Servomotor is connected to the machine may not only damage the machine, but they may also cause accidents resulting in personal injury.



Important

If you disabled the overtravel function for trial operation of the Servomotor without a load, enable the overtravel function (P-OT and N-OT signal) before you perform trial operation with the Servomotor connected to the machine in order to provide protection.

If you will use a holding brake, observe the following precautions during trial operation.

- Before you check the operation of the brake, implement measures to prevent vibration from being caused by the machine falling due to gravity or an external force.
- First check the Servomotor operation and brake operation with the Servomotor uncoupled from the machine. If no problems are found, connect the Servomotor to the machine and perform trial operation again.

Control the operation of the brake with the /BK (Brake) signal output from the SERVOPACK.

Refer to the following sections for information on wiring and the related parameter settings.

 [4.4.4 Wiring the SERVOPACK to the Holding Brake](#) on page 4-28

 [6.11 Holding Brake](#) on page 6-32



Important

Failures caused by incorrect wiring or incorrect voltage application in the brake circuit may cause the SERVOPACK to fail, damage the SERVOPACK, damage the equipment, or cause an accident resulting in death or injury.

Observe the precautions and instructions for wiring and trial operation precisely as described in this manual.





8.5.2

Preparations

Confirm the following items before you perform the trial operation procedure for both the machine and Servomotor.

- Make sure that the procedure described in [8.4 Trial Operation with EtherCAT \(CoE\) Communications](#) on page 8-10 has been completed.
- Make sure that the SERVOPACK is connected correctly to both the host controller and the peripheral devices.
 - Safety Function Wiring
 - If you are not using the safety function, leave the Safety Jumper Connector (provided as an accessory with the SERVOPACK) connected to CN8.
 - If you are using the safety function, remove the Safety Jumper Connector from CN8 and connect the safety function device.
 - Overtravel wiring
 - Brake wiring
 - Allocation of the /BK (Brake) signal to a pin on the I/O signal connector (CN1)
 - Emergency stop circuit wiring
 - Host controller wiring

8.5.3 Operating Procedure

1. Enable the overtravel signals.
 6.10.2 Setting to Enable/Disable Overtravel on page 6-27
2. Make the settings for the protective functions, such as the safety function, overtravel, and the brake.
 4.6 Connecting Safety Function Signals on page 4-37
 6.10 Overtravel and Related Settings on page 6-26
 6.11 Holding Brake on page 6-32

3. Turn OFF the power supplies to the SERVOPACK.
 The control power supply and main circuit power supply will turn OFF.

4. Couple the Servomotor to the machine.

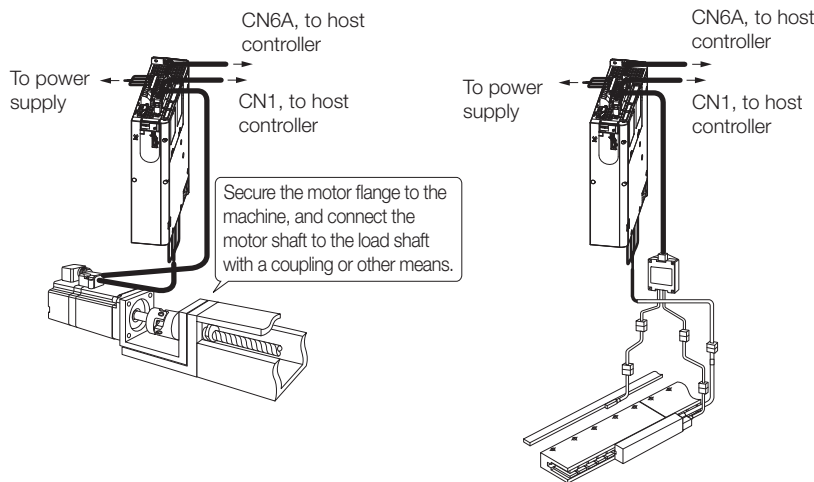

5. Turn ON the power supplies to the machine and host controller and turn ON the control power supply and main circuit power supply to the SERVOPACK.
6. Check the protective functions, such as overtravel and the brake, to confirm that they operate correctly.
 Note: Enable activating an emergency stop so that the Servomotor can be stopped safely should an error occur during the remainder of the procedure.
7. Input the Enable Operation command from the host controller.
 The servo will turn ON.
8. Perform trial operation according to 8.4 Trial Operation with EtherCAT (CoE) Communications on page 8-10 and confirm that the same results are obtained as when trial operation was performed on the Servomotor without a load.
9. If necessary, adjust the servo gain to improve the Servomotor response characteristics.
 The Servomotor and machine may not be broken in completely for the trial operation. Therefore, let the system run for a sufficient amount of time to ensure that it is properly broken in.
10. For future maintenance, save the parameter settings with one of the following methods.
 - Use the SigmaWin+ to save the parameters as a file.
 - Use the Parameter Copy Mode of the Digital Operator.
 - Record the settings manually.

This concludes the procedure for trial operation with both the machine and Servomotor.

8.6**Convenient Function to Use during Trial Operation**

This section describes some convenient operations that you can use during trial operation. Use them as required.

8.6.1**Program Jogging**

You can use program jogging to perform continuous operation with a preset operation pattern, travel distance, movement speed, acceleration/deceleration time, waiting time, and number of movements.

You can use this operation when you set up the system in the same way as for normal jogging to move the Servomotor without connecting it to the host controller in order to check Servomotor operation and execute simple positioning operations.

Preparations

Confirm the following conditions before you perform program jogging.

- The parameters must not be write prohibited.
- The main circuit power supply must be ON.
- There must be no alarms.
- There must be no hard wire base block (HWBB).
- The servo must be OFF.
- The range of machine motion and the safe movement speed of your machine must be considered when you set the travel distance and movement speed.
- There must be no overtravel.

Additional Information

- You can use the functions that are applicable to position control. However, functions for motions through EtherCAT communications are disabled.
- The overtravel function is enabled.

Program Jogging Operation Pattern

An example of a program jogging operation pattern is given below. In this example, the Servomotor direction is set to Pn000 = n.□□□0 (Use CCW as the forward direction).

Setting of Pn530 (2530h)	Setting	Operation Pattern
n.□□□0	(Waiting time → Forward travel distance) × Number of movements	<p>Number of movements (Pn536)</p> <p>Movement speed •Rotary Servomotor: Pn533 •Linear Servomotor: Pn585</p> <p>Speed 0</p> <p>Travel distance (Pn531)</p> <p>Waiting time (Pn535)</p> <p>Acceleration/ deceleration time (Pn534)</p>
n.□□□1	(Waiting time → Reverse by travel distance) × Number of movements	<p>Number of movements (Pn536)</p> <p>Speed 0</p> <p>Movement speed •Rotary Servomotor: Pn533 •Linear Servomotor: Pn585</p> <p>Travel distance (Pn531)</p> <p>Waiting time (Pn535)</p> <p>Acceleration/ deceleration time (Pn534)</p>
n.□□□2	(Waiting time → Forward by travel distance) × Number of movements → (Waiting time → Reverse by travel distance) × Number of movements	<p>Number of movements (Pn536)</p> <p>Speed 0</p> <p>Movement speed •Rotary Servomotor: Pn533 •Linear Servomotor: Pn585</p> <p>Travel distance (Pn531)</p> <p>Waiting time (Pn535)</p> <p>Acceleration/ deceleration time (Pn534)</p>
n.□□□3	(Waiting time → Reverse by travel distance) × Number of movements → (Waiting time → Forward by travel distance) × Number of movements	<p>Number of movements (Pn536)</p> <p>Speed 0</p> <p>Movement speed •Rotary Servomotor: Pn533 •Linear Servomotor: Pn585</p> <p>Travel distance (Pn531)</p> <p>Waiting time (Pn535)</p> <p>Acceleration/ deceleration time (Pn534)</p>

Continued on next page.

Continued from previous page.

Setting of Pn530 (2530h)	Setting	Operation Pattern
n.□□□4	(Waiting time → Forward by travel distance → Waiting time → Reverse by travel distance) × Number of movements	
n.□□□5	(Waiting time → Reverse by travel distance → Waiting time → Forward by travel distance) × Number of movements	

Information If Pn530 is set to n.□□□0, n.□□□1, n.□□□4, or n.□□□5, you can set Pn536 (Program Jogging Number of Movements) to 0 to perform infinite time operation. You cannot use infinite time operation if Pn530 is set to n.□□□2 or n.□□□3. If you perform infinite time operation from the Digital Operator, press the **JOG/SVON** Key to turn OFF the servo to end infinite time operation.

Related Parameters

Use the following parameters to set the program jogging operation pattern. Do not change the settings while the program jogging operation is being executed.

- Rotary Servomotors



Pn530 (2530h)	Program Jogging-Related Selections				Speed	Position	Torque
	Setting Range	Setting Unit	Default Setting	When Enabled	Classification		
	0000 to 0005	–	0000	Immediately	Setup		
Pn531 (2531h)	Program Jogging Travel Distance				Speed	Position	Torque
	Setting Range	Setting Unit	Default Setting	When Enabled	Classification		
	1 to 1,073,741,824	1 reference unit	32,768	Immediately	Setup		
Pn533 (2533h)	Program Jogging Movement Speed				Speed	Position	Torque
	Setting Range	Setting Unit	Default Setting	When Enabled	Classification		
	1 to 10,000	1 min ⁻¹	500	Immediately	Setup		
Pn534 (2534h)	Program Jogging Acceleration/Deceleration Time				Speed	Position	Torque
	Setting Range	Setting Unit	Default Setting	When Enabled	Classification		
	2 to 10,000	1 ms	100	Immediately	Setup		
Pn535 (2535h)	Program Jogging Waiting Time				Speed	Position	Torque
	Setting Range	Setting Unit	Default Setting	When Enabled	Classification		
	0 to 10,000	1 ms	100	Immediately	Setup		
Pn536 (2536h)	Program Jogging Number of Movements				Speed	Position	Torque
	Setting Range	Setting Unit	Default Setting	When Enabled	Classification		
	0 to 1,000	1	1	Immediately	Setup		

- Linear Servomotors

Pn530 (2530h)	Program Jogging-Related Selections				Speed	Position	Force
	Setting Range	Setting Unit	Default Setting	When Enabled	Classification		
	0000 to 0005	–	0000	Immediately	Setup		
Pn531 (2531h)	Program Jogging Travel Distance				Speed	Position	Force
	Setting Range	Setting Unit	Default Setting	When Enabled	Classification		
	1 to 1,073,741,824	1 reference unit	32,768	Immediately	Setup		
Pn585 (2585h)	Program Jogging Movement Speed				Speed	Position	Force
	Setting Range	Setting Unit	Default Setting	When Enabled	Classification		
	1 to 10,000	1 mm/s	50	Immediately	Setup		
Pn534 (2534h)	Program Jogging Acceleration/Deceleration Time				Speed	Position	Force
	Setting Range	Setting Unit	Default Setting	When Enabled	Classification		
	2 to 10,000	1 ms	100	Immediately	Setup		
Pn535 (2535h)	Program Jogging Waiting Time				Speed	Position	Force
	Setting Range	Setting Unit	Default Setting	When Enabled	Classification		
	0 to 10,000	1 ms	100	Immediately	Setup		
Pn536 (2536h)	Program Jogging Number of Movements				Speed	Position	Force
	Setting Range	Setting Unit	Default Setting	When Enabled	Classification		
	0 to 1,000	1	1	Immediately	Setup		

Applicable Tools

The following table lists the tools that you can use to perform program jogging.

Tool	Fn No./Function Name	Reference
Digital Operator	Fn004	 Σ -7-Series Digital Operator Operating Manual (Manual No.: SIEP S800001 33)
SigmaWin+	Operation - Program JOG Operation	 Operating Procedure on page 8-17

Operating Procedure

Use the following procedure for a program jog operation.

1. Click the  Servo Drive Button in the workspace of the Main Window of the SigmaWin+.
2. Select **JOG Program** in the Menu Dialog Box.
The Jog Program Dialog Box will be displayed.
3. Read the warnings and then click the **OK** Button.

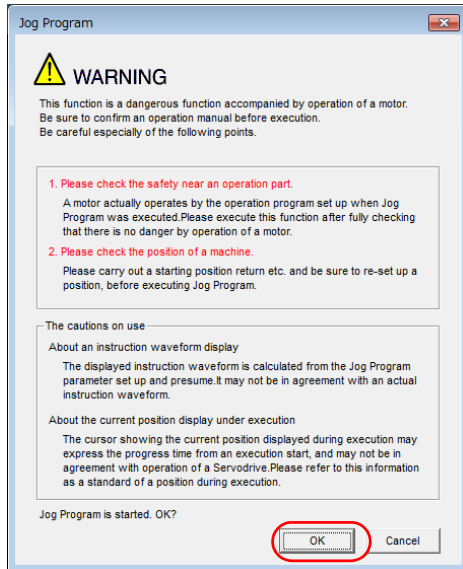

4. Set the operating conditions, click the **Apply** Button, and then click the **Run** Button.
A graph of the operation pattern will be displayed.

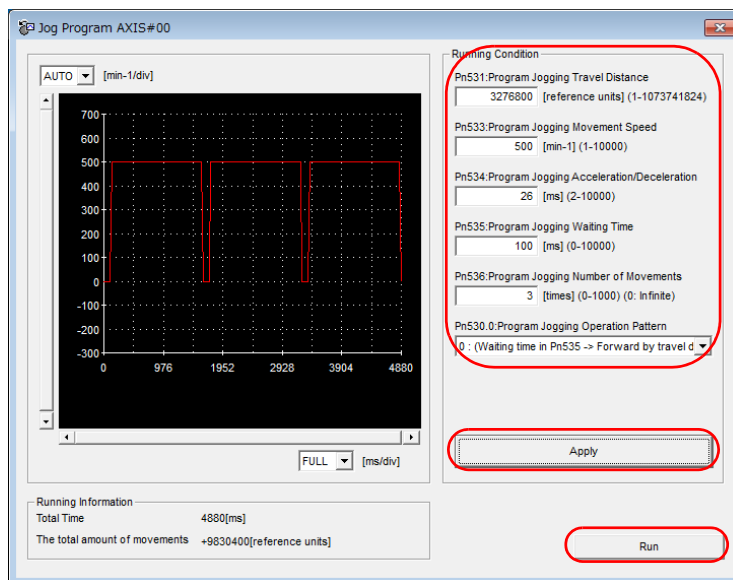

- Click the **Servo ON** Button and then the **Execute** Button. The program jogging operation will be executed.

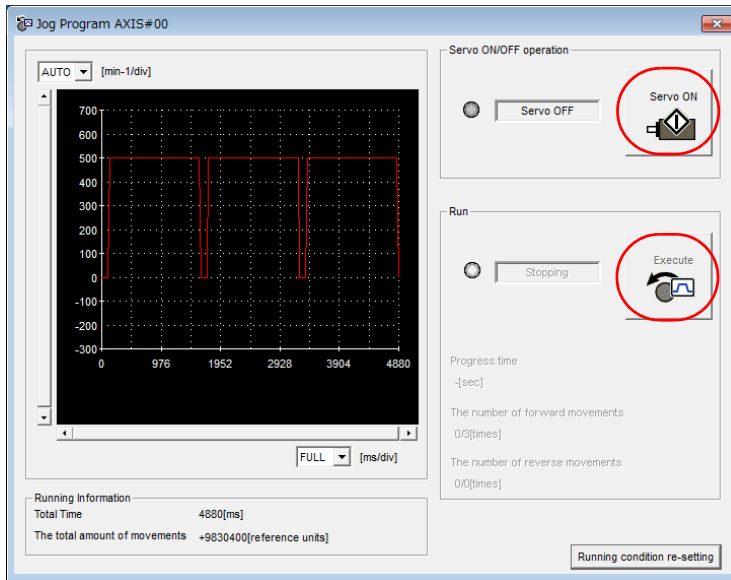

⚠ CAUTION

- Be aware of the following points if you cancel the program jogging operation while the motor is operating.
 - If you cancel operation with the **Servo OFF** Button, the motor will stop according to setting of the Servo OFF stopping method (Pn001 = n.□□□X).
 - If you cancel operation with the **Cancel** Button, the motor will decelerate to a stop and then enter a zero-clamped state.

This concludes the program jogging procedure.

8.6.2 Origin Search

The origin search operation positions the motor to the origin within one rotation and the clamps it there.

CAUTION

- Make sure that the load is not coupled when you execute an origin search.
The Forward Drive Prohibit (P-OT) signal and Reverse Drive Prohibit (N-OT) signal are disabled during an origin search.

Use an origin search when it is necessary to align the origin within one rotation with the machine origin.

- Rotary Servomotors: 60 min⁻¹
- Linear Servomotors: 15 mm/s

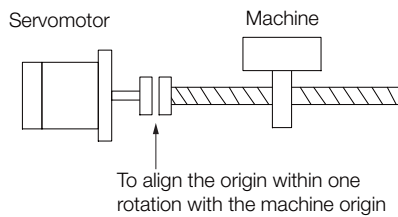

Preparations

Confirm the following conditions before you start an origin search.

- The parameters must not be write prohibited.
- The main circuit power supply must be ON.
- There must be no alarms.
- There must be no hard wire base block (HWBB).
- The servo must be OFF.

Applicable Tools

The following table lists the tools that you can use to perform an origin search.

Tool	Fn No./Function Name	Reference
Digital Operator	Fn003	Σ-7-Series Digital Operator Operating Manual (Manual No.: SIEP S800001 33)
SigmaWin+	Encoder Setting - Search Origin	Operating Procedure on page 8-20

Operating Procedure

Use the following procedure to perform an origin search.

1. Click the  Servo Drive Button in the workspace of the Main Window of the SigmaWin+.
2. Select **Search Origin** in the Menu Dialog Box.
The Origin Search Dialog Box will be displayed.
3. Read the warnings and then click the **OK** Button.

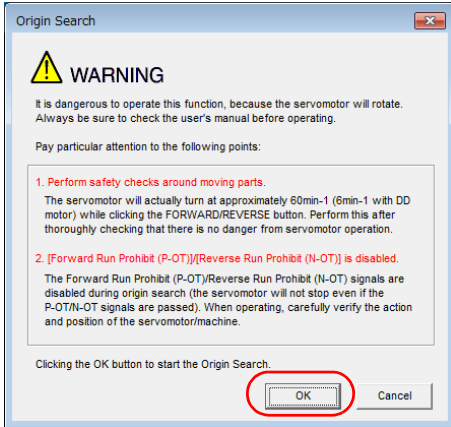

4. Click the **Servo ON** Button.

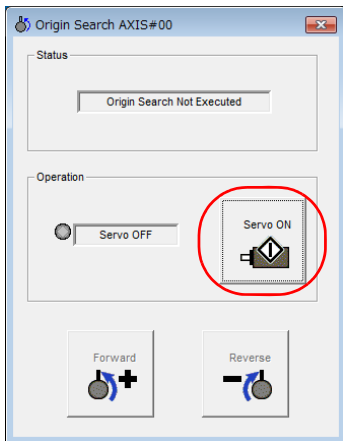

5. Click the **Forward** Button or the **Reverse** Button.
An origin search will be performed only while you hold down the mouse button. The motor will stop when the origin search has been completed.

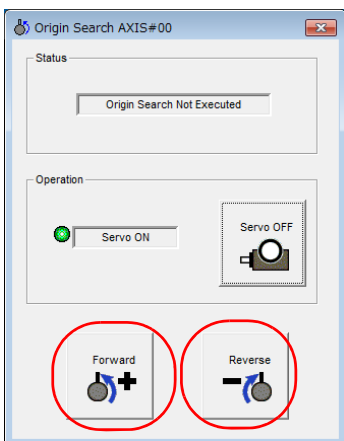

This concludes the origin search procedure.

8.6.3 Test without a Motor

A test without a motor is used to check the operation of the host controller and peripheral devices by simulating the operation of the Servomotor in the SERVOPACK, i.e., without actually operating a Servomotor. This test allows you to check wiring, debug the system, and verify parameters to shorten the time required for setup work and to prevent damage to the machine that may result from possible malfunctions. The operation of the motor can be checked with this test regardless of whether the motor is actually connected or not.

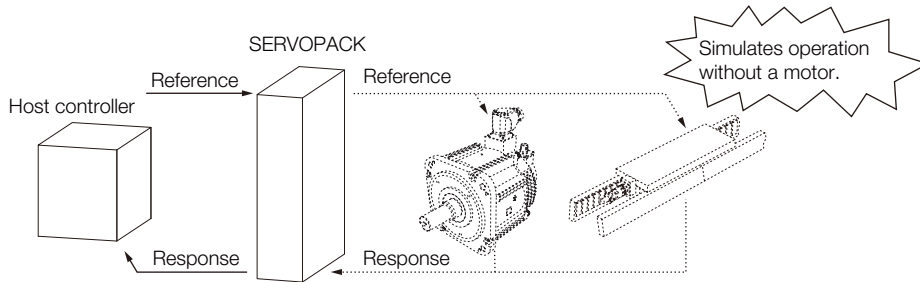

Use Pn00C = n.□□□X to enable or disable the test without a motor.

Parameter	Meaning	When Enabled	Classification
Pn00C (200Ch)	n.□□□0 (default setting)	After restart	Setup
	n.□□□1		

Information An asterisk is displayed on the status display of the Digital Operator while a test without a motor is being executed.

Motor Information and Encoder Information

The motor and encoder information is used during tests without a motor. The source of the information depends on the device connection status.

• Rotary Servomotor

Motor Connection Status	Information That Is Used	Source of Information
Connected	Motor information	Information in the motor that is connected
	Encoder information <ul style="list-style-type: none"> Encoder resolution Encoder type 	
Not connected	Motor information <ul style="list-style-type: none"> Rated motor speed Maximum motor speed 	<ul style="list-style-type: none"> Setting of Pn000 = n.X□□□ (Rotary/Linear Startup Selection When Encoder Is Not Connected) Rated motor speed and maximum motor speed The values previously saved in the SERVOPACK will be used for the rated motor speed and maximum motor speed. Use the monitor displays (Un020: Rated Motor Speed and Un021: Maximum Motor Speed) to check the values.
	Encoder information <ul style="list-style-type: none"> Encoder resolution Encoder type 	<ul style="list-style-type: none"> Encoder resolution: Setting of Pn00C = n.□□X□ (Encoder Resolution for Tests without a Motor) Encoder type: Setting of Pn00C = n.□X□□ (Encoder Type Selection for Tests without a Motor)

If you use fully-closed loop control, the external encoder information is also used.

External Encoder Connection Status	Information That Is Used	Source of Information
Connected	External encoder information	Information in the external encoder that is connected
Not connected	<ul style="list-style-type: none"> Resolution Encoder type 	<ul style="list-style-type: none"> Resolution: 256 Encoder type: Incremental encoder

• Linear Servomotors

Motor Connection Status	Information That Is Used	Source of Information
Connected	Motor information	Information in the motor that is connected
	Linear encoder information • Resolution • Encoder pitch • Encoder type	Information in the linear encoder that is connected
Not connected	Motor information	Setting of Pn000 = n.X□□□ (Rotary/Linear Startup Selection When Encoder Is Not Connected)
	Linear encoder information • Resolution • Encoder pitch • Encoder type	• Resolution: 256 • Encoder pitch: Setting of Pn282 (Linear Encoder Pitch) • Encoder type: Setting of Pn00C = n.□X□□ (Encoder Type Selection for Tests without a Motor)

• Related Parameters

Parameter	Meaning	When Enabled	Classification
Pn000 (2000h)	n.0□□□ (default setting)	After restart	Setup
	n.1□□□		

Pn282 (2282h)	Linear Encoder Pitch				<input type="checkbox"/> Speed	<input type="checkbox"/> Position	<input type="checkbox"/> Force
	Setting Range	Setting Unit	Default Setting	When Enabled	Classification		
	0 to 6,553,600	0.01 μm	0	After restart	Setup		

Parameter	Meaning	When Enabled	Classification
Pn00C (200Ch)	n.□□0□ (default setting)	After restart	Setup
	n.□□1□		
	n.□□2□		
	n.□□3□		
	n.□0□□ (default setting)		
	n.□1□□		

Motor Position and Speed Responses

For a test without a motor, the following responses are simulated for references from the host controller according to the gain settings for position or speed control.

- Servomotor position
- Motor speed
- External encoder position

The load model will be for a rigid system with the moment of inertia ratio that is set in Pn103.

Restrictions

The following functions cannot be used during the test without a motor.

- Regeneration and dynamic brake operation
 - Brake output signal
- Refer to the following section for information on confirming the brake output signal.

☞ 10.2.3 I/O Signals Status Monitor on page 10-5

- Items marked with “x” in the following utility function table

Button in Menu Dialog Box	SigmaWin+	Digital Operator		Executable?		Reference
	SigmaWin+ Function Name	Fn No.	Utility Function Name	Motor Not Connected	Motor Connected	
Basic Functions	Initialize *1	Fn005	Initializing Parameters	○	○	page 6-10
	Software Reset	Fn030	Software Reset	○	○	page 7-44
	Product Information	Fn011	Display Servomotor Model	○	○	page 10-2
		Fn012	Display Software Version	○	○	
		Fn01E	Display SERVOPACK and Servomotor IDs	○	○	
Fn01F	Display Servomotor ID from Feedback Option Module	○	○			
Encoder Setting	Reset Absolute Encoder	Fn008	Reset Absolute Encoder	×	○	page 6-50
	Multi-turn Limit Setup	Fn013	Multiturn Limit Setting after Multiturn Limit Disagreement Alarm	×	○	page 7-37
	Search Origin *2	Fn003	Origin Search	○	○	page 8-19
	Zero Point Position Setting	Fn020	Set Absolute Linear Encoder Origin	×	○	page 6-52
	Polarity Detection	Fn080	Polarity Detection	×	×	page 6-23
Trouble-shooting	Display Alarm	Fn000	Display Alarm History	○	○	page 16-43
		Fn006	Clear Alarm History	○	○	page 16-44
		Fn014	Reset Option Module Configuration Error	○	○	page 16-45
	Reset Motor Type Alarm	Fn021	Reset Motor Type Alarm	○	○	–
Operation	Jog	Fn002	Jog	○	○	page 8-7
	Program JOG Operation	Fn004	Jog Program	○	○	page 8-13
Tuning	Tuning - Autotuning without Host Reference	Fn201	Advanced Autotuning without Reference	×	×	page 9-23
	Tuning - Autotuning with Host Reference	Fn202	Advanced Autotuning with Reference	×	×	page 9-34
	Tuning - Custom Tuning	Fn203	One-Parameter Tuning	×	×	page 9-41
	Tuning - Custom Tuning - Adjust Anti-resonance Control	Fn204	Adjust Anti-resonance Control	×	×	page 9-50
	Tuning - Custom Tuning - Vibration Suppression	Fn205	Vibration Suppression	×	×	page 9-55
	Response Level Setting	Fn200	Tuning-less Level Setting	×	×	page 9-16
Diagnostic	Easy FFT	Fn206	Easy FFT	×	×	page 9-93

Continued on next page.

8.6 Convenient Function to Use during Trial Operation

8.6.3 Test without a Motor

Continued from previous page.

SigmaWin+		Digital Operator		Executable?		Reference
Button in Menu Dialog Box	SigmaWin+ Function Name	Fn No.	Utility Function Name	Motor Not Connected	Motor Connected	
Others	Adjust the Analog Monitor Output	Fn00C	Adjust Analog Monitor Output Offset	○	○	page 10-10
		Fn00D	Adjust Analog Monitor Output Gain	○	○	
	Adjust the Motor Current Detection Offsets	Fn00E	Autotune Motor Current Detection Signal Offset	×	○	page 7-50
		Fn00F	Manually Adjust Motor Current Detection Signal Offset	×	○	
	Initialize Vibration Detection Level	Fn01B	Initialize Vibration Detection Level	×	×	page 7-46
	Write Prohibited Setting	Fn010	Write Prohibition Setting	○	○	page 6-7

*1. An **Initialize** Button will be displayed in the Parameter Editing Dialog Box.

*2. Cannot be used when connecting a Linear Servomotor.

Tuning

9

This chapter provides information on the flow of tuning, details on tuning functions, and related operating procedures.

9.1	Overview and Flow of Tuning	9-4
9.1.1	Tuning Functions	9-5
9.1.2	Diagnostic Tool	9-6
9.2	Monitoring Methods	9-7
9.3	Precautions to Ensure Safe Tuning	9-8
9.3.1	Overtravel Settings	9-8
9.3.2	Torque Limit Settings	9-8
9.3.3	Setting the Position Deviation Overflow Alarm Level	9-8
9.3.4	Vibration Detection Level Setting	9-10
9.3.5	Setting the Position Deviation Overflow Alarm Level at Servo ON	9-10
9.4	Tuning-less Function	9-12
9.4.1	Application Restrictions	9-12
9.4.2	Operating Procedure	9-13
9.4.3	Troubleshooting Alarms	9-14
9.4.4	Parameters Disabled by Tuning-less Function	9-15
9.4.5	Automatically Adjusted Function Setting	9-15
9.4.6	Related Parameters	9-15
9.5	Estimating the Moment of Inertia	9-16
9.5.1	Outline	9-16
9.5.2	Restrictions	9-16
9.5.3	Applicable Tools	9-17
9.5.4	Operating Procedure	9-17

9.6 Autotuning without Host Reference 9-23

9.6.1 Outline 9-23
9.6.2 Restrictions 9-24
9.6.3 Applicable Tools 9-25
9.6.4 Operating Procedure 9-25
9.6.5 Troubleshooting Problems in Autotuning
without a Host Reference 9-29
9.6.6 Automatically Adjusted Function Settings 9-31
9.6.7 Related Parameters 9-33

9.7 Autotuning with a Host Reference 9-34

9.7.1 Outline 9-34
9.7.2 Restrictions 9-35
9.7.3 Applicable Tools 9-35
9.7.4 Operating Procedure 9-36
9.7.5 Troubleshooting Problems in Autotuning
with a Host Reference 9-39
9.7.6 Automatically Adjusted Function Settings 9-39
9.7.7 Related Parameters 9-40

9.8 Custom Tuning 9-41

9.8.1 Outline 9-41
9.8.2 Preparations 9-41
9.8.3 Applicable Tools 9-42
9.8.4 Operating Procedure 9-42
9.8.5 Automatically Adjusted Function Settings 9-48
9.8.6 Tuning Example for Tuning Mode 2 or 3 9-48
9.8.7 Related Parameters 9-49

9.9 Anti-Resonance Control Adjustment 9-50

9.9.1 Outline 9-50
9.9.2 Preparations 9-50
9.9.3 Applicable Tools 9-51
9.9.4 Operating Procedure 9-51
9.9.5 Related Parameters 9-53
9.9.6 Suppressing Different Vibration Frequencies
with Anti-resonance Control 9-53

9.10 Vibration Suppression 9-55

9.10.1 Outline 9-55
9.10.2 Preparations 9-56
9.10.3 Applicable Tools 9-56
9.10.4 Operating Procedure 9-56
9.10.5 Setting Combined Functions 9-58
9.10.6 Related Parameters 9-58

9.11 Speed Ripple Compensation 9-59

9.11.1 Outline 9-59
9.11.2 Setting Up Speed Ripple Compensation 9-59
9.11.3 Setting Parameters 9-63

9.12 Additional Adjustment Functions 9-65

- 9.12.1 Gain Switching 9-65
- 9.12.2 Friction Compensation 9-68
- 9.12.3 Gravity Compensation 9-69
- 9.12.4 Current Control Mode Selection 9-70
- 9.12.5 Current Gain Level Setting 9-71
- 9.12.6 Speed Detection Method Selection 9-71
- 9.12.7 Speed Feedback Filter 9-71
- 9.12.8 Backlash Compensation 9-72

9.13 Manual Tuning 9-77

- 9.13.1 Tuning the Servo Gains 9-77
- 9.13.2 Compatible Adjustment Functions 9-87

9.14 Diagnostic Tools 9-91

- 9.14.1 Mechanical Analysis 9-91
- 9.14.2 Easy FFT 9-93

9.1 Overview and Flow of Tuning

Tuning is performed to optimize response by adjusting the servo gains in the SERVOPACK. The servo gains are set using a combination of parameters, such as parameters for the speed loop gain, position loop gain, filters, friction compensation, and moment of inertia ratio. These parameters influence each other, so you must consider the balance between them. The servo gains are set to stable settings by default. Use the various tuning functions to increase the response even further for the conditions of your machine. The basic tuning procedure is shown in the following flowchart. Make suitable adjustments considering the conditions and operating requirements of your machine.

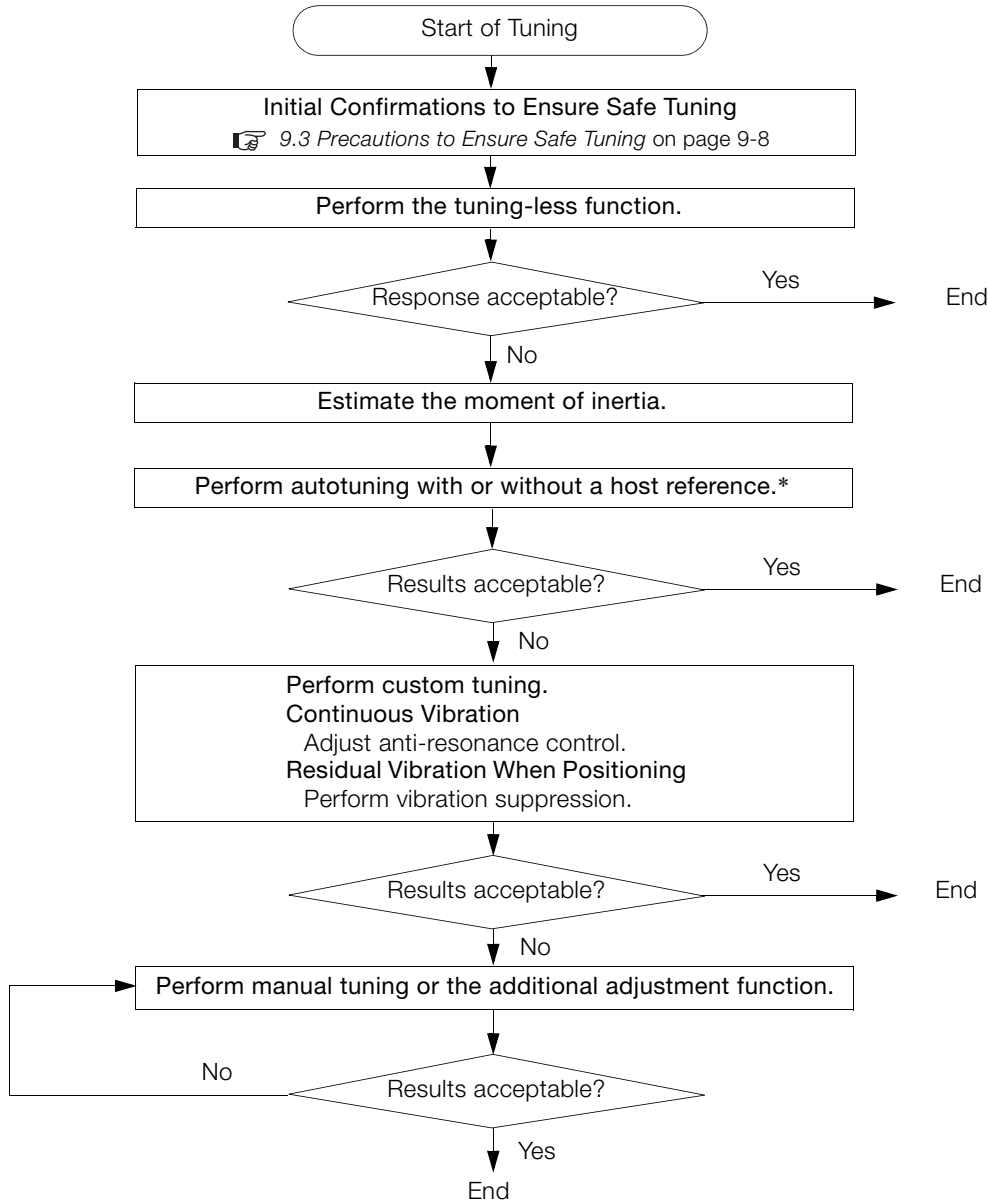

* If possible, perform autotuning with a host reference.
 If a host controller is not available, set an operation pattern that is as close as possible to the host reference and perform autotuning without a host reference.
 If an operation pattern that is close to the host reference is not possible, perform autotuning with a host reference while performing program jogging.

9.1.1 Tuning Functions

The following table provides an overview of the tuning functions.

Tuning Function	Outline	Applicable Control Methods	Reference
Tuning-less Function	This automatic adjustment function is designed to enable stable operation without servo tuning. This function can be used to obtain a stable response regardless of the type of machine or changes in the load. You can use it with the default settings.	Speed control or position control	page 9-12
Moment of Inertia Estimation	The moment of inertia ratio is calculated by operating the Servomotor a few times. The moment of inertia ratio that is calculated here is used in other tuning functions.	Speed control, position control, or torque control	page 9-16
Autotuning without Host Reference	The following parameters are automatically adjusted in the internal references in the SERVO-PACK during automatic operation. <ul style="list-style-type: none"> • Gains (e.g., position loop gain and speed loop gain) • Filters (torque reference filter and notch filters) • Friction compensation • Anti-resonance control • Vibration suppression 	Speed control or position control	page 9-23
Autotuning with Host Reference	The following parameters are automatically adjusted with the position reference input from the host controller while the machine is in operation. You can use this function for fine-tuning after you perform autotuning without a host reference. <ul style="list-style-type: none"> • Gains (e.g., position loop gain and speed loop gain) • Filters (torque reference filter and notch filters) • Friction compensation • Anti-resonance control • Vibration suppression 	Position control	page 9-34
Custom Tuning	The following parameters are adjusted with the position reference or speed reference input from the host controller while the machine is in operation. <ul style="list-style-type: none"> • Gains (e.g., position loop gain and speed loop gain) • Filters (torque reference filter and notch filters) • Friction compensation • Anti-resonance control 	Speed control or position control	page 9-41
Anti-resonance Control Adjustment	This function effectively suppresses continuous vibration.	Speed control or position control	page 9-50
Vibration Suppression	This function effectively suppresses residual vibration if it occurs when positioning.	Position control	page 9-55
Speed Ripple Compensation	This function reduces the ripple in the motor speed.	Speed control, position control, or torque control	page 9-59
Additional Adjustment Function	This function combines autotuning with custom tuning. You can use it to improve adjustment results.	Depends on the functions that you use.	page 9-65
Manual Tuning	You can manually adjust the servo gains to adjust the response.	Speed control, position control, or torque control	page 9-77

9.1.2 Diagnostic Tool

You can use the following tools to measure the frequency characteristics of the machine and set notch filters.

Diagnostic Tool	Outline	Applicable Control Methods	Reference
Mechanical Analysis	The machine is subjected to vibration to detect resonance frequencies. The measurement results are displayed as waveforms or numeric data.	Speed control, position control, or torque control	page 9-91
Easy FFT	The machine is subjected to vibration to detect resonance frequencies. The measurement results are displayed only as numeric data.	Speed control, position control, or torque control	page 9-93

9.2 Monitoring Methods

You can use the data tracing function of the SigmaWin+ or the analog monitor signals of the SERVOPACK for monitoring. If you perform custom tuning or manual tuning, always use the above functions to monitor the machine operating status and SERVOPACK signal waveform while you adjust the servo gains.

Check the adjustment results with the following response waveforms.

- Position Control

Item	Unit	
	Rotary Servomotor	Linear Servomotor
Torque reference	%	
Feedback speed	min ⁻¹	mm/s
Position reference speed	min ⁻¹	mm/s
Position deviation	Reference units	

- Speed Control

Item	Unit	
	Rotary Servomotor	Linear Servomotor
Torque reference	%	
Feedback speed	min ⁻¹	mm/s
Reference speed	min ⁻¹	mm/s

- Torque Control

Item	Unit	
	Rotary Servomotor	Linear Servomotor
Torque reference	%	
Feedback speed	min ⁻¹	mm/s

9.3 Precautions to Ensure Safe Tuning

CAUTION

- Observe the following precautions when you perform tuning.
 - Do not touch the rotating parts of the motor when the servo is ON.
 - Before starting the Servomotor, make sure that an emergency stop can be performed at any time.
 - Make sure that trial operation has been successfully performed without any problems.
 - Provide an appropriate stopping device on the machine to ensure safety.

Perform the following settings in a way that is suitable for tuning.

9.3.1 Overtravel Settings

Overtravel settings are made to force the Servomotor to stop for a signal input from a limit switch when a moving part of the machine exceeds the safe movement range.

Refer to the following section for details.

 6.10 *Overtravel and Related Settings* on page 6-26

9.3.2 Torque Limit Settings

You can limit the torque that is output by the Servomotor based on calculations of the torque required for machine operation. You can use torque limits to reduce the amount of shock applied to the machine when problems occur, such as collisions or interference. If the torque limit is lower than the torque that is required for operation, overshooting or vibration may occur. Refer to the following section for details.

 7.7 *Selecting Torque Limits* on page 7-26

9.3.3 Setting the Position Deviation Overflow Alarm Level

The position deviation overflow alarm is a protective function that is enabled when the SERVOPACK is used in position control.

If the alarm level is set to a suitable value, the SERVOPACK will detect excessive position deviation and will stop the Servomotor if the Servomotor operation does not agree with the reference.

The position deviation is the difference between the position reference value and the actual position.

You can calculate the position deviation from the position loop gain (Pn102) and the motor speed with the following formula.

• **Rotary Servomotors**

$$\text{Position deviation [reference units]} = \frac{\text{Motor speed [min}^{-1}\text{]}}{60} \times \frac{\text{Encoder resolution}^{*1}}{\text{Pn102 [0.1/s/10}^{*2, *3}\text{]} \times \frac{\text{Denominator}}{\text{Numerator}}}$$

• **Linear Servomotors**

$$\text{Position deviation [reference units]} = \frac{\text{Motor speed [mm/s]}}{\text{Pn102 [0.1/s/10}^{*2, *3}\text{]} \times \frac{\text{Resolution}}{\text{Linear encoder pitch [\mu m]/1,000}} \times \frac{\text{Denominator}}{\text{Numerator}}}$$

Position Deviation Overflow Alarm Level (Pn520) [setting unit: reference units]

- Rotary Servomotors

$$\text{Pn520} > \frac{\text{Maximum motor speed [min}^{-1}\text{]}}{60} \times \frac{\text{Encoder resolution}^{*1}}{\text{Pn102 [0.1/s]/10}^{*2, *3}} \times \frac{\text{Denominator}}{\text{Numerator}} \times \underline{\underline{(1.2 \text{ to } 2)^{*4}}}$$

- Linear Servomotors

$$\text{Pn520} > \frac{\text{Maximum motor speed [mm/s]}}{\text{Pn102 [0.1/s]/10}^{*2, *3}} \times \frac{\text{Resolution}}{\text{Linear encoder pitch [\mu m]/1,000}} \times \frac{\text{Denominator}}{\text{Numerator}} \times \underline{\underline{(1.2 \text{ to } 2)^{*4}}}$$

*1. Refer to the following section for details.

 6.14 Setting Unit Systems on page 6-42

*2. When model following control (Pn140 = n.□□□1) is enabled, use the setting of Pn141 (Model Following Control Gain) instead of the setting of Pn102 (Position Loop Gain).

*3. To check the setting of Pn102 on the Digital Operator, change the parameter display setting to display all parameters (Pn00B = n.□□□1).

*4. The underlined coefficient “× (1.2 to 2)” adds a margin to prevent an A.d00 alarm (Position Deviation Overflow) from occurring too frequently.

If you set a value that satisfies the formula, an A.d00 alarm (Position Deviation Overflow) should not occur during normal operation.

If the Servomotor operation does not agree with the reference, position deviation will occur, an error will be detected, and the motor will stop.

The following calculation example uses a Rotary Servomotor with a maximum motor speed of

6,000 and an encoder resolution of 16,777,216 (24 bits). Pn102 is set to 400. $\frac{\text{Denominator}}{\text{Numerator}} = \frac{1}{16}$

$$\begin{aligned} \text{Pn520} &= \frac{6,000}{60} \times \frac{16,777,216}{400/10} \times \frac{1}{16} \times 2 \\ &= 2,621,440 \times 2 \\ &= 5,242,880 \text{ (default setting of Pn520)} \end{aligned}$$

If the acceleration/deceleration rate required for the position reference exceeds the tracking capacity of the Servomotor, the tracking delay will increase and the position deviation will no longer satisfy the above formulas. If this occurs, lower the acceleration/deceleration rate so that the Servomotor can follow the position reference or increase the position deviation overflow alarm level.

Related Parameters

Pn520 (2520h)	Position Deviation Overflow Alarm Level [Position]				
	Setting Range	Setting Unit	Default Setting	When Enabled	Classification
	1 to 1,073,741,823	1 reference unit	5,242,880	Immediately	Setup
Pn51E (251Eh)	Position Deviation Overflow Warning Level [Position]				
	Setting Range	Setting Unit	Default Setting	When Enabled	Classification
	10 to 100	1%	100	Immediately	Setup

Related Alarms

Alarm Number	Alarm Name	Alarm Meaning
A.d00	Position Deviation Overflow	This alarm occurs if the position deviation exceeds the setting of Pn520 (2520h) (Position Deviation Overflow Alarm Level).

Related Warnings

Warning Number	Warning Name	Warning Meaning
A.900	Position Deviation Overflow	This warning occurs if the position deviation exceeds the specified percentage (Pn520 × Pn51E/100).

9.3.4 Vibration Detection Level Setting

You can set the vibration detection level (Pn312) to more accurately detect A.520 alarms (Vibration Alarm) and A.911 warnings (Vibration Warning) when vibration is detected during machine operation.

Set the initial vibration detection level to an appropriate value. Refer to the following section for details.

 7.11 *Initializing the Vibration Detection Level* on page 7-46

9.3.5 Setting the Position Deviation Overflow Alarm Level at Servo ON

If the servo is turned ON when there is a large position deviation, the Servomotor will attempt to return to the original position to bring the position deviation to 0, which may create a hazardous situation. To prevent this, you can set a position deviation overflow alarm level at servo ON to restrict operation.

The related parameters and alarms are given in the following tables.

Related Parameters

Pn526 (2526h)	Position Deviation Overflow Alarm Level at Servo ON Position				
	Setting Range	Setting Unit	Default Setting	When Enabled	Classification
	1 to 1,073,741,823	1 reference unit	5,242,880	Immediately	Setup

Pn528 (2528h)	Position Deviation Overflow Warning Level at Servo ON Position				
	Setting Range	Setting Unit	Default Setting	When Enabled	Classification
	10 to 100	1%	100	Immediately	Setup

• Rotary Servomotors

Pn529 (2529h)	Speed Limit Level at Servo ON Position				
	Setting Range	Setting Unit	Default Setting	When Enabled	Classification
	0 to 10,000	1 min ⁻¹	10,000	Immediately	Setup

• Linear Servomotors

Pn584 (2584h)	Speed Limit Level at Servo ON Position				
	Setting Range	Setting Unit	Default Setting	When Enabled	Classification
	0 to 10,000	1 mm/s	10,000	Immediately	Setup

Related Alarms

Alarm Number	Alarm Name	Alarm Meaning
A.d01	Position Deviation Overflow Alarm at Servo ON	This alarm occurs if Servo ON command (Enable Operation command) is executed after the position deviation exceeded the setting of Pn526 (Excessive Position Deviation Alarm Level at Servo ON) while the servo was OFF.
A.d02	Position Deviation Overflow Alarm for Speed Limit at Servo ON	If position deviation remains in the deviation counter, the setting of Pn529 or Pn584 (Speed Limit Level at Servo ON) will limit the speed when the servo is turned ON. This alarm occurs if a position reference is input and the setting of Pn520 (Excessive Position Deviation Alarm Level) is exceeded.

Refer to the following section for information on troubleshooting alarms.

 16.2.3 *Resetting Alarms* on page 16-42

Related Warnings

Warning Number	Warning Name	Warning Meaning
A.901	Position Deviation Overflow Warning at Servo ON	This warning occurs if the servo is turned ON while the position deviation exceeds the specified percentage ($Pn526 \times Pn528/100$).

9.4 Tuning-less Function

The tuning-less function performs autotuning to obtain a stable response regardless of the type of machine or changes in the load. Autotuning is started when the servo is turned ON.

 **CAUTION**

- The tuning-less function is disabled during torque control.
- The Servomotor may momentarily emit a sound or vibrate the first time the servo is turned ON after the Servomotor is connected to the machine.
This sound is caused by setting the automatic notch filter. It does not indicate a problem. However, if this sound or vibration continues, manually set a function to suppress vibration (e.g., a notch filter).
- The Servomotor may vibrate if it exceeds the allowable load moment of inertia.
If that occurs, set the tuning-less load level to 2 (Pn170 = n.2□□□) or reduce the Tuning-less Rigidity Level (Pn170 = n.□X□□).
- To ensure safety, make sure that you can perform an emergency stop at any time when you execute the tuning-less function.

9.4.1 Application Restrictions

The following application restrictions apply to the tuning-less function.

Function	Executable*	Remarks
Vibration Detection Level Initialization	○	-
Moment of Inertia Estimation	×	Disable the tuning-less function (Pn170 = n.□□□0) before you execute moment of inertia estimation.
Autotuning without Host Reference	×	Disable the tuning-less function (Pn170 = n.□□□0) before you execute autotuning without a host reference.
Autotuning with Host Reference	×	-
Custom Tuning	×	-
Anti-Resonance Control Adjustment	×	-
Vibration Suppression	×	-
Easy FFT	○	The tuning-less function is disabled while you execute Easy FFT and then it is enabled when Easy FFT has been completed.
Friction Compensation	×	-
Gain Selection	×	-
Mechanical Analysis	○	The tuning-less function is disabled while you execute mechanical analysis and then it is enabled when mechanical analysis has been completed.

* ○: Yes ×: No

9.4.2 Operating Procedure

The tuning-less function is enabled in the default settings. No specific procedure is required. You can use the following parameter to enable or disable the tuning-less function.

Parameter		Meaning	When Enabled	Classification
Pn170 (2170h)	n.□□□0	Disable tuning-less function.	After restart	Setup
	n.□□□1 (default setting)	Enable tuning-less function.		
	n.□□0□ (default setting)	Use for speed control.		
	n.□□1□	Use for speed control and use host controller for position control.		

When you enable the tuning-less function, you can select the tuning-less type. Normally, set Pn14F to n.□□2□ (Use tuning-less type 3) (default setting). If compatibility with previous models is required, set Pn14F to n.□□0□ (Use tuning-less type 1) or n.□□1□ (Use tuning-less type 2).

Parameter		Meaning	When Enabled	Classification
Pn14F (214Fh)	n.□□0□	Use tuning-less type 1.	After restart	Tuning
	n.□□1□	Use tuning-less type 2. (The noise level is improved more than with tuning-less type 1.)		
	n.□□2□ (default setting)	Use tuning-less type 3.		

Tuning-less Level Settings

If vibration or other problems occur, change the tuning-less levels. To change the tuning-less levels, use the SigmaWin+.

◆ Preparations

Check the following settings before you set the tuning-less levels.

- The tuning-less function must be enabled (Pn170 = n.□□□1).
- The test without a motor function must be disabled (Pn00C = n.□□□0).
- The Servomotor must be connected to the machine.

◆ Procedure

Use the following procedure to set the tuning-less levels.

In addition to the following procedure, you can also set the parameters directly. Refer to *Related Parameters*, below, for the parameters to set.

1. Select **Setup - Response Level Setting** from the menu bar of the Main Window of the SigmaWin+.
The Response Level Setting Dialog Box will be displayed.

- Click the ▲ or ▼ Button to adjust the response level setting. Increase the response level setting to increase the response. Decrease the response level setting to suppress vibration.

The default response level setting is 4.

Response Level Setting	Description	Remarks
7	Response level: High	You cannot select these levels if tuning-less type 1 or 2 (Pn14F = n.□□0□ or n.□□1□) is used.
6		
5		
4 (default setting)		
3		
2		
1		
0	Response level: Low	-

- Click the **Completed Button**.

The adjustment results will be saved in the SERVOPACK.



Reset the tuning-less level to the default setting when removing the Servomotor from the machine. The Servomotor may vibrate if the tuning-less level is not reset and the servo is turned ON when the Servomotor has been removed from the machine.

◆ Related Parameters

■ Tuning-less Rigidity Level

If you use tuning-less type 1 or 2 (Pn14F = n.□□0□ or n.□□1□), set the tuning-less level to between 0 and 4 (Pn170 = n.□0□□ to n.□4□□). Do not set the tuning-less level to between 5 and 7 (Pn170 = n.□5□□ to n.□7□□).

Parameter	Description	When Enabled	Classification	
Pn170 (2170h)	n.□0□□	Tuning-less rigidity level 0 (low rigidity)	Immediately	Setup
	n.□1□□	Tuning-less rigidity level 1		
	n.□2□□	Tuning-less rigidity level 2		
	n.□3□□	Tuning-less rigidity level 3		
	n.□4□□ (default setting)	Tuning-less rigidity level 4		
	n.□5□□	Tuning-less rigidity level 5		
	n.□6□□	Tuning-less rigidity level 6		
	n.□7□□	Tuning-less rigidity level 7 (high rigidity)		

■ Tuning-less Load Level

Parameter	Description	When Enabled	Classification	
Pn170 (2170h)	n.0□□□	Tuning-less load level 0	Immediately	Setup
	n.1□□□ (default setting)	Tuning-less load level 1		
	n.2□□□	Tuning-less load level 2		

9.4.3 Troubleshooting Alarms

An A.521 alarm (Autotuning Alarm) will occur if a resonant sound occurs or if excessive vibration occurs during position control. If an alarm occurs, implement the following measures.

- Resonant Sound
Decrease the setting of Pn170 = n.X□□□ or the setting of Pn170 = n.□X□□.
- Excessive Vibration during Position Control
Increase the setting of Pn170 = n.X□□□ or decrease the setting of Pn170 = n.□X□□.

9.4.4 Parameters Disabled by Tuning-less Function

When the tuning-less function is enabled (Pn170 = n.□□□1) (default setting), the parameters in the following table are disabled.

Item	Parameter Name	Parameter Number
Gain-Related Parameters	Speed Loop Gain	Pn100 (2100h)
	Second Speed Loop Gain	Pn104 (2104h)
	Speed Loop Integral Time Constant	Pn101 (2101h)
	Second Speed Loop Integral Time Constant	Pn105 (2105h)
	Position Loop Gain	Pn102 (2102h)
	Second Position Loop Gain	Pn106 (2106h)
	Moment of Inertia Ratio	Pn103 (2103h)
Advanced Control-Related Parameters	Friction Compensation Function Selection	Pn408 (2408h) = n.X□□□
	Anti-Resonance Control Selection	Pn160 (2160h) = n.□□□X
Gain Selection-Related Parameters	Gain Switching Selection	Pn139 (2139h) = n.□□□X

The tuning-less function is disabled during torque control, Easy FFT, and mechanical analysis for a vertical axis. The gain-related parameters in the above table are enabled for torque control, Easy FFT, and mechanical analysis. Of these, Pn100, Pn103, and Pn104 are enabled for torque control.

9.4.5 Automatically Adjusted Function Setting

You can also automatically adjust notch filters.

Normally, set Pn460 to n.□1□□ (Adjust automatically) (default setting). Vibration is automatically detected and a notch filter is set.

Set Pn460 to n.□0□□ (Do not adjust automatically) only if you do not change the setting of the notch filter before you execute the tuning-less function.

Parameter	Meaning	When Enabled	Classification
Pn460 (2460h)	n.□0□□	Immediately	Tuning
	n.□1□□ (default setting)		

9.4.6 Related Parameters

The following parameters are automatically adjusted when you execute the tuning-less function.

Do not manually change the settings of these parameters after you have enabled the tuning-less function.

Parameter	Name
Pn401 (2401h)	First Stage First Torque Reference Filter Time Constant
Pn40A (240Ah)	First Stage Notch Filter Q Value
Pn40C (240Ch)	Second Stage Notch Filter Frequency
Pn40D (240Dh)	Second Stage Notch Filter Q Value

9.5 Estimating the Moment of Inertia

This section describes how the moment of inertia is calculated.

The moment of inertia ratio that is calculated here is used in other tuning functions. You can also estimate the moment of inertia during autotuning without a host reference. Refer to the following section for the procedure.

 9.6.4 Operating Procedure on page 9-25

9.5.1 Outline

The moment of inertia during operation is automatically calculated by the SERVOPACK for round-trip (forward and reverse) operation. A reference from the host controller is not used.

The moment of inertia ratio (i.e., the ratio of the load moment of inertia to the motor moment of inertia) is a basic parameter for adjusting gains. It must be set as accurately as possible.

Although the load moment of inertia can be calculated from the weight and structure of the mechanisms, doing so is very troublesome and calculating it accurately can be very difficult with the complex mechanical structures that are used these days. With an estimate of the moment of inertia, you can obtain an accurate load moment of inertia simply by running the Servomotor in the actual system in a forward and reverse direction a few times.

The motor is operated with the following specifications.

- Maximum speed: $\pm 1,000 \text{ min}^{-1}$ (can be changed)
- Acceleration rate: $\pm 20,000 \text{ min}^{-1}/\text{s}$ (can be changed)
- Travel distance: ± 2.5 rotations max. (can be changed)

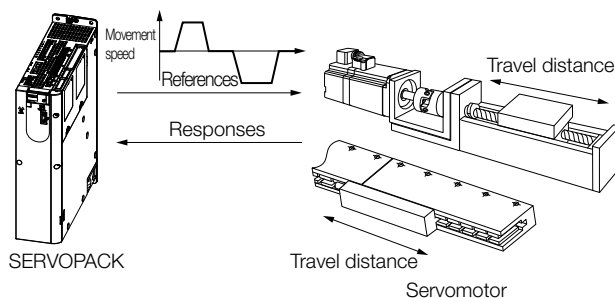

Note: Execute moment of inertia estimation after jogging to a position that ensures a suitable range of motion.

9.5.2 Restrictions

The following restrictions apply to estimating the moment of inertia.

Systems for which Execution Cannot Be Performed

- When the machine system can move only in one direction
- When the range of motion is 0.5 rotations or less

Systems for Which Adjustments Cannot Be Made Accurately

- When a suitable range of motion is not possible
- When the moment of inertia changes within the set operating range
- When the machine has high dynamic friction
- When the rigidity of the machine is low and vibration occurs when positioning is performed
- When the position integration function is used
- When proportional control is used

- When mode switching is used

Note: If you specify moment of inertia estimation, mode switching will be disabled and PI control will be used while the moment of inertia is being calculated. Mode switching will be enabled after moment of inertia estimation has been completed.

- When speed feedforward or torque feedforward is input

Preparations

Check the following settings before you execute moment of inertia estimation.

- The main circuit power supply must be ON.
- There must be no overtravel.
- The servo must be OFF.
- The control method must not be set to torque control.
- The first gains must be selected.
- The test without a motor function must be disabled (Pn00C = n.□□□0).
- There must be no alarms or warnings.
- There must be no hard wire base block (HWBB).
- The parameters must not be write prohibited.
- The tuning-less function must be disabled (Pn170 = n.□□□0).

9.5.3 Applicable Tools

The following table lists the tools that you can use to estimate the moment of inertia.

Tool	Fn No./Function Name	Operating Procedure Reference
SigmaWin+	<i>Tuning - Tuning</i>	 9.5.4 Operating Procedure on page 9-17

9.5.4 Operating Procedure

Use the following procedure to set the moment of inertia ratio.

WARNING

- Estimating the moment of inertia requires operating the motor and therefore presents hazards. Observe the following precaution.
 - Confirm safety around moving parts.

This function involves automatic operation with vibration. Make sure that you can perform an emergency stop (to turn OFF the power supply) at any time. There will be movement in both directions within the set range of movement. Check the range of movement and the directions and implement protective controls for safety, such as the overtravel functions.

CAUTION

- Be aware of the following points if you cancel the moment of inertia estimation while the motor is operating.
 - If you cancel operation with the **Servo OFF** Button, the motor will stop according to setting of the Servo OFF stopping method (Pn001 = n.□□□X).
 - If you cancel operation with the **Cancel** Button, the motor will decelerate to a stop and then enter a zero-clamped state.

1. Click the  Servo Drive Button in the workspace of the Main Window of the SigmaWin+.

2. Select **Tuning** in the Menu Dialog Box.
The Tuning Dialog Box will be displayed.
Click the **Cancel** Button to cancel tuning.

3. Click the **Execute** Button.

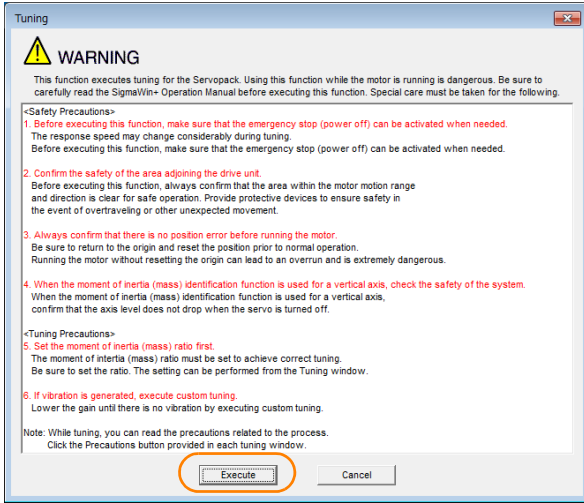

4. Click the **Execute** Button.

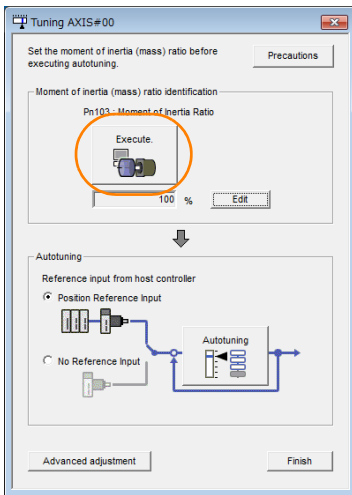

5. Set the conditions as required.

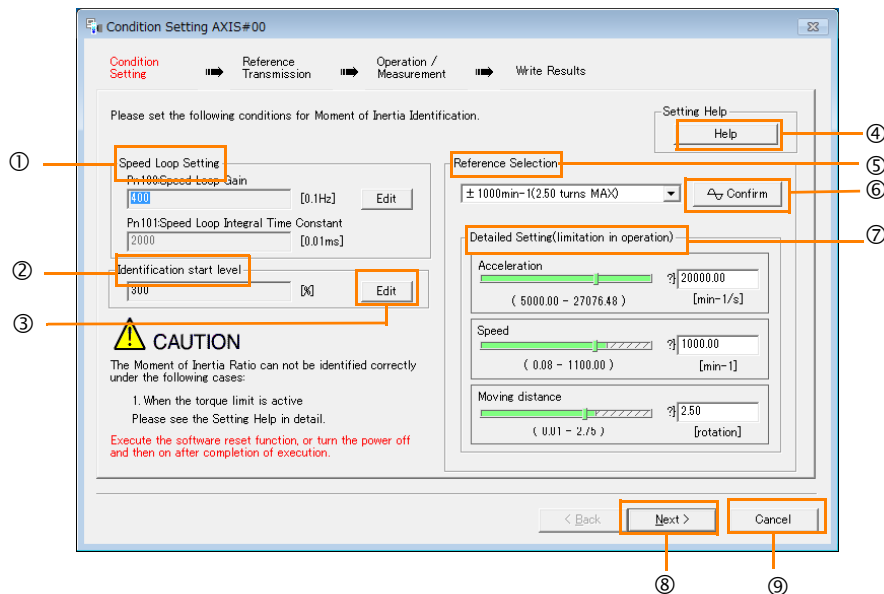

① **Speed Loop Setting** Area

Make the speed loop settings in this area.

If the speed loop response is too bad, it will not be possible to measure the moment of inertia ratio accurately.

The values for the speed loop response that are required for moment of inertia estimation are set for the default settings. It is normally not necessary to change these settings.

If the default speed loop gain is too high for the machine (i.e., if vibration occurs), lower the setting. It is not necessary to increase the setting any farther.

② **Identification Start Level** Group

This is the setting of the moment of inertia calculation starting level.

If the load is large or the machine has low rigidity, the torque limit may be applied, causing moment of inertia estimation to fail.

If that occurs, estimation may be possible if you double the setting of the start level.

③ **Edit** Buttons

Click the button to display a dialog box to change the settings related to the speed loop or estimation start level.

④ **Help** Button

Click this button to display guidelines for setting the reference conditions. Make the following settings as required.

- Operate the motor to measure the load moment of inertia of the machine in comparison with the rotor moment of inertia.
- Set the operation mode, reference pattern (maximum acceleration rate, maximum speed, and maximum travel distance), and speed loop-related parameters.
- Correct measurement of the moment of inertia ratio may not be possible depending on the settings. Set suitable settings using the measurement results as reference.

⑤ **Reference Selection** Area

Either select the reference pattern for estimation processing from the box, or set the values in the **Detailed Setting** Group. Generally speaking, the larger the maximum acceleration rate is, the more accurate the moment of inertia estimation will be.

Set the maximum acceleration range within the possible range of movement considering the gear ratio, e.g., the pulley diameters or ball screw pitch.

⑥ **Confirm** Button

Click this button to display the Reference Confirmation Dialog Box.

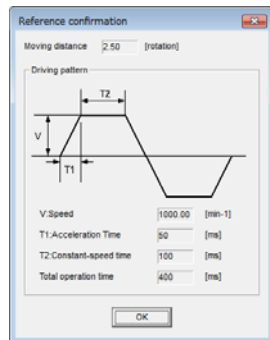
⑦ **Detailed Setting** Area

You can change the settings by moving the bars or directly inputting the settings to create the required reference pattern.

⑧ **Next** Button

Click this button to display the Reference Transmission Dialog Box.

⑨ **Cancel** Button

Click this button to return to the Tuning Dialog Box.

⚠ CAUTION

- The travel distance is the distance for one operation in the forward or reverse direction. During multiple operations, the operation starting position may move in one direction or the other. Confirm the possible operating range for each measurement or operation.
- Depending on the parameter settings and the moment of inertia of the machine, overshooting may occur and may cause the maximum speed setting to be exceeded temporarily. Allow sufficient leeway in the settings.

Information When Measurement Is Not Correct
 Estimating the moment of inertia ratio cannot be performed correctly if the torque limit is activated. Adjust the limits or reduce the acceleration rate in the reference selection so that the torque limit is not activated.

- 6. Click the **Next** Button.
 The Reference Transmission Dialog Box will be displayed.
- 7. Click the **Start** Button.

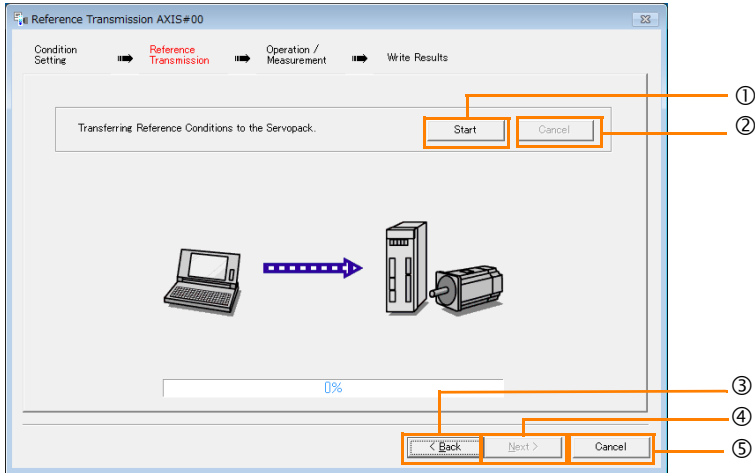

- ① **Start** Button
 The reference conditions will be transferred to the SERVOPACK. A progress bar will show the progress of the transfer.
- ② **Cancel** Button
 The **Cancel** Button is enabled only while data is being transferred to the SERVOPACK. You cannot use it after the transfer has been completed.
- ③ **Back** Button
 This button returns you to the Condition Setting Dialog Box. It is disabled while data is being transferred.
- ④ **Next** Button
 This button is enabled only when the data has been transferred correctly. You cannot use it if an error occurs or if you cancel the transfer before it is completed. Click the **Next** Button to display the Operation/Measurement Dialog Box.
- ⑤ **Cancel** Button
 This button cancels processing and returns you to the Tuning Dialog Box.

- 8. Click the **Next** Button.
 The Operation/Measurement Dialog Box will be displayed.
- 9. Click the **Servo On** Button.

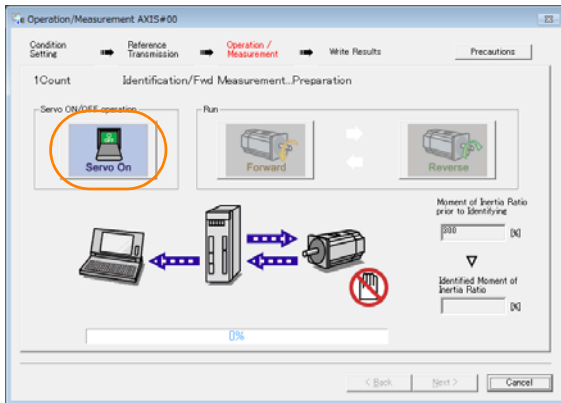

10. Click the Forward Button.

The shaft will rotate in the forward direction and the measurement will start. After the measurement and data transfer have been completed, the **Reverse** Button will be displayed in color.

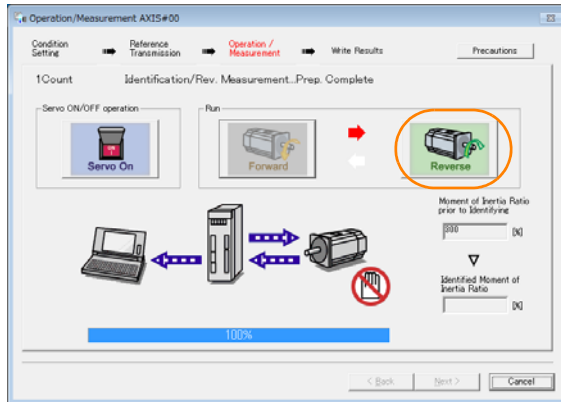
11. Click the Reverse Button.

The shaft will rotate in the reverse direction and the measurement will start. After the measurement and data transfer have been completed, the **Forward** Button will be displayed in color.

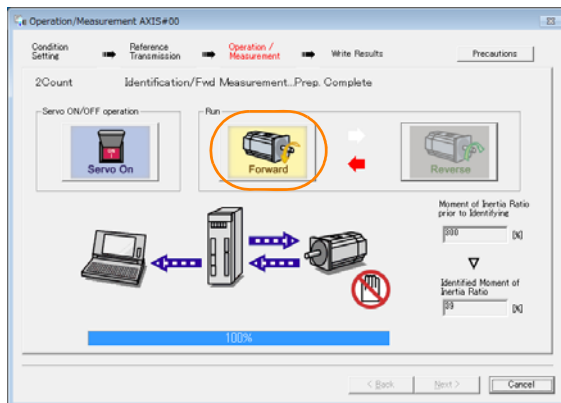
**12. Repeat steps 9 to 11 until the Next Button is enabled.**

Measurements are performed from 2 to 7 times and then verified. The number of measurements is displayed in upper left corner of the dialog box. A progress bar at the bottom of the dialog box will show the progress of the transfer each time.

13. When the measurements have been completed, click the Servo On Button to turn OFF the servo.**14. Click the Next Button.**

The Write Results Dialog Box will be displayed.

Information

If you click the **Next** Button before you turn OFF the servo, the following Dialog Box will be displayed. Click the **OK** Button to turn OFF the servo.

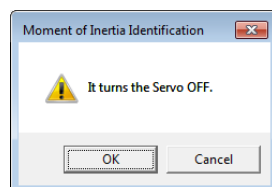

15. Click the **Writing Results Button**.

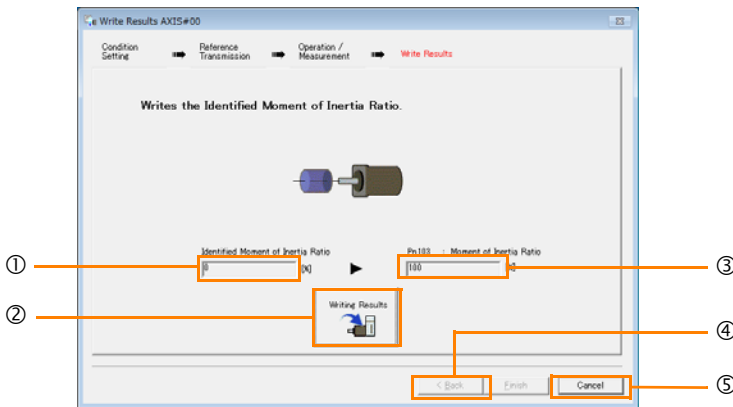

- ① **Identified Moment of Inertia Ratio Box**
The moment of inertia ratio that was found with operation and measurements is displayed here.
- ② **Writing Results Button**
If you click this button, Pn103 (Moment of Inertia Ratio) in the SERVOPACK is set to the value that is displayed for the identified moment of inertia ratio.
- ③ **Pn103: Moment of Inertia Ratio Box**
The value that is set for the parameter is displayed here.
After you click the **Writing Results** Button, the value that was found with operation and measurements will be displayed as the new setting.
- ④ **Back Button**
This button is disabled.
- ⑤ **Cancel Button**
This button will return you to the Tuning Dialog Box.

16. Confirm that the **Identified Moment of Inertia Ratio Box** and the **Pn103: Moment of Inertia Ratio Box** show the same value and then click the **Finish Button**.

17. Click the **OK Button**.

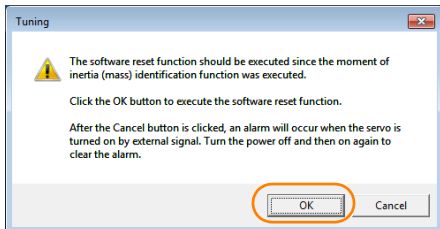

18. Click the **Execute Button**.

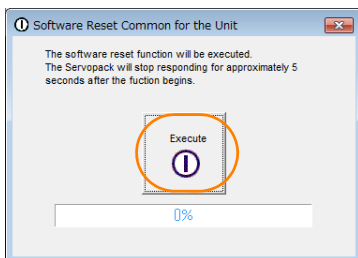

If the setting of the moment of inertia ratio (Pn103) was changed, the new value will be saved and the Tuning Dialog Box will be displayed again.

This concludes the procedure to estimate the moment of inertia ratio.

9.6

Autotuning without Host Reference

This section describes autotuning without a host reference.



Important

- Autotuning without a host reference performs adjustments based on the setting of the speed loop gain (Pn100). Therefore, precise adjustments cannot be made if there is vibration when adjustments are started. Make adjustments after lowering the speed loop gain (Pn100) until vibration is eliminated.
- You cannot execute autotuning without a host reference if the tuning-less function is enabled (Pn170 = n.□□□1 (default setting)). Disable the tuning-less function (Pn170 = n.□□□0) before you execute autotuning without a host reference.
- If you change the machine load conditions or drive system after you execute autotuning without a host reference and then you execute autotuning without a host reference with moment of inertia estimation specified, use the following parameter settings. If you execute autotuning without a host reference for any other conditions, the machine may vibrate and may be damaged.

Pn140 = n.□□□0 (Do not use model following control.)

Pn160 = n.□□□0 (Do not use anti-resonance control.)

Pn408 = n.00□0 (Disable friction compensation, first stage notch filter, and second stage notch filter.)

Note: If you are using the Digital Operator and the above parameters are not displayed, change the parameter display setting to display all parameters (Pn00B = n.□□□1) and then turn the power supply OFF and ON again.

9.6.1

Outline

For autotuning without a host reference, operation is automatically performed by the SERVO-PACK for round-trip (forward and reverse) operation to adjust for machine characteristics during operation. A reference from the host controller is not used.

The following items are adjusted automatically.

- Moment of inertia ratio
- Gains (e.g., speed loop gain and position loop gain)
- Filters (torque reference filter and notch filters)
- Friction compensation
- Anti-resonance control
- Vibration suppression (only for mode 2 or 3)

Refer to the following section for details on the parameters that are adjusted.

9.6.7 Related Parameters on page 9-33

The motor is operated with the following specifications.

Maximum Speed	Rated motor speed × $\frac{2}{3}$	
Acceleration Torque	Rated motor torque: Approx. 100% Note: The acceleration torque depends on the setting of the influence of the moment of inertia ratio (Pn103), machine friction, and external disturbance.	
Travel Distance	Rotary Servomotors	You can set the desired travel distance. The default setting is for a value equivalent to 3 motor shaft rotations.
	Linear Servomotors	You can set the desired travel distance in increments of 1,000 reference units. (The default setting is for 90 mm.)

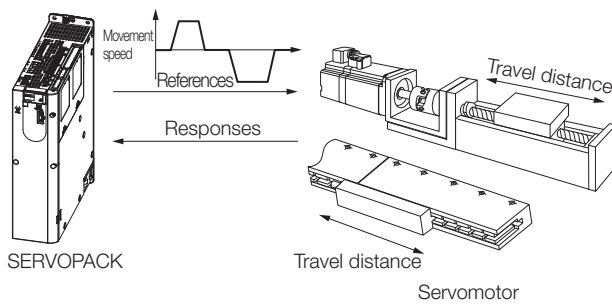

Note: Execute autotuning without a host reference after jogging to a position that ensures a suitable range of motion.

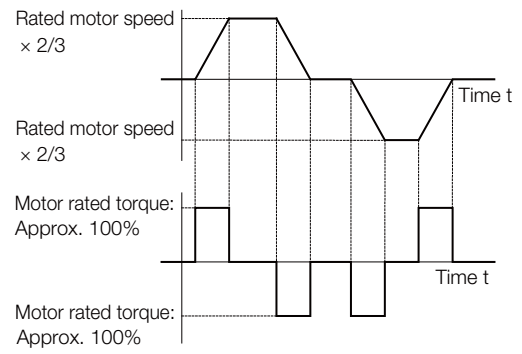

Example of Automatic Operation Pattern

! WARNING

- Autotuning without a host reference requires operating the motor and therefore presents hazards. Observe the following precaution.
 - Confirm safety around moving parts. This function involves automatic operation with vibration. Make sure that you can perform an emergency stop (to turn OFF the power supply) at any time. There will be movement in both directions within the set range of movement. Check the range of movement and the directions and implement protective controls for safety, such as the overtravel functions.

9.6.2 Restrictions

The following restrictions apply to autotuning without a host reference.

If you cannot use autotuning without a host reference because of these restrictions, use autotuning with a host reference or custom tuning. Refer to the following sections for details.

9.7 Autotuning with a Host Reference on page 9-34

9.8 Custom Tuning on page 9-41

Systems for Which Execution Cannot Be Performed

- When the machine system can move only in one direction
- When the range of motion is 0.5 rotations or less

Systems for Which Adjustments Cannot Be Made Accurately

- When a suitable range of motion is not possible
- When the moment of inertia changes within the set operating range
- When the machine has high friction
- When the rigidity of the machine is low and vibration occurs when positioning is performed
- When the position integration function is used
- When proportional control is used
- When mode switching is used

Note: If you specify moment of inertia estimation, mode switching will be disabled and PI control will be used while the moment of inertia is being calculated. Mode switching will be enabled after moment of inertia estimation has been completed.

- When speed feedforward or torque feedforward is input
- When the positioning completed width (Pn522) is too narrow

Preparations

Check the following settings before you execute autotuning without a host reference.



- The main circuit power supply must be ON.
- There must be no overtravel.
- The servo must be OFF.
- The control method must not be set to torque control.
- The first gains must be selected.
- The test without a motor function must be disabled (Pn00C = n.□□□0).
- There must be no alarms or warnings.
- There must be no hard wire base block (HWBB).
- The parameters must not be write prohibited.
- The tuning-less function must be disabled (Pn170 = n.□□□0), or the tuning-less function must be enabled (Pn170 = n.□□□1) and moment of inertia estimation must be specified.
- If you execute autotuning without a host reference during speed control, set the mode to 1.

Information

- If you start autotuning without a host reference while the SERVOPACK is in speed control for mode 2 or 3, the SERVOPACK will change to position control automatically to perform autotuning without a host reference. The SERVOPACK will return to speed control after autotuning has been completed.

9.6.3 Applicable Tools

The following table lists the tools that you can use to perform autotuning without a host reference.

Tool	Fn No./Function Name	Operating Procedure Reference
Digital Operator	Fn201	 Σ -7-Series Digital Operator Operating Manual (Manual No.: SIEP S800001 33)
SigmaWin+	Tuning - Tuning	 9.6.4 Operating Procedure on page 9-25

9.6.4 Operating Procedure

Use the following procedure to perform autotuning without a host reference.

CAUTION

- If you specify not estimating the moment of inertia, set the moment of inertia ratio (Pn103) correctly. If the setting greatly differs from the actual moment of inertia ratio, normal control of the machine may not be possible, and vibration may result.

1. Confirm that the moment of inertia ratio (Pn103) is set correctly.
2. Click the  Servo Drive Button in the workspace of the Main Window of the SigmaWin+.
3. Select **Tuning** in the Menu Dialog Box.
The Tuning Dialog Box will be displayed.
Click the **Cancel** Button to cancel tuning.

4. Click the **Execute** Button.

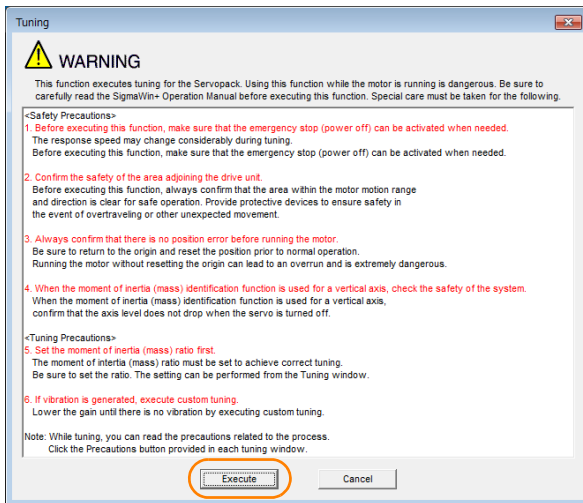

5. Select the **No Reference Input** Option in the Autotuning Area and then click the **Auto-tuning** Button.

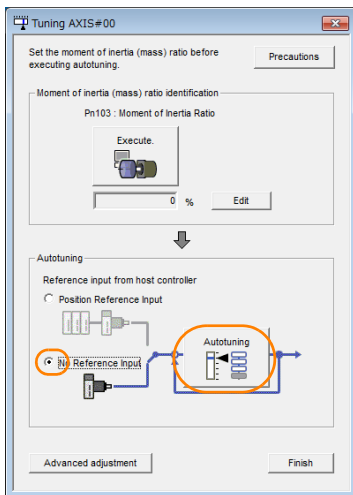

Information When the following dialog box is displayed, click the **OK** Button and then confirm that the correct moment of inertia ratio is set in Pn103 (Moment of Inertia Ratio).

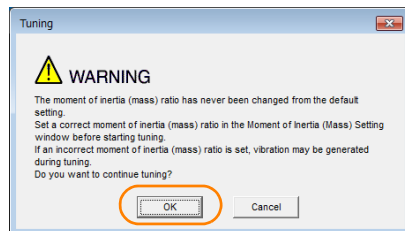

- Set the conditions in the **Switching the load moment of inertia (load mass) identification Box**, the **Mode selection Box**, the **Mechanism selection Box**, and the **Distance Box**, and then click the **Next Button**.

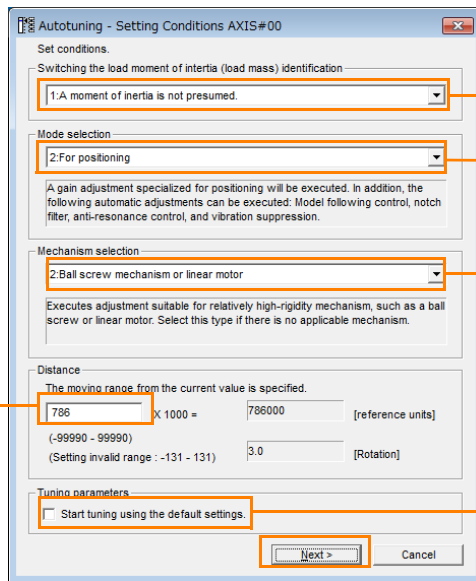

- Switching the load moment of inertia (load mass) identification Box**
 Specify whether to estimate the moment of inertia.
 0: A moment of inertia is presumed. (default setting)
 1: A moment of inertia is not presumed.

- Mode selection Box**
 Set the mode.

Mode Selection	Description
1: Standard	Standard gain adjustment is performed. In addition to gain adjustment, notch filters and anti-resonance control are automatically adjusted.
2: For positioning	Tuning is performed for positioning applications. In addition to gain adjustment, model following control, notch filters, anti-resonance control, and vibration suppression are automatically adjusted.
3: For positioning especially to prevent overshooting	Tuning is performed for positioning applications with emphasis on eliminating overshooting. In addition to gain adjustment, notch filters, anti-resonance control, and vibration suppression are automatically adjusted.

- Distance Box**
 Set the travel distance.
 Movement range: -99,990,000 to +99,990,000 [reference units]
 Minimum setting increment for travel distance: 1,000 [reference units]
 Negative values are for reverse operation and positive values are for forward operation from the current position.
 Default settings:
 Rotary Servomotors: Approx. 3 rotations
 Linear Servomotors: Approx 90 mm
 Set the distance to the following values or higher. To ensure tuning precision, we recommend that you use approximately the default distance setting.
 Rotary Servomotors: 0.5 rotations
 Linear Servomotors: 5 mm

- Mechanism selection Box**
 Select the type according to the machine element to drive.
 If there is noise or if the gain does not increase, better results may be obtained by changing the rigidity type. Select the type according to the following guidelines.

Mechanism Selection	Description
1: Belt mechanism	Tuning is performed for a mechanism with relatively low rigidity, e.g., a belt.
2: Ball screw mechanism or linear motor	Tuning is performed for a mechanism with relatively high rigidity, e.g., a ball screw or Linear Servomotor. Use this setting if there is no other appropriate setting.
3: Rigid model	Tuning is performed for a mechanism with high rigidity, e.g., a rigid body system.

- Tuning parameters Box**
 Specify the parameters to use for tuning.
 If you select the **Start tuning using the default settings** Check Box, the tuning parameters will be returned to the default settings before tuning is started.

7. Click the Servo ON Button.



8. Click the Start tuning Button.

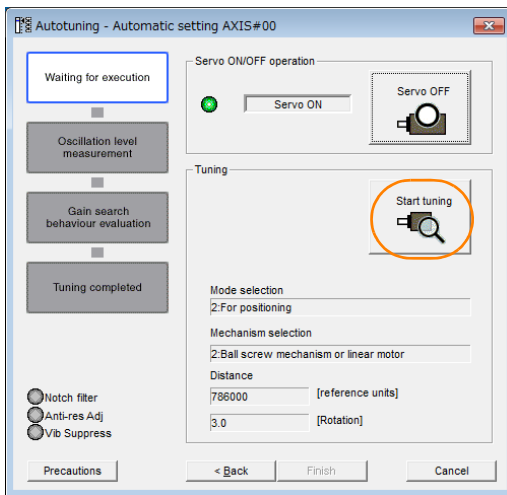

9. Confirm safety around moving parts and click the **Yes** Button.



The motor will start operating and tuning will be executed.

Vibration that occurs during tuning will be detected automatically and suitable settings will be made for that vibration. When the settings have been completed, the indicators for the functions that were used will light at the lower left of the dialog box.

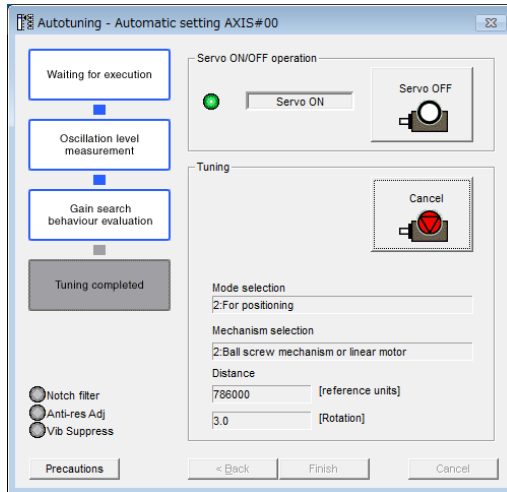

10. When tuning has been completed, click the **Finish** Button.

The results of tuning will be set in the parameters and you will return to the Tuning Dialog Box.

This concludes the procedure to perform autotuning without a host reference.

9.6.5 Troubleshooting Problems in Autotuning without a Host Reference

The following tables give the causes of and corrections for problems that may occur in autotuning without a host reference.

◆ Autotuning without a Host Reference Was Not Performed

Possible Cause	Corrective Action
Main circuit power supply is OFF.	Turn ON the main circuit power supply.
An alarm or warning occurred.	Remove the cause of the alarm or warning.
Overtraveling occurred.	Remove the cause of overtraveling.
The second gains were selected with the gain selection.	Disable automatic gain switching.
The HWBB was activated.	Release the HWBB.
The setting of the travel distance is too small.	Set the travel distance again in step 6 of the procedure.
The settings for the tuning-less function are not correct.	<ul style="list-style-type: none"> Disable the tuning-less function (Pn170 = n.□□□0). Enable the tuning-less function (Pn170 = n.□□□1) and specify moment of inertia estimation.

◆ When an Error Occurs during Execution of Autotuning without a Host Reference

Error	Possible Cause	Corrective Action
The gain adjustments were not successfully completed.	Machine vibration occurs or the positioning completion signal is not stable when the Servomotor stops.	<ul style="list-style-type: none"> • Increase the setting of the positioning completed width (Pn522). • Change the mode from 2 to 3. • If machine vibration occurs, suppress the vibration with the anti-resonance control function and the vibration suppression function.
An error occurred during calculation of the moment of inertia.	Refer to the following section for troubleshooting information.  ◆ When an Error Occurs during Calculation of Moment of Inertia on page 9-30	
Positioning was not completed within approximately 10 seconds after position adjustment was completed.	The positioning completed width is too narrow or proportional control is being used.	Increase the setting of the positioning completed width (Pn522).

◆ When an Error Occurs during Calculation of Moment of Inertia

Possible Cause	Corrective Action
The SERVOPACK started calculating the moment of inertia but the calculation was not completed.	<ul style="list-style-type: none"> • Increase the setting of the speed loop gain (Pn100). • Increase the stroke (travel distance).
The moment of inertia fluctuated greatly and did not converge within 10 tries.	Set Pn103 (Moment of Inertia Ratio) from the machine specifications and specify not estimating the moment of inertia.
Low-frequency vibration was detected.	Double the setting of moment of inertia calculation starting level (Pn324).
The torque limit was reached.	<ul style="list-style-type: none"> • If you are using the torque limit, increase the torque limit. • Double the setting of moment of inertia calculation starting level (Pn324).
Speed control changed to proportional control during calculation of the moment of inertia.	Use PI control when calculating the moment of inertia.

◆ Adjustment Results Are Not Satisfactory for Position Control

You may be able to improve the adjustment results by changing the settings of the positioning completed width (Pn522) and position reference unit (*position user unit* (2701h)).

If satisfactory results are still not possible, adjust the overshoot detection level (Pn561). That may improve the adjustment results.

- Pn561 = 100% (default setting)
This will allow tuning with overshooting that is equivalent to the positioning completed width.
- Pn561 = 0%
This will allow tuning to be performed without overshooting within the positioning completed width, but the positioning completed width may be extended.

Pn561 (2561h)	Overshoot Detection Level			Speed	Position	Torque
	Setting Range	Setting Unit	Default Setting	When Enabled	Classification	
	0 to 100	1%	100	Immediately	Setup	

9.6.6 Automatically Adjusted Function Settings

You can specify whether to automatically adjust the following functions during autotuning.

◆ Automatic Notch Filters

Normally, set Pn460 to n.□1□□ (Adjust automatically) (default setting).

Vibration will be detected during autotuning without a host reference and a notch filter will be adjusted.

Set Pn460 to n.□0□□ (Do not adjust automatically) only if you do not change the setting of the notch filter before you execute this function.

Parameter	Function	When Enabled	Classification
Pn460 (2460h)	n.□□□0	Immediately	Tuning
	n.□□□1 (default setting)		
	n.□0□□		
	n.□1□□ (default setting)		

◆ Anti-Resonance Control Adjustment

This function reduces low vibration frequencies, for which the notch filters cannot be used.

Normally, set Pn160 to n.□□1□ (Adjust automatically) (default setting).

Vibration will be detected during autotuning without a host reference and anti-resonance control will be automatically adjusted.

Parameter	Function	When Enabled	Classification
Pn160 (2160h)	n.□□0□	Immediately	Tuning
	n.□□1□ (default setting)		

◆ Vibration Suppression

You can use vibration suppression to suppress transitional vibration at a low frequency from 1 Hz to 100 Hz, which is generated mainly when the machine vibrates during positioning.

Normally, set Pn140 to n.□1□□ (Adjust automatically) (default setting).

Vibration will be detected during autotuning without a host reference and vibration suppression control will be automatically set.

Set Pn140 = n.□0□□ (Do not adjust automatically) only if you do not change the settings for vibration suppression before you execute autotuning without a host reference.

Note: Autotuning without a host reference uses model following control. Therefore, it can be executed only if the mode is set to 2 or 3.

Parameter		Function	When Enabled	Classification
Pn140 (2140h)	n.0000	Do not adjust vibration suppression automatically during execution of autotuning without a host reference, autotuning with a host reference, and custom tuning.	Immediately	Tuning
	n.1000 (default setting)	Adjust vibration suppression automatically during execution of autotuning without a host reference, autotuning with a host reference, and custom tuning.		

◆ Friction Compensation

Friction compensation compensates for changes in the following conditions.

- Changes in the viscous resistance of the lubricant, such as grease, on the sliding parts of the machine
- Changes in the friction resistance resulting from variations in the machine assembly
- Changes in the friction resistance due to aging

The conditions for applying friction compensation depend on the mode selection.

Mode Selection Settings	Friction Compensation
1: Standard	Based on the setting of Pn408 = n.X000 (Friction Compensation Function Selection)*
2: For position control	Adjusted with friction compensation.
3: For position control (emphasis on overshooting)	

Parameter		Function	When Enabled	Classification
Pn408 (2408h)	n.0000 (default setting)	Disable friction compensation.	Immediately	Setup
	n.1000	Enable friction compensation.		

* Refer to the following section for details.
 Required Parameter Settings on page 9-68

◆ Feedforward

If Pn140 is set to n.0000 (Do not use model following control and speed/torque feedforward together (default setting)) and tuning is performed with the mode selection set to 2 or 3, feedforward (Pn109), the speed feedforward input (VFF), and the torque feedforward input (TFF) will be disabled.

To use the speed feedforward input (VFF), the torque feedforward input (TFF), and model following control from the host controller in the system, set Pn140 to n.1000 (Use model following control and speed/torque feedforward together).

Parameter		Function	When Enabled	Classification
Pn140 (2140h)	n.0000 (default setting)	Do not use model following control and speed/torque feedforward together.	Immediately	Tuning
	n.1000	Use model following control and speed/torque feedforward together.		



Important When model following control is used with the feedforward function, it is used to make optimum feedforward settings in the SERVOPACK. Therefore, model following control is not normally used together with either the speed feedforward input (VFF) or torque feedforward input (TFF) from the host controller. However, model following control can be used with the speed feedforward input (VFF) or torque feedforward input (TFF) if required. An unsuitable feedforward input may result in overshooting.

9.6.7 Related Parameters

The following parameters are automatically adjusted or used as reference when you execute autotuning without a host reference.

Do not change the settings while autotuning without a host reference is being executed.

Parameter	Name	Automatic Changes
Pn100 (2100h)	Speed Loop Gain	Yes
Pn101 (2101h)	Speed Loop Integral Time Constant	Yes
Pn102 (2102h)	Position Loop Gain	Yes
Pn103 (2103h)	Moment of Inertia Ratio	Yes
Pn121 (2121h)	Friction Compensation Gain	Yes
Pn123 (2123h)	Friction Compensation Coefficient	Yes
Pn124 (2124h)	Friction Compensation Frequency Correction	No
Pn125 (2125h)	Friction Compensation Gain Correction	Yes
Pn401 (2401h)	First Stage First Torque Reference Filter Time Constant	Yes
Pn408 (2408h)	Torque-Related Function Selections	Yes
Pn409 (2409h)	First Stage Notch Filter Frequency	Yes
Pn40A (240Ah)	First Stage Notch Filter Q Value	Yes
Pn40C (240Ch)	Second Stage Notch Filter Frequency	Yes
Pn40D (240Dh)	Second Stage Notch Filter Q Value	Yes
Pn140 (2140h)	Model Following Control-Related Selections	Yes
Pn141 (2141h)	Model Following Control Gain	Yes
Pn142 (2142h)	Model Following Control Gain Correction	Yes
Pn143 (2143h)	Model Following Control Bias in the Forward Direction	Yes
Pn144 (2144h)	Model Following Control Bias in the Reverse Direction	Yes
Pn145 (2145h)	Vibration Suppression 1 Frequency A	Yes
Pn146 (2146h)	Vibration Suppression 1 Frequency B	Yes
Pn147 (2147h)	Model Following Control Speed Feedforward Compensation	Yes
Pn160 (2160h)	Anti-Resonance Control-Related Selections	Yes
Pn161 (2161h)	Anti-Resonance Frequency	Yes
Pn163 (2163h)	Anti-Resonance Damping Gain	Yes
Pn531 (2531h)	Program Jogging Travel Distance	No
Pn533 (2533h)	Program Jogging Movement Speed for Rotary Servomotor	No
Pn585 (2585h)	Program Jogging Movement Speed for Linear Servomotor	No
Pn534 (2534h)	Program Jogging Acceleration/Deceleration Time	No
Pn535 (2535h)	Program Jogging Waiting Time	No
Pn536 (2536h)	Program Jogging Number of Movements	No

Yes: The parameter is automatically set.

No: The parameter is not automatically set, but the setting is read during execution.

9.7 Autotuning with a Host Reference

This section describes autotuning with a host reference.



Important

Autotuning with a host reference makes adjustments based on the set speed loop gain (Pn100). Therefore, precise adjustments cannot be made if there is vibration when adjustments are started. Make adjustments after lowering the speed loop gain (Pn100) until vibration is eliminated.

9.7.1 Outline

Autotuning with a host reference automatically makes optimum adjustments for operation references from the host controller.

The following items are adjusted automatically.

- Gains (e.g., speed loop gain and position loop gain)
- Filters (torque reference filter and notch filters)
- Friction compensation
- Anti-resonance control
- Vibration suppression

Refer to the following section for details on the parameters that are adjusted.

 [9.7.7 Related Parameters on page 9-40](#)

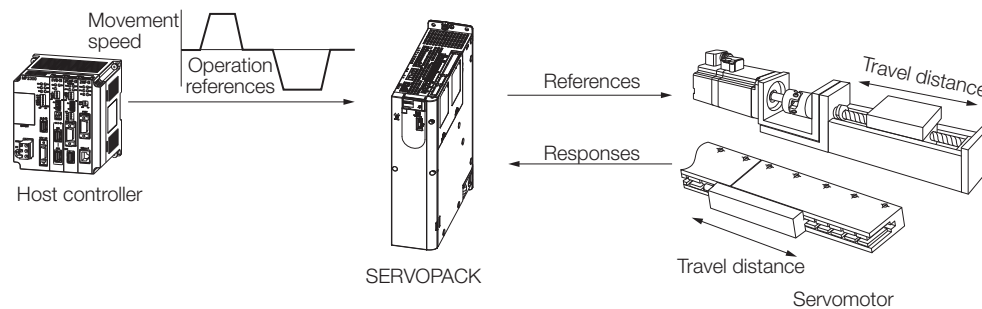

CAUTION

- Because autotuning with a host reference adjusts the SERVOPACK during automatic operation, vibration or overshooting may occur. To ensure safety, make sure that you can perform an emergency stop at any time.

9.7.2 Restrictions

Systems for Which Adjustments Cannot Be Made Accurately

Adjustments will not be made correctly for autotuning with a host reference in the following cases. Use custom tuning.

- When the travel distance for the reference from the host controller is equal to or lower than the setting of the positioning completed width (Pn522)
- Rotary Servomotors: When the movement speed for the reference from the host controller is equal to or lower than the setting of the rotation detection level (Pn502)
- Linear Servomotors: When the movement speed for the reference from the host controller is equal to or lower than the setting of the zero speed level (Pn581)
- When the time required to stop is 10 ms or less
- When the rigidity of the machine is low and vibration occurs when positioning is performed
- When the position integration function is used
- When proportional control is used
- When mode switching is used
- When the positioning completed width (Pn522) is too narrow

Refer to the following sections for details on custom tuning.

 9.8 Custom Tuning on page 9-41



Preparations

Check the following settings before you execute autotuning with a host reference.

- The servo must be in ready status.
- There must be no overtravel.
- The servo must be OFF.
- Position control must be selected if power is supplied to the motor (i.e., when the servo is ON).
- The first gains must be selected.
- The test without a motor function must be disabled (Pn00C = n.□□□0).
- There must be no warnings.
- The tuning-less function must be disabled (Pn170 = n.□□□0).
- The parameters must not be write prohibited.

9.7.3 Applicable Tools

The following table lists the tools that you can use to perform autotuning with a host reference.

Tool	Fn No./Function Name	Operating Procedure Reference
Digital Operator	Fn202	 Σ -7-Series Digital Operator Operating Manual (Manual No.: SIEP S800001 33)
SigmaWin+	<i>Tuning - Tuning</i>	 9.7.4 Operating Procedure on page 9-36

9.7.4 Operating Procedure

Use the following procedure to perform autotuning with a host reference.

1. Confirm that the moment of inertia ratio (Pn103) is set correctly.
2. Click the  Servo Drive Button in the workspace of the Main Window of the SigmaWin+.
3. Select **Tuning** in the Menu Dialog Box.
The Tuning Dialog Box will be displayed.
Click the **Cancel** Button to cancel tuning.
4. Click the **Execute** Button.

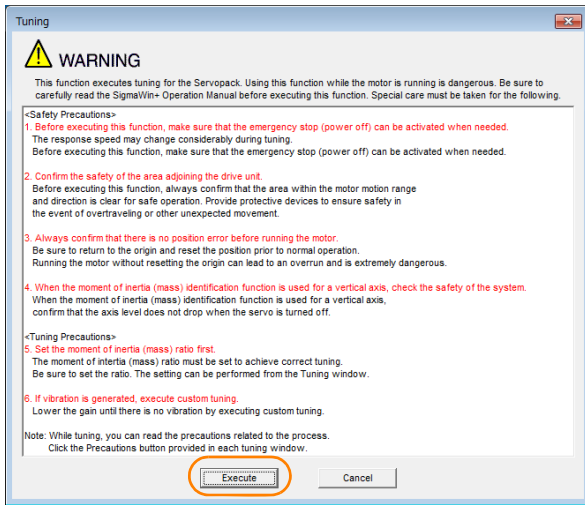

5. Select the **Position reference input** Option in the **Autotuning** Area and then click the **Autotuning** Button.

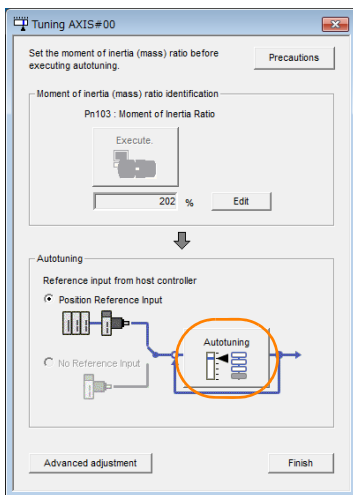

Information When the following dialog box is displayed, click the **OK** Button and then confirm that the correct moment of inertia ratio is set in Pn103 (Moment of Inertia Ratio).

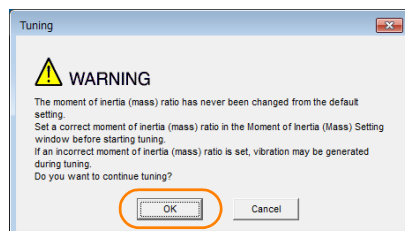

- Set the conditions in the **Mode selection Box** and the **Mechanism selection Box**, and then click the **Next Button**.
If you select the **Start tuning using the default settings** Check Box in the **Tuning parameters Area**, the tuning parameters will be returned to the default settings before tuning is started.

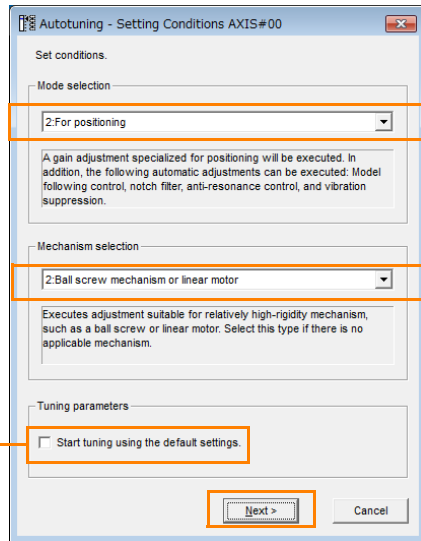

• **Mode selection Box**
Set the mode.

Mode Selection	Description
1: Standard	Standard gain adjustment is performed. In addition to gain adjustment, notch filters and anti-resonance control are automatically adjusted.
2: For positioning	Tuning is performed for positioning applications. In addition to gain adjustment, model following control, notch filters, anti-resonance control, and vibration suppression are automatically adjusted.
3: For positioning especially to prevent overshooting	Tuning is performed for positioning applications with emphasis on eliminating overshooting. In addition to gain adjustment, notch filters, anti-resonance control, and vibration suppression are automatically adjusted.

• **Tuning parameters Box**
Specify the parameters to use for tuning. If you select the **Start tuning using the default settings** Check Box, the tuning parameters will be returned to the default settings before tuning is started.

• **Mechanism selection Box**
Select the type according to the machine element to drive. If there is noise or if the gain does not increase, better results may be obtained by changing the rigidity type. Select the type according to the following guidelines.

Mechanism Selection	Description
1: Belt mechanism	Tuning is performed for a mechanism with relatively low rigidity, e.g., a belt.
2: Ball screw mechanism or linear motor	Tuning is performed for a mechanism with relatively high rigidity, e.g., a ball screw or Linear Servomotor. Use this setting if there is no other appropriate setting.
3: Rigid model	Tuning is performed for a mechanism with high rigidity, e.g., a rigid body system.

- Click the **Yes Button**.

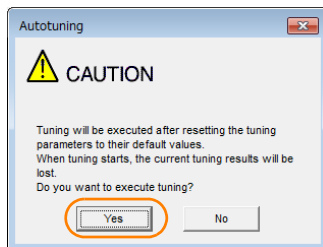

- Input the correct moment of inertia ratio and click the **Next Button**.

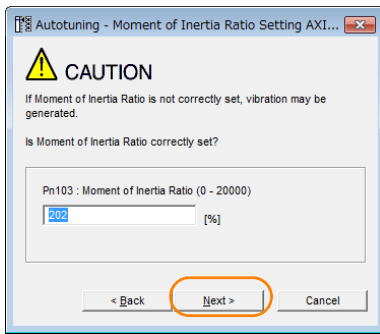

- Confirm safety around moving parts, enter a reference from the host controller, and then click the **Start tuning Button**.

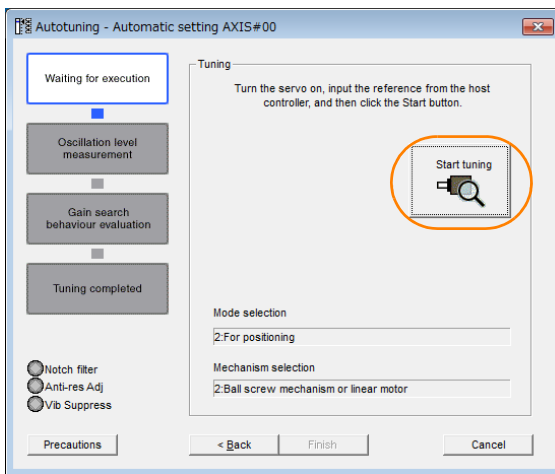

- Click the **Yes Button**.



Tuning will be executed.

Vibration that occurs during tuning will be detected automatically and suitable settings will be made for that vibration. When the settings have been completed, the indicators for the functions that were used will light at the lower left of the dialog box.

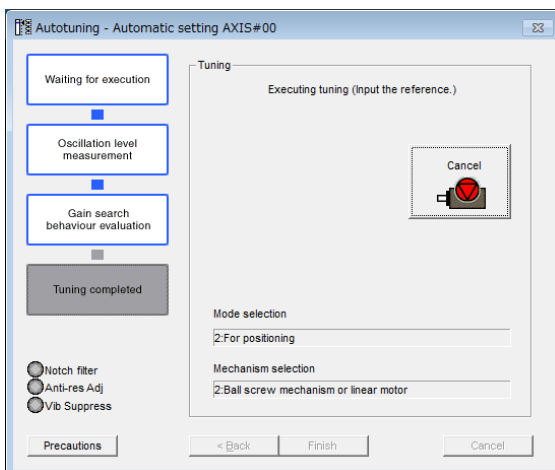

11. When tuning has been completed, click the Finish Button.

The results of tuning will be set in the parameters and you will return to the Tuning Dialog Box.

This concludes the procedure to perform autotuning with a host reference.

9.7.5 Troubleshooting Problems in Autotuning with a Host Reference

The following tables give the causes of and corrections for problems that may occur in autotuning with a host reference.

◆ Autotuning with a Host Reference Was Not Performed

Possible Cause	Corrective Action
Main circuit power supply is OFF.	Turn ON the main circuit power supply.
An alarm or warning occurred.	Remove the cause of the alarm or warning.
Overtraveling occurred.	Remove the cause of overtraveling.
The second gains were selected with the gain selection.	Disable automatic gain switching.
The HWBB was activated.	Release the HWBB.

◆ Troubleshooting Errors

Error	Possible Cause	Corrective Action
The gain adjustments were not successfully completed.	Machine vibration occurs or positioning completion is not stable when the Servomotor stops.	<ul style="list-style-type: none"> • Increase the setting of Pn522 (2522h) (Positioning Completed Width). • Change the mode from 2 to 3. • If machine vibration occurs, suppress the vibration with the anti-resonance control function and the vibration suppression function.
Positioning was not completed within approximately 10 seconds after position adjustment was completed.	The positioning completed width is too narrow or proportional control is being used.	Increase the setting of Pn522 (2522h) (Positioning Completed Width).

◆ Adjustment Results Are Not Satisfactory for Position Control

You may be able to improve the adjustment results by changing the settings of the positioning completed width (Pn522) and position reference unit (*position user unit* (2701h)).

If satisfactory results are still not possible, adjust the overshoot detection level (Pn561). That may improve the adjustment results.

- Pn561 = 100% (default setting)
This will allow tuning with overshooting that is equivalent to the positioning completed width.
- Pn561 = 0%
This will allow tuning to be performed without overshooting within the positioning completed width, but the positioning completed width may be extended.

Pn561 (2561h)	Overshoot Detection Level				
	Setting Range	Setting Unit	Default Setting	When Enabled	Classification
	0 to 100	1%	100	Immediately	Setup

9.7.6 Automatically Adjusted Function Settings

These function settings are the same as for autotuning without a host reference. Refer to the following section.

 9.6.6 Automatically Adjusted Function Settings on page 9-31

9.7.7 Related Parameters

The following parameters are automatically adjusted or used as reference when you execute autotuning with a host reference.

Do not change the settings while autotuning with a host reference is being executed.

Parameter	Name	Automatic Changes
Pn100 (2100h)	Speed Loop Gain	Yes
Pn101 (2101h)	Speed Loop Integral Time Constant	Yes
Pn102 (2102h)	Position Loop Gain	Yes
Pn103 (2103h)	Moment of Inertia Ratio	No
Pn121 (2121h)	Friction Compensation Gain	Yes
Pn123 (2123h)	Friction Compensation Coefficient	Yes
Pn124 (2124h)	Friction Compensation Frequency Correction	No
Pn125 (2125h)	Friction Compensation Gain Correction	Yes
Pn401 (2401h)	First Stage First Torque Reference Filter Time Constant	Yes
Pn408 (2408h)	Torque-Related Function Selections	Yes
Pn409 (2409h)	First Stage Notch Filter Frequency	Yes
Pn40A (240Ah)	First Stage Notch Filter Q Value	Yes
Pn40C (240Ch)	Second Stage Notch Filter Frequency	Yes
Pn40D (240Dh)	Second Stage Notch Filter Q Value	Yes
Pn140 (2140h)	Model Following Control-Related Selections	Yes
Pn141 (2141h)	Model Following Control Gain	Yes
Pn142 (2142h)	Model Following Control Gain Correction	Yes
Pn143 (2143h)	Model Following Control Bias in the Forward Direction	Yes
Pn144 (2144h)	Model Following Control Bias in the Reverse Direction	Yes
Pn145 (2145h)	Vibration Suppression 1 Frequency A	Yes
Pn146 (2146h)	Vibration Suppression 1 Frequency B	Yes
Pn147 (2147h)	Model Following Control Speed Feedforward Compensation	Yes
Pn160 (2160h)	Anti-Resonance Control-Related Selections	Yes
Pn161 (2161h)	Anti-Resonance Frequency	Yes
Pn163 (2163h)	Anti-Resonance Damping Gain	Yes

Yes: The parameter is automatically set.

No: The parameter is not automatically set, but the setting is read during execution.

9.8 Custom Tuning

This section describes custom tuning.

9.8.1 Outline

You can use custom tuning to manually adjust the servo during operation using a speed or position reference input from the host controller. You can use it to fine-tune adjustments that were made with autotuning.

The following items are adjusted automatically.

- Gains (e.g., speed loop gain and position loop gain)
- Filters (torque reference filter and notch filters)
- Friction compensation
- Anti-resonance control

Refer to the following section for details on the parameters that are adjusted.

 [9.8.7 Related Parameters](#) on page 9-49

There are two adjustment methods that you can use for custom tuning.

- **Tuning Mode 0 (Setting Servo Gains Giving Priority to Stability) or 1 (Setting Servo Gains Giving Priority to Good Response)**

These modes allow you to set stable control conditions for multiple servo gains by manipulating only one tuning level. Automatic setting of notch filters and anti-resonance control is provided if vibration is detected. Manual anti-resonance control adjustment is also possible during custom tuning.

- **Tuning Mode 2 (Setting Servo Gains Giving Priority to Position Control Applications) or 3 (Setting Servo Gains Giving Priority to Preventing Overshooting in Position Control Applications)**

Two tuning levels are manipulated to reduce positioning time even further and set multiple servo gains.

Model following control is used to reduce the positioning time. If vibration is detected, notch filters and anti-resonance control are automatically adjusted, and friction compensation is automatically set. Manual anti-resonance control adjustment and vibration suppression are also possible during custom tuning.

CAUTION

- Vibration or overshooting may occur during custom tuning. To ensure safety, make sure that you can perform an emergency stop at any time.



9.8.2 Preparations

Check the following settings before you execute custom tuning.

- The test without a motor function must be disabled (Pn00C = n.□□□0).
- The tuning-less function must be disabled (Pn170 = n.□□□0).
- If speed control is used, tuning mode 0 or 1 must be set.
- The parameters must not be write prohibited.

9.8.3 Applicable Tools

The following table lists the tools that you can use to perform custom tuning.

Tool	Fn No./Function Name	Operating Procedure Reference
Digital Operator	Fn203	 Σ -7-Series Digital Operator Operating Manual (Manual No.: SIEP S800001 33)
SigmaWin+	<i>Tuning – Tuning</i>	 9.8.4 Operating Procedure on page 9-42

9.8.4 Operating Procedure

Use the following procedure to perform custom tuning.

WARNING

- Before you execute custom tuning, check the information provided in the SigmaWin+ operating manual. Observe the following precautions.
 - Make sure that you can perform an emergency stop at any time. When custom tuning is started, several parameters will be overwritten with the recommended settings, which may greatly affect the response before and after execution. Make sure that you can perform an emergency stop at any time.
 - Set the moment of inertia correctly before you execute custom tuning. If the setting greatly differs from the actual moment of inertia, vibration may occur.
 - If you change the feedforward level, the new setting will not be used immediately. It will be used after positioning is completed.

1. Confirm that the moment of inertia ratio (Pn103) is set correctly.
2. Click the  Servo Drive Button in the workspace of the Main Window of the SigmaWin+.
3. Select **Tuning** in the Menu Dialog Box. The Tuning Dialog Box will be displayed. Click the **Cancel** Button to cancel tuning.
4. Click the **Execute** Button.

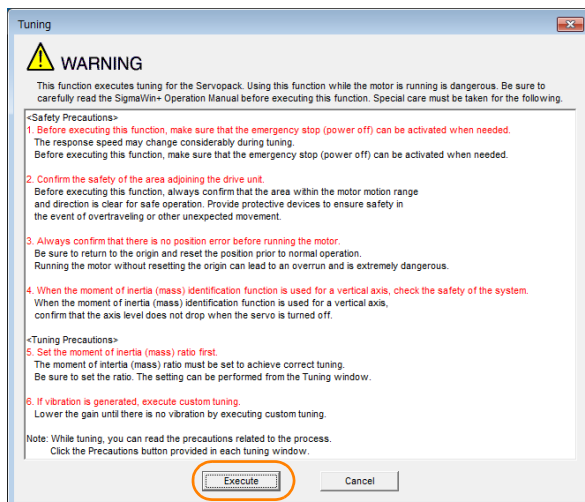

5. Click the **Advanced adjustment** Button.

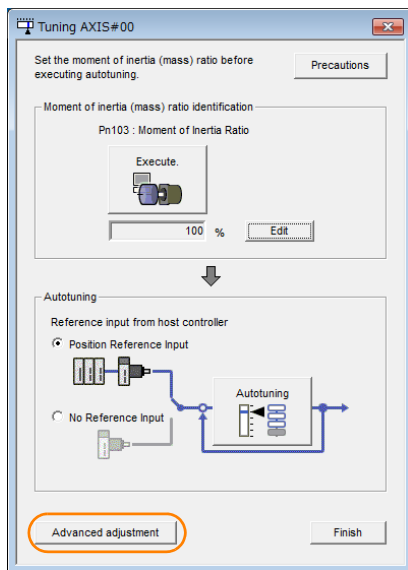

Information

When the following dialog box is displayed, click the **OK** Button and then confirm that the correct moment of inertia ratio is set in Pn103 (Moment of Inertia Ratio).

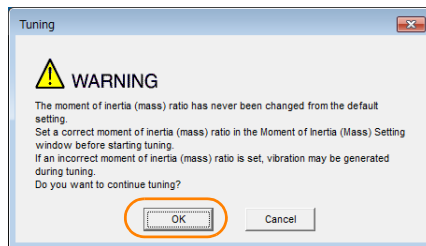

6. Click the **Custom tuning** Button.

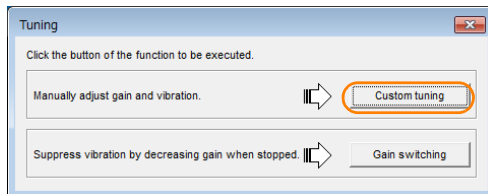

7. Set the Tuning mode Box and Mechanism selection Box, and then click the Next Button.

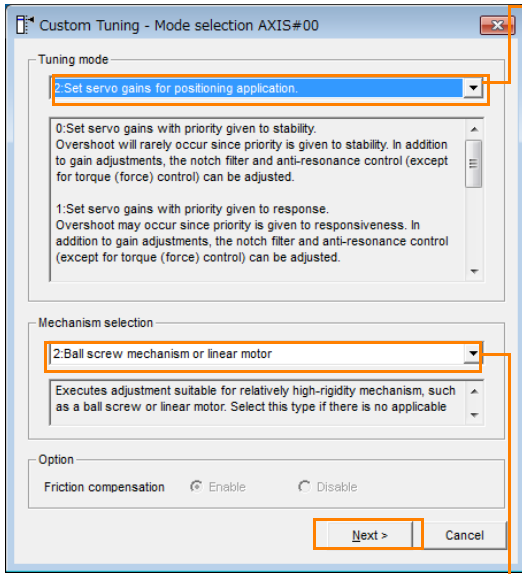

Tuning mode Box	
Mode Selection	Description
0: Set servo gains with priority given to stability.	This setting gives priority to stability and preventing overshooting. In addition to gain adjustment, notch filters and anti-resonance control (except during torque control) are automatically adjusted.
1: Set servo gains with priority given to response.	Overshooting may occur because priority is given to response. In addition to gain adjustment, notch filters and anti-resonance control (except during torque control) are automatically adjusted.
2: Set servo gains for positioning application.	Tuning is performed for positioning applications. In addition to gain adjustment, notch filters, anti-resonance control, and vibration suppression are adjusted.
3: Set servo gains especially to prevent overshooting during positioning application.	Tuning is performed for positioning applications with emphasis on eliminating overshooting. In addition to gain adjustment, notch filters, anti-resonance control, and vibration suppression are adjusted.

• Mechanism Selection Box

Select the type according to the machine element to drive. If there is noise or if the gain does not increase, better results may be obtained by changing the rigidity type. Select the type according to the following guidelines.

Mechanism Selection	Description
1: Belt mechanism	Tuning is performed for a mechanism with relatively low rigidity, e.g., a belt.
2: Ball screw mechanism or Linear motor	Tuning is performed for a mechanism with relatively high rigidity, e.g., a ball screw or Linear Servomotor. Use this setting if there is no other appropriate setting.
3: Rigid body system	Tuning is performed for a mechanism with high rigidity, e.g., a rigid body system.

Information The tuning modes that you can select depend on the SERVOPACK setting.

8. If the moment of inertia ratio is not set correctly, correct the setting and then click the Next Button.

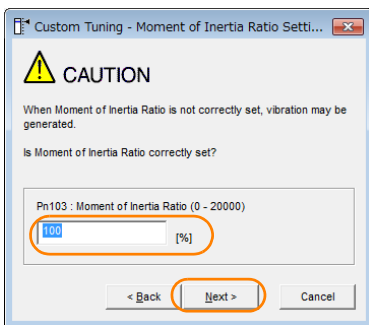

- Turn ON the servo, enter a reference from the host controller, and then click the **Start tuning Button**.

Tuning Mode 0 or 1

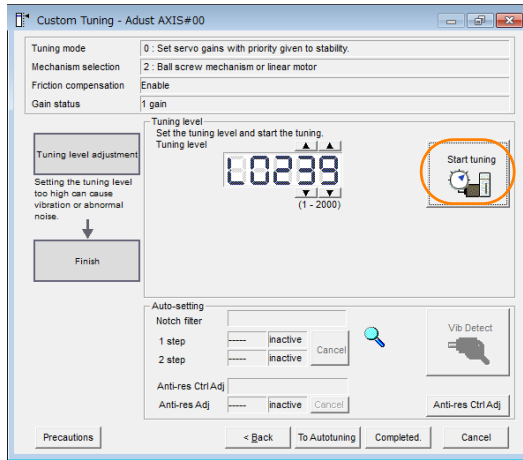

Tuning Mode 2 or 3

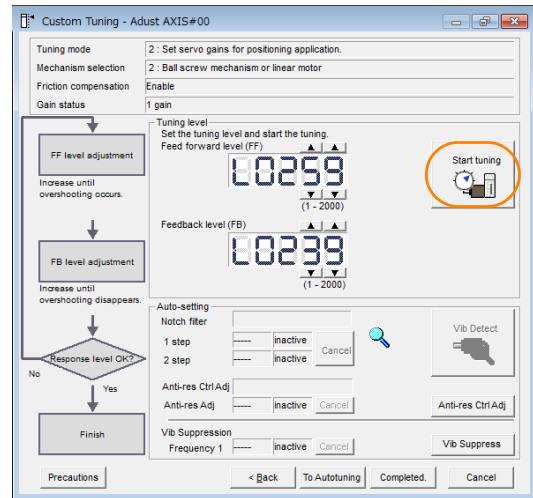

- Use the **▲** and **▼** Buttons to change the tuning level.

Click the **Back** Button during tuning to restore the setting to its original value. The tuning level will return to the value from before when custom tuning was started.

Tuning Mode 0 or 1

Increase the tuning level until overshooting occurs.

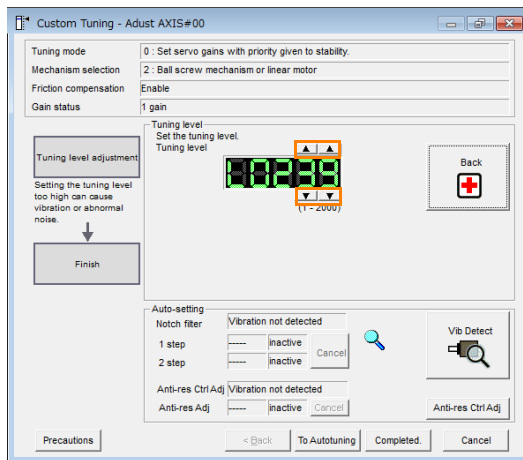

Tuning Mode 2 or 3

Increase the feedforward level until overshooting occurs and then increase the feedback level until overshooting is eliminated. Repeat these changes to make the adjustment.

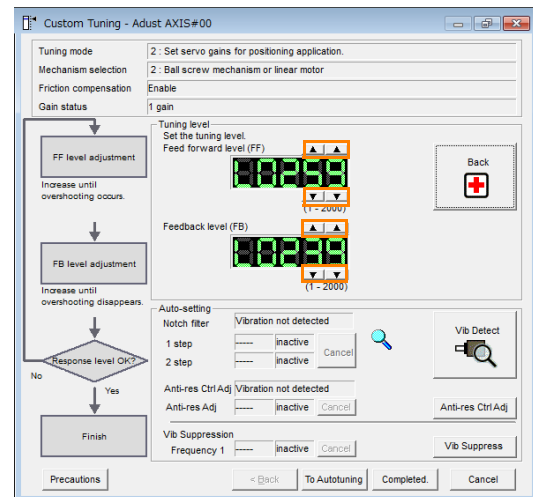

Information The new feedforward level will not be used until the positioning completed signal is output.

- You can set the functions to suppress vibration (notch filters, automatic anti-resonance setting, anti-resonance control adjustment, and autotuning with a host reference) as required.

Refer to the following section for details.

Vibration Suppression Functions on page 9-46

12. When tuning has been completed, click the **Completed Button.**

The values that were changed will be saved in the SERVOPACK and you will return to the Tuning Dialog Box.

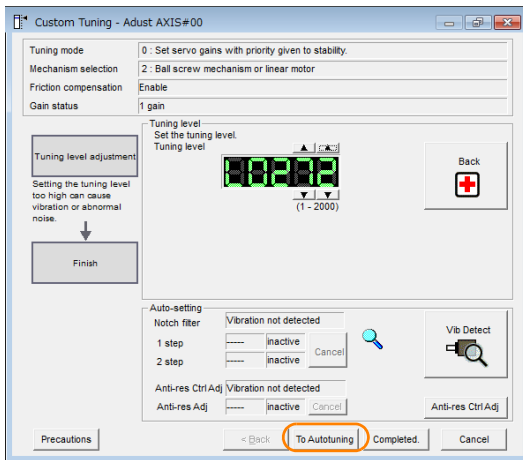

This concludes the procedure to set up custom tuning.

Vibration Suppression Functions

◆ Notch Filters and Automatic Anti-resonance Setting

If the vibration frequency that occurs when you increase the servo gains is at 1,000 Hz or higher, notch filters are effective to suppress vibration. If the vibration is between 100 Hz and 1,000 Hz, anti-resonance control is effective.

◆ Automatic Setting

To set vibration suppression automatically, use the parameters to enable notch filters and automatic anti-resonance control setting.

The notch filter frequency (stage 1 or 2) or anti-resonance control frequency that is effective for the vibration that was detected during tuning will be automatically set.

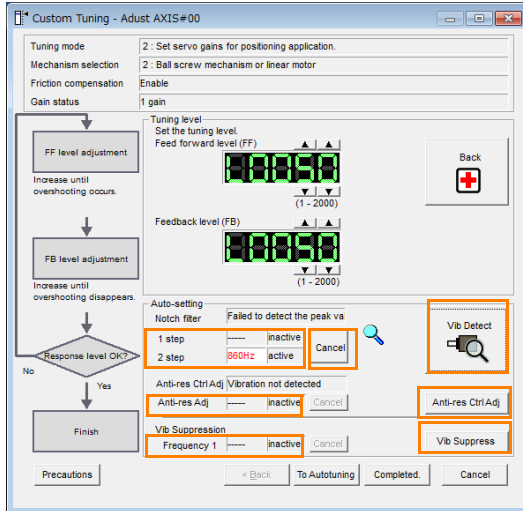

- **Auto-setting Cancel Buttons**

The automatically set notch filter frequencies or the anti-resonance control frequencies may not always suppress vibration. Click the **Cancel** Button to reset the notch filter frequencies or the anti-resonance control frequencies to the values from just before these frequencies were set automatically.

When they are reset, vibration detection will start again.

- **Vib Detect Button**

While the notch filter or anti-resonance control adjustment automatic setting function is enabled, you can click the **Vib Detect** Button to manually detect vibration. When you click the **Vib Detect** Button, the SERVOPACK will detect vibration at that time, and set the notch filter frequency (stage 1 or 2) or anti-resonance control frequency that is effective for the detected vibration. You can also perform manual vibration detection even when the SERVOPACK does not detect vibration.

- **Anti-res Ctrl Adj Button**

You can use the **Anti-res Ctrl Adj** Button to execute the anti-resonance control function if fine-tuning is required. Refer to the following section.

9.9 Anti-Resonance Control Adjustment on page 9-50

- **Vib Suppress Button**

Click the **Vib Suppress** Button to suppress low and transient vibration (oscillation) of approximately 1 Hz to 100 Hz that occurs during positioning. Refer to the following section.

9.10 Vibration Suppression on page 9-55

◆ Autotuning with a Host Reference

You can perform autotuning with a host reference. Refer to the following section for details.



9.7 Autotuning with a Host Reference on page 9-34

9.8.5 Automatically Adjusted Function Settings

You cannot use vibration suppression functions at the same time. Other automatic function settings are the same as for autotuning without a host reference. Refer to the following section.

 9.6.6 *Automatically Adjusted Function Settings* on page 9-31

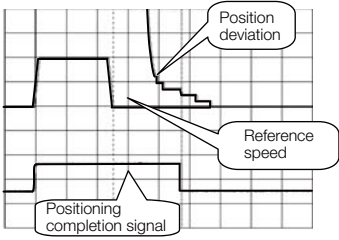
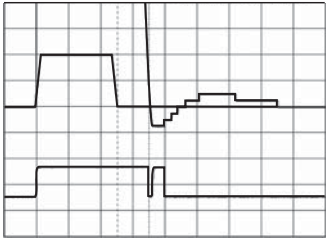
9.8.6 Tuning Example for Tuning Mode 2 or 3

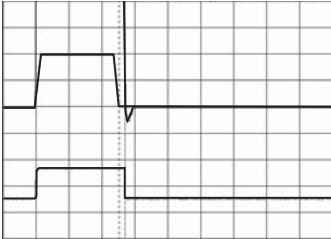
Step	Measurement Display Examples	Operation
1		<p>The positioning time is measured after the moment of inertia ratio (Pn103) is set correctly. Tuning is completed if the specifications are met. The tuning results are saved in the SERVOPACK.</p>
2		<p>The positioning time will be reduced if the feedforward level is increased. Tuning is completed if the specifications are met. The tuning results are saved in the SERVOPACK. If overshooting occurs before the specifications are met, proceed to step 3.</p>
3		<p>Overshooting will be reduced if the feedback level is increased. If the overshooting is eliminated, proceed to step 4.</p>
4		<p>The graph shows overshooting that occurred when the feedforward level was increased even more after step 3. In this state, overshooting occurs, but the positioning settling time is shorter. Tuning is completed if the specifications are met. The tuning results are saved in the SERVOPACK. If overshooting occurs before the specifications are met, repeat steps 3 and 4. If vibration occurs before the overshooting is eliminated, the vibration is suppressed with the notch filters and anti-resonance control.</p>
5	-	<p>The tuning results are saved in the SERVOPACK.</p>

9.8.7 Related Parameters

The following parameters are automatically adjusted or used as reference when you execute custom tuning.

Do not change the settings while custom tuning is being executed.

Parameter	Name	Automatic Changes
Pn100 (2100h)	Speed Loop Gain	Yes
Pn101 (2101h)	Speed Loop Integral Time Constant	Yes
Pn102 (2102h)	Position Loop Gain	Yes
Pn103 (2103h)	Moment of Inertia Ratio	No
Pn121 (2121h)	Friction Compensation Gain	Yes
Pn123 (2123h)	Friction Compensation Coefficient	Yes
Pn124 (2124h)	Friction Compensation Frequency Correction	No
Pn125 (2125h)	Friction Compensation Gain Correction	Yes
Pn401 (2401h)	First Stage First Torque Reference Filter Time Constant	Yes
Pn408 (2408h)	Torque-Related Function Selections	Yes
Pn409 (2409h)	First Stage Notch Filter Frequency	Yes
Pn40A (240Ah)	First Stage Notch Filter Q Value	Yes
Pn40C (240Ch)	Second Stage Notch Filter Frequency	Yes
Pn40D (240Dh)	Second Stage Notch Filter Q Value	Yes
Pn140 (2140h)	Model Following Control-Related Selections	Yes
Pn141 (2141h)	Model Following Control Gain	Yes
Pn142 (2142h)	Model Following Control Gain Correction	Yes
Pn143 (2143h)	Model Following Control Bias in the Forward Direction	Yes
Pn144 (2144h)	Model Following Control Bias in the Reverse Direction	Yes
Pn145 (2145h)	Vibration Suppression 1 Frequency A	No
Pn146 (2146h)	Vibration Suppression 1 Frequency B	No
Pn147 (2147h)	Model Following Control Speed Feedforward Compensation	Yes
Pn160 (2160h)	Anti-Resonance Control-Related Selections	Yes
Pn161 (2161h)	Anti-Resonance Frequency	Yes
Pn163 (2163h)	Anti-Resonance Damping Gain	Yes

Yes: The parameter is automatically set.

No: The parameter is not automatically set, but the setting is read during execution.

9.9 Anti-Resonance Control Adjustment

This section describes anti-resonance control.

9.9.1 Outline

Anti-resonance control increases the effectiveness of vibration suppression after custom tuning.

Anti-resonance control is effective for suppression of continuous vibration frequencies from 100 to 1,000 Hz that occur when the control gain is increased. Vibration can be eliminated by setting vibration frequencies through automatic detection or by manually setting them to adjust the damping gain. Input an operation reference and execute this anti-resonance control adjustment when there is vibration.

Anti-resonance control is automatically set by autotuning without a host reference or autotuning with a host reference. Use anti-resonance control adjustment only if fine-tuning is required or readjustment is required as a result of a failure to detect vibration.

Perform custom tuning if required to increase the response after performing anti-resonance control adjustment. If the control gain is increased, e.g., when custom tuning is performed, vibration may occur again. If that occurs, perform anti-resonance control adjustment again to fine-tune the parameters.



CAUTION

- Related parameters will be set automatically when anti-resonance control adjustment is executed. This may greatly affect the response before and after execution. Make sure that you can perform an emergency stop at any time.
- Before you execute anti-resonance control adjustment, set the correct moment of inertia ratio (Pn103). If the setting greatly differs from the actual moment of inertia ratio, normal control of the machine may not be possible, and vibration may occur.



Important

- Anti-resonance control adjustment detects vibration frequencies between 100 Hz and 1,000 Hz. If the vibration frequency is not within this range, use custom tuning with tuning mode 2 selected to automatically set a notch filter or use vibration suppression.
- Vibration reduction can be made more effective by increasing the anti-resonance damping gain (Pn163), but the vibration may become larger if the damping gain is too high. Increase the damping gain by approximately 0% to 200% in 10% increments while checking the effect on vibration. If vibration reduction is still insufficient at a gain of 200%, cancel the setting, and lower the control gain by using a different method, such as custom tuning.



9.9.2 Preparations

Check the following settings before you execute anti-resonance control adjustment.

- The tuning-less function must be disabled (Pn170 = n.□□□0).
- The test without a motor function must be disabled (Pn00C = n.□□□0).
- The control method must not be set to torque control.
- The parameters must not be write prohibited.

9.9.3 Applicable Tools

The following table lists the tools that you can use to perform anti-resonance control adjustment.

Tool	Fn No./Function Name	Operating Procedure Reference
Digital Operator	Fn204	 Σ -7-Series Digital Operator Operating Manual (Manual No.: SIEP S800001 33)
SigmaWin+	Tuning - Tuning	 9.9.4 Operating Procedure on page 9-51

9.9.4 Operating Procedure

To execute anti-resonance control adjustment, an operation reference is input, and the adjustment is executed while vibration is occurring.

The following methods can be used to execute anti-resonance control adjustment.

- To automatically detect the vibration frequency
- To manually set the vibration frequency

Use the following procedure.

CAUTION

- Before you execute anti-resonance control adjustment, check the information provided in the SigmaWin+ operating manual. Observe the following precautions.
 - Make sure that you can perform an emergency stop at any time. Parameters will be set automatically when anti-resonance control adjustment is executed. This may greatly affect the response before and after execution. Make sure that you can perform an emergency stop (to turn OFF the power supply) at any time.
 - Set the moment of inertia correctly before you execute anti-resonance control adjustment. If the setting greatly differs from the actual moment of inertia, effective vibration reduction may not be possible.
 - If you have already performed anti-resonance control adjustment and then you change the frequency, the current anti-resonance control effect may be lost. Caution is particularly required when automatically detecting the vibration frequency.
 - If effective vibration reduction is not achieved even after you execute anti-resonance control adjustment, cancel the function and lower the control gain by using a different method, such as custom tuning.
 - Perform custom tuning separately if required to increase the response after performing anti-resonance control adjustment. If the servo gain is increased, e.g., when custom tuning is performed, vibration may occur again. If that occurs, perform anti-resonance control adjustment again to fine-tune the parameters.

1. Perform steps 1 to 7 of the procedure for custom tuning. Refer to the following section for details.

 9.8.4 Operating Procedure on page 9-42

2. Click the Anti-res Ctrl Adj Button.

The rest of the procedure depends on whether you know the vibration frequency.

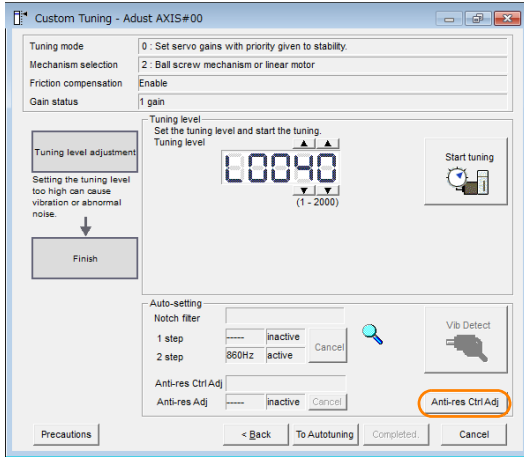

3. If you do not know the vibration frequency, click the Auto Detect Button. If you know the vibration frequency, click the Manual Set Button.

To Automatically Detect the Vibration Frequency

The frequency will be set.

To Manually Set the Vibration Frequency

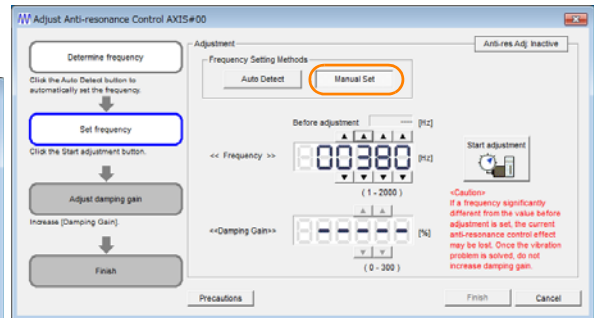
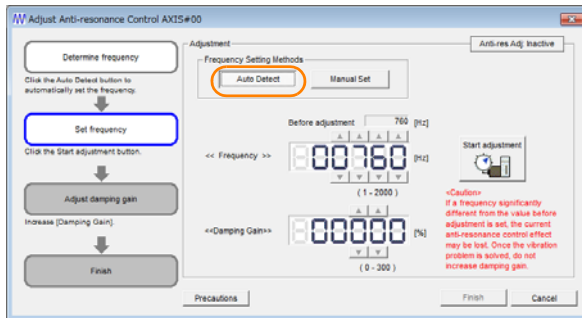

4. Click the Start adjustment Button.

5. Use the ▲ and ▼ Buttons in the Adjustment Area to change the settings.

Click the **Reset** Button during tuning to restore the setting to its original value. The tuning level will return to the value from before when custom tuning was started.

To Automatically Detect the Vibration Frequency

Change the setting of the damping gain.

To Manually Set the Vibration Frequency

Change the settings of the frequency and damping gain.

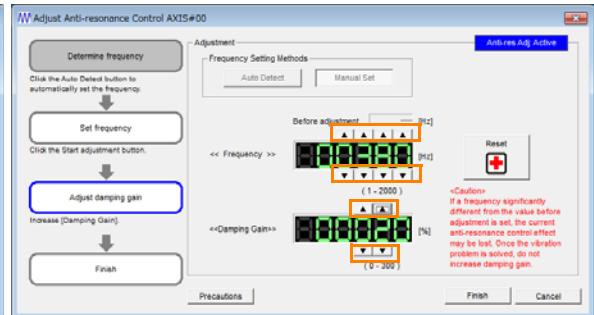

6. When the adjustment has been completed, click the **Finish** Button.

The values that were changed will be saved in the SERVOPACK and you will return to the Tuning Dialog Box.



This concludes the procedure to set up anti-resonance control.

9.9.5 Related Parameters

The following parameters are automatically adjusted or used as reference when you execute anti-resonance control adjustment.

Do not change the settings while anti-resonance control adjustment is being executed.

Parameter	Name	Automatic Changes
Pn160 (2160h)	Anti-Resonance Control-Related Selections	Yes
Pn161 (2161h)	Anti-Resonance Frequency	Yes
Pn162 (2162h)	Anti-Resonance Gain Correction	No
Pn163 (2163h)	Anti-Resonance Damping Gain	Yes
Pn164 (2164h)	Anti-Resonance Filter Time Constant 1 Correction	No
Pn165 (2165h)	Anti-Resonance Filter Time Constant 2 Correction	No

Yes: The parameter is automatically set.

No: The parameter is not automatically set, but the setting is read during execution.

9.9.6 Suppressing Different Vibration Frequencies with Anti-resonance Control

When you use anti-resonance control and increase the control gain, for some mechanism, vibration can occur at a higher frequency than the frequency for which vibration was suppressed. If this occurs, you can suppress vibration for more than one frequency by adjusting Pn166 (Anti-Resonance Damping Gain 2).

- Information** Guidelines for Vibration That Can Be Suppressed
- Anti-resonance frequency (Pn161): f_a [Hz], Another vibration frequency that occurs when the control gain is increased: f_b [Hz]
- Vibration frequencies: 100 Hz to 1,000 Hz
 - Range of different vibration frequencies: $1 < (f_b/f_a) \leq 3$ to 4

Required Parameter Settings

The following parameter settings are required to use anti-resonance control for more than one vibration frequency.

Parameter		Description	When Enabled	Classification
Pn160 (2160h)	n.□□□0 (default setting)	Do not use anti-resonance control.	After restart	Setup
	n.□□□1	Use anti-resonance control.		
Pn161 (2161h)	Anti-Resonance Frequency			[Speed] [Position] [Torque]
	Setting Range	Setting Unit	Default Setting	When Enabled
	10 to 20,000	0.1 Hz	1000	Immediately
Pn162 (2162h)	Anti-Resonance Gain Correction			[Speed] [Position] [Torque]
	Setting Range	Setting Unit	Default Setting	When Enabled
	1 to 1,000	1%	100	Immediately
Pn163 (2163h)	Anti-Resonance Damping Gain			[Speed] [Position] [Torque]
	Setting Range	Setting Unit	Default Setting	When Enabled
	0 to 300	1%	0	Immediately
Pn164 (2164h)	Anti-Resonance Filter Time Constant 1 Correction			[Speed] [Position] [Torque]
	Setting Range	Setting Unit	Default Setting	When Enabled
	-1,000 to 1,000	0.01 ms	0	Immediately
Pn165 (2165h)	Anti-Resonance Filter Time Constant 2 Correction			[Speed] [Position] [Torque]
	Setting Range	Setting Unit	Default Setting	When Enabled
	-1,000 to 1,000	0.01 ms	0	Immediately
Pn166 (2166h)	Anti-Resonance Damping Gain 2			[Speed] [Position] [Torque]
	Setting Range	Setting Unit	Default Setting	When Enabled
	0 to 1,000	1%	0	Immediately

Adjustment Procedure for Suppressing Different Vibration Frequencies with Anti-resonance Control

Use the following procedure to make adjustments to suppress different vibration frequencies with anti-resonance control.

Step	Operation
1	Use the gain adjustment and anti-resonance control. Refer to the following section for details.  9.9.4 Operating Procedure on page 9-51
2	If there is vibration at a higher frequency than the vibration suppressed with anti-resonance control in step 1, adjust Pn166 (Anti-Resonance Damping Gain 2).
3	Adjust Pn166 (Anti-Resonance Damping Gain 2) while checking to see if vibration reduction is effective. To adjust Pn166 (Anti-Resonance Damping Gain 2), increase the setting by 10% at a time starting from the value that resulted in Pn163 (Anti-Resonance Damping Gain) from the adjustment in step 1.
4	If the vibration disappears, the adjustment is completed. However, if the vibration does not disappear even when you adjust Pn166 (Anti-Resonance Damping Gain 2), reduce the tuning level or feedback level until vibration does not occur.

9.10 Vibration Suppression

This section describes vibration suppression.

9.10.1 Outline

You can use vibration suppression to suppress transient vibration at a low frequency from 1 Hz to 100 Hz, which is generated mainly when the machine vibrates during positioning. This is effective for vibration frequencies for which notch filters and anti-resonance control adjustment are not effective.

Vibration suppression is automatically set by autotuning without a host reference or autotuning with a host reference. Use vibration suppression only if fine-tuning is required or readjustment is required as a result of a failure to detect vibration. To execute vibration suppression, input an operation reference and execute the function when there is vibration.

Perform custom tuning if required to increase the response after performing vibration suppression.

CAUTION

- Related parameters will be set automatically when vibration suppression is executed. This may greatly affect the response before and after execution. Make sure that you can perform an emergency stop at any time.
- Before you execute vibration suppression, set the correct moment of inertia ratio (Pn103) with autotuning without a host reference or another method. If the setting greatly differs from the actual moment of inertia ratio, normal control of the machine may not be possible, and vibration may occur.



Important

- Vibration suppression detects vibration frequencies between 1 Hz and 100 Hz.
- Frequency detection will not be performed if there is no vibration in the position deviation or if the vibration frequency is outside the range of detectable frequencies. If that is a problem, use a device such as a displacement meter or vibration sensor to measure the vibration frequency.
- If an automatically detected vibration frequency is not suppressed, the actual frequency and the detected frequency may be different. Fine-tune the detected frequency if necessary.

Items That Influence Performance

If continuous vibration occurs while the Servomotor is stopping, vibration suppression cannot be used to suppress the vibration effectively. In this case, use anti-resonance control adjustment or custom tuning.

Detection of Vibration Frequencies

Frequency detection may not be possible if vibration does not appear in the position deviation or the vibration that results from the position deviation is too small. You can adjust the detection sensitivity by changing the setting of the residual vibration detection width (Pn560), which is set as a percentage of the positioning completed width (Pn522). Perform the detection of vibration frequencies again after adjusting the setting of Pn560.

Pn560 (2560h)	Residual Vibration Detection Width				Position
	Setting Range	Setting Unit	Default Setting	When Enabled	Classification
	1 to 3,000	0.1%	400	Immediately	Setup

Note: As a guideline, change the setting 10% at a time. If the setting of this parameter is lowered, the detection sensitivity will be increased. Vibration may not be detected accurately if the setting is too small.

Information

The vibration frequencies that are automatically detected may vary somewhat with each positioning operation. Perform positioning several times and make adjustments while checking the effect of vibration suppression.

9.10.2 Preparations

Check the following settings before you execute vibration suppression.

- Position control must be used.
- The tuning-less function must be disabled (Pn170 = n.□□□0).
- The test without a motor function must be disabled (Pn00C = n.□□□0).
- The parameters must not be write prohibited.

9.10.3 Applicable Tools

The following table lists the tools that you can use to perform vibration suppression.

Tool	Fn No./Function Name	Operating Procedure Reference
Digital Operator	Fn205	Σ-7-Series Digital Operator Operating Manual (Manual No.: SIEP S800001 33)
SigmaWin+	<i>Tuning - Tuning</i>	9.10.4 Operating Procedure on page 9-56

9.10.4 Operating Procedure

Use the following procedure to perform vibration suppression.

1. Perform steps 1 to 7 of the procedure for custom tuning. Refer to the following section for details.

 9.8.4 Operating Procedure on page 9-42

2. Click the **Vib Suppress** Button.

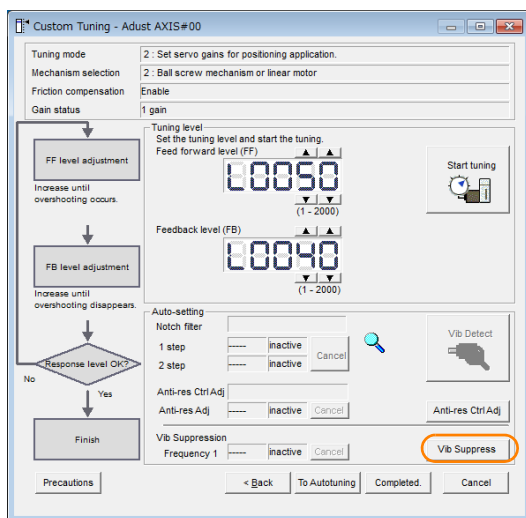

- Click the **Import Button** or click **▲** and **▼** Button to manually adjust the set frequency. When you click the **Import Button**, the residual vibration frequency in the motor is read as the set frequency. (The frequency can be read only when the residual vibration frequency is between 1.0 and 100.0.)



Important

Frequency detection will not be performed if there is no vibration or if the vibration frequency is outside the range of detectable frequencies. If a vibration frequency is not detected, provide a means of measuring the vibration frequency.

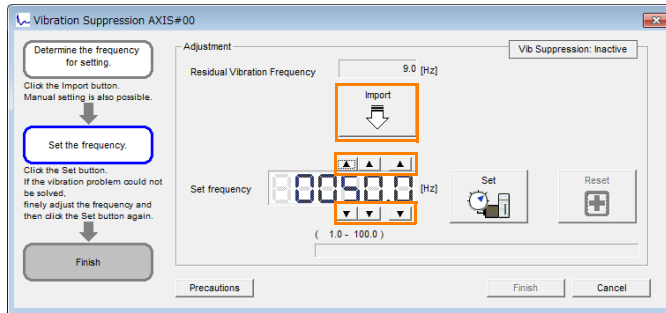

- Click the **Set Button**.



Important

No settings related to vibration suppression are changed during operation. If the Servomotor does not stop within approximately 10 seconds after changing the setting, an update timeout will occur. The setting will be automatically returned to the previous value.

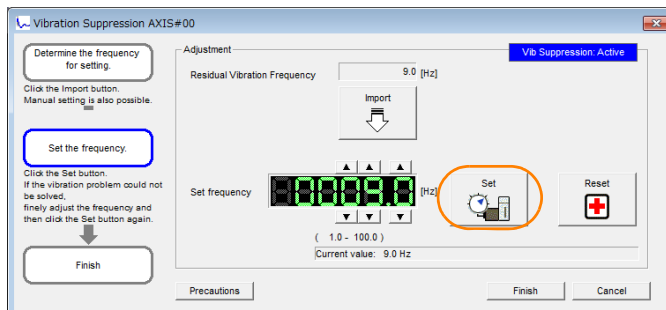

If the vibration is not eliminated, use the **▲** and **▼** Buttons for the set frequency to fine-tune the value and click the **Set Button** again.

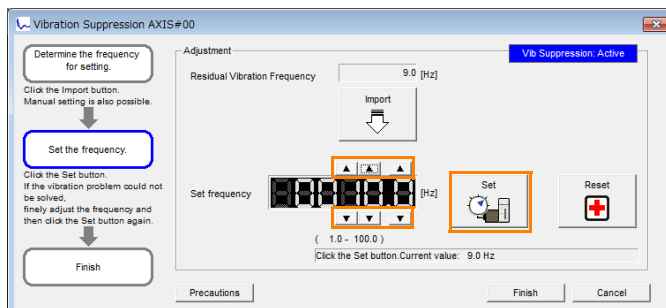

Click the **Reset Button** during adjustment to restore the setting to its original value. The status from before when adjustment was started will be restored.

5. When the vibration has been eliminated, click the Finish Button.

The updated value will be saved in the SERVOPACK.



Vibration suppression will be enabled in step 5. The motor response, however, will change when the Servomotor comes to a stop with no reference input.

This concludes the procedure to set up vibration suppression.

9.10.5 Setting Combined Functions

You can also use the feedforward function when you execute vibration suppression.

In the default settings, feedforward (Pn109), the speed feedforward input (VFF), and the torque feedforward input (TFF) are disabled.

To use the speed feedforward input (VFF), the torque feedforward input (TFF), and model following control from the host controller in the system, set Pn140 to n.1□□□ (Use model following control and speed/torque feedforward together).

Parameter		Function	When Enabled	Classification
Pn140 (2140h)	n.0□□□ (default setting)	Do not use model following control and speed/torque feedforward together.	Immediately	Tuning
	n.1□□□	Use model following control and speed/torque feedforward together.		



When model following control is used with the feedforward function, it is used to make optimum feedforward settings in the SERVOPACK. Therefore, model following control is not normally used together with either the speed feedforward input (VFF) or torque feedforward input (TFF) from the host controller. However, model following control can be used with the speed feedforward input (VFF) or torque feedforward input (TFF) if required. An unsuitable feedforward input may result in overshooting.

9.10.6 Related Parameters

The following parameters are automatically adjusted or used as reference when you execute vibration suppression.

Do not change the settings while vibration suppression is being executed.

Parameter	Name	Automatic Changes
Pn140 (2140h)	Model Following Control-Related Selections	Yes
Pn141 (2141h)	Model Following Control Gain	Yes
Pn142 (2142h)	Model Following Control Correction	No
Pn143 (2143h)	Model Following Control Bias in the Forward Direction	No
Pn144 (2144h)	Model Following Control Bias in the Reverse Direction	No
Pn145 (2145h)	Vibration Suppression 1 Frequency A	Yes
Pn146 (2146h)	Vibration Suppression 1 Frequency B	Yes
Pn147 (2147h)	Model Following Control Speed Feedforward Compensation	No
Pn14A (214Ah)	Vibration Suppression 2 Frequency	No
Pn14B (214Bh)	Vibration Suppression 2 Correction	No

Yes: The parameter is automatically set.

No: The parameter is not automatically set, but the setting is read during execution.

9.11 Speed Ripple Compensation

This section describes speed ripple compensation.

9.11.1 Outline

Speed ripple compensation reduces the amount of ripple in the motor speed due to torque ripple or cogging torque. You can enable speed ripple compensation to achieve smoother operation. To enable it, you must set up ripple compensation on the SigmaWin+.

WARNING

- Speed ripple compensation requires operating the motor and therefore presents hazards. Observe the following precaution.
Confirm safety around moving parts.
This function involves automatic operation. Make sure that you can perform an emergency stop (to turn OFF the power supply) at any time.



Important

- Execute speed ripple compensation only after adjusting the gains.
- Reset speed ripple compensation after you replace the Servomotor or SERVOPACK.
 - Execute speed ripple compensation after jogging to a position that ensures a suitable range of motion.

9.11.2 Setting Up Speed Ripple Compensation

Restrictions

The following restrictions apply to the setup for speed ripple compensation.

◆ Systems for Which Execution Cannot Be Performed

There are no restrictions.

◆ Systems for Which Adjustments Cannot Be Made Accurately

Systems for which there is not a suitable range of motion

◆ Preparations

Check the following items before you set up speed ripple compensation.

- The main circuit power supply must be ON.
- The servo must be OFF.
- There must be no alarms or warnings.
- There must be no hard wire base block (HWBB).
- The parameters must not be write prohibited.

Applicable Tools

The following table lists the tools that you can use to set up speed ripple compensation.

Tool	Fn No./Function Name	Reference
Digital Operator	You cannot set up speed ripple compensation from the Digital Operator.	
SigmaWin+	Diagnostic – Ripple Compensation	Operating Procedure on page 9-60

Operating Procedure

Use the following procedure to set up speed ripple compensation.

1. Click the Servo Drive Button in the workspace of the Main Window of the SigmaWin+.
2. Select **Ripple Compensation** in the Menu Dialog Box.
The Ripple Compensation Dialog Box will be displayed.
3. Click the **OK** Button.

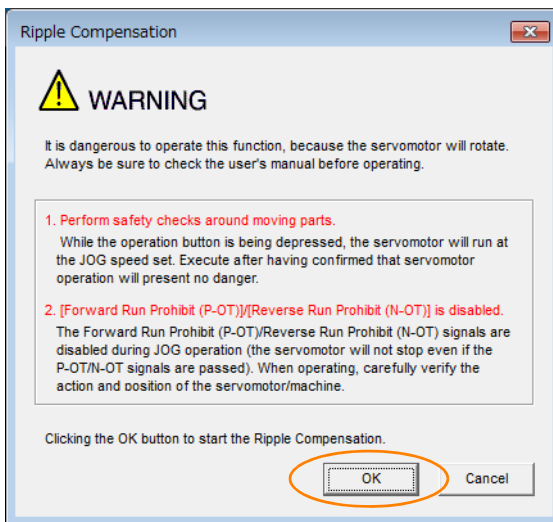

- Information**
1. Click the **Cancel** Button to cancel ripple compensation. The Main Window will return.
 2. If write protection is set, the following dialog box will be displayed.

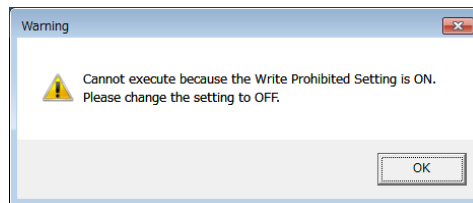

Click the **OK** Button to cancel write prohibition.

4. Click the Edit Button.

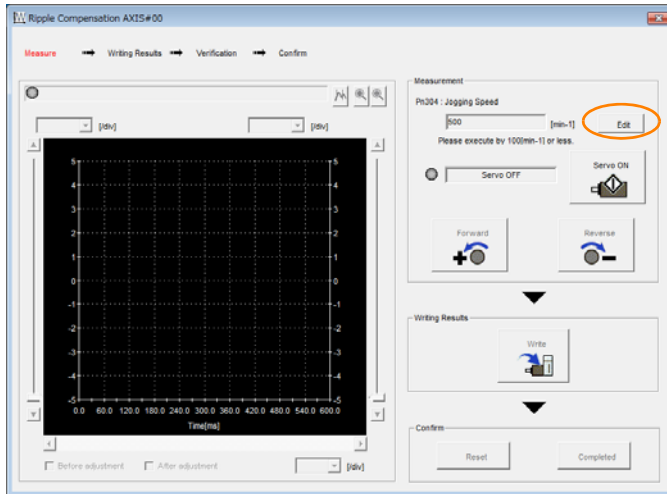

5. Enter the jogging speed in the Input Value Box and click the OK Button.

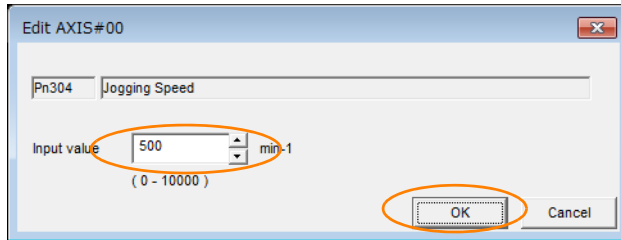

6. Click the Servo ON Button.

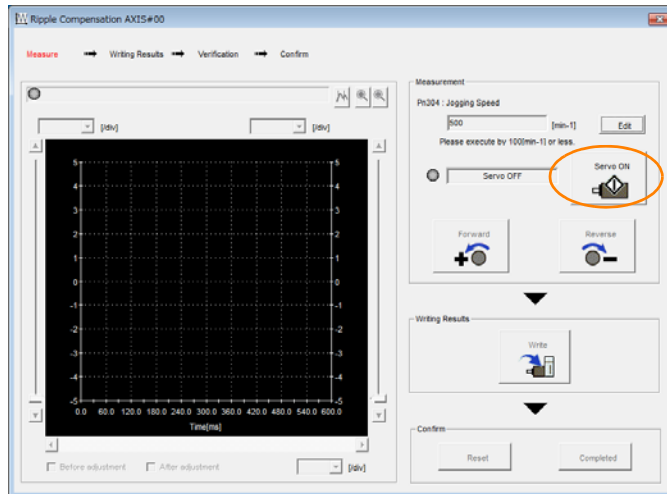

7. Click the **Forward Button** or the **Reverse Button**.

Measurement operation is started.

The Servomotor shaft will rotate at the preset jogging speed while you hold down the **Forward** or **Reverse** Button and the speed ripple will be measured.

The feedback speed and torque reference graph will be displayed in the Ripple Compensation Dialog Box during jogging.

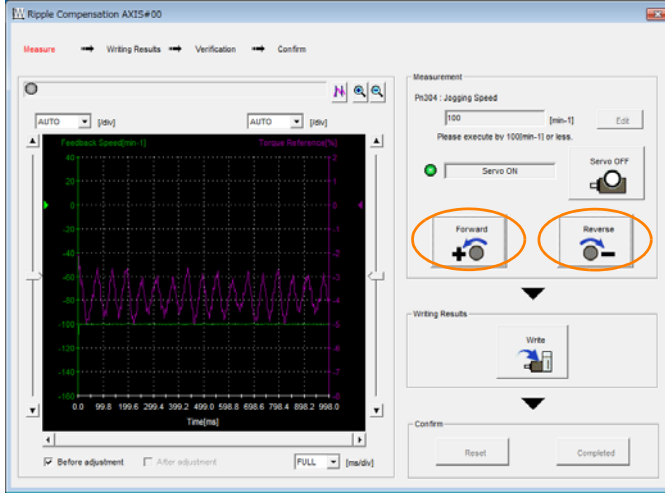

Important

If the measurement time (i.e., the jogging time) for the speed ripple is too short, speed ripple measurement will not be completed. The following dialog box will be displayed if speed ripple measurement was not completed.

Click the **OK** Button and repeat the measurement.

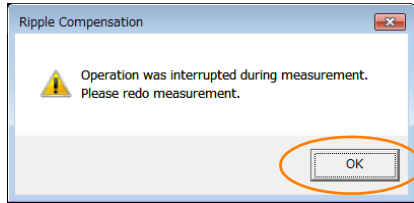

8. After speed ripple measurement has been completed, click the **Write Button**.

The ripple compensation value will be written to the SERVOPACK.

9. After writing has been completed, click the **OK** Button.

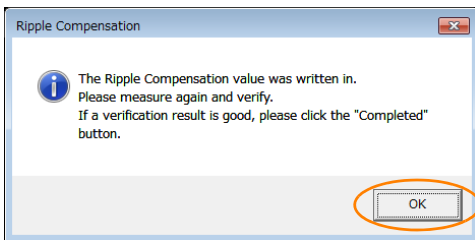

10. Click the Forward Button or the Reverse Button.

Verification operation is started.

The Servomotor shaft will rotate at the preset jogging speed while you hold down the **Forward** or **Reverse** Button.

The waveform with speed ripple compensation applied to it will be displayed.

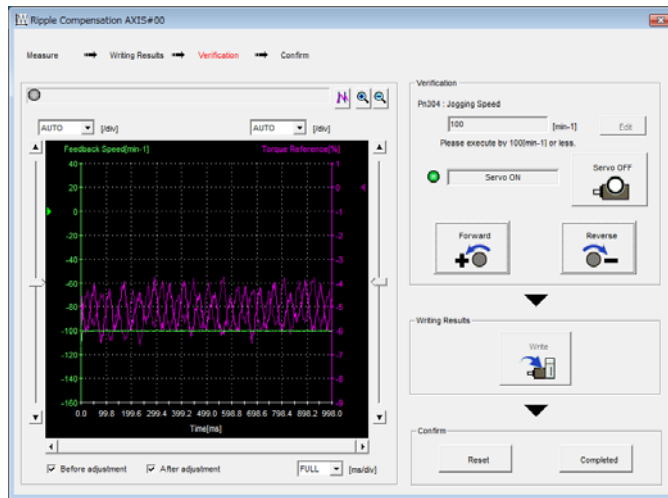

11. If the verification results are OK, click the Finish Button.

Information To discard the setup results, click the **Reset** Button.

This concludes the setup for speed ripple compensation.

9.11.3 Setting Parameters

The function is enabled when you perform the operating procedure on *Operating Procedure* on page 9-60. To cancel speed ripple compensation, use Pn423 = n.□□□0 (Disable speed ripple compensation) to disable it.

Parameter	Description	When Enabled	Classification
Pn423 (2423h)	n.□□□0 (default setting)	Immediately	Setup
	n.□□□1		

If you enable speed ripple compensation, a compensation reference will be applied to reduce ripple even when stopped at a 0 speed reference. In speed control mode, this may result in the motor moving slightly. To prevent this, set Pn423 = n.□X□□ (Speed Ripple Compensation Selections) and Pn427 or Pn49F (Speed Ripple Compensation Enable Speed).

Parameter	Description	When Enabled	Classification
Pn423 (2423h)	n.□0□□ (default setting)	After restart	Setup
	n.□1□□		

• For Rotary Servomotors

Pn427 (2427h)	Speed Ripple Compensation Enable Speed				
	Setting Range	Setting Unit	Default Setting	When Enabled	Classification
	0 to 10,000	1 min ⁻¹	0	Immediately	Tuning

• For Linear Servomotors

Pn49F (249Fh)	Speed Ripple Compensation Enable Speed				
	Setting Range	Setting Unit	Default Setting	When Enabled	Classification
	0 to 10,000	1 mm/s	0	Immediately	Tuning

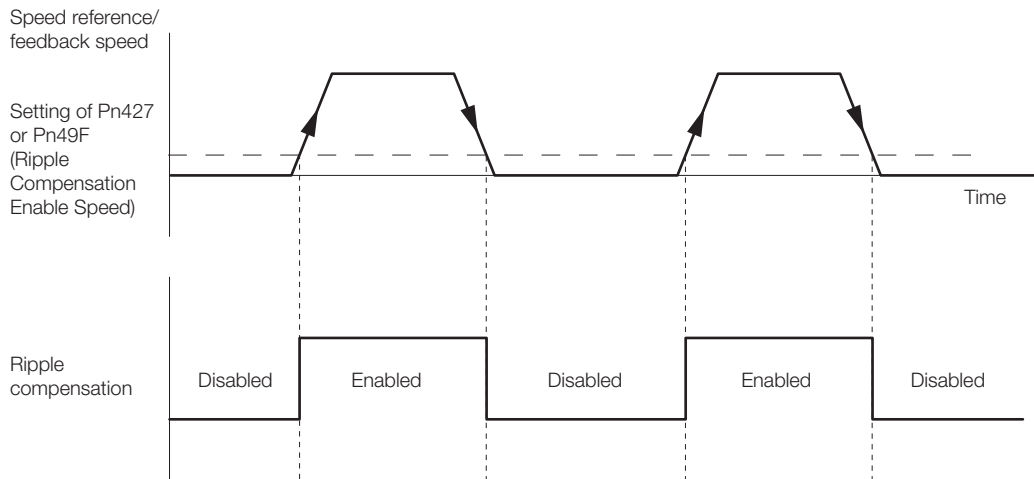

Speed Ripple Compensation Warnings

The speed ripple compensation value is specific to each Servomotor. If you replace the Servomotor while speed ripple compensation is enabled, an A.942 warning (Speed Ripple Compensation Information Disagreement) will occur to warn you.

You can use any of the following methods to clear A.942.

- Reset the speed ripple compensation value on the SigmaWin+.
- Disable speed ripple compensation (Pn423 = n.□□□0).
- Disable detection of A.942 (Pn423 = n.□□1□).

Parameter		Description	When Enabled	Classification
Pn423 (2423h)	n.□□0□ (default setting)	Detect A.942 alarms.	After restart	Setup
	n.□□1□	Do not detect A.942 alarms.		

9.12 Additional Adjustment Functions

This section describes the functions that you can use to make adjustments after you perform autotuning without a host reference, autotuning with a host reference, and custom tuning.

Function	Applicable Control Methods	Reference
Gain Switching	Position control, speed control, or torque control*	page 9-65
Friction Compensation	Position control or speed control	page 9-68
Current Control Mode Selection	Position control, speed control, or torque control	page 9-70
Current Gain Level Setting	Position control or speed control	page 9-71
Speed Detection Method Selection	Position control, speed control, or torque control	page 9-71
Backlash Compensation	Position Control	page 9-72

* Automatic gain switching is enabled only for position control.

9.12.1 Gain Switching

You can use gain switching to shorten the positioning time by increasing the gains during positioning and suppressing vibration by decreasing the gains while stopping.

Parameter	Function	When Enabled	Classification
Pn139 (2139h)	n.□□□0 (default setting)	Immediately	Tuning
	n.□□□2		

Note: Pn139 = n.□□□1 is a reserved setting. Do not use this setting.

Refer to the following section for gain switching combinations.

 [Gain Switching Combinations](#) on page 9-65

Gain Switching Combinations

Selected Gains	Speed Loop Gain	Speed Loop Integral Time Constant	Position Loop Gain	Torque Reference Filter	Friction Compensation Gain
Gain Settings 1	Speed Loop Gain (Pn100)	Speed Loop Integral Time Constant (Pn101)	Position Loop Gain (Pn102)	First Stage First Torque Reference Filter Time Constant (Pn401)	Friction Compensation Gain (Pn121)
Gain Settings 2	Second Speed Loop Gain (Pn104)	Second Speed Loop Integral Time Constant (Pn105)	Second Position Loop Gain (Pn106)	First Stage Second Torque Reference Filter Time Constant (Pn412)	Second Friction Compensation Gain (Pn122)

Note: Automatic gain switching is not supported for Model Following Control Gain and Model Following Control Correction.

Automatic Gain Switching

Automatic gain switching is enabled only for position control. The switching conditions are specified by using the following settings.

Parameter	Switching Condition	Selected Gains	Switching Waiting Time	Switching Time
Pn139 (2139h)	n.□□□2	Gain settings 1 to gain settings 2	Gain Switching Waiting Time 1 Pn135	Gain Switching Time 1 Pn131
		Gain settings 2 to gain settings 1	Gain Switching Waiting Time 2 Pn136	Gain Switching Time 2 Pn132

Select one of the following settings for switching condition A.

Parameter	Position Control Gain Switching Condition A	For Control Methods Other Than Position Control (No Switching)	When Enabled	Classification	
Pn139 (2139h)	n.□□0□ (default setting)	/COIN (Positioning Completion) signal ON	Gain settings 1 used.	Immediately	Tuning
	n.□□1□	/COIN (Positioning Completion) signal OFF	Gain settings 2 used.		
	n.□□2□	/NEAR (Near) signal ON	Gain settings 1 used.		
	n.□□3□	/NEAR (Near) signal OFF	Gain settings 2 used.		
	n.□□4□	Position reference filter output is 0 and position reference input is OFF.	Gain settings 1 used.		
	n.□□5□	Position reference input is ON.	Gain settings 2 used.		

Automatic Switching Pattern 1 (Pn139 = n.□□□2)

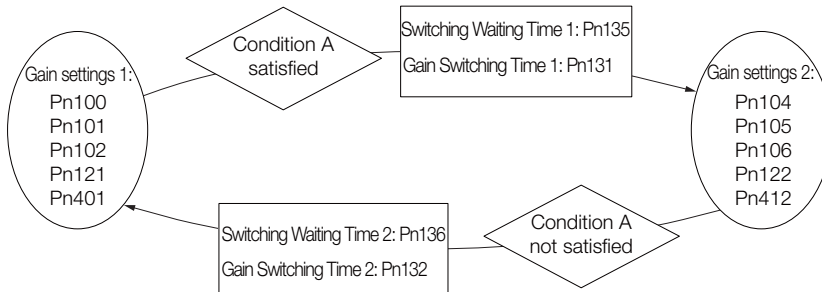

◆ Relationship between the Waiting Times and Switching Times for Gain Switching

In this example, an ON /COIN (Positioning Completion) signal is set as condition A for automatic gain switching. The position loop gain is changed from the value in Pn102 (Position Loop Gain) to the value in Pn106 (Second Position Loop Gain). When the /COIN signal turns ON, the switching operation begins after the waiting time (Pn135). The switching operation changes the position loop gain linearly from the gain set in Pn102 to the gain set in Pn106 over the switching time (Pn131).

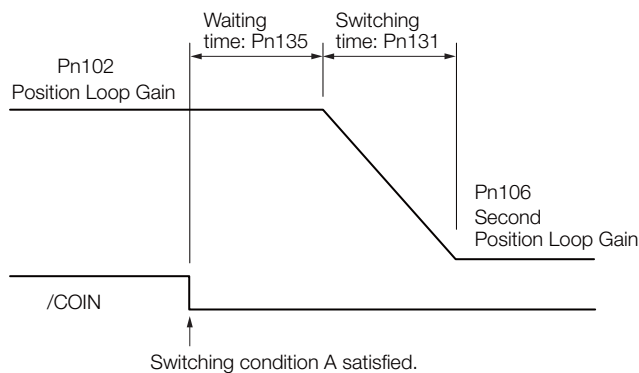

Information You can use gain switching for either PI control or I-P control (Pn10B = n.□□0□ or □□1□).

Related Parameters

Pn100 (2100h)	Speed Loop Gain [Speed] [Position]				
	Setting Range	Setting Unit	Default Setting	When Enabled	Classification
	10 to 20,000	0.1 Hz	400	Immediately	Tuning
Pn101 (2101h)	Speed Loop Integral Time Constant [Speed] [Position]				
	Setting Range	Setting Unit	Default Setting	When Enabled	Classification
	15 to 51,200	0.01 ms	2,000	Immediately	Tuning
Pn102 (2102h)	Position Loop Gain [Position]				
	Setting Range	Setting Unit	Default Setting	When Enabled	Classification
	10 to 20,000	0.1/s	400	Immediately	Tuning
Pn401 (2401h)	First Stage First Torque Reference Filter Time Constant [Speed] [Position] [Torque]				
	Setting Range	Setting Unit	Default Setting	When Enabled	Classification
	0 to 65,535	0.01 ms	100	Immediately	Tuning
Pn121 (2121h)	Friction Compensation Gain [Speed] [Position]				
	Setting Range	Setting Unit	Default Setting	When Enabled	Classification
	10 to 1,000	1%	100	Immediately	Tuning
Pn104 (2104h)	Second Speed Loop Gain [Speed] [Position]				
	Setting Range	Setting Unit	Default Setting	When Enabled	Classification
	10 to 20,000	0.1 Hz	400	Immediately	Tuning
Pn105 (2105h)	Second Speed Loop Integral Time Constant [Speed] [Position]				
	Setting Range	Setting Unit	Default Setting	When Enabled	Classification
	15 to 51,200	0.01 ms	2,000	Immediately	Tuning
Pn106 (2106h)	Second Position Loop Gain [Position]				
	Setting Range	Setting Unit	Default Setting	When Enabled	Classification
	10 to 20,000	0.1/s	400	Immediately	Tuning
Pn412 (2412h)	First Stage Second Torque Reference Filter Time Constant [Speed] [Position] [Torque]				
	Setting Range	Setting Unit	Default Setting	When Enabled	Classification
	0 to 65,535	0.01 ms	100	Immediately	Tuning
Pn122 (2122h)	Second Friction Compensation Gain [Speed] [Position]				
	Setting Range	Setting Unit	Default Setting	When Enabled	Classification
	10 to 1,000	1%	100	Immediately	Tuning

Parameters Related to Automatic Gain Switching

Pn131 (2131h)	Gain Switching Time 1 [Position]				
	Setting Range	Setting Unit	Default Setting	When Enabled	Classification
	0 to 65,535	1 ms	0	Immediately	Tuning
Pn132 (2132h)	Gain Switching Time 2 [Position]				
	Setting Range	Setting Unit	Default Setting	When Enabled	Classification
	0 to 65,535	1 ms	0	Immediately	Tuning
Pn135 (2135h)	Gain Switching Waiting Time 1 [Position]				
	Setting Range	Setting Unit	Default Setting	When Enabled	Classification
	0 to 65,535	1 ms	0	Immediately	Tuning
Pn136 (2136h)	Gain Switching Waiting Time 2 [Position]				
	Setting Range	Setting Unit	Default Setting	When Enabled	Classification
	0 to 65,535	1 ms	0	Immediately	Tuning

Related Monitoring

- SigmaWin+
You can monitor gain switching with the status monitor or with tracing.
- Analog Monitors

Parameter	Analog Monitor	Monitor Name	Output Value	Description
Pn006 (2006h)	n.□□0B	Active Gain Monitor	1 V	Gain settings 1 are enabled.
Pn007 (2007h)			2 V	Gain settings 2 are enabled.

9.12.2 Friction Compensation

Friction compensation is used to compensate for viscous friction fluctuations and regular load fluctuations.

You can automatically adjust friction compensation with autotuning without a host reference, autotuning with a host reference, or custom tuning, or you can manually adjust it with the following procedure.

Required Parameter Settings

The following parameter settings are required to use friction compensation.

Parameter	Function			When Enabled	Classification	
Pn408 (2408h)	n.0□□□ (default setting)	Disable friction compensation.			Immediately	Setup
	n.1□□□	Enable friction compensation.				
Pn121 (2121h)	Friction Compensation Gain				Speed	Position
	Setting Range	Setting Unit	Default Setting	When Enabled	Classification	
	10 to 1,000	1%	100	Immediately	Tuning	
Pn122 (2122h)	Second Friction Compensation Gain				Speed	Position
	Setting Range	Setting Unit	Default Setting	When Enabled	Classification	
	10 to 1,000	1%	100	Immediately	Tuning	
Pn123 (2123h)	Friction Compensation Coefficient				Speed	Position
	Setting Range	Setting Unit	Default Setting	When Enabled	Classification	
	0 to 100	1%	0	Immediately	Tuning	
Pn124 (2124h)	Friction Compensation Frequency Correction				Speed	Position
	Setting Range	Setting Unit	Default Setting	When Enabled	Classification	
	-10,000 to 10,000	0.1 Hz	0	Immediately	Tuning	
Pn125 (2125h)	Friction Compensation Gain Correction				Speed	Position
	Setting Range	Setting Unit	Default Setting	When Enabled	Classification	
	1 to 1,000	1%	100	Immediately	Tuning	

Operating Procedure for Friction Compensation

Use the following procedure to perform friction compensation.

CAUTION

- Before you execute friction compensation, set the moment of inertia ratio (Pn103) as accurately as possible. If the setting greatly differs from the actual moment of inertia, vibration may occur.

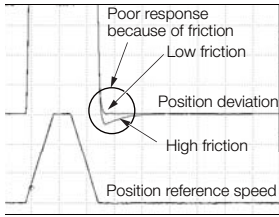
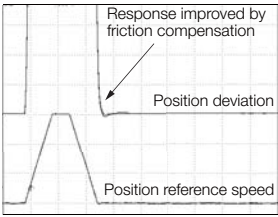
Step	Operation
1	<p>Set the following parameters related to friction compensation to their default settings.</p> <p>Friction compensation gain (Pn121): 100 Second friction compensation gain (Pn122): 100 Friction compensation coefficient (Pn123): 0 Friction compensation frequency correction (Pn124): 0 Friction compensation gain correction (Pn125): 100</p> <p>Note: Always use the default settings for the friction compensation frequency correction (Pn124) and friction compensation gain correction (Pn125).</p>
2	<p>Gradually increase the friction compensation coefficient (Pn123) to check the effect of friction compensation.</p> <p>Note: Usually, set the friction compensation coefficient (Pn123) to 95% or less. If the effect is insufficient, increase the friction compensation gain (Pn121) by 10% increments until vibration stops.</p> <p>Effect of Adjusted Parameters</p> <p>Pn121: Friction Compensation Gain and Pn122: Second Friction Compensation Gain These parameters set the response to external disturbances. The higher the setting is, the better the response will be. If the machine has a resonance frequency, however, vibration may occur if the setting is too high.</p> <p>Pn123: Friction Compensation Coefficient This parameter sets the effect of friction compensation. The higher the setting is, the more effective friction compensation will be. If the setting is too high, however, vibration will occur more easily. Usually, set the value to 95% or less.</p>
3	<p>Effect of Adjustments</p> <p>The following graphs show the response with and without adjustment.</p> <div style="display: flex; justify-content: space-around; align-items: center;"> <div style="text-align: center;">  <p>Before Friction Compensation</p> </div> <div style="font-size: 2em;">⇒</div> <div style="text-align: center;">  <p>After Friction Compensation</p> </div> </div>

9.12.3 Gravity Compensation

When the Servomotor is used with a vertical axis, gravity compensation prevents the moving part from falling due to the machine's own weight when the brake is released.

SERVOPACKs with software version 0023 or higher support gravity compensation.

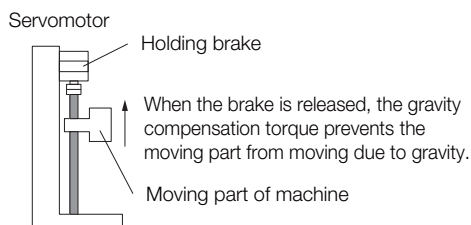

A timing chart for when the moving part is raised then lowered is provided below.

Refer to the following section for details on brake operation timing.

 [6.11.1 Brake Operating Sequence](#) on page 6-32

9.12.4 Current Control Mode Selection

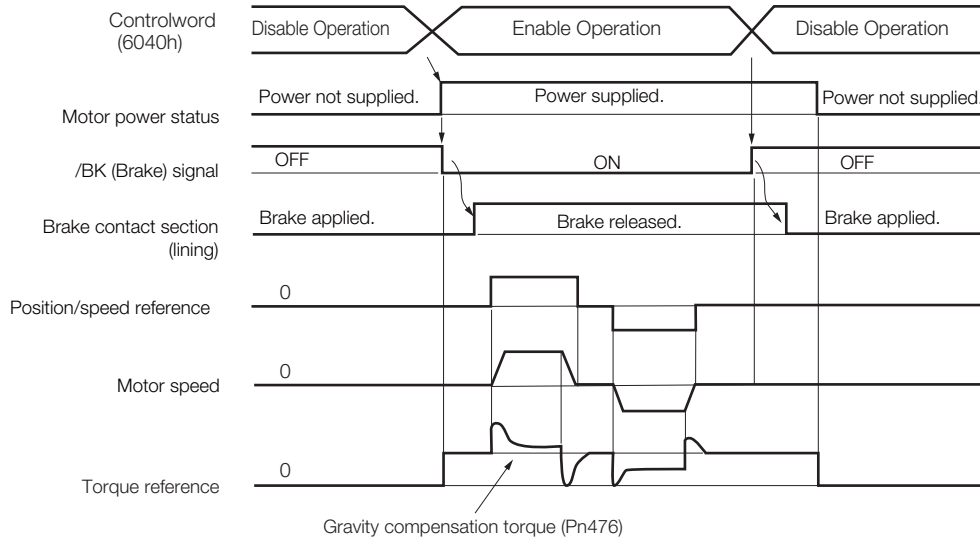

Required Parameter Settings

The following parameter settings are required to use gravity compensation.

Parameter		Description	When Enabled	Classification		
Pn475 (2475h)	n.□□□0 (default setting)	Disable gravity compensation.	After restart	Setup		
	n.□□□1	Enable gravity compensation.				
Pn476 (2476h)	Gravity Compensation Torque			Speed	Position	Torque
	Setting Range	Setting Unit	Default Setting	When Enabled	Classification	
	-1,000 to 1,000	0.1%	0	Immediately	Tuning	

Operating Procedure for Gravity Compensation

Use the following procedure to perform gravity compensation.

1. Set Pn475 to n.□□□1 (Enable gravity compensation).
2. To enable changes to the settings, turn the power supply to the SERVOPACK OFF and ON again.
3. Use SigmaWin+ or an analog monitor to find the torque reference value when the motor is stopped with the servo ON.
4. Set the torque reference value found in step 3 in Pn476 (Gravity Compensation Torque).
5. Turn the servo ON and OFF a few times and fine-tune Pn476 so that the moving part of the machine does not fall.

9.12.4 Current Control Mode Selection

Current control mode selection reduces high-frequency noise while the Servomotor is being stopped.

Parameter		Meaning	When Enabled	Classification
Pn009 (2009h)	n. □□0□	Use current control mode 1.	After restart	Tuning
	n. □□1□ (default setting)	Use current control mode 2 (low noise).		
	n. □□2□	Reserved settings (Do not use.)		



If current control mode 2 is selected, the load ratio may increase while the Servomotor is being stopped.

9.12.5 Current Gain Level Setting

You can set the current gain level to reduce noise by adjusting the parameter for current control inside the SERVOPACK according to the speed loop gain (Pn100). The noise level can be reduced by decreasing the current gain level (Pn13D) from its default setting of 2,000% (disabled). However, if the setting is decreased, the level of noise will be lowered, but the response characteristic of the SERVOPACK will also be reduced. Adjust the current gain level within the range that maintains the SERVOPACK response characteristic.

Pn13D (213Dh)	Current Gain Level			Speed	Position
	Setting Range	Setting Unit	Default Setting	When Enabled	Classification
	100 to 2,000	1%	2,000	Immediately	Tuning



If the current gain level is changed, the response characteristic of the speed loop will also change. Servo tuning must therefore be performed again.

9.12.6 Speed Detection Method Selection

You can use the speed detection method selection to ensure smooth Servomotor speed changes during operation. To ensure smooth motor speed changes during operation, set Pn009 to n.□1□□ (Use speed detection 2).

With a Linear Servomotor, you can reduce the noise level of the running motor when the linear encoder scale pitch is large.

Parameter	Meaning	When Enabled	Classification
Pn009 (2009h)	n. □0□□ (default setting)	After restart	Tuning
	n. □1□□		



If the speed detection method is changed, the response characteristic of the speed loop will also change. Servo tuning must therefore be performed again.

9.12.7 Speed Feedback Filter

You can set a first order lag filter for the speed feedback in the speed loop. This ensures smooth changes in the feedback speed to reduce vibration. If a large value is set, it will increase the delay and make response slower.

Pn308 (2308h)	Speed Feedback Filter Time Constant			Speed	Position
	Setting Range	Setting Unit	Default Setting	When Enabled	Classification
	0 to 65,535 (0.00 ms to 655.35 ms)	0.01 ms	0 (0.00 ms)	Immediately	Setup

9.12.8 Backlash Compensation

Outline

If you drive a machine that has backlash, there will be deviation between the travel distance in the position reference that is managed by the host controller and the travel distance of the actual machine. Use backlash compensation to add the backlash compensation value to the position reference and use the result to drive the Servomotor. This will ensure that the travel distance of the actual machine will be the same as the travel distance in the host controller.

- Note: 1. Backlash compensation can be used only with a Rotary Servomotor.
 2. Backlash compensation can be used only for position control.

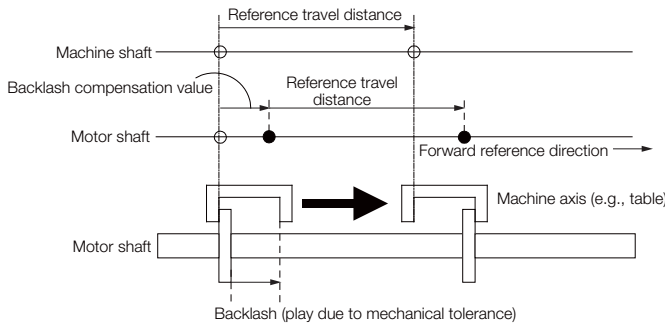

Related Parameters

Set the following parameters to use backlash compensation.

◆ Backlash Compensation Direction

Set the direction in which to apply backlash compensation.

Parameter	Meaning	When Enabled	Classification
Pn230 (2230h)	n. □□□0 (default setting)	After restart	Setup
	n. □□□1		

◆ Backlash Compensation Value

Set the amount of backlash compensation to add to the position reference. The amount is set in increments of 0.1 reference unit. However, when the amount is converted to encoder pulses, it is rounded off at the decimal point.

Example When Pn231 = 6553.6 [reference units] and position reference unit (Numerator/Denominator) = 1/1:
 $6,553.6 \times 1 = 6,553.6$ [pulses]
 ⇒ The backlash compensation will be 6,553 encoder pulses.

Pn231 (2231h)	Backlash Compensation [Position]				
	Setting Range	Setting Unit	Default Setting	When Enabled	Classification
	-500,000 to 500,000	0.1 reference units	0	Immediately	Setup



Important

- The backlash compensation value is restricted by the following formula. Backlash compensation is not performed if this condition is not met.

$$Pn231 \leq \frac{\text{Denominator}}{\text{Numerator}} \times \frac{Pn210}{Pn20E} \times \frac{\text{Maximum motor speed [min}^{-1}\text{]}}{60} \times \text{Encoder resolution} \times 0.00025$$

*Refer to the following section for the encoder resolution.

 **6.14 Setting Unit Systems on page 6-42**

With fully-closed loop control, substitute the number of external encoder pulses per motor rotation for the encoder resolution in the above formula.

Example 1:

Denominator = 1, Numerator = 1, Maximum motor speed = 6,000 [min⁻¹], and Encoder resolution = 16,777,216 (24 bits)

$1/1 \times 1/16 \times 6,000/60 \times 16,777,216 \times 0.00025 = 26,214.4$ [reference units]

⇒ The backlash compensation will be limited to 26,214.4 reference units.

Example 2:

Denominator = 1, Numerator = 1, Maximum motor speed = 6,000 [min⁻¹], number of external encoder pitches (Pn20A) = 500, and Use of the JZDP-H00□-000 (signal resolution: 1/256):

$1/4 \times 6,000/60 \times (500 \times 256) \times 0.00025 = 800.0$ [reference units]

⇒ The backlash compensation will be limited to 800.0 reference units.

- Do not exceed the upper limit of the backlash compensation value. You can check the upper limit on the operation monitor of the SigmaWin+.

◆ Backlash Compensation Time Constant

You can set a time constant for a first order lag filter for the backlash compensation value (Pn231) that is added to the position reference.

If you set Pn233 (Backlash Compensation Time Constant) to 0, the first order lag filter is disabled.

Pn233 (2233h)	Backlash Compensation Time Constant				Position
	Setting Range	Setting Unit	Default Setting	When Enabled	Classification
	0 to 65,535	0.01 ms	0	Immediately	Setup

Note: Changes to the settings are applied when there is no reference pulse input and the Servomotor is stopped.
The current operation is not affected if the setting is changed during motor operation.

Related Monitoring

You can monitor the following values on the operation monitor of the SigmaWin+.

Displayed Value	Setting Unit
Current Backlash Compensation Value	0.1 reference units
Backlash Compensation Value Setting Limit	0.1 reference units

Compensation Operation

This section describes the operation that is performed for backlash compensation.

Note: The following figures are for when backlash compensation is applied to references in the forward direction (Pn230 = n.□□□0). The following monitor information is provided in the figures: *target position* (607Ah) (target position in the reference coordinate system), *position demand value* (6062h) (reference position in the reference coordinate system), and *position actual value* (6064h) (feedback position in the machine coordinate system). The monitor information includes the feedback position in machine coordinate system (*position actual value*) and other feedback information. The backlash compensation value is subtracted from the feedback positions in the monitor information, so it is not necessary for the host controller to consider the backlash compensation value.

⚠ CAUTION

- The encoder divided pulse output will output the number of encoder pulses for which driving was actually performed, including the backlash compensation value. If you use the encoder output pulses for position feedback at the host controller, you must consider the backlash compensation value.

◆ **Operation When the Servo Is ON**

The backlash compensation value (Pn231) is added in the backlash compensation direction when the servo is ON (i.e., while power is supplied to the motor) and a reference is input in the same direction as the backlash compensation direction (Pn230.0 = n.□□□X). When there is a reference input in the direction opposite to the backlash compensation direction, the backlash compensation value is not added (i.e., backlash compensation is not performed).

The relationship between *position actual value* (6064h) and the motor shaft position is as follows:

- If a reference is input in the compensation direction: Position actual value (6064h) = Motor shaft position - Pn231
- If a reference is input in the direction opposite to the compensation direction: Position actual value (6064h) = Motor shaft position

The following figure shows driving the Servomotor in the forward direction from Target Position 0 (*target position*: 607Ah) to Target Position 1 and then to Target Position 2, and then returning from Target Position 2 to Target Position 1 and then to Target Position 0.

Backlash compensation is applied when moving from Target Position 0 to Target Position 1, but not when moving from Target Position 2 to Target Position 1.

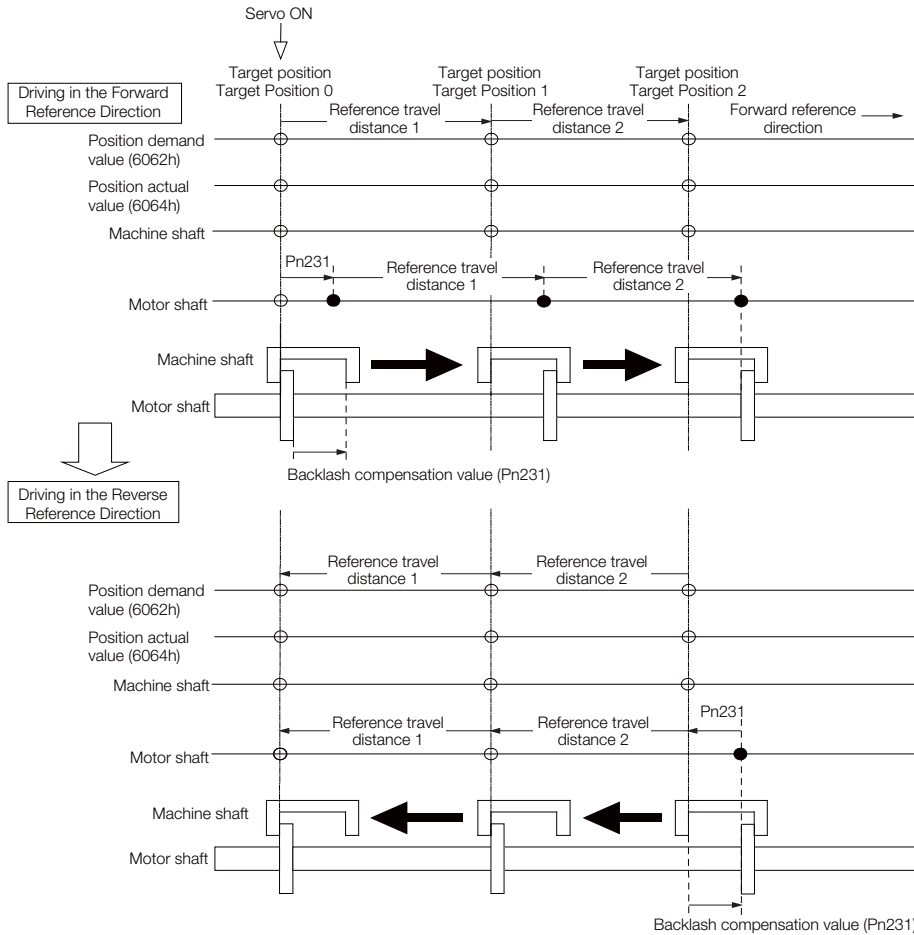

◆ Operation When the Servo Is OFF

Backlash compensation is not applied when the servo is OFF (i.e., when power is not supplied to motor). Therefore, the reference position (*position demand value* (6062h)) is moved by only the backlash compensation value.

The relationship between *position actual value* (6064h) and the motor shaft position is as follows:

- When servo is OFF: Position actual value (6064h) = Servomotor shaft position

The following figure shows what happens when the servo is turned OFF after driving the Servomotor in the forward direction from target position Target Position 0 to Target Position 1. Backlash compensation is not applied when the servo is OFF. (The SERVOPACK manages the position data so that *position actual value* (6064h) and *position demand value* (6062h) are the same.)

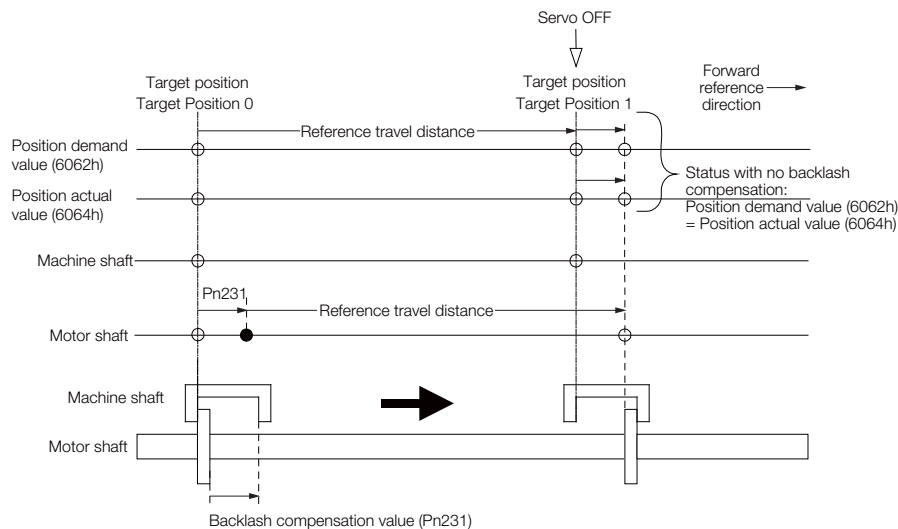

◆ Operation When There Is Overtravel

When there is overtravel (i.e., when driving is prohibited due to an overtravel signal or software limit), the operation is the same as for when the servo is OFF (◆ *Operation When the Servo Is OFF* on page 9-75), i.e., backlash compensation is not applied.

◆ Operation When Control Is Changed

Backlash compensation is performed only for position control.

Backlash compensation is not applied when position control is changed to any other control method.

Backlash compensation is applied in the same way as when the servo is ON (◆ *Operation When the Servo Is ON* on page 9-74) if any other control method is changed to position control.

Related Monitoring

You can monitor the following values on the operation monitor of the SigmaWin+.

Displayed Value	Unit	Specification
Input Reference Pulse Speed	min ⁻¹	Displays the input reference pulse speed before backlash compensation.
Position Deviation	Reference units	Displays the position deviation for the position reference after backlash compensation.
Input Reference Pulse Counter	Reference units	Displays the input reference pulse counter before backlash compensation.
Feedback Pulse Counter	Encoder pulses	Displays the number of pulses from the actually driven motor encoder.
Fully-Closed Feedback Pulse Counter	External encoder resolution	Displays the number of pulses of the actually driven external encoder.
Feedback Pulse Counter	Reference units	Displays the number of pulses from the actually driven encoder in reference units.

◆ Related Monitoring Diagrams

The following symbols are used in the related monitoring diagrams.

- [A]: Analog monitor
- [E]: EtherCAT monitor Information
- [U]: Monitor mode (Un monitor)
- [O]: Output signal
- [T]: Trace data

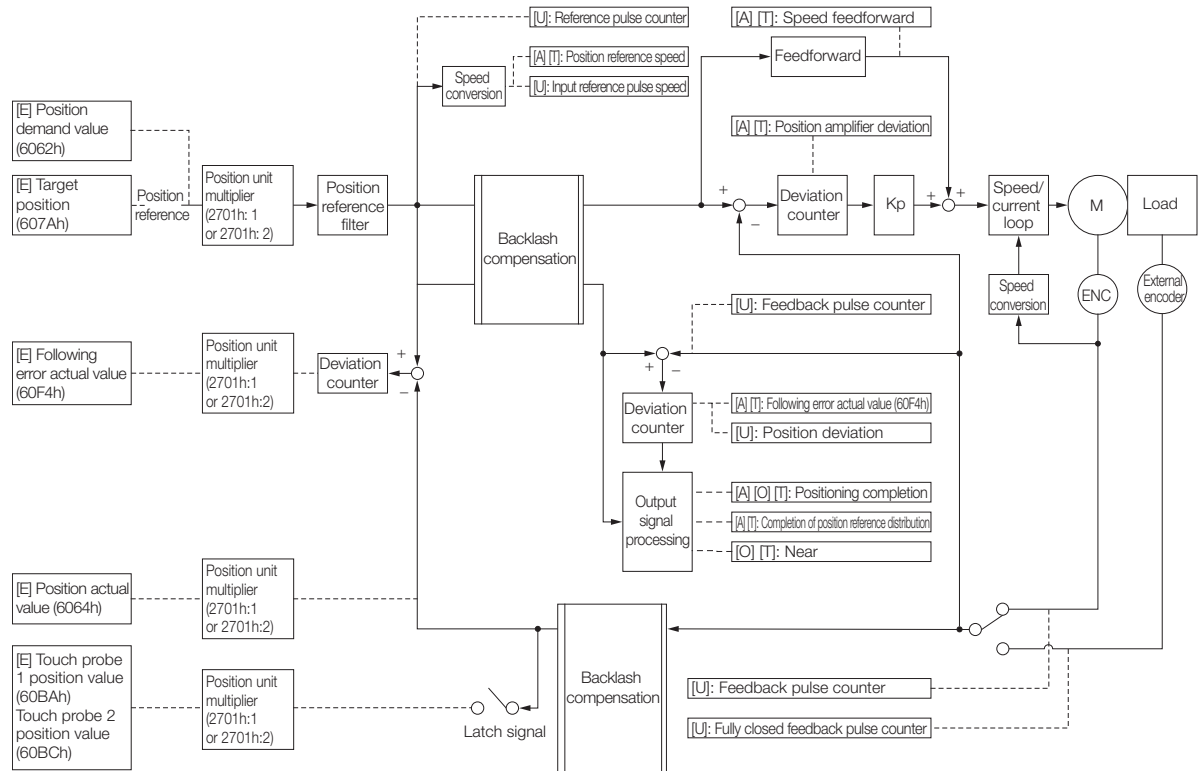

9.13 Manual Tuning

This section describes manual tuning.

9.13.1 Tuning the Servo Gains

Servo Gains

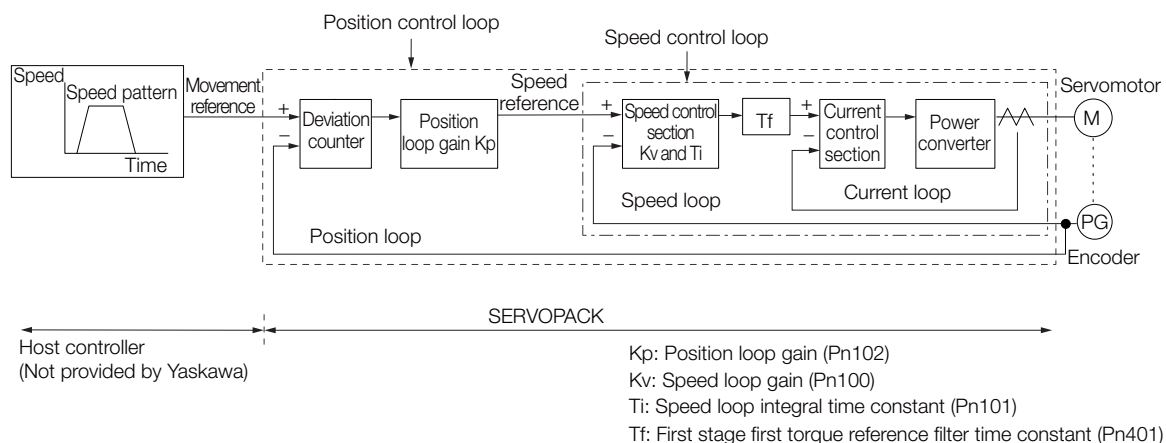

In order to manually tune the servo gains, you must understand the configuration and characteristic of the SERVOPACK and adjust the servo gains individually. In most cases, if you greatly change any one parameter, you must adjust the other parameters again. To check the response characteristic, you must prepare a measuring instrument to monitor the output waveforms from the analog monitor.

The SERVOPACK has three feedback systems (the position loop, speed loop, and current loop), and the response characteristic must be increased more with the inner loops. If this relationship is not maintained, the response characteristic will suffer and vibration will occur more easily.

A sufficient response characteristic is ensured for the current loop. There is never a need for it to be adjusted by the user.

Outline

You can use manual tuning to set the servo gains in the SERVOPACK to increase the response characteristic of the SERVOPACK. For example, you can reduce the positioning time for position control.

Use manual tuning in the following cases.

- When tuning with autotuning without a host reference or autotuning with a host reference does not achieve the desired results
- When you want to increase the servo gains higher than the gains that resulted from autotuning without a host reference or autotuning with a host reference
- When you want to determine the servo gains and moment of inertia ratio yourself

You start manual tuning either from the default parameter settings or from the gain settings that resulted from autotuning without a host reference or autotuning with a host reference.

Applicable Tools

You can monitor the servo gains with the SigmaWin+ or with the analog monitor.

Precautions

Vibration may occur while you are tuning the servo gains. We recommend that you enable vibration alarms (Pn310 = n.□□□2) to detect vibration. Refer to the following section for information on vibration detection.

 7.11 *Initializing the Vibration Detection Level* on page 7-46

Vibration alarms are not detected for all vibration. Also, an emergency stop method is necessary to stop the machine safely when an alarm occurs. You must provide an emergency stop device and activate it immediately whenever vibration occurs.

Tuning Procedure Example (for Position Control or Speed Control)

Step	Description
1	Adjust the first stage first torque reference filter time constant (Pn401) so that vibration does not occur.
2	Increase the position loop gain (Pn100) and reduce the speed loop integral time constant (Pn101) as far as possible within the range that does not cause machine vibration.
3	Repeat steps 1 and 2 and return the settings about 10% to 20% from the values that you set.
4	For position control, increase the position loop gain (Pn102) within the range that does not cause vibration.

Information If you greatly change any one servo gain parameter, you must adjust the other parameters again. Do not increase the setting of just one parameter. As a guideline, adjust the settings of the servo gains by approximately 5% each. As a rule, change the servo parameters in the following order.

- To Increase the Response Speed
 1. Reduce the torque reference filter time constant.
 2. Increase the speed loop gain.
 3. Decrease the speed loop integral time constant.
 4. Increase the position loop gain.
- To Reduce Response Speed and to Stop Vibration and Overshooting
 1. Reduce the position loop gain.
 2. Increase the speed loop integral time constant.
 3. Decrease the speed loop gain.
 4. Increase the torque filter time constant.

Adjusted Servo Gains

You can set the following gains to adjust the response characteristic of the SERVOPACK.

- Pn100: Speed Loop Gain
- Pn101: Speed Loop Integral Time Constant
- Pn102: Position Loop Gain
- Pn401: First Stage First Torque Reference Filter Time Constant

◆ Position Loop Gain

The position loop gain determines the response characteristic of the position loop in the SERVOPACK. If you can increase the setting of the position loop gain, the response characteristic will improve and the positioning time will be shortened. However, you normally cannot increase the position loop gain higher than the inherent vibration frequency of the machine system. Therefore, to increase the setting of the position loop gain, you must increase the rigidity of the machine to increase the inherent vibration frequency of the machine.

Pn102 (2102h)	Position Loop Gain Position				
	Setting Range	Setting Unit	Default Setting	When Enabled	Classification
	10 to 20,000	0.1/s	400	Immediately	Tuning

Information For machines for which a high position loop gain (Pn102) cannot be set, overflow alarms can occur during high-speed operation. If that is the case, you can increase the setting of the following parameter to increase the level for alarm detection. Use the following condition as a guideline for determining the setting.

$$Pn520 \geq \frac{\text{Maximum feed speed [reference units/s]}}{Pn102 \div 10 (1/s)} \times 2.0$$

If you use a position reference filter, transient deviation will increase due to the filter time constant. When you make the setting, consider deviation accumulation that may result from the filter.

Pn520 (2520h)	Position Deviation Overflow Alarm Level Position				
	Setting Range	Setting Unit	Default Setting	When Enabled	Classification
	1 to 1,073,741,823	1 reference unit	5,242,880	Immediately	Setup

◆ Speed Loop Gain

This parameter determines the response characteristic of the speed loop. If the response characteristic of the speed loop is low, it becomes a delay factor for the position loop located outside of the speed loop. This will result in overshooting and vibration in the speed reference. Therefore, setting the speed loop gain as high as possible within the range that will not cause the machine system to vibrate will produce a stable Servo System with a good response characteristic.

Pn100 (2100h)	Speed Loop Gain Speed Position Torque				
	Setting Range	Setting Unit	Default Setting	When Enabled	Classification
	10 to 20,000	0.1 Hz	400	Immediately	Tuning

$$\text{Setting of Pn103} = \frac{\text{Load moment of inertia at motor shaft } (J_L)}{\text{Servomotor moment of inertia } (L_M)} \times 100(\%)$$

The default setting of Pn103 (Moment of Inertia Ratio) is 100. Before you tune the servo, calculate the moment of inertia ratio with the above formula and set Pn103 to the calculation result.

Pn103 (2103h)	Moment of Inertia Ratio Speed Position Torque				
	Setting Range	Setting Unit	Default Setting	When Enabled	Classification
	0 to 20,000	1%	100	Immediately	Tuning

◆ Speed Loop Integral Time Constant

To enable response to even small inputs, the speed loop has an integral element. The integral element becomes a delay factor in the Servo System. If the time constant is set too high, overshooting will occur, positioning settling time will increase, and the response characteristic will suffer.

Pn101 (2101h)	Speed Loop Integral Time Constant Speed Position				
	Setting Range	Setting Unit	Default Setting	When Enabled	Classification
	15 to 51,200	0.01 ms	2,000	Immediately	Tuning

◆ Torque Reference Filter

As shown in the following diagram, the torque reference filter contains a first order lag filter and notch filters arranged in series, and each filter operates independently.

The notch filters can be enabled and disabled with Pn408 = n.□X□X and Pn416 = n.□XXX.

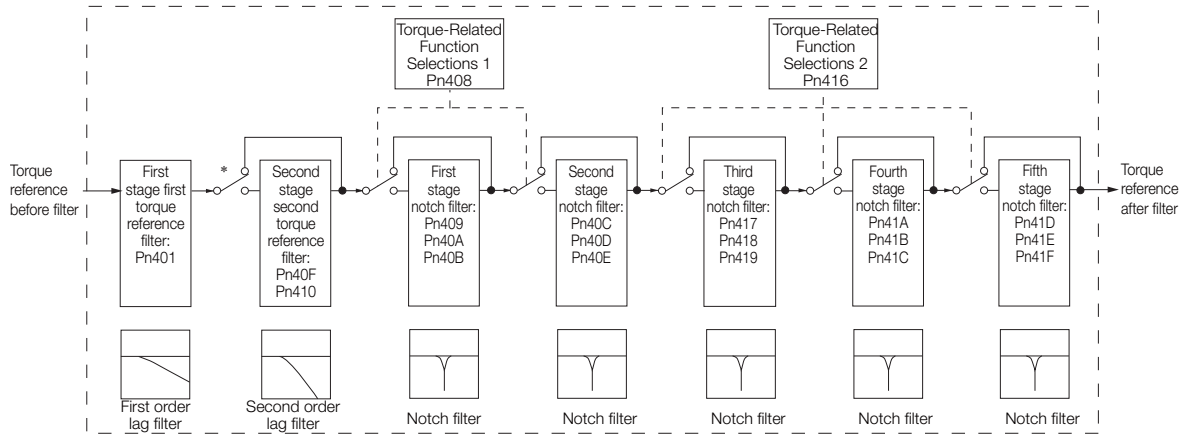

* The second stage second torque reference filter is disabled when Pn40F is set to 5,000 (default setting) and it is enabled when Pn40F is set to a value lower than 5,000.

■ Torque Reference Filter

If you suspect that machine vibration is being caused by the Servo Drive, try adjusting the torque reference filter time constant. This may stop the vibration. The lower the value, the better the control response characteristic will be, but there may be a limit depending on the machine conditions.

Pn401 (2401h)	First Stage First Torque Reference Filter Time Constant			Speed	Position	Torque
	Setting Range	Setting Unit	Default Setting	When Enabled	Classification	
	0 to 65,535	0.01 ms	100	Immediately	Tuning	
Pn40F (240Fh)	Second Stage Second Torque Reference Filter Frequency			Speed	Position	Torque
	Setting Range	Setting Unit	Default Setting	When Enabled	Classification	
	100 to 5,000	1 Hz	5000*	Immediately	Tuning	
Pn410 (2410h)	Second Stage Second Torque Reference Filter Q Value			Speed	Position	Torque
	Setting Range	Setting Unit	Default Setting	When Enabled	Classification	
	50 to 100	0.01	50	Immediately	Tuning	

* The filter is disabled if you set the parameter to 5,000.

■ Notch Filters

The notch filter can eliminate specific frequency elements generated by the vibration of sources such as resonance of the shaft of a ball screw.

The notch filter puts a notch in the gain curve at the specific vibration frequency (called the notch frequency). The frequency components near the notch frequency can be reduced or removed with a notch filter.

Notch filters are set with three parameters for the notch filter frequency, notch filter Q value, and notch filter depth. This section describes the notch filter Q value and notch filter depth.

• Notch filter Q Value

The setting of the notch filter Q value determines the width of the frequencies that are filtered for the notch filter frequency. The width of the notch changes with the notch filter Q value. The larger the notch filter Q value is, the steeper the notch is and the narrower the width of frequencies that are filtered is.

The notch filter frequency characteristics for different notch filter Q values are shown below.

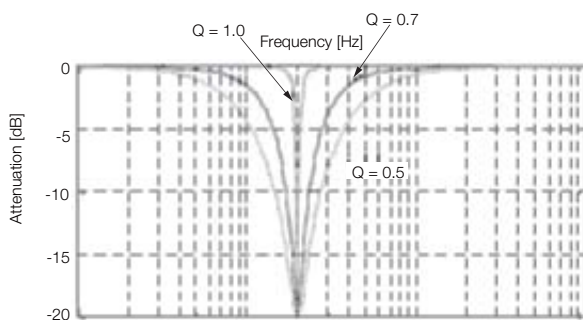

Note: The above notch filter frequency characteristics are based on calculated values and may be different from actual characteristics.

• Notch Filter Depth

The setting of the notch filter depth determines the depth of the frequencies that are filtered for the notch filter frequency. The depth of the notch changes with the notch filter depth. The smaller the notch filter depth is, the deeper the notch is, increasing the effect of vibration suppression. However, if the value is too small, vibration can actually increase.

The notch filter is disabled if the notch filter depth, d, is set to 1.0 (i.e., if Pn419 is set to 1,000).

The notch filter frequency characteristics for different notch filter depths are shown below.

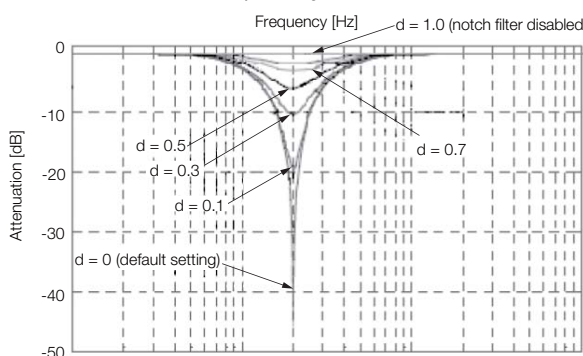

Note: The above notch filter frequency characteristics are based on calculated values and may be different from actual characteristics.

You can enable or disable the notch filter with Pn408.

Parameter	Meaning	When Enabled	Classification
Pn408 (2408h)	n.□□□0 (default setting)	Disable first stage notch filter.	Immediately Setup
	n.□□□1	Enable first stage notch filter.	
	n.□0□□ (default setting)	Disable second stage notch filter.	
	n.□1□□	Enable second stage notch filter.	
Pn416 (2416h)	n.□□□0 (default setting)	Disable third stage notch filter.	
	n.□□□1	Enable third stage notch filter.	
	n.□□0□ (default setting)	Disable fourth stage notch filter.	
	n.□□1□	Enable fourth stage notch filter.	
	n.□0□□ (default setting)	Disable fifth stage notch filter.	
	n.□1□□	Enable fifth stage notch filter.	

Set the machine vibration frequencies in the notch filter parameters.

Pn409 (2409h)	First Stage Notch Filter Frequency				Speed	Position	Torque
	Setting Range	Setting Unit	Default Setting	When Enabled	Classification		
	50 to 5,000	1 Hz	5,000	Immediately	Tuning		
Pn40A (240Ah)	First Stage Notch Filter Q Value				Speed	Position	Torque
	Setting Range	Setting Unit	Default Setting	When Enabled	Classification		
	50 to 1,000	0.01	70	Immediately	Tuning		
Pn40B (240Bh)	First Stage Notch Filter Depth				Speed	Position	Torque
	Setting Range	Setting Unit	Default Setting	When Enabled	Classification		
	0 to 1,000	0.001	0	Immediately	Tuning		
Pn40C (240Ch)	Second Stage Notch Filter Frequency				Speed	Position	Torque
	Setting Range	Setting Unit	Default Setting	When Enabled	Classification		
	50 to 5,000	1 Hz	5,000	Immediately	Tuning		
Pn40D (240Dh)	Second Stage Notch Filter Q Value				Speed	Position	Torque
	Setting Range	Setting Unit	Default Setting	When Enabled	Classification		
	50 to 1,000	0.01	70	Immediately	Tuning		
Pn40E (240Eh)	Second Stage Notch Filter Depth				Speed	Position	Torque
	Setting Range	Setting Unit	Default Setting	When Enabled	Classification		
	0 to 1,000	0.001	0	Immediately	Tuning		
Pn417 (2417h)	Third Stage Notch Filter Frequency				Speed	Position	Torque
	Setting Range	Setting Unit	Default Setting	When Enabled	Classification		
	50 to 5,000	1 Hz	5,000	Immediately	Tuning		
Pn418 (2418h)	Third Stage Notch Filter Q Value				Speed	Position	Torque
	Setting Range	Setting Unit	Default Setting	When Enabled	Classification		
	50 to 1,000	0.01	70	Immediately	Tuning		
Pn419 (2419h)	Third Stage Notch Filter Depth				Speed	Position	Torque
	Setting Range	Setting Unit	Default Setting	When Enabled	Classification		
	0 to 1,000	0.001	0	Immediately	Tuning		
Pn41A (241Ah)	Fourth Stage Notch Filter Frequency				Speed	Position	Torque
	Setting Range	Setting Unit	Default Setting	When Enabled	Classification		
	50 to 5,000	1 Hz	5,000	Immediately	Tuning		
Pn41B (241Bh)	Fourth Stage Notch Filter Q Value				Speed	Position	Torque
	Setting Range	Setting Unit	Default Setting	When Enabled	Classification		
	50 to 1,000	0.01	70	Immediately	Tuning		
Pn41C (241Ch)	Fourth Stage Notch Filter Depth				Speed	Position	Torque
	Setting Range	Setting Unit	Default Setting	When Enabled	Classification		
	0 to 1,000	0.001	0	Immediately	Tuning		
Pn41D (241Dh)	Fifth Stage Notch Filter Frequency				Speed	Position	Torque
	Setting Range	Setting Unit	Default Setting	When Enabled	Classification		
	50 to 5,000	1 Hz	5,000	Immediately	Tuning		
Pn41E (241Eh)	Fifth Stage Notch Filter Q Value				Speed	Position	Torque
	Setting Range	Setting Unit	Default Setting	When Enabled	Classification		
	50 to 1,000	0.01	70	Immediately	Tuning		
Pn41F (241Fh)	Fifth Stage Notch Filter Depth				Speed	Position	Torque
	Setting Range	Setting Unit	Default Setting	When Enabled	Classification		
	0 to 1,000	0.001	0	Immediately	Tuning		



Important

- Do not set notch filter frequencies (Pn409, Pn40C, Pn417, Pn41A, and Pn41D) that are close to the speed loop's response frequency. Set a frequency that is at least four times the speed loop gain (Pn100). (However, Pn103 (Moment of Inertia Ratio) must be set to an appropriate value.) If the setting is not correct, vibration may occur and the machine may be damaged.
- Change the notch filter frequencies (Pn409, Pn40C, Pn417, Pn41A, and Pn41D) only while the Servomotor is stopped. Vibration may occur if a notch filter frequency is changed during operation.

Guidelines for Manually Tuning Servo Gains

When you manually adjust the parameters, make sure that you completely understand the information in the product manual and use the following conditional expressions as guidelines. The appropriate values of the parameter settings are influenced by the machine specifications, so they cannot be determined universally. When you adjust the parameters, actually operate the machine and use the SigmaWin+ or analog monitor to monitor operating conditions. Even if the status is stable while the motor is stopped, an unstable condition may occur when an operation reference is input. Therefore, input operation references and adjust the servo gains as you operate the motor.

Stable gain: Settings that provide a good balance between parameters.

However, if the load moment of inertia is large and the machine system contains elements prone to vibration, you must sometimes use a setting that is somewhat higher to prevent the machine from vibrating.

Critical gain: Settings for which the parameters affect each other

Depending on the machine conditions, overshooting and vibration may occur and operation may not be stable. If the critical gain condition expressions are not met, operation will become more unstable, and there is a risk of abnormal motor shaft vibration and round-trip operation with a large amplitude. Always stay within the critical gain conditions.

If you use the torque reference filter, second torque reference filter, and notch filters together, the interference between the filters and the speed loop gain will be superimposed. Allow leeway in the adjustments.



Important

The following adjusted value guidelines require that the setting of Pn103 (Moment of Inertia Ratio) is correctly set for the actual machine.

◆ When Pn10B = n.□□0□ (PI Control)

Guidelines are given below for gain settings 1.

The same guidelines apply to gain settings 2 (Pn104, Pn105, Pn106, and Pn412).

- Speed Loop Gain (Pn100 [Hz]) and Position Loop Gain (Pn102 [/s])
 - Stable gain: $Pn102 \text{ [s]} \leq 2\pi \times Pn100/4 \text{ [Hz]}$
 - Critical gain: $Pn102 \text{ [s]} < 2\pi \times Pn100 \text{ [Hz]}$
- Speed Loop Gain (Pn100 [Hz]) and Speed Loop Integral Time Constant (Pn101 [ms])
 - Stable gain: $Pn101 \text{ [ms]} \geq 4,000/(2\pi \times Pn100 \text{ [Hz]})$
 - Critical gain: $Pn101 \text{ [ms]} > 1,000/(2\pi \times Pn100 \text{ [Hz]})$
- Speed Loop Gain (Pn100 [Hz]) and First Stage First Torque Reference Filter Time Constant (Pn401 [ms])
 - Stable gain: $Pn401 \text{ [ms]} \leq 1,000/(2\pi \times Pn100 \text{ [Hz]} \times 4)$
 - Critical gain: $Pn401 \text{ [ms]} < 1,000/(2\pi \times Pn100 \text{ [Hz]} \times 1)$

- Speed Loop Gain (Pn100 [Hz]) and Second Stage Second Torque Reference Filter Frequency (Pn40F [Hz])
Critical gain: $Pn40F [Hz] > 4 \times Pn100 [Hz]$
Note: Set the second stage second torque reference filter Q value (Pn410) to 0.70.
- Speed Loop Gain (Pn100 [Hz]) and First Stage Notch Filter Frequency (Pn409 [Hz]) (or Second Stage Notch Filter Frequency (Pn40C [Hz]))
Critical gain: $Pn409 [Hz] > 4 \times Pn100 [Hz]$
- Speed Loop Gain (Pn100 [Hz]) and Speed Feedback Filter Time Constant (Pn308 [ms])
Stable gain: $Pn308 [ms] \leq 1,000 / (2\pi \times Pn100 [Hz] \times 4)$
Critical gain: $Pn308 [ms] < 1,000 / (2\pi \times Pn100 [Hz] \times 1)$

◆ When Pn10B = n.□□1□ (I-P Control)

Guidelines are given below for gain settings 1.

The same guidelines apply to gain settings 2 (Pn104, Pn105, Pn106, and Pn412).

For I-P control, the relationships between the speed loop integral time constant, speed loop gain, and position loop gain are different from the relationships for PI control. The relationship between other servo gains is the same as for PI control.

- Speed Loop Gain (Pn100 [Hz]) and Speed Loop Integral Time Constant (Pn101 [ms])
Stable gain: $Pn100 [Hz] \geq 320 / Pn101 [ms]$
- Position Loop Gain (Pn102 [/s]) and Speed Loop Integral Time Constant (Pn101 [ms])
Stable gain: $Pn102 [/s] \leq 320 / Pn101 [ms]$

Information

Selecting the Speed Loop Control Method (PI Control or I-P Control)

Usually, I-P control is effective for high-speed positioning and high-speed, high-precision processing applications. With I-P control, you can use a lower position loop gain than for PI control to reduce the positioning time and reduce arc radius reduction. However, if you can use mode switching to change to proportional control to achieve the desired application, then using PI control would be the normal choice.

◆ Decimal Points in Parameter Settings

For the SGD7S SERVOPACKs, decimal places are given for the settings of parameters on the Digital Operator, Panel Operator, and in the manual. For example with Speed Loop Gain (Pn100), Pn100 = 40.0 is used to indicate a setting of 40.0 Hz. In the following adjusted value guidelines, the decimal places are also given.

Example

- Speed Loop Gain (Pn100 [Hz]) and Speed Loop Integral Time Constant (Pn101 [ms])
Stable gain: $Pn101 [ms] \geq 4,000 / (2\pi \times Pn100 [Hz])$, therefore
If Pn100 = 40.0 [Hz], then $Pn101 = 4,000 / (2\pi \times 40.0) \approx 15.92 [ms]$.

Model Following Control

You can use model following control to improve response characteristic and shorten positioning time. You can use model following control only with position control.

Normally, the parameters that are used for model following control are automatically set along with the servo gains by executing autotuning or custom tuning. However, you must adjust them manually in the following cases.

- When the tuning results for autotuning or custom tuning are not acceptable
- When you want to increase the response characteristic higher than that achieved by the tuning results for autotuning or custom tuning
- When you want to determine the servo gains and model following control parameters yourself

The block diagram for model following control is provided below.

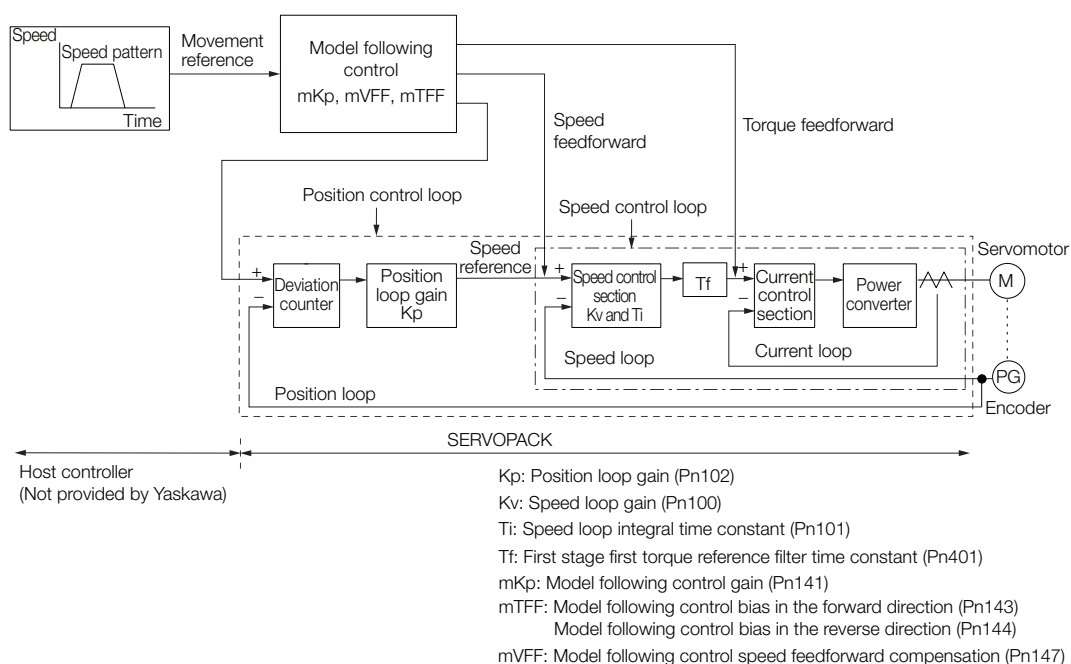

◆ Manual Tuning Procedure

Use the following tuning procedure for using model following control.

Step	Description
1	Friction compensation must also be used. Set the friction compensation parameters. Refer to the following section for the setting procedure. 📖 9.12.2 Friction Compensation on page 9-68
2	Adjust the servo gains. Refer to the following section for an example procedure. 📖 Tuning Procedure Example (for Position Control or Speed Control) on page 9-78 Note: 1. Set the moment of inertia ratio (Pn103) as accurately as possible. 2. Refer to the guidelines for manually tuning the servo gains and set a stable gain for the position loop gain (Pn102). 📖 Guidelines for Manually Tuning Servo Gains on page 9-83
3	Increase the model following control gain (Pn141) as much as possible within the range in which overshooting and vibration do not occur.
4	If overshooting occurs or if the response is different for forward and reverse operation, fine-tune model following control with the following settings: model following control bias in the forward direction (Pn143), model following control bias in the reverse direction (Pn144), and model following control speed feedforward compensation (Pn147).

◆ Related Parameters

Next we will describe the following parameters that are used for model following control.

- Pn140 (Model Following Control-Related Selections)
- Pn141 (Model Following Control Gain)
- Pn143 (Model Following Control Bias in the Forward Direction)
- Pn144 (Model Following Control Bias in the Reverse Direction)
- Pn147 (Model Following Control Speed Feedforward Compensation)

■ Model Following Control-Related Selections

Set Pn140 = n.□□□X to specify whether to use model following control.

If you use model following control with vibration suppression, set Pn140 to n.□□1□ or Pn140 = n.□□2□. When you also perform vibration suppression, adjust vibration suppression with custom tuning in advance.

Note: If you use vibration suppression (Pn140 = n.□□1□ or Pn140 = n.□□2□), always set Pn140 to n.□□□1 (Use model following control).

Parameter	Function	When Enabled	Classification
Pn140 (2140h)	n.□□□0 (default setting)	Do not use model following control.	Immediately Tuning
	n.□□□1	Use model following control.	
	n.□□□□ (default setting)	Do not perform vibration suppression.	
	n.□□1□	Perform vibration suppression for a specific frequency.	
	n.□□2□	Perform vibration suppression for two specific frequencies.	

■ Model Following Control Gain

The model following control gain determines the response characteristic of the Servo System. If you increase the setting of the model following control gain, the response characteristic will improve and the positioning time will be shortened. The response characteristic of the Servo System is determined by this parameter, and not by Pn102 (Position Loop Gain).

Pn141 (2141h)	Model Following Control Gain				Position
	Setting Range	Setting Unit	Default Setting	When Enabled	Classification
	10 to 20,000	0.1/s	500	Immediately	Tuning

Information

For machines for which a high model following control gain cannot be set, the size of the position deviation in model following control will be determined by the setting of the model following control gain. For a machine with low rigidity, in which a high model following control gain cannot be set, position deviation overflow alarms may occur during high-speed operation. If that is the case, you can increase the setting of the following parameter to increase the level for alarm detection.

Use the following conditional expression for reference in determining the setting.

$$Pn\ 520 \geq \frac{\text{Maximum feed speed [reference units/s]}}{Pn\ 141/10 [1/s]} \times 2.0$$

Pn520 (2520h)	Position Deviation Overflow Alarm Level				Position
	Setting Range	Setting Unit	Default Setting	When Enabled	Classification
	1 to 1,073,741,823	1 reference unit	5,242,880	Immediately	Setup

■ Model Following Control Bias in the Forward Direction and Model Following Control Bias in the Reverse Direction

If the response is different for forward and reverse operation, use the following parameters for fine-tuning.

If you decrease the settings, the response characteristic will be lowered but overshooting will be less likely to occur.

Pn143 (2143h)	Model Following Control Bias in the Forward Direction				Position
	Setting Range	Setting Unit	Default Setting	When Enabled	Classification
	0 to 10,000	0.1%	1,000	Immediately	Tuning
Pn144 (2144h)	Model Following Control Bias in the Reverse Direction				Position
	Setting Range	Setting Unit	Default Setting	When Enabled	Classification
	0 to 10,000	0.1%	1,000	Immediately	Tuning

■ Model Following Control Speed Feedforward Compensation

If overshooting occurs even after you adjust the model following control gain, model following control bias in the forward direction, and model following control bias in the reverse direction, you may be able to improve performance by setting the following parameter.

If you decrease the settings, the response characteristic will be lowered but overshooting will be less likely to occur.

Pn147 (2147h)	Model Following Control Speed Feedforward Compensation					Position
	Setting Range	Setting Unit	Default Setting	When Enabled	Classification	
	0 to 10,000	0.1%	1,000	Immediately	Tuning	

■ Model Following Control Type Selection

When you enable model following control, you can select the model following control type. Normally, set Pn14F to n.□□□1 (Use model following control type 2) (default setting). If compatibility with previous models is required, set Pn14F to n.□□□0 (Use model following control type 1).

Parameter	Meaning	When Enabled	Classification
Pn14F (214Fh)	n.□□□0	After restart	Tuning
	n.□□□1 (default setting)		

9.13.2 Compatible Adjustment Functions

The compatible adjustment functions are used together with manual tuning. You can use these functions to improve adjustment results. These functions allow you to use the same functions as for Σ-III-Series SERVOPACKs to adjust Σ-7-Series SERVOPACKs.

Feedforward

The feedforward function applies feedforward compensation to position control to shorten the positioning time.

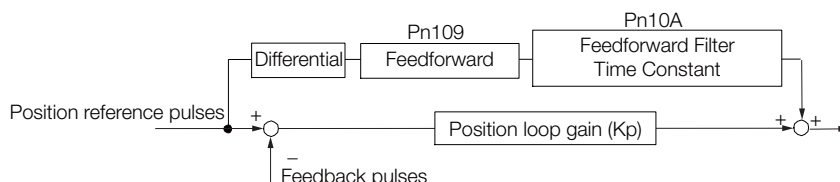

Pn109 (2109h)	Feedforward					Position
	Setting Range	Setting Unit	Default Setting	When Enabled	Classification	
	0 to 100	1%	0	Immediately	Tuning	
Pn10A (210Ah)	Feedforward Filter Time Constant					Position
	Setting Range	Setting Unit	Default Setting	When Enabled	Classification	
	0 to 6,400	0.01 ms	0	Immediately	Tuning	

Note: If you set the feedforward value too high, the machine may vibrate. As a guideline, use a setting of 80% or less.

Mode Switching (Changing between Proportional and PI Control)

You can use mode switching to automatically change between proportional control and PI control.

Overshooting caused by acceleration and deceleration can be suppressed and the settling time can be reduced by setting the switching condition and switching levels.

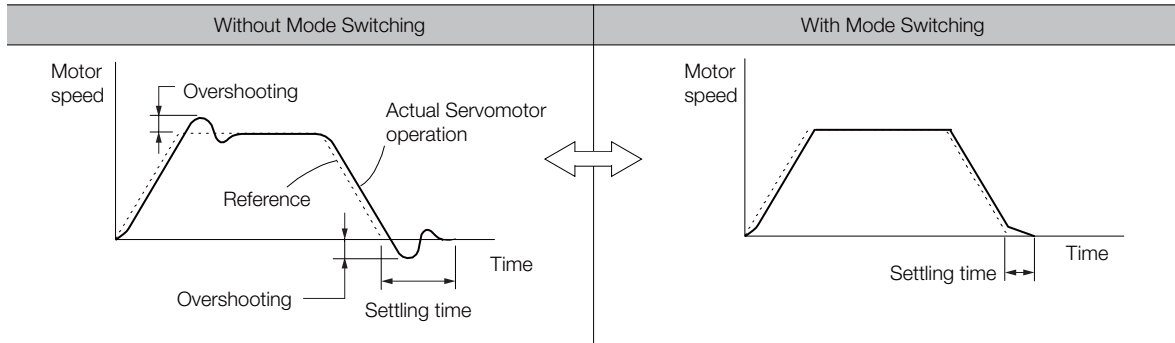

◆ Related Parameters

Select the switching condition for mode switching with Pn10B = n.□□□X.

Parameter	Mode Switching Selection	Parameter That Sets the Level		When Enabled	Classification
		Rotary Servomotor	Linear Servomotor		
Pn10B (210Bh)	n.□□□0 (default setting)	Pn10C (210Ch)		Immediately	Setup
	n.□□□1	Pn10D (210Dh)	Pn181 (2181h)		
	n.□□□2	Pn10E (210Eh)	Pn182 (2182h)		
	n.□□□3	Pn10F (210Fh)			
	n.□□□4	-			

■ Parameters That Set the Switching Levels

- Rotary Servomotors

Pn10C (210Ch)	Mode Switching Level for Torque Reference [Speed] [Position]				
	Setting Range	Setting Unit	Default Setting	When Enabled	Classification
	0 to 800	1%	200	Immediately	Tuning
Pn10D (210Dh)	Mode Switching Level for Speed Reference [Speed] [Position]				
	Setting Range	Setting Unit	Default Setting	When Enabled	Classification
	0 to 10,000	1 min ⁻¹	0	Immediately	Tuning
Pn10E (210Eh)	Mode Switching Level for Acceleration [Speed] [Position]				
	Setting Range	Setting Unit	Default Setting	When Enabled	Classification
	0 to 30,000	1 min ⁻¹ /s	0	Immediately	Tuning
Pn10F (210Fh)	Mode Switching Level for Position Deviation [Position]				
	Setting Range	Setting Unit	Default Setting	When Enabled	Classification
	0 to 10,000	1 reference unit	0	Immediately	Tuning

• Linear Servomotors

Pn10C (210Ch)	Mode Switching Level for Force Reference				Speed	Position
	Setting Range	Setting Unit	Default Setting	When Enabled	Classification	
	0 to 800	1%	200	Immediately	Tuning	
Pn181 (2181h)	Mode Switching Level for Speed Reference				Speed	Position
	Setting Range	Setting Unit	Default Setting	When Enabled	Classification	
	0 to 10,000	1 mm/s	0	Immediately	Tuning	
Pn182 (2182h)	Mode Switching Level for Acceleration				Speed	Position
	Setting Range	Setting Unit	Default Setting	When Enabled	Classification	
	0 to 30,000	1 mm/s ²	0	Immediately	Tuning	
Pn10F (210Fh)	Mode Switching Level for Position Deviation				Position	
	Setting Range	Setting Unit	Default Setting	When Enabled	Classification	
	0 to 10,000	1 reference unit	0	Immediately	Tuning	

■ Using the Torque Reference as the Mode Switching Condition (Default Setting)

When the torque reference equals or exceeds the torque set for the mode switching level for torque reference (Pn10C), the speed loop is changed to P control.

The default setting for the torque reference level is 200%.

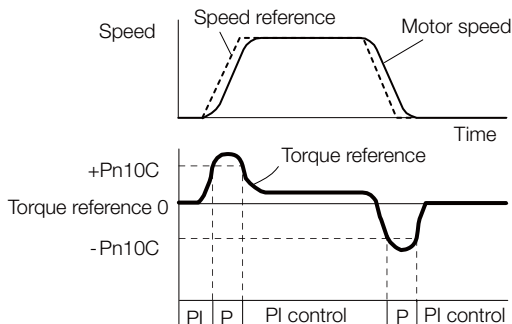

■ Using the Speed Reference as the Mode Switching Condition

• Rotary Servomotors

When the speed reference equals or exceeds the speed set for the mode switching level for a speed reference (Pn10D), the speed loop is changed to P control.

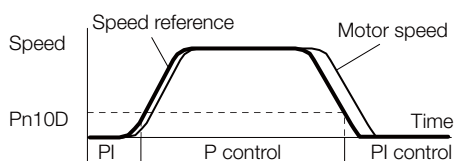

• Linear Servomotors

When the speed reference equals or exceeds the speed set for the mode switching level for a speed reference (Pn181), the speed loop is changed to P control.

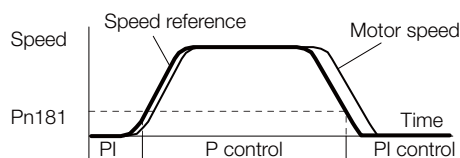

■ Using the Acceleration as the Mode Switching Condition

• Rotary Servomotors

When the speed reference equals or exceeds the acceleration rate set for the mode switching level for acceleration (Pn10E), the speed loop is changed to P control.

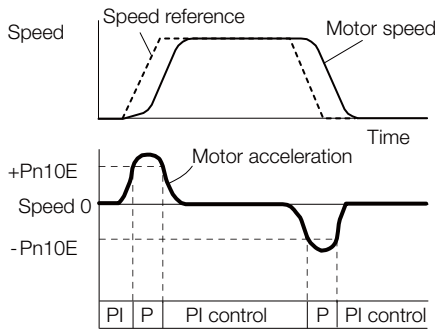

• Linear Servomotors

When the speed reference equals or exceeds the acceleration rate set for the mode switching level for acceleration (Pn182), the speed loop is changed to P control.

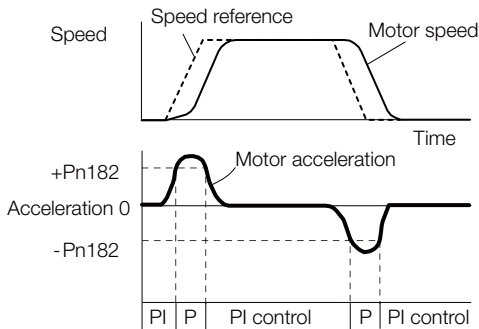

◆ Using the Position Deviation as the Mode Switching Condition

When the position deviation equals or exceeds the value set for the mode switching level for position deviation (Pn10F), the speed loop is changed to P control.

This setting is enabled only for position control.

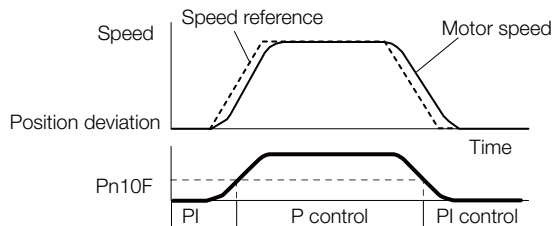

Position Integral

The position integral is the integral function of the position loop. This parameter is effective for electronic cams and electronic shafts.

Pn11F (211Fh)	Position Integral Time Constant				Position
	Setting Range	Setting Unit	Default Setting	When Enabled	Classification
	0 to 50,000	0.1 ms	0	Immediately	Tuning

9.14 Diagnostic Tools

9.14.1 Mechanical Analysis

Overview

You can connect the SERVOPACK to a computer to measure the frequency characteristics of the machine. This allows you to measure the frequency characteristics of the machine without using a measuring instrument.

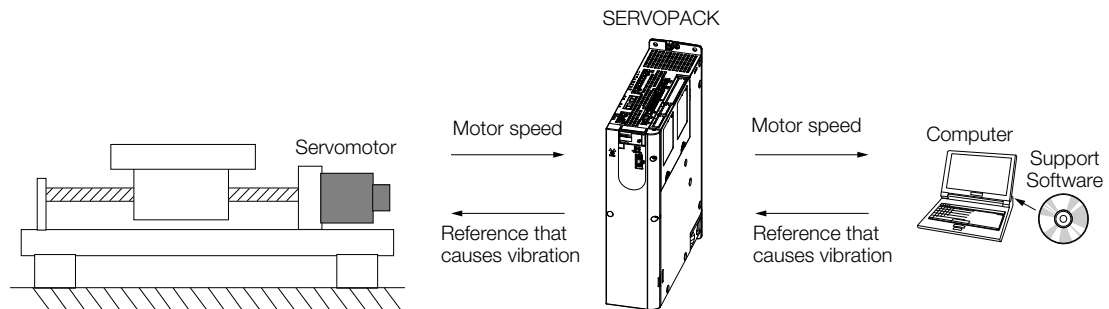

The motor is used to cause machine vibration and then the speed frequency characteristics for the motor torque are measured. The measured frequency characteristics can be used to determine the machine resonance.

You determine the machine resonance for use in servo tuning and as reference for considering changes to the machine. The performance of the servo cannot be completely utilized depending on the rigidity of the machine. You may need to consider making changes to the machine. The information can also be used as reference for servo tuning to help you adjust parameters, such as the servo rigidity and torque filter time constant.

You can also use the information to set parameters, such as the notch filters.



WARNING

- Mechanical analysis requires operating the motor and therefore presents hazards. Before you execute mechanical analysis, check the information provided in the SigmaWin+ operating manual.

Frequency Characteristics

The motor is used to cause the machine to vibrate and the frequency characteristics from the torque to the motor speed are measured to determine the machine characteristics. For a normal machine, the resonance frequencies are clear when the frequency characteristics are plotted on graphs with the gain and phase (bode plots). The bode plots show the size (gain) of the response of the machine to which the torque is applied, and the phase delay (phase) in the response for each frequency. Also, the machine resonance frequency can be determined from the maximum frequency of the valleys (anti-resonance) and peaks (resonance) of the gain and the phase delay.

For a motor without a load or for a rigid mechanism, the gain and phase change gradually in the bode plots.

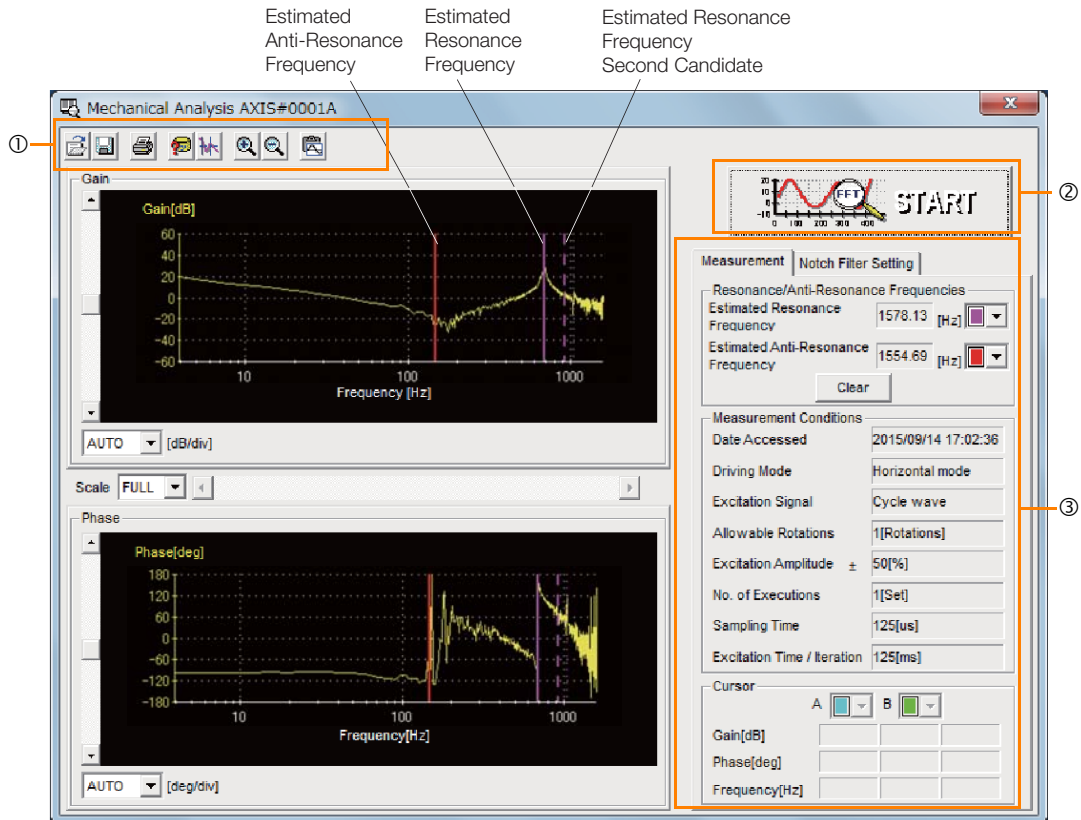

① Toolbar

② **START** Button

Click the **START** Button to start analysis.

③ **Measurement** and **Notch Filter Setting** Tab Pages

Measurement Tab Page: Displays detailed information on the results of analysis.

Notch Filter Setting Tab Page: Displays the notch filter frequencies. You can set these values in the parameters.

9.14.2 Easy FFT

The machine is made to vibrate and a resonance frequency is detected from the generated vibration to set notch filters according to the detected resonance frequencies. This is used to eliminate high-frequency vibration and noise.

During execution of Easy FFT, a frequency waveform reference is sent from the SERVOPACK to the Servomotor to automatically cause the shaft to rotate multiple times within 1/4th of a rotation, thus causing the machine to vibrate.

Execute Easy FFT after the servo is turned OFF if operation of the SERVOPACK results in high-frequency noise and vibration.

WARNING

- Never touch the Servomotor or machine during execution of Easy FFT. Doing so may result in injury.

CAUTION

- Use Easy FFT when the servo gain is low, such as in the initial stage of servo tuning. If you execute Easy FFT after you increase the gain, the machine may vibrate depending on the machine characteristics or gain balance.

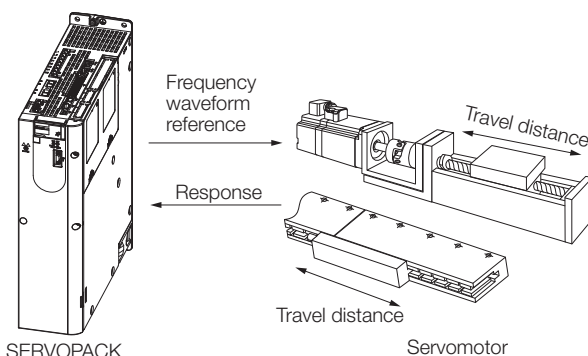

Easy FFT is built into the SERVOPACK for compatibility with previous products. Normally use autotuning without a host reference for tuning.

Preparations

Check the following settings before you execute Easy FFT.

- The parameters must not be write prohibited.
- The main circuit power supply must be ON.
- The test without a motor function must be disabled (Pn00C = n.□□□0).
- There must be no alarms.
- There must be no hard wire base block (HWBB).
- The servo must be OFF.
- There must be no overtravel.
- An external reference must not be input.

Applicable Tools

The following table lists the tools that you can use to perform EasyFFT.

Tool	Fn No./Function Name	Operating Procedure Reference
Digital Operator	Fn206	Σ-7-Series Digital Operator Operating Manual (Manual No.: SIEP S800001 33)
SigmaWin+	Diagnostic - Easy FFT	Operating Procedure on page 9-94

Operating Procedure

Use the following procedure for Easy FFT.

1. Click the  Servo Drive Button in the workspace of the Main Window of the SigmaWin+.
2. Select **Easy FFT** in the Menu Dialog Box.
The Easy FFT Dialog Box will be displayed.
Click the **Cancel** Button to cancel Easy FFT. You will return to the main window.
3. Click the **OK** Button.

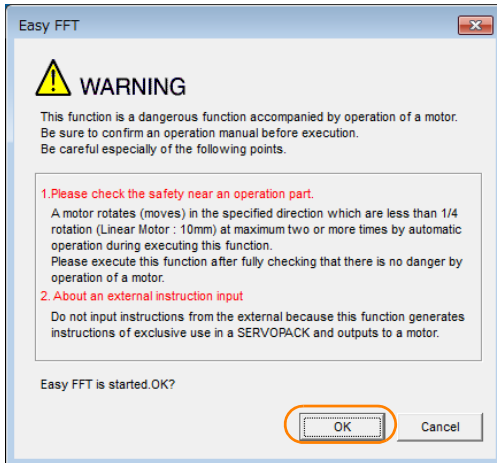

4. Click the **Servo ON** Button.

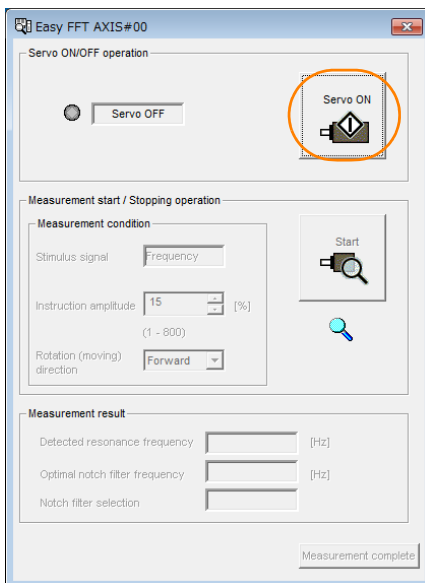

5. Select the instruction (reference) amplitude and the rotation direction in the **Measurement condition Area**, and then click the **Start Button**.

The motor shaft will rotate and measurements will start.

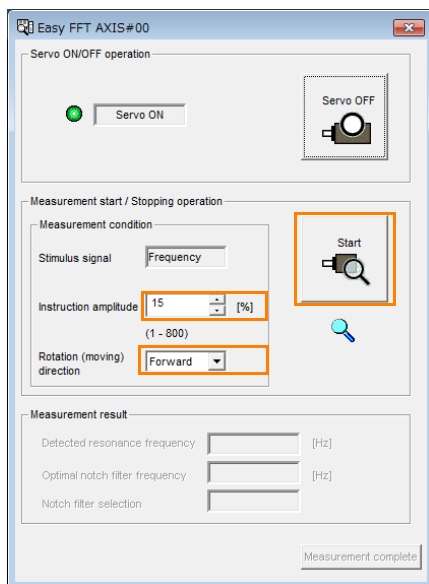

When measurements have been completed, the measurement results will be displayed.

6. Check the results in the **Measurement result Area** and then click the **Measurement complete Button**.

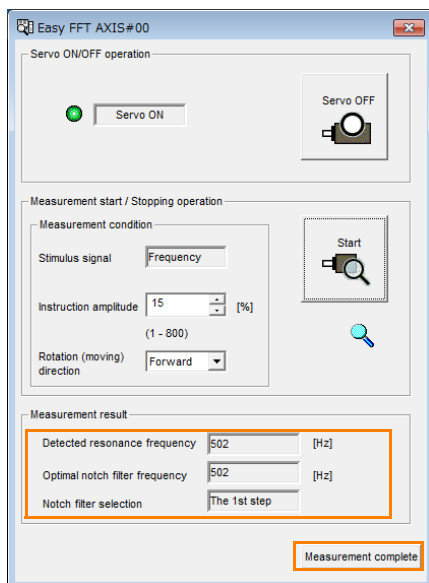

7. Click the **Result Writing** Button if you want to set the measurement results in the parameters.

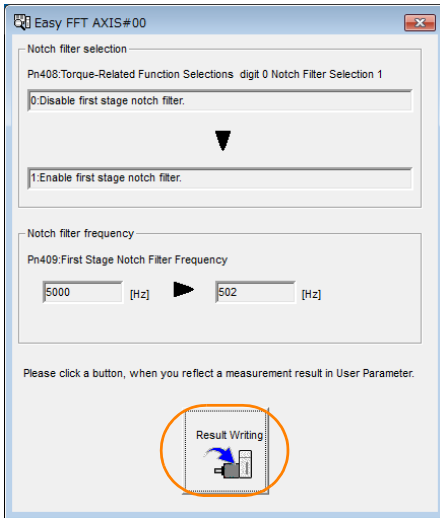

This concludes the procedure to set up Easy FFT.

Related Parameters

The following parameters are automatically adjusted or used as reference when you execute Easy FFT.

Do not change the settings of these parameters during execution of Easy FFT.

Parameter	Name	Automatic Changes
Pn408 (2408h)	Torque-Related Function Selections	Yes
Pn409 (2409h)	First Stage Notch Filter Frequency	Yes
Pn40A (240Ah)	First Stage Notch Filter Q Value	No
Pn40C (240Ch)	Second Stage Notch Filter Frequency	Yes
Pn40D (240Dh)	Second Stage Notch Filter Q Value	No
Pn456 (2456h)	Sweep Torque Reference Amplitude	No

Yes: The parameter is automatically set.

No: The parameter is not automatically set, but the setting is read during execution.

Monitoring

10

This chapter provides information on monitoring SERVO-
PACK product information and SERVOPACK status.

10.1	Monitoring Product Information	10-2
10.1.1	Items That You Can Monitor	10-2
10.1.2	Operating Procedures	10-2
10.2	Monitoring SERVOPACK Status	10-3
10.2.1	Servo Drive Status	10-3
10.2.2	Monitoring Operation, Status, and I/O	10-3
10.2.3	I/O Signals Status Monitor	10-5
10.3	Monitoring Machine Operation Status and Signal Waveforms	10-7
10.3.1	Items That You Can Monitor	10-7
10.3.2	Using the SigmaWin+	10-8
10.3.3	Using a Measuring Instrument	10-10
10.4	Monitoring Product Life	10-14
10.4.1	Items That You Can Monitor	10-14
10.4.2	Operating Procedure	10-15
10.4.3	Preventative Maintenance	10-15
10.5	Alarm Tracing	10-17
10.5.1	Data for Which Alarm Tracing Is Performed	10-17
10.5.2	Applicable Tools	10-17

10.1 Monitoring Product Information

10.1.1 Items That You Can Monitor

Monitor Items	
Information on SERVOPACKs	<ul style="list-style-type: none"> • Model/Type • Serial Number • Manufacturing Date • Software version (SW Ver.) • Remarks
Information on Servomotors	<ul style="list-style-type: none"> • Model/Type • Serial Number • Manufacturing Date • Remarks
Information on Encoders	<ul style="list-style-type: none"> • Model/Type • Serial Number • Manufacturing Date • Software version (SW Ver.) • Remarks

10.1.2 Operating Procedures

Use the following procedure to display the Servo Drive product information.

- Select **Read Product Information** in the Menu Dialog Box of the SigmaWin+. The Read Product Information Window will be displayed.

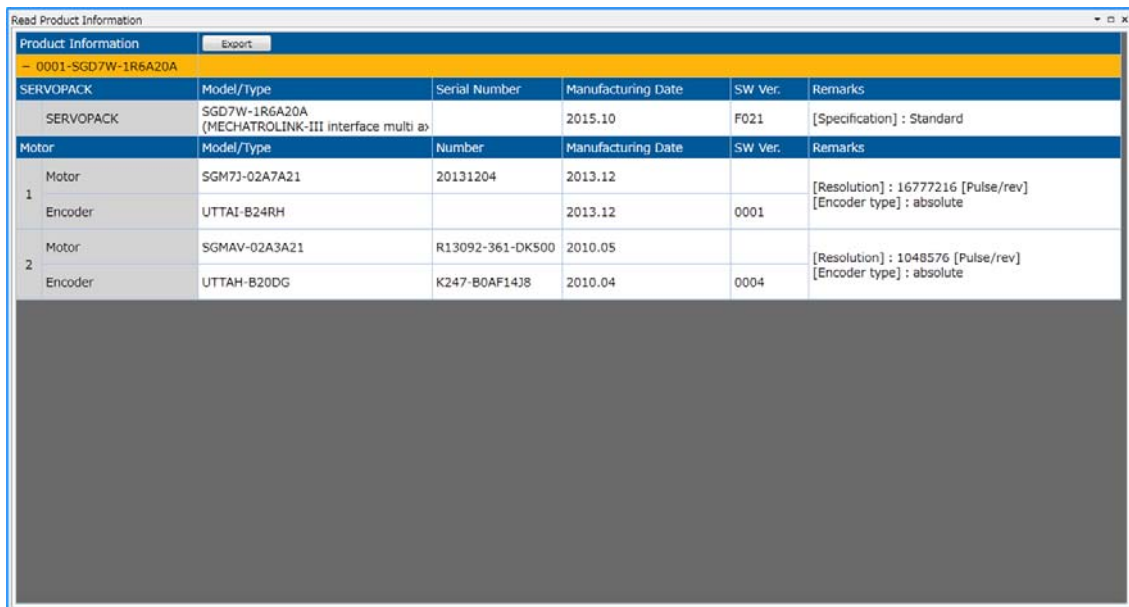

Information With the Digital Operator, you can use Fn011, Fn012, and Fn01E to monitor this information. Refer to the following manual for the differences in the monitor items compared with the SigmaWin+.

Σ-7-Series Digital Operator Operating Manual (Manual No.: SIEP S800001 33)

10.2 Monitoring SERVOPACK Status

10.2.1 Servo Drive Status

Use the following procedure to display the Servo Drive status.

- Start the SigmaWin+. The Servo Drive status will be automatically displayed when you go online with a SERVOPACK.

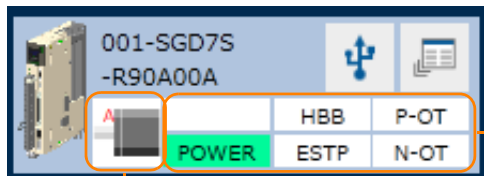

The Servo Drive status is displayed.

The Servomotor type is displayed.

10.2.2 Monitoring Operation, Status, and I/O

Items That You Can Monitor

The items that you can monitor on the Operation Pane, Status Pane, and I/O Pane are listed below.

- Operation Pane

Monitor Items	
<ul style="list-style-type: none"> • Motor Speed • Speed Reference • Internal Torque Reference • Angle of Rotation 1 (number of encoder pulses from origin within one encoder rotation) • Angle of Rotation 2 (angle from origin within one encoder rotation) • Input Reference Pulse Speed • Deviation Counter (Position Deviation) • Cumulative Load • Regenerative Load • DB Resistor Consumption Power • Absolute Encoder Multiturn Data • Absolute Encoder Position within One Rotation • Lower Bits of Absolute Encoder Position • Upper Bits of Absolute Encoder Position • Reference Pulse Counter • Feedback Pulse Counter • Fully Closed Feedback Pulse Counter • Total Operating Time • Current Backlash Compensation Value • Backlash Compensation Value Setting Limit • Position Amplifier Deviation • Feedback Position (APOS) • Current Reference Position (CPOS) • Position Deviation (PERR) 	<ul style="list-style-type: none"> • Target Position (TPOS) • Latched Position 1 (LPOS1) • Latched Position 2 (LPOS2) • Latched Position 3 (LPOS3) • Target Speed (TSPD) • Feedback Speed (FSPD) • Current Position Command Speed (CSPD) • Torque Limit (TRQ_LIM) • Speed Limit (SPD_LIM) • 6041h: Statusword • 6061h: Modes of operation display • 6062h: Position demand value • 6063h: Position actual internal value • 6064h: Position actual value • 606Bh: Velocity demand value • 606Ch: Velocity actual value • 6074h: Torque demand value • 60B9h: Touch probe status • 60BAh: Touch probe 1 position value • 60BCh: Touch probe 2 position value • 60F4h: Following error actual value • 60FCh: Position demand internal value • 1C32h, 01: Synchronization type • 1C32h, 02: Cycle time • 1C32h, 12: SM2 event miss count

• Status Pane

Monitor Items	
<ul style="list-style-type: none"> • Polarity Sensor Signal Monitor • Active Gain Monitor • Main Circuit • Encoder (PGRDY) • Motor Power (Request) • Motor Power ON • Dynamic Brake (DB) • Rotation (Movement) Direction • Mode Switch • Speed Reference • Torque Reference • Position Reference (PULS) 	<ul style="list-style-type: none"> • Position Reference Direction • Surge Current Limiting Resistor Short Relay • Regenerative Transistor • Regenerative Error Detection • AC Power ON • Overcurrent • Origin Not Passed • Moment of Inertia Identification • Polarity Detection in Progress • Completion of Polarity Detection • Ripple Compensation in Progress

• I/O Pane

Monitor Items	
<p style="writing-mode: vertical-rl; transform: rotate(180deg);">Input Signal Status</p> <ul style="list-style-type: none"> • /P-CON (Proportional Control Input Signal) • P-OT (Forward Drive Prohibit Input Signal) • N-OT (Reverse Drive Prohibit Input Signal) • /P-CL (Forward External Torque Limit Signal) • /N-CL (Reverse External Torque Limit Signal) • /ALM-RST (Alarm Reset Input Signal) • /Probe1 (Probe 1 Latch Input Signal) • /Probe2 (Probe 2 Latch Input Signal) • /Home (Home Switch Input Signal) • FSTP (Forced Stop Input Signal) • /DBANS (Dynamic Brake Answer Input Signal) 	<p style="writing-mode: vertical-rl; transform: rotate(180deg);">Output Signal Status</p> <ul style="list-style-type: none"> • ALM (Servo Alarm Output Signal) • /COIN (Positioning Completion Output Signal) • /V-CMP (Speed Coincidence Detection Output Signal) • /TGON (Rotation Detection Output Signal) • /S-RDY (Servo Ready Output Signal) • /CLT (Torque Limit Detection Signal) • /VLT (Speed Limit Detection Output Signal) • /BK (Brake Output Signal) • /WARN (Warning Output Signal) • /NEAR (Near Output Signal) • PAO (Encoder Divided Pulse Output Phase A Signal) • PBO (Encoder Divided Pulse Output Phase B Signal) • PCO (Encoder Divided Pulse Output Phase C Signal) • /PM (Preventative Maintenance Output Signal) • /DBON (Dynamic Brake Operation Request Output Signal)

Operating Procedure

Use the following procedure to display the Operation Monitor, Status Monitor, and I/O Monitor for the SERVOPACK.

- Select **Monitor** in the SigmaWin+ Menu Dialog Box. The Operation Pane, Status Pane, and I/O Pane will be displayed in the Monitor Window.

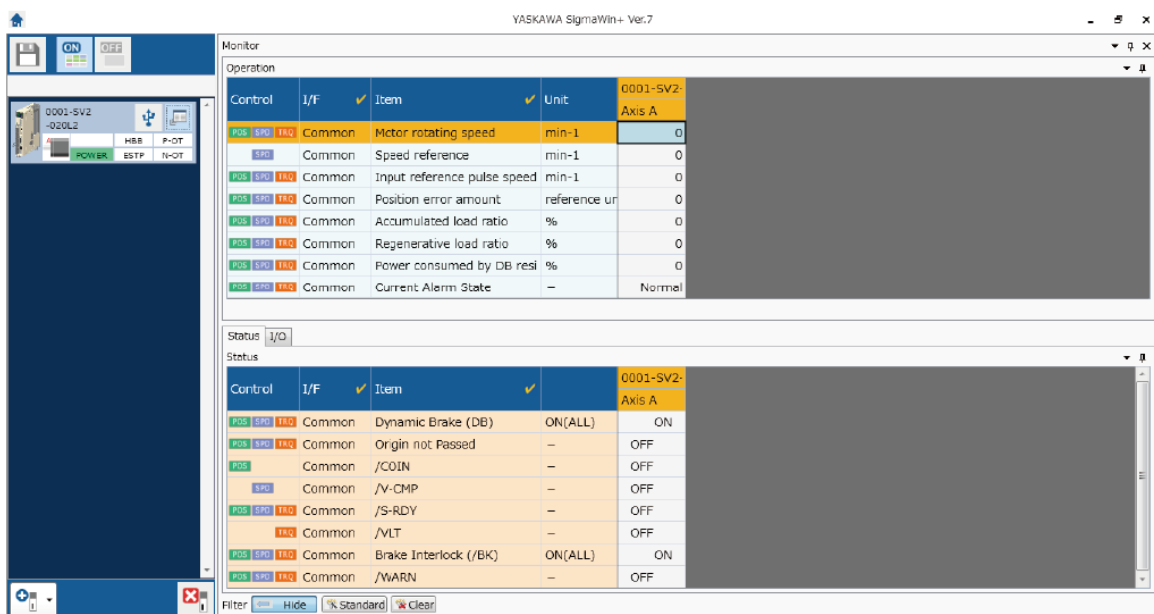

Information You can flexibly change the contents that are displayed in the Monitor Window. Refer to the following manual for details.
 📖 *Engineering Tool SigmaWin+ Operation Manual* (Manual No.: SIET S800001 34)

10.2.3 I/O Signals Status Monitor

Use the following procedure to check the status of the I/O signals.

1. Click the  Servo Drive Button in the workspace of the Main Window of the SigmaWin+.
2. Select **I/O Signal Allocation** in the Menu Dialog Box. The I/O Signal Allocation Window will be displayed.
3. Click the **Input Signal** Tab.

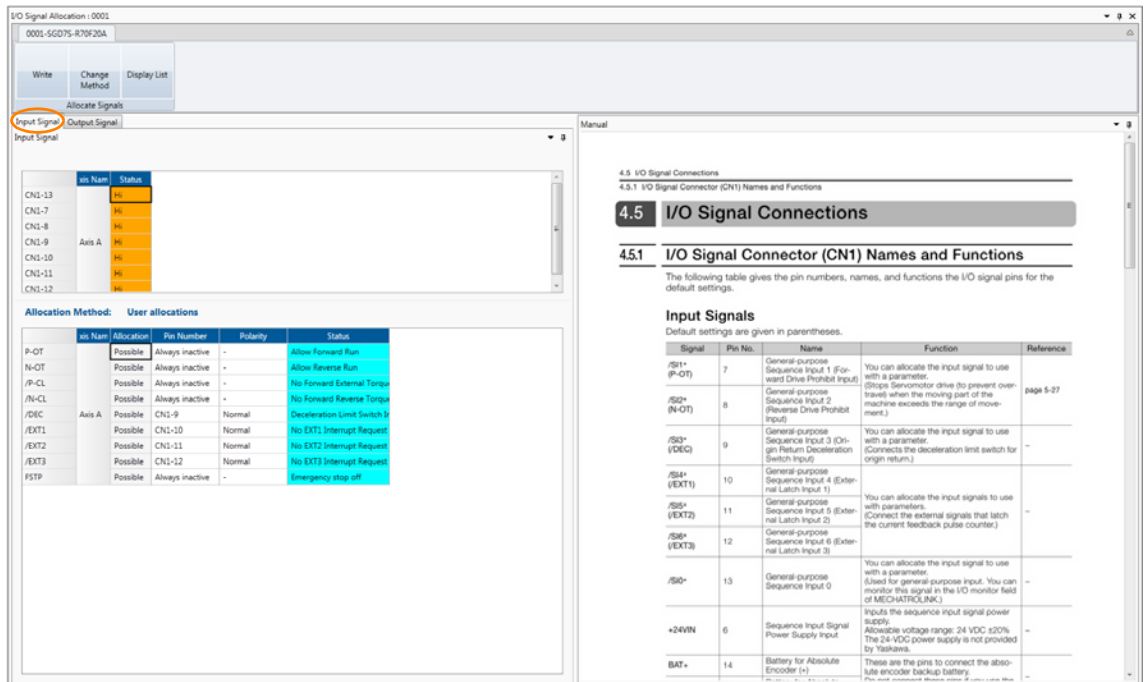

The screenshot shows the 'I/O Signal Allocation : 0001' window for device '0001-SGD7S-R70F2DA'. The 'Input Signal' tab is selected, showing a table of input signals for Axis A. A red circle highlights the 'Input Signal' tab label. To the right, a manual page titled '4.5 I/O Signal Connections' is visible, with a sub-section '4.5.1 I/O Signal Connector (CN1) Names and Functions'. Below this, a table lists 'Input Signals' with columns for Signal, Pin No., Name, Function, and Reference.

Signal	Pin No.	Name	Function	Reference
/SI1+ (P-OT)	7	General-purpose Sequence Input 1 (Forward Drive Prohibit Input)	You can allocate the input signal to use with a parameter. (Stops Servomotor drive (to prevent over-travel) when the moving part of the machine exceeds the range of movement.)	page 5-27
/SI2* (N-OT)	8	General-purpose Sequence Input 2 (Reverse Drive Prohibit Input)		
/SI3* (VDEC)	9	General-purpose Sequence Input 3 (Origin Return Deceleration Switch Input)	You can allocate the input signal to use with a parameter. (Connects the deceleration limit switch for origin return.)	
/SI4+ (EXT1)	10	General-purpose Sequence Input 4 (External Latch Input 1)		
/SI5* (EXT2)	11	General-purpose Sequence Input 5 (External Latch Input 2)	You can allocate the input signals to use with parameters. (Connect the external signals that latch the current feedback pulse counter.)	
/SI6* (EXT3)	12	General-purpose Sequence Input 6 (External Latch Input 3)		
/SI0-	13	General-purpose Sequence Input 0	You can allocate the input signal to use with a parameter. (Used for general-purpose input. You can monitor this signal in the I/O monitor field of MECHATROLINK.)	
+24VIN	6	Sequence Input Signal Power Supply Input	Inputs the sequence input signal power supply. Allowable voltage range: 24 VDC ±20%. The 24-VDC power supply is not provided by Yaskawa.	
BAT+	14	Battery for Absolute Encoder (+)	These are the pins to connect the absolute encoder backup battery. (Pin 14 and external backup battery.)	

Check the status of the input signals.

4. Click the **Output Signal** Tab.

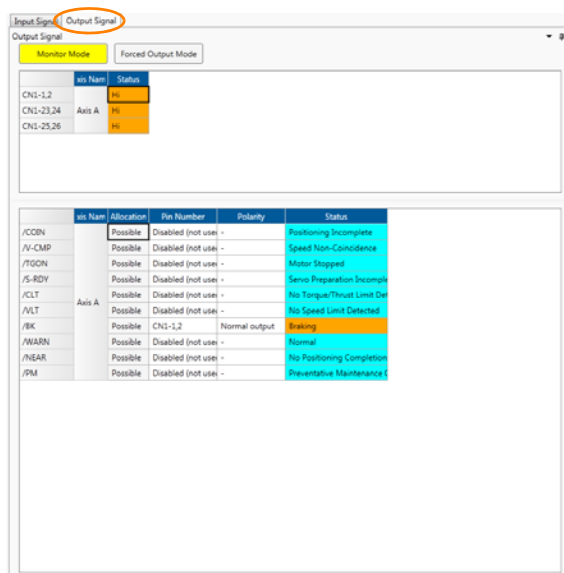

The screenshot shows the 'Output Signal' tab selected in the 'I/O Signal Allocation' window. It displays a table of output signals for Axis A. A red circle highlights the 'Output Signal' tab label. The table lists various output signals such as /CCDN, /V-CMP, /TGON, /S-RDY, /CLT, /VLT, /BK, /WARN, /NEAR, and /PM, along with their allocation, pin numbers, polarities, and current status.

Signal	Allocation	Pin Number	Polarity	Status
/CCDN	Possible	Disabled (not use)	-	Positioning Incomplete
/V-CMP	Possible	Disabled (not use)	-	Speed Non-Coincidence
/TGON	Possible	Disabled (not use)	-	Motor Stopped
/S-RDY	Possible	Disabled (not use)	-	Servo Preparation Incomplete
/CLT	Possible	Disabled (not use)	-	No Torque/Thrust Limit Det
/VLT	Possible	Disabled (not use)	-	No Speed Limit Detected
/BK	Possible	CN1-1,2	Normal output	Braking
/WARN	Possible	Disabled (not use)	-	Normal
/NEAR	Possible	Disabled (not use)	-	No Positioning Completion
/PM	Possible	Disabled (not use)	-	Preventative Maintenance

Check the status of the output signals.

Information

You can also use the above window to check wiring.

- Checking Input Signal Wiring

Change the signal status at the host controller. If the input signal status on the window changes accordingly, then the wiring is correct.

- Checking Output Signal Wiring

Click the **Force Output Mode** Button. This will force the output signal status to change. If the signal status at the host controller changes accordingly, then the wiring is correct.

You cannot use the **Force Output Mode** Button while the servo is ON.

For details, refer to the following manual.

 AC Servo Drive Engineering Tool SigmaWin+ Operation Manual (Manual No.: SIET S800001 34)

10.3 Monitoring Machine Operation Status and Signal Waveforms

To monitor waveforms, use the SigmaWin+ trace function or a measuring instrument, such as a memory recorder.

10.3.1 Items That You Can Monitor

You can use the SigmaWin+ or a measuring instrument to monitor the shaded items in the following block diagram.

- Rotary Servomotors

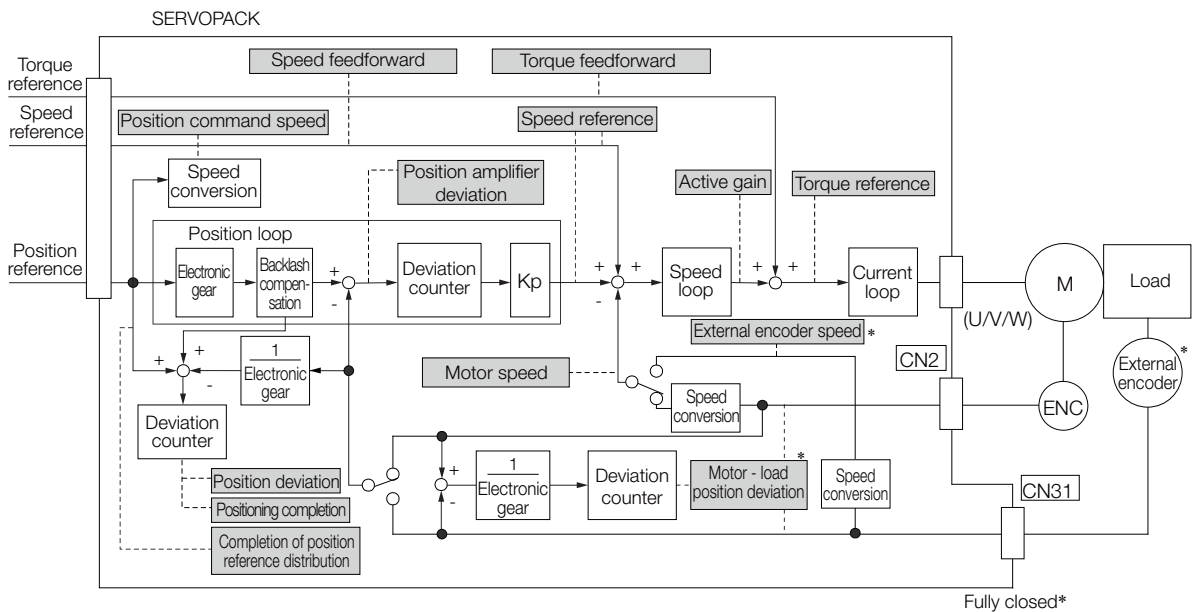

* This speed is available when fully-closed loop control is being used.

- Linear Servomotors

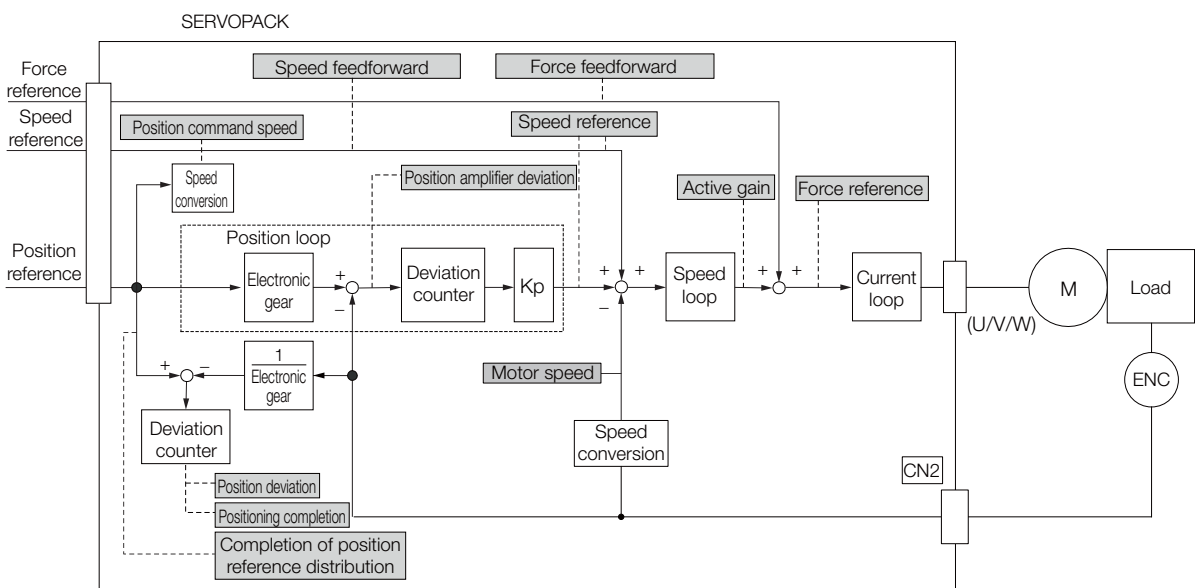

10.3.2 Using the SigmaWin+

This section describes how to trace data and I/O with the SigmaWin+.

Refer to the following manual for detailed operating procedures for the SigmaWin+.

Engineering Tool SigmaWin+ Operation Manual (Manual No.: SIET S800001 34)

Operating Procedure

1. Click the Servo Drive Button in the workspace of the Main Window of the SigmaWin+.
2. Select Trace in the Menu Dialog Box.
The Trace Dialog Box will be displayed.

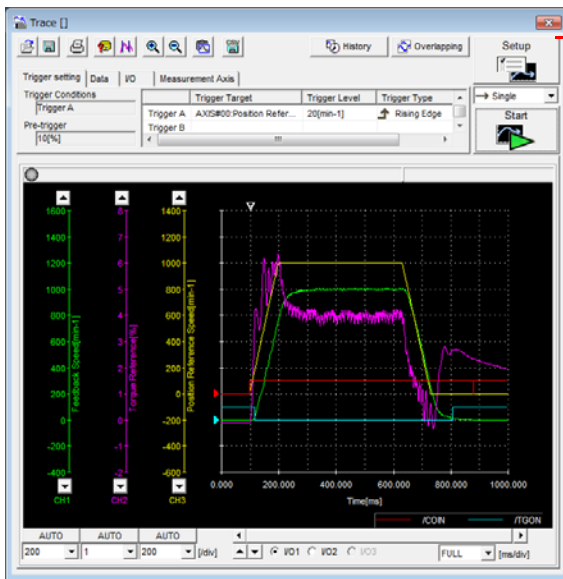

Click this button to display the Trace Setting Dialog Box shown below, and set the data to trace and the trace conditions.

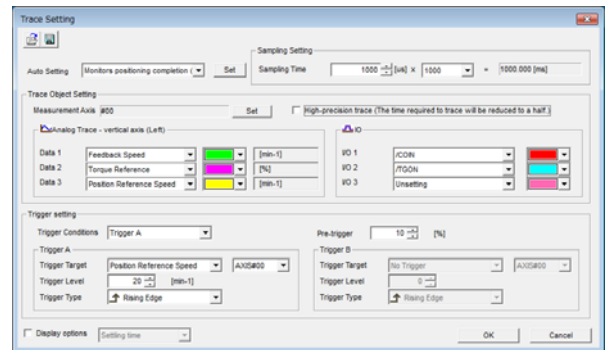

Trace Objects

You can trace the following items.

- Data Tracing

Trace Objects	
<ul style="list-style-type: none"> • Torque Reference • Feedback Speed • Reference Speed • Position Reference Speed • Position Error (Deviation) • Position Amplifier Error (Deviation) 	<ul style="list-style-type: none"> • Motor - Load Position Deviation • Speed Feedforward • Torque Feedforward • Effective (Active) Gain • Main Circuit DC Voltage

• I/O Tracing

Trace Objects				
Input Signals	<ul style="list-style-type: none"> • /P-CON (Proportional Control Input Signal) • P-OT (Forward Drive Prohibit Input Signal) • N-OT (Reverse Drive Prohibit Input Signal) • /ALM-RST (Alarm Reset Input Signal) • /P-CL (Forward External Torque/Force Limit Input Signal) • /N-CL (Reverse External Torque/Force Limit Input Signal) • /Probe1 (Probe 1 Latch Input Signal) • /Probe2 (Probe 2 Latch Input Signal) • /Home (Home Switch Input Signal) • FSTP (Forced Stop Input Signal) • /HWBB1 (Hard Wire Base Block Input 1 Signal) • /HWBB2 (Hard Wire Base Block Input 2 Signal) • /DBANS (Dynamic Brake Answer Input Signal) 			
	<table border="1"> <tr> <td>Output Signals</td> <td> <ul style="list-style-type: none"> • ALM (Servo Alarm Output Signal) • /COIN (Positioning Completion Output Signal) • /V-CMP (Speed Coincidence Detection Output Signal) • /TGON (Rotation Detection Output Signal) • /S-RDY (Servo Ready Output Signal) • /CLT (Torque Limit Detection Output Signal) • /VLT (Speed Limit Detection Output Signal) • /BK (Brake Output Signal) • /WARN (Warning Output Signal) • /NEAR (Near Output Signal) • PAO (Encoder Divided Pulse Output Phase A Signal) • PBO (Encoder Divided Pulse Output Phase B Signal) • PCO (Encoder Divided Pulse Output Phase C Signal) • /DBON (Dynamic Brake Operation Request Output Signal) </td> </tr> <tr> <td>Internal Status</td> <td> <ul style="list-style-type: none"> • ACON (Main Circuit ON Signal) • PDETCMP (Polarity Detection Completed Signal) • DEN (Position Reference Distribution Completed Signal) </td> </tr> </table>	Output Signals	<ul style="list-style-type: none"> • ALM (Servo Alarm Output Signal) • /COIN (Positioning Completion Output Signal) • /V-CMP (Speed Coincidence Detection Output Signal) • /TGON (Rotation Detection Output Signal) • /S-RDY (Servo Ready Output Signal) • /CLT (Torque Limit Detection Output Signal) • /VLT (Speed Limit Detection Output Signal) • /BK (Brake Output Signal) • /WARN (Warning Output Signal) • /NEAR (Near Output Signal) • PAO (Encoder Divided Pulse Output Phase A Signal) • PBO (Encoder Divided Pulse Output Phase B Signal) • PCO (Encoder Divided Pulse Output Phase C Signal) • /DBON (Dynamic Brake Operation Request Output Signal) 	Internal Status
Output Signals	<ul style="list-style-type: none"> • ALM (Servo Alarm Output Signal) • /COIN (Positioning Completion Output Signal) • /V-CMP (Speed Coincidence Detection Output Signal) • /TGON (Rotation Detection Output Signal) • /S-RDY (Servo Ready Output Signal) • /CLT (Torque Limit Detection Output Signal) • /VLT (Speed Limit Detection Output Signal) • /BK (Brake Output Signal) • /WARN (Warning Output Signal) • /NEAR (Near Output Signal) • PAO (Encoder Divided Pulse Output Phase A Signal) • PBO (Encoder Divided Pulse Output Phase B Signal) • PCO (Encoder Divided Pulse Output Phase C Signal) • /DBON (Dynamic Brake Operation Request Output Signal) 			
Internal Status	<ul style="list-style-type: none"> • ACON (Main Circuit ON Signal) • PDETCMP (Polarity Detection Completed Signal) • DEN (Position Reference Distribution Completed Signal) 			

10.3.3 Using a Measuring Instrument

Connect a measuring instrument, such as a memory recorder, to the analog monitor connector (CN5) on the SERVOPACK to monitor analog signal waveforms. The measuring instrument is not provided by Yaskawa.

Refer to the following section for details on the connection.

 4.8.3 Analog Monitor Connector (CN5) on page 4-41

Setting the Monitor Object

Use Pn006 = n.□□XX and Pn007 = n.□□XX (Analog Monitor 1 and 2 Signal Selections) to set the items to monitor.

Line Color	Signal	Parameter Setting
White	Analog monitor 1	Pn006 (2006h) = n.□□XX
Red	Analog monitor 2	Pn007 (2007h) = n.□□XX
Black (2 lines)	GND	-

Parameter	Description			
	Monitor Signal	Output Unit	Remarks	
Pn006 (2006h) or Pn007 (2007h)	n.□□00 (default setting of Pn007 (2007h))	Motor Speed	<ul style="list-style-type: none"> Rotary Servomotor: 1 V/1,000 min⁻¹ Linear Servomotor: 1 V/1,000 mm/s 	-
	n.□□01	Speed Reference	<ul style="list-style-type: none"> Rotary Servomotor: 1 V/1,000 min⁻¹ Linear Servomotor: 1 V/1,000 mm/s 	-
	n.□□02 (default setting of Pn006 (2006h))	Torque Reference	1 V/100% rated torque	-
	n.□□03	Position Deviation	0.05 V/Reference unit	0 V for speed or torque control
	n.□□04	Position Amplifier Deviation	0.05 V/encoder pulse unit	Position deviation after electronic gear conversion
	n.□□05	Position Command Speed	<ul style="list-style-type: none"> Rotary Servomotor: 1 V/1,000 min⁻¹ Linear Servomotor: 1 V/1,000 mm/s 	-
	n.□□06	Reserved parameter (Do not change.)	-	-
	n.□□07	Motor - Load Position Deviation	0.01 V/Reference unit	-
	n.□□08	Positioning Completion	Positioning completed: 5 V Positioning not completed: 0 V	Completion is indicated by the output voltage.
	n.□□09	Speed Feedforward	<ul style="list-style-type: none"> Rotary Servomotor: 1 V/1,000 min⁻¹ Linear Servomotor: 1 V/1,000 mm/s 	-
	n.□□0A	Torque Feedforward	1 V/100% rated torque	-
	n.□□0B	Active Gain*	1st gain: 1 V 2nd gain: 2 V	The gain that is active is indicated by the output voltage.
	n.□□0C	Completion of Position Reference Distribution	Distribution completed: 5 V Distribution not completed: 0 V	Completion is indicated by the output voltage.
	n.□□0D	External Encoder Speed	1 V/1,000 min ⁻¹	Value calculated at the motor shaft
n.□□10	Main Circuit DC Voltage	1 V/100 V (main circuit DC voltage)	-	

* Refer to the following section for details.

 9.12.1 Gain Switching on page 9-65

Changing the Monitor Factor and Offset

You can change the monitor factors and offsets for the output voltages for analog monitor 1 and analog monitor 2. The relationships to the output voltages are as follows:

$$\text{Analog monitor 1 output voltage} = (-1) \times \left\{ \begin{array}{l} \text{Analog Monitor 1 Signal} \\ \text{Selection (Pn006 = n.}\square\square\text{XX)} \end{array} \times \begin{array}{l} \text{Analog Monitor 1} \\ \text{Magnification (Pn552)} \end{array} + \begin{array}{l} \text{Analog Monitor 1} \\ \text{Offset Voltage (Pn550)} \end{array} \right\}$$

$$\text{Analog monitor 2 output voltage} = (-1) \times \left\{ \begin{array}{l} \text{Analog Monitor 2 Signal} \\ \text{Selection (Pn007 = n.}\square\square\text{XX)} \end{array} \times \begin{array}{l} \text{Analog Monitor 2} \\ \text{Magnification (Pn553)} \end{array} + \begin{array}{l} \text{Analog Monitor 2} \\ \text{Offset Voltage (Pn551)} \end{array} \right\}$$

The following parameters are set.

Pn550 (2550h)	Analog Monitor 1 Offset Voltage Speed Position Torque				
	Setting Range	Setting Unit	Default Setting	When Enabled	Classification
	-10,000 to 10,000	0.1 V	0	Immediately	Setup
Pn551 (2551h)	Analog Monitor 2 Offset Voltage Speed Position Torque				
	Setting Range	Setting Unit	Default Setting	When Enabled	Classification
	-10,000 to 10,000	0.1 V	0	Immediately	Setup
Pn552 (2552h)	Analog Monitor 1 Magnification Speed Position Torque				
	Setting Range	Setting Unit	Default Setting	When Enabled	Classification
	-10,000 to 10,000	x0.01	100	Immediately	Setup
Pn553 (2553h)	Analog Monitor 2 Magnification Speed Position Torque				
	Setting Range	Setting Unit	Default Setting	When Enabled	Classification
	-10,000 to 10,000	x0.01	100	Immediately	Setup

Example

- Example for Setting the Item to Monitor to the Motor Speed (Pn006 = n.□□00)

When Pn552 = 100 (Setting Unit: x0.01)

When Pn552 = 1,000 (Setting Unit: x0.01)

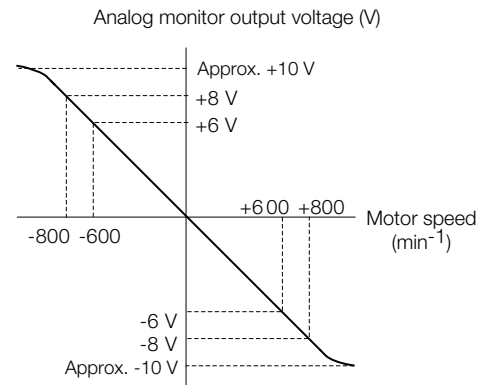
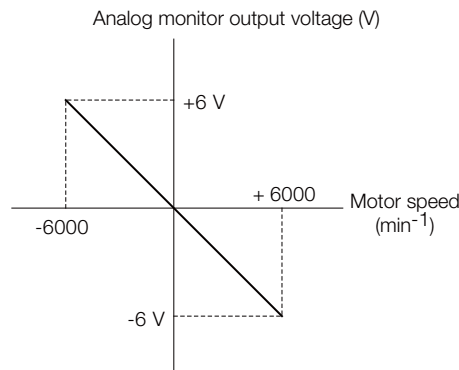

Note: The effective linearity range is ±8 V.
The resolution is 16 bits.

Adjusting the Analog Monitor Output

You can manually adjust the offset and gain for the analog monitor outputs for the torque reference monitor and motor speed monitor.

The offset is adjusted to compensate for offset in the zero point caused by output voltage drift or noise in the monitoring system.

The gain is adjusted to match the sensitivity of the measuring system.

The offset and gain are adjusted at the factory. You normally do not need to adjust them.

◆ Adjustment Example

An example of adjusting the output of the motor speed monitor is provided below.

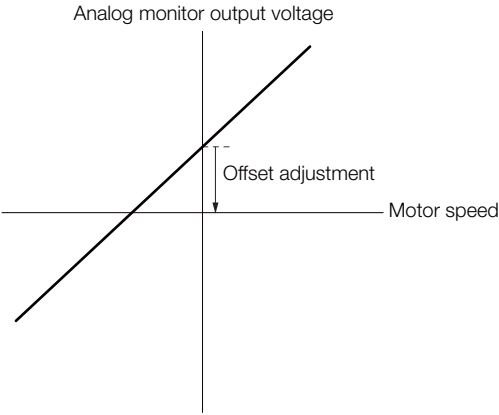
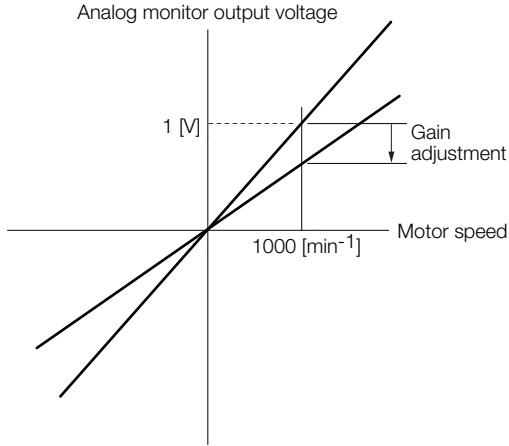
Offset Adjustment		Gain Adjustment	
			
Item	Specification	Item	Specification
Offset Adjustment Range	-2.4 V to 2.4 V	Gain Adjustment Range	100 ±50%
Adjustment Unit	18.9 mV/LSB	Adjustment Unit	0.4%/LSB

The gain adjustment range is made using a 100% output value (gain adjustment of 0) as the reference value with an adjustment range of 50% to 150%. A setting example is given below.

- Setting the Adjustment Value to -125
 $100 + (-125 \times 0.4) = 50$ [%]
 Therefore, the monitor output voltage goes to 50% of the original value.
- Setting the Adjustment Value to 125
 $100 + (125 \times 0.4) = 150$ [%]
 Therefore, the monitor output voltage goes to 150% of the original value.

- Information**
- The adjustment values do not use parameters, so they will not change even if the parameter settings are initialized.
 - Adjust the offset with the measuring instrument connected so that the analog monitor output value goes to zero. The following setting example achieves a zero output.
 - While power is not supplied to the Servomotor, set the monitor signal to the torque reference.
 - In speed control, set the monitor signal to the position deviation.

◆ Preparations



Confirm the following condition before you adjust the analog monitor output.

- The parameters must not be write prohibited.

◆ Applicable Tools

You can use the following tools to adjust analog monitor outputs.

- Offset Adjustment

Tool	Fn No./Function Name	Operating Procedure Reference
Digital Operator	Fn00C	 Σ-7-Series Digital Operator Operating Manual (Manual No.: SIEP S800001 33)
SigmaWin+	Others - Adjust the Analog Monitor Output	 ◆ Operating Procedure on page 10-13

- Gain Adjustment

Tool	Fn No./Function Name	Operating Procedure Reference
Digital Operator	Fn00D	Σ -7-Series Digital Operator Operating Manual (Manual No.: SIEP S800001 33)
SigmaWin+	<i>Others - Adjust the Analog Monitor Output</i>	◆ <i>Operating Procedure</i> on page 10-13

◆ Operating Procedure

Use the following procedure to adjust the analog monitor output.

1. Click the Servo Drive Button in the workspace of the Main Window of the SigmaWin+.
2. Select **Adjust the Analog Monitor Output** in the Menu Dialog Box.
The Adjust the Analog Monitor Output Dialog Box will be displayed.
3. Click the **Zero Adjustment** or **Gain Adjustment** Tab.

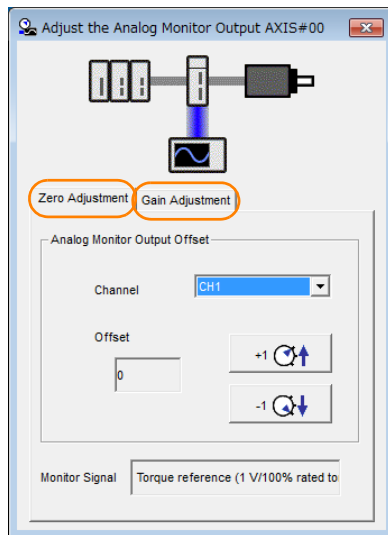



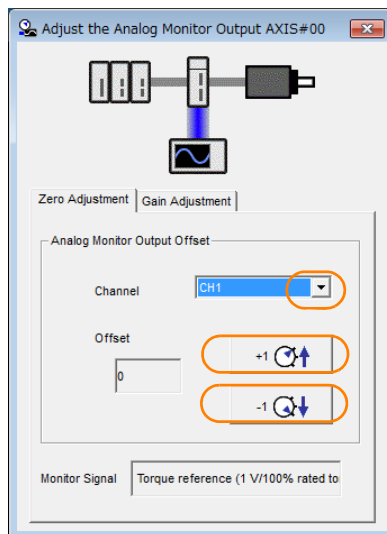

4. While watching the analog monitor, use the **+1** and **-1** Buttons to adjust the offset. There are two channels: CH1 and CH2. If necessary, click the down arrow on the **Channel** Box and select the channel.



This concludes adjusting the analog monitor output.

10.4 Monitoring Product Life

10.4.1 Items That You Can Monitor

Monitor Item	Description
SERVOPACK Installation Environment	The operating status of the SERVOPACK in terms of the installation environment is displayed. Implement one or more of the following actions if the monitor value exceeds 100%. <ul style="list-style-type: none"> • Lower the surrounding temperature. • Decrease the load.
Servomotor Installation Environment	The operating status of the SERVOPACK in terms of the installation environment is displayed. Implement one or more of the following actions if the monitor value exceeds 100%. <ul style="list-style-type: none"> • Lower the surrounding temperature. • Decrease the load.
Built-in Fan Service Life Prediction	The unused status of the SERVOPACK is treated as the 100% value. The value decreases each time the main circuit power supply is turned ON and each time the servo is turned OFF. Use a monitor value of 0% as a guideline for the replacement period. Refer to the following section for part replacement guidelines.  16.1.2 Guidelines for Part Replacement on page 16-2
Capacitor Service Life Prediction	The unused status of the SERVOPACK is treated as the 100% value. The value decreases each time the main circuit power supply is turned ON and each time the servo is turned OFF. Use a monitor value of 0% as a guideline for the replacement period. Refer to the following section for part replacement guidelines.  16.1.2 Guidelines for Part Replacement on page 16-2
Surge Prevention Circuit Service Life Prediction	The unused status of the SERVOPACK is treated as the 100% value. The value decreases each time the main circuit power supply is turned ON and each time the servo is turned OFF. Use a monitor value of 0% as a guideline for the replacement period. Refer to the following section for part replacement guidelines.  16.1.2 Guidelines for Part Replacement on page 16-2
Dynamic Brake Circuit Service Life Prediction	The unused status of the SERVOPACK is treated as the 100% value. The value decreases each time the main circuit power supply is turned ON and each time the servo is turned OFF. Use a monitor value of 0% as a guideline for the replacement period. Refer to the following section for part replacement guidelines.  16.1.2 Guidelines for Part Replacement on page 16-2
Built-in Brake Relay Service Life Prediction	The unused status of the built-in brake relay is treated as the 100% value. The value decreases based on the number of operations of the built-in brake relay. Use a monitor value of 0% as a guideline for the replacement period. Refer to the following section for part replacement guidelines.  16.1.2 Guidelines for Part Replacement on page 16-2

10.4.2 Operating Procedure

Use the following procedure to display the installation environment and service life prediction monitor dialog boxes.

1. Click the  Servo Drive Button in the workspace of the Main Window of the SigmaWin+.
2. Select **Life Monitor** in the Menu Dialog Box.
The Life Monitor Dialog Box will be displayed.

Information With the Digital Operator, you can use Un025 to Un02A to monitor this information.

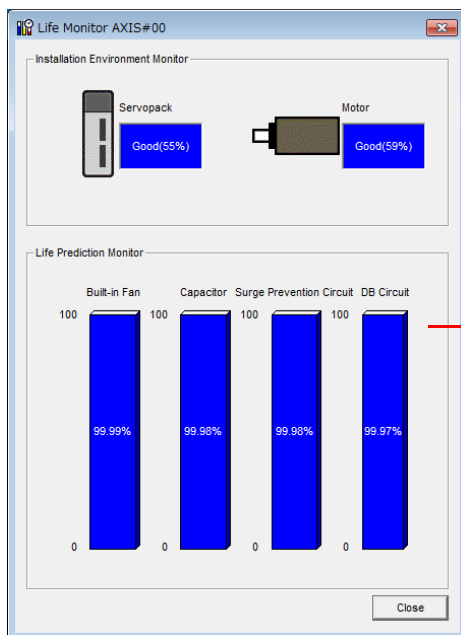

A value of 100% indicates that the SERVOPACK has not yet been used. The percentage decreases as the SERVOPACK is used and reaches 0% when it is time to replace the SERVOPACK.

10.4.3 Preventative Maintenance

You can use the following functions for preventative maintenance.

- Preventative maintenance warnings
- /PM (Preventative Maintenance Output) signal
- Built-in Brake Relay Life Alarm

The SERVOPACK can notify the host controller when it is time to replace any of the main parts.

Preventative Maintenance Warning

An A.9b0 warning (Preventative Maintenance Warning) is detected when any of the following service life prediction values drops to 10% or less: SERVOPACK built-in fan life, capacitor life, inrush current limiting circuit life, dynamic brake circuit life, and built-in brake relay life. You can change the setting of Pn00F = n.□□□X to enable or disable these warnings.

Parameter		Description	When Enabled	Classification
Pn00F (200Fh)	n.□□□0 (default setting)	Do not detect preventative maintenance warnings.	After restart	Setup
	n.□□□1	Detect preventative maintenance warnings.		

Note: Service life prediction of the built-in brake relay is performed as preventative maintenance for SERVOPACKs with built-in Servomotor brake control only when Pn023 is set to n.□□□0.

/PM (Preventative Maintenance Output) Signal

The /PM (Preventative Maintenance Output) signal is output when any of the following service life prediction values reaches 10% or less: SERVOPACK built-in fan life, capacitor life, inrush current limiting circuit life, dynamic brake circuit life, and built-in brake relay life. The /PM (Preventative Maintenance Output) signal must be allocated.

Even if detection of preventive maintenance warnings is disabled (Pn00F = n.□□□0), the /PM signal will still be output as long as it is allocated.

Classification	Signal	Connector Pin No.	Signal Status	Description
Output	/PM	Must be allocated.	ON (closed)	One of the following service life prediction values reached 10% or less: SERVOPACK built-in fan life, capacitor life, inrush current limiting circuit life, dynamic brake circuit life, and built-in brake relay life.
			OFF (open)	All of the following service life prediction values are greater than 10%: SERVOPACK built-in fan life, capacitor life, inrush current limiting circuit life, dynamic brake circuit life, and built-in brake relay life.

Note: You must allocate the /PM signal to use it. Use Pn514 = n.□□□X (/PM (Preventative Maintenance Output) Signal Allocation) to allocate the signal to connector pins. Refer to the following section for details.

 7.1.2 Output Signal Allocations on page 7-5

Built-in Brake Relay Life Alarm

A built-in brake relay life alarm (alarm code: 232h) is detected when the number of built-in brake relay operations has exceeded 30,000 operations. You can use Pn023 = n.□□X□ to enable or disable the built-in brake relay life alarm.

Parameter	Description	When Enabled	Classification
Pn023 (2023h)	n.□□0□ (default setting)	After restart	Setup
	n.□□1□		

Note: Built-in brake relay life alarm is used as preventative maintenance for SERVOPACKs with built-in Servomotor brake control only when Pn023 is set to n.□□□0.



Important Replace parts immediately after the number of built-in brake relay operations has exceeded 30,000 operations.

10.5 Alarm Tracing

Alarm tracing records data in the SERVOPACK from before and after an alarm occurs. This data helps you to isolate the cause of the alarm.

You can display the data recorded in the SERVOPACK as a trace waveform on the SigmaWin+.

Information

- Alarms that occur when the power supply is turned ON are not recorded.
- Alarms that occur during the recording of alarm trace data are not recorded.
- Alarms that occur while utility functions are being executed are not recorded.
- Alarms that occur while the data tracing function of the SigmaWin+ is being executed are not recorded.

10.5.1 Data for Which Alarm Tracing Is Performed

Two types of data are recorded for alarm tracing: numeric data and I/O signal ON/OFF data.

Numeric Data	ON/OFF Data
Torque reference	ALM
Feedback speed	Servo ON command (/S-ON)
Reference speed	Proportional control command (/P-CON)
Position command speed	Forward torque command (/P-CL)
Position deviation	Reverse torque command (/N-CL)
Load – motor position deviation	G-SEL1 signal (/G-SEL1)
Main circuit bus voltage	ACON

10.5.2 Applicable Tools

The following table lists the tools that you can use to perform alarm tracing.

Tool	Fn No./Function Name	Operating Procedure Reference
Digital Operator	You cannot display alarm tracing data from the Digital Operator.	
SigmaWin+	<i>Troubleshooting - Alarm Trace</i>	 Engineering Tool SigmaWin+ Operation Manual (Manual No.: SIET S800001 34)

Fully-Closed Loop Control

11

This chapter provides detailed information on performing fully-closed loop control with the SERVOPACK.

11.1	Fully-Closed System	11-2
11.2	SERVOPACK Commissioning Procedure	11-3
11.3	Parameter and Object Settings for Fully-closed Loop Control	11-5
11.3.1	Control Block Diagram for Fully-Closed Loop Control	11-5
11.3.2	Setting the Motor Direction and the Machine Movement Direction	11-6
11.3.3	Setting the Number of External Encoder Scale Pitches	11-7
11.3.4	Setting the PAO, PBO, and PCO (Encoder Divided Pulse Output) Signals	11-7
11.3.5	External Absolute Encoder Data Reception Sequence	11-8
11.3.6	Setting Unit Systems	11-8
11.3.7	Alarm Detection Settings	11-8
11.3.8	Analog Monitor Signal Settings	11-9
11.3.9	Setting to Use an External Encoder for Speed Feedback	11-9
11.4	Monitoring an External Encoder	11-10
11.4.1	Option Module Required for Monitoring	11-10
11.4.2	Block Diagrams	11-10

11.1 Fully-Closed System

With a fully-closed system, an externally installed encoder is used to detect the position of the controlled machine and the machine's position information is fed back to the SERVOPACK. High-precision positioning is possible because the actual machine position is fed back directly. With a fully-closed system, looseness or twisting of mechanical parts may cause vibration or oscillation, resulting in unstable positioning.

The following figure shows an example of the system configuration.

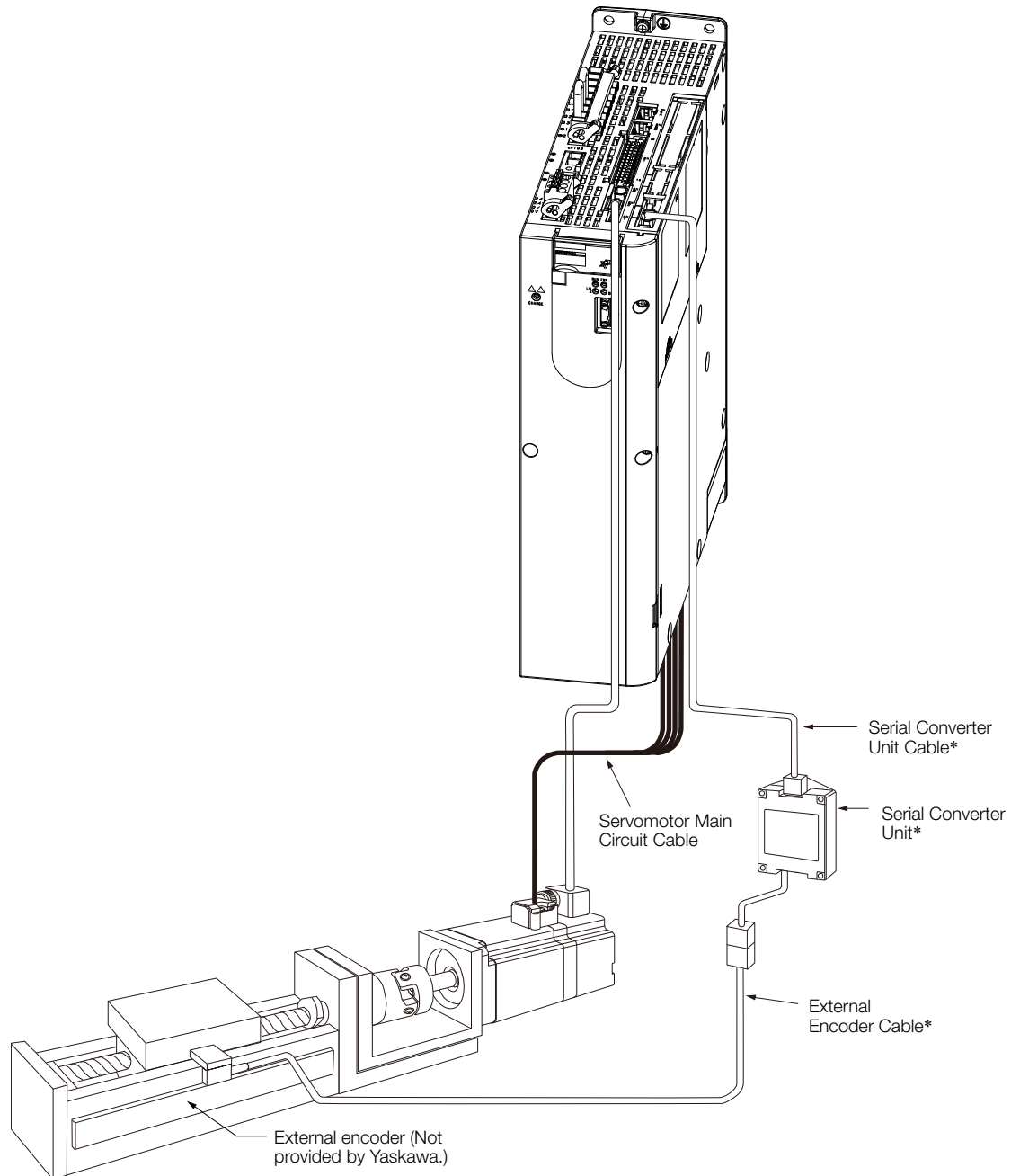

* The connected devices and cables depend on the type of external linear encoder that is used.

Note: Refer to the following section for details on connections that are not shown above, such as connections to power supplies and peripheral devices.

 2.4 Examples of Standard Connections between SERVOPACKs and Peripheral Devices on page 2-18

11.2 SERVOPACK Commissioning Procedure

First, confirm that the SERVOPACK operates correctly with semi-closed loop control, and then confirm that it operates correctly with fully-closed loop control. The commissioning procedure for the SERVOPACK for fully-closed loop control is given below.

Step	Description	Operation	Required Parameter and Object Settings	Controlling Device
1	<p>Check operation of the entire sequence with semi-closed loop control and without a load.</p> <p>Items to Check</p> <ul style="list-style-type: none"> • Power supply circuit wiring • Servomotor wiring • Encoder wiring • Wiring of I/O signal lines from the host controller • Servomotor rotation direction, motor speed, and multiturn data • Operation of safety mechanisms, such as the brakes and the overtravel mechanisms 	<p>Set the parameters so that the SERVOPACK operates correctly in semi-closed loop control without a load and check the following points. Set Pn002 to n.0□□□ to specify semi-closed loop control.</p> <ul style="list-style-type: none"> • Are there any errors in the SERVOPACK? • Does jogging function correctly when you operate the SERVOPACK without a load? • Do the I/O signals turn ON and OFF correctly? • Is power supplied to the Servomotor when the Servo ON command (Enable Operation command) is sent from the host controller? • Does the Servomotor operate correctly when a position reference is input by the host controller? 	<ul style="list-style-type: none"> • Pn000 (Basic Function Select Switch 0) • Pn001 (Basic Function Select Switch 1) • Pn002 = n.X□□□ (External Encoder Usage) • Position reference unit (<i>position user unit</i> (2701h)) • Pn50A, Pn50B, Pn511, and Pn516 (Input Signal Selections) • Pn50E, Pn50F, Pn510, and Pn514 (Output Signal Selections) 	SERVOPACK or host controller
2	<p>Check operation with the Servomotor connected to the machine with semi-closed loop control.</p> <p>Items to Check</p> <ul style="list-style-type: none"> • Initial response of the system connected to the machine • Movement direction, travel distance, and movement speed as specified by the references from the host controller 	<p>Connect the Servomotor to the machine. Set the moment of inertia ratio in Pn103 using autotuning without a host reference. Check that the machine's movement direction, travel distance, and movement speed agree with the references from the host controller.</p>	Pn103 (Moment of Inertia Ratio)	Host controller
3	<p>Check the external encoder.</p> <p>Items to Check</p> <ul style="list-style-type: none"> • Is the signal from the external encoder received correctly? 	<p>Set the parameters related to fully-closed loop control and move the machine with your hand without turning ON the power supply to the Servomotor. Check the following status with the Digital Operator or SigmaWin+.</p> <ul style="list-style-type: none"> • Does the fully-closed feedback pulse counter count up when the Servomotor moves in the forward direction? • Is the travel distance of the machine visually about the same as the amount counted by the fully-closed feedback pulse counter? <p>Note: The unit for the fully-closed feedback pulse counter is pulses, which is equivalent to the external encoder sine wave pitch.</p>	<ul style="list-style-type: none"> • Pn002 = n.X□□□ (External Encoder Usage) • Pn20A (Number of External Scale Pitches) • Position reference unit (<i>position user unit</i> (2701h)) • Pn281 (Encoder Output Resolution) • Pn51B (Excessive Error Level between Servomotor and Load Positions) • Pn522 (Positioning Completed Width) • Pn52A (Multiplier per One Fully-closed Rotation) 	–

Continued on next page.

Continued from previous page.

Step	Description	Operation	Required Parameter and Object Settings	Controlling Device
4	Perform a program jogging operation. Items to Check Does the fully-closed system operate correctly for the SERVOPACK without a load?	Perform a program jogging operation and confirm that the travel distance is the same as the reference value in Pn531. When you perform program jogging, start from a low speed and gradually increase the speed.	Pn530 to Pn536 (program jogging-related parameters)	SERVO-PACK
5	Operate the SERVOPACK. Items to Check Does the fully-closed system operate correctly, including the host controller?	Input a position reference and confirm that the SERVOPACK operates correctly. Start from a low speed and gradually increase the speed.	-	Host controller

11.3 Parameter and Object Settings for Fully-closed Loop Control

This section describes the parameter settings that are related to fully-closed loop control.

Parameter and Object to Set	Setting	Position Control	Speed Control	Torque Control	Reference
Pn000 (2000h) = n.□□□X	Motor direction	√	√	√	page 11-6
Pn002 (2002h) = n.X□□□	External encoder usage method	√	√	√	
Pn20A (220Ah)	Number of external scale pitches	√	√	√	page 11-7
Pn281 (2281h)	Encoder divided pulse output signals (PAO, PBO, and PCO) from the SERVO-PACK	√	√	√	page 11-7
-	External absolute encoder data reception sequence	√	√	√	page 7-42
Position User Unit (2701h)	Electronic gear ratio	√	-	-	page 6-42
Pn51B (251Bh)	Excessive deviation level between Servomotor and load positions	√	-	-	page 11-8
Pn52A (252Ah)	Multiplier for one fully-closed rotation	√	-	-	
Pn006 (2006h)/ Pn007 (2007h)	Analog monitor signal	√	√	√	page 11-9
Pn22A (222Ah) = n.X□□□	Speed feedback method during fully-closed loop control	√	-	-	page 11-9

11.3.1 Control Block Diagram for Fully-Closed Loop Control

The control block diagram for fully-closed loop control is provided below.

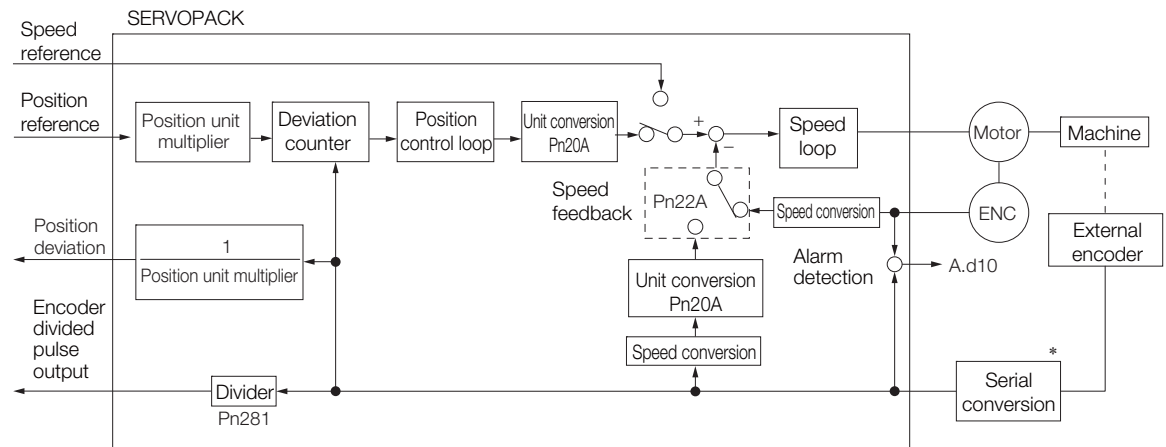

* The connected device depends on the type of external encoder.

Note: You can use either an incremental or an absolute encoder. If you use an absolute encoder, set Pn002 to n.□1□□ (Use the absolute encoder as an incremental encoder).

11.3.2 Setting the Motor Direction and the Machine Movement Direction

You must set the motor direction and the machine movement direction. To perform fully-closed loop control, you must set both Pn000 = n.□□□X (Direction Selection) and Pn002 = n.X□□□ (External Encoder Usage).

Parameter			Pn002 (2002h) = n.X□□□ (External Encoder Usage)			
			n.1□□□		n.3□□□	
Pn000 (2000h) =n.□□□X (Direction Selection)	n.□□□0	Reference direction	Forward reference	Reverse reference	Forward reference	Reverse reference
		Motor direction	CCW	CW	CCW	CW
		External encoder	Forward movement	Reverse movement	Reverse movement	Forward movement
	n.□□□1	Reference direction	Forward reference	Reverse reference	Forward reference	Reverse reference
		Motor direction	CW	CCW	CW	CCW
		External encoder	Reverse movement	Forward movement	Forward movement	Reverse movement

- Phase B leads in the divided pulses for a forward reference regardless of the setting of Pn000 = n.□□□X.
- Forward direction: The direction in which the pulses are counted up.
- Reverse direction: The direction in which the pulses are counted down.

Related Parameters

◆ Pn000 = n.□□□X

Refer to the following section for details.

 6.4 Motor Direction Setting on page 6-14

◆ Pn002 = n.X□□□

When you perform fully-closed loop control, set Pn002 to n.1□□□ or n.3□□□.

Parameter		Name	Meaning	When Enabled	Classification
Pn002 (2002h)	n.0□□□ (default setting)	External Encoder Usage	Do not use an external encoder.	After restart	Setup
	n.1□□□		External encoder moves in forward direction for CCW motor rotation.		
	n.2□□□		Reserved parameter (Do not change.)		
	n.3□□□		External encoder moves in reverse direction for CCW motor rotation.		
	n.4□□□		Reserved parameter (Do not change.)		

Information

Determine the setting of Pn002 = n.X□□□ as described below.

- Set Pn000 to n.□□□0 (Use the direction in which the linear encoder counts up as the forward direction) and set Pn002 to n.1□□□ (The external encoder moves in the forward direction for CCW motor rotation).
- Manually rotate the motor shaft counterclockwise.
- If the fully-closed feedback pulse counter counts up, do not change the setting of Pn002 (Pn002 = n.1□□□).
- If the fully-closed feedback pulse counter counts down, set Pn002 to n.3□□□.

11.3.3 Setting the Number of External Encoder Scale Pitches

Set the number of external encoder scale pitches per motor rotation in Pn20A.

Setting Example

Specifications External encoder scale pitch: 20 μm Ball screw lead: 30 mm
--

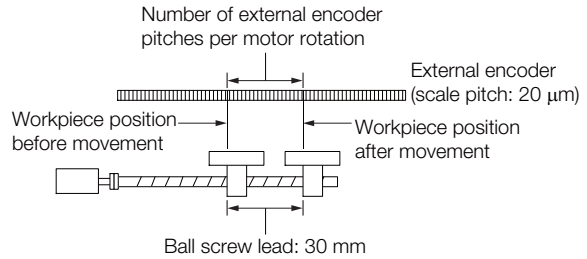

If the external encoder is connected directly to the motor, the setting will be 1,500 ($30 \text{ mm} / 0.02 \text{ mm} = 1,500$).

- Note: 1. If there is a fraction, round off the digits below the decimal point.
 2. If the number of external encoder scale pitches per motor rotation is not an integer, there will be deviation in the position loop gain (Kp), feedforward, and position reference speed monitor. This is not relevant for the position loop and it therefore does not interfere with the position accuracy.

Related Parameters

Pn20A (220Ah)	Number of External Scale Pitches Position				
	Setting Range	Setting Unit	Default Setting	When Enabled	Classification
	4 to 1,048,576	1 scale pitch/revolution	32,768	After restart	Setup

11.3.4 Setting the PAO, PBO, and PCO (Encoder Divided Pulse Output) Signals

Set the position resolution in Pn281 (Encoder Output Resolution).
 Enter the number of phase A and phase B edges for the setting.

Setting Example

Specifications External encoder scale pitch: 20 μm Ball screw lead: 30 mm Speed: 1,600 mm/s

If a single pulse (multiplied by 4) is output for 1 μm, the setting would be 20.
 If a single pulse (multiplied by 4) is output for 0.5 μm, the setting would be 40.
 The encoder divided pulse output would have the following waveform if the setting is 20.

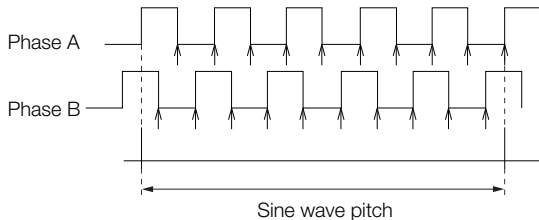

“↑” indicates the edge positions. In this example, the set value is 20 and therefore the number of edges is 20.

- Note: The upper limit of the encoder signal output frequency (multiplied by 4) is 6.4 Mpps. Do not set a value that would cause the output to exceed 6.4 Mpps.
 If the output exceeds the upper limit, an A.511 alarm (Overspeed of Encoder Output Pulse Rate) will be output.

11.3.5 External Absolute Encoder Data Reception Sequence

Example If the setting is 20 and the speed is 1,600 mm/s, the output frequency would be 1.6 Mpps

$$\frac{1600 \text{ mm/s}}{0.001 \text{ mm}} = 1,600,000 = 1.6 \text{ Mpps}$$

Because 1.6 Mpps is less than 6.4 Mpps, this setting can be used.

Related Parameters

Pn281 (2281h)	Encoder Output Resolution Position				
	Setting Range	Setting Unit	Default Setting	When Enabled	Classification
	1 to 4,096	1 edge/pitch	20	After restart	Setup

Note: 1. The maximum setting for the encoder output resolution is 4,096. Pulse output at a linear encoder resolution of 4,096 or higher is not possible.
 2. If the setting of Pn281 exceeds the resolution of the external encoder, the A.041 alarm (Encoder Output Pulse Setting Error) will be output.

11.3.5 External Absolute Encoder Data Reception Sequence

Refer to the following section for details.

7.9.4 Reading the Position Data from the Absolute Linear Encoder on page 7-42

With fully-closed loop control, the same sequence as for a Linear Servomotor is used.

11.3.6 Setting Unit Systems

Refer to the following section for details.

6.14 Setting Unit Systems on page 6-42

With fully-closed loop control, the same setting as for a Linear Servomotor is used.

11.3.7 Alarm Detection Settings

This section describes the alarm detection settings (Pn51B and Pn52A).

Pn51B (Excessive Error Level between Servomotor and Load Positions)

This setting is used to detect the difference between the feedback position of the motor encoder and the feedback load position of the external encoder for fully-closed loop control. If the detected difference exceeds the setting, an A.d10 alarm (Motor-Load Position Error Overflow) will be output.

Pn51B (251Bh)	Excessive Error Level between Servomotor and Load Positions Position				
	Setting Range	Setting Unit	Default Setting	When Enabled	Classification
	0 to 1,073,741,824	1 reference unit	1000	Immediately	Setup

Note: If you set this parameter to 0, A.d10 alarms will not be output and the machine may be damaged.

Pn52A (Multiplier per One Fully-closed Rotation)

Set the coefficient of the deviation between the motor and the external encoder per motor rotation.

This setting can be used to prevent the motor from running out of control due to damage to the external encoder or to detect belt slippage.

◆ **Setting Example**

Increase the value if the belt slips or is twisted excessively.

If this parameter is set to 0, the external encoder value will be read as it is.

If you use the default setting of 20, the second rotation will start with the deviation for the first motor rotation multiplied by 0.8.

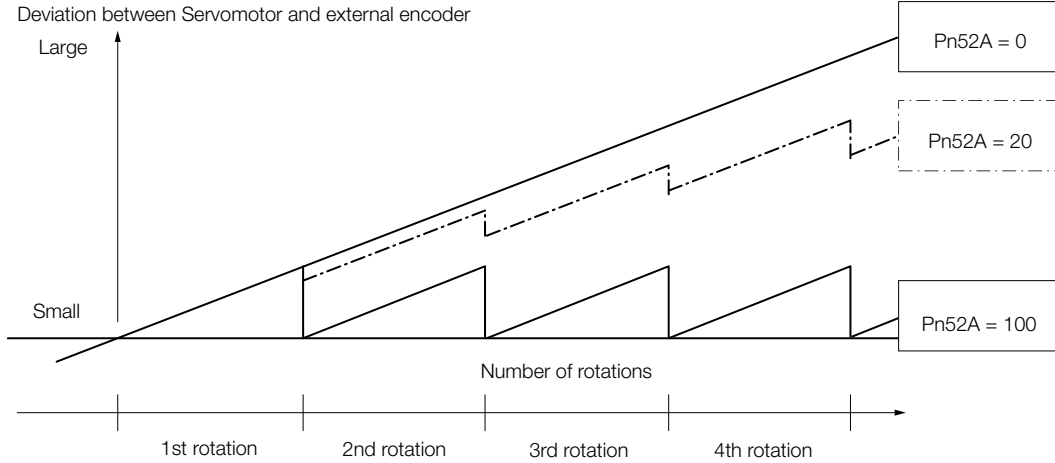

◆ **Related Parameters**

Pn52A (252Ah)	Multiplier per One Fully-closed Rotation				Position
	Setting Range	Setting Unit	Default Setting	When Enabled	Classification
	0 to 100	1%	20	Immediately	Setup

11.3.8 Analog Monitor Signal Settings

You can monitor the position deviation between the Servomotor and load with an analog monitor.

Parameter	Name	Meaning	When Enabled	Classification
Pn006 (2006h)	n.□□07	Analog Monitor 1 Signal Selection	Immediately	Setup
Pn007 (2007h)	n.□□07	Analog Monitor 2 Signal Selection		

11.3.9 Setting to Use an External Encoder for Speed Feedback

For fully-closed loop control, you normally set a parameter to specify using the motor encoder speed (Pn22A = n.0□□□).

If you will use a high-resolution external encoder, set the parameter to specify using the speed of the external encoder (Pn22A = n.1□□□).

Parameter	Meaning	When Enabled	Classification
Pn22A (222Ah)	n.0□□□ (default setting)	After restart	Setup
	n.1□□□		

Note: This parameter cannot be used if Pn002 is set to n.0□□□ (Do not use external encoder).

11.4 Monitoring an External Encoder

You can monitor the current value of an external encoder attached to a machine without creating a fully-closed loop.

A dual encoder system with an encoder in the Rotary Servomotor and an external encoder attached to the machine is used, but only the encoder in the Rotary Servomotor is used in the control loop.

The external encoder is used only to monitor the current position of the machine. You can also use a touch probe to latch the current position of an external encoder.

11.4.1 Option Module Required for Monitoring

A Fully-closed Module (SGDV-OFA01A) is required to use this function.

Refer to the following manual for detailed information on installation.

📖 Σ -V-Series/ Σ -V-Series for Large-Capacity Models/ Σ -7-Series Installation Guide Fully-closed Module (Manual No.: TOBP C720829 03)

Note: You cannot use a Safety Module (SGDV-OSA01A) if you install a Fully-closed Module.

11.4.2 Block Diagrams

A simple block diagram is given below to provide an overall image of monitoring an external encoder.

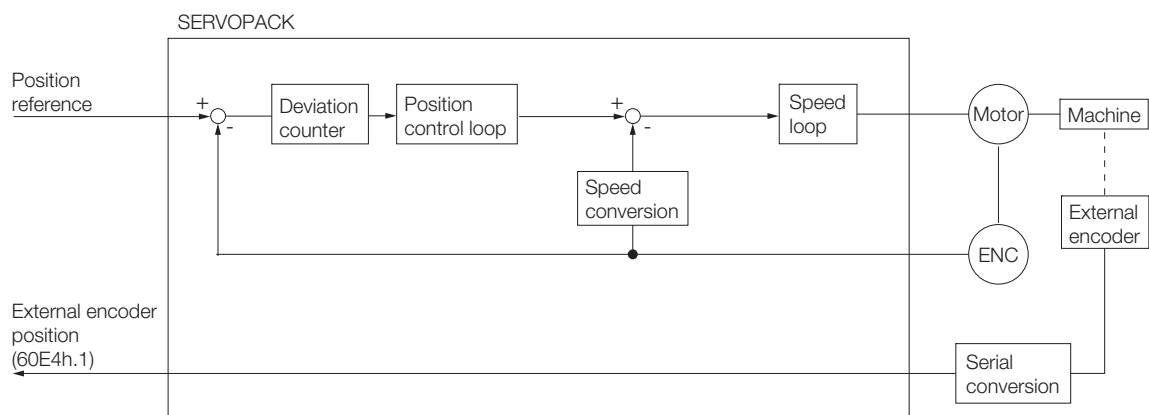

The following block diagram shows monitoring an external encoder in the Profile Position Mode.

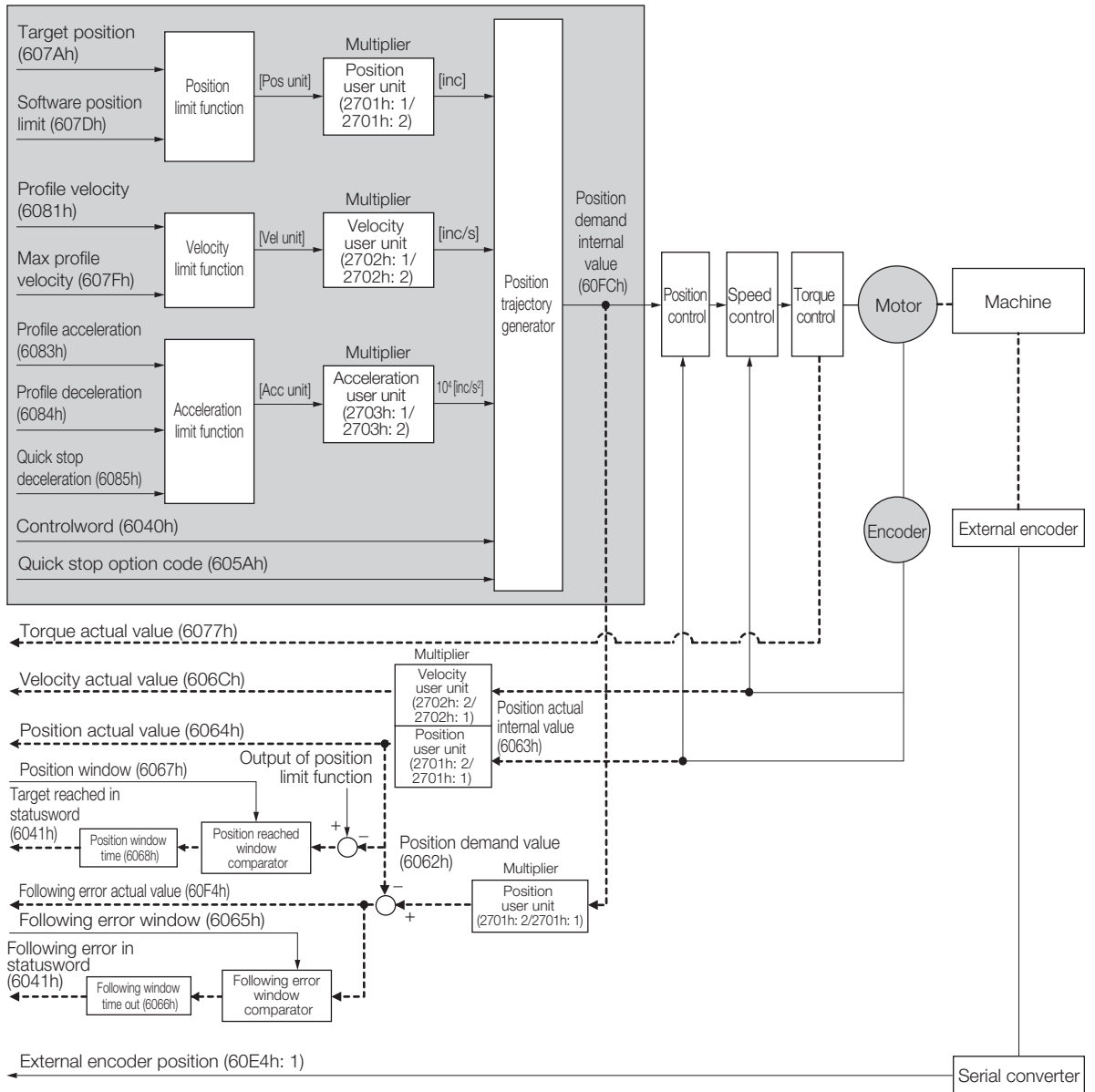

Fully-Closed Loop Control

Safety Functions

12

This chapter provides detailed information on the safety functions of the SERVOPACK.

12.1	Introduction to the Safety Functions	12-3
12.1.1	Safety Functions	12-3
12.1.2	Precautions for Safety Functions	12-4
12.2	Hard Wire Base Block (HWBB and SBB) . .	12-5
12.2.1	Risk Assessment	12-5
12.2.2	Hard Wire Base Block (HWBB) State	12-6
12.2.3	Resetting the HWBB State	12-7
12.2.4	Recovery Method	12-8
12.2.5	Detecting Errors in HWBB Signal	12-8
12.2.6	HWBB Input Signal Specifications	12-9
12.2.7	Operation without a Host Controller	12-9
12.2.8	/S-RDY (Servo Ready Output) Signal	12-10
12.2.9	/BK (Brake Output) Signal	12-10
12.2.10	Stopping Methods	12-11
12.2.11	ALM (Servo Alarm) Signal	12-11
12.3	EDM1 (External Device Monitor)	12-12
12.3.1	EDM1 Output Signal Specifications	12-12
12.4	Applications Examples for Safety Functions . .	12-13
12.4.1	Connection Example	12-13
12.4.2	Failure Detection Method	12-13
12.4.3	Procedure	12-14
12.5	Validating Safety Functions	12-15
12.6	Connecting a Safety Function Device . . .	12-16

12.7 Safety Module Safety Functions12-17

- 12.7.1 Safety Base Block with Delay (SBB-D)12-17
- 12.7.2 Safe Position Monitor with Delay (SPM-D)12-18
- 12.7.3 Safe Speed Limit with Delay (SLS-D)12-19
- 12.7.4 Active Mode Function12-19

12.1 Introduction to the Safety Functions

12.1.1 Safety Functions

Safety functions are built into the SERVOPACK to reduce the risks associated with using the machine by protecting workers from the hazards of moving machine parts and otherwise increasing the safety of machine operation.

Especially when working in hazardous areas inside guards, such as for machine maintenance, the safety function can be used to avoid hazardous moving machine parts.

You can implement the following four safety functions depending on the Safety Module that you use.

Function	Description	SERVO- PACK Built- in Function	Safety Module Function	
				Active Mode Function* ¹
Hard Wire Base Block (HWBB and SBB)	This safety function is equivalent to the Safety Torque OFF function defined in IEC 61800-5-2.	Yes (HWBB)	Yes (SBB* ²)	–
Safety Base Block with Delay (SBB-D)* ²	This safety function is equivalent to the Safety Stop 1 function defined in IEC 61800-5-2.	–	Yes	Yes
Safe Position Monitor with Delay (SPM-D)* ²	This safety function is equivalent to the Safety Stop 2 function defined in IEC 61800-5-2.	–	Yes	Yes
Safe Speed Limit with Delay (SLS-D)* ²	This safety function is equivalent to the Safely-Limited Speed function defined in IEC 61800-5-2.	–	Yes	–

*1. The Active Mode Function stops the motor according to the speed reference that is preset in a parameter in the SERVOPACK when the safety request input signal turns OFF during SBB-D or SPM-D. The Active Mode Function is not a safety function in the compliant standards. Keep this in mind when you design the system.

 [12.7.4 Active Mode Function on page 12-19](#)

*2. A Safety Module (optional) must be connected to use this function. Refer to the following manual for application procedures.

 [Σ-V-Series/Σ-V-Series for Large-Capacity Models/Σ-7-Series Installation Guide Safety Module \(Manual No.: SIEP C720829 06\)](#)

Refer to the following section for information on the safety function and safety parameters.

 [Compliance with UL Standards, EU Directives, and Other Safety Standards on page xxi](#)



Important

Products that display the TÜV mark on the nameplate have met the safety standards.

12.1.2 Precautions for Safety Functions

 **WARNING**

- To confirm that the HWBB function satisfies the safety requirements of the system, you must conduct a risk assessment of the system.
Incorrect use of the safety function may cause injury.
- The Servomotor will move if there is an external force (e.g., gravity on a vertical axis) even when the HWBB function is operating. Use a separate means, such as a mechanical brake, that satisfies the safety requirements.
Incorrect use of the safety function may cause injury.
- While the HWBB function is operating, the motor may move within an electric angle of 180° or less as a result of a SERVOPACK failure. Use the HWBB function for an application only after confirming that movement of the motor will not result in a hazardous condition.
Incorrect use of the safety function may cause injury.
- The dynamic brake and the brake signal are not safety-related elements. You must design the system so that SERVOPACK failures will not cause a hazardous condition while the HWBB function is operating.
Incorrect use of the safety function may cause injury.
- Connect devices that satisfy the safety standards for the signals for safety functions.
Incorrect use of the safety function may cause injury.
- The HWBB function does not shut OFF the power to the SERVOPACK or electrically isolate it. Implement measures to shut OFF the power supply to the SERVOPACK before you perform maintenance on it.
There is a risk of electric shock.
- Use an SELV-compliant power supply according to EN/IEC 60950-1 to input 24 VDC to the control power supply input terminals.
If you use a power supply that is not SELV compliant, safety functions may be lost if the power supply fails, which may result in machine damage or injury.

12.2 Hard Wire Base Block (HWBB and SBB)

A hard wire base block (abbreviated as HWBB) is a safety function that is designed to shut OFF the current to the motor with a hardwired circuit.

The drive signals to the Power Module that controls the motor current are controlled by the circuits that are independently connected to the two input signal channels to turn OFF the Power Module and shut OFF the motor current.



Important

For safety function signal connections, the input signal is the 0-V common and the output signal is a source output.

This is opposite to other signals described in this manual.

To avoid confusion, the ON and OFF status of signals for the safety function are defined as follows:

ON: The state in which the relay contacts are closed or the transistor is ON and current flows into the signal line.

OFF: The state in which the relay contacts are open or the transistor is OFF and no current flows into the signal line.

The input signal uses the 0-V common. The following figure shows a connection example.

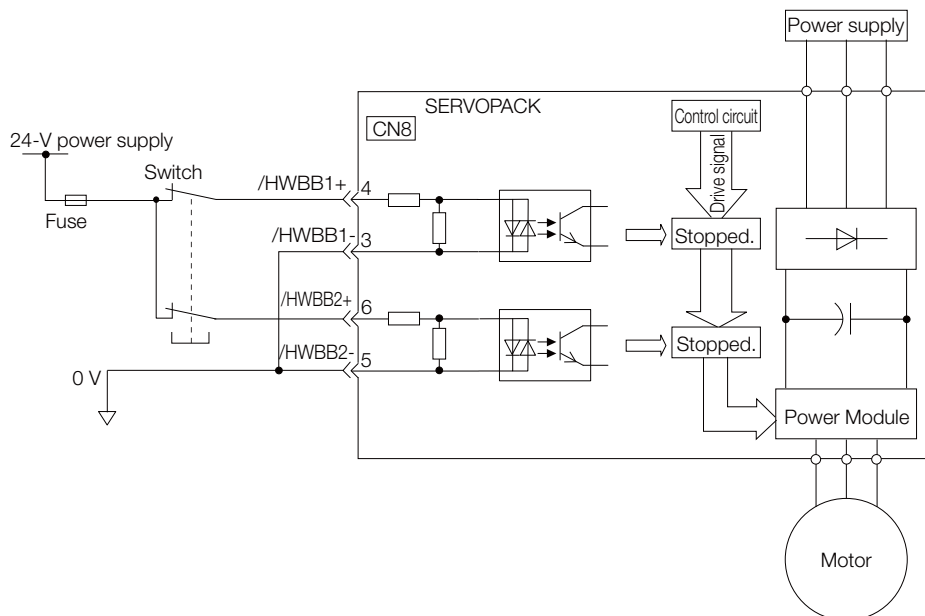

12.2.1 Risk Assessment

When using the HWBB, you must perform a risk assessment of the Servo System in advance to confirm that the safety level of the standards is satisfied. Refer to the following section for details on the standards.

Compliance with UL Standards, EU Directives, and Other Safety Standards on page xxi

Note: To meet performance level e (PLe) in EN ISO 13849-1 and SIL3 in IEC 61508, the EDM1 signal must be monitored by the host controller. If the EDM1 signal is not monitored by the host controller, the level will be safety performance level c (PLc) and SIL1.

The following hazards exist even when the HWBB is operating. These hazards must be included in the risk assessment.

- The Servomotor will move if an external force is applied to it (for example, gravity on a vertical axis). Implement measures to hold the Servomotor, such as installing a separate mechanical brake.

12.2.2 Hard Wire Base Block (HWBB) State

- If a failure occurs such as a Power Module failure, the Servomotor may move within an electric angle of 180°. Ensure safety even if the Servomotor moves.
 - The rotational angle or travel distance depends on the type of Servomotor as follows:
 - Rotary Servomotor: 1/6 rotation max. (rotational angle calculated at the motor shaft)
 - Linear Servomotor: 50 mm max.
- The HWBB does not shut OFF the power to the SERVOPACK or electrically isolate it. Implementation measures to shut OFF the power supply to the SERVOPACK before you perform maintenance on it.

12.2.2 Hard Wire Base Block (HWBB) State

The SERVOPACK will be in the following state if the HWBB operates. If the /HWBB1 or /HWBB2 signal turns OFF, the HWBB will operate and the SERVOPACK will enter a HWBB state.

- **When HWBB Operates after Servo OFF (Power Not Supplied to Motor)**

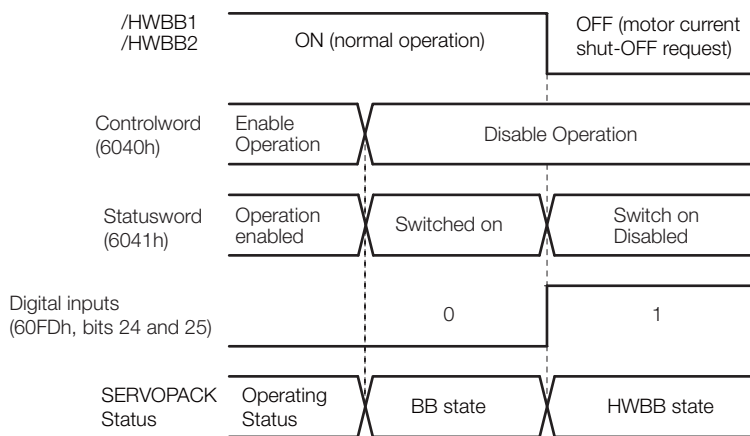

- **When HWBB Operates While Power Is Supplied to Servomotor**

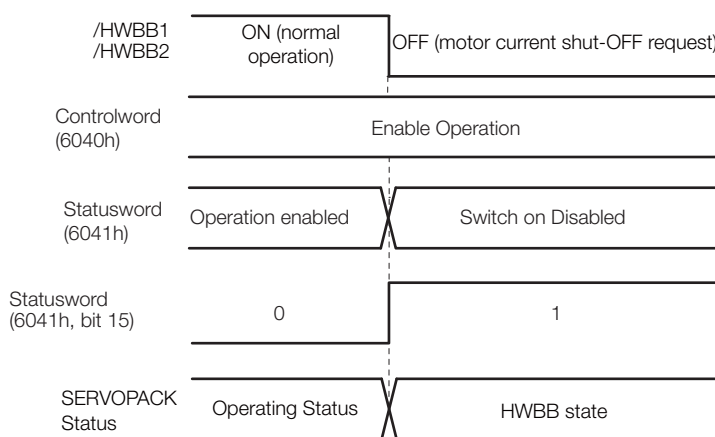

12.2.3 Resetting the HWBB State

Normally, after the Shutdown command is received and power is no longer supplied to the Servomotor, the /HWBB1 and /HWBB2 signals will turn OFF and the SERVOPACK will enter the HWBB state. If you turn ON the /HWBB1 and /HWBB2 signals in this state, the SERVOPACK will enter a base block (BB) state and will be ready to acknowledge the Servo ON command (Enable Operation command).

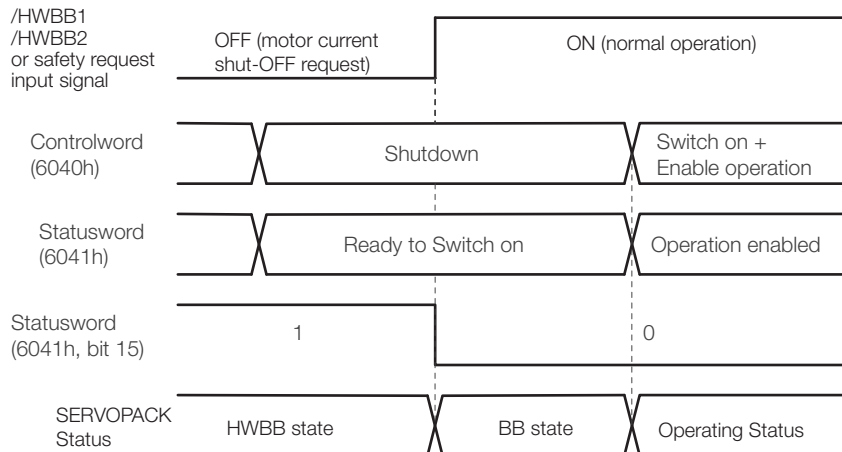

Even if the /HWBB1 and /HWBB2 signals are OFF and the Servo ON command (Enable Operation command) is received, when you turn ON the /HWBB1 and /HWBB2 signals, the SERVOPACK will enter the BB state.

Send the Servo ON command (Enable Operation command) after receiving the Shutdown command.

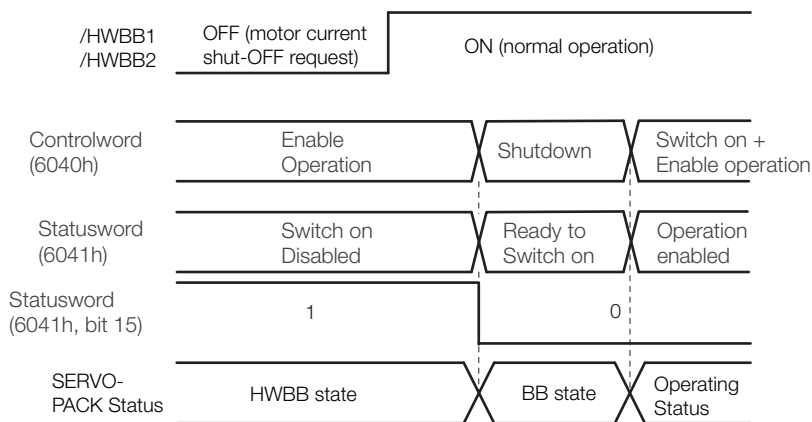

Note: If the SERVOPACK is placed in the BB state while the main circuit power supply is OFF, the HWBB state will be maintained until the Shutdown command is received.

12.2.4 Recovery Method

■ Recovery Conditions

All of the following conditions must be met.

- All safety request inputs are ON.
- The Servo ON command (Enable Operation command) was not sent.
- None of the following utility functions have been executed. (These functions execute the Servo ON command (Enable Operation command).)

The following utility functions execute the Servo ON command (Enable Operation command).

Utility Function No.	Function Name
Fn002	Jog
Fn003	Origin Search
Fn004	Jog Program
Fn00E	Autotune Motor Current Detection Signal Offset
Fn080	Polarity Detection
Fn201	Advanced Autotuning without Reference
Fn206	Easy FFT

Note: If any of the above utility functions was executed, the utility function must be ended. Perform the operation to return to the Main Menu for the utility functions on the Digital Operator. Refer to the following manual for operating procedures.

📖 Σ -7-Series Digital Operator Operating Manual (Manual No.: SIEP S800001 33)

■ Recovery Procedure

1. Specify Shutdown in *controlword* (6040h, bits 0 to 3) to reset the Servo Drive.
2. Specify Switch ON and the Servo ON command (Enable Operation command) in *controlword* (6040h, bits 0 to 3).

Power will be supplied to the motor.

12.2.5 Detecting Errors in HWBB Signal

If only the /HWBB1 or the /HWBB2 signal is input, an A.Eb1 alarm (Safety Function Signal Input Timing Error) will occur unless the other signal is input within 10 seconds. This makes it possible to detect failures, such as disconnection of an HWBB signal.

CAUTION

- The A.Eb1 alarm (Safety Function Signal Input Timing Error) is not a safety-related element. Keep this in mind when you design the system.

12.2.6 HWBB Input Signal Specifications

If an HWBB is requested by turning OFF the two HWBB input signal channels (/HWBB1 and /HWBB2), the power supply to the Servomotor will be turned OFF within 8 ms.

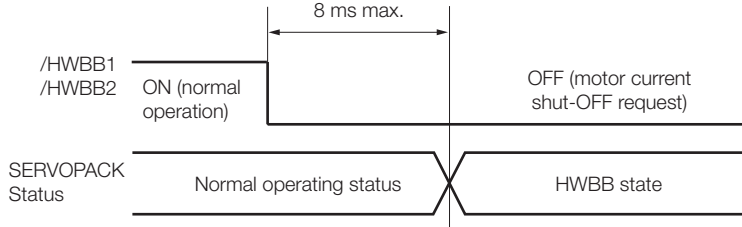

Note: 1. The OFF status is not recognized if the OFF interval of the /HWBB1 or /HWBB2 signal is 0.5 ms or shorter.
 2. You can check the status of the input signals by using monitor displays.

12.2.7 Operation without a Host Controller

The HWBB will operate even for operation without a host controller.

However, if the HWBB operates during execution of the following functions, leave the execution mode for the function and then enter it again to restart operation. Operation will not be restarted simply by turning OFF the /HWBB1 and /HWBB2 signals.

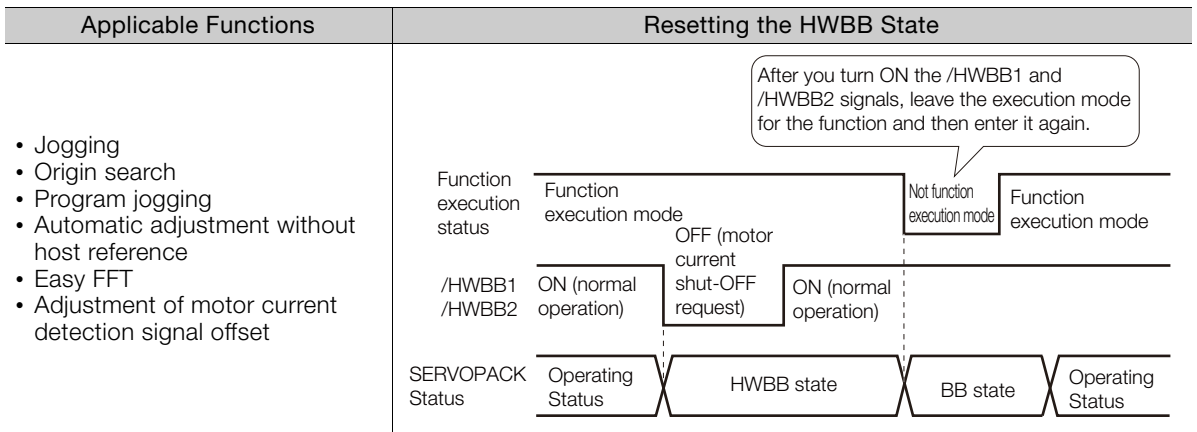

12.2.8 /S-RDY (Servo Ready Output) Signal

The Servo ON command (Enable Operation command) will not be acknowledged in the HWBB state. Therefore, the Servo Ready Output Signal will turn OFF. The Servo Ready Output Signal will turn ON if both the /HWBB1 and /HWBB2 signals are ON and the servo is turned OFF (BB state).

An example is provided below for when the main circuit power supply is ON when there is no servo alarm.

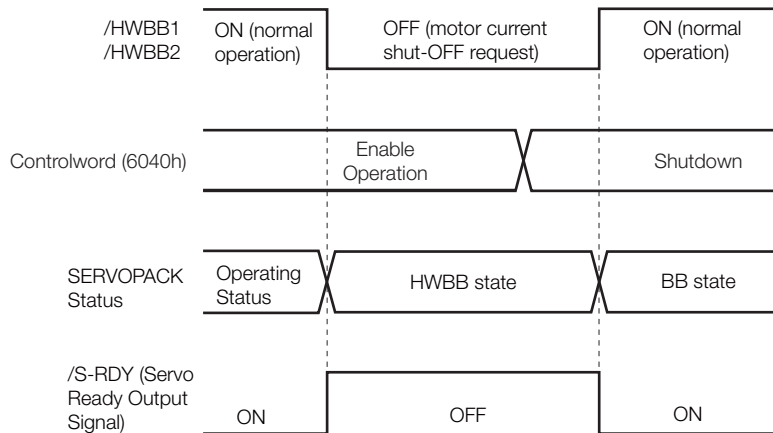

12.2.9 /BK (Brake Output) Signal

If the HWBB operates when the /HWBB1 or /HWBB2 signal is OFF, the /BK (Brake) signal will turn OFF. At that time, the setting in Pn506 (Brake Reference - Servo OFF Delay Time) will be disabled. Therefore, the Servomotor may be moved by external force until the actual brake becomes effective after the /BK signal turns OFF.

CAUTION

- The brake signal is not a safety-related element. You must design the system so that a hazardous condition does not occur even if the brake signal fails in the HWBB state. Also, if a Servomotor with a Brake is used, keep in mind that the brake in the Servomotor is used only to prevent the moving part from being moved by gravity or an external force and it cannot be used to stop the Servomotor.

12.2.10 Stopping Methods

If the /HWBB1 or /HWBB2 signal turns OFF and the HWBB operates, the Servomotor will stop according to the stop mode that is set for stopping the Servomotor when the servo turns OFF (Pn001 = n.□□□X). However, if the dynamic brake is enabled (Pn001 = n.□□□0 or n.□□□1), observe the following precautions.

CAUTION

- The dynamic brake is not a safety-related element. You must design the system so that a hazardous condition does not occur even if the Servomotor coasts to a stop in the HWBB state. Normally, we recommend that you use a sequence that returns to the HWBB state after stopping for a reference.
- If the application frequently uses the HWBB, stopping with the dynamic brake may result in the deterioration of elements in the SERVOPACK. To prevent internal elements from deteriorating, use a sequence in which the HWBB state is returned to after the Servomotor has come to a stop.

12.2.11 ALM (Servo Alarm) Signal

The ALM (Servo Alarm) signal is not output in the HWBB state.

12.3 EDM1 (External Device Monitor)

The EDM1 (External Device Monitor) signal is used to monitor failures in the HWBB. Connect the monitor signal as a feedback signal, e.g., to the Safety Unit.

Note: To meet performance level e (PLe) in EN ISO 13849-1 and SIL3 in IEC 61508, the EDM1 signal must be monitored by the host controller. If the EDM1 signal is not monitored by the host controller, the level will be safety performance level c (Plc) and SIL1.

Information **Safety Module Monitor (2720h)**
 You can also use *safety module monitor (2720h)* in the EtherCAT communications object dictionary to monitor the Safety Module. Refer to the following sections for details on monitoring the Safety Module.
 *Safety Module Monitor (2720h)* on page 15-22

• Failure Detection Signal for EDM1 Signal

The relationship between the EDM1, /HWBB1, and /HWBB2 signals is shown below.

Detection of failures in the EDM1 signal circuit can be achieved by using the four status of the EDM1 signal in the following table. A failure can be detected by checking the failure status, e.g., when the power supply is turned ON.

Signal	Logic			
/HWBB1	ON	ON	OFF	OFF
/HWBB2	ON	OFF	ON	OFF
EDM1	OFF	OFF	OFF	ON

WARNING

- The EDM1 signal is not a safety output. Use it only for monitoring for failures.

12.3.1 EDM1 Output Signal Specifications

If an HWBB is requested by turning OFF the two HWBB input signal channels (/HWBB1 and /HWBB2) when the safety function is operating normally, the EDM1 output signal will be turned ON within 8 ms.

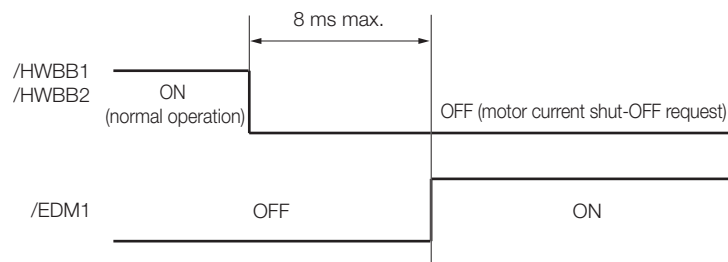

12.4 Applications Examples for Safety Functions

This section provides examples of using the safety functions.

12.4.1 Connection Example

In the following example, a Safety Unit is used and the HWBB operates when the guard is opened.

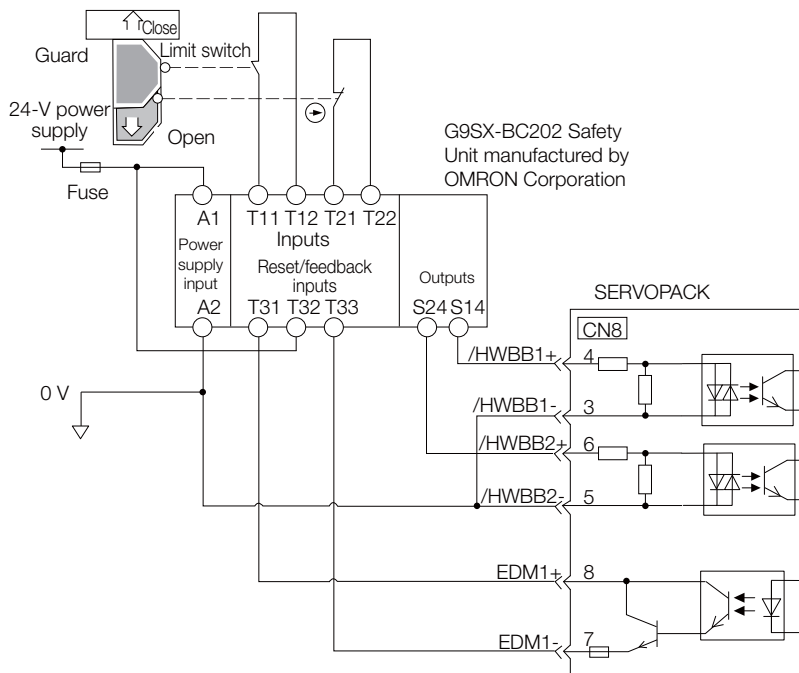

When the guard is opened, both the /HWBB1 and the /HWBB2 signals turn OFF, and the EDM1 signal turns ON. Because the feedback circuit is ON while the guard is closed, the Safety Unit is reset, the /HWBB1 and the /HWBB2 signals turn ON, and the operation is enabled.

Note: The EDM1 signal is used as a source output. Connect the EDM1 so that the current flows from EDM1+ to EDM1-.

12.4.2 Failure Detection Method

If a failure occurs (e.g., the /HWBB1 or the /HWBB2 signal remains ON), the Safety Unit is not reset when the guard is closed because the EDM1 signal remains OFF. Therefore starting is not possible and a failure is detected.

In this case the following must be considered: an error in the external device, disconnection of the external wiring, short-circuiting in the external wiring, or a failure in the SERVOPACK. Find the cause and correct the problem.

12.4.3 Procedure

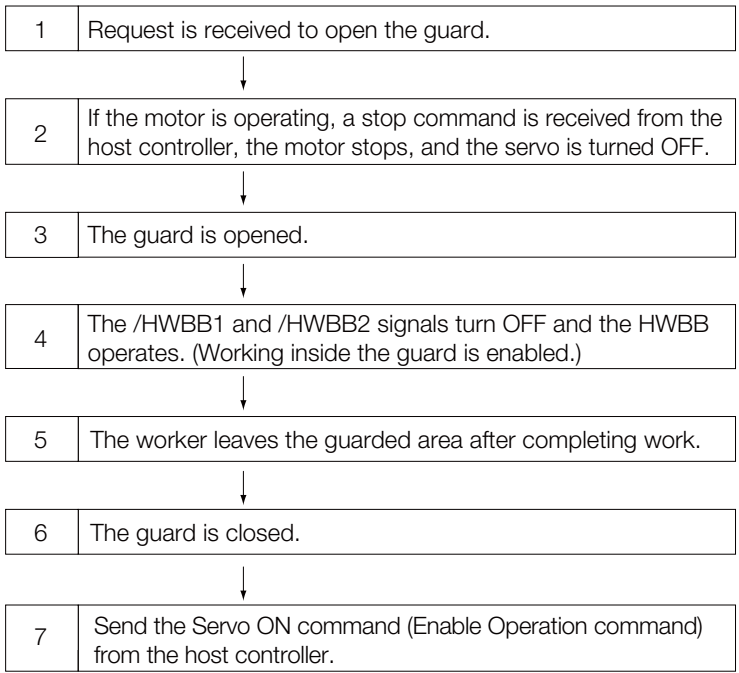

12.5 Validating Safety Functions

When you commission the system or perform maintenance or SERVOPACK replacement, you must always perform the following validation test on the HWBB after completing the wiring. (It is recommended that you keep the confirmation results as a record.)

- When the /HWBB1 and /HWBB2 signals turn OFF, confirm that the Digital Operator displays **Hbb** and that the Servomotor does not operate.
- Monitor the ON/OFF status of the /HWBB1 and /HWBB2 signals.
If the ON/OFF status of the signals do not coincide with the display, the following must be considered: an error in the external device, disconnection of the external wiring, short-circuiting in the external wiring, or a failure in the SERVOPACK. Find the cause and correct the problem.
- Confirm that the EDM1 signal is OFF while in normal operation by using the feedback circuit input display of the connected device.

12.6 Connecting a Safety Function Device

Use the following procedure to connect a safety function device.

1. Remove the Safety Jumper Connector from the connector for the safety function device (CN8).

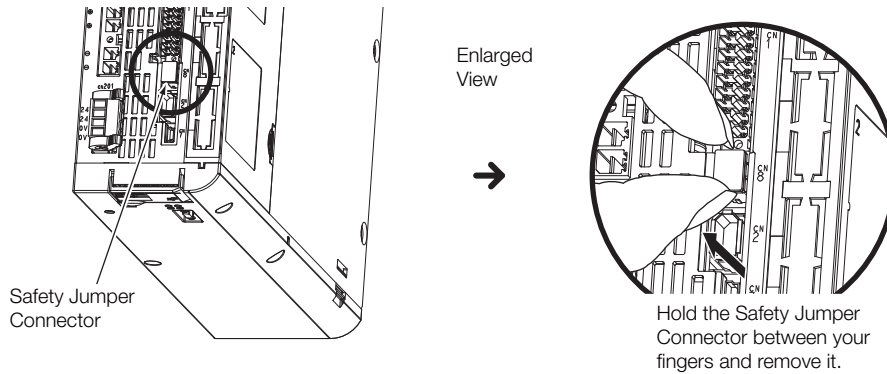

2. Connect the safety function device to the connector for the safety function device (CN8).

Note: If you do not connect a safety function device, leave the Safety Jumper Connector connected to the connector for the safety function device (CN8). If the SERVOPACK is used without the Safety Jumper Connector connected to CN8, no current will be supplied to the Servomotor and no motor torque will be output. In this case, **Hbb** will be displayed on the Digital Operator.

12.7 Safety Module Safety Functions

This section describes the safety functions provided by the Safety Module.

12.7.1 Safety Base Block with Delay (SBB-D)

The Safety Base Block with Delay (SBB-D) function operates according to the Safe Stop 1 (SS1) function defined in IEC 61800-5-2. The deceleration operation of the motor is monitored (deceleration monitoring) until the time set in a parameter elapses in response to the safety request input status. The HWBB in the SERVOPACK is then executed to shut OFF the power supply to the motor.

Note: Refer to the following manual for the application procedures for the SBB-D function.

📖 [Σ-V-Series/Σ-V-Series for Large-Capacity Models/Σ-7-Series User's Manual Safety Module \(Manual No.: SIEP C720829 06\)](#)

Operation Example for SBB-D

When the safety monitor time expires, the safe state (HWBB) is entered and then the power supply to the motor is shut OFF. The Drive enters the Switch ON Disabled state (*statusword* (6041h)).

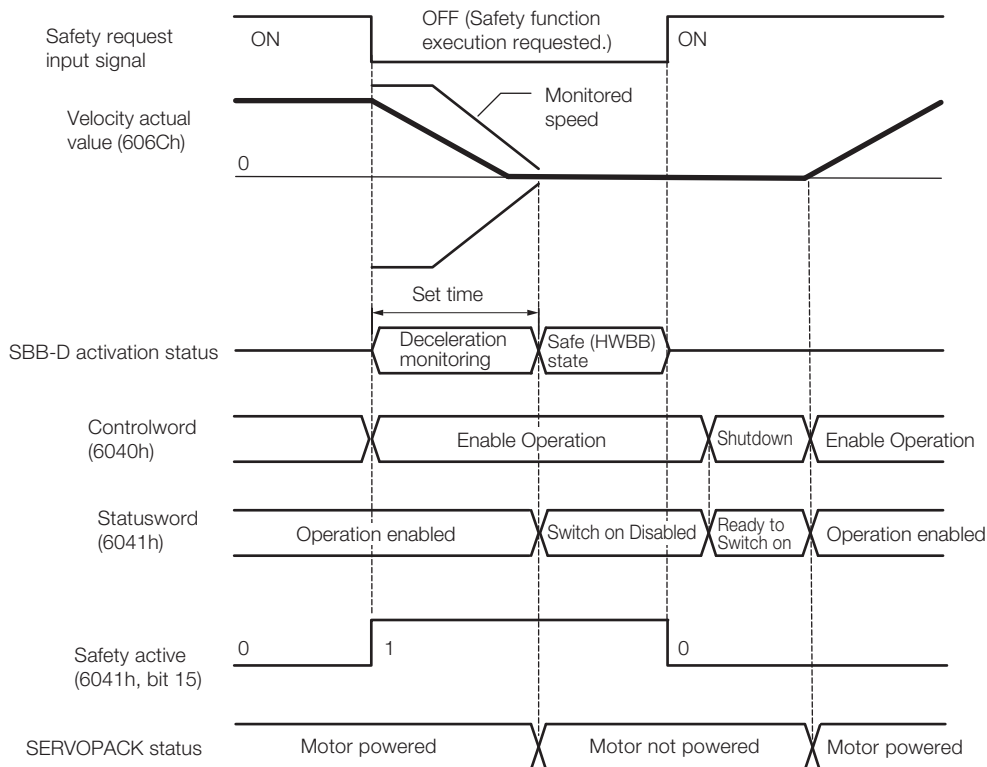

Recovery Method

When the safety request input signal turns ON, normal operation will be enabled.

The recovery method after deceleration monitoring is completed and the safe (HWBB) state is entered is the same as for the HWBB function. Refer to the following section for details.

📖 [12.2.4 Recovery Method on page 12-8](#)

12.7.2 Safe Position Monitor with Delay (SPM-D)

The Safe Position Monitor with Delay (SPM-D) function operates according to the Safe Stop 2 (SS2) function defined in IEC 61800-5-2. The deceleration operation of the motor is monitored (deceleration monitoring) until the time set in a parameter elapses in response to the safety request input status. Position monitoring is then performed to see if the motor travel distance is within the allowable range.

Note: Refer to the following manual for the application procedures for the SPM-D function.

📖 Σ -V-Series/ Σ -V-Series for Large-Capacity Models/ Σ -7-Series User's Manual Safety Module (Manual No.: SIEP C720829 06)

Operation Example for SPM-D

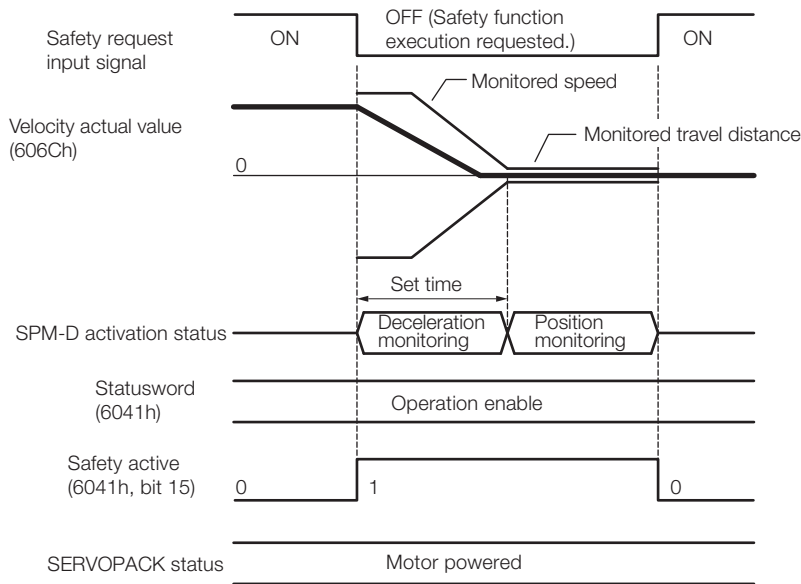

Recovery Method

When the safety request input signal turns ON, normal operation will be enabled.

The recovery method after deceleration monitoring is completed and the safe (HWBB) state is entered in the same as for the HWBB function. Refer to the following section for details.

📖 12.2.4 Recovery Method on page 12-8

12.7.3 Safe Speed Limit with Delay (SLS-D)

The Safe Speed Limit with Delay (SLS-D) function operates according to the Safely-Limited Speed (SLS) function defined in IEC 61800-5-2. The deceleration operation of the motor is monitored (deceleration monitoring) until the time set in a parameter elapses in response to the safety request input status. The motor speed is then monitored to see if it is within the allowable range (within range for a constant speed).

Note: Refer to the following manual for the application procedures for the SLS-D function.

📖 Σ -V-Series/ Σ -V-Series for Large-Capacity Models/ Σ -7-Series User's Manual Safety Module (Manual No.: SIEP C720829 06)

Operation Example for SLS-D

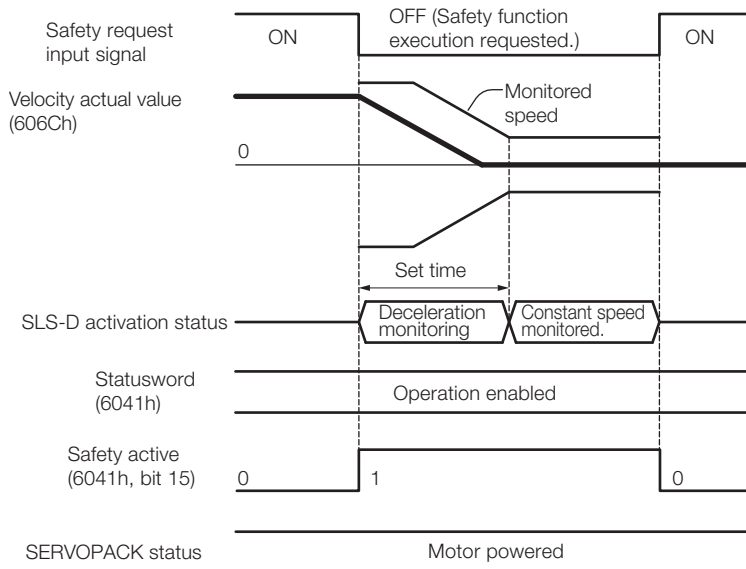

Recovery Method

When the safety request input signal turns ON, normal operation will be enabled.

The recovery method after deceleration monitoring is completed and the safe (HWBB) state is entered in the same as for the HWBB function. Refer to the following section for details.

📖 12.2.4 Recovery Method on page 12-8

12.7.4 Active Mode Function

The Active Mode Function stops the motor according to the deceleration reference that is pre-set in a parameter in the SERVOPACK when the safety request input signal turns OFF during SBB-D or SPM-D.

Active Mode Function Operation Example

If Profile Torque Mode or Cyclic Synchronous Torque Mode is set in *controlword* (6040h, bits 4 to 9), the servo will be turned OFF and the motor will be stopped as soon as the safety request input signal turns OFF.

◆ When Using the SBB-D Function (Position or Speed Control)

The motor is stopped at the set deceleration rate (Pn622 or Pn623). After the deceleration monitor time (Pc11 or Pc21) elapses, the servo is turned OFF (Switch ON Disable state is entered).

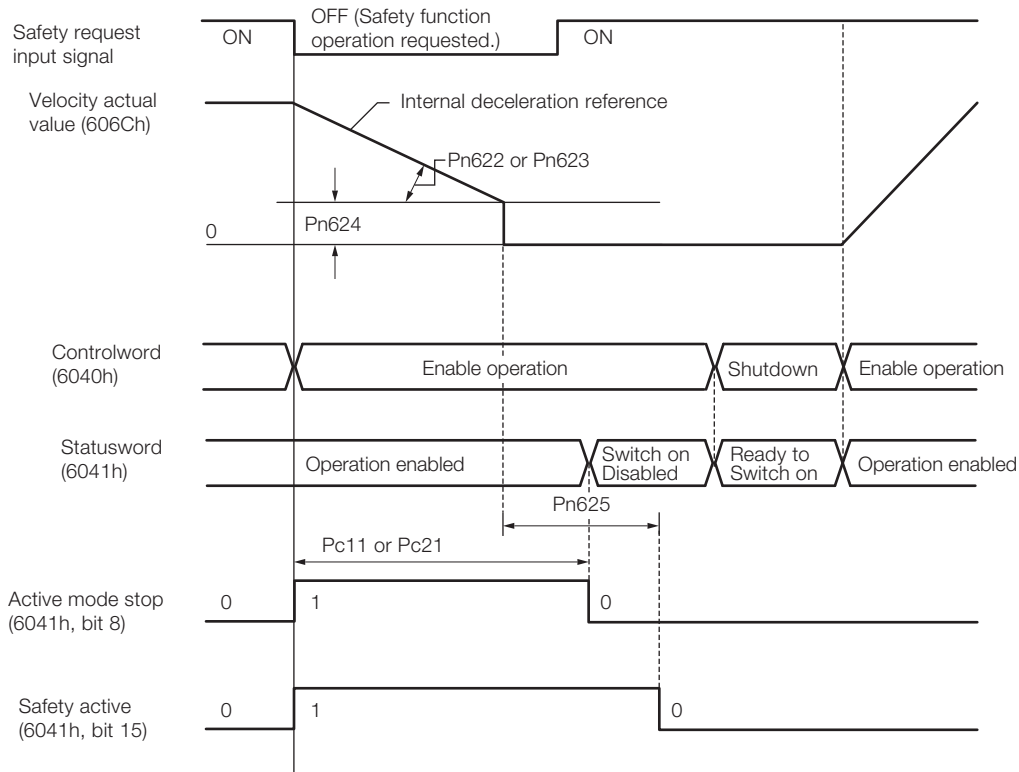

◆ When Using the SPM-D Function (Position or Speed Control)

The motor is stopped at the set deceleration rate (Pn622 or Pn623) and then the servo is locked (Operation Enabled state).

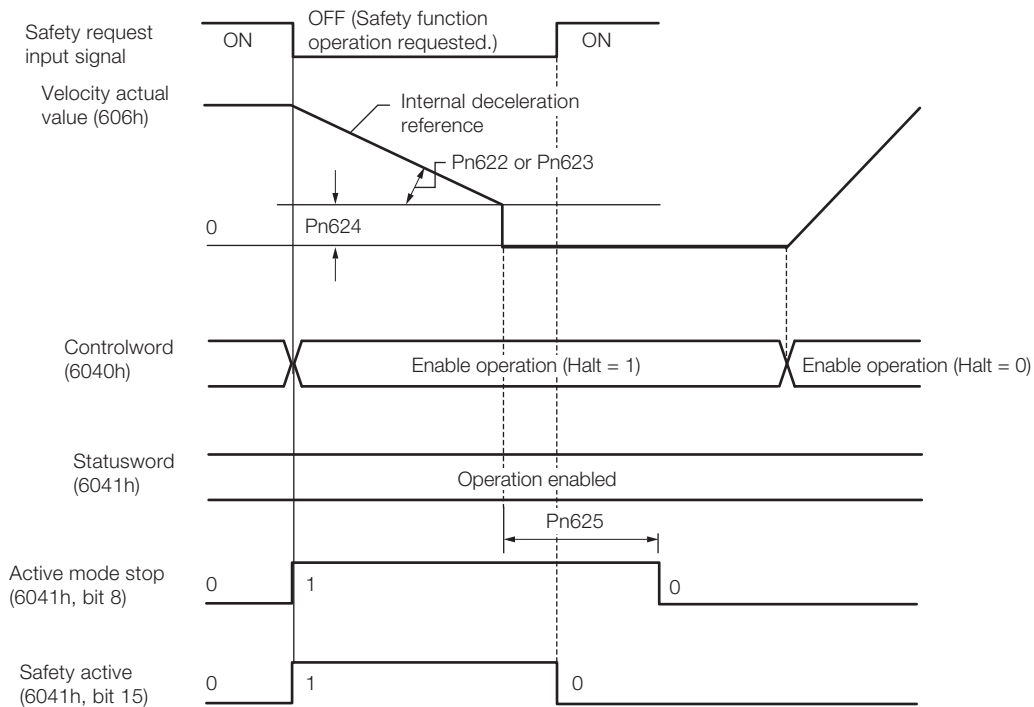

◆ Operation by Operation Mode When Stopped for the Active Mode Function

Operation Mode	Operation
Profile position mode	Profile position operation is canceled and <i>statusword</i> (6041h) changes as given below. Bit 08 = 1: Active Mode Function operating. Bit 12 = 0: Previous set-point already processed, waiting for new set-point. Bit 15 = 1: Safety function operating.
Homing mode	Homing operation is canceled and <i>statusword</i> (6041h) changes as given below. Bit 08 = 1: Active Mode Function operating. Bit 13 = 1: Homing error. Bit 15 = 1: Safety function operating.
Cyclic synchronous position/velocity/torque mode	Cyclic synchronous position, velocity, or torque operation is canceled and <i>statusword</i> (6041h) changes as given below. Bit 08 = 1: Active Mode Function operating. Bit 12 = 0: Target value (position/velocity/torque) ignored. Bit 15 = 1: Safety function operating.
Interpolated position mode	Interpolated position operation is canceled and <i>statusword</i> (6041h) changes as given below. Bit 08 = 1: Active Mode Function operating. Bit 12 = 0: Interpolation operation disabled. Bit 15 = 1: Safety function operating.
Profile velocity/torque mode	Profile velocity or torque operation is canceled and <i>statusword</i> (6041h) changes as given below. Bit 08 = 1: Active Mode Function operating. Bit 15 = 1: Safety function operating.

Recovery Method

◆ Recovery Conditions

If the Active Mode Function operates and the motor is stopped, the Active Mode Function will be reset and normal operation will be enabled when all of the following conditions are met.

- All relevant safety request input signals must be ON.
- A period of time equal to or greater than the value set as the Active Mode Hold Time (Pn625) must have elapsed.
- The following command must have been sent from the Controller.
- Interpolated Position Mode: Bit 8 in *controlword* (6040h) = 1 (stop axis according to *halt option code* (605Dh)) or bit 4 = 0 (disable interpolation).
- Cyclic Synchronous Position/Velocity Mode or Profile Velocity Mode: Bit 8 in *controlword* (6040h) = 1 (Halt).
- Profile Torque or Cyclic Synchronous Torque Mode: Bits 1 and 2 in *controlword* (6040h) = 1 (Shutdown).
- Homing Mode or Profile Position Mode: No condition.

Note: If the HWBB function has turned OFF the servo, normal operation will be enabled when the corresponding safety request input signal turns ON.

◆ Recovery Procedure

1. After detecting that bit 8 in *statusword* (6041h) is 1 (Active Mode Function operating) or that bit 15 is 1 (safety function operating), set bit 8 in *controlword* (6040h) to 1 (stop axis according to *halt option code* (605Dh)).
2. After detecting that the safety request input signal turned ON, confirm that bit 8 in *statusword* (6041h) is 0 (Active Mode Function operation completed) and that bit 15 is 0 (safety function operation completed), and then specify the Servo ON command (Enable Operation command) in *controlword* (6040h).
3. Specify a new motion command.

EtherCAT Communications

13

This chapter provides basic information on EtherCAT communications.

13.1	EtherCAT Slave Information	13-2
13.2	EtherCAT State Machine	13-3
13.3	EtherCAT (CoE) Communications Settings	13-5
13.3.1	Normal Device Recognition Process at Startup	13-5
13.3.2	Application Example	13-5
13.3.3	Device Recognition with Station Aliases	13-5
13.4	PDO Mappings	13-6
13.4.1	Setting Procedure for PDO Mappings	13-7
13.4.2	Default PDO Mappings	13-7
13.5	Synchronization with Distributed Clocks	13-8
13.6	Emergency Messages	13-11

13.1 EtherCAT Slave Information

You can use EtherCAT slave information files (XML format) to configure the EtherCAT master. The XML file contains general information on EtherCAT communications settings that are related to the SERVOPACK settings.

The following file is provided for the SERVOPACK.

SERVOPACK	File Name
SGD7S-□□□DA0□	Yaskawa_SGD7S-xxxDA0xxxxF64.xml

13.2 EtherCAT State Machine

The EtherCAT state machine is used to manage the communications states between the master and slave applications when EtherCAT communications are started and during operation, as shown in the following figure. Normally, the state changes for requests from the master.

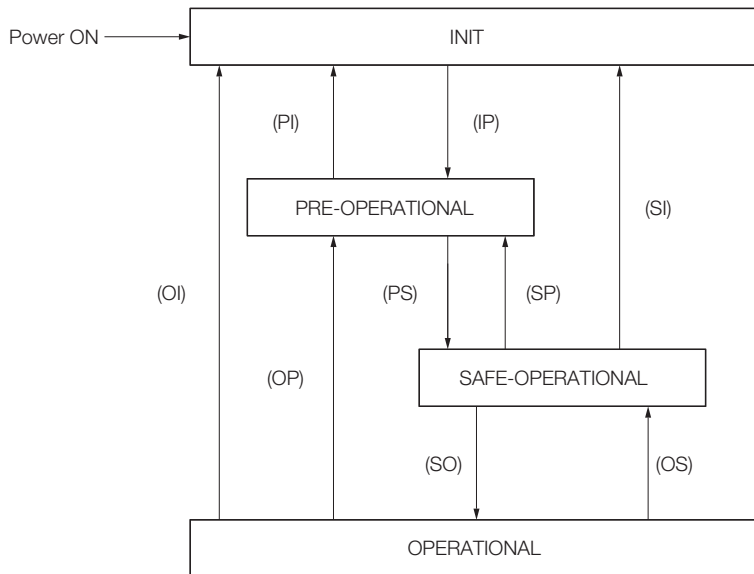

State	Description
INIT	<ul style="list-style-type: none"> Mailbox communications are not possible. Process data communications are not possible.
INIT => PRE-OP	<ul style="list-style-type: none"> The master sets the DL address and Sync Manager channels for mailbox communications. The master initializes DC clock synchronization. The master requests the Pre-Operational state. The master sets the AL control register. The slaves check whether the mailbox was initialized correctly.
PRE-OPERATIONAL (PREOP)	<ul style="list-style-type: none"> Mailbox communications are possible. Process data communications are not possible.
PREOP => SAFEOP	<ul style="list-style-type: none"> The master sets the Sync Manager channels and FMMU channels for process data. The master uses SDOs to set the PDO mappings and the Sync Manager PDO Assignment parameters. The master requests the Safe-Operational state. The slaves check whether the Sync Manager channels for process data communications and, if required, the distributed clock settings are correct.
SAFE-OPERATIONAL (SAFEOP)	<ul style="list-style-type: none"> Mailbox communications are possible. Process data communications are possible. However, only the input data is valid. The output data is still not valid.
SAFEOP => OP	<ul style="list-style-type: none"> The master sends valid output data. The master requests the Operational state.
OPERATIONAL (OP)	<ul style="list-style-type: none"> Mailbox communications are possible. Process data communications are possible.

Information

1. The SERVOPACK does not support EtherCAT Read/Write commands (APRW, FPRW, BRW, and LRW).
2. For SDO and PDO communications through the EtherCAT data link layer, the FMMUs and Sync Managers must be set as follows:

- Sync Manager Settings

Sync Manager	Assignment (Fixed)	Size	Start Address (Fixed)
Sync Manager 0	Assigned to Receive Mailbox	128 bytes (fixed)	0x1000
Sync Manager 1	Assigned to Transmit Mailbox	128 bytes (fixed)	0x1080
Sync Manager 2	Assigned to Receive PDOs	0 to 256 bytes (0 to 200 bytes*)	0x1100
Sync Manager 3	Assigned to Transmit PDOs	0 to 256 bytes (0 to 200 bytes*)	0x1400 (0x1358*)

* This is the size and first address for a SERVOPACK with a revision number (object 1018h: 03h) of 0x00020000 or lower. This setting can also be used with a revision number (object 1018h: 03h) of 0x00030001 or higher.

- FMMU Settings

FMMU	Setting
FMMU 0	Mapped in receive PDO (RxPDO) area.
FMMU 1	Mapped in transmit PDO (TxPDO) area.
FMMU 2	Mapped to the mailbox status.

13.3 EtherCAT (CoE) Communications Settings

You can use EtherCAT secondary addresses (station aliases) to identify devices or to specify addresses.

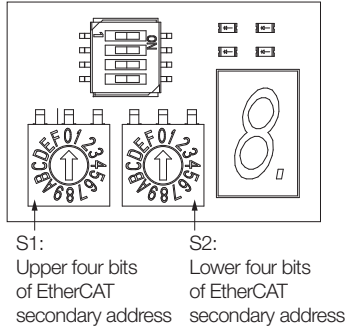

13.3.1 Normal Device Recognition Process at Startup

When communications are started, the master uses auto-increment addressing to detect the slaves. The Identity objects read from the slaves are compared with the master configuration information (set in advance with an EtherCAT configuration tool). Therefore, the slaves must normally be connected in the network in the same order as they appear in the master configuration. However, you can define station aliases to enable using other network topologies.

13.3.2 Application Example

With a machining center, there may be two identical drives for operation in the X and Y directions. When a device is replaced, there is a chance that the cable may be connected in the wrong order. To prevent the drives from receiving incorrect process data, you can use station aliases to use explicit addresses for the drives.

13.3.3 Device Recognition with Station Aliases

The master uses auto-increment addressing to read the station aliases. It then compares the detected station aliases with the master configuration to get the topology that was set as the network topology.

Station Alias Register (0x0012)

The station alias is set in the ESC Configured Station Alias register when the power supply is turned ON.

The value of the register can be read as follows:

$$\text{Configured station alias} = (\text{S1 set value}) \times 16 + (\text{S2 set value})$$

13.4 PDO Mappings

The process data that is used in process data communications is defined in the PDO mappings. PDO mappings are definitions of the applications objects that are sent with PDOs. The PDO mapping tables are in indexes 1600h to 1603h for the RxPDOs and indexes 1A00h to 1A03h for the TxPDOs in the object dictionary.

The following figure shows an example of PDO mappings.

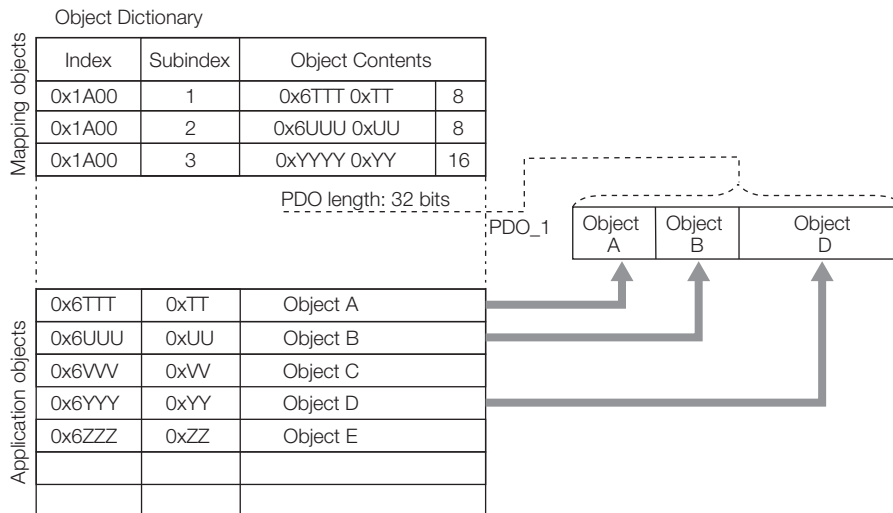

In addition to the above PDO mappings, PDOs have to be assigned to the Sync Managers to exchange EtherCAT process data.

The Sync Manager PDO assignment objects (1C12h and 1C13h) establish the relationship between these PDOs and the Sync Managers.

The following figure shows an example of a Sync Manager and the PDO mappings.

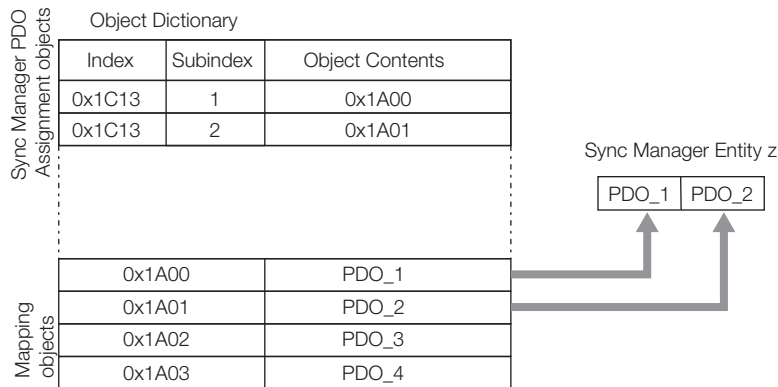

CAUTION

- The PDO mapping objects (indexes 1600h to 1603h and 1A00h to 1A03h) and the Sync Manager PDO assignment objects (index 1C12h and 1C13h) can be written only in Pre-Operation state.

13.4.1 Setting Procedure for PDO Mappings

1. Disable the assignments between the Sync Manager and PDOs.
(Set subindex 0 of objects 1C12h to 1C13h to 0.)
2. Set all of the mapping entries for the PDO mapping objects.
(Set objects 1600h to 1603h and 1A00h to 1A03h.)
3. Set the number of mapping entries for the PDO mapping objects.
(Set subindex 0 of objects 1600h to 1603h and 1A00h to 1A03h.)
4. Set the assignments between the Sync Manager and PDOs.
(Set subindex 1 of objects 1C12h to 1C13h.)
5. Enable the assignments between the Sync Manager and PDOs.
(Set subindex 0 of objects 1C12h to 1C13h to 1.)

13.4.2 Default PDO Mappings

The following table shows the default PDO mappings for the SERVOPACK. These initial settings are also defined in the EtherCAT slave information file (XML format).

- 1st PDO Mapping (Position, Velocity, Torque, Torque Limit, and Touch Probe)

RxPDO (1600h)	Controlword (6040h)	Target position (607Ah)	Target velocity (60FFh)	Target torque (6071h)	Max torque (6072h)	Mode of operation (6060h)	Padding (8 bits)	Touch probe function (60B8h)
TxPDO (1A00h)	Statusword (6041h)	Position actual value (6064h)	Torque actual value (6077h)	Following error actual value (60F4h)	Modes of operation display (6061h)	Padding (8 bits)	Touch probe status (60B9h)	Touch probe value (60BAh)

- 2nd PDO Mapping (Cyclic Synchronous Position): Default PDO Assignments

RxPDO (1601h)	Controlword (6040h)	Target position (607Ah)
TxPDO (1A01h)	Statusword (6041h)	Position actual value (6064h)

- 3rd PDO Mapping (Cyclic Synchronous Velocity)

RxPDO (1602h)	Controlword (6040h)	Target velocity (60FFh)
TxPDO (1A02h)	Statusword (6041h)	Position actual value (6064h)

- 4th PDO Mapping (Cyclic Synchronous Torque)

RxPDO (1603h)	Controlword (6040h)	Target torque (6071h)	
TxPDO (1A03h)	Statusword (6041h)	Position actual value (6064h)	Torque actual value (6077h)

13.5 Synchronization with Distributed Clocks

The synchronization of EtherCAT communications is based on a mechanism called a distributed clock. With the distributed clock, all devices are synchronized with each other by sharing the same reference clock. The slave devices synchronize the internal applications to the Sync0 events that are generated according to the reference clock.

You can use the following synchronization modes with EtherCAT (CoE). You can change the synchronization mode in the Sync Control registers (ESC registers 0x980 and 0x981).

- Free-Run (ESC register 0x980 = 0x0000)
In Free-Run mode, the local cycle is independent from the communications cycle and master cycle.
- DC Mode (ESC register 0x980 = 0x0300)
In this mode, the SERVOPACK is synchronized with the host controller (master) on the Sync0 event.

The following figure gives a timing chart for DC synchronization.

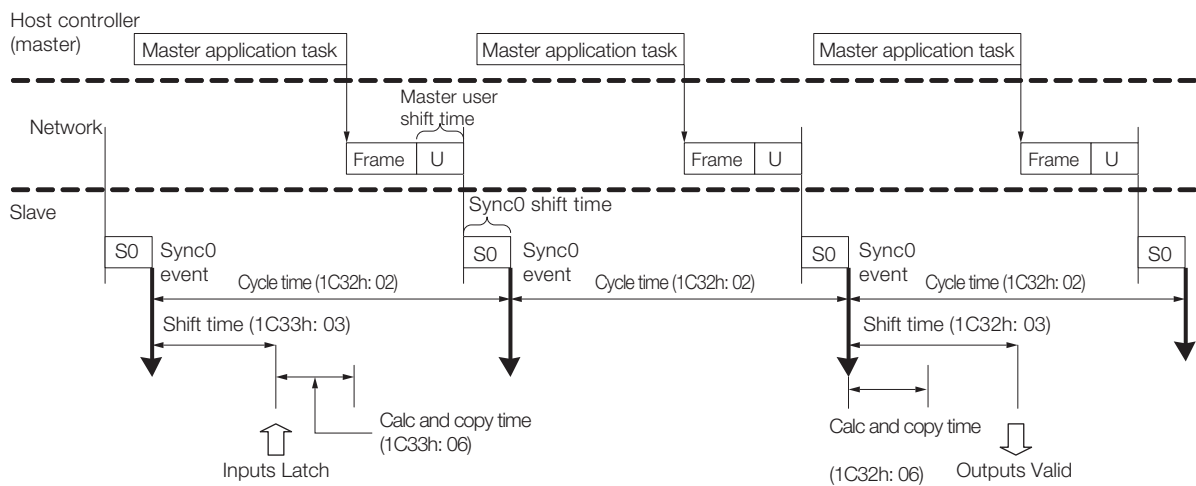

Index	Sub-index	Name	Access	PDO Mapping	Data Type	Description
Sync manager channel 2 synchronization						
1C32h	1	Synchronization type	RO	No	UINT	Current status of DC mode 0: Free-run 2: DC mode (synchronous with Sync0)
	2	Cycle time	RO	No	UDINT	Sync0 event cycle [ns] (The value is set by the master via an ESC register.) Range: $125,000 \times n$ ($n = 1$ to 32) [ns]
	3	Shift time	RO	No	UDINT	125,000 [ns] (fixed) The time between the Sync0 event and Outputs Valid (i.e., the time from Sync0 until the output data is input to the SERVOPACK).
	6	Calc and copy time	RO	No	UDINT	62,500 [ns] (fixed) The time from the Sync0 event until the output data from Sync Manager 2 is read.
Sync manager channel 3 synchronization						
1C33h	3	Shift time	RW	No	UDINT	$125,000 \times n$ ($n = 1$ to 32) [ns] Range: 0 to (Sync0 event cycle - 125,000) [ns] The time between the Sync0 event and Inputs Latch (i.e., when the input data is obtained from the SERVOPACK).
	6	Calc and copy time	RO	No	UDINT	62,500 [ns] (fixed) The time for copying the input process data to the Sync Manager 3 area.

Example of PDO Data Exchange Timing in DC Mode

- DC Cycle Time = 1 ms, Input Shift Time = 500 μ s

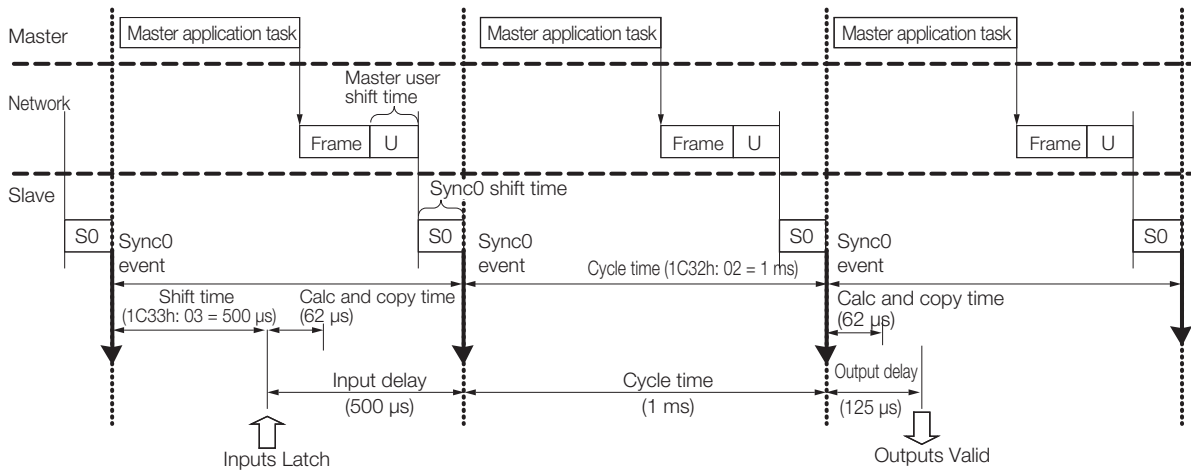

- DC Cycle Time = 125 μ s, Input Shift Time = 0 μ s

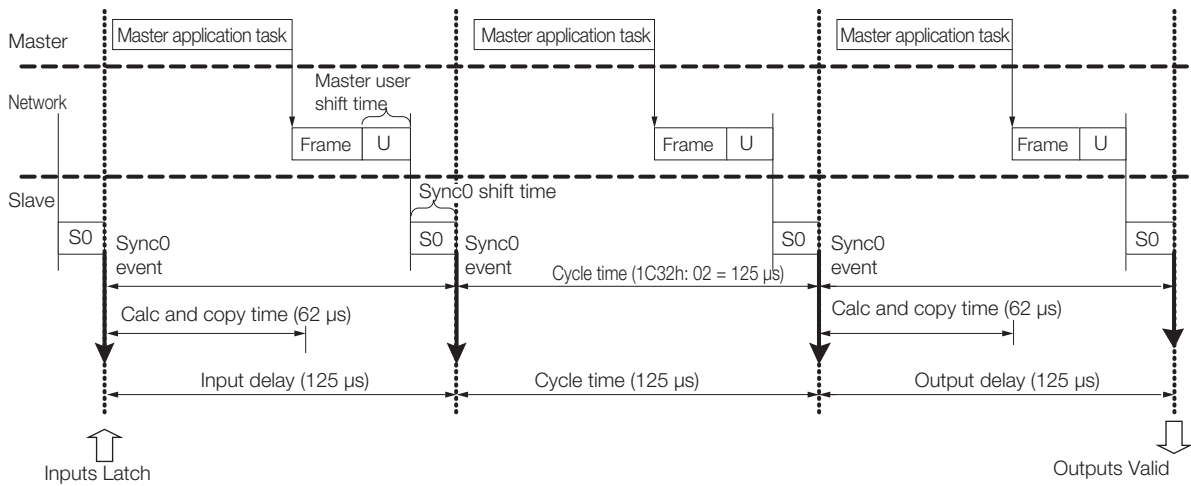

13.6 Emergency Messages

Emergency messages are triggered by alarms and warnings detected within the SERVOPACK. They are sent via the mailbox interface.

An emergency message consists of eight bytes of data as shown in the following table.

Byte	0	1	2	3	4	5	6	7
Description	Emergency error code (FF00h)* ¹		Error register (object 1001h)	Reserved.	Manufacturer-specific error field			
					SERVOPACK alarm/warning code* ²		Reserved.	

*1. The manufacturer-specific error code is always FF00h.

*2. For details on SERVOPACK alarms and warnings, refer to the following sections.

 16.2.2 *Troubleshooting Alarms* on page 16-11

 16.3.2 *Troubleshooting Warnings* on page 16-49

CiA402 Drive Profile

14

14.1	Device Control	14-3
14.1.1	State Machine Control Commands	14-4
14.1.2	Bits in Statusword (6041h)	14-4
14.1.3	Related Objects	14-4
14.2	Modes of Operation	14-5
14.2.1	Related Objects	14-5
14.2.2	Dynamic Mode Changes	14-5
14.3	Position Control Modes	14-6
14.3.1	Profile Position Mode	14-6
14.3.2	Interpolated Position Mode	14-9
14.3.3	Cyclic Synchronous Position Mode	14-12
14.4	Homing	14-14
14.4.1	Related Objects	14-14
14.4.2	Homing Method (6098h)	14-14
14.5	Velocity Control Modes	14-17
14.5.1	Profile Velocity Mode	14-17
14.5.2	Cyclic Synchronous Velocity Mode	14-18
14.6	Torque Control Modes	14-19
14.6.1	Profile Torque Mode	14-19
14.6.2	Cyclic Sync Torque Mode	14-20
14.7	Torque Limits	14-21

14.8	Digital I/O Signals	14-22
14.9	Touch Probe	14-23
14.9.1	Related Objects	14-23
14.9.2	Example of Execution Procedure for a Touch Probe	14-24
14.10	Fully-Closed Loop Control	14-25

14.1 Device Control

You use the *controlword* (6040h) to execute device control for the Servo Drive according to the following state transitions. You can use the *statusword* (6041h) to monitor the device status of the Servo Drive.

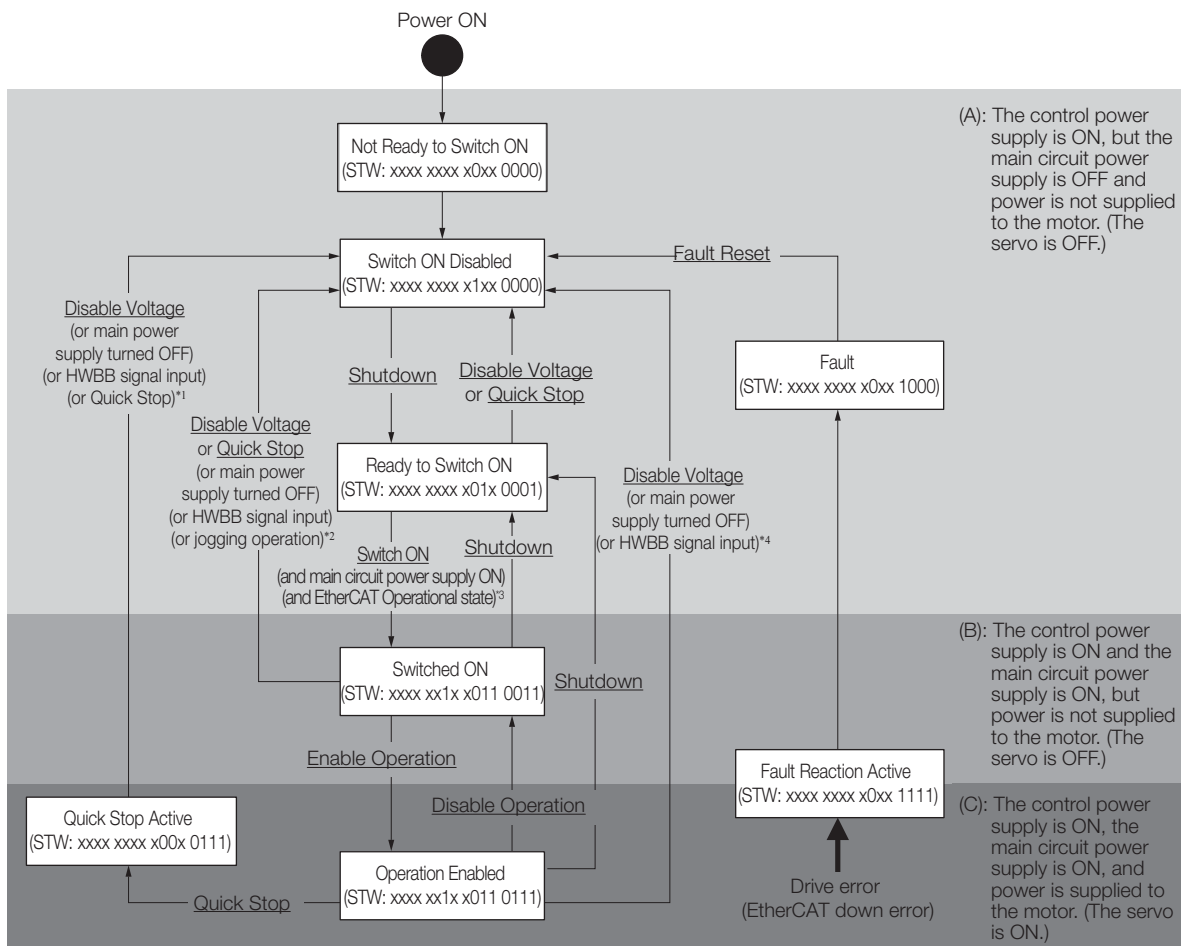

- *1. In the Quick Stop Active state, the SERVOPACK automatically moves to the Switch ON Disabled state in the following cases:
- The main power supply was turned OFF.
 - The HWBB signal was input.
 - The motor was stopped.
- *2. In the Switched ON state, the SERVOPACK automatically moves to the Switch ON Disabled state in the following cases:
- The main power supply was turned OFF.
 - The HWBB signal was input.
 - Motor operation was already enabled by the Digital Operator or the SigmaWin+.
- *3. In the Ready to Switch ON state, the SERVOPACK moves to the next state in the following cases:
- The main circuit power supply is ON.
 - The EtherCAT state machine (ESM) is in the Operational state.
 - The Servomotor is not being operated by the Digital Operator or the SigmaWin+.
- *4. In the Operation Enabled state, the SERVOPACK automatically moves to the Switch ON Disabled state in the following cases:
- The main power supply was turned OFF.
 - The HWBB signal was input.

Note: 1. : The states are shown in white boxes.

2. STW indicates the *statusword* (6041h).

3. _____: Underlines indicate control commands in the *controlword* (6040h).

14.1.1 State Machine Control Commands

Command	Bits in Controlword (6040h)				
	Bit 7	Bit 3	Bit 2	Bit 1	Bit 0
Shutdown	0	–	1	1	0
Switch ON	0	0	1	1	1
Switch ON + Enable Operation	0	1	1	1	1
Disable Voltage	0	–	–	0	–
Quick Stop	0	–	0	1	–
Disable Operation	0	0	1	1	1
Enable Operation	0	1	1	1	1
Fault Reset	0 → 1	–	–	–	–

14.1.2 Bits in Statusword (6041h)

Bit	Data Description	Remarks
0	Ready to Switch ON	Refer to the following section for details.  15.6 Device Control on page 15-23
1	Switched ON	
2	Operation Enabled	
3	Fault	
4	Voltage Enabled	
5	Quick Stop	
6	Switch ON Disabled	
7	Warning	
8	Active Mode Stop	
9	Remote	
10	Target Reached	
11	Internal Limit Active	
12	Operation Mode Specific	
13		
14	Torque Limit Active	
15	Safety Active	

14.1.3 Related Objects

Index	Subindex	Name	Access	PDO Mapping	Unit	Data Type
6040h	0	Controlword	RW	Yes	–	UINT
6041h	0	Statusword	RO	Yes	–	UINT
605Ah	0	Quick stop option code	RW	No	–	INT
605Bh	0	Shutdown option code	RW	No	–	INT
605Ch	0	Disable operation option code	RW	No	–	INT
605Dh	0	Halt option code	RW	No	–	INT
605Eh	0	Fault reaction option code	RW	No	–	INT

14.2 Modes of Operation

The SERVOPACK supports the following modes of operation.

- Profile Position Mode
- Homing Mode
- Interpolated Position Mode
- Profile Velocity Mode
- Torque Profile Velocity Mode
- Cyclic Sync Position Mode
- Cyclic Sync Velocity Mode
- Cyclic Sync Torque Mode

14.2.1 Related Objects

Index	Subindex	Name	Access	PDO Mapping	Unit	Data Type
6060h	0	Modes of operation	RW	Yes	–	SINT
6061h	0	Modes of operation display	RO	Yes	–	SINT
6502h	0	Supported drive modes	RO	No	–	UDINT

14.2.2 Dynamic Mode Changes

You can change the operation mode with *modes of operation* (6060h). The master must update all operation mode-specific process data objects at the same time when it changes the operation mode during motor operation. If the master selects a new operation mode, the SERVOPACK will change to the new operation mode immediately. The following table describes operation when the operation mode is changed to a new mode.

New Operation Mode	Operation When Operation Mode Is Changed
Profile Position Mode	Controlword bit 4 = 0: The motor is stopped in the current position control mode. Controlword bit 4 = 1: A new positioning operation is started immediately.
Homing Mode	Controlword bit 4 = 0: The motor is stopped in the current position control mode. Controlword bit 4 = 1: Homing is started immediately.
Interpolated Position Mode	Controlword bit 4 = 0: The motor is stopped in the current position control mode. Controlword bit 4 = 1: A new positioning operation is started immediately.
Profile Velocity Mode	The new operation mode is started immediately.
Torque Profile Velocity Mode	The new operation mode is started immediately.
Cyclic Sync Position Mode	The new operation mode is started immediately.
Cyclic Sync Velocity Mode	The new operation mode is started immediately.
Cyclic Sync Torque Mode	The new operation mode is started immediately.

14.3 Position Control Modes

14.3.1 Profile Position Mode

The Profile Position Mode is used to position to the target position at the profile velocity and the profile acceleration.

The following figure shows the block diagram for the Profile Position Mode.

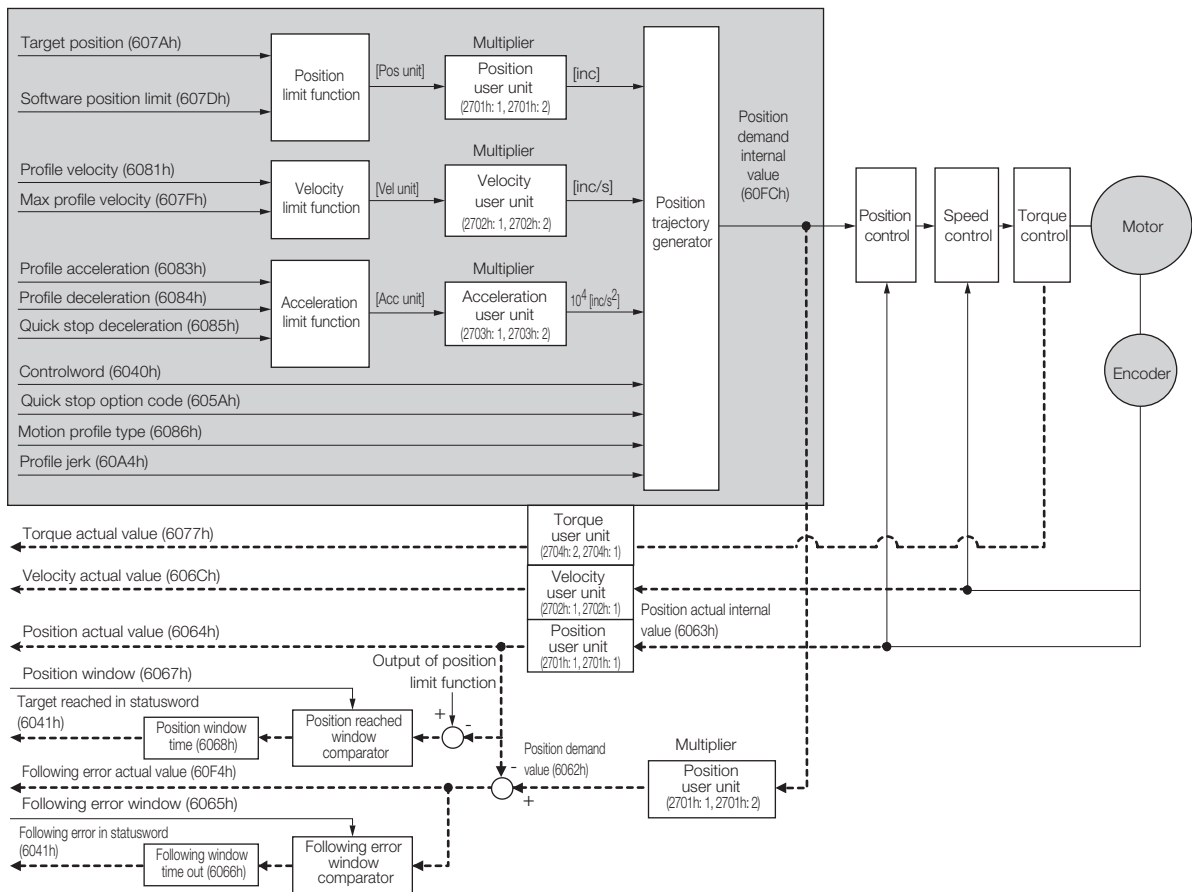

Related Objects

Index	Subindex	Name	Access	PDO Mapping	Unit	Data Type
6040h	0	Controlword	RW	Yes	-	UINT
6041h	0	Statusword	RO	Yes	-	UINT
607Ah	0	Target position	RW	Yes	Pos unit	DINT
607Dh	Software position limit					
	1	Min position limit	RW	No	Pos unit	DINT
	2	Max position limit	RW	No	Pos unit	DINT
607Fh	0	Max profile velocity	RW	Yes	Vel unit	UDINT
6081h	0	Profile velocity	RW	Yes	Vel unit	UDINT
6083h	0	Profile acceleration	RW	Yes	Acc unit	UDINT
6084h	0	Profile deceleration	RW	Yes	Acc unit	UDINT
6085h	0	Quick stop deceleration	RW	Yes	Acc unit	UDINT
6086h	-	Motion profile type	RW	Yes	-	INT
60A4h	Profile jerk					
	1	Profile jerk 1	RW	No	%	UDINT

In the Profile Position Mode, the following two methods can be used to start positioning.

◆ Single Set Point (When Change Set Immediately Bit (Bit 5) in *Controlword* Is 1)

When a new command is input to the New Set Point bit (bit 4) in *controlword* during positioning, positioning for the new command is started immediately.

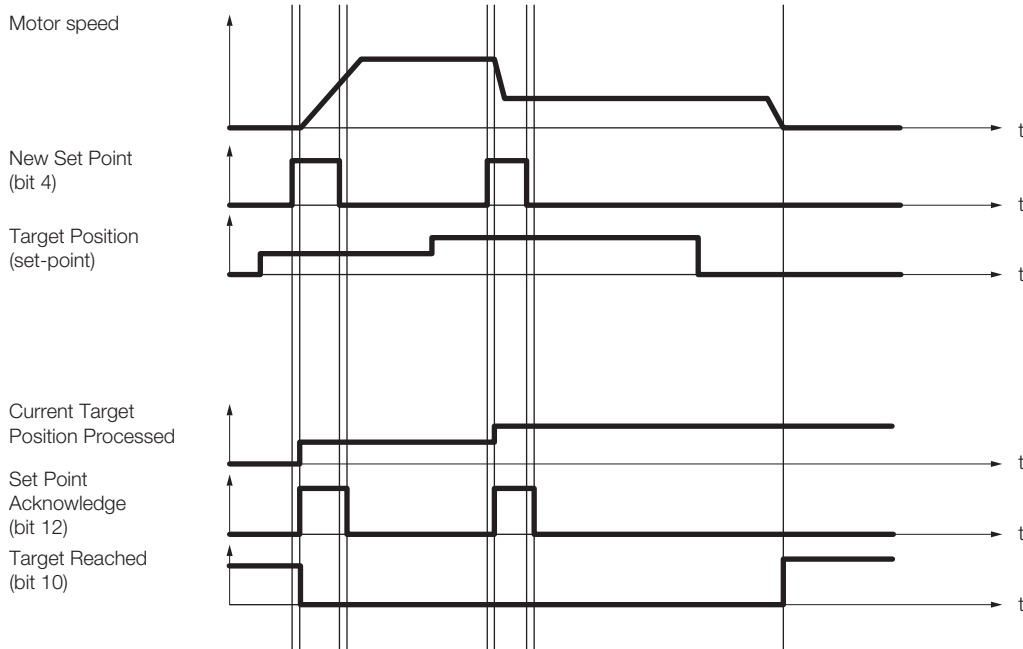

◆ Set of Set Points (When Change Set Immediately Bit (Bit 5) in *Controlword* Is 0)

When a new command is input in the New Set Point bit (bit 4) in *controlword* during positioning, positioning for the new command is started as soon as the current positioning operation is completed. The dotted line in the following figure shows the actual speed if the Change of Set Point bit (bit 9) is set to 1.

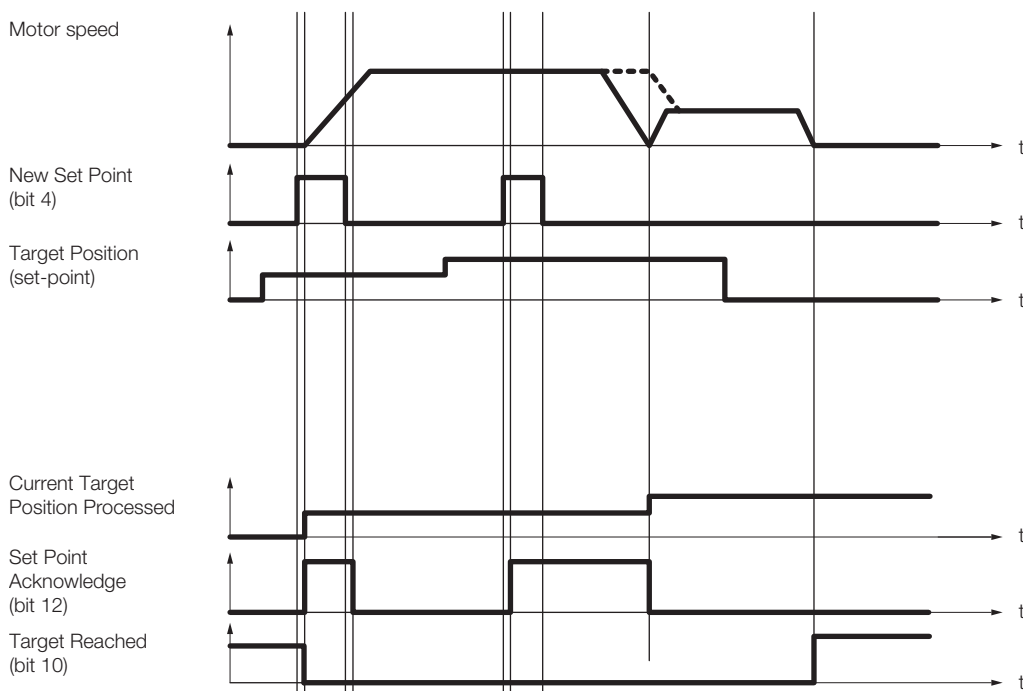

◆ SPOSING (S-curve Acceleration/Deceleration Positioning)

If you set *Motion profile type* to 2, S-curve acceleration/deceleration will be used for positioning to *Target position*.

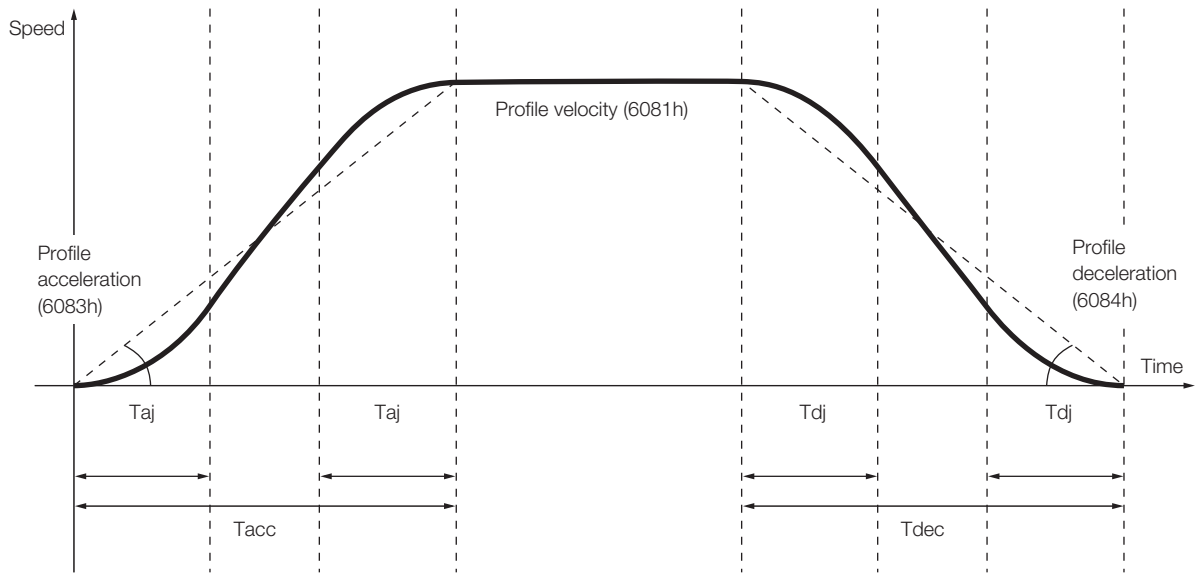

Acceleration time: $T_{acc} = \frac{\text{Profile velocity (6081h)}}{\text{Profile acceleration (6083h)}}$

S-curve acceleration time: $T_{aj} = T_{acc} \times \text{Profile jerk (60A4h)}$

Deceleration time: $T_{dec} = \frac{\text{Profile velocity (6081h)}}{\text{Profile deceleration (6084h)}}$

S-curve deceleration time: $T_{dj} = T_{dec} \times \text{Profile jerk (60A4h)}$



Important

1. If you change the *Target position* (607Ah), *Profile velocity* (6081h), *Profile acceleration* (6083h), or *Profile deceleration* (6084h), do so either while positioning is stopped or while positioning at a constant speed.
2. Set the S-curve acceleration/deceleration time in *Profile jerk* (60A4h).

14.3.2 Interpolated Position Mode

The Interpolated Position Mode is used to control multiple coordinated axes or to control a single axis that requires time interpolation of the set point data. There are the following two sub-modes for the Interpolated Position Mode.

Interpolation submode select (60C0h) is used to change the submode. Refer to the following section for details.

 15.10 Interpolated Position Mode on page 15-37

Interpolated Position Mode		Number of Data	Number of Profiles
Mode 1	No position reference filter	1	1
	Position reference filter		
Mode 2	No position reference filter	1 to 254	2
	Position reference filter		

Mode 1

This submode normally uses a time (communications) synchronization mechanism to synchronize the Servo Drives. The Interpolation Time Period defines the update cycle of the Interpolation Data (i.e., the interpolation position). The interpolation processing in the SERVOPACK is based on this setting. The Interpolation Data is interpreted as an absolute value.

The following figure shows the block diagram for mode 1.

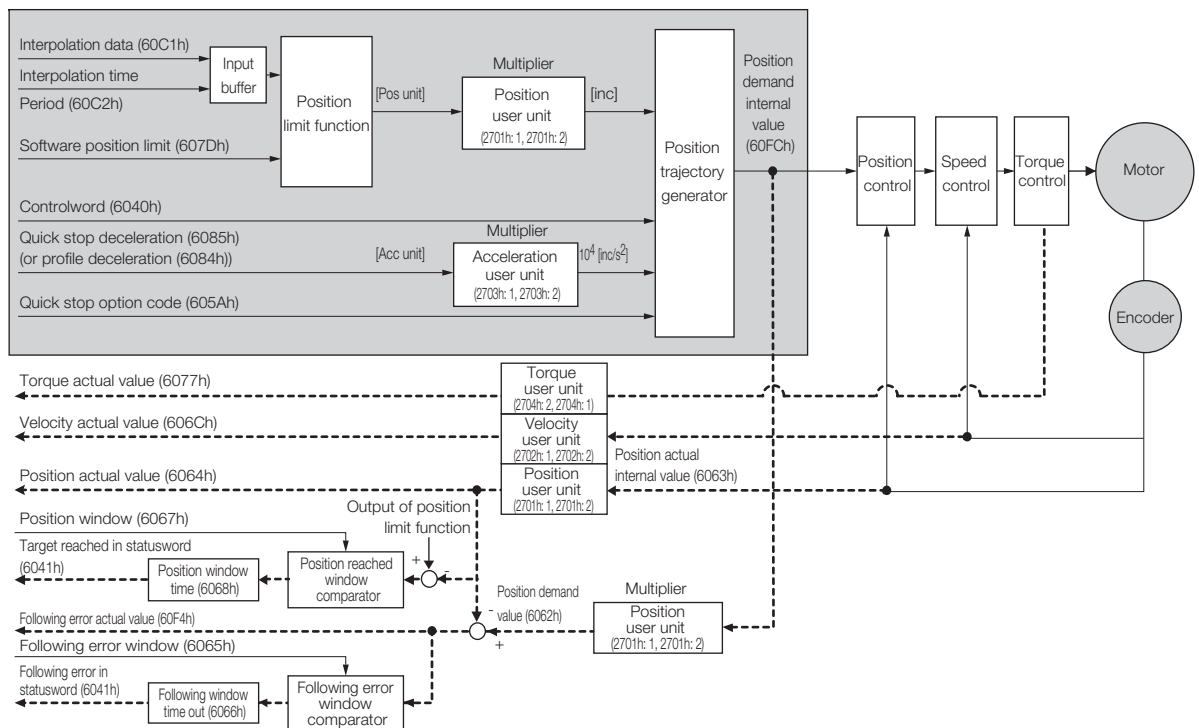

◆ Related Objects

Index	Subindex	Name	Access	PDO Mapping	Unit	Data Type
6040h	0	Controlword	RW	Yes	–	UINT
6041h	0	Statusword	RO	Yes	–	UINT
60C1h	1	Interpolation data record	RW	Yes	Pos unit	DINT

Continued on next page.

Continued from previous page.

Index	Subindex	Name	Access	PDO Mapping	Unit	Data Type
60C2h	Interpolation time period					
	1	Interpolation time period value	RW	No	–	USINT
	2	Interpolation time index	RW	No	–	SINT
607Dh	Software position limit					
	1	Min position limit	RW	No	Pos unit	DINT
	2	Max position limit	RW	No	Pos unit	DINT
6084h	0	Profile deceleration	RW	Yes	Acc unit	UDINT
6085h	0	Quick stop deceleration	RW	Yes	Acc unit	UDINT

Mode 2

This submode is used to perform interpolation feeding control for an individual axis. Unlike mode 1, mode 2 has reference input buffers (*interpolation data record for 1st profile* and *interpolation data record for 2nd profile*) that you can set to different interpolation positions (*interpolation data record*). The interpolation positions that are set in the reference input buffers are read each *interpolation time period* to perform interpolation processing.

The following figure shows the block diagram for mode 2.

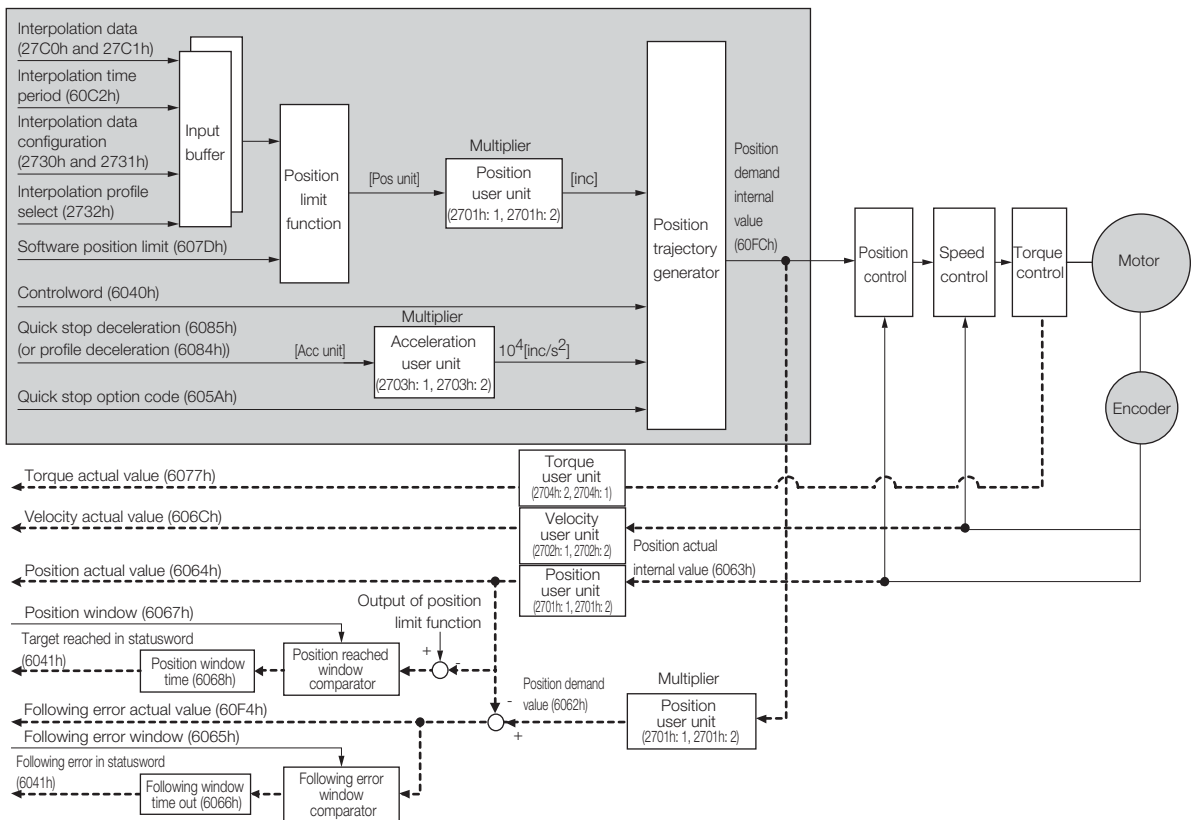

◆ Related Objects

Index	Subindex	Name	Access	PDO Mapping	Unit	Data Type
6040h	0	Controlword	RW	Yes	–	UINT
6041h	0	Statusword	RO	Yes	–	UINT
60C2h	Interpolation time period					
	1	Interpolation time period value	RW	No	–	USINT
	2	Interpolation time index	RW	No	–	SINT

Continued on next page.

Continued from previous page.

Index	Subindex	Name	Access	PDO Mapping	Unit	Data Type
2730h	Interpolation data configuration for 1st profile					
	1	Maximum buffer size	RO	No	–	UDINT
	2	Actual buffer size	RW	No	–	UDINT
	3	Buffer organization	RW	No	–	USINT
	4	Buffer position	RW	Yes	–	UINT
	5	Size of data record	RO	No	–	USINT
	6	Buffer clear	RO	No	–	USINT
	7	Position data definition	RW	Yes	–	USINT
	8	Position data polarity	RW	Yes	–	USINT
	9	Behavior after reaching buffer position	RW	Yes	–	USINT
2731h	Interpolation data configuration for 2nd profile					
	1	Maximum buffer size	RO	No	–	UDINT
	2	Actual buffer size	RW	No	–	UDINT
	3	Buffer organization	RW	No	–	USINT
	4	Buffer position	RW	Yes	–	UINT
	5	Size of data record	RO	No	–	USINT
	6	Buffer clear	RO	No	–	USINT
	7	Position data definition	RW	Yes	–	USINT
	8	Position data polarity	RW	Yes	–	USINT
	9	Behavior after reaching buffer position	RW	Yes	–	USINT
2732h	0	Interpolation profile select	RW	Yes	–	USINT
27C0h	1-254	Interpolation data record for 1 st profile	RW	No	Pos unit	DINT
27C1h	1-254	Interpolation data record for 2 nd profile	RW	No	Pos unit	DINT
2741h	Interpolation data read/write pointer position monitor					
	1	Interpolation data read pointer position	RO	Yes	–	UINT
	2	Interpolation data write pointer position	RO	Yes	–	UINT
607Dh	Software position limit					
	1	Min position limit	RW	No	Pos unit	DINT
	2	Max position limit	RW	No	Pos unit	DINT
6084h	0	Profile deceleration	RW	Yes	Acc unit	UDINT
6085h	0	Quick stop deceleration	RW	Yes	Acc unit	UDINT

◆ Object Setting Procedure

The recommended object setting procedure to use mode 2 is given in the following table.

Step	Description
1	Set <i>interpolation submode select</i> (60C0h).
2	Set <i>interpolation profile select</i> (2732h).
3	Set <i>interpolation data configuration for 1st profile</i> (2730h) and <i>interpolation data configuration for 2nd profile</i> (2731h).
4	Set <i>interpolation data record for 1st profile</i> (27C0h) and <i>interpolation data record for 2nd profile</i> (27C1h).
5	Set <i>mode of operation</i> (6060h).
6	Set <i>enable interpolation</i> (6060h bit 4).

14.3.3 Cyclic Synchronous Position Mode

The Cyclic Synchronous Position Mode is used for the interpolated positioning in the same way as the Interpolated Position Mode. In this mode, speed and torque compensations can be specified by the master to enable speed and torque feedforward.

The *interpolation time period* defines the interval at which the target position is updated. Interpolation is performed in the SERVOPACK according to this setting. The target position is interpreted as an absolute value.

The following figure shows the block diagram for the Cyclic Synchronous Position Mode.

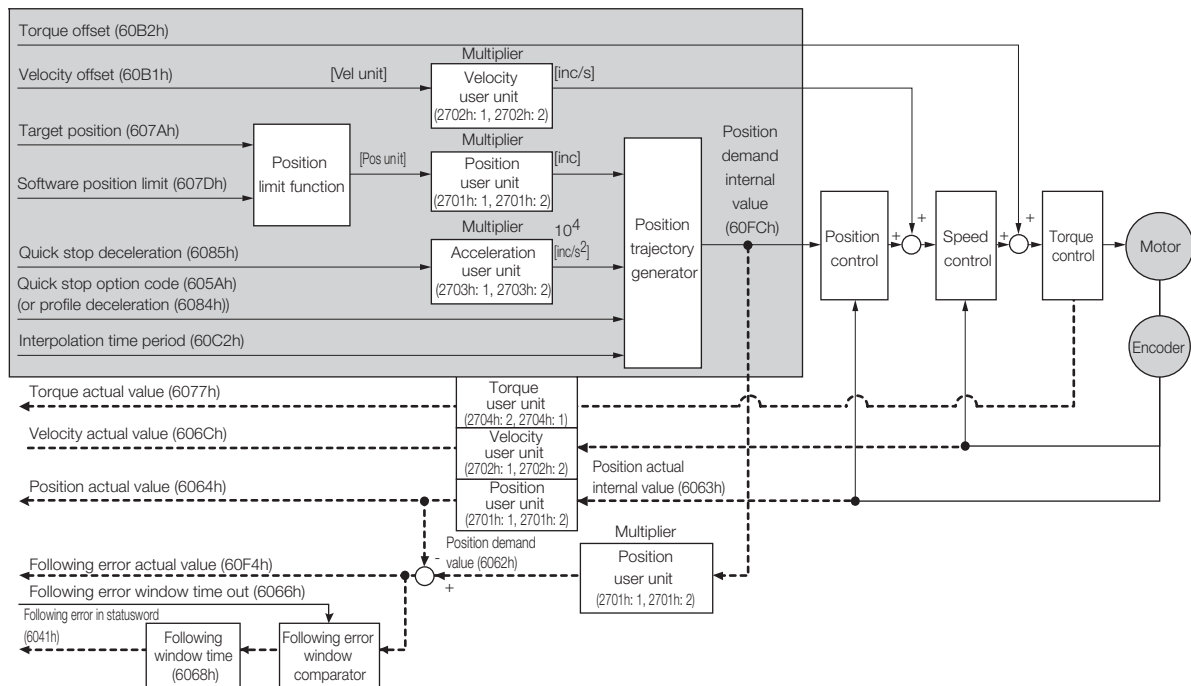

◆ Related Objects

Index	Subindex	Name	Access	PDO Mapping	Unit	Data Type
607Ah	0	Target position	RW	Yes	Pos unit	DINT
607Dh	Software position limit					
	1	Min position limit	RW	No	Pos unit	DINT
	2	Max position limit	RW	No	Pos unit	DINT
6084h	0	Profile deceleration	RW	Yes	Acc unit	UDINT
6085h	0	Quick stop deceleration	RW	Yes	Acc unit	UDINT

Continued on next page.

Continued from previous page.

Index	Subindex	Name	Access	PDO Mapping	Unit	Data Type
60B1h	0	Velocity offset	RW	Yes	Vel unit	DINT
60B2h	0	Torque offset	RW	Yes	Trq unit	INT
60C2h	Interpolation time period					
	1	Interpolation time period value	RO	No	–	USINT
	2	Interpolation time index	RO	No	–	SINT

14.4 Homing

The following figure shows the relationship between the input objects and the output objects in the Homing Mode. You can specify the speeds, acceleration rate, and homing method. You can also use *home offset* to offset zero in the user coordinate system from the home position.

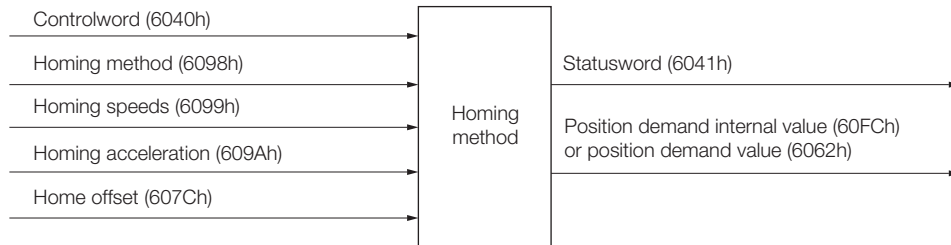

14.4.1 Related Objects

Index	Subindex	Name	Access	PDO Mapping	Unit	Data Type
6040h	0	Controlword	RW	Yes	–	UINT
6041h	0	Statusword	RO	Yes	–	UINT
607Ch	0	Home offset	RW	No	Pos unit	DINT
6098h	0	Homing method	RW	Yes	–	SINT
		Homing speeds				
6099h	1	Speed during search for switch	RW	Yes	Vel unit	UDINT
	2	Speed during search for zero	RW	Yes	Vel unit	UDINT
609Ah	0	Homing acceleration	RW	Yes	Acc unit	UDINT

14.4.2 Homing Method (6098h)

Value	Definition	Description
0	–	No homing
1	Homing with the negative limit switch and index pulse	<p>With this method, homing starts in the negative direction if the negative limit switch is inactive. The home position is the first index pulse that is detected after the negative limit switch becomes inactive.</p> <p>Index pulse</p> <p>Negative limit switch (N-OT)</p>

Continued on next page.

Continued from previous page.

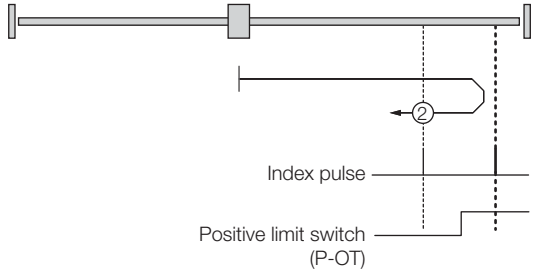
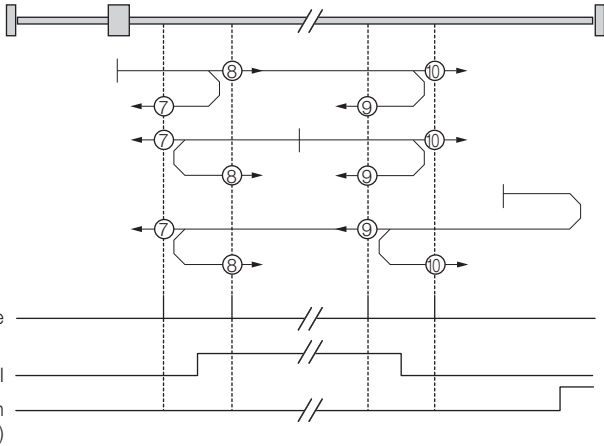
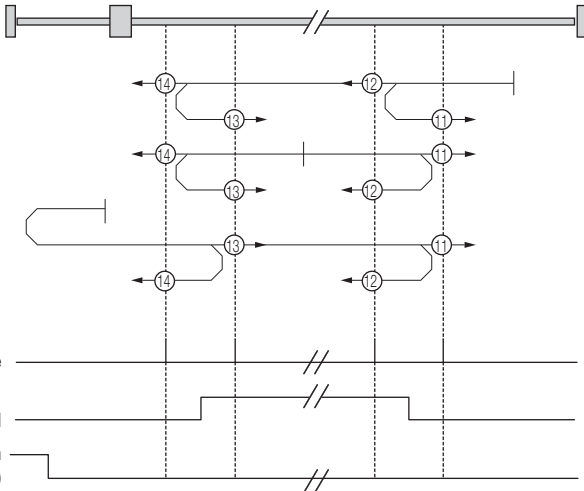
Value	Definition	Description
2	Homing with the positive limit switch and index pulse	<p>With this method, homing starts in the positive direction if the positive limit switch is inactive. The home position is the first index pulse that is detected after the positive limit switch becomes inactive.</p>  <p style="text-align: right;">Index pulse Positive limit switch (P-OT)</p>
7 to 10	Homing with the home switch input (/Home) signal and index pulse and starting in the positive direction	<p>With methods 7 to 10, homing starts in the positive direction. However, if the /Home signal is already active when homing is started, the initial homing direction depends on the required edge. The home position will be the index pulse on either the rising or falling edge side of the /Home signal. If the initial movement direction is away from the /Home signal, the motor will reverse direction when the limit switch in the movement direction is input.</p>  <p style="text-align: right;">Index pulse /Home signal Positive limit switch (P-OT)</p>
11 to 14	Homing with the home switch input (/Home) signal and index pulse and starting in the negative direction	<p>These methods are similar to methods 7 to 10 except that homing starts in the negative direction.</p>  <p style="text-align: right;">Index pulse /Home signal Negative limit switch (N-OT)</p>

Continued on next page.

14.4 Homing

14.4.2 Homing Method (6098h)

Continued from previous page.

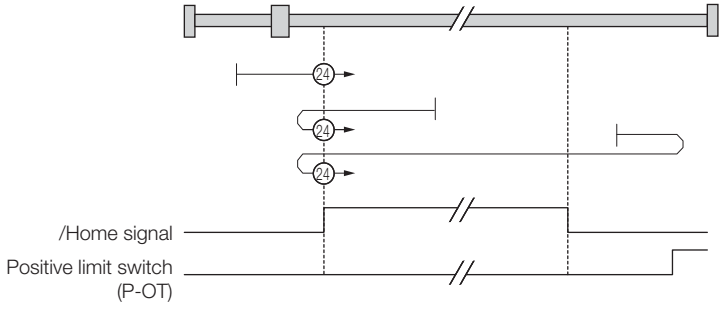
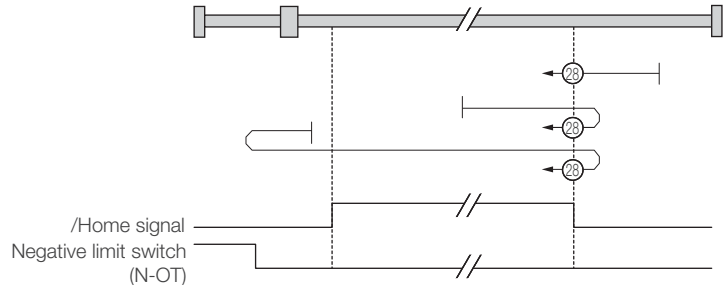
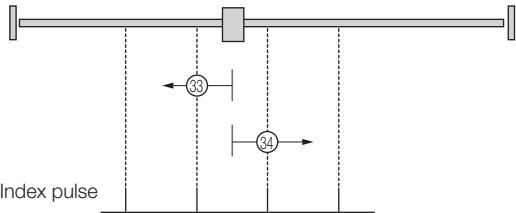
Value	Definition	Description
24	Homing with the home switch input (/Home) signal and starting in the positive direction	<p>This method is same as method 8 except that the home position does not depend on the index pulse. Here, it depends only on changes in the relevant /Home signal or limit switch.</p> 
28	Homing with the home switch input (/Home) signal and starting in the negative direction	<p>This method is same as method 12 except that the home position does not depend on the index pulse. Here, it depends only on changes in the relevant /Home signal or limit switch.</p> 
33, 34	Homing with the index pulse	
35	Homing with the current position	<p>With this method, the current position is defined as the home position. You can execute this method even if the Servo Drive is not in the Operation Enabled state (default setting).</p>

Note: The index pulse is the encoder's zero signal (phase C).

14.5 Velocity Control Modes

14.5.1 Profile Velocity Mode

In the Profile Velocity Mode, the speed is output according to the *profile acceleration* and *profile deceleration* until it reaches the *target velocity*.

The following figure shows the block diagram for the Profile Velocity Mode.

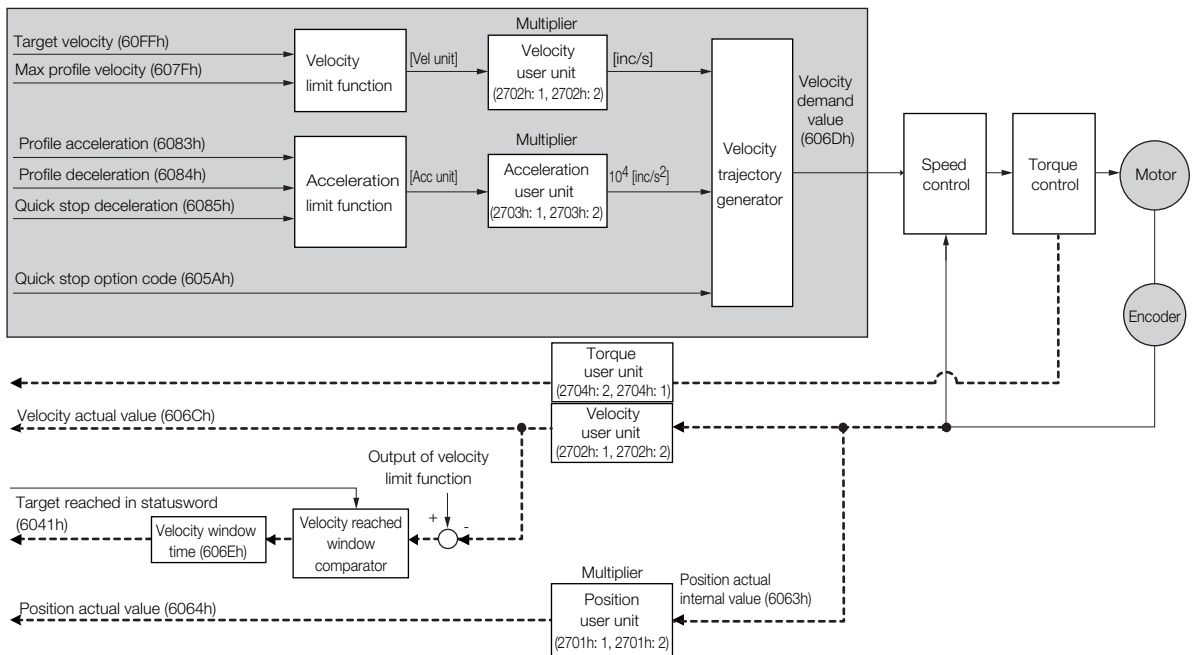

Related Objects

Index	Subindex	Name	Access	PDO Mapping	Unit	Data Type
60FFh	0	Target velocity	RW	Yes	Vel unit	DINT
607Fh	0	Max profile velocity	RW	Yes	Vel unit	UDINT
6083h	0	Profile acceleration	RW	Yes	Acc unit	UDINT
6084h	0	Profile deceleration	RW	Yes	Acc unit	UDINT
6085h	0	Quick stop deceleration	RW	Yes	Acc unit	UDINT
606Bh	0	Velocity demand value	RO	Yes	Vel unit	DINT
606Ch	0	Velocity actual value	RO	Yes	Vel unit	DINT
606Dh	0	Velocity window	RW	No	Vel unit	UINT
606Eh	0	Velocity window time	RW	No	ms	UINT

14.5.2 Cyclic Synchronous Velocity Mode

In the Cyclic Synchronous Velocity Mode, the master provides the target speed to the Servo Drive, which performs speed control. In this mode, a torque compensation can be specified by the master to enable torque feedforward.

The following figure shows the block diagram for the Cyclic Synchronous Velocity Mode.

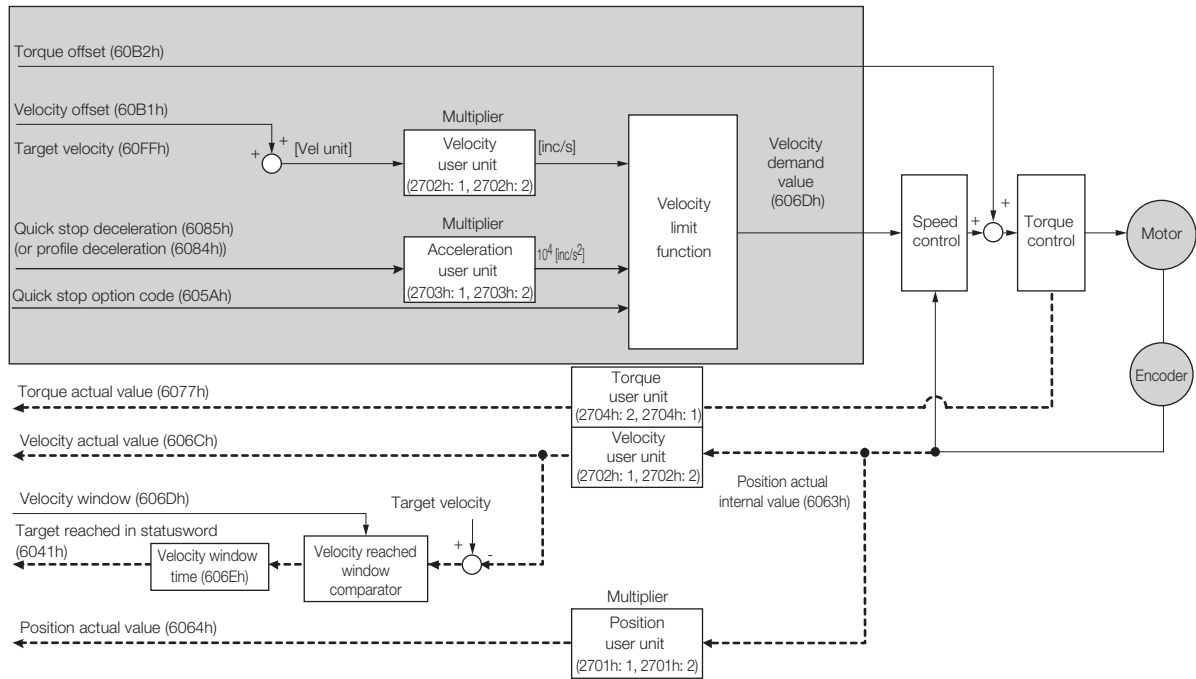

Related Objects

Index	Subindex	Name	Access	PDO Mapping	Unit	Data Type
60FFh	0	Target velocity	RW	Yes	Vel unit	DINT
60B1h	0	Velocity offset	RW	Yes	Vel unit	DINT
60B2h	0	Torque offset	RW	Yes	0.1% *	INT
6084h	0	Profile deceleration	RW	Yes	Acc unit	UDINT
6085h	0	Quick stop deceleration	RW	Yes	Acc unit	UDINT
606Bh	0	Velocity demand value	RO	Yes	Vel unit	DINT
606Ch	0	Velocity actual value	RO	Yes	Vel unit	DINT
606Dh	0	Velocity window	RW	No	Vel unit	UINT
606Eh	0	Velocity window time	RW	No	ms	UINT

* The rated motor torque is 100%.

14.6 Torque Control Modes

14.6.1 Profile Torque Mode

In the Profile Torque Mode, the torque is output up to the *target torque* according to the *torque slope* setting.

The following figure shows the block diagram for the Profile Torque Mode.

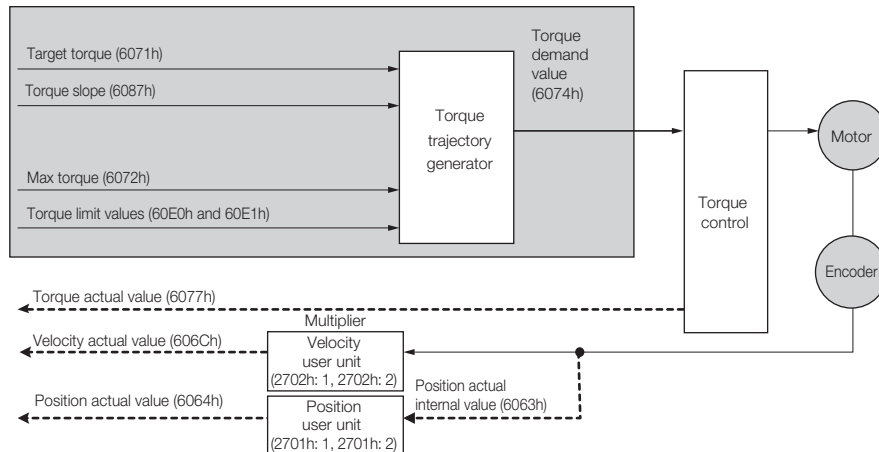

Related Objects

Index	Subindex	Name	Access	PDO Mapping	Unit	Data Type
6071h	0	Target torque	RW	Yes	0.1%*	INT
6087h	0	Torque slope	RW	Yes	0.1%/s*	UDINT
6074h	0	Torque demand value	RO	Yes	0.1%*	INT
6077h	0	Torque actual value	RO	Yes	0.1%*	INT
6072h	0	Max torque	RW	Yes	0.1%*	UINT
60E0h	0	Positive torque limit value	RW	Yes	0.1%*	UINT
60E1h	0	Negative torque limit value	RW	Yes	0.1%*	UINT

* The rated motor torque is 100%.

14.6.2 Cyclic Sync Torque Mode

In the Cyclic Synchronous Torque Mode, the master provides the *target torque* to the Servo Drive, which performs torque control.

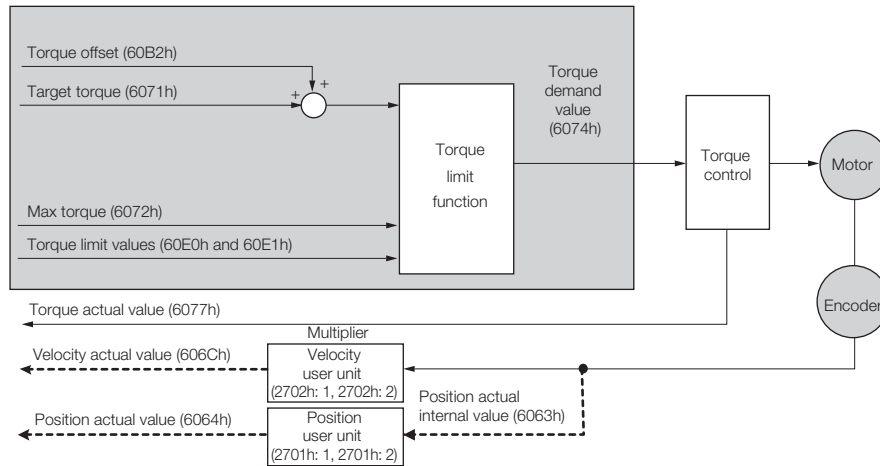

Related Objects

Index	Subindex	Name	Access	PDO Mapping	Unit	Data Type
6071h	0	Target torque	RW	Yes	0.1%*	INT
6074h	0	Torque demand value	RO	Yes	0.1%*	INT
6077h	0	Torque actual value	RO	Yes	0.1%*	INT
60B2h	0	Torque offset	RW	Yes	0.1%*	INT
6072h	0	Max torque	RW	Yes	0.1%*	UINT
60E0h	0	Positive torque limit value	RW	Yes	0.1%*	UINT
60E1h	0	Negative torque limit value	RW	Yes	0.1%*	UINT

* The rated motor torque is 100%.

14.7 Torque Limits

The following figure shows the block diagram for the torque limits. The torque is limited by the lowest limit value.

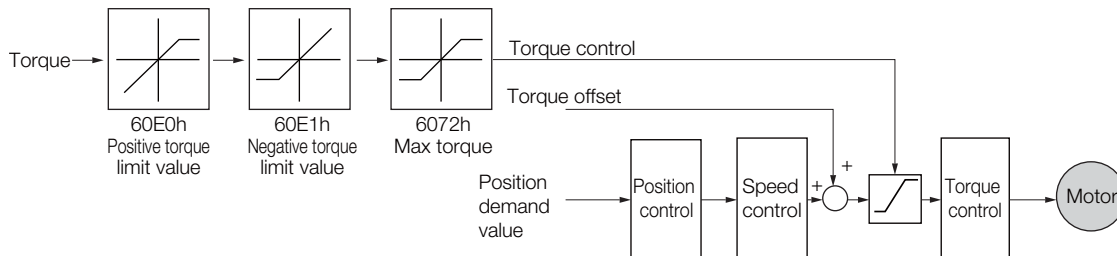

Related Objects

Index	Subindex	Name	Access	PDO Mapping	Unit	Data Type
6072h	0	Max torque	RW	Yes	0.1%*	UINT
60E0h	0	Positive torque limit value	RW	Yes	0.1%*	UINT
60E1h	0	Negative torque limit value	RW	Yes	0.1%*	UINT

* The rated motor torque is 100%.

14.8 Digital I/O Signals

The *digital inputs* and *digital outputs* are used to control the I/O signals of the CN1 connector on the SERVOPACK.

Index	Subindex	Name	Access	PDO Mapping	Unit	Data Type
60FDh	0	Digital inputs	RO	Yes	–	UDINT
60FEh	Digital outputs					
	1	Physical outputs	RW	Yes	–	UDINT
	2	Bit mask	RW	No	–	UDINT

14.9 Touch Probe

You can latch the feedback position with the following trigger events.

- Trigger with probe 1 input (Probe 1 Latch Input (/Probe1) signal)
- Trigger with probe 2 input (Probe 2 Latch Input (/Probe2) signal)
- Trigger with encoder zero signal (phase C)

The following two touch probe latches can be used at the same time.

■ Touch Probe 1 Latch

- Latch control object: 60B8h (bits 0 to 7)
- Latch status object: 60B9h (bits 0 to 7)
- The latched position is always stored in *touch probe 1 position value* (60BAh).
- Trigger signal: Encoder zero signal or /Probe1 signal

■ Touch Probe 2 Latch

- Latch control object: 60B8h (bits 8 to 15)
- Latch status object: 60B9h (bits 8 to 15)
- The latched position is always stored in *touch probe 2 position value* (60BCh).
- Trigger signal: /Probe2 signal

You can change the connector pin assignments and the /Probe1 and /Probe2 signal logic in the Probe 1 Latch Input Signal parameter (Pn511 = X) and the Probe 2 Latch Input Signal parameter (Pn511 = X).

Note: Touch probe 1 cannot be used during homing. If touch probe 1 was already active, it will be switched OFF.

14.9.1 Related Objects

Index	Subindex	Name	Access	PDO Mapping	Unit	Data Type
60B8h	0	Touch probe function	RW	Yes	–	UINT
60B9h	0	Touch probe status	RO	Yes	–	UINT
60BAh	0	Touch probe 1 position value	RO	Yes	Pos unit	DINT
60BCh	0	Touch probe 2 position value	RO	Yes	Pos unit	DINT

14.9.2 Example of Execution Procedure for a Touch Probe

- Single Trigger Mode (60B8h bit 1 = 0 or bit 9 = 0)

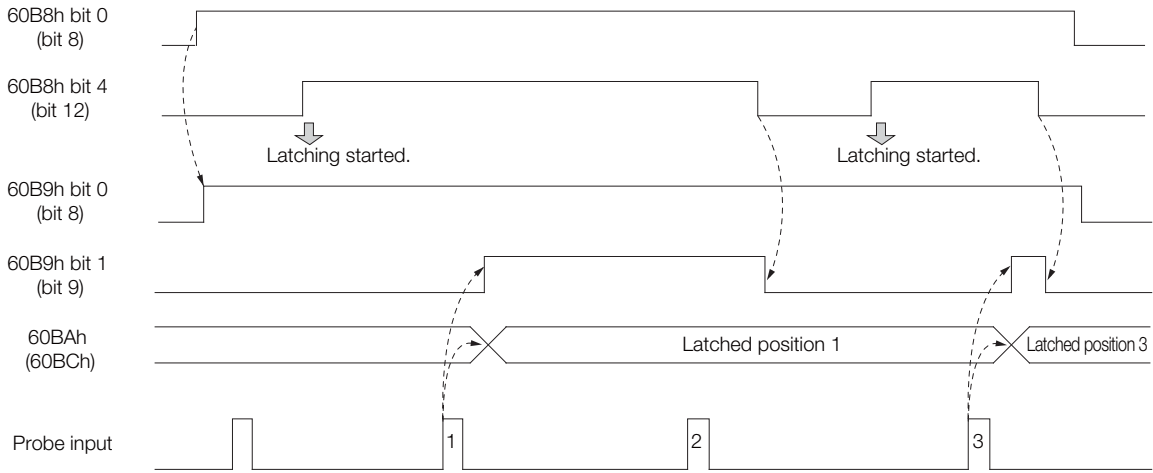

- Continuous Trigger Mode (60B8h bit 1 = 1 or bit 9 = 1)

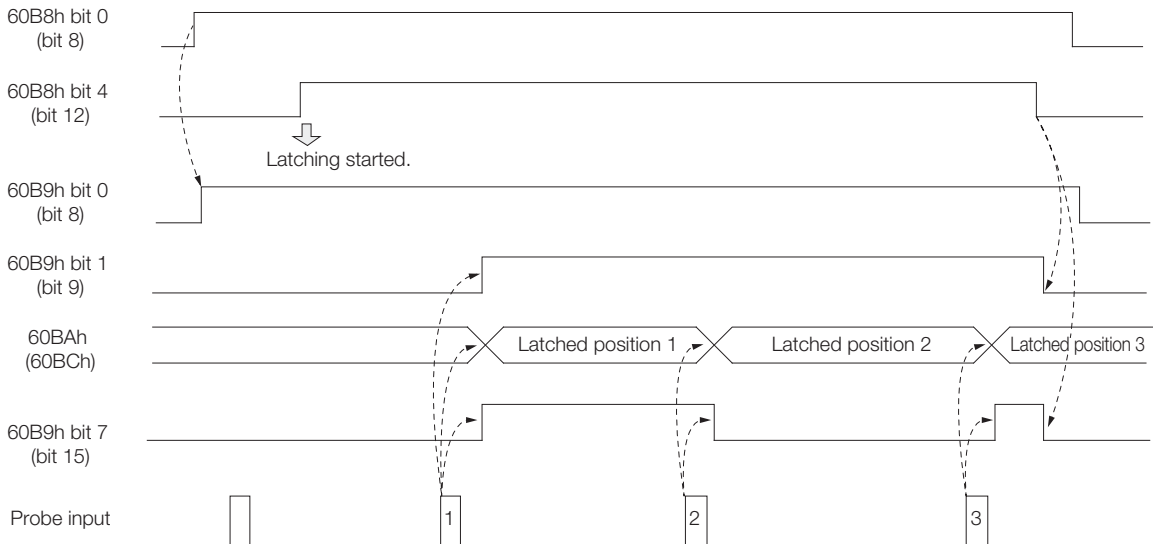

14.10 Fully-Closed Loop Control

The following figure shows the block diagram for the fully-closed loop control.

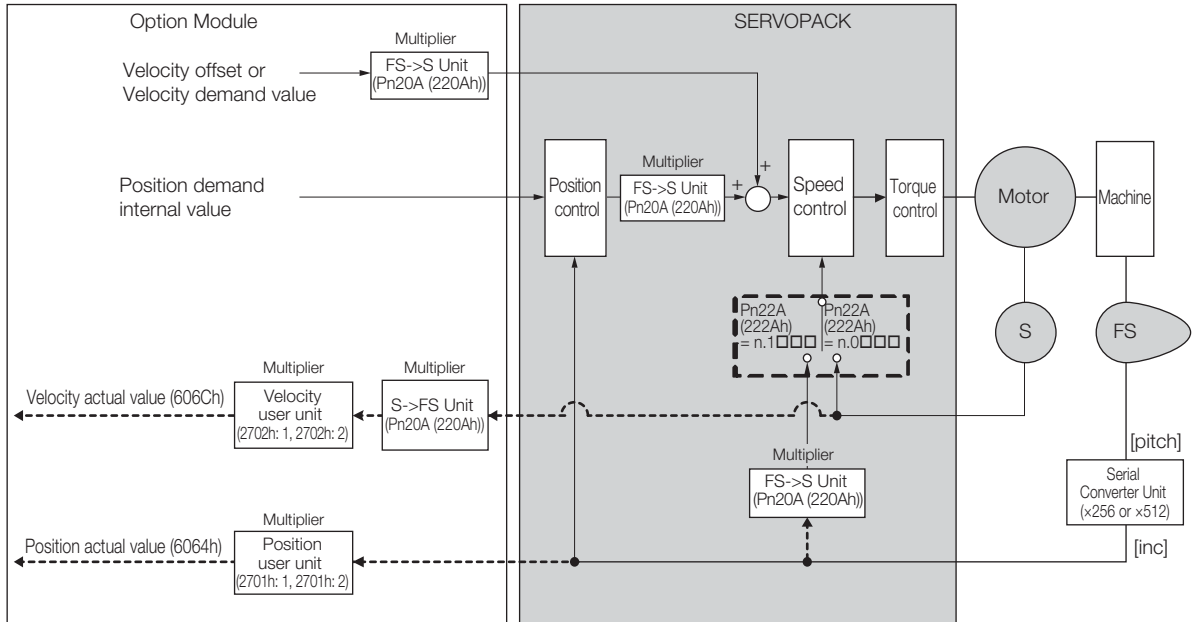

The basic setting procedure for the related parameters is given in the following table.

Step	Description	Parameter Setting
1	Set the speed feedback method to use during fully-closed loop control.	Fully-closed Control Selections (Pn22A (222Ah))
2	Set the motor rotation direction.	Rotation Direction Selection (Pn000 (2000h) = n.□□□X) External Encoder Usage (Pn002 (2002h) = n.X□□□)
3	Set the number of pitches (cycles) of the sine wave for the external encoder.	Number of External Scale Pitches (Pn20A (220Ah))
4	Set the position reference unit (electronic gear).	Position user unit (2701h)
5	Set the alarm detection level for the external encoder.	Motor-Load Position Deviation Overflow Detection Level (Pn51B (251Bh)) Multiplier per Fully-closed Rotation (Pn52A (252Ah))

Object Dictionary

This chapter provides tables of the objects that are supported by an EtherCAT SERVOPACK. Each object is described.

15.1	Object Dictionary List	15-3
15.2	General Objects	15-5
15.3	PDO Mapping Objects	15-9
15.4	Sync Manager Communications Objects	15-13
15.5	Manufacturer-Specific Objects	15-17
15.6	Device Control	15-23
15.7	Profile Position Mode	15-31
15.8	Homing Mode	15-33
15.9	Position Control Function	15-35
15.10	Interpolated Position Mode	15-37
15.11	Cyclic Synchronous Position Mode	15-43
15.12	Profile Velocity/Cyclic Synchronous Velocity Mode	15-44
15.13	Profile Torque/Cyclic Synchronous Torque Mode	15-45

15.14	Torque Limit Function	15-46
15.15	Touch Probe Function	15-47
15.16	Digital Inputs/Outputs	15-49
15.17	Dual Encoder Feedback	15-51

15.1 Object Dictionary List

The following table lists the dictionary objects.

Functional Classification	Object Name	Index	Refer to
General Objects	Device type	(1000h)	15.2
	Error register	(1001h)	15.2
	Manufacturer device name	(1008h)	15.2
	Manufacturer software version	(100Ah)	15.2
	Store parameters field	(1010h)	15.2
	Restore default parameters	(1011h)	15.2
	Identity object	(1018h)	15.2
PDO Mapping Objects	Receive PDO mapping	(1600h to 1603h)	15.3
	Transmit PDO mapping	(1A00h to 1A03h)	15.3
Sync Manager Communication Objects	Sync manager communication type	(1C00h)	15.4
	Sync manager PDO assignment	(1C10h and 1C13h)	15.4
	Sync manager synchronization	(1C32h and 1C33h)	15.4
	Sync error setting	(10F1h)	15.4
Manufacturer Specific Objects	SERVOPACK parameters	(2000h to 26FFh)	15.5
	User parameter configuration	(2700h)	15.5
	Position user unit	(2701h)	15.5
	Velocity user unit	(2702h)	15.5
	Acceleration user unit	(2703h)	15.5
	Torque user unit	(2704h)	14.5
	Encoder selection	(2705h)	14.5
	SERVOPACK adjusting command object	(2710h)	15.5
Device Control	Error code	(603Fh)	15.6
	Controlword	(6040h)	15.6
	Statusword	(6041h)	15.6
	Quick stop option code	(605Ah)	15.6
	Shutdown option code	(605Bh)	15.6
	Disable operation option code	(605Ch)	15.6
	Halt option code	(605Dh)	15.6
	Fault reaction option code	(605Eh)	15.6
	Modes of operation	(6060h)	15.6
	Modes of operation display	(6061h)	15.6
	Supported drive modes	(6502h)	15.6
	Profile Position Mode	Target position	(607Ah)
Software position limit		(607Dh)	15.7
Max profile velocity		(607Fh)	15.7
Profile velocity		(6081h)	15.7
Profile acceleration		(6083h)	15.7
Profile deceleration		(6084h)	15.7
Quick stop deceleration		(6085h)	15.7
Homing Mode	Home offset	(607Ch)	15.8
	Homing method	(6098h)	15.8
	Homing speeds	(6099h)	15.8
	Homing acceleration	(609Ah)	15.8

Continued on next page.

Continued from previous page.

Functional Classification	Object Name	Index	Refer to
Position Control Function	Position demand value	(6062h)	15.9
	Position actual internal value	(6063h)	15.9
	Position actual value	(6064h)	15.9
	Position demand internal value	(60FCh)	15.9
	Following error window	(6065h)	15.9
	Following error time out	(6066h)	15.9
	Following error actual value	(60F4h)	15.9
	Position window	(6067h)	15.9
	Position window time	(6068h)	15.9
Interpolated Position Mode	Interpolation sub mode select	(60C0h)	15.10
	Interpolation data record	(60C1h)	15.10
	Interpolation time period	(60C2h)	15.10
	Manufacturer interpolation data configuration for 1st profile	(2730h)	15.10
	Manufacturer interpolation data configuration for 2nd profile	(2731h)	15.10
	Interpolation profile select	(2732h)	15.10
	Interpolation data record for 1st profile	(27C0h)	15.10
	Interpolation data record for 2nd profile	(27C1h)	15.10
	Interpolation data read/write pointer position	(2741h)	15.10
Cyclic Synchronous Position Mode	Velocity offset	(60B1h)	15.11
	Torque offset	(60B2h)	15.11
Profile Velocity/Cyclic Synchronous Velocity Mode	Velocity demand value	(606Bh)	15.12
	Velocity actual value	(606Ch)	15.12
	Velocity window	(606Dh)	15.12
	Velocity window time	(606Eh)	15.12
	Target velocity	(60FFh)	15.12
Profile Torque/Cyclic Synchronous Velocity Mode	Target torque	(6071h)	15.13
	Torque demand value	(6074h)	15.13
	Torque slope	(6087h)	15.13
	Motor rated torque	(6076h)	15.13
	Torque actual value	(6077h)	15.13
Torque Limit Function	Max torque	(6072h)	15.14
	Positive torque limit value	(60E0h)	15.14
	Negative torque limit value	(60E1h)	15.14
Touch Probe Function	Touch probe function	(60B8h)	15.15
	Touch probe status	(60B9h)	15.15
	Touch probe 1 position value	(60BAh)	15.15
	Touch probe 2 position value	(60BCh)	15.15
Digital Inputs/Outputs	Digital inputs	(60FDh)	15.16
	Digital outputs	(60FEh)	15.16

15.2 General Objects

Device Type (1000h)

This object contains the device type and functionality.

Index	Sub-index	Name	Data Type	Access	PDO Mapping	Value	Saving to EEPROM
1000h	0	Device type	UDINT	RO	No	0x00020192	No

◆ Data Description

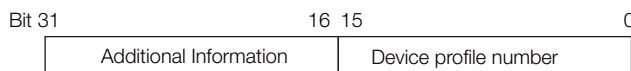

Additional information: 0002 (Servo Drive)

Device profile number: 0192 (DS402)

Error Register (1001h)

This object contains the error status of the device. The value of this object is stored as part of an emergency message.

Index	Sub-index	Name	Data Type	Access	PDO Mapping	Value	Saving to EEPROM
1001h	0	Error register	USINT	RO	No	0x00	No

◆ Data Description

Bit	Data	Description
0	Generic error	0: No error, 1: Error
1 to 7	Reserved.	0: Always 0

Manufacturer Device Name (1008h)

This object contains the SERVOPACK model name.

Index	Sub-index	Name	Data Type	Access	PDO Mapping	Value	Saving to EEPROM
1008h	0	Manufacturer device name	STRING	RO	No	–	No

Manufacturer Software Version (100Ah)

This object contains the software version of the SERVOPACK.

Index	Sub-index	Name	Data Type	Access	PDO Mapping	Value	Saving to EEPROM
100Ah	0	Manufacturer software version	STRING	RO	No	–	No

◆ Data Description

The following string is saved.

“xxxx.*** (D:oooo)”

xxxx.***: Software version of EtherCAT (CoE)

oooo: Software version of the SERVOPACK

Store Parameters Field (1010h)

You can use this object to save the parameter settings in non-volatile memory.

Index	Sub-index	Name	Data Type	Access	PDO Mapping	Value	Saving to EEPROM
1010h	0	Largest subindex supported	USINT	RO	No	4	No
	1	Save all parameters	UDINT	RW	No	0x00000000 to 0xFFFFFFFF (default: 0x00000001)	No
	2	Save communication parameters	UDINT	RW	No	0x00000000 to 0xFFFFFFFF (default: 0x00000001)	No
	3	Save application parameters	UDINT	RW	No	0x00000000 to 0xFFFFFFFF (default: 0x00000001)	No
	4	Save manufacturer defined parameters	UDINT	RW	No	0x00000000 to 0xFFFFFFFF (default: 0x00000001)	No

If you read the object entry data, a value will be returned that tells whether the SERVOPACK can save the parameters.

Bit	Value	Meaning
1	0	The SERVOPACK does not save the parameters autonomously.
0	0	The SERVOPACK does not save the parameters for a command.
	1	The SERVOPACK saves the parameters for a command.

To prevent saving parameters by mistake, they are saved only when a specific signature is written to the appropriate subindex. The signature is “save.”

Signature	MSB				LSB			
ASCII	e	v	a	s				
hex	65h	76h	61h	73h				

If you write “save” to subindex 1, all parameters are saved.

If you write “save” to subindex 2, the communications parameters (objects 1000h to 1FFFh) are saved.

If you write “save” to subindex 3, the application parameters (objects 27□□h and 6□□□h) are saved.

If you write “save” to subindex 4, the SERVOPACK parameters (objects 2000h to 26FFh) are saved.

- Note:
1. If an incorrect signature is written, the SERVOPACK refuses to save the parameters and returns an SDO abort code.
 2. If you read the object entry data while parameters are being saved, 0 will be returned.
 3. Subindex 1 and subindex 4 can be written only in the Switch ON Disabled state (servo OFF).
 4. After storing parameters with subindex 1 or subindex 4, you must turn the power supply OFF and ON again to move to the Operation Enabled state.

Restore Default Parameters (1011h)

You can use this object to restore the parameters to the default values.

Index	Subindex	Name	Data Type	Access	PDO Mapping	Value	Saving to EEPROM
1011h	0	Largest subindex supported	USINT	RO	No	4	No
	1	Restore all default parameters	UDINT	RW	No	0x00000000 to 0xFFFFFFFF (default: 0x00000001)	No
	2	Restore communication default parameters	UDINT	RW	No	0x00000000 to 0xFFFFFFFF (default: 0x00000001)	No
	3	Restore application default parameters	UDINT	RW	No	0x00000000 to 0xFFFFFFFF (default: 0x00000001)	No
	4	Restore manufacturer defined default parameters	UDINT	RW	No	0x00000000 to 0xFFFFFFFF (default: 0x00000001)	No

If you read the object entry data, a value will be returned that tells whether the SERVOPACK can initialize the parameters.

Bit	Value	Description
0	0 1	The SERVOPACK does not restore the parameters to the default values. The SERVOPACK restores the parameters to the default values.

To prevent restoring the parameters to the default values by mistake, the parameters are restored to the default values only when a specific signature is written to the appropriate subindex. The signature is “load.”

Signature	MSB				LSB			
ASCII	d	a	o	l				
hex	64h	61h	6Fh	6Ch				

If you write “load” to subindex 1, all parameters are restored to the default values.

If you write “load” to subindex 2, the communications parameters (objects 1□□□h) are restored to the default values.

If you write “load” to subindex 3, the application parameters (objects 27□□h and 6□□□h) are restored to the default values.

If you write “load” to subindex 4, the SERVOPACK parameters (objects 2000h to 26FFh) are restored to the default values.

Note: 1. If an incorrect signature is written, the SERVOPACK refuses to restore the default values and returns an SDO abort code.

2. Subindex 1 and subindex 4 can be written only in the Switch ON Disabled state (servo OFF).

3. If you read this object while the default values are being restored, 0 will be returned.

4. The default values are enabled after the SERVOPACK is reset or after the power supply to the SERVOPACK is turned OFF and ON again.

Identity Object (1018h)

This object contains general information on the device.

Index	Sub-index	Name	Data Type	Access	PDO Mapping	Value	Saving to EEPROM
1018h	0	Number of entries	USINT	RO	No	4	No
	1	Vendor ID	UDINT	RO	No	0x00000539	No
	2	Product code	UDINT	RO	No	0x02200401 ^{*1}	No
	3	Revision number ^{*2}	UDINT	RO	No	–	No
	4	Serial number ^{*3}	UDINT	RO	No	0x00000000	No

*1. For SGD7S-□□□DA0□: 0x02200401

*2. The revision number is saved as follows:

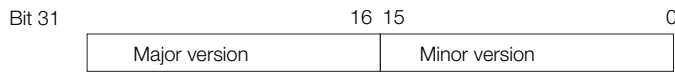

The major version identifies the operating specifications of EtherCAT (CoE). If the CoE functionality is expanded, the major version has to be increased. The minor version number identifies different versions with the same operating specifications.

*3. Serial number is not used. (It is always 0.)

15.3 PDO Mapping Objects

The CANopen over EtherCAT protocol allows the user to map objects to process data objects (PDOs) in order to use the PDOs for realtime data transfer.

The PDO mappings define which objects will be included in the PDOs.

A mapping entry (subindexes 1 to 8) is defined as shown below.

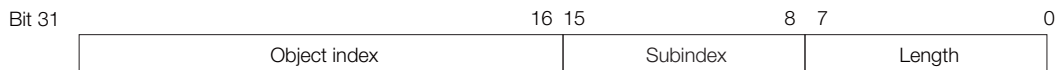

Bits 0 to 7: The length of the mapped object in bits. (If there is a gap in the PDOs, the bit length of the gap is given.)

Bits 8 to 15: The subindex of the mapped object (0 if there is a gap in the PDOs).

Bits 16 to 31: The index of the mapped object (0 if there is a gap in the PDOs).

Information The objects mapped to PDOs can be changed only when the EtherCAT (CoE) Network Module is in the Pre-Operational state.
Set the mapping entries (subindexes 1 to 8) only after you write 0 to subindex 0.

Receive PDO Mapping (1600h to 1603h)

◆ 1st Receive PDO Mapping

Index	Subindex	Name	Data Type	Access	PDO Mapping	Value	Saving to EEPROM
1600h	0	Number of objects in this PDO	USINT	RW	No	0 to 8 (default: 8)	Yes
	1	Mapping entry 1	UDINT	RW	No	0 to 0xFFFFFFFF (default: 0x60400010)	Yes
	2	Mapping entry 2	UDINT	RW	No	0 to 0xFFFFFFFF (default: 0x607A0020)	Yes
	3	Mapping entry 3	UDINT	RW	No	0 to 0xFFFFFFFF (default: 0x60FF0020)	Yes
	4	Mapping entry 4	UDINT	RW	No	0 to 0xFFFFFFFF (default: 0x60710010)	Yes
	5	Mapping entry 5	UDINT	RW	No	0 to 0xFFFFFFFF (default: 0x60720010)	Yes
	6	Mapping entry 6	UDINT	RW	No	0 0xFFFFFFFF (default: 0x60600008)	Yes
	7	Mapping entry 7	UDINT	RW	No	0 to 0xFFFFFFFF (default: 0x00000008)	Yes
	8	Mapping entry 8	UDINT	RW	No	0 to 0xFFFFFFFF (default: 0x60B80010)	Yes

◆ 2nd Receive PDO Mapping

Index	Sub-index	Name	Data Type	Access	PDO Mapping	Value	Saving to EEPROM
1601h	0	Number of objects in this PDO	USINT	RW	No	0 to 8 (default: 2)	Yes
	1	Mapping entry 1	UDINT	RW	No	0 to 0xFFFFFFFF (default: 0x60400010)	Yes
	2	Mapping entry 2	UDINT	RW	No	0 to 0xFFFFFFFF (default: 0x607A0020)	Yes
	3 to 8	Mapping entry 3 to Mapping entry 8	UDINT	RW	No	0 to 0xFFFFFFFF (default: 0)	Yes

◆ 3rd Receive PDO Mapping

Index	Sub-index	Name	Data Type	Access	PDO Mapping	Value	Saving to EEPROM
1602h	0	Number of objects in this PDO	USINT	RW	No	0 to 8 (default: 2)	Yes
	1	Mapping entry 1	UDINT	RW	No	0 to 0xFFFFFFFF (default: 0x60400010)	Yes
	2	Mapping entry 2	UDINT	RW	No	0 to 0xFFFFFFFF (default: 0x60FF0020)	Yes
	3 to 8	Mapping entry 3 to Mapping entry 8	UDINT	RW	No	0 to 0xFFFFFFFF (default: 0)	Yes

◆ 4th Receive PDO Mapping

Index	Sub-index	Name	Data Type	Access	PDO Mapping	Value	Saving to EEPROM
1603h	0	Number of objects in this PDO	USINT	RW	No	0 to 8 (default: 2)	Yes
	1	Mapping entry 1	UDINT	RW	No	0 to 0xFFFFFFFF (default: 0x60400010)	Yes
	2	Mapping entry 2	UDINT	RW	No	0 to 0xFFFFFFFF (default: 0x60710010)	Yes
	3 to 8	Mapping entry 3 to Mapping entry 8	UDINT	RW	No	0 to 0xFFFFFFFF (default: 0)	Yes

Transmit PDO Mapping (1A00h to 1A03h)

◆ 1st Transmit PDO Mapping

Index	Sub-index	Name	Data Type	Access	PDO Mapping	Value	Saving to EEPROM
1A00h	0	Number of objects in this PDO	USINT	RW	No	0 to 8 (default: 8)	Yes
	1	Mapping entry 1	UDINT	RW	No	0 to 0xFFFFFFFF (default: 0x60410010)	Yes
	2	Mapping entry 2	UDINT	RW	No	0 to 0xFFFFFFFF (default: 0x60640020)	Yes
	3	Mapping entry 3	UDINT	RW	No	0 to 0xFFFFFFFF (default: 0x60770010)	Yes
	4	Mapping entry 4	UDINT	RW	No	0 to 0xFFFFFFFF (default: 0x60F40020)	Yes
	5	Mapping entry 5	UDINT	RW	No	0 to 0xFFFFFFFF (default: 0x60610008)	Yes
	6	Mapping entry 6	UDINT	RW	No	0 to 0xFFFFFFFF (default: 0x00000008)	Yes
	7	Mapping entry 7	UDINT	RW	No	0 to 0xFFFFFFFF (default: 0x60B90010)	Yes
	8	Mapping entry 8	UDINT	RW	No	0 to 0xFFFFFFFF (default: 0x60BA0020)	Yes

◆ 2nd Transmit PDO Mapping

Index	Sub-index	Name	Data Type	Access	PDO Mapping	Value	Saving to EEPROM
1A01h	0	Number of objects in this PDO	USINT	RW	No	0 to 8 (default: 2)	Yes
	1	Mapping entry 1	UDINT	RW	No	0 to 0xFFFFFFFF (default: 0x60410010)	Yes
	2	Mapping entry 2	UDINT	RW	No	0 to 0xFFFFFFFF (default: 0x60640020)	Yes
	3 to 8	Mapping entry 3 to Mapping entry 8	UDINT	RW	No	0 to 0xFFFFFFFF (default: 0)	Yes

◆ 3rd Transmit PDO Mapping

Index	Sub-index	Name	Data Type	Access	PDO Mapping	Value	Saving to EEPROM
1A02h	0	Number of objects in this PDO	USINT	RW	No	0 to 8 (default: 2)	Yes
	1	Mapping entry 1	UDINT	RW	No	0 to 0xFFFFFFFF (default: 0x60410010)	Yes
	2	Mapping entry 2	UDINT	RW	No	0 to 0xFFFFFFFF (default: 0x60640020)	Yes
	3 to 8	Mapping entry 3 to Mapping entry 8	UDINT	RW	No	0 to 0xFFFFFFFF (default: 0)	Yes

◆ 4th Transmit PDO Mapping

Index	Sub-index	Name	Data Type	Access	PDO Mapping	Value	Saving to EEPROM
1A03h	0	Number of objects in this PDO	USINT	RW	No	0 to 8 (default: 3)	Yes
	1	Mapping entry 1	UDINT	RW	No	0 to 0xFFFFFFFF (default: 0x60410010)	Yes
	2	Mapping entry 2	UDINT	RW	No	0 to 0xFFFFFFFF (default: 0x60640020)	Yes
	3	Mapping entry 3	UDINT	RW	No	0 to 0xFFFFFFFF (default: 0x60770010)	Yes
	4 to 8	Mapping entry 4 to Mapping entry 8	UDINT	RW	No	0 to 0xFFFFFFFF (default: 0)	Yes

15.4 Sync Manager Communications Objects

Sync Manager Communications Type (1C00h)

Index	Subindex	Name	Data Type	Access	PDO Mapping	Value	Saving to EEPROM
1C00h	0	Number of used Sync Manager channels	USINT	RO	No	4	No
	1	Communication type sync manager 0	USINT	RO	No	1: Mailbox reception (master to slave)	No
	2	Communication type sync manager 1	USINT	RO	No	2: Mailbox send (slave to master)	No
	3	Communication type sync manager 2	USINT	RO	No	3: Process data output (master to slave)	No
	4	Communication type sync manager 3	USINT	RO	No	4: Process data input (slave to master)	No

Sync Manager PDO Assignment (1C10h to 1C13h)

This object defines which PDOs will be transferred in the process data communications.

Index	Subindex	Name	Data Type	Access	PDO Mapping	Value	Saving to EEPROM
1C10h	0	Sync manager PDO assignment 0	USINT	RO	No	0	No
1C11h	0	Sync manager PDO assignment 1	USINT	RO	No	0	No
1C12h	0	Number of assigned PDOs	USINT	RW	No	0 to 2 (default: 1)	Yes
	1	Index of assigned RxPDO 1	UINT	RW	No	1600h to 1603h (default: 1601h)	Yes
	2	Index of assigned RxPDO 2	UINT	RW	No	1600h to 1603h (default: 1600h)	Yes
1C13h	0	Number of assigned PDOs	USINT	RW	No	0 to 2 (default: 1)	Yes
	1	Index of assigned TxPDO 1	UINT	RW	No	1A00h to 1A03h (default: 1A01h)	Yes
	2	Index of assigned TxPDO 2	UINT	RW	No	1A00h to 1A03h (default: 1A00h)	Yes

Objects 1C12h and 1C13h can be changed when the EtherCAT (CoE) Network Module is in the Pre-Operational state. Set subindex 1 or 2 only after you write 0 to subindex 0.

Sync Manager Synchronization (1C32h and 1C33h)

◆ Sync Manager 2 (Process Data Output) Synchronization

Index	Sub-index	Name	Data Type	Access	PDO Mapping	Value	Saving to EEPROM
1C32h	0	Number of synchronization parameters	USINT	RO	No	10	No
	1	Synchronization type	UINT	RO	No	0: Free-Run (DC not used) 2: DC Sync0 (DC used)	No
	2	Cycle time	UDINT	RO	No	Sync0 event cycle [ns]	No
	3	Shift time	UDINT	RO	No	125,000 [ns]	No
	4	Synchronization types supported	UINT	RO	No	Bit 0 = 1: Free-Run supported Bits 2 to 4 = 001: DC Sync0 supported Bits 5 and 6 = 00: Output shift not supported.	No
	5	Minimum cycle time	UDINT	RO	No	62,500 [ns]	No
	6	Calc and copy time	UDINT	RO	No	62,500 [ns]	No
	7	Reserved	UDINT	RO	No	–	No
	8	Reserved	UINT	RO	No	–	No
	9	Delay time	UDINT	RO	No	0 [ns]	No
	10	Sync0 cycle time	UDINT	RO	No	Same as 1C32h: 02.	No
	11	Reserved	UDINT	RO	No	–	No
	12	SM2 event miss count	UDINT	RO	No	–	No

◆ Sync Manager 3 (Process Data Input) Synchronization

Index	Sub-index	Name	Data Type	Access	PDO Mapping	Value	Saving to EEPROM
1C33h	0	Number of synchronization parameters	USINT	RO	No	10	No
	1	Synchronization type	UINT	RO	No	Same as 1C32h: 01.	No
	2	Cycle time	UDINT	RO	No	Same as 1C32h: 02.	No
	3	Shift time	UDINT	RW	No	125,000 × n [ns] (n = 1, 2, 3...) Range: 0 to (Sync0 event cycle - 125,000)	Yes
	4	Synchronization types supported	UINT	RO	No	Bit 0 = 1: Free-Run supported. Bits 2 to 4 = 001: DC Sync0 supported Bits 5 and 6 = 01: Input shift with local timer supported.	No
	5	Minimum cycle time	UDINT	RO	No	Same as 1C32h: 05.	No
	6	Calc and copy time	UDINT	RO	No	62,500 [ns]	No
	7	Reserved	UDINT	RO	No	–	No
	8	Reserved	UINT	RO	No	–	No
	9	Delay time	UDINT	RO	No	0	No
10	Sync0 cycle time	UDINT	RO	No	Same as 1C32h: 10.	No	

Sync Error Settings (10F1h)

Index	Sub-index	Name	Data Type	Access	PDO Mapping	Value	Saving to EEPROM
10F1h	0	Number of entries	USINT	RO	No	2	No
	1	Reserved	UDINT	RO	No	0	No
	2	Sync error counter limit	UDINT	RW	No	0 to 15 (default: 9)	Yes

Note: Both 10F1h and 1F01h have the same function. You can set either object.

◆ 0x10F1h: 2 Sync Error Counter Limit

This object defines the allowable number of failures when receiving process data. If the value of the internal error counter in the SERVOPACK exceeds the value of this object, the SERVOPACK will detect an alarm (A12h) and change the ESM state to SAFEOP.

The SERVOPACK increments the internal error counter by 3 if the process output data is not updated (i.e., if a reception event does not occur) when the synchronization event (Sync0) occurs. When the process output data is updated normally, the internal error counter is decremented by 1. The internal error counter is reset when the EtherCAT communications state changes from SAFEOP to OP.

An example of internal error counter operation is shown below.

Reception (SM2) event	1	0	1	0	1	0	1	0	1	0	1
SERVOPACK internal error counter (Error Counter Limit = 9)	0	3	2	5	4	7	6	9 (Error)	9	9	9

In this example, a failure in receiving the process data occurs every other DC (Sync0) cycle. After eight DC cycles, the internal error count reaches the Sync Error Count Limit, and an error occurs.

No alarm will be detected if the DC mode is disabled or when the Sync Error Count Limit is set to 0.



1. Set a suitable cycle time for updating the process data according to the requirements of the application.
2. Determine if the default setting of the Sync Error Counter Limit is suitable for the requirements of the application. With the default value of 9, network frames will be lost (SM2 reception events will not occur) three times consecutively before an alarm occurs in the SERVOPACK. If the setting of the Sync Error Counter Limit is too small, alarms will occur even when there is no problem in the application.
3. Noise may cause communications errors in the SERVOPACK. Check the SERVOPACK wiring and make sure that it has been performed to minimize the influence of noise. Implement noise countermeasures if necessary. Refer to the following section for information on noise countermeasures.

 [4.1.2 Countermeasures against Noise on page 4-5](#)

15.5 Manufacturer-Specific Objects

SERVOPACK Parameters (2000h to 26FFh)

Objects 2000h to 26FFh are mapped to SERVOPACK parameters (Pn□□□).

Object index 2□□□h corresponds to Pn□□□ in the SERVOPACK parameters (e.g., object 2100h is the same as Pn100).

User Parameter Configuration (2700h)

This object enables all user parameter settings and initializes all of the position data.

Index	Sub-index	Name	Data Type	Access	PDO Mapping	Value	Saving to EEPROM
2700h	0	User parameter configuration	UDINT	RW	No	0 to 0xFFFFFFFF (default: 0)	No

If you change any of the following objects and restart operation without turning the power supply OFF and then ON again, you must execute this object to enable the new settings.

- Objects 2701h, 2702h, 2703h, and 2704h
- SERVOPACK parameters that require that the power supply be turned OFF and ON again to enable changes to the parameter settings

◆ Procedure

1. Change the SERVOPACK to the Switch ON Disabled state.
2. Set the new parameter settings.
3. Set *user parameter configuration* (2700h) to 1. The parameter settings will be enabled. After execution, object 2700h will automatically be reset to 0.

Position User Unit (2701h)

This object sets the user-defined position reference unit (Pos unit).

The user-defined position reference unit is calculated with the following formula.

$$1 \text{ [Pos unit]} = (\text{Numerator/Denominator}) \text{ [inc]}$$

Index	Sub-index	Name	Data Type	Access	PDO Mapping	Value	Saving to EEPROM
2701h	0	Number of entries	USINT	RO	No	2	No
	1	Numerator	UDINT	RW	No	1 to 1,073,741,823 (default: 1)	Yes
	2	Denominator	UDINT	RW	No	1 to 1,073,741,823 (default: 1)	Yes

Setting range: $1/4,096 < \text{Numerator/Denominator} < 65,536$

(Alarm A.A20 will be detected if the setting exceeds the setting range.)

Velocity User Unit (2702h)

This object sets the user-defined speed reference unit (Vel unit).

The user-defined speed reference unit is calculated with the following formula.

$$1 [\text{Vel unit}] = (\text{Numerator}/\text{Denominator}) [\text{inc}/\text{sec}]$$

Index	Sub-index	Name	Data Type	Access	PDO Mapping	Value	Saving to EEPROM
2702h	0	Number of entries	USINT	RO	No	2	No
	1	Numerator	UDINT	RW	No	1 to 1,073,741,823 (default: 1)	Yes
	2	Denominator	UDINT	RW	No	1 to 1,073,741,823 (default: 1)	Yes

Setting range: $1/128 \leq \text{Numerator}/\text{Denominator} \leq 8,388,608$

(Alarm A.A20 will be detected if the setting exceeds the setting range.)

Acceleration User Unit (2703h)

This object sets the user-defined acceleration reference unit (Acc unit).

The user-defined acceleration reference unit is calculated with the following formula.

$$1 [\text{Acc unit}] = (\text{Numerator}/\text{Denominator}) \times 10^4 [\text{inc}/\text{sec}^2]$$

Index	Sub-index	Name	Data Type	Access	PDO Mapping	Value	Saving to EEPROM
2703h	0	Number of entries	USINT	RO	No	2	No
	1	Numerator	UDINT	RW	No	1 to 1,073,741,823 (default: 1)	Yes
	2	Denominator	UDINT	RW	No	1 to 1,073,741,823 (default: 1)	Yes

Setting range: $1/128 \leq \text{Numerator}/\text{Denominator} \leq 262,144$

(Alarm A.A20 will be detected if the setting exceeds the setting range.)

Torque User Unit (2704h)

This object sets the user-defined torque reference unit (Torque unit).

The user-defined torque reference unit is calculated with the following formula.

$$1 [\text{Trq. unit}] = (\text{Numerator}/\text{Denominator}) [\%]$$

Index	Sub-index	Name	Data Type	Access	PDO Mapping	Value	Saving to EEPROM
2704h	0	Number of entries	USINT	RO	No	2	No
	1	Numerator	UDINT	RW	No	1 to 1,073,741,823 (default: 1)	Yes
	2	Denominator	UDINT	RW	No	1 to 1,073,741,823 (default: 1)	Yes

Setting range: $1/256 \leq \text{Numerator}/\text{Denominator} \leq 1$

(Alarm A.A20 will be detected if the setting exceeds the setting range.)

The objects that are related to the user-defined torque reference unit setting are given in the following table.

The reference unit for the following objects is 0.1%.

EtherCAT(CoE) Communications Object	Data Type
Target torque (6071h)	INT
Torque demand value (6074h)	INT
Torque slope (6087h)	UDINT
Torque actual value (6077h)	INT
Max torque (6072h)	UINT
Positive torque limit value (60E0h)	UINT
Negative torque limit value (60E1h)	UINT
Torque offset (60B2h)	INT

Encoder Selection (2705h)

This object is used to select the encoder resolution.

Index	Subindex	Name	Data Type	Access	PDO Mappings	Value	Saving to EEPROM
2705h	0	Encoder Selection	USINT	RW	No	0000h (20 bits), 0001h (24 bits) (default: 0000h)	Yes

SERVOPACK Adjusting Command (2710h)

This object is used for SERVOPACK adjustment services (e.g., encoder setup or multiturn reset). Write data to subindex 1 to start command execution. Also, read the subindex 3 to obtain the response. If you cannot obtain the response by reading subindex 3, the first byte of the response data will give information about the progress of execution.

Index	Subindex	Name	Data Type	Access	PDO Mapping	Value	Saving to EEPROM
2710h	0	Number of entries	USINT	RO	No	3	No
	1	Command	STRING	RW	No	Bytes 0 to n: Service Request Data The command is executed when command data is written.	No
	2	Status	USINT	RO	No	0: Command completed, no errors, and no response data 1: Command completed, no errors, and response data provided 2: Command completed, error, and no response data 3: Command completed, error, response data provided 255: Command is being executed	No
	3	Reply	STRING	RO	No	Byte 0: Subindex 2 Byte 1: Not used 2 to n: Service response data	No

◆ Command/Response Data Format

Command Data (Service Request Data)	
Byte	Description
0	Reserved.
1	Reserved.
2	CCMD (command code) 00: Read request 01: Write request
3	CSIZE (CDATA data byte size)
4 to 7	CADDRESS (address)
8 to 15	CDATA (writing data)

Response Data (Service Response Data)	
Byte	Description
0	Status (Same data as subindex 2)
1	Reserved.
2	RCMD (echoback of CCMD)
3	RSIZE (R_DATA data byte size)
4 to 7	RADDRESS (echoback of CADDRESS)
8 to 15	RDATA (read data)/ERROCODE

◆ Executable Adjustment Services

Adjustment Service	Request Code	Preparation before Execution	Processing Time	Execution Conditions
Absolute Encoder Reset	1008h	Required	5 s max.	If an incremental encoder is used, it is not possible to reset the encoder while the servo is ON.
Autotune Motor Current Detection Signal Offset	100Eh	Not required	5 s max.	Adjustment is disabled in the following cases. <ul style="list-style-type: none"> • While the main circuit power supply is OFF • While the servo is ON • While the Servomotor is not stopped
Multiturn Limit Setting	1013h	Required	5 s max.	If an incremental encoder is used, the setting is disabled unless a Multiturn Limit Disagreement alarm has occurred.
Software Reset*	2006h	Not required	5 s max.	The software cannot be reset in the following cases. <ul style="list-style-type: none"> • While the servo is ON • While the Servomotor is not stopped

* EtherCAT (CoE) communications will be disconnected after the software is reset. Repeat the operation sequence and establish communications again. Refer to the following sections for precautions required when resetting the software.

 **7.10 Software Reset**

◆ How to Send a Command for Adjustment

To execute the adjustment service, use the following procedure to send the adjustment command. Step 4 is not required when the software is reset.

1. Send the following data and set the request code for the adjustment service to execute.

CCMD = 0001h
 CSIZE = 02h
 CADDRESS = 00002000h
 CDATA = Request code of the adjustment service to execute*

* Select the request code from the table in ◆ *Executable Adjustment Services* on page 15-20.

If the slave station receives the command normally, the status field will be set to 1.
 If an error occurs, perform step 4 to stop execution.

2. For an adjustment that requires preparations, send the following data. If preparations before execution are not required, perform step 3.

CCMD = 0001h
 CSIZE = 02h
 CADDRESS = 00002001h
 CDATA = 0002h

If the slave station receives the command normally, the status field will be set to 1.
 If an error occurs, perform step 4 to stop execution.

3. Send the following data to execute the adjustment service.

CCMD = 0001h
 CSIZE = 02h
 CADDRESS = 00002001h
 CDATA = 0001h

If the slave station receives the command normally, the status field will be set to 1.
 If an error occurs, perform step 4 to stop execution.

4. Send the following data to stop execution.

CCMD = 0001h
 CSIZE = 02h
 CADDRESS = 00002000h
 CDATA = 0000h

If the slave station receives the command normally, the status field will be set to 1.

Note: If no command is received within 10 seconds after step 1, the adjustment service will be automatically stopped.

Safety Module Monitor (2720h)

This object shows the operating status of the Safety Module.

Index	Subindex	Name	Data Type	Access	PDO Mapping	Value	Saving to EEPROM
2720h	0	Safety module monitor	UDINT	RO	Yes	–	No

◆ Details

Bit	Signal	Description
0	Safety Request Input Signal A1	0: Safety Request Input Signal A1 is ON. (Operation is normal.)
		1: Safety Request Input Signal A1 is OFF. (Safety Function A is active.)
1	Safety Request Input Signal A2	0: Safety Request Input Signal A2 is ON. (Operation is normal.)
		1: Safety Request Input Signal A2 is OFF. (Safety Function A is active.)
2	Safety Request Input Signal B1	0: Safety Request Input Signal B1 is ON. (Operation is normal.)
		1: Safety Request Input Signal B1 is OFF. (Safety Function B is active.)
3	Safety Request Input Signal B2	0: Safety Request Input Signal B2 is ON. (Operation is normal.)
		1: Safety Request Input Signal B2 is OFF. (Safety Function B is active.)
4	External Device Monitor Signal A	0: External Device Monitor Output Signal A is OFF. (Operation is normal or a malfunction occurred in Safety Function A.)
		1: External Device Monitor Output Signal A is ON. (Safety Function A is active.)
5	External Device Monitor Signal B	0: External Device Monitor Output Signal B is OFF. (Operation is normal or a malfunction occurred in Safety Function B.)
		1: External Device Monitor Output Signal B is ON. (Safety Function B is active.)
6 and 7	Reserved.	–
8	Safety Function Monitoring	0: –
		1: Monitoring is in progress.
9	Safety Function Safe	0: –
		1: Safe state
10	Safety Function HWBB	0: –
		1: HWBB function is operating.
12 to 15	Reserved.	–
16	Active Mode State	0: Standby or not selected.
		1: Operating
17 to 31	Reserved.	–

15.6 Device Control

Error Code (603Fh)

This object provides the SERVOPACK alarm/warning code of the last error that occurred.

Index	Sub-index	Name	Data Type	Access	PDO Mapping	Value	Saving to EEPROM
603Fh	0	Error code	UINT	RO	Yes	0	No

Controlword (6040h)

This object controls the device and operation mode.

Index	Sub-index	Name	Data Type	Access	PDO Mapping	Value	Saving to EEPROM
6040h	0	Controlword	UINT	RW	Yes	0 to 0xFFFF (default: 0)	No

◆ Controlword Bits

Bit	Function	Description
0	Switch on	Refer to ■ <i>Details on Bits 0 to 3.</i>
1	Enable voltage	
2	Quick stop	
3	Enable operation	
4 to 6	Operation mode specific	Refer to ■ <i>Details on Bits 4 to 9.</i>
7	Fault reset	0 → 1: Alarm/warning reset.
8	Halt	Refer to ■ <i>Details on Bits 4 to 9.</i>
9	Operation mode specific	
10	– (Reserved)	–
11	Positive torque limit	0: Disables <i>torque limit parameter</i> (object 2404h). 1: Enables <i>torque limit parameter</i> (object 2404h).
12	Negative torque limit	0: Disables <i>torque limit parameter</i> (object 2405h). 1: Enables <i>torque limit parameter</i> (object 2405h).
13 to 15	– (Reserved)	–

■ Details on Bits 0 to 3

- Bits 0 to 3: These bits function as the control command for the Servo Drive's state.

Command	Controlword Bits				
	Bit 7	Bit 3	Bit 2	Bit 1	Bit 0
Shutdown	0	X	1	1	0
Switch on	0	0	1	1	1
Switch on + Enable operation	0	1	1	1	1
Disable voltage	0	X	X	0	X
Quick stop	0	X	0	1	X
Disable operation	0	0	1	1	1
Enable operation	0	1	1	1	1

■ Details on Bits 4 to 9

• Bits 4, 5, and 9: Profile Position Mode

Bit 9	Bit 5	Bit 4	Description
0	0	0 → 1	Starts the next positioning operation after the current positioning operation is completed (i.e., after the target is reached).
X	1	0 → 1	Starts the next positioning operation immediately.
1	0	0 → 1	Continues positioning with the current profile speed up to the current target position and then start the next positioning operation.

• Bits 6 and 8: Profile Position Mode

Bit	Function	Value	Description
6	Abs/rel	0	Treats the target position as an absolute value.
		1	Treats the target position as a relative value. (Treats it as the movement distance from the current target position.)
8	Halt	0	Executes or continues positioning.
		1	Stops axis according to <i>halt option code</i> (605Dh).

• Bits 4, 5, 6, 8, and 9: Homing Mode

Bit	Function	Value	Description
4	Homing operation start	0	Does not start homing.
		1	Starts or continues homing.
5	–	0	Reserved.
6	–	0	Reserved.
8	Halt	0	Enables bit 4.
		1	Stops the axis according to <i>halt option code</i> (605Dh).
9	–	0	Reserved.

• Bits 4, 5, 6, 8, and 9: Cyclic Synchronous Position, Velocity, or Torque Mode

Bit	Function	Value	Description
4	–	0	Reserved.
5	–	0	Reserved.
6	–	0	Reserved.
8	Halt	0	Executes or continues operation.
		1	Stops axis according to <i>halt option code</i> (605Dh).
9	–	0	Reserved.

• Bits 4, 5, 6, 8, and 9: Interpolated Position Mode

Bit	Function	Value	Description
4	Enable interpolation	0	Disables interpolation.
		1	Enables interpolation.
5	–	0	Reserved.
6	–	0	Reserved.
8	Halt	0	Executes specification for bit 4.
		1	Stops the axis according to <i>halt option code</i> (605Dh).
9	–	0	Reserved.

• Bits 4, 5, 6, 8, and 9: Profile Velocity/Torque Mode

Bit	Function	Value	Description
4	–	0	Reserved.
5	–	0	Reserved.
6	–	0	Reserved.
8	Halt	0	Executes or continues operation.
		1	Stops the axis according to <i>halt option code</i> (605Dh).
9	–	0	Reserved.

Statusword (6041h)

Statusword contains the bits that give the current state of the Servo Drive and the operating state of the operation mode.

Index	Sub-index	Name	Data Type	Access	PDO Mapping	Value	Saving to EEPROM
6041h	0	Statusword	UINT	RO	Yes	0	No

◆ Statusword Bits

Bit	State	Description
0	Ready to switch on	Refer to ■ <i>Details on Bits 0 to 7.</i>
1	Switched on	
2	Operation enabled	
3	Fault	
4	Voltage enabled	
5	Quick stop	
6	Switch on disabled	
7	Warning	
8	Active mode stop	1: Active mode function execution is in progress.
9	Remote	<i>Controlword</i> (6040h) is being processed
10	Operation mode specific	Refer to ■ <i>Details on Bits 10, 12, and 13.</i>
11	Internal limit active	Refer to ■ <i>Details on Bit 11.</i>
12, 13	Operation mode specific	Refer to ■ <i>Details on Bits 10, 12, and 13.</i>
14	Torque limit active	0: Torque limit is disabled. 1: Torque limit is enabled.
15	Safety active	1: Safety function is active.

■ Details on Bits 0 to 7

• Bits 0 to 7: Current State of Servo Drive

Bit 7	Bit 6	Bit 5	Bit 4	Bit 3	Bit 2	Bit 1	Bit 0	Servo Drive State
X	0	X	X	0	0	0	0	Not ready to switch on
X	1	X	X	0	0	0	0	Switch on disabled
X	0	1	X	0	0	0	1	Ready to switch on
X	0	1	X	0	0	1	1	Switched on
X	0	1	X	0	1	1	1	Operation enabled
X	0	0	X	0	1	1	1	Quick stop active
X	0	X	X	1	1	1	1	Fault reaction active
X	0	X	X	1	0	0	0	Fault
X	X	X	1	X	X	X	X	Main power on
1	X	X	X	X	X	X	X	Warning occurred

■ Details on Bit 11

• Bit 11: Internal limit active

The internal limit is activated in the following cases:

- The target position was limited by a software limit.
- The N-OT or P-OT signal was activated.
- The interpolation speed was exceeded in Interpolated Position Mode or Cyclic Position Mode.

If the interpolated reference speed exceeds the following speed range, the target position will be ignored.

$$\frac{(\text{Target position} - \text{position demand value}) \times (2701h: 01)/(2701h: 02)}{\text{Interpolation time period}} < 4,194,304 \text{ [inc/ms]}$$

■ Details on Bits 10, 12, and 13

• Bits 10, 12, and 13: Profile Position Mode

Bit	Meaning	Value	Description
10	Target reached	0	<i>Halt</i> (bit 8 in <i>controlword</i>) = 0: The target position has not been reached. <i>Halt</i> (bit 8 in <i>controlword</i>) = 1: The axis is decelerating.
		1	<i>Halt</i> (bit 8 in <i>controlword</i>) = 0: The target position was reached. <i>Halt</i> (bit 8 in <i>controlword</i>) = 1: The axis is stopped.
12	Set-point acknowledge	0	Processing of previous set point (reference) was completed and Servo Drive is waiting for a new set point.
		1	Processing the previous set point is still in process or a set point was acknowledged.
13	Following error	0	No following error has occurred.
		1	A following error occurred.

• Bits 10, 12, and 13: Homing Mode

Bit 13	Bit 12	Bit 10	Description
Homing error	Homing attained	Target reached	
0	0	0	Homing is in progress.
0	0	1	Homing was interrupted or has not yet started.
0	1	0	Home has been defined, but the operation is still in progress.
0	1	1	Homing was completed normally.
1	0	0	A homing error occurred and the speed is not 0.
1	0	1	A homing error occurred and the speed is 0.

• Bits 10, 12, and 13: Cyclic Synchronous Position, Velocity, or Torque Mode

Bit	State	Value	Description
10	Target reached	0	The target (position, speed, or torque) has not been reached (always 0 in Cyclic Torque Mode).
		1	The target (position, speed, or torque) was reached.
12	Target value ignored	0	The target value (position, speed, or torque) was disabled.
		1	Target value (position, speed, or torque) was enabled.
13	Following error	0	There is no following error (always 0 in Cyclic Velocity or Torque Mode).
		1	A following error occurred.

• Bits 10, 12, and 13: Interpolated Position Mode

Bit	State	Value	Description
10	Target reached	0	<i>Halt</i> (bit 8 in <i>controlword</i>) = 0: The target position has not been reached. <i>Halt</i> (bit 8 in <i>controlword</i>) = 1: The axis is decelerating.
		1	<i>Halt</i> (bit 8 in <i>controlword</i>) = 0: The target position was reached. <i>Halt</i> (bit 8 in <i>controlword</i>) = 1: The axis is stopped.
12	lp mode active	0	Interpolation is disabled.
		1	Interpolation is enabled.
13	–	0	Reserved.

- Bits 10, 12, and 13: Profile Velocity Mode

Bit	State	Value	Description
10	Target reached	0	<i>Halt</i> (bit 8 in <i>controlword</i>) = 0: The target speed has not been reached. <i>Halt</i> (bit 8 in <i>controlword</i>) = 1: The axis is decelerating.
		1	<i>Halt</i> (bit 8 in <i>controlword</i>) = 0: The target speed was reached. <i>Halt</i> (bit 8 in <i>controlword</i>) = 1: The axis is stopped.
12	Speed	0	The speed is not 0.
		1	The speed is 0.
13	–	0	Reserved.

- Bits 10, 12, and 13: Profile Torque Mode

Bit	State	Value	Description
10	Target reached	0	<i>Halt</i> (bit 8 in <i>controlword</i>) = 0: The target torque has not been reached. <i>Halt</i> (bit 8 in <i>controlword</i>) = 1: The axis is decelerating.
		1	<i>Halt</i> (bit 8 in <i>controlword</i>) = 0: The target torque was reached. <i>Halt</i> (bit 8 in <i>controlword</i>) = 1: The axis is stopped.
12	–	0	Reserved.
13	–	0	Reserved.

Quick Stop Option Code (605Ah)

This object determines what operation will be performed if a Quick Stop is executed.

Index	Sub-index	Name	Data Type	Access	PDO Mapping	Value	Saving to EEPROM
605Ah	0	Quick stop option code	INT	RW	No	0 to 4 (default: 2)	Yes

◆ Data Description

Value	Description
0	Disables the Servo Drive (moves to the Switch ON Disabled state).
1	Decelerates at the deceleration rate for decelerating to a stop and moves to the Switch ON Disabled state.*1, *2
2	Decelerates at the deceleration rate for a quick stop and moves to the Switch ON Disabled state.*1, *3
3	Decelerates at the torque limit and moves to the Switch ON Disabled state.*1

*1. The motor is always stopped according to option code 0 (servo OFF stop) in Profile Torque Mode or Cyclic Torque Mode.

*2. The deceleration rate for decelerating to a stop is defined in the following object.

- Profile Position, Interpolated Position, Cyclic Position, or Cyclic Velocity Mode: 6084h
- Homing Mode: 609Ah

*3. *Quick stop deceleration* (6085h) is the deceleration rate for a quick stop.

Shutdown Option Code (605Bh)

This object defines the operation that is performed if there is a move from Operation Enable state to Ready to Switch ON state.

Index	Sub-index	Name	Data Type	Access	PDO Mapping	Value	Saving to EEPROM
605Bh	0	Shutdown option code	INT	RW	No	0 to 1 (default: 0)	Yes

◆ Data Description

Value	Description
0	Disables the Servo Drive (moves to the Switch ON Disabled state).
1	Decelerates at the deceleration rate for decelerating to a stop and moves to the Switch ON Disabled state. *1, *2

*1. The motor is always stopped according to option code 0 (servo OFF stop) in Profile Torque Mode or Cyclic Torque Mode.

*2. The deceleration rate for decelerating to a stop is defined in the following object.

- Profile Position, Interpolated Position, Cyclic Position, or Cyclic Velocity Mode: 6084h
- Homing Mode: 609Ah

Disable Operation Option Code (605Ch)

This object defines the operation that is performed if there is a move from Operation Enable state to Switched ON state.

Index	Sub-index	Name	Data Type	Access	PDO Mapping	Value	Saving to EEPROM
605Ch	0	Disable operation option code	INT	RW	No	0 to 1 (default: 1)	Yes

◆ Data Description

Value	Description
0	Disables the Servo Drive (moves to the Switch ON Disabled state).
1	Decelerates at the deceleration rate for decelerating to a stop and moves to the Switch ON Disabled state. *1, *2

*1. The motor is always stopped according to option code 0 (servo OFF stop) in Profile Torque Mode or Cyclic Torque Mode.

*2. The deceleration rate for decelerating to a stop is defined in the following object.

- Profile Position, Interpolated Position, Cyclic Position, or Cyclic Velocity Mode: 6084h
- Homing Mode: 609Ah

Halt Option Code (605Dh)

This object defines the operation that is performed if bit 8 (Halt) in *controlword* is active.

Index	Sub-index	Name	Data Type	Access	PDO Mapping	Value	Saving to EEPROM
605Dh	0	Halt option code	INT	RW	No	0 to 4 (default: 1)	Yes

◆ Data Description

Value	Description
1	Decelerates at the deceleration rate for decelerating to a stop and moves to the Operation Enabled state. *1, *2
2	Decelerates at the deceleration rate for a quick stop and moves to the Operation Enabled state. *1, *3
3	Decelerates at the torque limit and moves to the Operation Enabled state. *1

*1. If bit 8 (Halt) is 1 in Profile Torque Mode or Cyclic Torque Mode, the torque reference value is reduced to zero.

*2. The deceleration rate for decelerating to a stop is defined in the following object.

- Profile Position, Interpolated Position, Cyclic Position, or Cyclic Velocity Mode: 6084h
- Homing Mode: 609Ah

*3. *Quick stop deceleration* (6085h) is the deceleration rate for a quick stop.

Fault Reaction Option Code (605Eh)

This object defines the operation that is performed when an alarm is detected in the Servo Drive system.

Index	Subindex	Name	Data Type	Access	PDO Mapping	Value	Saving to EEPROM
605Eh	0	Fault reaction option code	INT	RW	No	0	Yes

◆ Data Description

Value	Description
0	Disables the Servo Drive. (Turns OFF the servo.)

Modes of Operation (6060h)

This object is used to select the operation mode. The Servo Drive gives the actual operation mode in the *modes of operation display* object.

Index	Subindex	Name	Data Type	Access	PDO Mapping	Value	Saving to EEPROM
6060h	0	Modes of operation	SINT	RW	Yes	0 to 10 (default: 0)	Yes

◆ Data Description

Value	Description
0	There is no mode change or no mode assigned.
1	Profile Position Mode
2	Reserved (continue previous mode).
3	Profile Velocity Mode
4	Torque Profile mode
6	Homing Mode
7	Interpolated Position Mode
8	Cyclic Sync Position Mode
9	Cyclic Sync Velocity Mode
10	Cyclic Sync Torque Mode
Other value	Reserved (continue previous mode).

Modes of Operation Display (6061h)

This object gives the current mode of operation.

The values that are returned are the same as the object codes for *modes of operation* (6060h).

Index	Subindex	Name	Data Type	Access	PDO Mapping	Value	Saving to EEPROM
6061h	0	Modes of operation display	SINT	RO	Yes	0	No

Supported Drive Modes (6502h)

This object gives the operation modes that are supported by the device.

Index	Sub-index	Name	Data Type	Access	PDO Mapping	Value	Saving to EEPROM
6502h	0	Supported drive modes	UDINT	RO	No	03EDh	No

◆ Data Description

Bit	Applicable Mode	Definition
0	Pp (Profile position mode)	1: Supported.
1	Vl (Velocity mode)	0: Not supported.
2	Pv (Profile velocity mode)	1: Supported.
3	Tq (Torque profile mode)	1: Supported.
4	Reserved.	0
5	Hm (Homing mode)	1: Supported.
6	Ip (Interpolated position mode)	1: Supported.
7	Csp (Cyclic sync position mode)	1: Supported.
8	Csv (Cyclic sync velocity mode)	1: Supported.
9	Cst (Cyclic sync torque mode)	1: Supported.
10 to 31	Reserved.	0

15.7 Profile Position Mode

Target Position (607Ah)

This object contains the target position for the Profile Position Mode or Cyclic Synchronous Position Mode.

In Profile Position Mode, the value of this object is interpreted as either an absolute or relative value depending on the Abs/Rel Flag in *controlword*. In Cyclic Synchronous Position Mode, the value is always interpreted as an absolute value.

Index	Sub-index	Name	Data Type	Access	PDO Mapping	Value	Saving to EEPROM
607Ah	0	Target position	DINT	RW	Yes	-2,147,483,648 to 2,147,483,647 (default: 0) [Pos. unit]	No

Software Position Limits (607Dh)

This object defines the absolute positions of the limits to the target position (*position demand value*). Every target position is checked against these limits.

The limit positions are specified in user-defined position reference units, the same as for target positions, and are always relative to the machine home position.

The limit values are corrected internally for the *home offset* as given below. The target positions are compared with the corrected values.

- Corrected minimum position limit = Min position limit – Home offset (607Ch)
- Corrected maximum position limit = Max position limit – Home offset (607Ch)

The software position limits are enabled at the following times:

- When homing is completed
- When an absolute encoder is connected

The software limits are disabled if they are set as follows:

- Min position limit \geq Max position limit

Index	Sub-index	Name	Data Type	Access	PDO Mapping	Value	Saving to EEPROM
607Dh	0	Number of entries	USINT	RO	No	2	No
	1	Min position limit	DINT	RW	No	-536,870,912 to 536,870,911 (default: 0) [Pos. unit]	Yes
	2	Max position limit	DINT	RW	No	-536,870,912 to 536,870,911 (default: 0) [Pos. unit]	Yes

Max Profile Velocity (607Fh)

This object contains the maximum speed during a Profile Mode operation.

Index	Sub-index	Name	Data Type	Access	PDO Mapping	Value	Saving to EEPROM
607Fh	0	Max profile velocity	UDINT	RW	Yes	0 to 4,294,967,295 (default: 2,147,483,647) [Vel. unit]	Yes

Profile Velocity (6081h)

This object contains the final movement speed at the end of acceleration for a Profile Mode operation.

Index	Subindex	Name	Data Type	Access	PDO Mapping	Value	Saving to EEPROM
6081h	0	Profile velocity	UDINT	RW	Yes	0 to 4,294,967,295 (default: 0) [Vel. unit]	Yes

Profile Acceleration (6083h)

This object specifies the acceleration rate for Profile Mode operations.

Index	Subindex	Name	Data Type	Access	PDO Mapping	Value	Saving to EEPROM
6083h	0	Profile acceleration	UDINT	RW	Yes	0 to 4,294,967,295 (default: 1,000) [Acc. unit]	Yes

Profile Deceleration (6084h)

This object specifies the deceleration rate for Profile Mode operations.

Index	Subindex	Name	Data Type	Access	PDO Mapping	Value	Saving to EEPROM
6084h	0	Profile deceleration	UDINT	RW	Yes	0 to 4,294,967,295 (default: 1,000) [Acc. unit]	Yes

Quick Stop Deceleration (6085h)

This object contains the deceleration rate that is used to stop the motor if the *quick stop option code* (605Ah) is set to 2 and the Quick Stop command is given.

Index	Subindex	Name	Data Type	Access	PDO Mapping	Value	Saving to EEPROM
6085h	0	Quick stop deceleration	UDINT	RW	Yes	0 to 4,294,967,295 (default: 1,000) [Acc. unit]	Yes

15.8 Homing Mode

Home Offset (607Ch)

This object contains the offset between the zero position for the application and the machine home position (found during homing).

Index	Sub-index	Name	Data Type	Access	PDO Mapping	Value	Saving to EEPROM
607Ch	0	Home offset	DINT	RW	No	-536,870,912 to 536,870,911 (default: 0) [Pos. unit]	Yes

- **Incremental Encoder**

The machine home position is found during homing. After homing is completed, the zero position is offset from the home position by adding the home offset to the home position.

- **Absolute Encoder**

If an absolute encoder is connected to the SERVOPACK, the home offset is added to the encoder absolute position when the power supply to the SERVOPACK is turned ON.



Homing Method (6098h)

This object specifies the homing method. Refer to the following section for details on the operations that are performed.

14.4 Homing on page 14-14

Index	Sub-index	Name	Data Type	Access	PDO Mapping	Value	Saving to EEPROM
6098h	0	Homing method	SINT	RW	Yes	0 to 35 (default: 35)	No

◆ Data Description

Value (Method)	Description
0	Homing is disabled.
1	Homing with the negative limit switch and index pulse
2	Homing with the positive limit switch and index pulse
7 to 14	Homing with the home switch and index pulse
24	Homing with the home switch
28	Homing with the home switch
33 or 34	Homing with the index pulse
35	Homing with the current position

Homing Speeds (6099h)

This object defines the speeds that are used during homing. The speeds are given in user speed reference units.

Index	Sub-index	Name	Data Type	Access	PDO Mapping	Value	Saving to EEPROM
6099h	0	Number of entries	USINT	RO	No	2	No
	1	Speed during search for switch	UDINT	RW	Yes	0 to 4,294,967,295 (default: 500,000) [Vel. unit]	Yes
	2	Speed during search for zero	UDINT	RW	Yes	0 to 4,294,967,295 (default: 100,000) [Vel. unit]	Yes

Homing Acceleration (609Ah)

This object defines the acceleration that is used during homing. The rate is given in user acceleration reference units.

Index	Sub-index	Name	Data Type	Access	PDO Mapping	Value	Saving to EEPROM
609Ah	0	Homing acceleration	UDINT	RW	Yes	0 to 4,294,967,295 (default: 1,000) [Acc. unit]	Yes

15.9 Position Control Function

Position Demand Value (6062h)

This object specifies the current reference position in user position reference units.

Index	Sub-index	Name	Data Type	Access	PDO Mapping	Value	Saving to EEPROM
6062h	0	Position demand value	DINT	RO	Yes	– [Pos. unit]	No

Position Actual Internal Value (6063h)

This object gives the current feedback position in encoder pulse units.

Index	Sub-index	Name	Data Type	Access	PDO Mapping	Value	Saving to EEPROM
6063h	0	Position actual internal value	DINT	RO	Yes	– [inc]	No

Position Actual Value (6064h)

This object gives the current feedback position in user position reference units.

Index	Sub-index	Name	Data Type	Access	PDO Mapping	Value	Saving to EEPROM
6064h	0	Position actual value	DINT	RO	Yes	– [Pos. unit]	No

Position Demand Internal Value (60FCh)

This object gives the output of the trajectory generator during position control (the position that is input to the position loop). The value is given in encoder pulses.

Index	Sub-index	Name	Data Type	Access	PDO Mapping	Value	Saving to EEPROM
60FCh	0	Position demand internal value	DINT	RO	Yes	– [inc]	No

Following Error Window (6065h)

This object defines the detection range for the following error (bit 13 of *statusword*).

If the position deviation exceeds the *following error window* for the *following error time out* (6066h), bit 13 in *statusword* changes to 1 to indicate following error. A following error can occur when the Servo Drive is blocked, when the profile speed is too high, or when the gain settings are not correct.

Index	Sub-index	Name	Data Type	Access	PDO Mapping	Value	Saving to EEPROM
6065h	0	Following error window	UDINT	RW	No	0 to 1,073,741,823 (default: 5,242,880) [Pos. unit]	Yes

Following Error Time Out (6066h)

If the position deviation exceeds the *following error window* for the time specified in this object, bit 13 in *statusword* changes to 1 to indicate following error.

Index	Sub-index	Name	Data Type	Access	PDO Mapping	Value	Saving to EEPROM
6066h	0	Following error time out	UINT	RW	No	0 to 65,535 (default: 0) [ms]	Yes

Following Error Actual Value (60F4h)

This object provides the current following error.

Index	Subindex	Name	Data Type	Access	PDO Mapping	Value	Saving to EEPROM
60F4h	0	Following error actual value	DINT	RO	Yes	– [Pos. unit]	No

Position Window (6067h)

This object defines the positioning completed width for the target position. When the Servo Drive has completed outputting the reference to the target position and the time specified in *position window time* (6068h) has passed after the distance between the target position and the *position actual value* is within the value of this object, bit 10 (*target reached*) in *statusword* changes to 1.

Index	Subindex	Name	Data Type	Access	PDO Mapping	Value	Saving to EEPROM
6067h	0	Position window	UDINT	RW	No	0 to 1,073,741,823 (default: 30) [Pos. unit]	Yes

Position Window Time (6068h)

When the Servo Drive has completed outputting the reference to the target position and the time specified in this object has passed after the distance between the target position and the *position actual value* is within the *position window* (6067h), bit 10 (*target reached*) in *statusword* changes to 1.

Index	Subindex	Name	Data Type	Access	PDO Mapping	Value	Saving to EEPROM
6068h	0	Position window time	UINT	RW	No	0 to 65,535 (default: 0) [ms]	Yes

15.10 Interpolated Position Mode

Interpolation Submode Select (60C0h) (Object Shared by Mode 1 and Mode 2)

This object is used to select the submode for the Interpolated Position Mode. To use Interpolated Position Mode, set this object first.

Index	Subindex	Name	Data Type	Access	PDO Mapping	Value	Saving to EEPROM
60C0h	0	Interpolation sub mode select	INT	RW	No	-3 to 0 (default: 0)	No

◆ Data Description

Value (Method)	Description
0	Selects mode 1 with no position reference filter. <i>Interpolation data record (60C1h) is used as the interpolation position reference.</i>
-1	Selects mode 1 with a position reference filter.*
-2	Selects mode 2 with no position reference filter. <i>Interpolation data record for 1st profile (27C0h) and interpolation data record for 2nd profile (27C1h) are used as the interpolation position references.</i>
-3	Selects mode 2 with a position reference filter.*

* If a reference filter is used, the moving average of the interpolation position over the *interpolation time period* (60C2h) is used.

Interpolation Data Record (60C1h) (Object Shared by Mode 1 and Mode 2)

This object gives the interpolation position reference for Interpolated Position Mode.

Index	Subindex	Name	Data Type	Access	PDO Mapping	Value	Saving to EEPROM
60C1h	0	Number of entries	USINT	RO	No	1	No
	1	Interpolation data record	DINT	RW	Yes	-2,147,483,648 to 2,147,483,647 (default: 0) [Pos. unit]	No

Interpolation Time Period (60C2h) (Object Shared by Mode 1 and Mode 2)

This object defines the interpolated position reference period for Interpolation Position Mode.

If DC Sync0 Mode is selected, the interpolation time period is automatically stored as the Sync0 Cycle Time. If DC Free-Run Mode is selected, set the object manually.

Index	Sub-index	Name	Data Type	Access	PDO Mapping	Value	Saving to EEPROM
60C2h	0	Number of entries	USINT	RO	No	2	No
	1	Interpolation time period value	USINT	RW	No	1 to 250 (default:125)	No
	2	Interpolation time index	SINT	RW	No	-6 to -3 (default: -3)	No

Interpolation time = (Interpolation time period (60C2h: 01)) × 10^{Interpolation time index (60C2h: 02)} [s]

Note: You can change this object only under the following conditions.

- When DC Sync0 Mode Is Selected:
EtherCAT (CoE) is in the Switch ON Disable state.
- When DC Free-run Mode Is Selected:
EtherCAT (CoE) is in the Switch ON Disable state.
Or, EtherCAT (CoE) is in Interpolated Position Mode and *enable interpolation* equals 0.

Manufacturer Interpolation Data Configuration for 1st Profile (2730h) (Mode 2 Object)

This object sets how to use the interpolation position reference in *interpolation data record for 1st profile* (27C0h).

Index	Sub-index	Name	Data Type	Access	PDO Mapping	Value	Saving to EEPROM
2730h	0	Number of entries	USINT	RO	No	9	No
	1	Maximum buffer size	UDINT	RO	No	254	No
	2	Actual buffer size	UDINT	RW	No	254	No
	3	Buffer organization	USINT	RW	No	0 or 1 (default: 0)	No
	4	Buffer position	UINT	RW	Yes	1 to 254 (default: 1)	No
	5	Size of data record	USINT	RO	No	1	No
	6	Buffer clear	USINT	RO	No	0 or 1 (default: 0)	No
	7	Position data definition	USINT	RW	Yes	0 or 1 (default: 1)	No
	8	Position data polarity	USINT	RW	Yes	0 or 1 (default: 0)	No
9	Behavior after reaching buffer position	USINT	RW	Yes	0 or 1 (default: 0)	No	

◆ 2730h: 3 Buffer Organization

Value (Method)	Description
0	Uses the reference input buffer as a FIFO buffer.
1	Uses the reference input buffer is as a ring buffer.

Note: Do not change this value while *enable interpolation* (6040h bit 4) is 1.

◆ 2730h: 4 Buffer Position

The object contains the entry point for the available area in the reference input buffer.

Note: Do not change this value while *enable interpolation* (6040h bit 4) is 1.

◆ 2730h: 6 Buffer Clear

Value (Method)	Description
0	Disables the reference input buffer.
1	Enables the reference input buffer.

◆ 2730h: 7 Position Data Definition

Value (Method)	Description
0	Uses the value in the reference input buffer as an absolute value.
1	Uses the value in the reference input buffer as a relative value.

To enable changing this value, set the write pointer (2741h: 2) and the read pointer (2741h: 1) to the same value.

◆ 2730h: 8 Position Data Polarity

Value (Method)	Description
0	Multiplies the value in the reference input buffer by 1.
1	Multiplies the value in the reference input buffer by -1.

This value is valid when *position data definition* (2730h: 7) is 1.

To enable changing this value, set the write pointer (2741h: 2) and the read pointer (2741h: 1) to the same value.

◆ 2730h: 9 Behavior after Reaching Buffer Position

Value (Method)	Description
0	Holds the value of the read pointer (2741h: 1) when the read pointer (2741h: 1) equals the write pointer (2741h: 2) and <i>enable interpolation</i> is 0.
1	Initializes the value of the read pointer (2741h: 1) when the read pointer (2741h: 1) equals the write pointer (2741h: 2) and <i>enable interpolation</i> is 0.

This value is valid when *buffer organization* (2731h: 3) is 0.

Manufacturer Interpolation Data Configuration for 2nd Profile (2731h) (Mode 2 Object)

This object sets how to use the interpolation position reference in *interpolation data record for 2nd profile* (27C1h).

Index	Sub-index	Name	Data Type	Access	PDO Mapping	Value	Saving to EEPROM
2731h	0	Number of entries	USINT	RO	No	9	No
	1	Maximum buffer size	UDINT	RO	No	254	No
	2	Actual buffer size	UDINT	RW	No	254	No
	3	Buffer organization	USINT	RW	No	0 or 1 (default: 0)	No
	4	Buffer position	UINT	RW	Yes	1 to 255 (default: 1)	No
	5	Size of data record	USINT	RO	No	1	No
	6	Buffer clear	USINT	RO	No	0 or 1 (default: 0)	No
	7	Position data definition	USINT	RW	Yes	0 or 1 (default: 0)	No
	8	Position data polarity	USINT	RW	Yes	0 or 1 (default: 0)	No
9	Behavior after reaching buffer position	USINT	RW	Yes	0 or 1 (default: 0)	No	

◆ 2731h: 3 Buffer Organization

Value (Method)	Description
0	Uses the reference input buffer as a FIFO buffer.
1	Uses the reference input buffer as a ring buffer.

Note: Do not change this value while *enable interpolation* (6040h bit 4) is 1.

◆ 2731h: 4 Buffer Position

This object contains the entry point for the available area in the reference input buffer.

Note: Do not change this value while *enable interpolation* (6040h bit 4) is 1.

◆ 2731h: 6 Buffer Clear

Value (Method)	Description
0	Disables the reference input buffer.
1	Enables the reference input buffer.

◆ 2731h: 7 Position Data Definition

Value (Method)	Description
0	Uses the value in the reference input buffer as an absolute value.
1	Uses the value in the reference input buffer as a relative value.

To enable changing this value, set the write pointer (2741h: 2) and the read pointer (2741h: 1) to the same value.

◆ 2731h: 8 Position Data Polarity

Value (Method)	Description
0	Multiplies the value in the reference input buffer by 1.
1	Multiplies the value in the reference input buffer by -1.

This value is valid when *position data definition* (2731h: 7) is 1.

To enable changing this value, set the write pointer (2741h: 2) and the read pointer (2741h: 1) to the same value.

◆ 2731h: 9 Behavior after Reaching Buffer Position

Value (Method)	Description
0	Holds the value of the read pointer (2741h: 1) when the read pointer (2741h: 1) equals the write pointer (2741h: 2) and <i>enable interpolation</i> is 0.
1	Initializes the value of the read pointer (2741h: 1) when the read pointer (2741h: 1) equals the write pointer (2741h: 2) and <i>enable interpolation</i> is 0.

This value is valid when *buffer organization* (2731h: 3) is 0.

Interpolation Profile Select (2732h) (Mode 2 Object)

This object is used to select the type of interpolation profile to use. Change the interpolation profile only after execution of the current profile has been completed. You can change the object when *enable interpolation* (6040h bit 4) is 0.

Index	Sub-index	Name	Data Type	Access	PDO Mapping	Value	Saving to EEPROM
2732h	0	Interpolation profile select	USINT	RW	Yes	0 or 1 (default: 0)	No

◆ Data Description

Value (Method)	Description
0	Uses the 1st profile. (<i>interpolation data record for 1st profile</i> (27C0h) and <i>manufacturer interpolation data configuration for 1st profile</i> (2730h) are enabled.)
1	Uses the 2nd profile. (<i>interpolation data record for 2nd profile</i> (27C1h) and <i>manufacturer interpolation data configuration for 2nd profile</i> (2731h) are enabled.)

Note: Do not change this value while *enable interpolation* (6040h bit 4) is 1.

Interpolation Data Record for 1st Profile (27C0h) (Mode 2 Object)

This object is used to set the interpolation position reference for the 1st profile in Buffer Strategies for the Interpolated Position Mode.

Set this object only after setting all of the items in *manufacturer interpolation data configuration for 1st profile* (2730h).

After you set this object, set *enable interpolation* (6040h bit 4) to 1.

Index	Sub-index	Name	Data Type	Access	PDO Mapping	Value	Saving to EEPROM
27C0h	0	Number of entries	USINT	RO	No	254	No
	1 to 254	1st set point to 254th set point	DINT	RW	No	-2,147,483,648 to 2,147,483,647 (default:0)	No

Interpolation Data Record for 2nd Profile (27C1h) (Mode 2 Object)

This object is used to set the interpolation position reference for the 2nd profile in Buffer Strategies for the Interpolated Position Mode.

Set this object only after setting all of the items in *manufacturer interpolation data configuration for 2nd profile* (2731h).

After you set this object, set *enable interpolation* (6040h bit 4) to 1.

Index	Sub-index	Name	Data Type	Access	PDO Mapping	Value	Saving to EEPROM
27C1h	0	Number of entries	USINT	RO	No	254	No
	1 to 254	1st set point to 254th set point	DINT	RW	No	-2,147,483,648 to 2,147,483,647 (default:0)	No

Interpolation Data Read/Write Pointer Position Monitor (2741h) (Mode 2 Object)

This object gives the current values of the read and write pointers for the reference input buffers in the EtherCAT (CoE) Network Module.

Index	Sub-index	Name	Data Type	Access	PDO Mapping	Value	Saving to EEPROM
2741h	0	Number of entries	USINT	RO	No	2	No
	1	Interpolation data read pointer position	UINT	RO	Yes	1 to 254	No
	2	Interpolation data write pointer position	UINT	RO	Yes	1 to 254	No

◆ 2741h: 1 Interpolation Data Read Pointer Position

This object gives the current value of the read pointer for the reference input buffer in the EtherCAT (CoE) Network Module.

◆ 2741h: 2 Interpolation Data Write Pointer Position

This object gives the current value of the write pointer for the reference input buffer in the EtherCAT (CoE) Network Module.

15.11 Cyclic Synchronous Position Mode

Velocity Offset (60B1h)

In Cyclic Synchronous Position Mode, this object contains the speed feedforward value.

In Cyclic Synchronous Velocity Mode, this object contains the offset value to add to the speed reference.

Index	Subindex	Name	Data Type	Access	PDO Mapping	Value	Saving to EEPROM
60B1h	0	Velocity offset	DINT	RW	Yes	-2,147,483,648 to 2,147,483,647 (default: 0) [Vel. unit]	No

Torque Offset (60B2h)

In Cyclic Synchronous Position Mode or Cyclic Synchronous Velocity Mode, this object contains the torque feedforward value. In Cyclic Synchronous Torque Mode, this object contains the offset value to add to the torque reference.

Index	Subindex	Name	Data Type	Access	PDO Mapping	Value	Saving to EEPROM
60B2h	0	Torque offset	INT	RW	Yes	-32,768 to 32,767 (default: 0) [0.1%]	No

15.12 Profile Velocity/Cyclic Synchronous Velocity Mode

Velocity Demand Value (606Bh)

This object contains the output value from the velocity trajectory generator or the output value from the position control function (i.e., the input reference for the speed loop).

Index	Sub-index	Name	Data Type	Access	PDO Mapping	Value	Saving to EEPROM
606Bh	0	Velocity demand value	DINT	RO	Yes	– [Vel. unit]	No

Velocity Actual Value (606Ch)

This object contains the motor speed.

Index	Sub-index	Name	Data Type	Access	PDO Mapping	Value	Saving to EEPROM
606Ch	0	Velocity actual value	DINT	RO	Yes	– [Vel. unit]	No

Velocity Window (606Dh)

This object sets the speed coincidence detection width.

When the time specified in *velocity window time* (606Eh) has passed after the difference between the target speed (*target velocity*) and the *velocity actual value* is within the setting of the *velocity window*, bit 10 (*target reached*) in *statusword* is set to 1.

Index	Sub-index	Name	Data Type	Access	PDO Mapping	Value	Saving to EEPROM
606Dh	0	Velocity window	UINT	RW	No	0 to 65,535 (default: 20,000) [Vel. unit]	Yes

Velocity Window Time (606Eh)

When the time specified in *velocity window time* (606Eh) has passed after the difference between the target speed (*target velocity*) and the *velocity actual value* is within the setting of the *velocity window*, bit 10 (*target reached*) in *statusword* is set to 1.

Index	Sub-index	Name	Data Type	Access	PDO Mapping	Value	Saving to EEPROM
606Eh	0	Velocity window time	UINT	RW	No	0 to 65,535 (default: 0) [ms]	Yes

Target Velocity (60FFh)

This object specifies the target speed for Profile Velocity Mode or Cyclic Synchronous Velocity Mode in user defined speed reference units.

Index	Sub-index	Name	Data Type	Access	PDO Mapping	Value	Saving to EEPROM
60FFh	0	Target velocity	DINT	RW	Yes	–2,147,483,648 to 2,147,483,647 (default: 0) [Vel. unit]	No

15.13 Profile Torque/Cyclic Synchronous Torque Mode

Target Torque (6071h)

This object specifies the input torque reference value for Torque Control Mode. Set the value in units of 0.1% of the motor rated torque.

Index	Subindex	Name	Data Type	Access	PDO Mapping	Value	Saving to EEPROM
6071h	0	Target torque	INT	RW	Yes	-32,768 to 32,767 (default: 0) [0.1%]	No

Torque Demand Value (6074h)

This object gives the currently output torque reference value. The value is given in units of 0.1% of the motor rated torque.

Index	Subindex	Name	Data Type	Access	PDO Mapping	Value	Saving to EEPROM
6074h	0	Torque demand value	INT	RO	Yes	- [0.1%]	No

Torque Slope (6087h)

This object sets the torque output slope to use in Profile Torque Mode. Set the value as the rate of change per second (0.1%/s) in respect to the motor rated torque.

Index	Subindex	Name	Data Type	Access	PDO Mapping	Value	Saving to EEPROM
6087h	0	Torque slope	UDINT	RW	Yes	0 to 4,294,967,295 (default:1,000) [0.1%/s]	Yes

Motor Rated Torque (6076h)

This object gives the motor rated torque (rated force for a Linear Servomotor). The value is given in m·Nm for a Rotary Servomotor, and in m·N for a Linear Servomotor.

Index	Subindex	Name	Data Type	Access	PDO Mapping	Value	Saving to EEPROM
6076h	0	Motor rated torque	UDINT	RO	No	-[mNm] or [mN]	No

Torque Actual Value (6077h)

For a SERVOPACK, this object contains the same value as the torque reference output value.

Index	Subindex	Name	Data Type	Access	PDO Mapping	Value	Saving to EEPROM
6077h	0	Torque actual value	INT	RO	Yes	- [0.1%]	No

15.14 Torque Limit Function

Max Torque (6072h)

This object sets the maximum output torque for the motor. Set the value in units of 0.1% of the motor rated torque.

The maximum motor torque is automatically set in this object when the power is turned ON.

Index	Sub-index	Name	Data Type	Access	PDO Mapping	Value	Saving to EEPROM
6072h	0	Max torque	UINT	RW	Yes	0 to 65,535 (default: maximum motor torque) [0.1%]	No

Positive Torque Limit Value (60E0h)

This object sets the positive torque limit. Set the value in units of 0.1% of the motor rated torque.

Index	Sub-index	Name	Data Type	Access	PDO Mapping	Value	Saving to EEPROM
60E0h	0	Positive torque limit value	UINT	RW	Yes	0 to 65,535 (default: 8,000) [0.1%]	Yes

Negative Torque Limit Value (60E1h)

This object sets the negative torque limit. Set the value in units of 0.1% of the motor rated torque.

Index	Sub-index	Name	Data Type	Access	PDO Mapping	Value	EEPROM
60E1h	0	Negative torque limit value	UINT	RW	Yes	0 to 65,535 (default: 8,000) [0.1%]	Yes

15.15 Touch Probe Function

Touch Probe Function (60B8h)

This object sets the touch probes.

Index	Subindex	Name	Data Type	Access	PDO Mapping	Value	Saving to EEPROM
60B8h	0	Touch probe function	UINT	RW	Yes	0 to 0xFFFF (default: 0)	No

◆ Data Description

Bit	Value	Description
0	0	Disables touch probe 1.
	1	Enables touch probe 1.
1	0	Single Trigger Mode (Latches the position at the first trigger event.)
	1	Continuous Trigger Mode (Latches the position every trigger event.)
2	0	Triggers on probe 1 input (SERVOPACK CN1/Probe 1 (SI4) signal).
	1	Triggers on encoder zero signal (phase C).
3	–	Reserved.
4	0	Stops sampling at touch probe 1.
	1	Starts sampling at touch probe 1
5 to 7	–	Reserved.
8	0	Disables touch probe 2.
	1	Enables touch probe 2.
9	0	Single Trigger Mode (Latches the position at the first trigger event.)
	1	Continuous Trigger Mode (Latches the position every trigger event.)
10	0	Triggers on probe 2 input (SERVOPACK CN1/Probe 2 (SI5) signal).
	1	Reserved.
11	–	Reserved.
12	0	Stops sampling at touch probe 2.
	1	Starts sampling at touch probe 2
13 to 15	–	Reserved.

Note: 1. Bits 0 to 7: For touch probe 1.

Bits 8 to 15: For touch probe 2.

2. Touch probe 1 cannot be used during execution of homing. If touch probe 1 was already enabled, it will be disabled when homing is started.

3. If 1 is specified for bit 1 (i.e., if Continuous Trigger Mode is set), the setting of bit 2 (Trigger Selection Signal) will be read each time the latch is started. To continuously latch with the same trigger signal, do not change the status of bit 2.

Touch Probe Status (60B9h)

This object gives the status of the touch probes.

Index	Subindex	Name	Data Type	Access	PDO Mapping	Value	Saving to EEPROM
60B9h	0	Touch probe status	UINT	RO	Yes	–	No

◆ Data Description

Bit	Value	Description
0	0	Touch probe 1 is disabled.
	1	Touch probe 1 is enabled.
1	0	No latched position is stored for touch probe 1.
	1	A latch position is stored for touch probe 1.
2 to 6	–	Reserved.
7	0 or 1	Saving the latched position for Continuous Trigger Mode for touch probe 1 was completed.* (Status toggles every time a position is latched.)
8	0	Touch probe 2 is disabled.
	1	Touch probe 2 is enabled.
9	0	No latched position is stored for touch probe 2.
	1	A latch position is stored for touch probe 2.
10 to 14	–	Reserved.
15	1	Saving the latched position for Continuous Trigger Mode for touch probe 2 was completed.* (Status toggles every time a position is latched.)

* If the continuous latch is enabled (60B8h bit 1 = 1 or bit 9 = 1), bit 7 or bit 15 of object 60B9h is toggled every time the latched position is updated.

Touch Probe 1 Position Value (60BAh)

This object gives the latched position for touch probe 1. The value is given in user position units (Pos. unit).

Index	Sub-index	Name	Data Type	Access	PDO Mapping	Value	Saving to EEPROM
60BAh	0	Touch probe 1 position value	DINT	RO	Yes	– [Pos. unit]	No

Touch Probe 2 Position Value (60BCh)

This object gives the latched position for touch probe 2. The value is given in user position units (Pos. unit).

Index	Sub-index	Name	Data Type	Access	PDO Mapping	Value	Saving to EEPROM
60BCh	0	Touch probe 2 position value	DINT	RO	Yes	– [Pos. unit]	No

15.16 Digital Inputs/Outputs

Digital Inputs (60FDh)

This object gives the status of the *digital inputs* to CN1 on the SERVOPACK.

Index	Subindex	Name	Data Type	Access	PDO Mapping	Value	Saving to EEPROM
60FDh	0	Digital inputs	UDINT	RO	Yes	–	No

◆ Data Description

Bit	Signal	Description
0	N-OT: Negative limit switch	0: OFF, 1: ON
1	P-OT: Positive limit switch	0: OFF, 1: ON
2	Home switch	0: OFF, 1: ON
3 to 15	–	Reserved.
16	SI0	0: OFF (open), 1: ON (closed)
17	SI1	0: OFF (open), 1: ON (closed)
18	SI2	0: OFF (open), 1: ON (closed)
19	SI3	0: OFF (open), 1: ON (closed)
20	SI4	0: OFF (open), 1: ON (closed)
21	SI5	0: OFF (open), 1: ON (closed)
22	SI6	0: OFF (open), 1: ON (closed)
23	–	Reserved.
24	HWBB1	Hardwired base block signal input 1 (0: Open, 1: Closed)
25	HWBB2	Hardwired base block signal input 2 (0: Open, 1: Closed)
26 to 31	–	Reserved.

Digital Outputs (60FEh)

This object controls the status of the general-purpose output signals (SO1 to SO5) from CN1 on the SERVOPACK.

Subindex 1 is used to control the status of the output signals. Subindex 2 determines which output signals in subindex 1 are enabled.

For objects 250Eh, 250Fh, 2510h, 2513h, 251Ah, 2752h, and 2753h:

If SERVOPACK status outputs are assigned to the SO1 to SO5 signals in the above objects, the status will be output using ORs with the settings in this object. If any of these signals (SO1 to SO5) are assigned to functions that are enabled with the above objects, use the Bit Masks in subindex 2 to disable the corresponding signals so that the signals are not duplicated.

Index	Sub-index	Name	Data Type	Access	PDO Mapping	Value	Saving to EEPROM
60FEh	0	Number of entries	USINT	RO	No	2	No
	1	Physical outputs* ¹	UDINT	RW	Yes	0 to 0xFFFFFFFF (default: 0)	No
	2	Bit mask* ²	UDINT	RW	No	0 to 0xFFFFFFFF (default: 0x000C0000)	Yes

*1. Data Description of Physical Outputs:

Bit	Signal	Description
0 to 16	–	Reserved.
17	SO1	0: OFF, 1: ON
18	SO2	0: OFF, 1: ON
19	SO3	0: OFF, 1: ON
20	SO4	0: OFF, 1: ON
21	SO5	0: OFF, 1: ON
22 to 31	–	Reserved.

*2. Data Description of Bit Masks:

Bit	Signal	Description
0 to 16	–	Reserved.
17	SO1	0: Disables physical output. 1: Enables physical output.
18	SO2	0: Disables physical output. 1: Enables physical output.
19	SO3	0: Disables physical output. 1: Enables physical output.
20	SO4	0: Disables physical output. 1: Enables physical output.
21	SO5	0: Disables physical output. 1: Enables physical output.
22 to 31	–	Reserved.

15.17 Dual Encoder Feedback

You can monitor the position of the external encoder in *dual encoder feedback* (60E4h).

Index	Sub-index	Name	Data Type	Access	PDO Mapping	Value	Saving to EEPROM
60E4h	0	Number of entries	USINT	RO	No	1	No
	1	External encoder position	DINT	RO	Yes	(Default: 0)	Yes

Maintenance

16

This chapter provides information on the meaning of, causes of, and corrections for alarms and warnings. In this chapter, the object index number (2□□□h) for EtherCAT communications is given after the SERVOPACK parameter number (Pn□□□)

16.1 Inspections and Part Replacement 16-2

- 16.1.1 Inspections 16-2
- 16.1.2 Guidelines for Part Replacement 16-2
- 16.1.3 Replacing the Battery 16-3

16.2 Alarm Displays 16-5

- 16.2.1 List of Alarms 16-5
- 16.2.2 Troubleshooting Alarms 16-11
- 16.2.3 Resetting Alarms 16-42
- 16.2.4 Displaying the Alarm History 16-43
- 16.2.5 Clearing the Alarm History 16-44
- 16.2.6 Resetting Alarms Detected
in Option Modules 16-45
- 16.2.7 Resetting Motor Type Alarms 16-46

16.3 Warning Displays 16-48

- 16.3.1 List of Warnings 16-48
- 16.3.2 Troubleshooting Warnings 16-49

16.4 Troubleshooting Based on the Operation and Conditions of the Servomotor . . 16-55

16.1 Inspections and Part Replacement

This section describes inspections and part replacement for SERVOPACKs.

16.1.1 Inspections

Perform the inspections given in the following table at least once every year for the SERVO-PACK. Daily inspections are not required.

Item	Frequency	Inspection	Correction
Exterior	At least once a year	Check for dust, dirt, and oil on the surfaces.	Clean with compressed air or a cloth.
Loose Screws		Check for loose terminal block and connector screws and for other loose parts.	Tighten any loose screws or other loose parts.

16.1.2 Guidelines for Part Replacement

The following electric or electronic parts are subject to mechanical wear or deterioration over time. Use one of the following methods to check the standard replacement period.

- Use the service life prediction function of the SERVOPACK.
Refer to the following section for information on service life predictions.

 10.4 Monitoring Product Life on page 10-14

- Use the following table.

Part	Standard Replacement Period	Remarks
Cooling Fan	4 to 5 years	The standard replacement periods given on the left are for the following operating conditions. <ul style="list-style-type: none"> • Surrounding air temperature: Annual average of 30°C • Load factor: 80% max. • Operation rate: 20 hours/day max.
Electrolytic Capacitor	10 years	
Inrush Current Limiting Circuit Relay	100,000 power ON operations	Power ON frequency: Once an hour
Battery	3 years without power supplied	Surrounding temperature without power supplied: 20°C
Built-in Brake Relay*	30,000 operations	Allowable number of operations: 30 operations per minute max.

* Only SERVOPACKs with built-in Servomotor brake control have a built-in brake relay.

When any standard replacement period is close to expiring, contact your Yaskawa representative. After an examination of the part in question, we will determine whether the part should be replaced.



Important

The parameters of any SERVOPACKs that are sent to Yaskawa for part replacement are reset to the factory settings before they are returned to you. Always keep a record of the parameter settings. And, always confirm that the parameters are properly set before starting operation.

16.1.3 Replacing the Battery

If the battery voltage drops to approximately 2.7 V or less, an A.830 alarm (Encoder Battery Alarm) or an A.930 warning (Encoder Battery Warning) will be displayed.

If this alarm or warning is displayed, the battery must be replaced. Refer to the following section for the battery replacement procedure.

 *Battery Replacement Procedure on page 16-3*

Battery Alarm/Warning Selection

Whether to display an alarm or a warning is determined by the setting of Pn008 = n.□□□X (Low Battery Voltage Alarm/Warning Selection).

Parameter	Meaning	When Enabled	Classification
Pn008 (2008h)	n.□□□0 (default setting)	After restart	Setup
	n.□□□1		

- Pn008 = n.□□□0
The ALM (Servo Alarm) signal is output for up to five seconds when the control power supply is turned ON, and then the battery voltage is monitored for four seconds. No alarm will be displayed even if the battery voltage drops below the specified value after these four seconds.
- Pn008 = n.□□□1
The ALM (Servo Alarm) signal is output for up to five seconds when the control power supply is turned ON, and then the battery voltage is monitored continuously.

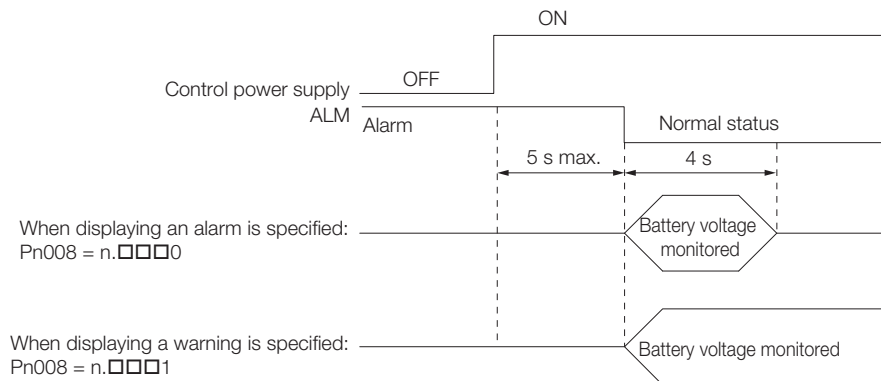

Battery Replacement Procedure

◆ When Installing a Battery on the Host Controller

1. Turn ON only the control power supply to the SERVOPACK.
2. Remove the old battery and mount a new battery.
3. Turn OFF the control power supply to the SERVOPACK to clear the A.830 alarm (Absolute Encoder Battery Error).
4. Turn ON the control power supply to the SERVOPACK again.
5. Make sure that the alarm has been cleared and that the SERVOPACK operates normally.

◆ When Using an Encoder Cable with a Battery Case

1. Turn ON only the control power supply to the SERVOPACK.

 If you remove the battery or disconnect the Encoder Cable while the control power supply to the SERVOPACK is OFF, the absolute encoder data will be lost.

Important

2. Open the cover of the Battery Case.

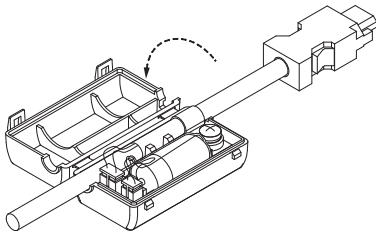

3. Remove the old battery and mount a new battery.

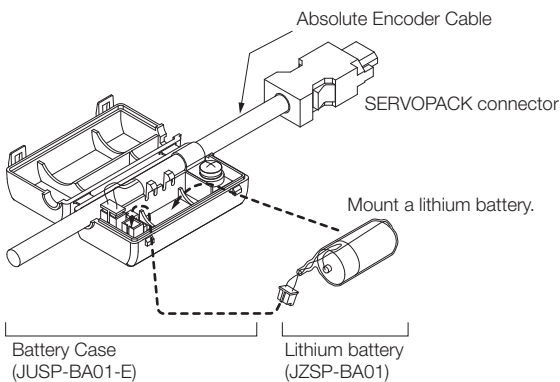

4. Close the cover of the Battery Case.

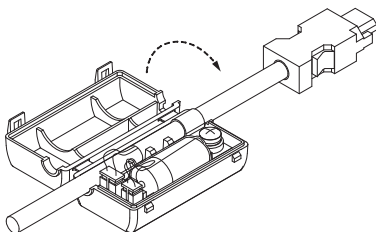

5. Turn OFF the power supply to the SERVOPACK to clear the A.830 alarm (Absolute Encoder Battery Error).
6. Turn ON the power supply to the SERVOPACK.
7. Make sure that the alarm has been cleared and that the SERVOPACK operates normally.

16.2 Alarm Displays

To check an alarm that occurs in the SERVOPACK, use one of the following methods.

However, if no alarm number appears on the panel display, this indicates a SERVOPACK system error. Replace the SERVOPACK.

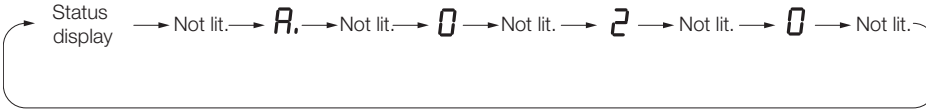
Panel display on SERVOPACK	If there is an alarm, the code will be displayed one character at a time, as shown below. Example: Alarm A.020 
Digital Operator	The alarm code will be displayed.
Statusword (6041h)	Bit 3 (<i>fault</i>) in the <i>statusword</i> will change to 1. (Bit 3 is 0 during normal operation.)
Error Code (603Fh)	A current alarm code is stored in object 603Fh.
Emergency message	The Controller is notified of any alarm that occurs. (Notification may not be possible if EtherCAT communications are unstable.)

This section provides a list of the alarms that may occur and the causes of and corrections for those alarms.

16.2.1 List of Alarms

The following alarm tables gives the alarm name, alarm meaning, alarm stopping method, and alarm reset possibility in order of the alarm codes.

Servomotor Stopping Method for Alarms

Refer to the following section for information on the stopping method for alarms.

 6.12.2 Servomotor Stopping Method for Alarms on page 6-38

Alarm Reset Possibility

Yes: You can use an alarm reset to clear the alarm. However, this assumes that the cause of the alarm has been removed.

No: You cannot clear the alarm.

List of Alarms

Alarm Code	Alarm Name	Alarm Meaning	Servo-motor Stopping Method	Alarm Reset Possible?
020h	Parameter Checksum Error	There is an error in the parameter data in the SERVOPACK.	Gr.1	No
021h	Parameter Format Error	There is an error in the parameter data format in the SERVOPACK.	Gr.1	No
022h	System Checksum Error	There is an error in the parameter data in the SERVOPACK.	Gr.1	No
024h	System Alarm	An internal program error occurred in the SERVOPACK.	Gr.1	No
025h	System Alarm	An internal program error occurred in the SERVOPACK.	Gr.1	No
030h	Main Circuit Detector Error	There is an error in the detection data for the main circuit.	Gr.1	Yes

Continued on next page.

Continued from previous page.

Alarm Code	Alarm Name	Alarm Meaning	Servo-motor Stopping Method	Alarm Reset Possible?
040h	Parameter Setting Error	A parameter setting is outside of the setting range.	Gr.1	No
041h	Encoder Output Pulse Setting Error	The setting of Pn212 (2212h) (Encoder Output Pulses) or Pn281 (2281h) (Encoder Output Resolution) is outside of the setting range or does not satisfy the setting conditions.	Gr.1	No
042h	Parameter Combination Error	<ul style="list-style-type: none"> The value of the program jogging movement speed (Pn533 (2533h) or Pn585 (2585h)) is below the setting range. The required parameters (Pn001, Pn601, and Pn604) have not been set. 	Gr.1	No
044h	Semi-Closed/Fully-Closed Loop Control Parameter Setting Error	The settings of the Option Module and Pn002 = n.X□□□ (External Encoder Usage) do not match.	Gr.1	No
050h	Combination Error	The capacities of the SERVOPACK and Servomotor do not match.	Gr.1	Yes
051h	Unsupported Device Alarm	An unsupported device was connected.	Gr.1	No
070h	Motor Type Change Detected	The connected motor is a different type of motor from the previously connected motor.	Gr.1	No
080h	Linear Encoder Pitch Setting Error	The setting of Pn282 (2282h) (Linear Encoder Pitch) has not been changed from the default setting.	Gr.1	No
0b0h	Invalid Servo ON Command Alarm	The Servo ON command (Enable Operation command) was sent from the host controller after a utility function that turns ON the Servomotor was executed.	Gr.1	Yes
100h	Overcurrent Detected	An overcurrent flowed through the power transistor or the heat sink overheated.	Gr.1	No
101h	Motor Overcurrent Detected	The current to the motor exceeded the allowable current.	Gr.1	No
231h	Built-in Brake Relay Answer Error	The built-in brake relay malfunctioned.	Gr.1	No
232h	Built-in Brake Relay Life Alarm	The number of built-in brake relay operations exceeded the service life of the relay.	Gr.1	No
300h	Regeneration Error	There is an error related to regeneration.	Gr.1	Yes
320h	Regenerative Overload	A regenerative overload occurred.	Gr.2	Yes
330h	Main Circuit Power Supply Wiring Error	<ul style="list-style-type: none"> The AC power supply input setting or DC power supply input setting is not correct. The power supply wiring is not correct. 	Gr.1	Yes
400h	Overvoltage	The main circuit DC voltage is too high.	Gr.1	Yes
410h	Undervoltage	The main circuit DC voltage is too low.	Gr.2	Yes
450h	Main-Circuit Capacitor Overvoltage	The capacitor in the main circuit has deteriorated or is faulty.	Gr.1	No
510h	Overspeed	The motor exceeded the maximum speed.	Gr.1	Yes
511h	Encoder Output Pulse Overspeed	<ul style="list-style-type: none"> Rotary Servomotor: The pulse output speed for the setting of Pn212 (2212h) (Encoder Output Pulses) was exceeded. Linear Servomotor: The motor speed upper limit for the setting of Pn281 (2281h) (Encoder Output Resolution) was exceeded. 	Gr.1	Yes
520h	Vibration Alarm	Abnormal oscillation was detected in the motor speed.	Gr.1	Yes

Continued on next page.

Continued from previous page.

Alarm Code	Alarm Name	Alarm Meaning	Servo-motor Stopping Method	Alarm Reset Possible?
521h	Autotuning Alarm	Vibration was detected during autotuning for the tuning-less function.	Gr.1	Yes
550h	Maximum Speed Setting Error	The setting of Pn385 (2385h) (Maximum Motor Speed) is greater than the maximum motor speed.	Gr.1	Yes
710h	Instantaneous Overload	The Servomotor was operating for several seconds to several tens of seconds under a torque that largely exceeded the rating.	Gr.2	Yes
720h	Continuous Overload	The Servomotor was operating continuously under a torque that exceeded the rating.	Gr.1	Yes
730h	Dynamic Brake Overload	When the dynamic brake was applied, the rotational or linear kinetic energy exceeded the capacity of the Dynamic Brake Resistor.	Gr.1	Yes
731h				
740h	Inrush Current Limiting Resistor Overload	The main circuit power supply was frequently turned ON and OFF.	Gr.1	Yes
7A1h	Internal Temperature Error 1 (Control Board Temperature Error)	The surrounding temperature of the control PCB is abnormal.	Gr.2	Yes
7A2h	Internal Temperature Error 2 (Power Board Temperature Error)	The surrounding temperature of the power PCB is abnormal.	Gr.2	Yes
7A3h	Internal Temperature Sensor Error	An error occurred in the temperature sensor circuit.	Gr.2	No
7A4h	Power Transistor Overheated (Abnormal power transistor temperature.)	The temperature of the power transistor is abnormal.	Gr.2	No
7Abh	SERVOPACK Built-in Fan Stopped	The fan inside the SERVOPACK stopped.	Gr.1	Yes
810h	Encoder Backup Alarm	The power supplies to the encoder all failed and the position data was lost.	Gr.1	No
820h	Encoder Checksum Alarm	There is an error in the checksum results for encoder memory.	Gr.1	No
830h	Encoder Battery Alarm	The battery voltage was lower than the specified level after the control power supply was turned ON.	Gr.1	Yes
840h	Encoder Data Alarm	There is an internal data error in the encoder.	Gr.1	No
850h	Encoder Overspeed	The encoder was operating at high speed when the power was turned ON.	Gr.1	No
860h	Encoder Overheated	The internal temperature of encoder is too high.	Gr.1	No
861h	Motor Overheated	The internal temperature of motor is too high.	Gr.1	No
862h	Overheat Alarm	The input voltage (temperature) for the overheat protection input (TH) signal exceeded the setting of Pn61B (261Bh) (Overheat Alarm Level).	Gr.1	Yes
890h	Encoder Scale Error	A failure occurred in the linear encoder.	Gr.1	No
891h	Encoder Module Error	An error occurred in the linear encoder.	Gr.1	No
8A0h*2	External Encoder Error	An error occurred in the external encoder.	Gr.1	Yes
8A1h*2	External Encoder Module Error	An error occurred in the Serial Converter Unit.	Gr.1	Yes
8A2h*2	External Incremental Encoder Sensor Error	An error occurred in the external encoder.	Gr.1	Yes
8A3h*2	External Absolute Encoder Position Error	An error occurred in the position data of the external encoder.	Gr.1	Yes

Continued on next page.

Continued from previous page.

Alarm Code	Alarm Name	Alarm Meaning	Servo-motor Stopping Method	Alarm Reset Possible?
8A5h*2	External Encoder Overspeed	An overspeed error occurred in the external encoder.	Gr.1	Yes
8A6h*2	External Encoder Overheated	An overheating error occurred in the external encoder.	Gr.1	Yes
A10h	EtherCAT DC Synchronization Error*1	The SERVOPACK and Sync0 events cannot be synchronized.	Gr.2	Yes
A11h	EtherCAT State Error	The EtherCAT AL does not move to the Operational state when the DS402 drive is in Operation Enabled state.	Gr.2	Yes
A12h	EtherCAT Outputs Data Synchronization Error*1	The process data reception events and Sync0 events cannot be synchronized. (Process data communications failed.)	Gr.2	Yes
A20h	Parameter Setting Error	A parameter setting exceeds the setting range.	Gr.1	No
A40h	System Initialization Error	Initialization failed when the power supply was turned ON.	Gr.1	No
A41h	Communication Device Initialization Error	An error occurred during ESC initialization.	Gr.1	No
A47h	Loading Servo Information Error	Loading SERVOPACK information failed.	Gr.1	No
A48h	EEPROM Parameter Data Error	A checksum error occurred in the EEPROM.	Gr.1	No
b33h	Current Detection Error 3	An error occurred in the current detection circuit.	Gr.1	No
bF0h	System Alarm 0	Internal program error 0 occurred in the SERVOPACK.	Gr.1	No
bF1h	System Alarm 1	Internal program error 1 occurred in the SERVOPACK.	Gr.1	No
bF2h	System Alarm 2	Internal program error 2 occurred in the SERVOPACK.	Gr.1	No
bF3h	System Alarm 3	Internal program error 3 occurred in the SERVOPACK.	Gr.1	No
bF4h	System Alarm 4	Internal program error 4 occurred in the SERVOPACK.	Gr.1	No
bF5h	System Alarm 5	Internal program error 5 occurred in the SERVOPACK.	Gr.1	No
bF6h	System Alarm 6	Internal program error 6 occurred in the SERVOPACK.	Gr.1	No
bF7h	System Alarm 7	Internal program error 7 occurred in the SERVOPACK.	Gr.1	No
bF8h	System Alarm 8	Internal program error 8 occurred in the SERVOPACK.	Gr.1	No
C10h	Servomotor Out of Control	The Servomotor ran out of control.	Gr.1	Yes
C20h	Phase Detection Error	The detection of the phase is not correct.	Gr.1	No
C21h	Polarity Sensor Error	An error occurred in the polarity sensor.	Gr.1	No
C22h	Phase Information Disagreement	The phase information does not match.	Gr.1	No
C50h	Polarity Detection Failure	The polarity detection failed.	Gr.1	No
C51h	Overtravel Detected during Polarity Detection	The overtravel signal was detected during polarity detection.	Gr.1	Yes
C52h	Polarity Detection Not Completed	The servo was turned ON before the polarity was detected.	Gr.1	Yes
C53h	Out of Range of Motion for Polarity Detection	The travel distance exceeded the setting of Pn48E (248Eh) (Polarity Detection Range).	Gr.1	No

Continued on next page.

Continued from previous page.

Alarm Code	Alarm Name	Alarm Meaning	Servo-motor Stopping Method	Alarm Reset Possible?
C54h	Polarity Detection Failure 2	The polarity detection failed.	Gr.1	No
C80h	Encoder Clear Error or Multiturn Limit Setting Error	The multiturn data for the absolute encoder was not correctly cleared or set.	Gr.1	No
C90h	Encoder Communications Error	Communications between the encoder and SERVOPACK is not possible.	Gr.1	No
C91h	Encoder Communications Position Data Acceleration Rate Error	An error occurred in calculating the position data of the encoder.	Gr.1	No
C92h	Encoder Communications Timer Error	An error occurred in the communications timer between the encoder and SERVOPACK.	Gr.1	No
CA0h	Encoder Parameter Error	The parameters in the encoder are corrupted.	Gr.1	No
Cb0h	Encoder Echoback Error	The contents of communications with the encoder are incorrect.	Gr.1	No
CC0h	Multiturn Limit Disagreement	Different multiturn limits have been set in the encoder and the SERVOPACK.	Gr.1	No
CF1h*2	Reception Failed Error in Feedback Option Module Communications	Receiving data from the Feedback Option Module failed.	Gr.1	No
CF2h*2	Timer Stopped Error in Feedback Option Module Communications	An error occurred in the timer for communications with the Feedback Option Module.	Gr.1	No
d00h	Position Deviation Overflow	The setting of Pn520 (2520h) (Excessive Position Deviation Alarm Level) was exceeded by the position deviation.	Gr.1	Yes
d01h	Position Deviation Overflow Alarm at Servo ON	The servo was turned ON after the position deviation exceeded the setting of Pn526 (2526h) (Excessive Position Deviation Alarm Level at Servo ON) while the servo was OFF.	Gr.1	Yes
d02h	Position Deviation Overflow Alarm for Speed Limit at Servo ON	If position deviation remains in the deviation counter, the setting of Pn529 (2529h) or Pn584 (2584h) (Speed Limit Level at Servo ON) limits the speed when the servo is turned ON. This alarm occurs if a position reference is input and the setting of Pn520 (2520h) (Excessive Position Deviation Alarm Level) is exceeded before the limit is cleared.	Gr.2	Yes
d10h*2	Motor-Load Position Deviation Overflow	There was too much position deviation between the motor and load during fully-closed loop control.	Gr.2	Yes
d30h	Position Data Overflow	The position feedback data exceeded $\pm 1,879,048,192$.	Gr.1	No
E00h	EtherCAT Module Interface Initialization Timeout Error	Communications initialization failed between the SERVOPACK and the EtherCAT Module.	Gr.2	Yes
E02h	EtherCAT Internal Synchronization Error 1	A synchronization error occurred during EtherCAT communications with the SERVOPACK.	Gr.1	Yes
E03h	EtherCAT Module Interface Communications Data Error	There is an error in the communications data between the SERVOPACK and the EtherCAT Module.	Gr.1	Yes
E71h	Safety Option Module Detection Failure	Detection of the Safety Option Module failed.	Gr.1	No

Continued on next page.

Continued from previous page.

Alarm Code	Alarm Name	Alarm Meaning	Servo-motor Stopping Method	Alarm Reset Possible?
E72h	Feedback Option Module Detection Failure	Detection of the Feedback Option Module failed.	Gr.1	No
E74h	Unsupported Safety Option Module Alarm	An unsupported Safety Option Module was connected.	Gr.1	No
E75h*2	Unsupported Feedback Option Module Alarm	An unsupported Feedback Option Module was connected.	Gr.1	No
EA0h	Command-Option IF Servo Unit Initial Error	Communications could not be initialized between the SERVOPACK and EtherCAT (CoE) Network Module within 10 seconds.	Gr.1	No
EA1h	Command-Option IF Memory Check Error	An error occurred in communications memory between the SERVOPACK and EtherCAT (CoE) Network Module.	Gr.1	No
EA2h	Command-Option IF Servo Synchronization Error*1	Communications could not be synchronized between the SERVOPACK and EtherCAT (CoE) Network Module.	Gr.1	Yes
EA3h	Command-Option IF Servo Data Error*1	An error occurred in communications data between the SERVOPACK and EtherCAT (CoE) Network Module.	Gr.1	Yes
Eb1h	Safety Function Signal Input Timing Error	An error occurred in the input timing of the safety function signal.	Gr.1	No
EC8h	Gate Drive Error 1	An error occurred in the gate drive circuit.	Gr.1	No
EC9h	Gate Drive Error 2	An error occurred in the gate drive circuit.	Gr.1	No
Ed1h	Command Execution Timeout	A timeout error occurred for a EtherCAT command.	Gr.2	Yes
F10h	Power Supply Line Open Phase	The voltage was low for more than one second for phase R, S, or T when the main power supply was ON.	Gr.2	Yes
F30h	Dynamic Brake Circuit Error	An error occurred in the dynamic brake circuit.	Gr.2	Yes
F32h	Dynamic Brake Operation Request Output Signal Setting Error	An error occurred in the settings related to the Dynamic Brake Operation Request Output signal.	Gr.1	No
FL-1*3	System Alarm	An internal program error occurred in the SERVOPACK.	-	No
FL-2*3				
FL-3*3				
FL-4*3				
FL-5*3				
FL-6*3				
CPF00	Digital Operator Communications Error 1	Communications were not possible between the Digital Operator (model: JUSP-OP05A-1-E) and the SERVOPACK (e.g., a CPU error occurred).	-	No
CPF01	Digital Operator Communications Error 2			

*1. The EtherCAT communications state moved to SAFEOP after an alarm was detected.

*2. This alarm can occur when a Fully-closed Option Module is mounted.

*3. These alarms are not stored in the alarm history. They are only displayed on the panel display.

Note: The Eb0h, Eb2h to Eb9h, and EC0h to EC2h alarms can occur when a Safety Module is connected. Refer to the following manual for details.

 AC Servo Drive Σ -V-Series/ Σ -V-Series for Large-Capacity Models/ Σ -7-Series User's Manual Safety Module (Manual No.: SIEP C720829 06)

16.2.2 Troubleshooting Alarms

The causes of and corrections for the alarms are given in the following table. Contact your Yaskawa representative if you cannot solve a problem with the correction given in the table.

Alarm Code: Alarm Name	Possible Cause	Confirmation	Correction	Reference
020h: Parameter Checksum Error (There is an error in the parameter data in the SER- VOPACK.)	The power supply voltage suddenly dropped.	Measure the power supply voltage.	Set the power supply voltage within the specified range, and initialize the parameter settings.	page 6-10
	The power supply was shut OFF while writing parameter settings.	Check the timing of shutting OFF the power supply.	Initialize the parameter settings and then set the parameters again.	
	The number of times that parameters were written exceeded the limit.	Check to see if the parameters were frequently changed from the host controller.	The SERVOPACK may be faulty. Replace the SERVOPACK. Reconsider the method for writing the parameters.	-
	A malfunction was caused by noise from the AC power supply, ground, static electricity, or other source.	Turn the power supply to the SERVOPACK OFF and ON again. If the alarm still occurs, noise may be the cause.	Implement countermeasures against noise.	page 4-5
	Gas, water drops, or cutting oil entered the SERVOPACK and caused failure of the internal components.	Check the installation conditions.	The SERVOPACK may be faulty. Replace the SERVOPACK.	-
	A failure occurred in the SERVOPACK.	Turn the power supply to the SERVOPACK OFF and ON again. If the alarm still occurs, the SERVOPACK may have failed.	The SERVOPACK may be faulty. Replace the SERVOPACK.	-
021h: Parameter Format Error (There is an error in the parameter data format in the SERVOPACK.)	The software version of the SERVOPACK that caused the alarm is older than the software version of the parameters specified to write.	Read the product information to see if the software versions are the same. If they are different, it could be the cause of the alarm.	Write the parameters from another SERVOPACK with the same model and the same software version, and then turn the power OFF and ON again.	page 10-2
	A failure occurred in the SERVOPACK.	-	The SERVOPACK may be faulty. Replace the SERVOPACK.	-
022h: System Checksum Error (There is an error in the parameter data in the SERVOPACK.)	The power supply voltage suddenly dropped.	Measure the power supply voltage.	The SERVOPACK may be faulty. Replace the SERVOPACK.	-
	The power supply was shut OFF while setting a utility function.	Check the timing of shutting OFF the power supply.	The SERVOPACK may be faulty. Replace the SERVOPACK.	-
	A failure occurred in the SERVOPACK.	Turn the power supply to the SERVOPACK OFF and ON again. If the alarm still occurs, the SERVOPACK may have failed.	The SERVOPACK may be faulty. Replace the SERVOPACK.	-

Continued on next page.

Continued from previous page.

Alarm Code: Alarm Name	Possible Cause	Confirmation	Correction	Reference
024h: System Alarm (An internal program error occurred in the SERVOPACK.)	A failure occurred in the SERVOPACK.	–	The SERVOPACK may be faulty. Replace the SERVOPACK.	–
025h: System Alarm (An internal program error occurred in the SERVOPACK.)	A failure occurred in the SERVOPACK.	–	The SERVOPACK may be faulty. Replace the SERVOPACK.	–
030h: Main Circuit Detector Error	A failure occurred in the SERVOPACK.	–	The SERVOPACK may be faulty. Replace the SERVOPACK.	–
040h: Parameter Setting Error (A parameter setting is outside of the setting range.)	The SERVOPACK and Servomotor capacities do not match each other.	Check the combination of the SERVOPACK and Servomotor capacities.	Select a proper combination of SERVOPACK and Servomotor capacities.	page 1-12
	A failure occurred in the SERVOPACK.	–	The SERVOPACK may be faulty. Replace the SERVOPACK.	–
	A parameter setting is outside of the setting range.	Check the setting ranges of the parameters that have been changed.	Set the parameters to values within the setting ranges.	–
041h: Encoder Output Pulse Setting Error	The setting of Pn212 (2212h) (Encoder Output Pulses) or Pn281 (2281h) (Encoder Output Resolution) is outside of the setting range or does not satisfy the setting conditions.	Check the setting of Pn212 (2212h) or Pn281 (2281h).	Set Pn212 (2212h) or Pn281 (2281h) to an appropriate value.	page 7-23
042h: Parameter Combination Error	The speed of program jogging went below the setting range when Pn533 (2533h) or Pn585 (2585h) (Program Jogging Speed) was changed.	Check to see if the detection conditions* ¹ are satisfied.	Increase the setting of Pn533 (2533h) or Pn585 (2585h).	page 8-13
	The combination of Pn001 = n.□□□X (Motor Stopping Method for Servo OFF and Group 1 Alarms), Pn601 (Dynamic Brake Resistor Allowable Energy Consumption), and Pn604 (Dynamic Brake Resistance) is wrong, or the settings of those parameters are wrong.	Check Pn001 = n.□□□X, Pn601, and Pn604.	<ul style="list-style-type: none"> ■ When Not Using an External Dynamic Brake <ul style="list-style-type: none"> • Set Pn001 = n.□□□X to 2 (Coast the motor to a stop without the dynamic brake). • Set Pn601 and Pn604 to 0. ■ When Using an External Dynamic Brake <ul style="list-style-type: none"> • Set Pn001 = n.□□□X to 0 (Stop the motor by applying the dynamic brake) or 1 (Stop the motor by applying the dynamic brake and then release the dynamic brake). • Set Pn601 and Pn604 according to the specifications of the resistor. 	page 5-9

Continued on next page.

Continued from previous page.

Alarm Code: Alarm Name	Possible Cause	Confirmation	Correction	Reference
044h: Semi-Closed/ Fully-Closed Loop Control Parameter Setting Error	The setting of the Fully-closed Module does not match the setting of Pn002 (2002h) = n.X□□□ (External Encoder Usage).	Check the setting of Pn002 (2002h) = n.X□□□.	Make sure that the setting of the Fully-closed Module agrees with the setting of Pn002 (2002h) = n.X□□□.	page 11-6
050h: Combination Error (The capacities of the SERVOPACK and Servomotor do not match.)	The SERVOPACK and Servomotor capacities do not match each other.	Confirm that the following condition is met: $1/4 \leq (\text{Servomotor capacity}/\text{SERVOPACK capacity}) \leq 4$	Select a proper combination of the SERVOPACK and Servomotor capacities.	page 1-12
	A failure occurred in the encoder.	Replace the encoder and check to see if the alarm still occurs.	Replace the Servomotor or encoder.	–
	A failure occurred in the SERVOPACK.	–	The SERVOPACK may be faulty. Replace the SERVOPACK.	–
051h: Unsupported Device Alarm	The motor parameter file was not written to the linear encoder. (This applies only when not using a Serial Converter Unit.)	Check to see if the motor parameter file was written to the linear encoder.	Write the motor parameter file to the linear encoder.	page 6-16
	An unsupported Serial Converter Unit or encoder (e.g., an external encoder) is connected to the SERVOPACK.	Check the product combination specifications.	Change to a correct combination of models.	–
070h: Motor Type Change Detected (The connected motor is a different type of motor from the previously connected motor.)	A Rotary Servomotor was removed and a Linear Servomotor was connected.	–	Set the parameters for a Linear Servomotor and reset the motor type alarm. Then, turn the power supply to the SERVOPACK OFF and ON again.	page 16-46
	A Linear Servomotor was removed and a Rotary Servomotor was connected.	–	Set the parameters for a Rotary Servomotor and reset the motor type alarm. Then, turn the power supply to the SERVOPACK OFF and ON again.	page 16-46
080h: Linear Encoder Pitch Setting Error	The setting of Pn282 (2282h) (Linear Encoder Pitch) has not been changed from the default setting.	Check the setting of Pn282 (2282h).	Correct the setting of Pn282 (2282h).	page 6-15
0b0h: Invalid Servo ON Command Alarm	The Servo ON command (Enable Operation command) was sent from the host controller after a utility function that turns ON the Servomotor was executed.	–	Turn the power supply to the SERVOPACK OFF and ON again. Or, execute a software reset.	page 7-44

Continued on next page.

Continued from previous page.

Alarm Code: Alarm Name	Possible Cause	Confirmation	Correction	Reference
100h: Overcurrent Detected (An overcurrent flowed through the power trans- former or the heat sink overheated.)	The Main Circuit Cable is not wired correctly or there is faulty contact.	Check the wiring.	Correct the wiring.	page 4-19
	There is a short-circuit or ground fault in a Main Circuit Cable.	Check for short-circuits across Servomotor phases U, V, and W, or between the ground and Servomotor phases U, V, and W.	The cable may be short-circuited. Replace the cable.	
	There is a short-circuit or ground fault inside the Servomotor.	Check for short-circuits across Servomotor phases U, V, and W, or between the ground and Servomotor phases U, V, or W.	The Servomotor may be faulty. Replace the Servomotor.	
	There is a short-circuit or ground fault inside the SERVOPACK.	Check for short-circuits across the Servomotor connection terminals U, V, and W on the SERVOPACK, or between the ground and terminals U, V, or W.	The SERVOPACK may be faulty. Replace the SERVOPACK.	
	The Regenerative Resistor is not wired correctly or there is faulty contact.	Check the wiring.	Correct the wiring.	page 4-18
	The dynamic brake (DB, emergency stop executed from the SERVOPACK) was frequently activated, or a DB overload alarm occurred.	Check the power consumed by the DB resistor to see how frequently the DB is being used. Or, check the alarm display to see if a DB overload alarm (A.730 or A.731) has occurred.	Change the SERVOPACK model, operating methods, or the mechanisms so that the dynamic brake does not need to be used so frequently.	-
	The regenerative processing capacity was exceeded.	Check the regenerative load ratio in the SigmaWin+ Motion Monitor Tab Page to see how frequently the Regenerative Resistor is being used.	Recheck the operating conditions and load.	*2
	The SERVOPACK regenerative resistance is too small.	Check the regenerative load ratio in the SigmaWin+ Motion Monitor Tab Page to see how frequently the Regenerative Resistor is being used.	Change the regenerative resistance to a value larger than the SERVOPACK minimum allowable resistance.	-
A heavy load was applied while the Servomotor was stopped or running at a low speed.	Check to see if the operating conditions exceed Servo Drive specifications.	Reduce the load applied to the Servomotor. Or, increase the operating speed.	-	

Continued on next page.

Continued from previous page.

Alarm Code: Alarm Name	Possible Cause	Confirmation	Correction	Reference
100h: Overcurrent Detected (An overcurrent flowed through the power trans- former or the heat sink overheated.)	A malfunction was caused by noise.	Improve the noise envi- ronment, e.g. by improving the wiring or installation conditions, and check to see if the alarm still occurs.	Implement countermea- sures against noise, such as correct wiring of the FG. Use an FG wire size equivalent to the SERVO- PACK's main circuit wire size.	-
	A failure occurred in the SERVOPACK.	-	Turn the power supply to the SERVOPACK OFF and ON again. If an alarm still occurs, the SERVOPACK may be faulty. Replace the SERVOPACK.	-
101h: Motor Overcur- rent Detected (The current to the motor exceeded the allowable cur- rent.)	The Main Circuit Cable is not wired correctly or there is faulty contact.	Check the wiring.	Correct the wiring.	page 4-19
	There is a short-circuit or ground fault in a Main Circuit Cable.	Check for short-circuits across cable phases U, V, and W, or between the ground and cable phases U, V, and W.	The cable may be short- circuited. Replace the cable.	
	There is a short-circuit or ground fault inside the Servomotor.	Check for short-circuits across Servomotor phases U, V, and W, or between the ground and Servomotor phases U, V, or W.	The Servomotor may be faulty. Replace the Servo- motor.	
	There is a short-circuit or ground fault inside the SERVOPACK.	Check for short-circuits across the Servomotor connection terminals U, V, and W on the SER- VOPACK, or between the ground and termi- nals U, V, or W.	The SERVOPACK may be faulty. Replace the SER- VOPACK.	
	A heavy load was applied while the Ser- vomotor was stopped or running at a low speed.	Check to see if the operating conditions exceed Servo Drive specifications.	Reduce the load applied to the Servomotor. Or, increase the operating speed.	-
	A malfunction was caused by noise.	Improve the noise envi- ronment, e.g. by improving the wiring or installation conditions, and check to see if the alarm still occurs.	Implement countermea- sures against noise, such as correct wiring of the FG. Use an FG wire size equivalent to the SERVO- PACK's main circuit wire size.	-
	A failure occurred in the SERVOPACK.	-	Turn the power supply to the SERVOPACK OFF and ON again. If an alarm still occurs, the SERVOPACK may be faulty. Replace the SERVOPACK.	-
231h: Built-in Brake Relay Answer Error	A malfunction was caused by noise.	Turn the power supply to the SERVOPACK OFF and ON again. If the alarm still occurs, noise may be the cause.	Implement countermea- sures against noise.	-
	The built-in brake relay failed.	-	Replace the part. Con- tact your Yaskawa repre- sentative for replacement.	-

Continued on next page.

Continued from previous page.

Alarm Code: Alarm Name	Possible Cause	Confirmation	Correction	Reference
232h: Built-in Brake Relay Life Alarm	The service life of the built-in brake relay was exceeded.	–	Replace the part. Contact your Yaskawa representative for replacement.	–
300h: Regeneration Error	The jumper between the Regenerative Resistor terminals (B2 and B3) was removed from an SGD7S-1R9D, -3R5D, -5R4D, -8R4D, -120D, or -170D SERVOPACK.	Check to see if the jumper is connected between power supply terminals B2 and B3. Note: The SERVOPACK will be damaged if the External Regenerative Resistor is connected while the jumper connected between B2 and B3.	Correctly connect a jumper.	page 4-18
	The External Regenerative Resistor is not wired correctly, or was removed or disconnected.	Check the wiring of the External Regenerative Resistor. Note: The SERVOPACK will be damaged if the External Regenerative Resistor is connected while the jumper connected between B2 and B3.	Correct the wiring of the External Regenerative Resistor.	
	A failure occurred in the SERVOPACK.	–	While the main circuit power supply is OFF, turn the control power supply to the SERVOPACK OFF and ON again. If an alarm still occurs, the SERVOPACK may be faulty. Replace the SERVOPACK.	–

Continued on next page.

Continued from previous page.

Alarm Code: Alarm Name	Possible Cause	Confirmation	Correction	Reference
320h: Regenerative Overload	The power supply voltage exceeded the specified range.	Measure the power supply voltage.	Set the power supply voltage within the specified range.	–
	The external regenerative resistance value or Regenerative Resistor capacity is too small, or there has been a continuous regeneration state.	Check the operating conditions or the capacity.	Change the regenerative resistance value or capacity. Reconsider the operating conditions.	*2
	There was a continuous regeneration state because a negative load was continuously applied.	Check the load applied to the Servomotor during operation.	Reconsider the system including the servo, machine, and operating conditions.	–
	The setting of Pn600 (2600h) (Regenerative Resistor Capacity) is smaller than the capacity of the External Regenerative Resistor.	Check to see if a Regenerative Resistor is connected and check the setting of Pn600 (2600h).	Correct the setting of Pn600 (2600h).	page 6-55
	The setting of Pn603 (2603h) (Regenerative Resistance) is smaller than the capacity of the External Regenerative Resistor.	Check to see if a Regenerative Resistor is connected and check the setting of Pn603 (2603h).	Correct the setting of Pn603 (2603h).	page 6-55
	The external regenerative resistance is too high.	Check the regenerative resistance.	Change the regenerative resistance to a correct value or use an External Regenerative Resistor of an appropriate capacity.	*2
	A failure occurred in the SERVOPACK.	–	The SERVOPACK may be faulty. Replace the SERVOPACK.	–
330h: Main Circuit Power Supply Wiring Error (Detected when the main circuit power supply is turned ON.)	The Regenerative Resistor was disconnected when the SERVOPACK power supply voltage was high.	Measure the resistance of the Regenerative Resistor using a measuring instrument.	If you are using the Regenerative Resistor built into the SERVOPACK, replace the SERVOPACK. If you are using an External Regenerative Resistor, replace the External Regenerative Resistor.	–
	DC power was supplied when an AC power supply input was specified in the settings.	Check the power supply to see if it is a DC power supply.	Correct the power supply setting to match the actual power supply.	page 6-12
	AC power was supplied when a DC power supply input was specified in the settings.	Check the power supply to see if it is an AC power supply.	Correct the power supply setting to match the actual power supply.	
	A failure occurred in the SERVOPACK.	–	The SERVOPACK may be faulty. Replace the SERVOPACK.	–

Continued on next page.

Continued from previous page.

Alarm Code: Alarm Name	Possible Cause	Confirmation	Correction	Reference
400h: Overvoltage (Detected in the main circuit power supply section of the SERVOPACK.)	The power supply voltage exceeded the specified range.	Measure the power supply voltage.	Set the AC/DC power supply voltage within the specified range.	–
	The power supply is not stable or was influenced by a lightning surge.	Measure the power supply voltage.	Improve the power supply conditions, install a Surge Absorber, and then turn the power supply OFF and ON again. If an alarm still occurs, the SERVOPACK may be faulty. Replace the SERVOPACK.	–
	The voltage for AC power supply was too high during acceleration or deceleration.	Check the power supply voltage and the speed and torque during operation.	Set the AC power supply voltage within the specified range.	–
	The external regenerative resistance is too high for the operating conditions.	Check the operating conditions and the regenerative resistance.	Select a regenerative resistance value that is appropriate for the operating conditions and load.	*2
	The moment of inertia ratio or mass ratio exceeded the allowable value.	Check to see if the moment of inertia ratio or mass ratio is within the allowable range.	Increase the deceleration time, or reduce the load.	–
	A failure occurred in the SERVOPACK.	–	While the main circuit power supply is OFF, turn the control power supply to the SERVOPACK OFF and ON again. If an alarm still occurs, the SERVOPACK may be faulty. Replace the SERVOPACK.	–
410h: Undervoltage (Detected in the main circuit power supply section of the SERVOPACK.)	The power supply voltage went below the specified range.	Measure the power supply voltage.	Set the power supply voltage within the specified range.	–
	The power supply voltage dropped during operation.	Measure the power supply voltage.	Increase the power supply capacity.	–
	A momentary power interruption occurred.	Measure the power supply voltage.	If you have changed the setting of Pn509 (2509h) (Momentary Power Interruption Hold Time), decrease the setting.	page 7-14
	The SERVOPACK fuse is blown out.	–	Replace the SERVOPACK and connect a reactor to the DC Reactor terminals (⊖1 and ⊖2) on the SERVOPACK.	–
	A failure occurred in the SERVOPACK.	–	The SERVOPACK may be faulty. Replace the SERVOPACK.	–
450h: Main-Circuit Capacitor Overvoltage (The capacitor in the main circuit has deteriorated or is faulty.)	A failure occurred in the SERVOPACK.	–	Replace the SERVOPACK.	–

Continued on next page.

Continued from previous page.

Alarm Code: Alarm Name	Possible Cause	Confirmation	Correction	Reference
510h: Overspeed (The motor exceeded the maximum speed.)	The order of phases U, V, and W in the motor wiring is not correct.	Check the wiring of the Servomotor.	Make sure that the Servomotor is correctly wired.	–
	A reference value that exceeded the over-speed detection level was input.	Check the input reference.	Reduce the reference value. Or, adjust the gain.	–
	The motor exceeded the maximum speed.	Check the waveform of the motor speed.	Reduce the speed reference input gain and adjust the servo gain. Or, reconsider the operating conditions.	–
	A failure occurred in the SERVOPACK.	–	The SERVOPACK may be faulty. Replace the SERVOPACK.	–
511h: Encoder Output Pulse Overspeed	The encoder output pulse frequency exceeded the limit.	Check the encoder output pulse setting.	Decrease the setting of Pn212 (2212h) (Encoder Output Pulses) or Pn281 (2281h) (Encoder Output Resolution).	page 7-23
	The encoder output pulse frequency exceeded the limit because the motor speed was too high.	Check the encoder output pulse setting and the motor speed.	Reduce the motor speed.	–
520h: Vibration Alarm	Abnormal oscillation was detected in the motor speed.	Check for abnormal motor noise, and check the speed and torque waveforms during operation.	Reduce the motor speed. Or, reduce the setting of Pn100 (2100h) (Speed Loop Gain).	page 9-77
	The setting of Pn103 (2103h) (Moment of Inertia Ratio) is greater than the actual moment of inertia or was greatly changed.	Check the moment of inertia ratio or mass ratio.	Correct the setting of Pn103 (2103h).	page 9-16
	The vibration detection level (Pn312 or Pn384) is not suitable.	Check that the vibration detection level (Pn312 or Pn384) is suitable.	Set a suitable vibration detection level (Pn312 or Pn384).	page 7-46
521h: Autotuning Alarm (Vibration was detected while executing the custom tuning, Easy FFT, or the tuning-less function.)	The Servomotor vibrated considerably while performing the tuning-less function.	Check the waveform of the motor speed.	Reduce the load so that the moment of inertia ratio is within the allowable value. Or increase the load level or reduce the rigidity level in the tuning-less level settings.	page 9-13
	The Servomotor vibrated considerably while performing custom tuning or Easy FFT.	Check the waveform of the motor speed.	Check the operating procedure of corresponding function and implement corrections.	page 9-41, page 9-93
550h: Maximum Speed Setting Error	The setting of Pn385 (2385h) (Maximum Motor Speed) is greater than the maximum speed.	Check the setting of Pn385 (2385h), and the upper limits of the maximum motor speed setting and the encoder output resolution setting.	Set Pn385 (2385h) to a value that does not exceed the maximum motor speed.	page 7-17

Continued on next page.

Continued from previous page.

Alarm Code: Alarm Name	Possible Cause	Confirmation	Correction	Reference
710h: Instantaneous Overload 720h: Continuous Overload	The wiring is not correct or there is a faulty contact in the motor or encoder wiring.	Check the wiring.	Make sure that the Servomotor and encoder are correctly wired.	page 4-19
	Operation was performed that exceeded the overload protection characteristics.	Check the motor overload characteristics and Run command.	Reconsider the load and operating conditions. Or, increase the motor capacity.	–
	An excessive load was applied during operation because the Servomotor was not driven due to mechanical problems.	Check the operation reference and motor speed.	Correct the mechanical problem.	–
	There is an error in the setting of Pn282 (2282h) (Linear Encoder Pitch).	Check the setting of Pn282 (2282h).	Correct the setting of Pn282 (2282h).	page 6-15
	There is an error in the setting of Pn080 (2080h) = n.□□X□ (Motor Phase Selection).	Check the setting of Pn080 (2080h) = n.□□X□.	Set Pn080 (2080h) = n.□□X□ to an appropriate value.	page 6-20
	A failure occurred in the SERVOPACK.	–	The SERVOPACK may be faulty. Replace the SERVOPACK.	–
730h and 731h: Dynamic Brake Overload (An excessive power consumption by the dynamic brake was detected.)	The Servomotor was rotated by an external force.	Check the operation status.	Implement measures to ensure that the motor will not be rotated by an external force.	–
	When the Servomotor was stopped with the dynamic brake, the rotational or linear kinetic energy exceeded the capacity of the Dynamic Brake Resistor.	Check the power consumed by the DB resistor to see how frequently the DB is being used.	Reconsider the following: <ul style="list-style-type: none"> • Reduce the Servomotor command speed. • Decrease the moment of inertia ratio or mass ratio. • Reduce the frequency of stopping with the dynamic brake. 	–
	A failure occurred in the SERVOPACK.	–	The SERVOPACK may be faulty. Replace the SERVOPACK.	–
740h: Inrush Current Limiting Resistor Overload (The main circuit power supply was frequently turned ON and OFF.)	The allowable frequency of the inrush current limiting resistor was exceeded when the main circuit power supply was turned ON and OFF.	–	Reduce the frequency of turning the main circuit power supply ON and OFF.	–
	A failure occurred in the SERVOPACK.	–	The SERVOPACK may be faulty. Replace the SERVOPACK.	–

Continued on next page.

Continued from previous page.

Alarm Code: Alarm Name	Possible Cause	Confirmation	Correction	Reference
7A1h: Internal Temperature Error 1 (Control Board Temperature Error)	The surrounding temperature is too high.	Check the surrounding temperature using a thermostat. Or, check the operating status with the SERVOPACK installation environment monitor.	Decrease the surrounding temperature by improving the SERVOPACK installation conditions.	page 3-6
	An overload alarm was reset by turning OFF the power supply too many times.	Check the alarm display to see if there is an overload alarm.	Change the method for resetting the alarm.	–
	There was an excessive load or operation was performed that exceeded the regenerative processing capacity.	Use the accumulated load ratio to check the load during operation, and use the regenerative load ratio to check the regenerative processing capacity.	Reconsider the load and operating conditions.	–
	The SERVOPACK installation orientation is not correct or there is insufficient space around the SERVOPACK.	Check the SERVOPACK installation conditions.	Install the SERVOPACK according to specifications.	page 3-3, page 3-5
	A failure occurred in the SERVOPACK.	–	The SERVOPACK may be faulty. Replace the SERVOPACK.	–
7A2h: Internal Temperature Error 2 (Power Board Temperature Error)	The surrounding temperature is too high.	Check the surrounding temperature using a thermostat. Or, check the operating status with the SERVOPACK installation environment monitor.	Decrease the surrounding temperature by improving the SERVOPACK installation conditions.	page 3-6
	An overload alarm was reset by turning OFF the power supply too many times.	Check the alarm display to see if there is an overload alarm.	Change the method for resetting the alarm.	–
	There was an excessive load or operation was performed that exceeded the regenerative processing capacity.	Use the accumulated load ratio to check the load during operation, and use the regenerative load ratio to check the regenerative processing capacity.	Reconsider the load and operating conditions.	–
	The SERVOPACK installation orientation is not correct or there is insufficient space around the SERVOPACK.	Check the SERVOPACK installation conditions.	Install the SERVOPACK according to specifications.	page 3-3, page 3-5
	A failure occurred in the SERVOPACK.	–	The SERVOPACK may be faulty. Replace the SERVOPACK.	–
7A3h: Internal Temperature Sensor Error (An error occurred in the temperature sensor circuit.)	A failure occurred in the SERVOPACK.	–	The SERVOPACK may be faulty. Replace the SERVOPACK.	–

Continued on next page.

Continued from previous page.

Alarm Code: Alarm Name	Possible Cause	Confirmation	Correction	Reference
7A4h: Power Transistor Overheated (Abnormal power transistor temperature.)	The surrounding temperature is too high.	Check the surrounding temperature using a thermostat. Or, check the operating status with the SERVOPACK installation environment monitor.	Decrease the surrounding temperature by improving the SERVOPACK installation conditions.	page 3-6
	An overload alarm was reset by turning OFF the power supply too many times.	Check the alarm display to see if there is an overload alarm.	Change the method for resetting the alarm.	–
	There was an excessive load or operation was performed that exceeded the regenerative processing capacity.	Use the accumulated load ratio to check the load during operation, and use the regenerative load ratio to check the regenerative processing capacity.	Reconsider the load and operating conditions.	–
	The SERVOPACK installation orientation is not correct or there is insufficient space around the SERVOPACK.	Check the SERVOPACK installation conditions.	Install the SERVOPACK according to specifications.	page 3-3, page 3-5
	A failure occurred in the SERVOPACK.	–	The SERVOPACK may be faulty. Replace the SERVOPACK.	–
7Abh: SERVOPACK Built-in Fan Stopped	The fan inside the SERVOPACK stopped.	Check for foreign matter inside the SERVOPACK.	Remove foreign matter from the SERVOPACK. If an alarm still occurs, the SERVOPACK may be faulty. Replace the SERVOPACK.	–
810h: Encoder Backup Alarm (Detected at the encoder, but only when an absolute encoder is used.)	The power to the absolute encoder was turned ON for the first time.	Check to see if the power supply was turned ON for the first time.	Set up the encoder.	page 6-49
	The Encoder Cable was disconnected and then connected again.	Check to see if the power supply was turned ON for the first time.	Check the encoder connection and set up the encoder.	
	Power is not being supplied both from the control power supply (+5 V) from the SERVOPACK and from the battery power supply.	Check the encoder connector battery and the connector status.	Replace the battery or implement similar measures to supply power to the encoder, and set up the encoder.	–
	A failure occurred in the absolute encoder.	–	If the alarm still occurs after setting up the encoder again, replace the Servomotor.	–
	A failure occurred in the SERVOPACK.	–	The SERVOPACK may be faulty. Replace the SERVOPACK.	–

Continued on next page.

Continued from previous page.

Alarm Code: Alarm Name	Possible Cause	Confirmation	Correction	Reference
820h: Encoder Checksum Alarm (Detected at the encoder.)	A failure occurred in the encoder.	—	<ul style="list-style-type: none"> ■ When Using an Absolute Encoder Set up the encoder again. If the alarm still occurs, the Servomotor may be faulty. Replace the Servomotor. ■ When Using a Single-turn Absolute Encoder or Incremental Encoder <ul style="list-style-type: none"> • The Servomotor may be faulty. Replace the Servomotor. • The linear encoder may be faulty. Replace the linear encoder. 	page 6-49
	A failure occurred in the SERVOPACK.	—	The SERVOPACK may be faulty. Replace the SERVOPACK.	—
830h: Encoder Battery Alarm (The absolute encoder battery voltage was lower than the specified level.)	The battery connection is faulty or a battery is not connected.	Check the battery connection.	Correct the battery connection.	page 4-20
	The battery voltage is lower than the specified value (2.7 V).	Measure the battery voltage.	Replace the battery.	page 16-3
	A failure occurred in the SERVOPACK.	—	The SERVOPACK may be faulty. Replace the SERVOPACK.	—
840h: Encoder Data Alarm (Detected at the encoder.)	The encoder malfunctioned.	—	Turn the power supply to the SERVOPACK OFF and ON again. If an alarm still occurs, the Servomotor or linear encoder may be faulty. Replace the Servomotor or linear encoder.	—
	An error occurred in reading data from the linear encoder.	—	The linear encoder is not mounted within an appropriate tolerance. Correct the mounting of the linear encoder.	—
	Excessive speed occurred in the linear encoder.	—	Control the motor speed within the range specified by the linear encoder manufacturer and then turn ON the control power supply.	—
	The encoder malfunctioned due to noise.	—	Correct the wiring around the encoder by separating the Encoder Cable from the Servomotor Main Circuit Cable or by grounding the encoder.	—
	The polarity sensor is not wired correctly.	Check the wiring of the polarity sensor.	Correct the wiring of the polarity sensor.	—
	The polarity sensor failed.	—	Replace the polarity sensor.	—

Continued on next page.

Continued from previous page.

Alarm Code: Alarm Name	Possible Cause	Confirmation	Correction	Reference
850h: Encoder Over-speed (Detected at the encoder when the control power supply is turned ON.)	Rotary Servomotor: The Servomotor speed was 200 min ⁻¹ or higher when the control power supply was turned ON.	Check the motor speed when the power supply is turned ON.	Reduce the Servomotor speed to a value less than 200 min ⁻¹ , and turn ON the control power supply.	-
	Linear Servomotor: The Servomotor exceeded the specified speed when the control power supply was turned ON.	Check the motor speed when the power supply is turned ON.	Control the motor speed within the range specified by the linear encoder manufacturer and then turn ON the control power supply.	-
	A failure occurred in the encoder.	-	Turn the power supply to the SERVOPACK OFF and ON again. If an alarm still occurs, the Servomotor or linear encoder may be faulty. Replace the Servomotor or linear encoder.	-
	A failure occurred in the SERVOPACK.	-	Turn the power supply to the SERVOPACK OFF and ON again. If an alarm still occurs, the SERVOPACK may be faulty. Replace the SERVOPACK.	-
860h: Encoder Over-heated (Detected at the encoder, but only when an absolute encoder is used.)	The surrounding air temperature around the Servomotor is too high.	Measure the surrounding air temperature around the Servomotor.	Reduce the surrounding air temperature of the Servomotor to 40°C or less.	-
	The Servomotor load is greater than the rated load.	Use the accumulated load ratio to check the load.	Operate the Servo Drive so that the motor load remains within the specified range.	page 10-3
	A failure occurred in the encoder.	-	Turn the power supply to the SERVOPACK OFF and ON again. If an alarm still occurs, the Servomotor or absolute linear encoder may be faulty. Replace the Servomotor or absolute linear encoder.	-
	A failure occurred in the SERVOPACK.	-	Turn the power supply to the SERVOPACK OFF and ON again. If an alarm still occurs, the SERVOPACK may be faulty. Replace the SERVOPACK.	-

Continued on next page.

Continued from previous page.

Alarm Code: Alarm Name	Possible Cause	Confirmation	Correction	Reference
861h: Motor Overheated	The surrounding temperature around the Servomotor is too high.	Measure the surrounding temperature around the Servomotor.	Reduce the surrounding air temperature of the Servomotor to 40°C or less.	-
	The motor load is greater than the rated load.	Check the load with the accumulated load ratio on the Motion Monitor Tab Page on the SigmaWin+.	Operate the Servo Drive so that the motor load remains within the specified range.	page 10-3
	A failure occurred in the Serial Converter Unit.	-	Turn the power supply to the SERVOPACK OFF and ON again. If an alarm still occurs, the Serial Converter Unit may be faulty. Replace the Serial Converter Unit.	-
	A failure occurred in the SERVOPACK.	-	Turn the power supply to the SERVOPACK OFF and ON again. If an alarm still occurs, the SERVOPACK may be faulty. Replace the SERVOPACK.	-
862h: Overheat Alarm	The surrounding temperature is too high.	Check the surrounding temperature using a thermostat.	Lower the surrounding temperature by improving the installation conditions of the Linear Servomotor or the machine.	-
	The overheat protection input signal line is disconnected or short-circuited.	Check the input voltage with the overheat protection input information on the Motion Monitor Tab Page on the SigmaWin+.	Repair the line for the overheat protection input signal.	-
	An overload alarm was reset by turning OFF the power supply too many times.	Check the alarm display to see if there is an overload alarm.	Change the method for resetting the alarm.	-
	Operation was performed under an excessive load.	Use the accumulated load ratio to check the load during operation.	Reconsider the load and operating conditions.	-
	A failure occurred in the SERVOPACK.	-	The SERVOPACK may be faulty. Replace the SERVOPACK.	-
	The temperature detection circuit in the Linear Servomotor is faulty or the sensor attached to the machine is faulty.	-	The temperature detection circuit in the Linear Servomotor may be faulty or the sensor attached to the machine may be faulty. Replace the Linear Servomotor or repair the sensor attached to the machine.	-
890h: Encoder Scale Error	A failure occurred in the linear encoder.	-	The linear encoder may be faulty. Replace the linear encoder.	-
891h: Encoder Module Error	A failure occurred in the linear encoder.	-	Turn the power supply to the SERVOPACK OFF and ON again. If an alarm still occurs, the linear encoder may be faulty. Replace the linear encoder.	-

Continued on next page.

Continued from previous page.

Alarm Code: Alarm Name	Possible Cause	Confirmation	Correction	Reference
8A0h: External Encoder Error	Setting the origin of the absolute linear encoder failed because the motor moved.	Before you set the origin, use the fully-closed feedback pulse counter to confirm that the motor is not moving.	The motor must be stopped while setting the origin position.	page 6-52
	A failure occurred in the external encoder.	–	Replace the external encoder.	–
8A1h: External Encoder Module Error	A failure occurred in the external encoder.	–	Replace the external encoder.	–
	A failure occurred in the Serial Converter Unit.	–	Replace the Serial Converter Unit.	–
8A2h: External Incremental Encoder Sensor Error	A failure occurred in the external encoder.	–	Replace the external encoder.	–
8A3h: External Absolute Encoder Position Error	A failure occurred in the external absolute encoder.	–	The external absolute encoder may be faulty. Refer to the encoder manufacturer’s instruction manual for corrections.	–
8A5h: External Encoder Overspeed	An overspeed error was detected in the external encoder.	Check the maximum speed of the external encoder.	Keep the external encoder below its maximum speed.	–
8A6h: External Encoder Overheated	An overheating error was detected in the external encoder.	–	Replace the external encoder.	–
A10h: EtherCAT DC Synchronization Error	The synchronization timing (Sync0) for EtherCAT communications fluctuated.	–	Turn the power supply OFF and ON again and re-establish communications.	–
A11h: EtherCAT State Error	The EtherCAT communications state left the Operational state during motor operation.	–	Reset the alarm and then re-establish communications.	–
A12h: EtherCAT Output Data Synchronization Error	Noise caused an error in EtherCAT communications.	–	Check the EtherCAT wiring and implement noise countermeasures.	–
	The controller did not update the process data during the fixed period.	Check the process data specified by the controller.	Correct the controller so that the process data is updated during the fixed period.	–
	The EtherCAT Communications Cable or connector wiring is faulty.	Check the EtherCAT Communications Cable and connector wiring.	Wire the connections correctly.	–

Continued on next page.

Continued from previous page.

Alarm Code: Alarm Name	Possible Cause	Confirmation	Correction	Reference
A20h: Parameter Setting Error	The position unit is outside of the setting range.	Make sure it is within the following range. $1/4,096 < \text{Numerator (2701h: 1)/Denominator (2701h: 2)} < 65,536$	Correct the setting of <i>position user unit (2701h)</i> .	–
	The speed unit is outside of the setting range.	Make sure it is within the following range. $1/128 \leq \text{Numerator (2702h: 1)/Denominator (2702h: 2)} \leq 8,388,608$	Correct the setting of <i>velocity user unit (2702h)</i> .	–
	The acceleration unit is outside of the setting range.	Make sure it is within the following range. $1/128 \leq \text{Numerator (2703h: 1)/Denominator (2703h: 2)} \leq 262,144$	Correct the setting of <i>acceleration user unit (2703h)</i> .	–
A40h: System Initialization Error	A failure occurred in the SERVOPACK.	–	Replace the SERVOPACK.	–
A41h: Communications Device Initialization Error	A failure occurred in the SERVOPACK.	–	Replace the SERVOPACK.	–
A47h: Loading Servo Information Error	<i>User parameter configuration (2700h)</i> was executed while a utility function (Fn□□□) was being executed from the Digital Operator or SigmaWin+.	–	Turn the power supply OFF and ON again.	–
	The power supply was turned ON or <i>user parameter configuration (2700h)</i> was executed when an encoder was not connected.	Check the wiring of the encoder.	Turn OFF the power supply, correct the encoder connection, and then turn the power supply back ON.	–
	The power supply was turned ON or <i>user parameter configuration (2700h)</i> was executed when there was a Parameter Setting Error (alarm 040h).	Check the parameter settings.	Correct the parameter settings and turn the power supply OFF and ON again.	–
	A failure occurred in the SERVOPACK.	–	Replace the SERVOPACK.	–

Continued on next page.

Continued from previous page.

Alarm Code: Alarm Name	Possible Cause	Confirmation	Correction	Reference
A48h: EEPROM Parameter Data Error	The power supply was shut OFF while writing parameter settings.	Check the timing of shutting OFF the power supply.	Initialize the parameter settings (<i>restore default parameters</i> (1011h)) and then set the parameters again.	-
	The number of times that parameters were written exceeded the limit.	-	Repair or replace the SERVOPACK. Reconsider the method for writing the parameters.	-
	The power supply voltage suddenly dropped.	Measure the power supply voltage.	Set the power supply voltage within the specified range, and initialize the parameter settings (<i>restore default parameters</i> (1011h)).	-
	A failure occurred in the SERVOPACK.	-	Replace the SERVOPACK.	-
b33h: Current Detection Error 3	A failure occurred in the current detection circuit.	-	Turn the power supply to the SERVOPACK OFF and ON again. If an alarm still occurs, the SERVOPACK may be faulty. Replace the SERVOPACK.	-
bF0h: System Alarm 0	A failure occurred in the SERVOPACK.	-	Turn the power supply to the SERVOPACK OFF and ON again. If an alarm still occurs, the SERVOPACK may be faulty. Replace the SERVOPACK.	-
bF1h: System Alarm 1	A failure occurred in the SERVOPACK.	-	Turn the power supply to the SERVOPACK OFF and ON again. If an alarm still occurs, the SERVOPACK may be faulty. Replace the SERVOPACK.	-
bF2h: System Alarm 2	A failure occurred in the SERVOPACK.	-	Turn the power supply to the SERVOPACK OFF and ON again. If an alarm still occurs, the SERVOPACK may be faulty. Replace the SERVOPACK.	-
bF3h: System Alarm 3	A failure occurred in the SERVOPACK.	-	Turn the power supply to the SERVOPACK OFF and ON again. If an alarm still occurs, the SERVOPACK may be faulty. Replace the SERVOPACK.	-
bF4h: System Alarm 4	A failure occurred in the SERVOPACK.	-	Turn the power supply to the SERVOPACK OFF and ON again. If an alarm still occurs, the SERVOPACK may be faulty. Replace the SERVOPACK.	-
bF5h: System Alarm 5	A failure occurred in the SERVOPACK.	-	Turn the power supply to the SERVOPACK OFF and ON again. If an alarm still occurs, the SERVOPACK may be faulty. Replace the SERVOPACK.	-

Continued on next page.

Continued from previous page.

Alarm Code: Alarm Name	Possible Cause	Confirmation	Correction	Reference
bF6h: System Alarm 6	A failure occurred in the SERVOPACK.	—	Turn the power supply to the SERVOPACK OFF and ON again. If an alarm still occurs, the SERVOPACK may be faulty. Replace the SERVOPACK.	—
bF7h: System Alarm 7	A failure occurred in the SERVOPACK.	—	Turn the power supply to the SERVOPACK OFF and ON again. If an alarm still occurs, the SERVOPACK may be faulty. Replace the SERVOPACK.	—
bF8h: System Alarm 8	A failure occurred in the SERVOPACK.	—	Turn the power supply to the SERVOPACK OFF and ON again. If an alarm still occurs, the SERVOPACK may be faulty. Replace the SERVOPACK.	—
C10h: Servomotor Out of Control (Detected when the servo is turned ON.)	The order of phases U, V, and W in the motor wiring is not correct.	Check the Servomotor wiring.	Make sure that the Servomotor is correctly wired.	—
	There is an error in the setting of Pn080 (2080h) = n.□□X□ (Motor Phase Selection).	Check the setting of Pn080 (2080h) = n.□□X□.	Set Pn080 (2080h) = n.□□X□ to an appropriate value.	page 6-20
	A failure occurred in the encoder.	—	If the motor wiring is correct and an alarm still occurs after turning the power supply OFF and ON again, the Servomotor or linear encoder may be faulty. Replace the Servomotor or linear encoder.	—
	A failure occurred in the SERVOPACK.	—	Turn the power supply to the SERVOPACK OFF and ON again. If an alarm still occurs, the SERVOPACK may be faulty. Replace the SERVOPACK.	—
C20h: Phase Detection Error	The linear encoder signal level is too low.	Check the voltage of the linear encoder signal.	Fine-tune the mounting of the scale head. Or, replace the linear encoder.	—
	The count-up direction of the linear encoder does not match the forward direction of the Moving Coil in the motor.	Check the setting of Pn080 (2080h) = n.□□X□ (Motor Phase Sequence Selection). Check the installation orientation for the linear encoder and Moving Coil.	Change the setting of Pn080 (2080h) = n.□□X□. Correctly reinstall the linear encoder or Moving Coil.	page 6-20
	The polarity sensor signal is being affected by noise.	—	Correct the FG wiring. Implement countermeasures against noise for the polarity sensor wiring.	—
	The setting of Pn282 (2282h) (Linear Encoder Scale Pitch) is not correct.	Check the setting of Pn282 (2282h) (Linear Encoder Scale Pitch).	Check the specifications of the linear encoder and set a correct value.	page 6-15

Continued on next page.

16.2 Alarm Displays

16.2.2 Troubleshooting Alarms

Continued from previous page.

Alarm Code: Alarm Name	Possible Cause	Confirmation	Correction	Reference
C21h: Polarity Sensor Error	The polarity sensor is protruding from the Magnetic Way of the motor.	Check the polarity sensor.	Correctly reinstall the Moving Coil or Magnetic Way of the motor.	-
	The polarity sensor is not wired correctly.	Check the wiring of the polarity sensor.	Correct the wiring of the polarity sensor.	-
	The polarity sensor failed.	-	Replace the polarity sensor.	-
C22h: Phase Information Disagreement	The SERVOPACK phase information is different from the linear encoder phase information.	-	Perform polarity detection.	page 6-25

Continued on next page.

Continued from previous page.

Alarm Code: Alarm Name	Possible Cause	Confirmation	Correction	Reference
C50h: Polarity Detection Failure	The parameter settings are not correct.	Check the linear encoder specifications and feedback signal status.	The settings of Pn282 (2282h) (Linear Encoder Pitch) and Pn080 (2080h) = n.□□X□ (Motor Phase Selection) may not match the installation. Set the parameters to correct values.	page 6-15, page 6-20
	There is noise on the scale signal.	Check to make sure that the frame grounds of the Serial Converter Unit and Servomotor are connected to the FG terminal on the SERVOPACK and that the FG terminal on the SERVOPACK is connected to the frame ground on the power supply. And, confirm that the shield is properly processed on the Linear Encoder Cable. Check to see if the detection reference is repeatedly output in one direction.	Implement appropriate countermeasures against noise for the Linear Encoder Cable.	-
	An external force was applied to the Moving Coil of the motor.	-	The polarity cannot be properly detected if the detection reference is 0 and the speed feedback is not 0 because of an external force, such as cable tension, applied to the Moving Coil. Implement measures to reduce the external force so that the speed feedback goes to 0. If the external force cannot be reduced, increase the setting of Pn481 (2481h) (Polarity Detection Speed Loop Gain).	-
	The linear encoder resolution is too low.	Check the linear encoder scale pitch to see if it is within 100 μm.	If the linear encoder scale pitch is 100 μm or higher, the SERVOPACK cannot detect the correct speed feedback. Use a linear encoder scale pitch with higher resolution. (We recommend a pitch of 40 μm or less.) Or, increase the setting of Pn485 (2485h) (Polarity Detection Reference Speed). However, increasing the setting of Pn485 (2485h) will increase the Servomotor movement range that is required for polarity detection.	-

Continued on next page.

Continued from previous page.

Alarm Code: Alarm Name	Possible Cause	Confirmation	Correction	Reference
C51h: Overtravel Detected during Polarity Detection	The overtravel signal was detected during polarity detection.	Check the overtravel position.	Wire the overtravel signals. Execute polarity detection at a position where an overtravel signal would not be detected.	page 4-33
C52h: Polarity Detection Not Completed	The servo was turned ON when using an absolute linear encoder, Pn587 (2587h) was set to n.□□□0 (Do not detect polarity), and the polarity had not been detected.	–	When using an absolute linear encoder, set Pn587 (2587h) to n.□□□1 (Detect polarity)	–
C53h: Out of Range of Motion for Polarity Detection	The travel distance exceeded the setting of Pn48E (248Eh) (Polarity Detection Range) in the middle of detection.	–	Increase the setting of Pn48E (248Eh) (Polarity Detection Range). Or, increase the setting of Pn481 (2481h) (Polarity Detection Speed Loop Gain).	–
C54h: Polarity Detection Failure 2	An external force was applied to the Servomotor.	–	Increase the setting of Pn495 (2495h) (Polarity Detection Confirmation Force Reference). Increase the setting of Pn498 (2498h) (Polarity Detection Allowable Error Range). Increasing the allowable error will also increase the motor temperature.	–
C80h: Encoder Clear Error or Multiturn Limit Setting Error	A failure occurred in the encoder.	–	Turn the power supply to the SERVOPACK OFF and ON again. If an alarm still occurs, the Servomotor or linear encoder may be faulty. Replace the Servomotor or linear encoder.	–
	A failure occurred in the SERVOPACK.	–	Turn the power supply to the SERVOPACK OFF and ON again. If an alarm still occurs, the SERVOPACK may be faulty. Replace the SERVOPACK.	–

Continued on next page.

Continued from previous page.

Alarm Code: Alarm Name	Possible Cause	Confirmation	Correction	Reference
C90h: Encoder Commu- nications Error	There is a faulty contact in the connector or the connector is not wired correctly for the encoder.	Check the condition of the encoder connector.	Reconnect the encoder connector and check the encoder wiring.	page 4-19
	There is a cable disconnection or short-circuit in the encoder. Or, the cable impedance is outside the specified values.	Check the condition of the Encoder Cable.	Use the Encoder Cable within the specified specifications.	–
	One of the following has occurred: corrosion caused by improper temperature, humidity, or gas, a short-circuit caused by entry of water drops or cutting oil, or faulty contact in connector caused by vibration.	Check the operating environment.	Improve the operating environmental, and replace the cable. If the alarm still occurs, replace the SERVOPACK.	page 3-2
	A malfunction was caused by noise.	–	Correct the wiring around the encoder by separating the Encoder Cable from the Servomotor Main Circuit Cable or by grounding the encoder.	page 4-5
	A failure occurred in the SERVOPACK.	–	Connect the Servomotor to another SERVOPACK, and turn ON the control power supply. If no alarm occurs, the SERVOPACK may be faulty. Replace the SERVOPACK.	–
C91h: Encoder Commu- nications Posi- tion Data Acceleration Rate Error	Noise entered on the signal lines because the Encoder Cable is bent or the sheath is damaged.	Check the condition of the Encoder Cable and connectors.	Check the Encoder Cable to see if it is installed correctly.	page 4-8
	The Encoder Cable is bundled with a high-current line or installed near a high-current line.	Check the installation condition of the Encoder Cable.	Confirm that there is no surge voltage on the Encoder Cable.	–
	There is variation in the FG potential because of the influence of machines on the Servomotor side, such as a welder.	Check the installation condition of the Encoder Cable.	Properly ground the machine to separate it from the FG of the encoder.	–

Continued on next page.

Continued from previous page.

Alarm Code: Alarm Name	Possible Cause	Confirmation	Correction	Reference
C92h: Encoder Commu- nications Timer Error	Noise entered on the signal line from the encoder.	–	Implement countermeasures against noise for the encoder wiring.	page 4-5
	Excessive vibration or shock was applied to the encoder.	Check the operating conditions.	Reduce machine vibration. Correctly install the Servomotor or linear encoder.	–
	A failure occurred in the encoder.	–	Turn the power supply to the SERVOPACK OFF and ON again. If an alarm still occurs, the Servomotor or linear encoder may be faulty. Replace the Servomotor or linear encoder.	–
	A failure occurred in the SERVOPACK.	–	Turn the power supply to the SERVOPACK OFF and ON again. If an alarm still occurs, the SERVOPACK may be faulty. Replace the SERVOPACK.	–
CA0h: Encoder Parameter Error	A failure occurred in the encoder.	–	Turn the power supply to the SERVOPACK OFF and ON again. If an alarm still occurs, the Servomotor or linear encoder may be faulty. Replace the Servomotor or linear encoder.	–
	A failure occurred in the SERVOPACK.	–	Turn the power supply to the SERVOPACK OFF and ON again. If an alarm still occurs, the SERVOPACK may be faulty. Replace the SERVOPACK.	–

Continued on next page.

Continued from previous page.

Alarm Code: Alarm Name	Possible Cause	Confirmation	Correction	Reference
Cb0h: Encoder Echo- back Error	The encoder is wired incorrectly or there is faulty contact.	Check the wiring of the encoder.	Make sure that the encoder is correctly wired.	page 4-19
	The specifications of the Encoder Cable are not correct and noise entered on it.	–	Use a shielded twisted-pair wire cable or a screened twisted-pair cable with conductors of at least 0.12 mm ² .	–
	The Encoder Cable is too long and noise entered on it.	–	<ul style="list-style-type: none"> Rotary Servomotors: The Encoder Cable wiring distance must be 50 m max. Linear Servomotors: The Encoder Cable wiring distance must be 20 m max. 	–
	There is variation in the FG potential because of the influence of machines on the Servomotor side, such as a welder.	Check the condition of the Encoder Cable and connectors.	Properly ground the machine to separate it from the FG of the encoder.	–
	Excessive vibration or shock was applied to the encoder.	Check the operating conditions.	Reduce machine vibration. Correctly install the Servomotor or linear encoder.	–
	A failure occurred in the encoder.	–	Turn the power supply to the SERVOPACK OFF and ON again. If an alarm still occurs, the Servomotor or linear encoder may be faulty. Replace the Servomotor or linear encoder.	–
	A failure occurred in the SERVOPACK.	–	Turn the power supply to the SERVOPACK OFF and ON again. If an alarm still occurs, the SERVOPACK may be faulty. Replace the SERVOPACK.	–
CC0h: Multiturn Limit Disagreement	The multiturn limit of the encoder is different from that of the SERVOPACK. Or, the multiturn limit of the SERVOPACK has been changed.	Check the setting of Pn205 (2205h) (Multiturn Limit).	Change the setting if the alarm occurs.	page 7-37
	A failure occurred in the SERVOPACK.	–	Turn the power supply to the SERVOPACK OFF and ON again. If an alarm still occurs, the SERVOPACK may be faulty. Replace the SERVOPACK.	–

Continued on next page.

Continued from previous page.

Alarm Code: Alarm Name	Possible Cause	Confirmation	Correction	Reference
CF1h: Reception Failed Error in Feed- back Option Module Commu- nications	The cable between the Serial Converter Unit and SERVOPACK is not wired correctly or there is a faulty contact.	Check the wiring of the external encoder.	Correctly wire the cable between the Serial Converter Unit and SERVOPACK.	page 4-21
	A specified cable is not being used between Serial Converter Unit and SERVOPACK.	Check the wiring specifications of the external encoder.	Use a specified cable.	-
	The cable between the Serial Converter Unit and SERVOPACK is too long.	Measure the length of the cable that connects the Serial Converter Unit.	The length of the cable between the Serial Converter Unit and SERVOPACK must be 20 m or less.	-
	The sheath on cable between the Serial Converter Unit and SERVOPACK is broken.	Check the cable that connects the Serial Converter Unit.	Replace the cable between the Serial Converter Unit and SERVOPACK.	-
CF2h: Timer Stopped Error in Feed- back Option Module Commu- nications	Noise entered the cable between the Serial Converter Unit and SERVOPACK.	-	Correct the wiring around the Serial Converter Unit, e.g., separate I/O signal lines from the Main Circuit Cables or ground.	-
	A failure occurred in the Serial Converter Unit.	-	Replace the Serial Converter Unit.	-
	A failure occurred in the SERVOPACK.	-	Replace the SERVOPACK.	-
d00h: Position Devia- tion Overflow (The setting of Pn520 (2520h) (Excessive Position Error Alarm Level) was exceeded by the position deviation.)	The Servomotor U, V, and W wiring is not correct.	Check the wiring of the Servomotor's Main Circuit Cables.	Make sure that there are no faulty contacts in the wiring for the Servomotor and encoder.	-
	The position command speed is too fast.	Reduce the position command speed and try operating the SERVOPACK.	Reduce the position reference speed or the reference acceleration rate, or reconsider the electronic gear ratio.	page 6-43
	The acceleration of the position reference is too high.	Reduce the reference acceleration and try operating the SERVOPACK.	Reduce the acceleration of the position reference using an EtherCAT command.	-
	The setting of Pn520 (2520h) (Excessive Position Error Alarm Level) is too low for the operating conditions.	Check the setting of Pn520 (2520h) to see if it is appropriate.	Optimize the setting of Pn520 (2520h).	page 9-8
	A failure occurred in the SERVOPACK.	-	Turn the power supply to the SERVOPACK OFF and ON again. If an alarm still occurs, the SERVOPACK may be faulty. Replace the SERVOPACK.	-

Continued on next page.

Continued from previous page.

Alarm Code: Alarm Name	Possible Cause	Confirmation	Correction	Reference
d01h: Position Deviation Overflow Alarm at Servo ON	The servo was turned ON after the position deviation exceeded the setting of Pn526 (2526h) (Excessive Position Deviation Alarm Level at Servo ON) while the servo was OFF.	Check the position deviation while the servo is OFF.	Optimize the setting of Pn526 (2526h).	
d02h: Position Deviation Overflow Alarm for Speed Limit at Servo ON	If position deviation remains in the deviation counter, the setting of Pn529 (2529h) or Pn584 (2584h) (Speed Limit Level at Servo ON) limits the speed when the servo is turned ON. This alarm occurs if a position reference is input and the setting of Pn520 (2520h) (Excessive Position Deviation Alarm Level) is exceeded.	–	Optimize the setting of Pn520 (2520h). Or, set Pn529 (2529h) or Pn584 (2584h) to an appropriate value.	page 9-8
d10h: Motor-Load Position Deviation Overflow	The motor direction and external encoder installation orientation are backward.	Check the motor direction and the external encoder installation orientation.	Install the external encoder in the opposite direction, or change the setting of Pn002 (2002h) = n.X□□□ (External Encoder Usage) to reverse the direction.	page 11-6
	There is an error in the connection between the load (e.g., stage) and external encoder coupling.	Check the coupling of the external encoder.	Check the mechanical coupling.	–
d30h: Position Data Overflow	The position data exceeded $\pm 1,879,048,192$.	Check the input reference pulse counter.	Reconsider the operating specifications.	–
E00h: EtherCAT Module Interface Initialization Timeout Error	A failure occurred in the SERVOPACK.	–	Replace the SERVOPACK.	–
E02h: EtherCAT Internal Synchronization Error 1	The EtherCAT transmission cycle fluctuated.	–	Remove the cause of transmission cycle fluctuation at the host controller.	–
	A failure occurred in the SERVOPACK.	–	Turn the power supply to the SERVOPACK OFF and ON again. If an alarm still occurs, the SERVOPACK may be faulty. Replace the SERVOPACK.	–
E03h: EtherCAT Module Interface Communications Data Error	Noise caused an error in communications between the SERVOPACK and EtherCAT Network Module.	–	Implement countermeasures against noise.	–
	A failure occurred in the SERVOPACK.	–	Replace the SERVOPACK.	–

Continued on next page.

Continued from previous page.

Alarm Code: Alarm Name	Possible Cause	Confirmation	Correction	Reference
E71h: Safety Option Module Detection Failure	There is a faulty connection between the SERVOPACK and the Safety Option Module.	Check the connection between the SERVOPACK and the Safety Option Module.	Correctly connect the Safety Option Module.	-
	The Safety Option Module was disconnected.	-	Execute Fn014 (Reset Option Module Configuration Error) from the Digital Operator or SigmaWin+ and then turn the power supply OFF and ON again.	page 16-45
	A failure occurred in the Safety Option Module.	-	Replace the Safety Option Module.	-
	A failure occurred in the SERVOPACK.	-	Replace the SERVOPACK.	-
E72h: Feedback Option Module Detection Failure	There is a faulty connection between the SERVOPACK and the Feedback Option Module.	Check the connection between the SERVOPACK and the Feedback Option Module.	Correctly connect the Feedback Option Module.	-
	The Feedback Option Module was disconnected.	-	Reset the Option Module configuration error and turn the power supply to the SERVOPACK OFF and ON again.	page 16-45
	A failure occurred in the Feedback Option Module.	-	Replace the Feedback Option Module.	-
	A failure occurred in the SERVOPACK.	-	Replace the SERVOPACK.	-
E74h: Unsupported Safety Option Module Alarm	A failure occurred in the Safety Option Module.	-	Replace the Safety Option Module.	-
	An unsupported Safety Option Module was connected.	Refer to the manual for the connected Safety Option Module.	Connect a supported Safety Option Module.	-
E75h: Unsupported Feedback Option Module Alarm	A failure occurred in the Feedback Option Module.	-	Replace the Safety Option Module.	-
	An unsupported Feedback Option Module was connected.	Refer to the catalog for the connected Feedback Option Module or the SERVOPACK manual.	Connect a supported Feedback Option Module.	-
EA0h: Command-Option IF Servo Unit Initial Error	A failure occurred in the SERVOPACK.	-	Replace the SERVOPACK.	-
EA1h: Command-Option IF Memory Check Error	A failure occurred in the SERVOPACK.	-	Replace the SERVOPACK.	-

Continued on next page.

Continued from previous page.

Alarm Code: Alarm Name	Possible Cause	Confirmation	Correction	Reference
EA2h: Command- Option IF Servo Synchronization Error	Fluctuation in the EtherCAT communications synchronization timing (Sync0) caused the synchronization timing in the SERVOPACK to fluctuate.	–	Turn the power supply OFF and ON again and re-establish communications.	–
	A failure occurred in the SERVOPACK.	–	Repair or replace the SERVOPACK.	–
EA3h: Command- Option IF Servo Data Error	Noise caused an error in communications in the SERVOPACK.	–	Implement countermeasures against noise.	–
	A failure occurred in the SERVOPACK.	–	Replace the SERVOPACK.	–
Eb1h: Safety Function Signal Input Timing Error	The delay between activation of the /HWBB1 and /HWBB2 input signals for the HWBB was ten second or longer.	Measure the time delay between the /HWBB1 and /HWBB2 signals.	The output signal circuits or devices for /HWBB1 and /HWBB2 or the SERVOPACK input signal circuits may be faulty. Alternatively, the input signal cables may be disconnected. Check to see if any of these items are faulty or have been disconnected.	–
	A failure occurred in the SERVOPACK.	–	Replace the SERVOPACK.	–
EC8h: Gate Drive Error 1 (An error occurred in the gate drive circuit.)	A failure occurred in the SERVOPACK.	–	Turn the power supply to the SERVOPACK OFF and ON again. If an alarm still occurs, the SERVOPACK may be faulty. Replace the SERVOPACK.	–
EC9h: Gate Drive Error 2 (An error occurred in the gate drive circuit.)				
Ed1h: Command Execution Timeout	A timeout error occurred for an EtherCAT command.	Check the motor status when the command is executed.	Execute the Servo ON command (Enable Operation command) only when the motor is not operating.	–
F10h: Power Supply Line Open Phase (The voltage was low for more than one second for phase R, S, or T when the main power supply was ON.)	The three-phase power supply wiring is not correct.	Check the power supply wiring.	Make sure that the power supply is correctly wired.	page 4-11
	The three-phase power supply is unbalanced.	Measure the voltage for each phase of the three-phase power supply.	Balance the power supply by changing phases.	–
	A failure occurred in the SERVOPACK.	–	Turn the power supply to the SERVOPACK OFF and ON again. If an alarm still occurs, the SERVOPACK may be faulty. Replace the SERVOPACK.	–

Continued on next page.

Continued from previous page.

Alarm Code: Alarm Name	Possible Cause	Confirmation	Correction	Reference
F30h: Dynamic Brake Circuit Error (An error occurred in the dynamic brake circuit.)	The relay or Magnetic Contactor used in the dynamic brake circuit failed.	<ul style="list-style-type: none"> • Check to see if the relay works. • Check to see if the contacts in the Magnetic Contactor have welded together. 	The relay or Magnetic Contactor may be faulty. Replace the relay or Magnetic Contactor.	–
	The operating time of the relay or Magnetic Contactor used in the dynamic brake circuit was excessive.	Check to see if the operating time of the relay and Magnetic Contactor contacts (open to closed, closed to open) is less than 140 ms.	Replace the relay or Magnetic Contactor with a component that has an operating time less than 140 ms. (Recommended: Less than 130 ms)	–
	The cable used in the dynamic brake circuit is broken.	Check to see if the cable used in the dynamic brake circuit is broken.	Replace the broken cable.	–
	Dynamic brake circuit wiring is not correct.	Check the wiring of the relay and Magnetic Contactor used in the dynamic brake circuit.	Wire the relay and Magnetic Contactor correctly.	–
	There is a mistake in the allocation setting for the /DBANS (Dynamic Brake Answer Input) signal.	Check the terminal that was allocated the /DBANS signal and the setting of Pn515 = n.X□□□ (/DBANS (Dynamic Brake Answer Input) Signal Allocation).	<ul style="list-style-type: none"> • Wire the terminal that was allocated the /DBANS signal correctly. • Set Pn515 = n.X□□□ correctly. 	–
		Check the operation of the Magnetic Contactor's auxiliary contacts and the logic of the /DBANS signal.	Correct the operation of the magnetic contactor's auxiliary contacts and the logic of the /DBANS signal to be consistent.	–
	A failure occurred in the SERVOPACK.	–	Turn the power supply to the SERVOPACK OFF and ON again. If the alarm still occurs, the SERVOPACK may be faulty. Replace the SERVOPACK.	–

Continued on next page.

Continued from previous page.

Alarm Code: Alarm Name	Possible Cause	Confirmation	Correction	Reference
F32h: Dynamic Brake Operation Request Output Signal Setting Error (An error occurred in the settings related to the Dynamic Brake Operation Request Output signal.)	The /DBON (Dynamic Brake Operation Request Output) sig- nal and another out- put signal are both allocated to the same CN1 output signal ter- minal.	Check the parameters related to output signals (Pn50E to Pn510, Pn514, Pn53C, and Pn53D).	Set the parameters related to output signals (Pn50E to Pn510, Pn514, Pn53C, and Pn53D) cor- rectly so that the /DBON signal and another output signal are not allocated to the same CN1 output sig- nal terminal.	-
		Check the objects related to output signals (250Eh to 2510h, 2514h, 2752h, and 2753h).	Set the objects related to output signals (250Eh to 2510h, 2514h, 2752h, and 2753h) correctly so that the /DBON signal and another output signal are not allocated to the same CN1 output signal termi- nal.	-
	The /DBON (Dynamic Brake Operation Request Output) sig- nal is being used with the polarity reversed.	Check the related parameters (Pn512 and Pn513) that change the polarity of the /DBON signal.	Set the polarity of the / DBON signal correctly with Pn512 and Pn513.	-
	Digital Outputs (60FEh) is set to the terminal that was allo- cated the /DBON (Dynamic Brake Oper- ation Request Out- put) signal.	Check the Digital Out- puts (60FEh) settings.	Set Digital Outputs (60FEh) so that the signal of the terminal that was allocated the /DBON sig- nal will not be output.	-
FL-1*3: System Alarm	A failure occurred in the SERVOPACK.	-	Turn the power supply to the SERVOPACK OFF and ON again. If an alarm still occurs, the SERVOPACK may be faulty. Replace the SERVOPACK.	-
FL-2*3: System Alarm				
FL-3*3: System Alarm				
FL-4*3: System Alarm				
FL-5*3: System Alarm				
FL-6*3: System Alarm				
CPF00: Digital Operator Communications Error 1	There is a faulty con- tact between the Digi- tal Operator and the SERVOPACK.	Check the connector contact.	Disconnect the connec- tor and insert it again. Or, replace the cable.	-
	A malfunction was caused by noise.	-	Keep the Digital Operator or the cable away from sources of noise.	-
CPF01: Digital Operator Communications Error 2	A failure occurred in the Digital Operator.	-	Disconnect the Digital Operator and then connect it again. If an alarm still occurs, the Digital Opera- tor may be faulty. Replace the Digital Operator.	-
	A failure occurred in the SERVOPACK.	-	Turn the power supply to the SERVOPACK OFF and ON again. If an alarm still occurs, the SERVOPACK may be faulty. Replace the SERVOPACK.	-

16.2 Alarm Displays

16.2.3 Resetting Alarms

*1. Detection Conditions

• Rotary Servomotor

If either of the following conditions is detected, an alarm will occur.

$$\bullet \text{ Pn533 [min}^{-1}\text{]} \times \frac{\text{Encoder resolution}}{6 \times 10^5} \leq 1$$

$$\bullet \text{ Maximum motor speed [min}^{-1}\text{]} \times \frac{\text{Encoder resolution}}{\text{Approx. } 3.66 \times 10^{12}} \geq 1$$

• Linear Servomotor

If either of the following conditions is detected, an alarm will occur.

$$\bullet \frac{\text{Pn585 [mm/s]}}{\text{Linear encoder pitch [\mu m]}} \times \frac{\text{Resolution of Serial Converter Unit}}{10} \leq 1$$

$$\bullet \frac{\text{Pn385 [100 mm/s]}}{\text{Linear encoder pitch [\mu m]}} \times \frac{\text{Resolution of Serial Converter Unit}}{\text{Approx. } 6.10 \times 10^5} \geq 1$$

*2. Refer to the catalog for details.

*3. These alarms are not stored in the alarm history. They are only displayed on the panel display.

16.2.3 Resetting Alarms

If there is an ALM (Servo Alarm) signal, use one of the following methods to reset the alarm after eliminating the cause of the alarm.



Be sure to eliminate the cause of an alarm before you reset the alarm.

If you reset the alarm and continue operation without eliminating the cause of the alarm, it may result in damage to the equipment or fire.

Resetting Alarms with the SigmaWin+

Use the following procedure to reset alarms with the SigmaWin+.

1. Click the  Servo Drive Button in the workspace of the Main Window of the SigmaWin+.
2. Select **Display Alarm** in the Menu Dialog Box.
The Alarm Display Dialog Box will be displayed.
3. Click the **Reset axes** Button.

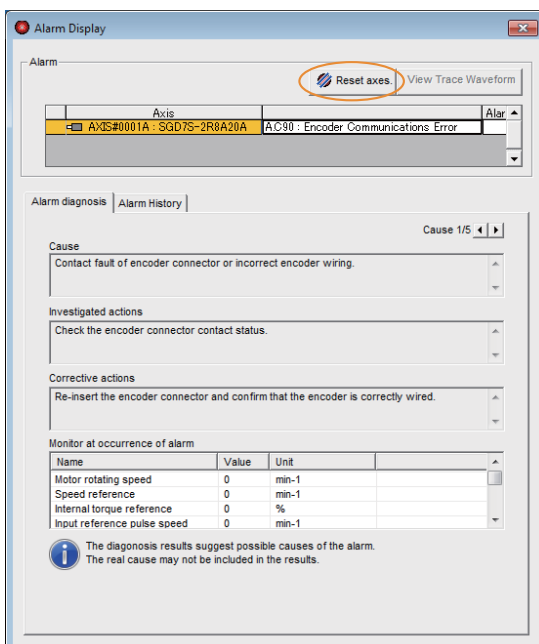

The alarm will be reset, and the alarm display will be cleared.

This concludes the procedure to reset alarms.

Clearing Alarms and Warnings with the Fault Reset Command

Execute the Fault Reset command to clear alarms or warnings.

Refer to the following section for details on the Fault Reset command.

 [Controlword Bits](#) on page 15-23

Resetting Alarms Using the Digital Operator

Press the **ALARM RESET** Key on the Digital Operator. Refer to the following manual for details on resetting alarms.

 [Σ-7-Series Digital Operator Operating Manual \(Manual No.: SIEP S800001 33\)](#)

16.2.4 Displaying the Alarm History

The alarm history displays up to the last ten alarms that have occurred in the SERVOPACK.



Note: The following alarms are not displayed in the alarm history: A.E50 (EtherCAT Synchronization Error), A.E60 (Reception Error in EtherCAT Communications), and FL-1 to FL-5.

Preparations

No preparations are required.

Applicable Tools

The following table lists the tools that you can use to display the alarm history.

Tool	Fn No./Function Name	Reference
Digital Operator	Fn000	 Σ-7-Series Digital Operator Operating Manual (Manual No.: SIEP S800001 33)
SigmaWin+	<i>Troubleshooting – Display Alarm</i>	 Operating Procedure on page 16-43

Operating Procedure

Use the following procedure to display the alarm history.

1. Click the  Servo Drive Button in the workspace of the Main Window of the SigmaWin+.
2. Select **Display Alarm** in the Menu Dialog Box.
The Alarm Display Dialog Box will be displayed.
3. Click the **Alarm History** Tab.
The following display will appear and you can check the alarms that occurred in the past.

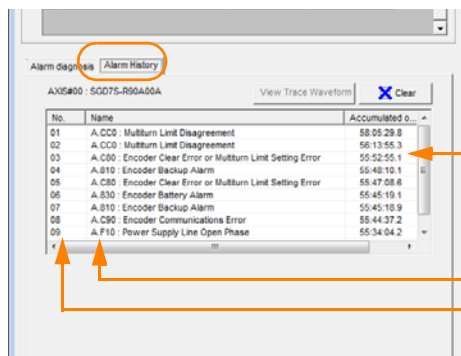

No.	Name	Accumulated o...
01	A.CC0: Multiturn Limit Disagreement	58:05:29.8
02	A.CC0: Multiturn Limit Disagreement	56:13:55.3
03	A.CB0: Encoder Clear Error or Multiturn Limit Setting Error	55:52:55.1
04	A.B10: Encoder Backup Alarm	55:48:10.1
05	A.CB0: Encoder Clear Error or Multiturn Limit Setting Error	55:47:08.8
06	A.B30: Encoder Battery Alarm	55:45:19.1
07	A.B10: Encoder Backup Alarm	55:45:19.9
08	A.CB0: Encoder Communications Error	55:44:37.2
09	A.F10: Power Supply Line Open Phase	55:34:04.2

Accumulated operation time
Total operation time to the point at which the alarm occurred is displayed in increments of 100 ms from when the control power supply and main circuit power supply turned ON.
For 24-hour, 365-day operation, measurements are possible for approximately 13 years.

Alarm number: Alarm name
Alarms in order of occurrence
(Older alarms have higher numbers.)

- Information**
1. If the same alarm occurs consecutively within one hour, it is not saved in the alarm history. If it occurs after an hour or more, it is saved.
 2. You can clear the alarm history by clicking the **Clear** Button. The alarm history is not cleared when alarms are reset or when the SERVOPACK main circuit power is turned OFF.

This concludes the procedure to display the alarm history.

16.2.5 Clearing the Alarm History

You can clear the alarm history that is recorded in the SERVOPACK.

The alarm history is not cleared when alarms are reset or when the SERVOPACK main circuit power is turned OFF. You must perform the following procedure.

Preparations

Always check the following before you clear the alarm history.

- The parameters must not be write prohibited.

Applicable Tools

The following table lists the tools that you can use to clear the alarm history.

Tool	Fn No./Function Name	Reference
Digital Operator	Fn006	Σ-7-Series Digital Operator Operating Manual (Manual No.: SIEP S800001 33)
SigmaWin+	<i>Troubleshooting – Display Alarm</i>	<i>Operating Procedure</i> on page 16-44

Operating Procedure

Use the following procedure to reset the alarm history.

1. Click the Servo Drive Button in the workspace of the Main Window of the SigmaWin+.
2. Select **Display Alarm** in the Menu Dialog Box.
The Alarm Display Dialog Box will be displayed.
3. Click the **Alarm History** Tab.
4. Click the **Clear** Button.
The alarm history will be cleared.

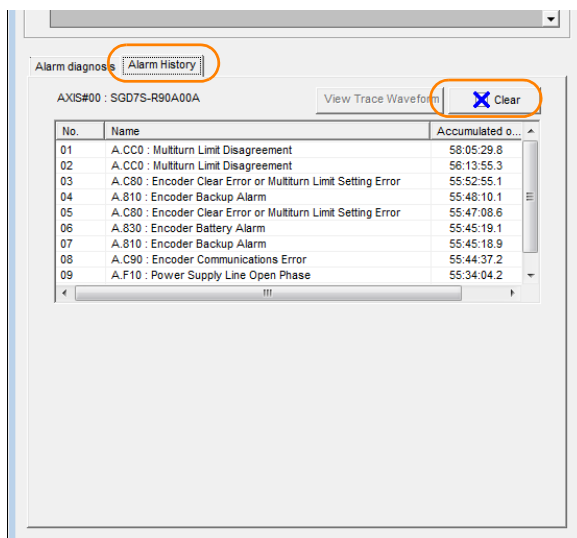

This concludes the procedure to reset the alarm history.

16.2.6 Resetting Alarms Detected in Option Modules

If any Option Modules are attached to the SERVOPACK, the SERVOPACK detects the presence and models of the connected Option Modules. If it finds any errors, it outputs alarms.

You can delete those alarms with this operation.

- Information**
- This operation is the only way to reset alarms for Option Modules. The alarms are not reset when you reset other alarms or when you turn OFF the power supply to the SERVOPACK.
 - Always remove the cause of an alarm before you reset the alarm.



Preparations

Always check the following before you clear an alarm detected in an Option Module.

- The parameters must not be write prohibited.

Applicable Tools

The following table lists the tools that you can use to reset Option Module configuration errors.

Tool	Fn No./Function Name	Reference
Digital Operator	Fn014	 Σ -7-Series Digital Operator Operating Manual (Manual No.: SIEP S800001 33)
SigmaWin+	<i>Troubleshooting - Display Alarm</i>	 <i>Operating Procedure</i> on page 16-45

Operating Procedure

Use the following procedure to reset alarms detected in Option Modules.

1. Click the  Servo Drive Button in the workspace of the Main Window of the SigmaWin+.
2. Select **Display Alarm** in the Menu Dialog Box.
The Display Alarm Dialog Box will be displayed.
3. Click the **Reset axes** Button.

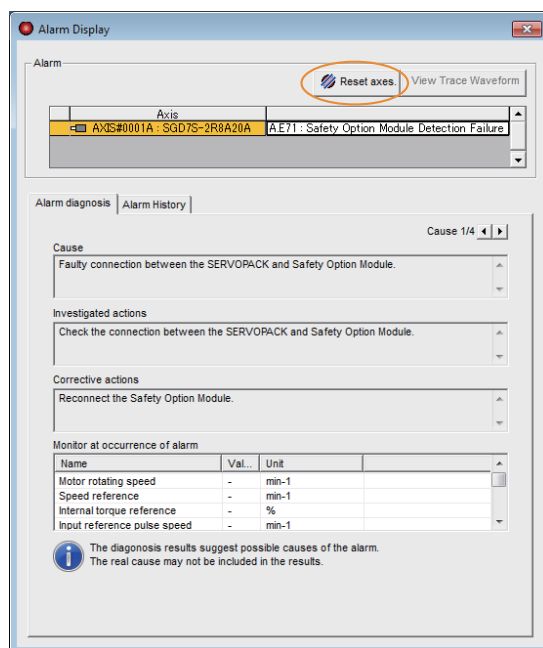

The Reset Option Module Configuration Error Dialog Box will be displayed.

4. Select the **Clear Check Box** for the Option Module for which to reset the alarm and then click the **Execute Button**.

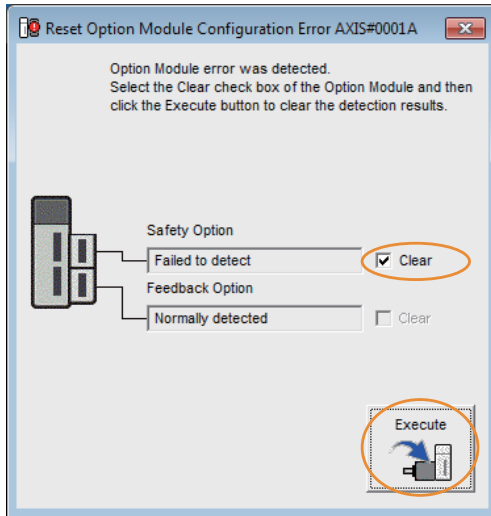

5. Read the precaution and then click the **OK Button**.

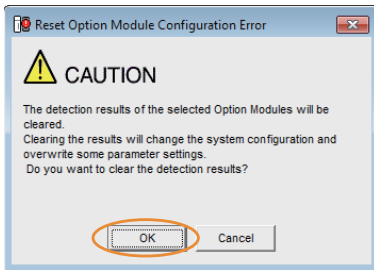

6. Read the precaution and then click the **OK Button**.

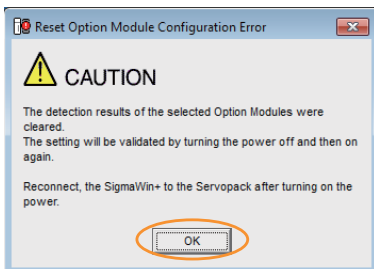

7. Turn the power supply to the **SERVOPACK OFF** and **ON** again.

This concludes the procedure to reset alarms detected in Option Modules.

16.2.7 Resetting Motor Type Alarms

The SERVOPACK automatically determines the type of motor that is connected to it. If the type of motor that is connected is changed, an A.070 alarm (Motor Type Change Detected) will occur the next time the SERVOPACK is started. If an A.070 alarm occurs, you must set the parameters to match the new type of motor.

An A.070 alarm is reset by executing the Reset Motor Type Alarm utility function.

- Information**
1. This utility function is the only way to reset an A.070 alarm (Motor Type Change Detected). The errors are not reset when you reset alarms or turn OFF the power supply to the SERVOPACK.
 2. If an A.070 alarm occurs, first set the parameters according to the newly connected motor type and then execute the Reset Motor Type Alarm utility function.



Preparations

Always check the following before you clear a motor type alarm.

- The parameters must not be write prohibited.

Applicable Tools

The following table lists the tools that you can use to clear the motor type alarm.

Tool	Fn No./Function Name	Reference
Digital Operator	Fn021	 Σ -7-Series Digital Operator Operating Manual (Manual No.: SIEP S800001 33)
SigmaWin+	<i>Troubleshooting – Reset Motor Type Alarm</i>	 <i>Operating Procedure</i> on page 16-47

Operating Procedure

Use the following procedure to reset Motor Type alarm.

1. Click the  Servo Drive Button in the workspace of the Main Window of the SigmaWin+.
2. Select **Reset Motor Type Alarm** in the Menu Dialog Box.
The Reset Motor Type Alarm Dialog Box will be displayed.
3. Click the **Reset** Button.

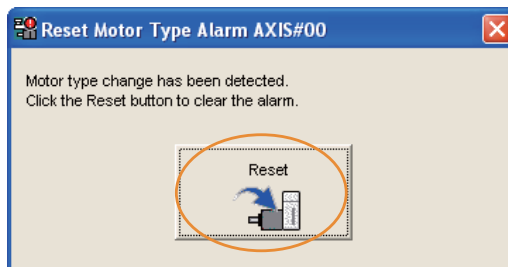

4. Read the precaution and then click the **OK** Button.

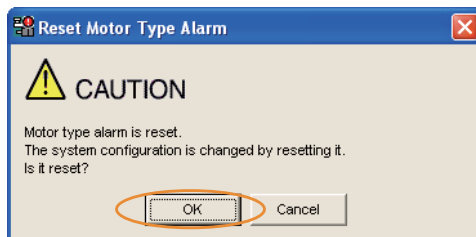

5. Read the precaution and then click the **OK** Button.

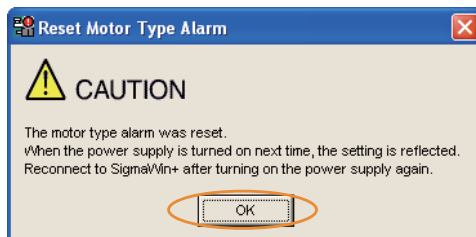

6. Turn the power supply to the SERVOPACK OFF and ON again.

This concludes the procedure to reset Motor Type alarms.

16.3 Warning Displays

To check a warning that occurs in the SERVOPACK, use one of the following methods. Warnings are displayed to warn you before an alarm occurs.

Panel display on SERVOPACK	<p>If there is a warning, the code will be displayed one character at a time, as shown below. Example: Alarm A.910</p>
Digital Operator	The warning code is displayed.
Statusword (6041h)	Bit 7 (<i>warning</i>) in the <i>statusword</i> will change to 1. (Bit 7 is 0 during normal operation.)
Error code (603Fh)	A current warning code is stored in <i>error code</i> (603Fh).
Emergency message	The Controller is notified of any warning that occurs. (Notification may not be possible if EtherCAT communications are unstable.)

This next section provides a list of warnings and the causes of and corrections for warnings.

16.3.1 List of Warnings

The warning table gives the warning name and warning meaning in order of the warning codes.

Warning Code	Warning Name	Meaning
900h	Position Deviation Overflow	The position deviation exceeded the percentage set with the following formula: (Pn520 (2520h) × Pn51E (251Eh)/100)
901h	Position Deviation Overflow Alarm at Servo ON	The position deviation when the servo was turned ON exceeded the percentage set with the following formula: (Pn526 (2526h) × Pn528 (2528h)/100)
910h	Overload	This warning occurs before an overload alarm (A.710 or A.720) occurs. If the warning is ignored and operation is continued, an alarm may occur.
911h	Vibration	Abnormal vibration was detected during motor operation. The detection level is the same as A.520. Set whether to output an alarm or a warning by setting Pn310 (2310h) (Vibration Detection Selection).
912h	Internal Temperature Warning 1 (Control Board Temperature Error)	The surrounding temperature of the control PCB is abnormal.
913h	Internal Temperature Warning 2 (Power Board Temperature Error)	The surrounding temperature of the power PCB is abnormal.
920h	Regenerative Overload	This warning occurs before an A.320 alarm (Regenerative Overload) occurs. If the warning is ignored and operation is continued, an alarm may occur.
921h	Dynamic Brake Overload	This warning occurs before an A.731 alarm (Dynamic Brake Overload) occurs. If the warning is ignored and operation is continued, an alarm may occur.
923h	SERVOPACK Built-in Fan Stopped	The fan inside the SERVOPACK stopped.
930h	Absolute Encoder Battery Error	This warning occurs when the voltage of absolute encoder's battery is low.

Continued on next page.

Continued from previous page.

Warning Code	Warning Name	Meaning
93Bh	Overheat Warning	The input voltage (temperature) for the overheat protection input (TH) signal exceeded the setting of Pn61C (261Ch) (Overheat Warning Level).
942h	Speed Ripple Compensation Information Disagreement	The speed ripple compensation information stored in the encoder does not agree with the speed ripple compensation information stored in the SERVOPACK.
971h	Undervoltage	This warning occurs before an A.410 alarm (Undervoltage) occurs. If the warning is ignored and operation is continued, an alarm may occur.
9A0h	Overtravel	Overtravel was detected while the servo was ON.
9b0h	Preventative Maintenance Warning	One of the consumable parts has reached the end of its service life.

Note: Use Pn008 (2008h) = n.□X□□ (Warning Detection Selection) to control warning detection. However, the following warnings are not affected by the setting of Pn008 (2008h) = n.□X□□ and other parameter settings are required in addition to Pn008 (2008h) = n.□X□□.

Warning	Parameters That Must Be Set to Select Warning Detection	Reference
911h	Pn310 (2310h) = n.□□□□ (Vibration Detection Setting)	page 7-46
930h	Pn008 (2008h) = n.□□□X (Low Battery Voltage Alarm/Warning Selection)	page 16-3
942h	Pn423 (2423h) = n.□□X□ (Speed Ripple Compensation Information Disagreement Warning Detection Selection)	page 9-59
971h	Pn008 (2008h) = n.□□X□ (Function Selection for Undervoltage) (Not affected by the setting of Pn008 (2008h) = n.□X□□.)	page 7-15
9A0h	Pn00D (200Dh) = n.X□□□ (Overtravel Warning Detection Selection) (Not affected by the setting of Pn008 (2008h) = n.□X□□.)	page 6-29
9b0h	Pn00F (200Fh) = n.□□□X (Preventative Maintenance Selection)	page 10-15

16.3.2 Troubleshooting Warnings

The causes of and corrections for the warnings are given in the following table. Contact your Yaskawa representative if you cannot solve a problem with the correction given in the table.

Warning Number: Warning Name	Possible Cause	Confirmation	Correction	Reference
900h: Position Deviation Overflow	The Servomotor U, V, and W wiring is not correct.	Check the wiring of the Servomotor's Main Circuit Cables.	Make sure that there are no faulty connections in the wiring for the Servomotor and encoder.	-
	A SERVOPACK gain is too low.	Check the SERVO-PACK gains.	Increase the servo gain, e.g., by using autotuning without a host reference.	page 9-23
	The acceleration of the position reference is too high.	Reduce the reference acceleration and try operating the SERVO-PACK.	Reduce the acceleration of the position reference using an EtherCAT command.	-
	The excessive position deviation alarm level (Pn520 (2520h) × Pn51E (251Eh)/100) is too low for the operating conditions.	Check excessive position deviation alarm level (Pn520 (2520h) × Pn51E (251Eh)/100) to see if it is set to an appropriate value.	Optimize the settings of Pn520 (2520h) and Pn51E (251Eh).	page 9-8
	A failure occurred in the SERVO-PACK.	-	Turn the power supply to the SERVOPACK OFF and ON again. If an alarm still occurs, the SERVOPACK may be faulty. Replace the SERVOPACK.	-

Continued on next page.

16.3 Warning Displays

16.3.2 Troubleshooting Warnings

Continued from previous page.

Warning Number: Warning Name	Possible Cause	Confirmation	Correction	Reference
910h: Overload (warning before an A.710 or A.720 alarm occurs)	The wiring is not correct or there is a faulty contact in the motor or encoder wiring.	Check the wiring.	Make sure that the Servomotor and encoder are correctly wired.	-
	Operation was performed that exceeded the overload protection characteristics.	Check the motor overload characteristics and Run command.	Reconsider the load and operating conditions. Or, increase the motor capacity.	-
911h: Vibration	An excessive load was applied during operation because the Servomotor was not driven because of mechanical problems.	Check the operation reference and motor speed.	Remove the mechanical problem.	-
	The overload warning level (Pn52B (252Bh)) is not suitable.	Check that the overload warning level (Pn52B (252Bh)) is suitable.	Set a suitable overload warning level (Pn52B (252Bh)).	page 6-40
	A failure occurred in the SERVOPACK.	-	The SERVOPACK may be faulty. Replace the SERVOPACK.	-
911h: Vibration	Abnormal vibration was detected during motor operation.	Check for abnormal motor noise, and check the speed and torque waveforms during operation.	Reduce the motor speed. Or, reduce the servo gain with custom tuning.	page 9-41
	The setting of Pn103 (2103h) (Moment of Inertia Ratio) is greater than the actual moment of inertia or was greatly changed.	Check the moment of inertia ratio or mass ratio.	Correct the setting of Pn103 (2103h).	page 9-16
	The vibration detection level (Pn312 (2312h) or Pn384 (2384h)) is not suitable.	Check that the vibration detection level (Pn312 (2312h) or Pn384 (2384h)) is suitable.	Set a suitable vibration detection level (Pn312 (2312h) or Pn384 (2384h)).	page 7-46

Continued on next page.

Continued from previous page.

Warning Number: Warning Name	Possible Cause	Confirmation	Correction	Reference
912h: Internal Temperature Warning 1 (Control Board Temperature Error)	The surrounding temperature is too high.	Check the surrounding temperature using a thermostat. Or, check the operating status with the SERVOPACK installation environment monitor.	Decrease the surrounding temperature by improving the SERVOPACK installation conditions.	page 3-6
	An overload alarm was reset by turning OFF the power supply too many times.	Check the alarm display to see if there is an overload alarm.	Change the method for resetting the alarm.	–
	There was an excessive load or operation was performed that exceeded the regenerative processing capacity.	Use the accumulated load ratio to check the load during operation, and use the regenerative load ratio to check the regenerative processing capacity.	Reconsider the load and operating conditions.	–
	The SERVOPACK installation orientation is not correct or there is insufficient space around the SERVOPACK.	Check the SERVOPACK installation conditions.	Install the SERVOPACK according to specifications.	page 3-3, page 3-5
	A failure occurred in the SERVOPACK.	–	The SERVOPACK may be faulty. Replace the SERVOPACK.	–
913h: Internal Temperature Warning 2 (Power Board Temperature Error)	The surrounding temperature is too high.	Check the surrounding temperature using a thermostat. Or, check the operating status with the SERVOPACK installation environment monitor.	Decrease the surrounding temperature by improving the SERVOPACK installation conditions.	page 3-6
	An overload alarm was reset by turning OFF the power supply too many times.	Check the alarm display to see if there is an overload alarm.	Change the method for resetting the alarm.	–
	There was an excessive load or operation was performed that exceeded the regenerative processing capacity.	Use the accumulated load ratio to check the load during operation, and use the regenerative load ratio to check the regenerative processing capacity.	Reconsider the load and operating conditions.	–
	The SERVOPACK installation orientation is not correct or there is insufficient space around the SERVOPACK.	Check the SERVOPACK installation conditions.	Install the SERVOPACK according to specifications.	page 3-3, page 3-5
	A failure occurred in the SERVOPACK.	–	The SERVOPACK may be faulty. Replace the SERVOPACK.	–

Continued on next page.

Continued from previous page.

Warning Number: Warning Name	Possible Cause	Confirmation	Correction	Reference
920h: Regenerative Overload (warning before an A.320 alarm occurs)	The power supply voltage exceeded the specified range.	Measure the power supply voltage.	Set the power supply voltage within the specified range.	-
	There is insufficient external regenerative resistance, Regenerative Resistor capacity, or SERVOPACK capacity, or there has been a continuous regeneration state.	Check the operating conditions and capacity again.	Change the regenerative resistance value, regenerative resistance capacity, or SERVOPACK capacity. Recheck the operating conditions.	-
	There was a continuous regeneration state because a negative load was continuously applied.	Check the load applied to the Servomotor during operation.	Reconsider the system including the servo, machine, and operating conditions.	-
921h: Dynamic Brake Overload (warning before an A.731 alarm occurs)	The Servomotor was rotated by an external force.	Check the operation status.	Implement measures to ensure that the motor will not be rotated by an external force.	-
	When the Servomotor was stopped with the dynamic brake, the rotational or linear kinetic energy exceeded the capacity of the Dynamic Brake Resistor.	Check the power consumed by the DB resistor to see how frequently the DB is being used.	Reconsider the following: <ul style="list-style-type: none"> • Reduce the Servomotor command speed. • Decrease the moment of inertia or mass. • Reduce the frequency of stopping with the dynamic brake. 	-
	A failure occurred in the SERVOPACK.	-	The SERVOPACK may be faulty. Replace the SERVOPACK.	-
923h: SERVOPACK Built-in Fan Stopped	The fan inside the SERVOPACK stopped.	Check for foreign matter inside the SERVOPACK.	Remove foreign matter from the SERVOPACK. If an alarm still occurs, the SERVOPACK may be faulty. Replace the SERVOPACK.	-
930h: Absolute Encoder Battery Error (The absolute encoder battery voltage was lower than the specified level.) (Detected only when an absolute encoder is connected.)	The battery connection is faulty or a battery is not connected.	Check the battery connection.	Correct the battery connection.	page 4-20
	The battery voltage is lower than the specified value (2.7 V).	Measure the battery voltage.	Replace the battery.	page 16-3
	A failure occurred in the SERVOPACK.	-	The SERVOPACK may be faulty. Replace the SERVOPACK.	-

Continued on next page.

Continued from previous page.

Warning Number: Warning Name	Possible Cause	Confirmation	Correction	Reference
93Bh: Overheat Warning	The surrounding temperature is too high.	Check the surrounding temperature using a thermostat.	Lower the surrounding temperature by improving the installation conditions of the Linear Servomotor or the machine.	–
	Operation was performed under an excessive load.	Use the accumulated load ratio to check the load during operation.	Reconsider the load and operating conditions.	–
	A failure occurred in the SERVOPACK.	–	The SERVOPACK may be faulty. Replace the SERVOPACK.	–
	The temperature detection circuit in the Linear Servomotor is faulty or the sensor attached to the machine is faulty.	–	The temperature detection circuit in the Linear Servomotor may be faulty or the sensor attached to the machine may be faulty. Replace the Linear Servomotor or repair the sensor attached to the machine.	–
942h: Speed Ripple Compensation Information Disagreement	The speed ripple compensation information stored in the encoder does not agree with the speed ripple compensation information stored in the SERVOPACK.	–	Reset the speed ripple compensation value on the SigmaWin+.	page 9-59
		–	Set Pn423 (2423h) to n.□□1□ (Do not detect A.942 alarms). However, changing the setting may increase the speed ripple.	page 9-59
		–	Set Pn423 (2423h) to n.□□□0 (Disable speed ripple compensation). However, changing the setting may increase the speed ripple.	page 9-59
971h: Undervoltage	For a 400-V SERVOPACK, the AC power supply voltage dropped below 280 V.	Measure the power supply voltage.	Set the power supply voltage within the specified range.	–
	The power supply voltage dropped during operation.	Measure the power supply voltage.	Increase the power supply capacity.	–
	A momentary power interruption occurred.	Measure the power supply voltage.	If you have changed the setting of Pn509 (2509h) (Momentary Power Interruption Hold Time), decrease the setting.	page 7-14
	The SERVOPACK fuse is blown out.	–	Replace the SERVOPACK and connect a reactor.	page 4-18
	A failure occurred in the SERVOPACK.	–	The SERVOPACK may be faulty. Replace the SERVOPACK.	–

Continued on next page.

16.3 Warning Displays

16.3.2 Troubleshooting Warnings

Continued from previous page.

Warning Number: Warning Name	Possible Cause	Confirmation	Correction	Reference
9A0h: Overtravel (Overtravel status was detected.)	Overtravel was detected while the servo was ON.	Check the status of the overtravel signals on the input signal monitor.	Even if an overtravel signal is not shown by the input signal monitor, momentary overtravel may have been detected. Take the following precautions. <ul style="list-style-type: none"> • Do not specify movements that would cause overtravel from the host controller. • Check the wiring of the overtravel signals. • Implement countermeasures against noise. 	page 6-29
9b0h: Preventative Maintenance Warning	One of the consumable parts has reached the end of its service life.	–	Replace the part. Contact your Yaskawa representative for replacement.	page 10-15

16.4 Troubleshooting Based on the Operation and Conditions of the Servomotor

This section provides troubleshooting based on the operation and conditions of the Servomotor, including causes and corrections.

Problem	Possible Cause	Confirmation	Correction	Reference
Servomotor Does Not Start	The control power supply is not turned ON.	Measure the voltage between control power supply terminals.	Turn OFF the Servo System. Correct the wiring so that the control power supply is turned ON.	-
	The main circuit power supply is not turned ON.	Measure the voltage across the main circuit power input terminals.	Turn OFF the Servo System. Correct the wiring so that the main circuit power supply is turned ON.	-
	The I/O signal connector (CN1) pins are not wired correctly or are disconnected.	Turn OFF the Servo System. Check the wiring condition of the I/O signal connector (CN1) pins.	Correct the wiring of the I/O signal connector (CN1) pins.	page 4-30, page 10-5
	The wiring for the Servomotor Main Circuit Cables or Encoder Cable is disconnected.	Check the wiring conditions.	Turn OFF the Servo System. Wire the cable correctly.	-
	There is an overload on the Servomotor.	Operate the Servomotor with no load and check the load status.	Turn OFF the Servo System. Reduce the load or replace the Servomotor with a Servomotor with a larger capacity.	-
	The type of encoder that is being used does not agree with the setting of Pn002 (2002h) = n.□X□□ (Encoder Usage).	Check the type of the encoder that is being used and the setting of Pn002 (2002h) = n.□X□□.	Set Pn002 (2002h) = n.□X□□ according to the type of the encoder that is being used.	page 7-31
	There is a mistake in the input signal allocations (Pn50A (250Ah), Pn50B (250Bh), Pn511 (2511h), and Pn516 (2516h)).	Check the input signal allocations (Pn50A (250Ah), Pn50B (250Bh), Pn511 (2511h), Pn516 (2516h)).	Correctly allocate the input signals (Pn50A (250Ah), Pn50B (250Bh), Pn511 (2511h), Pn516 (2516h)).	page 7-4, page 10-5
	The Servo ON command (Enable Operation command) was not sent.	Make sure the Servo ON command (Enable Operation command) is set to Operation Enabled.	Set the correct value for the Servo ON command (Enable Operation command).	-
	The torque limit reference is too small.	Check the torque limit reference.	Increase the torque limit reference.	-
	The operation mode is not set.	Check to see if <i>modes of operation</i> (6060h) is set.	Set <i>modes of operation</i> (6060h) correctly.	-
	A software limit is active.	Check to see if the target position exceeds a software limit.	Specify a target position that is within the software limits.	-
	EtherCAT communications are not established.	Check to see if the EtherCAT indicator shows the Operational state.	Place the EtherCAT communications in the Operational state.	-
The P-OT (Forward Drive Prohibit) or N-OT (Reverse Drive Prohibit) signal is still OFF.	Check the P-OT and N-OT signals.	Turn ON the P-OT and N-OT signals.	page 10-5	

Continued on next page.

Continued from previous page.

Problem	Possible Cause	Confirmation	Correction	Reference
Servomotor Does Not Start	The safety input signals (/HWBB1 or /HWBB2) were not turned ON.	Check the /HWBB1 and /HWBB2 input signals.	Turn ON the /HWBB1 and /HWBB2 input signals. If you are not using the safety function, connect the Safety Jumper Connector (provided as an accessory) to CN8.	page 10-5
	The FSTP (Forced Stop Input) signal is still OFF.	Check the FSTP signal.	<ul style="list-style-type: none"> Turn ON the FSTP signal. If you will not use the function to force the motor to stop, set Pn516 (2516h) = n.□□□X (FSTP (Forced Stop Input) Signal Allocation) to disable the signal. 	page 10-5
	A failure occurred in the SERVOPACK.	–	Turn OFF the Servo System. Replace the SERVOPACK.	–
	The polarity detection was not executed.	Check the setting of Pn080 (2080h) = n.□□□X (Polarity Sensor Selection).	Correct the parameter setting.	page 6-22
Check the inputs to the Servo ON command (Enable Operation command).		<ul style="list-style-type: none"> If you are using an incremental linear encoder, send the Servo ON command (Enable Operation command) from the host controller. If you are using an absolute linear encoder, execute polarity detection. 	page 6-23	
Servomotor Moves Instantaneously, and Then Stops	There is a mistake in the Servomotor wiring.	Turn OFF the Servo System. Check the wiring.	Wire the Servomotor correctly.	–
	There is a mistake in the wiring of the encoder or Serial Converter Unit.	Turn OFF the Servo System. Check the wiring.	Wire the Serial Converter Unit correctly.	–
	There is a mistake in the linear encoder wiring.	Turn OFF the Servo System. Check the wiring.	Wire the cable correctly.	–
	The setting of Pn282 (2282h) (Linear Encoder Pitch) is not correct.	Check the setting of Pn282 (2282h).	Correct the setting of Pn282 (2282h).	page 6-15
	The count-up direction of the linear encoder does not match the forward direction of the Moving Coil in the motor.	Check the directions.	Change the setting of Pn080 (2080h) = n.□□X□ (Motor Phase Selection). Match the linear encoder direction and motor direction.	page 6-20
	Polarity detection was not performed correctly.	Check to see if electrical angle 2 (electrical angle from polarity origin) at any position is between $\pm 10^\circ$.	Correct the settings for the polarity detection-related parameters.	–

Continued on next page.

Continued from previous page.

Problem	Possible Cause	Confirmation	Correction	Reference
Servomotor Speed Is Unstable	There is a faulty connection in the Servomotor wiring.	The connector connections for the power line (U, V, and W phases) and the encoder or Serial Converter Unit may be unstable. Turn OFF the Servo System. Check the wiring.	Tighten any loose terminals or connectors and correct the wiring.	–
Servomotor Moves without a Reference Input	A failure occurred in the SERVOPACK.	–	Turn OFF the Servo System. Replace the SERVOPACK.	–
	The count-up direction of the linear encoder does not match the forward direction of the Moving Coil in the motor.	Check the directions.	Change the setting of Pn080 (2080h) = n.□□X□ (Motor Phase Sequence Selection). Match the linear encoder direction and Servomotor direction.	page 6-20
	Polarity detection was not performed correctly.	Check to see if electrical angle 2 (electrical angle from polarity origin) at any position is between $\pm 10^\circ$.	Correct the settings for the polarity detection-related parameters.	–
Dynamic Brake Does Not Operate	The setting of Pn001 (2001h) = n.□□□X (Servo OFF or Alarm Group 1 Stopping Method) is not suitable.	Check the setting of Pn001 (2001h) = n.□□□X.	Set Pn001 (2001h) = n.□□□X correctly.	–
	The Dynamic Brake Resistor is disconnected.	Check the moment of inertia, motor speed, and dynamic brake frequency of use. If the moment of inertia, motor speed, or dynamic brake frequency of use is excessive, the dynamic brake resistance may be disconnected.	Turn OFF the Servo System. Replace the SERVOPACK. To prevent disconnection, reduce the load.	–
	There was a failure in the dynamic brake drive circuit.	–	There is a defective component in the dynamic brake circuit. Turn OFF the Servo System. Replace the SERVOPACK.	–

Continued on next page.

Continued from previous page.

Problem	Possible Cause	Confirmation	Correction	Reference
Abnormal Noise from Servomotor	The Servomotor vibrated considerably while performing the tuning-less function with the default settings.	Check the waveform of the motor speed.	Reduce the load so that the moment of inertia ratio or mass ratio is within the allowable value, or increase the load level or reduce the rigidity level in the tuning-less level settings.	page 9-12
	The machine mounting is not secure.	Turn OFF the Servo System. Check to see if there are any loose mounting screws.	Tighten the mounting screws.	-
	The machine mounting is not secure.	Turn OFF the Servo System. Check to see if there is misalignment in the coupling.	Align the coupling.	-
		Turn OFF the Servo System. Check to see if the coupling is balanced.	Balance the coupling.	-
	The bearings are defective.	Turn OFF the Servo System. Check for noise and vibration around the bearings.	Replace the Servomotor.	-
	There is a vibration source at the driven machine.	Turn OFF the Servo System. Check for any foreign matter, damage, or deformation in the machine's moving parts.	Consult with the machine manufacturer.	-
	Noise interference occurred because of incorrect I/O Signal Cable specifications.	Turn OFF the Servo System. Check the I/O Signal Cables to see if they satisfy specifications. Use shielded twisted-pair wire cables or screened twisted-pair cables with conductors of at least 0.12 mm ² .	Use cables that satisfy the specifications.	-
	Noise interference occurred because an I/O Signal Cable is too long.	Turn OFF the Servo System. Check the lengths of the I/O Signal Cables.	The I/O Signal Cables must be no longer than 3 m.	-
	Noise interference occurred because of incorrect Encoder Cable specifications.	Turn OFF the Servo System. Make sure that the rotary or Linear Encoder Cable satisfies the specifications. Use a shielded twisted-pair wire cable or a screened twisted-pair cable with a conductors of at least 0.12 mm ² .	Use cables that satisfy the specifications.	-
Noise interference occurred because the Encoder Cable is too long.	Turn OFF the Servo System. Check the length of the Encoder Cable.	<ul style="list-style-type: none"> Rotary Servomotors: The Encoder Cable length must be 50 m max. Linear Servomotors: Make sure that the Serial Converter Unit Cable is no longer than 20 m and that the Linear Encoder Cable and the Sensor Cable are no longer than 15 m each. 	-	

Continued on next page.

Continued from previous page.

Problem	Possible Cause	Confirmation	Correction	Reference
Abnormal Noise from Servomotor	Noise interference occurred because the Encoder Cable is damaged.	Turn OFF the Servo System. Check the Encoder Cable to see if it is pinched or the sheath is damaged.	Replace the Encoder Cable and correct the cable installation environment.	-
	The Encoder Cable was subjected to excessive noise interference.	Turn OFF the Servo System. Check to see if the Encoder Cable is bundled with a high-current line or installed near a high-current line.	Correct the cable layout so that no surge is applied by high-current lines.	-
	There is variation in the FG potential because of the influence of machines on the Servomotor side, such as a welder.	Turn OFF the Servo System. Check to see if the machines are correctly grounded.	Properly ground the machines to separate them from the FG of the encoder.	-
	There is a SERVOPACK pulse counting error due to noise.	Check to see if there is noise interference on the signal line from the encoder.	Turn OFF the Servo System. Implement countermeasures against noise for the encoder wiring.	-
	The encoder was subjected to excessive vibration or shock.	Turn OFF the Servo System. Check to see if vibration from the machine occurred. Check the Servomotor installation (mounting surface precision, securing state, and alignment). Check the linear encoder installation (mounting surface precision and securing method).	Reduce machine vibration. Improve the mounting state of the Servomotor or linear encoder.	-
	A failure occurred in the encoder.	-	Turn OFF the Servo System. Replace the Servomotor.	-
	A failure occurred in the Serial Converter Unit.	-	Turn OFF the Servo System. Replace the Serial Converter Unit.	-
Servomotor Vibrates at Frequency of Approx. 200 to 400 Hz.	A failure occurred in the linear encoder.	-	Turn OFF the Servo System. Replace the linear encoder.	-
	The servo gains are not balanced.	Check to see if the servo gains have been correctly tuned.	Perform autotuning without a host reference.	page 9-23
	The setting of Pn100 (2100h) (Speed Loop Gain) is too high.	Check the setting of Pn100 (2100h). The default setting is Kv = 40.0 Hz.	Set Pn100 (2100h) to an appropriate value.	-
	The setting of Pn102 (2102h) (Position Loop Gain) is too high.	Check the setting of Pn102 (2102h). The default setting is Kp = 40.0/s.	Set Pn102 (2102h) to an appropriate value.	-
	The setting of Pn101 (2101h) (Speed Loop Integral Time Constant) is not appropriate.	Check the setting of Pn101 (2101h). The default setting is Ti = 20.0 ms.	Set Pn101 (2101h) to an appropriate value.	-
	The setting of Pn103 (2103h) (Moment of Inertia Ratio or Mass Ratio) is not appropriate.	Check the setting of Pn103 (2103h).	Set Pn103 (2103h) to an appropriate value.	-

Continued on next page.

Continued from previous page.

Problem	Possible Cause	Confirmation	Correction	Reference
Large Motor Speed Overshoot on Starting and Stopping	The servo gains are not balanced.	Check to see if the servo gains have been correctly tuned.	Perform autotuning without a host reference.	page 9-23
	The setting of Pn100 (2100h) (Speed Loop Gain) is too high.	Check the setting of Pn100 (2100h). The default setting is $K_v = 40.0$ Hz.	Set Pn100 (2100h) to an appropriate value.	-
	The setting of Pn102 (2102h) (Position Loop Gain) is too high.	Check the setting of Pn102 (2102h). The default setting is $K_p = 40.0/s$.	Set Pn102 (2102h) to an appropriate value.	-
	The setting of Pn101 (2101h) (Speed Loop Integral Time Constant) is not appropriate.	Check the setting of Pn101 (2101h). The default setting is $T_i = 20.0$ ms.	Set Pn101 (2101h) to an appropriate value.	-
	The setting of Pn103 (2103h) (Moment of Inertia Ratio or Mass Ratio) is not appropriate.	Check the setting of Pn103 (2103h).	Set Pn103 (2103h) to an appropriate value.	-
	The torque reference is saturated.	Check the waveform of the torque reference.	Use the mode switch.	-
	The force limits (Pn483 (2483h) and Pn484 (2484h)) are set to the default values.	The default values of the force limits are Pn483 (2483h) = 30% and Pn484 (2484h) = 30%.	Set Pn483 (2483h) and Pn484 (2484h) to appropriate values.	page 7-26

Continued on next page.

Continued from previous page.

Problem	Possible Cause	Confirmation	Correction	Reference
Absolute Encoder Position Deviation Error (The position that was saved in the host controller when the power was turned OFF is different from the position when the power was next turned ON.)	Noise interference occurred because of incorrect Encoder Cable specifications.	Turn OFF the Servo System. Check the Encoder Cable to see if it satisfies specifications. Use a shielded twisted-pair cables or a screened twisted-pair cable with conductors of at least 0.12 mm ² .	Use cables that satisfy the specifications.	-
	Noise interference occurred because the Encoder Cable is too long.	Turn OFF the Servo System. Check the length of the Encoder Cable.	<ul style="list-style-type: none"> Rotary Servomotors: The Encoder Cable length must be 50 m max. Linear Servomotors: Make sure that the Serial Converter Unit Cable is no longer than 20 m and that the Linear Encoder Cable and the Sensor Cable are no longer than 15 m each. 	-
	Noise interference occurred because the Encoder Cable is damaged.	Turn OFF the Servo System. Check the Encoder Cable to see if it is pinched or the sheath is damaged.	Replace the Encoder Cable and correct the cable installation environment.	-
	The Encoder Cable was subjected to excessive noise interference.	Turn OFF the Servo System. Check to see if the Encoder Cable is bundled with a high-current line or installed near a high-current line.	Correct the cable layout so that no surge is applied by high-current lines.	-
	There is variation in the FG potential because of the influence of machines on the Servomotor side, such as a welder.	Turn OFF the Servo System. Check to see if the machines are correctly grounded.	Properly ground the machines to separate them from the FG of the encoder.	-
	There is a SERVOPACK pulse counting error due to noise.	Turn OFF the Servo System. Check to see if there is noise interference on the I/O signal line from the encoder or Serial Converter Unit.	Implement counter-measures against noise for the encoder or Serial Converter Unit wiring.	-

Continued on next page.

Continued from previous page.

Problem	Possible Cause	Confirmation	Correction	Reference
Absolute Encoder Position Deviation Error (The position that was saved in the host controller when the power was turned OFF is different from the position when the power was next turned ON.)	The encoder was subjected to excessive vibration or shock.	Turn OFF the Servo System. Check to see if vibration from the machine occurred. Check the Servomotor installation (mounting surface precision, securing state, and alignment). Check the linear encoder installation (mounting surface precision and securing method).	Reduce machine vibration. Improve the mounting state of the Servomotor or linear encoder.	-
	A failure occurred in the encoder.	-	Turn OFF the Servo System. Replace the Servomotor or linear encoder.	-
	A failure occurred in the SERVOPACK.	-	Turn OFF the Servo System. Replace the SERVOPACK.	-
	Host controller multiturn data or absolute encoder position data reading error	Check the error detection section of the host controller.	Correct the error detection section of the host controller.	-
		Check to see if the host controller is executing data parity checks.	Perform parity checks for the multiturn data or absolute encoder position data.	-
		Check for noise interference in the cable between the SERVOPACK and the host controller.	Implement countermeasures against noise and then perform parity checks again for the multiturn data or absolute encoder position data.	-

Continued on next page.

Continued from previous page.

Problem	Possible Cause	Confirmation	Correction	Reference
Overtravel Occurred	The P-OT/N-OT (Forward Drive Prohibit or Reverse Drive Prohibit) signal was input.	Check the external power supply (+24 V) voltage for the input signals.	Correct the external power supply (+24 V) voltage for the input signals.	-
		Check the operating condition of the overtravel limit switches.	Make sure that the overtravel limit switches operate correctly.	-
		Check the wiring of the overtravel limit switches.	Correct the wiring of the overtravel limit switches.	page 6-26
		Check the settings of the overtravel input signal allocations (Pn50A/ Pn50B).	Set the parameters to correct values.	page 6-26
	The P-OT/N-OT (Forward Drive Prohibit or Reverse Drive Prohibit) signal malfunctioned.	Check for fluctuation in the external power supply (+24 V) voltage for the input signals.	Eliminate fluctuation from the external power supply (+24 V) voltage for the input signals.	-
		Check to see if the operation of the overtravel limit switches is unstable.	Stabilize the operating condition of the overtravel limit switches.	-
		Check the wiring of the overtravel limit switches (e.g., check for cable damage and loose screws).	Correct the wiring of the overtravel limit switches.	-
	There is a mistake in the allocation of the P-OT or N-OT (Forward Drive Prohibit or Reverse Drive Prohibit) signal in Pn50A (250Ah) = n.X□□□ or Pn50B (250Bh) = n.□□□X.	Check to see if the P-OT signal is allocated in Pn50A (250Ah) = n.X□□□.	If another signal is allocated in Pn50A (250Ah) = n.X□□□, allocate the P-OT signal instead.	page 6-26
		Check to see if the N-OT signal is allocated in Pn50B (250Bh) = n.□□□X.	If another signal is allocated in Pn50B (250Bh) = n.□□□X, allocate the N-OT signal instead.	
	The selection of the Servomotor stopping method is not correct.	Check the servo OFF stopping method set in Pn001 (2001h) = n.□□□X or Pn001 (2001h) = n.□□X□.	Select a Servomotor stopping method other than coasting to a stop.	page 6-27
Check the torque control stopping method set in Pn001 (2001h) = n.□□□X or Pn001 (2001h) = n.□□X□.		Select a Servomotor stopping method other than coasting to a stop.		
Improper Stop Position for Overtravel (OT) Signal	The limit switch position and dog length are not appropriate.	-	Install the limit switch at the appropriate position.	-
	The overtravel limit switch position is too close for the coasting distance.	-	Install the overtravel limit switch at the appropriate position.	-

Continued on next page.

Continued from previous page.

Problem	Possible Cause	Confirmation	Correction	Reference
Position Deviation (without Alarm)	Noise interference occurred because of incorrect Encoder Cable specifications.	Turn OFF the Servo System. Check the Encoder Cable to see if it satisfies specifications. Use a shielded twisted-pair wire cable or a screened twisted-pair cable with conductors of at least 0.12 mm ² .	Use cables that satisfy the specifications.	-
	Noise interference occurred because the Encoder Cable is too long.	Turn OFF the Servo System. Check the length of the Encoder Cable.	<ul style="list-style-type: none"> Rotary Servomotors: The Encoder Cable length must be 50 m max. Linear Servomotors: Make sure that the Serial Converter Unit Cable is no longer than 20 m and that the Linear Encoder Cable and the Sensor Cable are no longer than 15 m each. 	-
	Noise interference occurred because the Encoder Cable is damaged.	Turn OFF the Servo System. Check the Encoder Cable to see if it is pinched or the sheath is damaged.	Replace the Encoder Cable and correct the cable installation environment.	-
	The Encoder Cable was subjected to excessive noise interference.	Turn OFF the Servo System. Check to see if the Encoder Cable is bundled with a high-current line or installed near a high-current line.	Correct the cable layout so that no surge is applied by high-current lines.	-
	There is variation in the FG potential because of the influence of machines on the Servomotor side, such as a welder.	Turn OFF the Servo System. Check to see if the machines are correctly grounded.	Properly ground the machines to separate them from the FG of the encoder.	-
	There is a SERVOPACK pulse counting error due to noise.	Turn OFF the Servo System. Check to see if there is noise interference on the I/O signal line from the encoder or Serial Converter Unit.	Implement countermeasures against noise for the encoder wiring or Serial Converter Unit wiring.	-

Continued on next page.

Continued from previous page.

Problem	Possible Cause	Confirmation	Correction	Reference
Position Deviation (without Alarm)	The encoder was subjected to excessive vibration or shock.	Turn OFF the Servo System. Check to see if vibration from the machine occurred. Check the Servomotor installation (mounting surface precision, securing state, and alignment). Check the linear encoder installation (mounting surface precision and securing method).	Reduce machine vibration. Improve the mounting state of the Servomotor or linear encoder.	-
	The coupling between the machine and Servomotor is not suitable.	Turn OFF the Servo System. Check to see if position offset occurs at the coupling between machine and Servomotor.	Correctly secure the coupling between the machine and Servomotor.	-
	Noise interference occurred because of incorrect I/O Signal Cable specifications.	Turn OFF the Servo System. Check the I/O Signal Cables to see if they satisfy specifications. Use a shielded twisted-pair cables or a screened twisted-pair cable with conductors of at least 0.12 mm ² .	Use cables that satisfy the specifications.	-
	Noise interference occurred because an I/O Signal Cable is too long.	Turn OFF the Servo System. Check the lengths of the I/O Signal Cables.	The I/O Signal Cables must be no longer than 3 m.	-
	An encoder fault occurred. (The pulse count does not change.)	-	Turn OFF the Servo System. Replace the Servomotor or linear encoder.	-
	A failure occurred in the SERVOPACK.	-	Turn OFF the Servo System. Replace the SERVOPACK.	-
Servomotor Overheated	The surrounding air temperature is too high.	Measure the surrounding air temperature around the Servomotor.	Reduce the surrounding air temperature to 40°C or less.	-
	The surface of the Servomotor is dirty.	Turn OFF the Servo System. Visually check the surface for dirt.	Clean dirt, dust, and oil from the surface.	-
	There is an overload on the Servomotor.	Check the load status with a monitor.	If the Servomotor is overloaded, reduce the load or replace the Servo Drive with a SERVOPACK and Servomotor with larger capacities.	-
	Polarity detection was not performed correctly.	Check to see if electrical angle 2 (electrical angle from polarity origin) at any position is between ±10°.	Correct the settings for the polarity detection-related parameters.	-

Parameter and Object Lists

17

This chapter provides information on parameters and objects.

17.1	List of Parameters	17-2
17.1.1	Interpreting the Parameter Lists	17-2
17.1.2	List of Parameters	17-3
17.2	Object List	17-33
17.3	SDO Abort Code List	17-42
17.4	Parameter Recording Table	17-43

17.1 List of Parameters

17.1.1 Interpreting the Parameter Lists

The types of motors to which the parameter applies.

- All: The parameter is used for both Rotary Servomotors and Linear Servomotors.
- Rotary: The parameter is used for only Rotary Servomotors.
- Linear: The parameter is used for only Linear Servomotors.

Rotary Servomotor terms are used for parameters that are applicable to all Servomotors. If you are using a Linear Servomotor, you need to interpret the terms accordingly. Refer to the following section for details.

Differences in Terms for Rotary Servomotors and Linear Servomotors on page vi

Indicates when a change to the parameter will be effective.

Parameter No.	Size	Name	Setting Range	Setting Unit	Default Setting	Applicable Motors	When Enabled	Classification	Reference												
Pn000 (2000h)	2	Basic Function Selections 0	0000h to 10B1h	-	0000h	All	After restart	Setup	-												
			<p>If there are differences in the parameters for Rotary Servomotor and Linear Servomotor, information is provided for both.</p> <ul style="list-style-type: none"> • Top row: For Rotary Servomotors • Bottom row: For Linear Servomotors 																		
			<p>There are the following two classifications.</p> <ul style="list-style-type: none"> • Setup • Tuning <p>Refer to the following section for details.</p> <p> 6.1.1 Classifications of SERVOPACK Parameters on page 6-3</p>																		
			<table border="1"> <thead> <tr> <th colspan="2">Rotation Direction Selection</th> <th>Reference</th> </tr> <tr> <th colspan="2">Movement Direction Selection</th> <th></th> </tr> </thead> <tbody> <tr> <td rowspan="2">n.□□□X</td> <td>0</td> <td>Use CCW as the forward direction. Use the direction in which the linear encoder counts up as the forward direction.</td> <td rowspan="4">page 6-14</td> </tr> <tr> <td rowspan="2">1</td> <td>Use CW as the forward direction. (Reverse Rotation Mode) Use the direction in which the linear encoder counts down as the forward direction. (Reverse Movement Mode)</td> </tr> </tbody> </table>							Rotation Direction Selection		Reference	Movement Direction Selection			n.□□□X	0	Use CCW as the forward direction. Use the direction in which the linear encoder counts up as the forward direction.	page 6-14	1	Use CW as the forward direction. (Reverse Rotation Mode) Use the direction in which the linear encoder counts down as the forward direction. (Reverse Movement Mode)
	Rotation Direction Selection		Reference																		
	Movement Direction Selection																				
	n.□□□X	0	Use CCW as the forward direction. Use the direction in which the linear encoder counts up as the forward direction.	page 6-14																	
		1	Use CW as the forward direction. (Reverse Rotation Mode) Use the direction in which the linear encoder counts down as the forward direction. (Reverse Movement Mode)																		
	n.□□X□		Reserved parameter (Do not change.)																		
	n.□X□□		Reserved parameter (Do not change.)																		
		<table border="1"> <thead> <tr> <th colspan="2">Rotary/Linear Servomotor Startup Selection When Encoder Is Not Connected</th> <th>Reference</th> </tr> </thead> <tbody> <tr> <td rowspan="2">n.X□□□</td> <td>0</td> <td>When an encoder is not connected, start as SERVOPACK for Rotary Servomotor.</td> <td rowspan="2">page 6-13</td> </tr> <tr> <td>1</td> <td>When an encoder is not connected, start as SERVOPACK for Linear Servomotor.</td> </tr> </tbody> </table>							Rotary/Linear Servomotor Startup Selection When Encoder Is Not Connected		Reference	n.X□□□	0	When an encoder is not connected, start as SERVOPACK for Rotary Servomotor.	page 6-13	1	When an encoder is not connected, start as SERVOPACK for Linear Servomotor.				
Rotary/Linear Servomotor Startup Selection When Encoder Is Not Connected		Reference																			
n.X□□□	0	When an encoder is not connected, start as SERVOPACK for Rotary Servomotor.	page 6-13																		
	1	When an encoder is not connected, start as SERVOPACK for Linear Servomotor.																			

17.1.2 List of Parameters

The following table lists the parameters.

Note: Do not change the following parameters from their default settings.

- Reserved parameters
- Parameters not given in this manual
- Parameters that are not valid for the Servomotor that you are using, as given in the parameter table

Parameter No.	Size	Name	Setting Range	Setting Unit	Default Setting	Applicable Motors	When Enabled	Classification	Reference	
Pn000 (2000h)	2	Basic Function Selections 0	0000h to 10B1h	-	0000h	All	After restart	Setup	-	
	n.□□□X	Rotation Direction Selection							Reference	page 6-14
		Movement Direction Selection								
		0	Use CCW as the forward direction.					Use the direction in which the linear encoder counts up as the forward direction.		
		1	Use CW as the forward direction. (Reverse Rotation Mode)							
	Use the direction in which the linear encoder counts down as the forward direction. (Reverse Movement Mode)									
	n.□□X□	Reserved parameter (Do not change.)								
	n.□X□□	Reserved parameter (Do not change.)								
	n.X□□□	Rotary/Linear Servomotor Startup Selection When Encoder Is Not Connected							Reference	page 6-13
		0	When an encoder is not connected, start as SERVOPACK for Rotary Servomotor.							
1	When an encoder is not connected, start as SERVOPACK for Linear Servomotor.									
Pn001 (2001h)	2	Application Function Selections 1	0000h to 1142h	-	0000h	All	After restart	Setup	-	
	n.□□□X	Motor Stopping Method for Servo OFF and Group 1 Alarms							Reference	page 6-37
		0	Stop the motor by applying the dynamic brake.							
		1	Stop the motor by the applying dynamic brake and then release the dynamic brake.							
	2	Coast the motor to a stop without the dynamic brake.								
	n.□□X□	Overtravel Stopping Method							Reference	page 6-27
		0	Apply the dynamic brake or coast the motor to a stop (use the stopping method set in Pn001 (2001h) = n.□□□X).							
		1	Decelerate the motor to a stop using the torque set in Pn406 as the maximum torque and then servo-lock the motor.							
		2	Decelerate the motor to a stop using the torque set in Pn406 as the maximum torque and then let the motor coast.							
		3	Decelerate the motor to a stop using the deceleration time set in Pn30A and then servo-lock the motor.							
4	Decelerate the motor to a stop using the deceleration time set in Pn30A and then let the motor coast.									
n.□X□□	Main Circuit Power Supply AC/DC Input Selection							Reference	page 6-12	
	0	Input AC power as the main circuit power supply using the L1, L2, and L3 terminals (do not use shared converter).								
1	Input DC power as the main circuit power supply using the B1 and ⊖ 2 terminals (use an external converter or the shared converter).									
n.X□□□	Reserved parameter (Do not change.)									

Continued on next page.

17.1 List of Parameters

17.1.2 List of Parameters

Continued from previous page.

Parameter No.	Size	Name	Setting Range	Setting Unit	Default Setting	Applicable Motors	When Enabled	Classification	Reference																			
Pn002 (2002h)	2	Application Function Selections 2	0000h to 4213h	-	0001h	-	After restart	Setup	-																			
	<table border="1"> <thead> <tr> <th colspan="3">EtherCAT (CoE) Module Torque Limit Command Usage Selection</th> <th>Applicable Motors</th> <th>Reference</th> </tr> </thead> <tbody> <tr> <td rowspan="4">n.□□□X</td> <td>0</td> <td>Reserved setting (Do not use.)</td> <td rowspan="4">All</td> <td rowspan="4">-</td> </tr> <tr> <td>1</td> <td>Enable torque limit commands from EtherCAT (CoE). (Automatically set by the EtherCAT (CoE) Module.)</td> </tr> <tr> <td>2</td> <td>Reserved setting (Do not use.)</td> </tr> <tr> <td>3</td> <td>Reserved setting (Do not use.)</td> </tr> </tbody> </table>										EtherCAT (CoE) Module Torque Limit Command Usage Selection			Applicable Motors	Reference	n.□□□X	0	Reserved setting (Do not use.)	All	-	1	Enable torque limit commands from EtherCAT (CoE). (Automatically set by the EtherCAT (CoE) Module.)	2	Reserved setting (Do not use.)	3	Reserved setting (Do not use.)		
	EtherCAT (CoE) Module Torque Limit Command Usage Selection			Applicable Motors	Reference																							
	n.□□□X	0	Reserved setting (Do not use.)	All	-																							
		1	Enable torque limit commands from EtherCAT (CoE). (Automatically set by the EtherCAT (CoE) Module.)																									
		2	Reserved setting (Do not use.)																									
		3	Reserved setting (Do not use.)																									
	<table border="1"> <thead> <tr> <th colspan="3">EtherCAT (CoE) Module Speed Limit Command Usage Selection</th> <th>Applicable Motors</th> <th>Reference</th> </tr> </thead> <tbody> <tr> <td rowspan="2">n.□□X□</td> <td>0</td> <td>Disable speed limit commands from EtherCAT (CoE) during torque control.</td> <td rowspan="2">All</td> <td rowspan="2">-</td> </tr> <tr> <td>1</td> <td>Reserved setting (Do not use.)</td> </tr> </tbody> </table>										EtherCAT (CoE) Module Speed Limit Command Usage Selection			Applicable Motors	Reference	n.□□X□	0	Disable speed limit commands from EtherCAT (CoE) during torque control.	All	-	1	Reserved setting (Do not use.)						
	EtherCAT (CoE) Module Speed Limit Command Usage Selection			Applicable Motors	Reference																							
	n.□□X□	0	Disable speed limit commands from EtherCAT (CoE) during torque control.	All	-																							
		1	Reserved setting (Do not use.)																									
	<table border="1"> <thead> <tr> <th colspan="3">Encoder Usage</th> <th>Applicable Motors</th> <th>Reference</th> </tr> </thead> <tbody> <tr> <td rowspan="3">n.□X□□</td> <td>0</td> <td>Use the encoder according to encoder specifications.</td> <td rowspan="2">All</td> <td rowspan="3">page 7-31</td> </tr> <tr> <td>1</td> <td>Use the encoder as an incremental encoder.</td> </tr> <tr> <td>2</td> <td>Use the encoder as a single-turn absolute encoder.</td> <td>Rotary</td> </tr> </tbody> </table>										Encoder Usage			Applicable Motors	Reference	n.□X□□	0	Use the encoder according to encoder specifications.	All	page 7-31	1	Use the encoder as an incremental encoder.	2	Use the encoder as a single-turn absolute encoder.	Rotary			
	Encoder Usage			Applicable Motors	Reference																							
	n.□X□□	0	Use the encoder according to encoder specifications.	All	page 7-31																							
		1	Use the encoder as an incremental encoder.																									
		2	Use the encoder as a single-turn absolute encoder.	Rotary																								
	<table border="1"> <thead> <tr> <th colspan="3">External Encoder Usage</th> <th>Applicable Motors</th> <th>Reference</th> </tr> </thead> <tbody> <tr> <td rowspan="5">n.X□□□</td> <td>0</td> <td>Do not use an external encoder.</td> <td rowspan="5">Rotary</td> <td rowspan="5">page 11-6</td> </tr> <tr> <td>1</td> <td>The external encoder moves in the forward direction for CCW motor rotation.</td> </tr> <tr> <td>2</td> <td>Reserved setting (Do not use.)</td> </tr> <tr> <td>3</td> <td>The external encoder moves in the reverse direction for CCW motor rotation.</td> </tr> <tr> <td>4</td> <td>Reserved setting (Do not use.)</td> </tr> </tbody> </table>										External Encoder Usage			Applicable Motors	Reference	n.X□□□	0	Do not use an external encoder.	Rotary	page 11-6	1	The external encoder moves in the forward direction for CCW motor rotation.	2	Reserved setting (Do not use.)	3	The external encoder moves in the reverse direction for CCW motor rotation.	4	Reserved setting (Do not use.)
	External Encoder Usage			Applicable Motors	Reference																							
	n.X□□□	0	Do not use an external encoder.	Rotary	page 11-6																							
		1	The external encoder moves in the forward direction for CCW motor rotation.																									
2		Reserved setting (Do not use.)																										
3		The external encoder moves in the reverse direction for CCW motor rotation.																										
4		Reserved setting (Do not use.)																										

Continued on next page.

Continued from previous page.

Parameter No.	Size	Name	Setting Range	Setting Unit	Default Setting	Applicable Motors	When Enabled	Classification	Reference																																																			
Pn006 (2006h)	2	Application Function Selections 6	0000h to 105Fh	–	0002h	All	Immediately	Setup	page 10-10																																																			
		<table border="1"> <thead> <tr> <th colspan="2">Analog Monitor 1 Signal Selection</th> </tr> </thead> <tbody> <tr> <td rowspan="2">00</td> <td>Motor speed (1 V/1,000 min⁻¹)</td> </tr> <tr> <td>Motor speed (1 V/1,000 mm/s)</td> </tr> <tr> <td rowspan="2">01</td> <td>Speed reference (1 V/1,000 min⁻¹)</td> </tr> <tr> <td>Speed reference (1 V/1,000 mm/s)</td> </tr> <tr> <td rowspan="2">02</td> <td>Torque reference (1 V/100% rated torque)</td> </tr> <tr> <td>Force reference (1 V/100% rated force)</td> </tr> <tr> <td>03</td> <td>Position deviation (0.05 V/reference unit)</td> </tr> <tr> <td rowspan="2">04</td> <td>Position amplifier deviation (after electronic gear) (0.05 V/encoder pulse unit)</td> </tr> <tr> <td>Position amplifier deviation (after electronic gear) (0.05 V/linear encoder pulse unit)</td> </tr> <tr> <td rowspan="2">05</td> <td>Position reference speed (1 V/1,000 min⁻¹)</td> </tr> <tr> <td>Position reference speed (1 V/1,000 mm/s)</td> </tr> <tr> <td>06</td> <td>Reserved setting (Do not use.)</td> </tr> <tr> <td>07</td> <td>Load-motor position deviation (0.01 V/reference unit)</td> </tr> <tr> <td>08</td> <td>Positioning completion (positioning completed: 5 V, positioning not completed: 0 V)</td> </tr> <tr> <td rowspan="2">09</td> <td>Speed feedforward (1 V/1,000 min⁻¹)</td> </tr> <tr> <td>Speed feedforward (1 V/1,000 mm/s)</td> </tr> <tr> <td rowspan="2">0A</td> <td>Torque feedforward (1 V/100% rated torque)</td> </tr> <tr> <td>Force feedforward (1 V/100% rated force)</td> </tr> <tr> <td>0B</td> <td>Active gain (1st gain: 1 V, 2nd gain: 2 V)</td> </tr> <tr> <td>0C</td> <td>Completion of position reference distribution (completed: 5 V, not completed: 0 V)</td> </tr> <tr> <td>0D</td> <td>External encoder speed (1 V/1,000 min⁻¹; value at the motor shaft)</td> </tr> <tr> <td>0E</td> <td>Reserved setting (Do not use.)</td> </tr> <tr> <td>0F</td> <td>Reserved setting (Do not use.)</td> </tr> <tr> <td>10</td> <td>Main circuit DC voltage</td> </tr> <tr> <td>11 to 5F</td> <td>Reserved settings (Do not use.)</td> </tr> <tr> <td>n.□□□□</td> <td colspan="2">Reserved parameter (Do not change.)</td> </tr> <tr> <td>n.X□□□</td> <td colspan="2">Reserved parameter (Do not change.)</td> </tr> </tbody> </table>								Analog Monitor 1 Signal Selection		00	Motor speed (1 V/1,000 min ⁻¹)	Motor speed (1 V/1,000 mm/s)	01	Speed reference (1 V/1,000 min ⁻¹)	Speed reference (1 V/1,000 mm/s)	02	Torque reference (1 V/100% rated torque)	Force reference (1 V/100% rated force)	03	Position deviation (0.05 V/reference unit)	04	Position amplifier deviation (after electronic gear) (0.05 V/encoder pulse unit)	Position amplifier deviation (after electronic gear) (0.05 V/linear encoder pulse unit)	05	Position reference speed (1 V/1,000 min ⁻¹)	Position reference speed (1 V/1,000 mm/s)	06	Reserved setting (Do not use.)	07	Load-motor position deviation (0.01 V/reference unit)	08	Positioning completion (positioning completed: 5 V, positioning not completed: 0 V)	09	Speed feedforward (1 V/1,000 min ⁻¹)	Speed feedforward (1 V/1,000 mm/s)	0A	Torque feedforward (1 V/100% rated torque)	Force feedforward (1 V/100% rated force)	0B	Active gain (1st gain: 1 V, 2nd gain: 2 V)	0C	Completion of position reference distribution (completed: 5 V, not completed: 0 V)	0D	External encoder speed (1 V/1,000 min ⁻¹ ; value at the motor shaft)	0E	Reserved setting (Do not use.)	0F	Reserved setting (Do not use.)	10	Main circuit DC voltage	11 to 5F	Reserved settings (Do not use.)	n.□□□□	Reserved parameter (Do not change.)		n.X□□□	Reserved parameter (Do not change.)	
	Analog Monitor 1 Signal Selection																																																											
	00	Motor speed (1 V/1,000 min ⁻¹)																																																										
		Motor speed (1 V/1,000 mm/s)																																																										
	01	Speed reference (1 V/1,000 min ⁻¹)																																																										
		Speed reference (1 V/1,000 mm/s)																																																										
	02	Torque reference (1 V/100% rated torque)																																																										
		Force reference (1 V/100% rated force)																																																										
	03	Position deviation (0.05 V/reference unit)																																																										
	04	Position amplifier deviation (after electronic gear) (0.05 V/encoder pulse unit)																																																										
		Position amplifier deviation (after electronic gear) (0.05 V/linear encoder pulse unit)																																																										
	05	Position reference speed (1 V/1,000 min ⁻¹)																																																										
		Position reference speed (1 V/1,000 mm/s)																																																										
	06	Reserved setting (Do not use.)																																																										
	07	Load-motor position deviation (0.01 V/reference unit)																																																										
	08	Positioning completion (positioning completed: 5 V, positioning not completed: 0 V)																																																										
	09	Speed feedforward (1 V/1,000 min ⁻¹)																																																										
		Speed feedforward (1 V/1,000 mm/s)																																																										
	0A	Torque feedforward (1 V/100% rated torque)																																																										
		Force feedforward (1 V/100% rated force)																																																										
	0B	Active gain (1st gain: 1 V, 2nd gain: 2 V)																																																										
	0C	Completion of position reference distribution (completed: 5 V, not completed: 0 V)																																																										
	0D	External encoder speed (1 V/1,000 min ⁻¹ ; value at the motor shaft)																																																										
	0E	Reserved setting (Do not use.)																																																										
	0F	Reserved setting (Do not use.)																																																										
	10	Main circuit DC voltage																																																										
	11 to 5F	Reserved settings (Do not use.)																																																										
	n.□□□□	Reserved parameter (Do not change.)																																																										
n.X□□□	Reserved parameter (Do not change.)																																																											

Continued on next page.

Continued from previous page.

Parameter No.	Size	Name	Setting Range	Setting Unit	Default Setting	Applicable Motors	When Enabled	Classification	Reference	
Pn007 (2007h)	2	Application Function Selections 7	0000h to 105Fh	-	0000h	All	Immediately	Setup	page 10-10	
	n.□□XX	Analog Monitor 2 Signal Selection								
		00	Motor speed (1 V/1,000 min ⁻¹) Motor speed (1 V/1,000 mm/s)							
		01	Speed reference (1 V/1,000 min ⁻¹) Speed reference (1 V/1,000 mm/s)							
		02	Torque reference (1 V/100% rated torque) Force reference (1 V/100% rated force)							
		03	Position deviation (0.05 V/reference unit)							
		04	Position amplifier deviation (after electronic gear) (0.05 V/encoder pulse unit)							
			Position amplifier deviation (after electronic gear) (0.05 V/linear encoder pulse unit)							
		05	Position reference speed (1 V/1,000 min ⁻¹)							
			Position reference speed (1 V/1,000 mm/s)							
		06	Reserved setting (Do not use.)							
		07	Load-motor position deviation (0.01 V/reference unit)							
		08	Positioning completion (positioning completed: 5 V, positioning not completed: 0 V)							
		09	Speed feedforward (1 V/1,000 min ⁻¹)							
			Speed feedforward (1 V/1,000 mm/s)							
		0A	Torque feedforward (1 V/100% rated torque)							
			Force feedforward (1 V/100% rated force)							
		0B	Active gain (1st gain: 1 V, 2nd gain: 2 V)							
		0C	Completion of position reference distribution (completed: 5 V, not completed: 0 V)							
		0D	External encoder speed (1 V/1,000 min ⁻¹ : value at the motor shaft)							
		0E	Reserved setting (Do not use.)							
		0F	Reserved setting (Do not use.)							
		10	Main circuit DC voltage							
		11 to 5F	Reserved settings (Do not use.)							
		n.□□□□	Reserved parameter (Do not change.)							
		n.X□□□	Reserved parameter (Do not change.)							

Continued on next page.

Continued from previous page.

Parameter No.	Size	Name	Setting Range	Setting Unit	Default Setting	Applicable Motors	When Enabled	Classification	Reference	
Pn008 (2008h)	2	Application Function Selections 8	0000h to 7121h	–	4000h	Rotary	After restart	Setup	–	
	n.□□□X	Low Battery Voltage Alarm/Warning Selection							Reference	
		0	Output alarm (A.830) for low battery voltage.							page 16-2
	1	Output warning (A.930) for low battery voltage.								
	n.□□X□	Function Selection for Undervoltage							Reference	
		0	Do not detect undervoltage.							page 7-15
		1	Detect undervoltage warning and limit torque at host controller.							
	2	Detect undervoltage warning and limit torque with Pn424 (2424h) and Pn425 (2425h) (i.e., only in the SERVOPACK).								
	n.□X□□	Warning Detection Selection							Reference	
		0	Detect warnings.							page 16-48
1	Do not detect warnings except for A.971.									
n.X□□□	Reserved parameter (Do not change.)									
Pn009 (2009h)	2	Application Function Selections 9	0000h to 0121h	–	0010h	All	After restart	Tuning	–	
	n.□□□X	Reserved parameter (Do not change.)								
	n.□□X□	Current Control Mode Selection							Reference	
		0	Use current control mode 1.							page 9-70
		1	Use current control mode 2.							
	2	Reserved setting (Do not use.)								
	n.□X□□	Speed Detection Method Selection							Reference	
		0	Use speed detection 1.							page 9-71
	1	Use speed detection 2.								
	n.X□□□	Reserved parameter (Do not change.)								

Continued on next page.

17.1 List of Parameters

17.1.2 List of Parameters

Continued from previous page.

Parameter No.	Size	Name	Setting Range	Setting Unit	Default Setting	Applicable Motors	When Enabled	Classification	Reference	
Pn00A (200Ah)	2	Application Function Selections A	0000h to 1244h	-	0001h	All	After restart	Setup	-	
			Motor Stopping Method for Group 2 Alarms							Reference
	n.□□□X		0	Apply the dynamic brake or coast the motor to a stop (use the stopping method set in Pn001 (2001h) = n.□□□X).						page 6-38
			1	Decelerate the motor to a stop using the torque set in Pn406 (2406h) as the maximum torque. Use the setting of Pn001 (2001h) = n.□□□X for the status after stopping.						
			2	Decelerate the motor to a stop using the torque set in Pn406 (2406h) as the maximum torque and then let the motor coast.						
			3	Decelerate the motor to a stop using the deceleration time set in Pn30A (230Ah). Use the setting of Pn001 (2001h) = n.□□□X for the status after stopping.						
			4	Decelerate the motor to a stop using the deceleration time set in Pn30A (230Ah) and then let the motor coast.						
			Stopping Method for Forced Stops							Reference
	n.□□□□		0	Apply the dynamic brake or coast the motor to a stop (use the stopping method set in Pn001 (2001h) = n.□□□X).						page 7-55
			1	Decelerate the motor to a stop using the torque set in Pn406 (2406h) as the maximum torque. Use the setting of Pn001 (2001h) = n.□□□X for the status after stopping.						
			2	Decelerate the motor to a stop using the torque set in Pn406 (2406h) as the maximum torque and then let the motor coast.						
			3	Decelerate the motor to a stop using the deceleration time set in Pn30A (230Ah). Use the setting of Pn001 (2001h) = n.□□□X for the status after stopping.						
			4	Decelerate the motor to a stop using the deceleration time set in Pn30A (230Ah) and then let the motor coast.						
	n.□X□□		Reserved parameter (Do not change.)							
n.X□□□		Reserved parameter (Do not change.)								
Pn00B (200Bh)	2	Application Function Selections B	0000h to 1121h	-	0000h	All	After restart	Setup	-	
	n.□□□X		Operator Parameter Display Selection							Reference
			0	Display only setup parameters.						page 6-3
			1	Display all parameters.						
	n.□□□□		Motor Stopping Method for Group 2 Alarms							Reference
			0	Stop the motor by setting the speed reference to 0.						page 6-38
			1	Apply the dynamic brake or coast the motor to a stop (use the stopping method set in Pn001 (2001h) = n.□□□X).						
			2	Set the stopping method with Pn00A (200Ah) = n.□□□X.						
	n.□X□□		Reserved parameter (Do not change.)							
	n.X□□□		Reserved parameter (Do not change.)							

Continued on next page.

Continued from previous page.

Parameter No.	Size	Name	Setting Range	Setting Unit	Default Setting	Applicable Motors	When Enabled	Classification	Reference		
Pn00C (200Ch)	2	Application Function Selections C	0000h to 0131h	-	0000h	-	After restart	Setup	page 8-21		
	n.□□□X		Function Selection for Test without a Motor						Applicable Motors		
			0	Disable tests without a motor.						All	
			1	Enable tests without a motor.							
	n.□□□□		Encoder Resolution for Tests without a Motor						Applicable Motors		
			0	Use 13 bits.						Rotary	
			1	Use 20 bits.							
			2	Use 22 bits.							
			3	Use 24 bits.							
	n.□X□□		Encoder Type Selection for Tests without a Motor						Applicable Motors		
		0	Use an incremental encoder.						All		
		1	Use an absolute encoder.								
n.X□□□		Reserved parameter (Do not change.)									
Pn00D (200Dh)	2	Application Function Selections D	0000h to 1001h	-	0000h	All	Immediately	Setup	page 6-29		
	n.□□□X		Reserved parameter (Do not change.)								
	n.□□X□		Reserved parameter (Do not change.)								
	n.□X□□		Reserved parameter (Do not change.)								
	n.X□□□		Overtravel Warning Detection Selection								
			0	Do not detect overtravel warnings.							
		1	Detect overtravel warnings.								
Pn00F (200Fh)	2	Application Function Selections F	0000h to 2011h	-	0000h	All	After restart	Setup	-		
	n.□□□X		Preventative Maintenance Warning Selection						Reference		
			0	Do not detect preventative maintenance warnings.						page 10-15	
			1	Detect preventative maintenance warnings.							
	n.□□X□		Reserved parameter (Do not change.)								
	n.□X□□		Reserved parameter (Do not change.)								
	n.X□□□		Reserved parameter (Do not change.)								
Pn021 (2021h)	2	Reserved parameter (Do not change.)	-	-	0000h	All	-	-	-		

Continued on next page.

17.1 List of Parameters

17.1.2 List of Parameters

Continued from previous page.

Parameter No.	Size	Name	Setting Range	Setting Unit	Default Setting	Applicable Motors	When Enabled	Classification	Reference	
Pn022 (2022h)	2	Application Function Selections 22	0000h to 0011h	–	0000h	All	After restart	Setup	–	
	n.□□□X	Overtravel Release Method Selection							Reference	
		0	Overtravel exists while the P-OT or N-OT signal is being input.							page 6-30
	1	Overtravel exists while the P-OT or N-OT signal is input and the current position of the workpiece is separated from the P-OT signal or N-OT signal.								
	n.□□□□	Reserved parameter (Do not change.)								
	n.□X□□	Reserved parameter (Do not change.)								
n.X□□□	Reserved parameter (Do not change.)									
Pn023 (2023h)	2	Application Function Selections 23	0000h to 0011h	–	0000h	All	After restart	Setup	–	
	n.□□□X	Built-in Brake Relay Usage Selection							Reference	
		0	Use the built-in brake relay.							page 6-36
	1	Do not use the built-in brake relay.								
	n.□□□□	Built-in Brake Relay Life Alarm Enable Selection							Reference	
		0	Detect built-in brake relay life alarm.							page 10-15
1	Do not detect built-in brake relay life alarm.									
n.□X□□	Reserved parameter (Do not change.)									
n.X□□□	Reserved parameter (Do not change.)									
Pn040 (2040h)	2	Reserved parameter (Do not change.)	0000h to 2111h	–	0000h	–	–	–	–	
Pn080 (2080h)	2	Application Function Selections 80	0000h to 1111h	–	0000h	Linear	After restart	Setup	–	
	n.□□□X	Polarity Sensor Selection							Reference	
		0	Use polarity sensor.							page 6-22
	1	Do not use polarity sensor.								
	n.□□□□	Motor Phase Sequence Selection							Reference	
		0	Set a phase-A lead as a phase sequence of U, V, and W.							page 6-20
1	Set a phase-B lead as a phase sequence of U, V, and W.									
n.□X□□	Reserved parameter (Do not change.)									
n.X□□□	Calculation Method for Maximum Speed or Encoder Output Pulses							Reference		
	0	Calculate the encoder output pulse setting for a fixed maximum speed.							page 18-5	
1	Calculate the maximum speed for a fixed encoder output pulse setting.									

Continued on next page.

Continued from previous page.

Parameter No.	Size	Name	Setting Range	Setting Unit	Default Setting	Applicable Motors	When Enabled	Classification	Reference	
Pn081 (2081h)	2	Application Function Selections 81	0000h to 1111h	-	0000h	All	After restart	Setup	page 7-18	
	n.□□□X		Phase-C Pulse Output Selection							
			0	Output phase-C pulses only in the forward direction.						
			1	Output phase-C pulses in both the forward and reverse directions.						
	n.□□X□		Reserved parameter (Do not change.)							
	n.□X□□		Reserved parameter (Do not change.)							
n.X□□□		Reserved parameter (Do not change.)								
Pn100 (2100h)	2	Speed Loop Gain	10 to 20,000	0.1 Hz	400	All	Immediately	Tuning	page 9-77	
Pn101 (2101h)	2	Speed Loop Integral Time Constant	15 to 51,200	0.01 ms	2000	All	Immediately	Tuning	page 9-77	
Pn102 (2102h)	2	Position Loop Gain	10 to 20,000	0.1/s	400	All	Immediately	Tuning	page 9-77	
Pn103 (2103h)	2	Moment of Inertia Ratio	0 to 20,000	1%	100	All	Immediately	Tuning	page 9-77	
Pn104 (2104h)	2	Second Speed Loop Gain	10 to 20,000	0.1 Hz	400	All	Immediately	Tuning	page 9-65	
Pn105 (2105h)	2	Second Speed Loop Integral Time Constant	15 to 51,200	0.01 ms	2000	All	Immediately	Tuning	page 9-65	
Pn106 (2106h)	2	Second Position Loop Gain	10 to 20,000	0.1/s	400	All	Immediately	Tuning	page 9-65	
Pn109 (2109h)	2	Feedforward	0 to 100	1%	0	All	Immediately	Tuning	page 9-87	
Pn10A (210Ah)	2	Feedforward Filter Time Constant	0 to 6,400	0.01 ms	0	All	Immediately	Tuning	page 9-87	
Pn10B (210Bh)	2	Gain Application Selections	0000h to 5334h	-	0000h	All	-	Setup	-	
	n.□□□X		Mode Switching Selection				When Enabled	Reference		
			0	Use the internal torque reference as the condition (level setting: Pn10C (210Ch)).				Immediately	page 9-88	
			1	Use the speed reference as the condition (level setting: Pn10D (210Dh)).						
				Use the speed reference as the condition (level setting: Pn181 (2181h)).						
			2	Use the acceleration reference as the condition (level setting: Pn10E (210Eh)).						
				Use the acceleration reference as the condition (level setting: Pn182 (2182h)).						
			3	Use the position deviation as the condition (level setting: Pn10F (210Fh)).						
			4	Do not use mode switching.						
	n.□□X□		Speed Loop Control Method				When Enabled	Reference		
		0	PI control				After restart	page 9-77		
		1	I-P control							
		2 and 3	Reserved settings (Do not use.)							
n.□X□□		Reserved parameter (Do not change.)								
n.X□□□		Reserved parameter (Do not change.)								

Continued on next page.

17.1 List of Parameters

17.1.2 List of Parameters

Continued from previous page.

Parameter No.	Size	Name	Setting Range	Setting Unit	Default Setting	Applicable Motors	When Enabled	Classification	Reference															
Pn10C (210Ch)	2	Mode Switching Level for Torque Reference	0 to 800	1%	200	All	Immediately	Tuning	page 9-88															
Pn10D (210Dh)	2	Mode Switching Level for Speed Reference	0 to 10,000	1 min ⁻¹	0	Rotary	Immediately	Tuning	page 9-88															
Pn10E (210Eh)	2	Mode Switching Level for Acceleration	0 to 30,000	1 min ⁻¹ /s	0	Rotary	Immediately	Tuning	page 9-88															
Pn10F (210Fh)	2	Mode Switching Level for Position Deviation	0 to 10,000	1 reference unit	0	All	Immediately	Tuning	page 9-88															
Pn11F (211Fh)	2	Position Integral Time Constant	0 to 50,000	0.1 ms	0	All	Immediately	Tuning	page 9-90															
Pn121 (2121h)	2	Friction Compensation Gain	10 to 1,000	1%	100	All	Immediately	Tuning	page 9-65, page 9-68															
Pn122 (2122h)	2	Second Friction Compensation Gain	10 to 1,000	1%	100	All	Immediately	Tuning	page 9-65, page 9-68															
Pn123 (2123h)	2	Friction Compensation Coefficient	0 to 100	1%	0	All	Immediately	Tuning	page 9-68															
Pn124 (2124h)	2	Friction Compensation Frequency Correction	-10,000 to 10,000	0.1 Hz	0	All	Immediately	Tuning	page 9-68															
Pn125 (2125h)	2	Friction Compensation Gain Correction	1 to 1,000	1%	100	All	Immediately	Tuning	page 9-68															
Pn131 (2131h)	2	Gain Switching Time 1	0 to 65,535	1 ms	0	All	Immediately	Tuning	page 9-65															
Pn132 (2132h)	2	Gain Switching Time 2	0 to 65,535	1 ms	0	All	Immediately	Tuning	page 9-65															
Pn135 (2135h)	2	Gain Switching Waiting Time 1	0 to 65,535	1 ms	0	All	Immediately	Tuning	page 9-65															
Pn136 (2136h)	2	Gain Switching Waiting Time 2	0 to 65,535	1 ms	0	All	Immediately	Tuning	page 9-65															
Pn139 (2139h)	2	Automatic Gain Switching Selections 1	0000h to 0052h	-	0000h	All	Immediately	Tuning	page 9-65															
			<table border="1"> <thead> <tr> <th colspan="2">Gain Switching Selection</th> </tr> </thead> <tbody> <tr> <td>0</td> <td>Disable automatic gain switching.</td> </tr> <tr> <td>1</td> <td>Reserved setting (Do not use.)</td> </tr> <tr> <td>2</td> <td>Use automatic gain switching pattern 1. The gain settings 1 switch automatically to 2 when switching condition A is satisfied. The gain settings 2 switch automatically to 1 when switching condition A is not satisfied.</td> </tr> </tbody> </table>								Gain Switching Selection		0	Disable automatic gain switching.	1	Reserved setting (Do not use.)	2	Use automatic gain switching pattern 1. The gain settings 1 switch automatically to 2 when switching condition A is satisfied. The gain settings 2 switch automatically to 1 when switching condition A is not satisfied.						
	Gain Switching Selection																							
	0	Disable automatic gain switching.																						
	1	Reserved setting (Do not use.)																						
	2	Use automatic gain switching pattern 1. The gain settings 1 switch automatically to 2 when switching condition A is satisfied. The gain settings 2 switch automatically to 1 when switching condition A is not satisfied.																						
			<table border="1"> <thead> <tr> <th colspan="2">Gain Switching Condition A</th> </tr> </thead> <tbody> <tr> <td>0</td> <td>/COIN (Positioning Completion Output) signal turns ON.</td> </tr> <tr> <td>1</td> <td>/COIN (Positioning Completion Output) signal turns OFF.</td> </tr> <tr> <td>2</td> <td>/NEAR (Near Output) signal turns ON.</td> </tr> <tr> <td>3</td> <td>/NEAR (Near Output) signal turns OFF.</td> </tr> <tr> <td>4</td> <td>Position reference filter output is 0 and position reference input is OFF.</td> </tr> <tr> <td>5</td> <td>Position reference input is ON.</td> </tr> </tbody> </table>								Gain Switching Condition A		0	/COIN (Positioning Completion Output) signal turns ON.	1	/COIN (Positioning Completion Output) signal turns OFF.	2	/NEAR (Near Output) signal turns ON.	3	/NEAR (Near Output) signal turns OFF.	4	Position reference filter output is 0 and position reference input is OFF.	5	Position reference input is ON.
	Gain Switching Condition A																							
	0	/COIN (Positioning Completion Output) signal turns ON.																						
	1	/COIN (Positioning Completion Output) signal turns OFF.																						
2	/NEAR (Near Output) signal turns ON.																							
3	/NEAR (Near Output) signal turns OFF.																							
4	Position reference filter output is 0 and position reference input is OFF.																							
5	Position reference input is ON.																							
		n.XXX																						
		Reserved parameter (Do not change.)																						
		n.XXX																						
		Reserved parameter (Do not change.)																						
Pn13D (213Dh)	2	Current Gain Level	100 to 2,000	1%	2000	All	Immediately	Tuning	page 9-71															

Continued on next page.

Continued from previous page.

Parameter No.	Size	Name	Setting Range	Setting Unit	Default Setting	Applicable Motors	When Enabled	Classification	Reference	
Pn140 (2140h)	2	Model Following Control-Related Selections	0000h to 1121h	–	0100h	All	Immediately	Tuning	–	
	n.□□□X	Model Following Control Selection							Reference	page 9-77
		0	Do not use model following control.							
	n.□□X□	Vibration Suppression Selection							Reference	page 9-77
		0	Do not perform vibration suppression.							
		1	Perform vibration suppression for a specific frequency.							
	n.□X□□	Vibration Suppression Adjustment Selection							Reference	page 9-30
		0	Do not adjust vibration suppression automatically during execution of autotuning without a host reference, autotuning with a host reference, and custom tuning.							
	n.X□□□	Speed Feedforward (VFF)/Torque Feedforward (TFF) Selection							Reference	page 9-30
		0	Do not use model following control and speed/torque feedforward together.							
	n.X□□□	Speed Feedforward (VFF)/Torque Feedforward (TFF) Selection							Reference	page 9-30
		1	Use model following control and speed/torque feedforward together.							
	Pn141 (2141h)	2	Model Following Control Gain	10 to 20,000	0.1/s	500	All	Immediately	Tuning	page 9-77
	Pn142 (2142h)	2	Model Following Control Gain Correction	500 to 2,000	0.1%	1000	All	Immediately	Tuning	page 9-65
	Pn143 (2143h)	2	Model Following Control Bias in the Forward Direction	0 to 10,000	0.1%	1000	All	Immediately	Tuning	page 9-77
Pn144 (2144h)	2	Model Following Control Bias in the Reverse Direction	0 to 10,000	0.1%	1000	All	Immediately	Tuning	page 9-77	
Pn145 (2145h)	2	Vibration Suppression 1 Frequency A	10 to 2,500	0.1 Hz	500	All	Immediately	Tuning	page 9-55	
Pn146 (2146h)	2	Vibration Suppression 1 Frequency B	10 to 2,500	0.1 Hz	700	All	Immediately	Tuning	page 9-55	
Pn147 (2147h)	2	Model Following Control Speed Feedforward Compensation	0 to 10,000	0.1%	1000	All	Immediately	Tuning	page 9-77	
Pn148 (2148h)	2	Second Model Following Control Gain	10 to 20,000	0.1/s	500	All	Immediately	Tuning	page 9-65	
Pn149 (2149h)	2	Second Model Following Control Gain Correction	500 to 2,000	0.1%	1000	All	Immediately	Tuning	page 9-65	
Pn14A (214Ah)	2	Vibration Suppression 2 Frequency	10 to 2,000	0.1 Hz	800	All	Immediately	Tuning	page 9-55	
Pn14B (214Bh)	2	Vibration Suppression 2 Correction	10 to 1,000	1%	100	All	Immediately	Tuning	page 9-55	

Continued on next page.

17.1 List of Parameters

17.1.2 List of Parameters

Continued from previous page.

Parameter No.	Size	Name	Setting Range	Setting Unit	Default Setting	Applicable Motors	When Enabled	Classification	Reference	
Pn14F (214Fh)	2	Control-Related Selections	0000h to 0021h	-	0021h	All	After restart	Tuning	-	
	n.□□□X		Model Following Control Type Selection						Reference	
			0	Use model following control type 1.						page 9-87
			1	Use model following control type 2.						
	n.□□X□		Tuning-less Type Selection						Reference	
			0	Use tuning-less type 1.						page 9-13
			1	Use tuning-less type 2.						
		2	Use tuning-less type 3.							
n.□X□□		Reserved parameter (Do not change.)								
n.X□□□		Reserved parameter (Do not change.)								
Pn160 (2160h)	2	Anti-Resonance Control-Related Selections	0000h to 0011h	-	0010h	All	Immediately	Tuning	-	
	n.□□□X		Anti-Resonance Control Selection						Reference	
			0	Do not use anti-resonance control.						page 9-50
			1	Use anti-resonance control.						
	n.□□X□		Anti-Resonance Control Adjustment Selection						Reference	
			0	Do not adjust anti-resonance control automatically during execution of autotuning without a host reference, autotuning with a host reference, and custom tuning.						page 9-30
			1	Adjust anti-resonance control automatically during execution of autotuning without a host reference, autotuning with a host reference, and custom tuning.						
n.□X□□		Reserved parameter (Do not change.)								
n.X□□□		Reserved parameter (Do not change.)								
Pn161 (2161h)	2	Anti-Resonance Frequency	10 to 20,000	0.1 Hz	1000	All	Immediately	Tuning	page 9-50	
Pn162 (2162h)	2	Anti-Resonance Gain Correction	1 to 1,000	1%	100	All	Immediately	Tuning	page 9-50	
Pn163 (2163h)	2	Anti-Resonance Damping Gain	0 to 300	1%	0	All	Immediately	Tuning	page 9-50	
Pn164 (2164h)	2	Anti-Resonance Filter Time Constant 1 Correction	-1,000 to 1,000	0.01 ms	0	All	Immediately	Tuning	page 9-50	
Pn165 (2165h)	2	Anti-Resonance Filter Time Constant 2 Correction	-1,000 to 1,000	0.01 ms	0	All	Immediately	Tuning	page 9-50	
Pn166 (2166h)	2	Anti-Resonance Damping Gain 2	0 to 1,000	1%	0	All	Immediately	Tuning	page 9-50	

Continued on next page.

Continued from previous page.

Parameter No.	Size	Name	Setting Range	Setting Unit	Default Setting	Applicable Motors	When Enabled	Classification	Reference		
Pn170 (2170h)	2	Tuning-less Function-Related Selections	0000h to 2711h	-	1401h	All	-	Setup	page 9-12		
		n.□□□X	Tuning-less Selection							When Enabled	
			0	Disable tuning-less function.						After restart	
			1	Enable tuning-less function.							
		n.□□X□	Speed Control Method							When Enabled	
			0	Use for speed control.						After restart	
			1	Use for speed control and use host controller for position control.							
		n.□X□□	Rigidity Level							When Enabled	
			0 to 7	Set the rigidity level.						Immediately	
		n.X□□□	Tuning-less Load Level							When Enabled	
			0 to 2	Set the load level for the tuning-less function.						Immediately	
		Pn181 (2181h)	2	Mode Switching Level for Speed Reference	0 to 10,000	1 mm/s	0	Linear	Immediately	Tuning	page 9-88
		Pn182 (2182h)	2	Mode Switching Level for Acceleration	0 to 30,000	1 mm/s ²	0	Linear	Immediately	Tuning	page 9-88
		Pn205 (2205h)	2	Multiturn Limit	0 to 65,535	1 rev	65535	Rotary	After restart	Setup	page 7-36
		Pn207 (2207h)	2	Position Control Function Selections	0000h to 2210h	-	0010h	All	After restart	Setup	-
				n.□□□X	Reserved parameter (Do not change.)						
n.□□X□	Reserved parameter (Do not change.)										
n.□X□□	Reserved parameter (Do not change.)										
n.X□□□	/COIN (Positioning Completion Output) Signal Output Timing							Reference			
	0			Output when the absolute value of the position deviation is the same or less than the setting of Pn522 (2522h) (Positioning Completed Width).						page 7-10	
	1			Output when the absolute value of the position error is the same or less than the setting of Pn522 (2522h) (Positioning Completed Width) and the reference after the position reference filter is 0.							
2	Output when the absolute value of the position error is the same or less than the setting of Pn522 (2522h) (Positioning Completed Width) and the reference input is 0.										
Pn20A (220Ah)	4	Number of External Encoder Scale Pitches	4 to 1,048,576	1 scale pitch/revolution	32768	Rotary	After restart	Setup	page 11-7		
Pn20E (220Eh)	4	Electronic Gear Ratio (Numerator)*4	1 to 1,073,741,824	1	16	All	After restart	Setup	page 6-42		
Pn210 (2210h)	4	Electronic Gear Ratio (Denominator)*4	1 to 1,073,741,824	1	1	All	After restart	Setup	page 6-42		
Pn212 (2212h)	4	Number of Encoder Output Pulses	16 to 1,073,741,824	1 P/Rev	2048	Rotary	After restart	Setup	page 7-23		

Continued on next page.

17.1 List of Parameters

17.1.2 List of Parameters

Continued from previous page.

Parameter No.	Size	Name	Setting Range	Setting Unit	Default Setting	Applicable Motors	When Enabled	Classification	Reference	
Pn22A (222Ah)	2	Fully-closed Control Selections	0000h to 1003h	-	0000h	Rotary	After restart	Setup	page 11-9	
	n.□□□X		Reserved parameter (Do not change.)							
	n.□□X□		Reserved parameter (Do not change.)							
	n.□X□□		Reserved parameter (Do not change.)							
	n.X□□□		Fully-closed Control Speed Feedback Selection							
		0	Use motor encoder speed.							
		1	Use external encoder speed.							
Pn230 (2230h)	2	Position Control Expansion Function Selections	0000h to 0001h	-	0000h	All	After restart	Setup	page 9-72	
	n.□□□X		Backlash Compensation Direction							
			0	Compensate forward references.						
			1	Compensate reverse references.						
	n.□□X□		Reserved parameter (Do not change.)							
n.□X□□		Reserved parameter (Do not change.)								
n.X□□□		Reserved parameter (Do not change.)								
Pn231 (2231h)	4	Backlash Compensation	-500,000 to 500,000	0.1 reference units	0	All	Immediately	Setup	page 9-72	
Pn233 (2233h)	2	Backlash Compensation Time Constant	0 to 65,535	0.01 ms	0	All	Immediately	Setup	page 9-72	
Pn281 (2281h)	2	Encoder Output Resolution	1 to 4,096	1 edge/pitch	20	All	After restart	Setup	page 7-23	
Pn282 (2282h)	4	Linear Encoder Scale Pitch	0 to 6,553,600	0.01 μm	0	Linear	After restart	Setup	page 6-15	
Pn304 (2304h)	2	Jogging Speed	0 to 10,000	1 min ⁻¹	500	Rotary	Immediately	Setup	page 8-7	
Pn305 (2305h)	2	Soft Start Acceleration Time	0 to 10,000	1 ms	0	All	Immediately	Setup	*1	
Pn306 (2306h)	2	Soft Start Deceleration Time	0 to 10,000	1 ms	0	All	Immediately	Setup	*1	
Pn308 (2308h)	2	Speed Feedback Filter Time Constant	0 to 65,535	0.01 ms	0	All	Immediately	Setup	page 9-77	
Pn30A (230Ah)	2	Deceleration Time for Servo OFF and Forced Stops	0 to 10,000	1 ms	0	All	Immediately	Setup	page 6-28	
Pn30C (230Ch)	2	Speed Feedforward Average Movement Time	0 to 5,100	0.1 ms	0	All	Immediately	Setup	page 9-87	

Continued on next page.

Continued from previous page.

Parameter No.	Size	Name	Setting Range	Setting Unit	Default Setting	Applicable Motors	When Enabled	Classification	Reference	
Pn310 (2310h)	2	Vibration Detection Selections	0000h to 0002h	–	0000h	All	Immediately	Setup	page 7-46	
	n.□□□X		Vibration Detection Selection							
			0	Do not detect vibration.						
			1	Output a warning (A.911) if vibration is detected.						
			2	Output an alarm (A.520) if vibration is detected.						
	n.□□X□		Reserved parameter (Do not change.)							
	n.□X□□		Reserved parameter (Do not change.)							
n.X□□□		Reserved parameter (Do not change.)								
Pn311 (2311h)	2	Vibration Detection Sensitivity	50 to 500	1%	100	All	Immediately	Tuning	page 7-46	
Pn312 (2312h)	2	Vibration Detection Level	0 to 5,000	1 min ⁻¹	50	Rotary	Immediately	Tuning	page 7-46	
Pn316 (2316h)	2	Maximum Motor Speed	0 to 65,535	1 min ⁻¹	10000	Rotary	After restart	Setup	page 7-17	
Pn324 (2324h)	2	Moment of Inertia Calculation Starting Level	0 to 20,000	1%	300	All	Immediately	Setup	page 9-30	
Pn383 (2383h)	2	Jogging Speed	0 to 10,000	1 mm/s	50	Linear	Immediately	Setup	page 8-7	
Pn384 (2384h)	2	Vibration Detection Level	0 to 5,000	1 mm/s	10	Linear	Immediately	Tuning	page 7-46	
Pn385 (2385h)	2	Maximum Motor Speed	1 to 100	100 mm/s	50	Linear	After restart	Setup	page 7-17	
Pn401 (2401h)	2	First Stage First Torque Reference Filter Time Constant	0 to 65,535	0.01 ms	100	All	Immediately	Tuning	page 9-80	
Pn402 (2402h)	2	Forward Torque Limit	0 to 800	1%*1	800	Rotary	Immediately	Setup	page 7-26	
Pn403 (2403h)	2	Reverse Torque Limit	0 to 800	1%*1	800	Rotary	Immediately	Setup	page 7-26	
Pn404 (2404h)	2	Forward External Torque Limit	0 to 800	1%*1	100	All	Immediately	Setup	page 7-27	
Pn405 (2405h)	2	Reverse External Torque Limit	0 to 800	1%*1	100	All	Immediately	Setup	page 7-27	
Pn406 (2406h)	2	Emergency Stop Torque	0 to 800	1%*1	800	All	Immediately	Setup	page 6-27	
Pn407 (2407h)	2	Speed Limit during Torque Control	0 to 10,000	1 min ⁻¹	10000	Rotary	Immediately	Setup	page 7-13	

Continued on next page.

17.1 List of Parameters

17.1.2 List of Parameters

Continued from previous page.

Parameter No.	Size	Name	Setting Range	Setting Unit	Default Setting	Applicable Motors	When Enabled	Classification	Reference	
Pn408 (2408h)	2	Torque-Related Function Selections	0000h to 1111h	-	0000h	All	-	Setup	-	
	n.□□□X		Notch Filter Selection 1				When Enabled	Reference		
			0	Disable first stage notch filter.			Immediately	page 9-80		
			1	Enable first stage notch filter.						
	n.□□X□		Speed Limit Selection				When Enabled	Reference		
			0	Use the smaller of the maximum motor speed and the setting of Pn407 (2407h) as the speed limit.			After restart	page 7-12		
				Use the smaller of the maximum motor speed and the setting of Pn480 (2480h) as the speed limit.						
			1	Use the smaller of the overspeed alarm detection speed and the setting of Pn407 (2407h) as the speed limit.						
				Use the smaller of the overspeed alarm detection speed and the setting of Pn480 (2480h) as the speed limit.						
	n.□X□□		Notch Filter Selection 2				When Enabled	Reference		
			0	Disable second stage notch filter.			Immediately	page 9-80		
			1	Enable second stage notch filter.						
	n.X□□□		Friction Compensation Function Selection				When Enabled	Reference		
			0	Disable friction compensation.			Immediately	page 9-68		
			1	Enable friction compensation.						
Pn409 (2409h)	2	First Stage Notch Filter Frequency	50 to 5,000	1 Hz	5000	All	Immediately	Tuning	page 9-80	
Pn40A (240Ah)	2	First Stage Notch Filter Q Value	50 to 1,000	0.01	70	All	Immediately	Tuning	page 9-80	
Pn40B (240Bh)	2	First Stage Notch Filter Depth	0 to 1,000	0.001	0	All	Immediately	Tuning	page 9-80	
Pn40C (240Ch)	2	Second Stage Notch Filter Frequency	50 to 5,000	1 Hz	5000	All	Immediately	Tuning	page 9-80	
Pn40D (240Dh)	2	Second Stage Notch Filter Q Value	50 to 1,000	0.01	70	All	Immediately	Tuning	page 9-80	
Pn40E (240Eh)	2	Second Stage Notch Filter Depth	0 to 1,000	0.001	0	All	Immediately	Tuning	page 9-80	
Pn40F (240Fh)	2	Second Stage Second Torque Reference Filter Frequency	100 to 5,000	1 Hz	5000	All	Immediately	Tuning	page 9-80	
Pn410 (2410h)	2	Second Stage Second Torque Reference Filter Q Value	50 to 100	0.01	50	All	Immediately	Tuning	page 9-80	
Pn412 (2412h)	2	First Stage Second Torque Reference Filter Time Constant	0 to 65,535	0.01 ms	100	All	Immediately	Tuning	page 9-65	

Continued on next page.

Continued from previous page.

Parameter No.	Size	Name	Setting Range	Setting Unit	Default Setting	Applicable Motors	When Enabled	Classification	Reference	
Pn416 (2416h)	2	Torque-Related Function Selections 2	0000h to 1111h	-	0000h	All	Immediately	Setup	page 9-82	
	n.□□□X		Notch Filter Selection 3							
			0	Disable third stage notch filter.						
			1	Enable third stage notch filter.						
	n.□□X□		Notch Filter Selection 4							
			0	Disable fourth stage notch filter.						
			1	Enable fourth stage notch filter.						
	n.□X□□		Notch Filter Selection 5							
			0	Disable fifth stage notch filter.						
			1	Enable fifth stage notch filter.						
n.X□□□		Reserved parameter (Do not change.)								
Pn417 (2417h)	2	Third Stage Notch Filter Frequency	50 to 5,000	1 Hz	5000	All	Immediately	Tuning	page 9-82	
Pn418 (2418h)	2	Third Stage Notch Filter Q Value	50 to 1,000	0.01	70	All	Immediately	Tuning	page 9-82	
Pn419 (2419h)	2	Third Stage Notch Filter Depth	0 to 1,000	0.001	0	All	Immediately	Tuning	page 9-82	
Pn41A (241Ah)	2	Fourth Stage Notch Filter Frequency	50 to 5,000	1 Hz	5000	All	Immediately	Tuning	page 9-82	
Pn41B (241Bh)	2	Fourth Stage Notch Filter Q Value	50 to 1,000	0.01	70	All	Immediately	Tuning	page 9-82	
Pn41C (241Ch)	2	Fourth Stage Notch Filter Depth	0 to 1,000	0.001	0	All	Immediately	Tuning	page 9-82	
Pn41D (241Dh)	2	Fifth Stage Notch Filter Frequency	50 to 5,000	1 Hz	5000	All	Immediately	Tuning	page 9-82	
Pn41E (241Eh)	2	Fifth Stage Notch Filter Q Value	50 to 1,000	0.01	70	All	Immediately	Tuning	page 9-82	
Pn41F (241Fh)	2	Fifth Stage Notch Filter Depth	0 to 1,000	0.001	0	All	Immediately	Tuning	page 9-81	
Pn423 (2423h)	2	Speed Ripple Compensation Selections	0000h to 1111h	-	0000h	Rotary	-	Setup	page 9-59	
	n.□□□X		Speed Ripple Compensation Function Selection					When Enabled		
			0	Disable speed ripple compensation.					Immediately	
			1	Enable speed ripple compensation.						
	n.□□X□		Speed Ripple Compensation Information Disagreement Warning Detection Selection					When Enabled		
			0	Detect A.942 alarms.					After restart	
			1	Do not detect A.942 alarms.						
	n.□X□□		Speed Ripple Compensation Enable Condition Selection					When Enabled		
			0	Speed reference					After restart	
			1	Motor speed						
n.X□□□		Reserved parameter (Do not change.)								
Pn424 (2424h)	2	Torque Limit at Main Circuit Voltage Drop	0 to 100	1%*1	50	All	Immediately	Setup	page 7-15	

Continued on next page.

17.1 List of Parameters

17.1.2 List of Parameters

Continued from previous page.

Parameter No.	Size	Name	Setting Range	Setting Unit	Default Setting	Applicable Motors	When Enabled	Classification	Reference				
Pn425 (2425h)	2	Release Time for Torque Limit at Main Circuit Voltage Drop	0 to 1,000	1 ms	100	All	Immediately	Setup	page 7-15				
Pn426 (2426h)	2	Torque Feedforward Average Movement Time	0 to 5,100	0.1 ms	0	All	Immediately	Setup	page 9-87				
Pn427 (2427h)	2	Speed Ripple Compensation Enable Speed	0 to 10,000	1 min ⁻¹	0	Rotary	Immediately	Tuning	page 9-59				
Pn456 (2456h)	2	Sweep Torque Reference Amplitude	1 to 800	1%	15	All	Immediately	Tuning	page 9-93				
Pn460 (2460h)	2	Notch Filter Adjustment Selections 1	0000h to 0101h	-	0101h	All	Immediately	Tuning	page 9-12, page 9-23, page 9-41				
										n.□□□X		Notch Filter Adjustment Selection 1	
										0	Do not adjust the first stage notch filter automatically during execution of autotuning without a host reference, autotuning with a host reference, and custom tuning.		
										1	Adjust the first stage notch filter automatically during execution of autotuning without a host reference, autotuning with a host reference, and custom tuning.		
										n.□□X□		Reserved parameter (Do not change.)	
										n.□X□□		Notch Filter Adjustment Selection 2	
										0	Do not adjust the second stage notch filter automatically when the tuning-less function is enabled or during execution of autotuning without a host reference, autotuning with a host reference, and custom tuning.		
1	Adjust the second stage notch filter automatically when the tuning-less function is enabled or during execution of autotuning without a host reference, autotuning with a host reference, and custom tuning.												
n.X□□□		Reserved parameter (Do not change.)											
Pn475 (2475h)	2	Gravity Compensation-Related Selections	0000h to 0001h	-	0000h	All	After restart	Setup	page 9-69				
										n.□□□X		Gravity Compensation Selection	
										0	Disable gravity compensation.		
										1	Enable gravity compensation.		
										n.□□X□		Reserved parameter (Do not change.)	
										n.□X□□		Reserved parameter (Do not change.)	
										n.X□□□		Reserved parameter (Do not change.)	
Pn476 (2476h)	2	Gravity Compensation Torque	-1,000 to 1,000	0.1%	0	All	Immediately	Tuning	page 9-69				
Pn480 (2480h)	2	Speed Limit during Force Control	0 to 10,000	1 mm/s	10000	Linear	Immediately	Setup	page 7-13				
Pn481 (2481h)	2	Polarity Detection Speed Loop Gain	10 to 20,000	0.1 Hz	400	Linear	Immediately	Tuning	-				
Pn482 (2482h)	2	Polarity Detection Speed Loop Integral Time Constant	15 to 51,200	0.01 ms	3000	Linear	Immediately	Tuning	-				
Pn483 (2483h)	2	Forward Force Limit	0 to 800	1%*1	30	Linear	Immediately	Setup	page 7-26				
Pn484 (2484h)	2	Reverse Force Limit	0 to 800	1%*1	30	Linear	Immediately	Setup	page 7-26				

Continued on next page.

Continued from previous page.

Parameter No.	Size	Name	Setting Range	Setting Unit	Default Setting	Applicable Motors	When Enabled	Classification	Reference
Pn485 (2485h)	2	Polarity Detection Reference Speed	0 to 100	1 mm/s	20	Linear	Immediately	Tuning	–
Pn486 (2486h)	2	Polarity Detection Reference Acceleration/Deceleration Time	0 to 100	1 ms	25	Linear	Immediately	Tuning	–
Pn487 (2487h)	2	Polarity Detection Constant Speed Time	0 to 300	1 ms	0	Linear	Immediately	Tuning	–
Pn488 (2488h)	2	Polarity Detection Reference Waiting Time	50 to 500	1 ms	100	Linear	Immediately	Tuning	–
Pn48E (248Eh)	2	Polarity Detection Range	1 to 65,535	1 mm	10	Linear	Immediately	Tuning	–
Pn490 (2490h)	2	Polarity Detection Load Level	0 to 20,000	1%	100	Linear	Immediately	Tuning	–
Pn495 (2495h)	2	Polarity Detection Confirmation Force Reference	0 to 200	1%	100	Linear	Immediately	Tuning	–
Pn498 (2498h)	2	Polarity Detection Allowable Error Range	0 to 30	1 deg	10	Linear	Immediately	Tuning	–
Pn49F (249Fh)	2	Speed Ripple Compensation Enable Speed	0 to 10,000	1 mm/s	0	Linear	Immediately	Tuning	page 9-59
Pn502 (2502h)	2	Rotation Detection Level	1 to 10,000	1 min ⁻¹	20	Rotary	Immediately	Setup	page 7-8
Pn503 (2503h)	2	Speed Coincidence Detection Signal Output Width	0 to 100	1 min ⁻¹	10	Rotary	Immediately	Setup	page 7-9
Pn506 (2506h)	2	Brake Reference-Servo OFF Delay Time	0 to 50	10 ms	0*5	All	Immediately	Setup	page 6-32
Pn507 (2507h)	2	Brake Reference Output Speed Level	0 to 10,000	1 min ⁻¹	100	Rotary	Immediately	Setup	page 6-32
Pn508 (2508h)	2	Servo OFF-Brake Command Waiting Time	10 to 100	10 ms	50	All	Immediately	Setup	page 6-32
Pn509 (2509h)	2	Momentary Power Interruption Hold Time	20 to 50,000	1 ms	20	All	Immediately	Setup	page 7-14

Continued on next page.

17.1 List of Parameters

17.1.2 List of Parameters

Continued from previous page.

Parameter No.	Size	Name	Setting Range	Setting Unit	Default Setting	Applicable Motors	When Enabled	Classification	Reference	
Pn50A (250Ah)	2	Input Signal Selections 1	0000h to FFF2h	-	1881h	All	After restart	Setup	-	
		n.□□□X	Reserved parameter (Do not change.)							
		n.□□X□	Reserved parameter (Do not change.)							
		n.□X□□	Reserved parameter (Do not change.)							
		n.X□□□	P-OT (Forward Drive Prohibit) Signal Allocation							Reference
			0	Enable forward drive when CN1-13 input signal is ON (closed).	page 6-26					
			1	Enable forward drive when CN1-7 input signal is ON (closed).						
			2	Enable forward drive when CN1-8 input signal is ON (closed).						
			3	Enable forward drive when CN1-9 input signal is ON (closed).						
			4	Enable forward drive when CN1-10 input signal is ON (closed).						
			5	Enable forward drive when CN1-11 input signal is ON (closed).						
			6	Enable forward drive when CN1-12 input signal is ON (closed).						
			7	Set the signal to always prohibit forward drive.						
			8	Set the signal to always enable forward drive.						
			9	Enable forward drive when CN1-13 input signal is OFF (open).						
	A		Enable forward drive when CN1-7 input signal is OFF (open).							
	B	Enable forward drive when CN1-8 input signal is OFF (open).								
	C	Enable forward drive when CN1-9 input signal is OFF (open).								
	D	Enable forward drive when CN1-10 input signal is OFF (open).								
	E	Enable forward drive when CN1-11 input signal is OFF (open).								
	F	Enable forward drive when CN1-12 input signal is OFF (open).								

Continued on next page.

Continued from previous page.

Parameter No.	Size	Name	Setting Range	Setting Unit	Default Setting	Applicable Motors	When Enabled	Classification	Reference		
Pn50B (250Bh)	2	Input Signal Selections 2	0000h to FFFFh	-	8882h	All	After restart	Setup	-		
			N-OT (Reverse Drive Prohibit) Signal Allocation							Reference	
	n.□□□X		0	Enable reverse drive when CN1-13 input signal is ON (closed).							page 6-26
			1	Enable reverse drive when CN1-7 input signal is ON (closed).							
			2	Enable reverse drive when CN1-8 input signal is ON (closed).							
			3	Enable reverse drive when CN1-9 input signal is ON (closed).							
			4	Enable reverse drive when CN1-10 input signal is ON (closed).							
			5	Enable reverse drive when CN1-11 input signal is ON (closed).							
			6	Enable reverse drive when CN1-12 input signal is ON (closed).							
			7	Set the signal to always prohibit reverse drive.							
			8	Set the signal to always enable reverse drive.							
			9	Enable reverse drive when CN1-13 input signal is OFF (open).							
			A	Enable reverse drive when CN1-7 input signal is OFF (open).							
			B	Enable reverse drive when CN1-8 input signal is OFF (open).							
			C	Enable reverse drive when CN1-9 input signal is OFF (open).							
		D	Enable reverse drive when CN1-10 input signal is OFF (open).								
		E	Enable reverse drive when CN1-11 input signal is OFF (open).								
		F	Enable reverse drive when CN1-12 input signal is OFF (open).								
n.□□X□		Reserved parameter (Do not change.)									
		/P-CL (Forward External Torque Limit Input) Signal Allocation							Reference		
n.□X□□		0	Active when CN1-13 input signal is ON (closed).							page 7-27	
		1	Active when CN1-7 input signal is ON (closed).								
		2	Active when CN1-8 input signal is ON (closed).								
		3	Active when CN1-9 input signal is ON (closed).								
		4	Active when CN1-10 input signal is ON (closed).								
		5	Active when CN1-11 input signal is ON (closed).								
		6	Active when CN1-12 input signal is ON (closed).								
		7	The signal is always active.								
		8	The signal is always inactive.								
		9	Active when CN1-13 input signal is OFF (open).								
		A	Active when CN1-7 input signal is OFF (open).								
		B	Active when CN1-8 input signal is OFF (open).								
		C	Active when CN1-9 input signal is OFF (open).								
		D	Active when CN1-10 input signal is OFF (open).								
		E	Active when CN1-11 input signal is OFF (open).								
		F	Active when CN1-12 input signal is OFF (open).								
n.X□□□		/N-CL (Reverse External Torque Limit Input) Signal Allocation							Reference		
		0 to F	The allocations are the same as the /P-CL (Forward External Torque Limit Input) signal allocations.							page 7-27	

Continued on next page.

17.1 List of Parameters

17.1.2 List of Parameters

Continued from previous page.

Parameter No.	Size	Name	Setting Range	Setting Unit	Default Setting	Applicable Motors	When Enabled	Classification	Reference	
Pn50E (250Eh)	2	Output Signal Selections 1	0000h to 6666h	-	0000h	All	After restart	Setup	-	
			/COIN (Positioning Completion Output) Signal Allocation							Reference
	n.□□□X		0	Disabled (the above signal output is not used).						page 7-10
			1	Output the signal from the CN1-1 or CN1-2 output terminal.						
			2	Output the signal from the CN1-23 or CN1-24 output terminal.						
			3	Output the signal from the CN1-25 or CN1-26 output terminal.						
			4	Output the signal from the CN1-27 or CN1-28 output terminal.						
			5	Output the signal from the CN1-29 or CN1-30 output terminal.						
			6	Reserved setting (Do not use.)						
			/V-CMP (Speed Coincidence Detection Output) Signal Allocation							Reference
	n.□□X□		0 to 6	The allocations are the same as the /COIN (Positioning Completion) signal allocations.						page 7-9
			/TGON (Rotation Detection Output) Signal Allocation							Reference
	n.□X□□		0 to 6	The allocations are the same as the /COIN (Positioning Completion) signal allocations.						page 7-8
			/S-RDY (Servo Ready) Signal Allocation							Reference
	n.X□□□		0 to 6	The allocations are the same as the /COIN (Positioning Completion) signal allocations.						page 7-8
	Pn50F (250Fh)	2	Output Signal Selections 2	0000h to 6666h	-	0100h	All	After restart	Setup	-
				/CLT (Torque Limit Detection Output) Signal Allocation						
n.□□□X		0	Disabled (the above signal output is not used).						page 7-30	
		1	Output the signal from the CN1-1 or CN1-2 output terminal.							
		2	Output the signal from the CN1-23 or CN1-24 output terminal.							
		3	Output the signal from the CN1-25 or CN1-26 output terminal.							
		4	Output the signal from the CN1-27 or CN1-28 output terminal.							
		5	Output the signal from the CN1-29 or CN1-30 output terminal.							
		6	Reserved setting (Do not use.)							
		/MLT (Speed Limit Detection) Signal Allocation							Reference	
n.□□X□		0 to 6	The allocations are the same as the /CLT (Torque Limit Detection Output) signal allocations.						page 7-12	
		/BK (Brake Output) Signal Allocation							Reference	
n.□X□□		0 to 6	The allocations are the same as the /CLT (Torque Limit Detection Output) signal allocations.						page 6-32	
		/WARN (Warning Output) Signal Allocation							Reference	
n.X□□□		0 to 6	The allocations are the same as the /CLT (Torque Limit Detection Output) signal allocations.						page 7-7	

Continued on next page.

Continued from previous page.

Parameter No.	Size	Name	Setting Range	Setting Unit	Default Setting	Applicable Motors	When Enabled	Classification	Reference																		
Pn510 (2510h)	2	Output Signal Selections 3	0000h to 0666h	-	0000h	All	After restart	Setup	-																		
			<table border="1"> <thead> <tr> <th colspan="2">/NEAR (Near Output) Signal Allocation</th> <th>Reference</th> </tr> </thead> <tbody> <tr> <td>0</td> <td>Disabled (the above signal output is not used).</td> <td rowspan="7">page 7-11</td> </tr> <tr> <td>1</td> <td>Output the signal from the CN1-1 or CN1-2 output terminal.</td> </tr> <tr> <td>2</td> <td>Output the signal from the CN1-23 or CN1-24 output terminal.</td> </tr> <tr> <td>3</td> <td>Output the signal from the CN1-25 or CN1-26 output terminal.</td> </tr> <tr> <td>4</td> <td>Output the signal from the CN1-27 or CN1-28 output terminal.</td> </tr> <tr> <td>5</td> <td>Output the signal from the CN1-29 or CN1-30 output terminal.</td> </tr> <tr> <td>6</td> <td>Reserved setting (Do not use.)</td> </tr> </tbody> </table>							/NEAR (Near Output) Signal Allocation		Reference	0	Disabled (the above signal output is not used).	page 7-11	1	Output the signal from the CN1-1 or CN1-2 output terminal.	2	Output the signal from the CN1-23 or CN1-24 output terminal.	3	Output the signal from the CN1-25 or CN1-26 output terminal.	4	Output the signal from the CN1-27 or CN1-28 output terminal.	5	Output the signal from the CN1-29 or CN1-30 output terminal.	6	Reserved setting (Do not use.)
	/NEAR (Near Output) Signal Allocation		Reference																								
	0	Disabled (the above signal output is not used).	page 7-11																								
	1	Output the signal from the CN1-1 or CN1-2 output terminal.																									
	2	Output the signal from the CN1-23 or CN1-24 output terminal.																									
	3	Output the signal from the CN1-25 or CN1-26 output terminal.																									
	4	Output the signal from the CN1-27 or CN1-28 output terminal.																									
	5	Output the signal from the CN1-29 or CN1-30 output terminal.																									
	6	Reserved setting (Do not use.)																									
n.□□□□		Reserved parameter (Do not change.)																									
n.□X□□		Reserved parameter (Do not change.)																									
n.X□□□		Reserved parameter (Do not change.)																									
Pn511 (2511h)	2	Input Signal Selections 5	0000h to FFFFh	-	6543h	All	After restart	Setup	page 7-4																		
	n.□□□□		Reserved parameter (Do not change.)																								
			<table border="1"> <thead> <tr> <th colspan="2">/Probe1 (Probe 1 Latch Input) Signal Allocation</th> </tr> </thead> <tbody> <tr> <td>4</td> <td>Active when CN1-10 input signal is ON (closed).</td> </tr> <tr> <td>5</td> <td>Active when CN1-11 input signal is ON (closed).</td> </tr> <tr> <td>6</td> <td>Active when CN1-12 input signal is ON (closed).</td> </tr> <tr> <td>7</td> <td>The signal is always inactive.</td> </tr> <tr> <td>8</td> <td>The signal is always inactive.</td> </tr> <tr> <td>D</td> <td>Active when CN1-10 input signal is OFF (open).</td> </tr> <tr> <td>E</td> <td>Active when CN1-11 input signal is OFF (open).</td> </tr> <tr> <td>F</td> <td>Active when CN1-12 input signal is OFF (open).</td> </tr> </tbody> </table>							/Probe1 (Probe 1 Latch Input) Signal Allocation		4	Active when CN1-10 input signal is ON (closed).	5	Active when CN1-11 input signal is ON (closed).	6	Active when CN1-12 input signal is ON (closed).	7	The signal is always inactive.	8	The signal is always inactive.	D	Active when CN1-10 input signal is OFF (open).	E	Active when CN1-11 input signal is OFF (open).	F	Active when CN1-12 input signal is OFF (open).
	/Probe1 (Probe 1 Latch Input) Signal Allocation																										
	4	Active when CN1-10 input signal is ON (closed).																									
	5	Active when CN1-11 input signal is ON (closed).																									
	6	Active when CN1-12 input signal is ON (closed).																									
	7	The signal is always inactive.																									
	8	The signal is always inactive.																									
	D	Active when CN1-10 input signal is OFF (open).																									
E	Active when CN1-11 input signal is OFF (open).																										
F	Active when CN1-12 input signal is OFF (open).																										
n.□X□□		<table border="1"> <thead> <tr> <th colspan="2">/Probe2 (Probe 2 Latch Input) Signal Allocation</th> </tr> </thead> <tbody> <tr> <td>0 to F</td> <td>The allocations are the same as the /Probe1 (Probe 1 Latch Input) signal allocations.</td> </tr> </tbody> </table>							/Probe2 (Probe 2 Latch Input) Signal Allocation		0 to F	The allocations are the same as the /Probe1 (Probe 1 Latch Input) signal allocations.															
/Probe2 (Probe 2 Latch Input) Signal Allocation																											
0 to F	The allocations are the same as the /Probe1 (Probe 1 Latch Input) signal allocations.																										
n.X□□□		<table border="1"> <thead> <tr> <th colspan="2">/Home (Home Switch Input) Signal Allocation</th> </tr> </thead> <tbody> <tr> <td>0 to F</td> <td>The allocations are the same as the /Probe1 (Probe 1 Latch Input) signal allocations.</td> </tr> </tbody> </table>							/Home (Home Switch Input) Signal Allocation		0 to F	The allocations are the same as the /Probe1 (Probe 1 Latch Input) signal allocations.															
/Home (Home Switch Input) Signal Allocation																											
0 to F	The allocations are the same as the /Probe1 (Probe 1 Latch Input) signal allocations.																										

Continued on next page.

17.1 List of Parameters

17.1.2 List of Parameters

Continued from previous page.

Parameter No.	Size	Name	Setting Range	Setting Unit	Default Setting	Applicable Motors	When Enabled	Classification	Reference		
Pn512 (2512h)	2	Output Signal Inverse Settings 1	0000h to 1111h	-	0000h	All	After restart	Setup	page 7-5		
	n.□□□X		Output Signal Inversion for CN1-1 and CN1-2 Terminals								
			0	The signal is not inverted.							
			1	The signal is inverted.							
	n.□□X□		Output Signal Inversion for CN1-23 and CN1-24 Terminals								
			0	The signal is not inverted.							
			1	The signal is inverted.							
	n.□X□□		Output Signal Inversion for CN1-25 and CN1-26 Terminals								
			0	The signal is not inverted.							
			1	The signal is inverted.							
	n.X□□□		Output Signal Inversion for CN1-27 and CN1-28 Terminals								
			0	The signal is not inverted.							
			1	The signal is inverted.							
	Pn513 (2513h)	2	Output Signal Inverse Settings 2	0000h to 0011h	-	0000h	All	After restart	Setup	page 7-5	
		n.□□□X		Output Signal Inversion for CN1-29 and CN1-30 Terminals							
				0	The signal is not inverted.						
		1	The signal is inverted.								
n.□□X□		Reserved parameter (Do not change.)									
n.□X□□		Reserved parameter (Do not change.)									
n.X□□□		Reserved parameter (Do not change.)									
Pn514 (2514h)	2	Output Signal Selections 4	0000h to 0666h	-	0000h	All	After restart	Setup	-		
	n.□□□X		Reserved parameter (Do not change.)								
	n.□□X□		Reserved parameter (Do not change.)								
	n.□X□□		/PM (Preventative Maintenance Output) Signal Allocation							Reference page 10-15	
			0	Disabled (the above signal output is not used).							
			1	Output the signal from the CN1-1 or CN1-2 output terminal.							
			2	Output the signal from the CN1-23 or CN1-24 output terminal.							
			3	Output the signal from the CN1-25 or CN1-26 output terminal.							
			4	Output the signal from the CN1-27 or CN1-28 output terminal.							
	n.X□□□		5	Output the signal from the CN1-29 or CN1-30 output terminal.							
6			Reserved setting (Do not use.)								
		Reserved parameter (Do not change.)									

Continued on next page.

Continued from previous page.

Parameter No.	Size	Name	Setting Range	Setting Unit	Default Setting	Applicable Motors	When Enabled	Classification	Reference	
Pn515 (2515h)	2	Input Signal Selections 6	0000h to FFFFh	–	8888h	All	After restart	Setup	–	
	n.□□□X	Reserved parameter (Do not change.)								
	n.□□X□	Reserved parameter (Do not change.)								
	n.□X□□	/DBANS (Dynamic Brake Answer Input) Signal Allocation								
		0	Detect DB circuit error when CN1-13 input signal is ON (closed) while /DBON signal is ON.							
		1	Detect DB circuit error when CN1-7 input signal is ON (closed) while /DBON signal is ON.							
		2	Detect DB circuit error when CN1-8 input signal is ON (closed) while /DBON signal is ON.							
		3	Detect DB circuit error when CN1-9 input signal is ON (closed) while /DBON signal is ON.							
		4	Detect DB circuit error when CN1-10 input signal is ON (closed) while /DBON signal is ON.							
		5	Detect DB circuit error when CN1-11 input signal is ON (closed) while /DBON signal is ON.							
		6	Detect DB circuit error when CN1-12 input signal is ON (closed) while /DBON signal is ON.							
		7	Disable DB circuit error detection using the /DBANS signal.							
		8	Disable DB circuit error detection using the /DBANS signal.							
		9	Detect DB circuit error when CN1-13 input signal is OFF (open) while /DBON signal is ON.							
		A	Detect DB circuit error when CN1-7 input signal is OFF (open) while /DBON signal is ON.							
		B	Detect DB circuit error when CN1-8 input signal is OFF (open) while /DBON signal is ON.							
		C	Detect DB circuit error when CN1-9 input signal is OFF (open) while /DBON signal is ON.							
	D	Detect DB circuit error when CN1-10 input signal is OFF (open) while /DBON signal is ON.								
	E	Detect DB circuit error when CN1-11 input signal is OFF (open) while /DBON signal is ON.								
	F	Detect DB circuit error when CN1-12 input signal is OFF (open) while /DBON signal is ON.								
	n.X□□□	Reserved parameter (Do not change.)								

Continued on next page.

17.1 List of Parameters

17.1.2 List of Parameters

Continued from previous page.

Parameter No.	Size	Name	Setting Range	Setting Unit	Default Setting	Applicable Motors	When Enabled	Classification	Reference																																					
Pn516 (2516h)	2	Input Signal Selections 7	0000h to FFFFh	-	8888h	All	After restart	Setup	-																																					
			<table border="1"> <thead> <tr> <th colspan="2">FSTP (Forced Stop Input) Signal Allocation</th> <th>Reference</th> </tr> </thead> <tbody> <tr> <td>0</td> <td>Enable drive when CN1-13 input signal is ON (closed).</td> <td rowspan="16">page 7-55</td> </tr> <tr> <td>1</td> <td>Enable drive when CN1-7 input signal is ON (closed).</td> </tr> <tr> <td>2</td> <td>Enable drive when CN1-8 input signal is ON (closed).</td> </tr> <tr> <td>3</td> <td>Enable drive when CN1-9 input signal is ON (closed).</td> </tr> <tr> <td>4</td> <td>Enable drive when CN1-10 input signal is ON (closed).</td> </tr> <tr> <td>5</td> <td>Enable drive when CN1-11 input signal is ON (closed).</td> </tr> <tr> <td>6</td> <td>Enable drive when CN1-12 input signal is ON (closed).</td> </tr> <tr> <td>7</td> <td>Set the signal to always prohibit drive (always force the motor to stop).</td> </tr> <tr> <td>8</td> <td>Set the signal to always enable drive (always disable forcing the motor to stop).</td> </tr> <tr> <td>9</td> <td>Enable drive when CN1-13 input signal is OFF (open).</td> </tr> <tr> <td>A</td> <td>Enable drive when CN1-7 input signal is OFF (open).</td> </tr> <tr> <td>B</td> <td>Enable drive when CN1-8 input signal is OFF (open).</td> </tr> <tr> <td>C</td> <td>Enable drive when CN1-9 input signal is OFF (open).</td> </tr> <tr> <td>D</td> <td>Enable drive when CN1-10 input signal is OFF (open).</td> </tr> <tr> <td>E</td> <td>Enable drive when CN1-11 input signal is OFF (open).</td> </tr> <tr> <td>F</td> <td>Enable drive when CN1-12 input signal is OFF (open).</td> </tr> </tbody> </table>							FSTP (Forced Stop Input) Signal Allocation		Reference	0	Enable drive when CN1-13 input signal is ON (closed).	page 7-55	1	Enable drive when CN1-7 input signal is ON (closed).	2	Enable drive when CN1-8 input signal is ON (closed).	3	Enable drive when CN1-9 input signal is ON (closed).	4	Enable drive when CN1-10 input signal is ON (closed).	5	Enable drive when CN1-11 input signal is ON (closed).	6	Enable drive when CN1-12 input signal is ON (closed).	7	Set the signal to always prohibit drive (always force the motor to stop).	8	Set the signal to always enable drive (always disable forcing the motor to stop).	9	Enable drive when CN1-13 input signal is OFF (open).	A	Enable drive when CN1-7 input signal is OFF (open).	B	Enable drive when CN1-8 input signal is OFF (open).	C	Enable drive when CN1-9 input signal is OFF (open).	D	Enable drive when CN1-10 input signal is OFF (open).	E	Enable drive when CN1-11 input signal is OFF (open).	F	Enable drive when CN1-12 input signal is OFF (open).	
	FSTP (Forced Stop Input) Signal Allocation		Reference																																											
	0	Enable drive when CN1-13 input signal is ON (closed).	page 7-55																																											
	1	Enable drive when CN1-7 input signal is ON (closed).																																												
	2	Enable drive when CN1-8 input signal is ON (closed).																																												
	3	Enable drive when CN1-9 input signal is ON (closed).																																												
	4	Enable drive when CN1-10 input signal is ON (closed).																																												
	5	Enable drive when CN1-11 input signal is ON (closed).																																												
	6	Enable drive when CN1-12 input signal is ON (closed).																																												
	7	Set the signal to always prohibit drive (always force the motor to stop).																																												
	8	Set the signal to always enable drive (always disable forcing the motor to stop).																																												
	9	Enable drive when CN1-13 input signal is OFF (open).																																												
	A	Enable drive when CN1-7 input signal is OFF (open).																																												
	B	Enable drive when CN1-8 input signal is OFF (open).																																												
	C	Enable drive when CN1-9 input signal is OFF (open).																																												
	D	Enable drive when CN1-10 input signal is OFF (open).																																												
	E	Enable drive when CN1-11 input signal is OFF (open).																																												
	F	Enable drive when CN1-12 input signal is OFF (open).																																												
	n.□□□□		Reserved parameter (Do not change.)																																											
n.□□□□		Reserved parameter (Do not change.)																																												
n.X□□□		Reserved parameter (Do not change.)																																												
Pn51A (251Ah)	2	Output Signal Selections 8	0000h to 0060h	-	0000h	All	After restart	Setup	page 7-5																																					
	n.□□□□		Reserved parameter (Do not change.)																																											
			<table border="1"> <thead> <tr> <th colspan="2">/DBON (Dynamic Brake Operation Request Output) Signal Allocation</th> </tr> </thead> <tbody> <tr> <td>0</td> <td>Disabled (the above signal output is not used).</td> </tr> <tr> <td>1</td> <td>Output the signal from the CN1-1 or CN1-2 output terminal.</td> </tr> <tr> <td>2</td> <td>Output the signal from the CN1-23 or CN1-24 output terminal.</td> </tr> <tr> <td>3</td> <td>Output the signal from the CN1-25 or CN1-26 output terminal.</td> </tr> <tr> <td>4</td> <td>Output the signal from the CN1-27 or CN1-28 output terminal.</td> </tr> <tr> <td>5</td> <td>Output the signal from the CN1-29 or CN1-30 output terminal.</td> </tr> <tr> <td>6</td> <td>Reserved setting (Do not use.)</td> </tr> </tbody> </table>							/DBON (Dynamic Brake Operation Request Output) Signal Allocation		0	Disabled (the above signal output is not used).	1	Output the signal from the CN1-1 or CN1-2 output terminal.	2	Output the signal from the CN1-23 or CN1-24 output terminal.	3	Output the signal from the CN1-25 or CN1-26 output terminal.	4	Output the signal from the CN1-27 or CN1-28 output terminal.	5	Output the signal from the CN1-29 or CN1-30 output terminal.	6	Reserved setting (Do not use.)																					
	/DBON (Dynamic Brake Operation Request Output) Signal Allocation																																													
	0	Disabled (the above signal output is not used).																																												
	1	Output the signal from the CN1-1 or CN1-2 output terminal.																																												
	2	Output the signal from the CN1-23 or CN1-24 output terminal.																																												
	3	Output the signal from the CN1-25 or CN1-26 output terminal.																																												
	4	Output the signal from the CN1-27 or CN1-28 output terminal.																																												
	5	Output the signal from the CN1-29 or CN1-30 output terminal.																																												
6	Reserved setting (Do not use.)																																													
n.□□□□		Reserved parameter (Do not change.)																																												
n.X□□□		Reserved parameter (Do not change.)																																												
Pn51B (251Bh)	4	Motor-Load Position Deviation Overflow Detection Level	0 to 1,073,741,824	1 reference unit	1000	Rotary	Immediately	Setup	page 11-8																																					
Pn51E (251Eh)	2	Position Deviation Overflow Warning Level	10 to 100	1%	100	All	Immediately	Setup	page 16-48																																					
Pn520 (2520h)	4	Position Deviation Overflow Alarm Level	1 to 1,073,741,823	1 reference unit	5242880	All	Immediately	Setup	page 9-8, page 16-5																																					

Continued on next page.

Continued from previous page.

Parameter No.	Size	Name	Setting Range	Setting Unit	Default Setting	Applicable Motors	When Enabled	Classification	Reference
Pn522 (2522h)	4	Positioning Completed Width	0 to 1,073,741,824	1 reference unit	7	All	Immediately	Setup	page 7-10
Pn524 (2524h)	4	Near Signal Width	1 to 1,073,741,824	1 reference unit	1073741824	All	Immediately	Setup	page 7-11
Pn526 (2526h)	4	Position Deviation Overflow Alarm Level at Servo ON	1 to 1,073,741,823	1 reference unit	5242880	All	Immediately	Setup	page 9-8
Pn528 (2528h)	2	Position Deviation Overflow Warning Level at Servo ON	10 to 100	1%	100	All	Immediately	Setup	page 9-8
Pn529 (2529h)	2	Speed Limit Level at Servo ON	0 to 10,000	1 min ⁻¹	10000	Rotary	Immediately	Setup	page 9-8
Pn52A (252Ah)	2	Multiplier per Fully-closed Rotation	0 to 100	1%	20	Rotary	Immediately	Tuning	page 11-8
Pn52B (252Bh)	2	Overload Warning Level	1 to 100	1%	20	All	Immediately	Setup	page 6-40
Pn52C (252Ch)	2	Base Current Derating at Motor Overload Detection	10 to 100	1%	100	All	After restart	Setup	page 6-40
Pn530 (2530h)	2	Program Jogging-Related Selections	0000h to 0005h	-	0000h	All	Immediately	Setup	page 8-13
		Program Jogging Operation Pattern							
		0	(Waiting time in Pn535 → Forward by travel distance in Pn531) × Number of movements in Pn536						
		1	(Waiting time in Pn535 → Reverse by travel distance in Pn531) × Number of movements in Pn536						
		2	(Waiting time in Pn535 → Forward by travel distance in Pn531) × Number of movements in Pn536 (Waiting time in Pn535 → Reverse by travel distance in Pn531) × Number of movements in Pn536						
		3	(Waiting time in Pn535 → Reverse by travel distance in Pn531) × Number of movements in Pn536 (Waiting time in Pn535 → Forward by travel distance in Pn531) × Number of movements in Pn536						
		4	(Waiting time in Pn535 → Forward by travel distance in Pn531 → Waiting time in Pn535 → Reverse by travel distance in Pn531) × Number of movements in Pn536						
		5	(Waiting time in Pn535 → Reverse by travel distance in Pn531 → Waiting time in Pn535 → Forward by travel distance in Pn531) × Number of movements in Pn536						
		n.□□□□	Reserved parameter (Do not change.)						
		n.□X□□	Reserved parameter (Do not change.)						
	n.X□□□	Reserved parameter (Do not change.)							
Pn531 (2531h)	4	Program Jogging Travel Distance	1 to 1,073,741,824	1 reference unit	32768	All	Immediately	Setup	page 8-13
Pn533 (2533h)	2	Program Jogging Movement Speed	1 to 10,000	1 min ⁻¹	500	Rotary	Immediately	Setup	page 8-13
Pn534 (2534h)	2	Program Jogging Acceleration/Deceleration Time	2 to 10,000	1 ms	100	All	Immediately	Setup	page 8-13
Pn535 (2535h)	2	Program Jogging Waiting Time	0 to 10,000	1 ms	100	All	Immediately	Setup	page 8-13
Pn536 (2536h)	2	Program Jogging Number of Movements	0 to 1,000	1 time	1	All	Immediately	Setup	page 8-13
Pn550 (2550h)	2	Analog Monitor 1 Offset Voltage	-10,000 to 10,000	0.1 V	0	All	Immediately	Setup	page 10-7

Continued on next page.

17.1 List of Parameters

17.1.2 List of Parameters

Continued from previous page.

Parameter No.	Size	Name	Setting Range	Setting Unit	Default Setting	Applicable Motors	When Enabled	Classification	Reference																						
Pn551 (2551h)	2	Analog Monitor 2 Offset Voltage	-10,000 to 10,000	0.1 V	0	All	Immediately	Setup	page 10-7																						
Pn552 (2552h)	2	Analog Monitor 1 Magnification	-10,000 to 10,000	× 0.01	100	All	Immediately	Setup	page 10-7																						
Pn553 (2553h)	2	Analog Monitor 2 Magnification	-10,000 to 10,000	× 0.01	100	All	Immediately	Setup	page 10-7																						
Pn55A (255Ah)	2	Power Consumption Monitor Unit Time	1 to 1,440	1 min	1	All	Immediately	Setup	–																						
Pn560 (2560h)	2	Residual Vibration Detection Width	1 to 3,000	0.1%	400	All	Immediately	Setup	page 9-55																						
Pn561 (2561h)	2	Overshoot Detection Level	0 to 100	1%	100	All	Immediately	Setup	page 9-23, page 9-34																						
Pn581 (2581h)	2	Zero Speed Level	1 to 10,000	1 mm/s	20	Linear	Immediately	Setup	page 7-8																						
Pn582 (2582h)	2	Speed Coincidence Detection Signal Output Width	0 to 100	1 mm/s	10	Linear	Immediately	Setup	page 7-9																						
Pn583 (2583h)	2	Brake Reference Output Speed Level	0 to 10,000	1 mm/s	10	Linear	Immediately	Setup	page 6-32																						
Pn584 (2584h)	2	Speed Limit Level at Servo ON	0 to 10,000	1 mm/s	10000	Linear	Immediately	Setup	page 9-10																						
Pn585 (2585h)	2	Program Jogging Movement Speed	1 to 10,000	1 mm/s	50	Linear	Immediately	Setup	page 8-13																						
Pn586 (2586h)	2	Motor Running Cooling Ratio	0 to 100	1%/Max. speed	0	Linear	Immediately	Setup	–																						
Pn587 (2587h)	2	Polarity Detection Execution Selection for Absolute Linear Encoder	0000h to 0001h	–	0000h	Linear	Immediately	Setup	–																						
			<table border="1"> <thead> <tr> <th colspan="3">Polarity Detection Selection for Absolute Linear Encoder</th> <th>Reference</th> </tr> </thead> <tbody> <tr> <td>n.□□□X</td> <td>0</td> <td>Do not detect polarity.</td> <td rowspan="2">page 6-23</td> </tr> <tr> <td>n.□□□X</td> <td>1</td> <td>Detect polarity.</td> </tr> <tr> <td>n.□□□□</td> <td colspan="3">Reserved parameter (Do not change.)</td> </tr> <tr> <td>n.□X□□</td> <td colspan="3">Reserved parameter (Do not change.)</td> </tr> <tr> <td>n.X□□□</td> <td colspan="3">Reserved parameter (Do not change.)</td> </tr> </tbody> </table>								Polarity Detection Selection for Absolute Linear Encoder			Reference	n.□□□X	0	Do not detect polarity.	page 6-23	n.□□□X	1	Detect polarity.	n.□□□□	Reserved parameter (Do not change.)			n.□X□□	Reserved parameter (Do not change.)			n.X□□□	Reserved parameter (Do not change.)
	Polarity Detection Selection for Absolute Linear Encoder			Reference																											
	n.□□□X	0	Do not detect polarity.	page 6-23																											
	n.□□□X	1	Detect polarity.																												
	n.□□□□	Reserved parameter (Do not change.)																													
n.□X□□	Reserved parameter (Do not change.)																														
n.X□□□	Reserved parameter (Do not change.)																														
Pn600 (2600h)	2	Regenerative Resistor Capacity* ²	Depends on model.* ³	10 W	0	All	Immediately	Setup	page 6-55																						
Pn601* ⁶ (2601h)	2	Dynamic Brake Resistor Allowable Energy Consumption	0 to 65,535	10 J	0	All	After restart	Setup	page 5-9																						
Pn603 (2603h)	2	Regenerative Resistance	0 to 65,535	10 mΩ	0	All	Immediately	Setup	page 6-55																						
Pn604* ⁷ (2604h)	2	Dynamic Brake Resistance	0 to 65,535	10 mΩ	0	All	After restart	Setup	page 5-9																						

Continued on next page.

Continued from previous page.

Parameter No.	Size	Name	Setting Range	Setting Unit	Default Setting	Applicable Motors	When Enabled	Classification	Reference	
Pn61A (261Ah)	2	Overheat Protection Selections	0000h to 0003h	–	0000h	Linear	After restart	Setup	page 7-63	
	n.□□□X	Overheat Protection Selections								
		0	Disable overheat protection.							
		1	Use overheat protection in the Yaskawa Linear Servomotor.*8							
		2	Monitor a negative voltage input from a sensor attached to the machine and use overheat protection.							
	3	Monitor a positive voltage input from a sensor attached to the machine and use overheat protection.								
	n.□□X□	Reserved parameter (Do not change.)								
n.□X□□	Reserved parameter (Do not change.)									
n.X□□□	Reserved parameter (Do not change.)									
Pn61B *9 (261Bh)	2	Overheat Alarm Level	0 to 500	0.01 V	250	All	Immediately	Setup	page 7-64	
Pn61C *9 (261Ch)	2	Overheat Warning Level	0 to 100	1%	100	All	Immediately	Setup	page 7-64	
Pn61D *9 (261Dh)	2	Overheat Alarm Filter Time	0 to 65,535	1 s	0	All	Immediately	Setup	page 7-64	
PnBA0 (2752h)	2	ZONE Output Signal Selection 1	0000h to 5555h	–	0000h	All	After restart	Setup	–	
	n.□□□X	/ZONE0 (ZONE Signal 1 Output) Signal Allocation								Reference
		0	Disabled (the above signal output is not used).							page 7-60
		1	Output the signal from the CN1-1 or CN1-2 output terminal.							
		2	Output the signal from the CN1-23 or CN1-24 output terminal.							
		3	Output the signal from the CN1-25 or CN1-26 output terminal.							
		4	Output the signal from the CN1-27 or CN1-28 output terminal.							
	5	Output the signal from the CN1-29 or CN1-30 output terminal.								
	n.□□X□	/ZONE1 (ZONE Signal 2 Output) Signal Allocation								Reference
		0 to 5	The allocations are the same as the /ZONE0 (ZONE Signal 1 Output) signal allocations.							page 7-60
n.□X□□	/ZONE2 (ZONE Signal 3 Output) Signal Allocation								Reference	
	0 to 5	The allocations are the same as the /ZONE0 (ZONE Signal 1 Output) signal allocations.							page 7-60	
n.X□□□	/ZONE3 (ZONE Signal 4 Output) Signal Allocation								Reference	
	0 to 5	The allocations are the same as the /ZONE0 (ZONE Signal 1 Output) signal allocations.							page 7-60	

Continued on next page.

17.1 List of Parameters

17.1.2 List of Parameters

Continued from previous page.

Parameter No.	Size	Name	Setting Range	Setting Unit	Default Setting	Applicable Motors	When Enabled	Classification	Reference	
PnBA1 (2753h)	2	ZONE Output Signal Selection 2	0000h to 0005h	-	0000h	All	After restart	Setup	-	
		/nZONE (nZONE Signal Output) Signal Allocation							Reference	
		n.□□□X	0	Disabled (the above signal output is not used).						page 7-61
			1	Output the signal from the CN1-1 or CN1-2 output terminal.						
			2	Output the signal from the CN1-23 or CN1-24 output terminal.						
			3	Output the signal from the CN1-25 or CN1-26 output terminal.						
			4	Output the signal from the CN1-27 or CN1-28 output terminal.						
			5	Output the signal from the CN1-29 or CN1-30 output terminal.						
		n.□□X□	Reserved parameter (Do not change.)							
		n.□X□□	Reserved parameter (Do not change.)							
	n.X□□□	Reserved parameter (Do not change.)								

- *1. Set a percentage of the motor rated torque.
- *2. Normally set this parameter to 0. If you use an External Regenerative Resistor, set the capacity (W) of the External Regenerative Resistor.
- *3. The upper limit is the maximum output capacity (W) of the SERVOPACK.
- *4. With EtherCAT (CoE), this is automatically set when the power supply is turned ON.
- *5. The default setting is 32 for a SERVOPACK with built-in Servomotor brake control.
- *6. SGD7S-210D to 370D SERVOPACKs require three Dynamic Brake Resistors. For this parameter setting, enter the total value of resistor capacity of the three resistors.
- *7. SGD7S-210D to 370D SERVOPACKs require three Dynamic Brake Resistors. For this parameter setting, enter the resistance of one Dynamic Brake Resistor multiplied by $\sqrt{3}$.
- *8. The SGLFW2 is the only Yaskawa Linear Servomotor that supports this function.
- *9. Enabled only when Pn61A is set to n.□□□2 or n.□□□3.

17.2 Object List

Index	Subindex	Name	Data Type	Access	PDO Mapping	Saving to EEPROM ^{*1}	Default Value	Lower Limit	Upper Limit	Unit	Parameter No. ^{*2}
1000h	0	Device type	UDINT	RO	No	No	0x00020192	–	–	–	–
1001h	0	Error register	USINT	RO	No	No	–	–	–	–	–
1008h	0	Manufacturer device name	STRING	RO	No	No	–	–	–	–	–
100Ah	0	Manufacturer software version	STRING	RO	No	No	–	–	–	–	–
Store parameters field											
1010h	0	Largest subindex supported	USINT	RO	No	No	4	–	–	–	–
	1	Save all parameters	UDINT	RW	No	No	0x00000001	0x00000000	0xFFFFFFFF	–	PnC00 ^{*3,*4}
	2	Save communication parameters	UDINT	RW	No	No	0x00000001	0x00000000	0xFFFFFFFF	–	PnC02 ^{*3,*4}
	3	Save application parameters	UDINT	RW	No	No	0x00000001	0x00000000	0xFFFFFFFF	–	PnC04 ^{*3,*4}
	4	Save manufacturer defined parameters	UDINT	RW	No	No	0x00000001	0x00000000	0xFFFFFFFF	–	PnC06 ^{*3,*4}
Restore default parameters											
1011h	0	Largest subindex supported	USINT	RO	No	No	4	–	–	–	–
	1	Restore all default parameters	UDINT	RW	No	No	0x00000001	0x00000000	0xFFFFFFFF	–	PnC08 ^{*3,*4}
	2	Restore communication default parameters	UDINT	RW	No	No	0x00000001	0x00000000	0xFFFFFFFF	–	PnC0A ^{*3,*4}
	3	Restore application default parameters	UDINT	RW	No	No	0x00000001	0x00000000	0xFFFFFFFF	–	PnC0C ^{*3,*4}
	4	Restore manufacturer defined default parameters	UDINT	RW	No	No	0x00000001	0x00000000	0xFFFFFFFF	–	PnC0E ^{*3,*4}
Identity object											
1018h	0	Number of entries	USINT	RO	No	No	4	–	–	–	–
	1	Vendor ID	UDINT	RO	No	No	0x539	–	–	–	–
	2	Product code	UDINT	RO	No	No	0x02200401 ^{*5}	–	–	–	–
	3	Revision number	UDINT	RO	No	No	–	–	–	–	–
	4	Serial number	UDINT	RO	No	No	0	–	–	–	–
Sync error settings											
10F1h ^{*6}	0	Number of entries	USINT	RO	No	No	2	–	–	–	–
	1	Reserved	UDINT	RO	No	No	0	–	–	–	–
	2	Sync error counter limit	UDINT	RW	No	No	9	0	15	–	PnCCC
1st receive PDO mapping											
1600h	0	Number of objects in this PDO	USINT	RW	No	Yes	8	0	8	–	PnCA0
	1	Mapping entry 1	UDINT	RW	No	Yes	0x60400010	0	0xFFFFFFFF	–	PnC20
	2	Mapping entry 2	UDINT	RW	No	Yes	0x607A0020	0	0xFFFFFFFF	–	PnC22
	3	Mapping entry 3	UDINT	RW	No	Yes	0x60FF0020	0	0xFFFFFFFF	–	PnC24
	4	Mapping entry 4	UDINT	RW	No	Yes	0x60710010	0	0xFFFFFFFF	–	PnC26
	5	Mapping entry 5	UDINT	RW	No	Yes	0x60720010	0	0xFFFFFFFF	–	PnC28
	6	Mapping entry 6	UDINT	RW	No	Yes	0x60600008	0	0xFFFFFFFF	–	PnC2A
	7	Mapping entry 7	UDINT	RW	No	Yes	0x00000008	0	0xFFFFFFFF	–	PnC2C
	8	Mapping entry 8	UDINT	RW	No	Yes	0x60B80010	0	0xFFFFFFFF	–	PnC2E

Continued on next page.

Continued from previous page.

Index	Sub-index	Name	Data Type	Access	PDO Mapping	Saving to EEPROM ^{*1}	Default Value	Lower Limit	Upper Limit	Unit	Parameter No. ^{*2}
1601h	2nd receive PDO mapping										
	0	Number of objects in this PDO	USINT	RW	No	Yes	2	0	8	-	PnCA1
	1	Mapping entry 1	UDINT	RW	No	Yes	0x60400010	0	0xFFFFFFFF	-	PnC30
	2	Mapping entry 2	UDINT	RW	No	Yes	0x607A0020	0	0xFFFFFFFF	-	PnC32
	3	Mapping entry 3	UDINT	RW	No	Yes	0	0	0xFFFFFFFF	-	PnC34
	4	Mapping entry 4	UDINT	RW	No	Yes	0	0	0xFFFFFFFF	-	PnC36
	5	Mapping entry 5	UDINT	RW	No	Yes	0	0	0xFFFFFFFF	-	PnC38
	6	Mapping entry 6	UDINT	RW	No	Yes	0	0	0xFFFFFFFF	-	PnC3A
	7	Mapping entry 7	UDINT	RW	No	Yes	0	0	0xFFFFFFFF	-	PnC3C
8	Mapping entry 8	UDINT	RW	No	Yes	0	0	0xFFFFFFFF	-	PnC3E	
1602h	3rd receive PDO mapping										
	0	Number of objects in this PDO	USINT	RW	No	Yes	2	0	8	-	PnCA2
	1	Mapping entry 1	UDINT	RW	No	Yes	0x60400010	0	0xFFFFFFFF	-	PnC40
	2	Mapping entry 2	UDINT	RW	No	Yes	0x60FF0020	0	0xFFFFFFFF	-	PnC42
	3	Mapping entry 3	UDINT	RW	No	Yes	0	0	0xFFFFFFFF	-	PnC44
	4	Mapping entry 4	UDINT	RW	No	Yes	0	0	0xFFFFFFFF	-	PnC46
	5	Mapping entry 5	UDINT	RW	No	Yes	0	0	0xFFFFFFFF	-	PnC48
	6	Mapping entry 6	UDINT	RW	No	Yes	0	0	0xFFFFFFFF	-	PnC4A
	7	Mapping entry 7	UDINT	RW	No	Yes	0	0	0xFFFFFFFF	-	PnC4C
8	Mapping entry 8	UDINT	RW	No	Yes	0	0	0xFFFFFFFF	-	PnC4E	
1603h	4th receive PDO mapping										
	0	Number of objects in this PDO	USINT	RW	No	Yes	2	0	8	-	PnCA3
	1	Mapping entry 1	UDINT	RW	No	Yes	0x60400010	0	0xFFFFFFFF	-	PnC50
	2	Mapping entry 2	UDINT	RW	No	Yes	0x60710010	0	0xFFFFFFFF	-	PnC52
	3	Mapping entry 3	UDINT	RW	No	Yes	0	0	0xFFFFFFFF	-	PnC54
	4	Mapping entry 4	UDINT	RW	No	Yes	0	0	0xFFFFFFFF	-	PnC56
	5	Mapping entry 5	UDINT	RW	No	Yes	0	0	0xFFFFFFFF	-	PnC58
	6	Mapping entry 6	UDINT	RW	No	Yes	0	0	0xFFFFFFFF	-	PnC5A
	7	Mapping entry 7	UDINT	RW	No	Yes	0	0	0xFFFFFFFF	-	PnC5C
8	Mapping entry 8	UDINT	RW	No	Yes	0	0	0xFFFFFFFF	-	PnC5E	
1A00h	1st transmit PDO mapping										
	0	Number of objects in this PDO	USINT	RW	No	Yes	8	0	8	-	PnCA4
	1	Mapping entry 1	UDINT	RW	No	Yes	0x60410010	0	0xFFFFFFFF	-	PnC60
	2	Mapping entry 2	UDINT	RW	No	Yes	0x60640020	0	0xFFFFFFFF	-	PnC62
	3	Mapping entry 3	UDINT	RW	No	Yes	0x60770010	0	0xFFFFFFFF	-	PnC64
	4	Mapping entry 4	UDINT	RW	No	Yes	0x60F40020	0	0xFFFFFFFF	-	PnC66
	5	Mapping entry 5	UDINT	RW	No	Yes	0x60610008	0	0xFFFFFFFF	-	PnC68
	6	Mapping entry 6	UDINT	RW	No	Yes	0x00000008	0	0xFFFFFFFF	-	PnC6A
	7	Mapping entry 7	UDINT	RW	No	Yes	0x60B90010	0	0xFFFFFFFF	-	PnC6C
8	Mapping entry 8	UDINT	RW	No	Yes	0x60BA0020	0	0xFFFFFFFF	-	PnC6E	
1A01h	2nd transmit PDO mapping										
	0	Number of objects in this PDO	USINT	RW	No	Yes	2	0	8	-	PnCA5
	1	Mapping entry 1	UDINT	RW	No	Yes	0x60410010	0	0xFFFFFFFF	-	PnC70
	2	Mapping entry 2	UDINT	RW	No	Yes	0x60640020	0	0xFFFFFFFF	-	PnC72
	3	Mapping entry 3	UDINT	RW	No	Yes	0	0	0xFFFFFFFF	-	PnC74
	4	Mapping entry 4	UDINT	RW	No	Yes	0	0	0xFFFFFFFF	-	PnC76
	5	Mapping entry 5	UDINT	RW	No	Yes	0	0	0xFFFFFFFF	-	PnC78
	6	Mapping entry 6	UDINT	RW	No	Yes	0	0	0xFFFFFFFF	-	PnC7A
	7	Mapping entry 7	UDINT	RW	No	Yes	0	0	0xFFFFFFFF	-	PnC7C
8	Mapping entry 8	UDINT	RW	No	Yes	0	0	0xFFFFFFFF	-	PnC7E	

Continued on next page.

Continued from previous page.

Index	Subindex	Name	Data Type	Access	PDO Mapping	Saving to EEPROM*1	Default Value	Lower Limit	Upper Limit	Unit	Parameter No.*2
1A02h	3rd transmit PDO mapping										
	0	Number of objects in this PDO	USINT	RW	No	Yes	2	0	8	–	PnCA6
	1	Mapping entry 1	UDINT	RW	No	Yes	0x60410010	0	0xFFFFFFFF	–	PnC80
	2	Mapping entry 2	UDINT	RW	No	Yes	0x60640020	0	0xFFFFFFFF	–	PnC82
	3	Mapping entry 3	UDINT	RW	No	Yes	0	0	0xFFFFFFFF	–	PnC84
	4	Mapping entry 4	UDINT	RW	No	Yes	0	0	0xFFFFFFFF	–	PnC86
	5	Mapping entry 5	UDINT	RW	No	Yes	0	0	0xFFFFFFFF	–	PnC88
	6	Mapping entry 6	UDINT	RW	No	Yes	0	0	0xFFFFFFFF	–	PnC8A
	7	Mapping entry 7	UDINT	RW	No	Yes	0	0	0xFFFFFFFF	–	PnC8C
8	Mapping entry 8	UDINT	RW	No	Yes	0	0	0xFFFFFFFF	–	PnC8E	
1A03h	4th transmit PDO mapping										
	0	Number of objects in this PDO	USINT	RW	No	Yes	3	0	8	–	PnCA7
	1	Mapping entry 1	UDINT	RW	No	Yes	0x60410010	0	0xFFFFFFFF	–	PnC90
	2	Mapping entry 2	UDINT	RW	No	Yes	0x60640020	0	0xFFFFFFFF	–	PnC92
	3	Mapping entry 3	UDINT	RW	No	Yes	0x60770010	0	0xFFFFFFFF	–	PnC94
	4	Mapping entry 4	UDINT	RW	No	Yes	0	0	0xFFFFFFFF	–	PnC96
	5	Mapping entry 5	UDINT	RW	No	Yes	0	0	0xFFFFFFFF	–	PnC98
	6	Mapping entry 6	UDINT	RW	No	Yes	0	0	0xFFFFFFFF	–	PnC9A
	7	Mapping entry 7	UDINT	RW	No	Yes	0	0	0xFFFFFFFF	–	PnC9C
8	Mapping entry 8	UDINT	RW	No	Yes	0	0	0xFFFFFFFF	–	PnC9E	
1C00h	Sync Manager communication type										
	0	Number of used Sync Manager channels	USINT	RO	No	No	4	–	–	–	–
	1	Communication type sync manager 0	USINT	RO	No	No	1	–	–	–	PnCB0*4
	2	Communication type sync manager 1	USINT	RO	No	No	2	–	–	–	PnCB1*4
	3	Communication type sync manager 2	USINT	RO	No	No	3	–	–	–	PnCB2*4
1C10h	0	Sync Manager PDO assignment 0	USINT	RO	No	No	0	–	–	–	–
1C11h	0	Sync Manager PDO assignment 1	USINT	RO	No	No	0	–	–	–	–
1C12h	Sync Manager PDO assignment 2										
	0	Number of assigned PDOs	USINT	RW	No	Yes	1	0	2	–	PnCB5
	1	Index of assigned RxPDO 1	UINT	RW	No	Yes	0x1601	0x1600	0x1603	–	PnCB6
	2	Index of assigned RxPDO 2	UINT	RW	No	Yes	0x1600	0x1600	0x1603	–	PnCB7
1C13h	Sync Manager PDO assignment 3										
	0	Number of assigned PDOs	USINT	RW	No	Yes	1	0	2	–	PnCBB
	1	Index of assigned TxPDO 1	UINT	RW	No	Yes	0x1A01	0x1A00	0x1A03	–	PnCBC
	2	Index of assigned TxPDO 2	UINT	RW	No	Yes	0x1A00	0x1A00	0x1A03	–	PnCBD

Continued on next page.

Continued from previous page.

Index	Sub-index	Name	Data Type	Access	PDO Mapping	Saving to EEPROM ^{*1}	Default Value	Lower Limit	Upper Limit	Unit	Parameter No. ^{*2}
1C32h	Sync Manager channel 2 synchronization										
	0	Number of synchronization parameters	USINT	RO	No	No	12	-	-	-	-
	1	Synchronization type	UINT	RO	No	No	-	-	-	-	PnCC0 ^{*4}
	2	Cycle time	UDINT	RO	No	No	-	-	-	-	PnCC2 ^{*4}
	3	Shift time	UDINT	RO	No	No	250000	-	-	-	PnCC4 ^{*4}
	4	Synchronization types supported	UINT	RO	No	No	0x0005	-	-	-	-
	5	Minimum cycle time	UDINT	RO	No	No	62500	-	-	-	-
	6	Calc and copy time	UDINT	RO	No	No	62500	-	-	-	-
	7	Reserved	UDINT	RO	No	No	0	-	-	-	-
	8	Reserved	UINT	RO	No	No	0	-	-	-	-
	9	Delay time	UDINT	RO	No	No	0	-	-	-	-
	10	Sync0 cycle time	UDINT	RO	No	No	-	-	-	-	PnCC6 ^{*4}
	11	Reserved	UDINT	RO	No	No	0	-	-	-	-
12	SM2 event miss count	UDINT	RO	No	No	-	-	-	-	PnCC8 ^{*4}	
1C33h	Sync Manager channel 3 synchronization										
	0	Number of synchronization parameters	USINT	RO	No	No	10	-	-	-	-
	1	Synchronization type	UINT	RO	No	No	-	-	-	-	-
	2	Cycle time	UDINT	RO	No	No	-	-	-	-	-
	3	Shift time	UDINT	RW	No	Yes	0	0	Sync0 event cycle - 12,500	-	PnCCA
	4	Synchronization types supported	UINT	RO	No	No	0x0025	-	-	-	-
	5	Minimum cycle time	UDINT	RO	No	No	62500	-	-	-	-
	6	Calc and copy time	UDINT	RO	No	No	62500	-	-	-	-
	7	Reserved	UDINT	RO	No	No	0	-	-	-	-
	8	Reserved	UINT	RO	No	No	0	-	-	-	-
	9	Delay time	UDINT	RO	No	No	0	-	-	-	-
10	Sync0 cycle time	UDINT	RO	No	No	-	-	-	-	-	
2000h to 26FFh	0	SERVOPACK parameters (Pn000 (2000h) to Pn6FF (26FFh))	-	-	-	-	-	-	-	-	Pn000 ^{*7} - Pn6FF ^{*7}
2700h	0	User parameter Configuration	UDINT	RW	No	No	0	0	0xFFFFFFFF	-	PnB00
2701h	Position user unit										
	0	Number of entries	USINT	RO	No	No	2	-	-	-	-
	1	Numerator	UDINT	RW	No	Yes	1	1	1073741823	-	PnB02
	2	Denominator	UDINT	RW	No	Yes	1	1	1073741823	-	PnB04
2702h	Velocity user unit										
	0	Number of entries	USINT	RO	No	No	2	-	-	-	-
	1	Numerator	UDINT	RW	No	Yes	1	1	1073741823	-	PnB06
	2	Denominator	UDINT	RW	No	Yes	1	1	1073741823	-	PnB08
2703h	Acceleration user unit										
	0	Number of entries	USINT	RO	No	No	2	-	-	-	-
	1	Numerator	UDINT	RW	No	Yes	1	1	1073741823	-	PnB0A
	2	Denominator	UDINT	RW	No	Yes	1	1	1073741823	-	PnB0C
2704h	Torque user unit										
	0	Number of entries	USINT	RO	No	No	2	-	-	-	-
	1	Numerator	UDINT	RW	No	Yes	1	1	1073741823	-	PnB94
	2	Denominator	UDINT	RW	No	Yes	10	1	1073741823	-	PnB96
2705h	0	Encoder Selection	UINT	RW	No	Yes	0x0000	0x0000	0x0001	-	PnB9C

Continued on next page.

Continued from previous page.

Index	Subindex	Name	Data Type	Access	PDO Mapping	Saving to EEPROM*1	Default Value	Lower Limit	Upper Limit	Unit	Parameter No.*2
2710h	SERVOPACK adjusting command										
	0	Number of entries	USINT	RO	No	No	3	-	-	-	-
	1	Command	STRING	RW	No	No	0	0	0xFF	-	-
	2	Status	USINT	RO	No	No	-	-	-	-	-
	3	Reply	STRING	RO	No	No	-	-	-	-	-
2730h	Interpolation data configuration for 1st profile										
	0	Number of entries	USINT	RO	No	No	9	-	-	-	-
	1	Maximum buffer size	UDINT	RO	No	No	254	-	-	-	-
	2	Actual buffer size	UDINT	RW	No	No	254	-	-	-	-
	3	Buffer organization	USINT	RW	No	No	0	0	1	-	PnCEC
	4	Buffer position	UINT	RW	Yes	No	1	1	254	-	PnCED
	5	Size of data record	USINT	RO	No	No	1	1	1	-	-
	6	Buffer clear	USINT	RO	No	No	0	0	1	-	-
	7	Position data definition	USINT	RW	Yes	No	1	0	1	-	PnCEE
	8	Position data polarity	USINT	RW	Yes	No	0	0	1	-	PnCEF
	9	Behavior after reaching buffer position	USINT	RW	Yes	No	0	0	1	-	PnCF0
2731h	Interpolation data configuration for 2nd profile										
	0	Number of entries	USINT	RO	No	No	9	-	-	-	-
	1	Maximum buffer size	UDINT	RO	No	No	254	-	-	-	-
	2	Actual buffer size	UDINT	RW	No	No	254	-	-	-	-
	3	Buffer organization	USINT	RW	No	No	0	0	1	-	PnCF1
	4	Buffer position	UINT	RW	Yes	No	1	1	254	-	PnCF2
	5	Size of data record	USINT	RO	No	No	1	1	1	-	-
	6	Buffer clear	USINT	RO	No	No	0	0	1	-	-
	7	Position data definition	USINT	RW	Yes	No	1	0	1	-	PnCF3
	8	Position data polarity	USINT	RW	Yes	No	0	0	1	-	PnCF4
	9	Behavior after reaching buffer position	USINT	RW	Yes	No	0	0	1	-	PnCF5
2732h	0	Interpolation profile select	USINT	RW	Yes	No	0	0	1	-	PnCF6
2741h	Interpolation data read/write pointer position monitor										
	0	Number of entries	USINT	RO	No	No	2	-	-	-	-
	1	Interpolation data read pointer position	UINT	RO	Yes	No	-	1	254	-	PnCF7*4
	2	Interpolation data write pointer position	UINT	RO	Yes	No	-	1	254	-	PnCF8*4

Continued on next page.

Continued from previous page.

Index	Subindex	Name	Data Type	Access	PDO Mapping	Saving to EEPROM ^{*1}	Default Value	Lower Limit	Upper Limit	Unit	Parameter No. ^{*2}
2750h	ZONE table positive side boundary position (ZONE P)										
	0	Number of entries	USINT	RO	No	No	16	-	-	-	-
	1	ZONE ID0	DINT	RW	No	Yes	0	-2147483648	2147483647	Pos. unit	PnA00 ^{*8}
	2	ZONE ID1	DINT	RW	No	Yes	0	-2147483648	2147483647	Pos. unit	PnA04 ^{*8}
	3	ZONE ID2	DINT	RW	No	Yes	0	-2147483648	2147483647	Pos. unit	PnA08 ^{*8}
	4	ZONE ID3	DINT	RW	No	Yes	0	-2147483648	2147483647	Pos. unit	PnA0C ^{*8}
	5	ZONE ID4	DINT	RW	No	Yes	0	-2147483648	2147483647	Pos. unit	PnA10 ^{*8}
	6	ZONE ID5	DINT	RW	No	Yes	0	-2147483648	2147483647	Pos. unit	PnA14 ^{*8}
	7	ZONE ID6	DINT	RW	No	Yes	0	-2147483648	2147483647	Pos. unit	PnA18 ^{*8}
	8	ZONE ID7	DINT	RW	No	Yes	0	-2147483648	2147483647	Pos. unit	PnA1C ^{*8}
	9	ZONE ID8	DINT	RW	No	Yes	0	-2147483648	2147483647	Pos. unit	PnA20 ^{*8}
	10	ZONE ID9	DINT	RW	No	Yes	0	-2147483648	2147483647	Pos. unit	PnA24 ^{*8}
	11	ZONE ID10	DINT	RW	No	Yes	0	-2147483648	2147483647	Pos. unit	PnA28 ^{*8}
	12	ZONE ID11	DINT	RW	No	Yes	0	-2147483648	2147483647	Pos. unit	PnA2C ^{*8}
	13	ZONE ID12	DINT	RW	No	Yes	0	-2147483648	2147483647	Pos. unit	PnA30 ^{*8}
	14	ZONE ID13	DINT	RW	No	Yes	0	-2147483648	2147483647	Pos. unit	PnA34 ^{*8}
15	ZONE ID14	DINT	RW	No	Yes	0	-2147483648	2147483647	Pos. unit	PnA38 ^{*8}	
16	ZONE ID15	DINT	RW	No	Yes	0	-2147483648	2147483647	Pos. unit	PnA3C ^{*8}	

Continued on next page.

Continued from previous page.

Index	Subindex	Name	Data Type	Access	PDO Mapping	Saving to EEPROM*1	Default Value	Lower Limit	Upper Limit	Unit	Parameter No.*2
2751h	ZONE table negative side boundary position (ZONE N)										
	0	Number of entries	USINT	RO	No	No	16	-	-	-	-
	1	ZONE ID0	DINT	RW	No	Yes	0	-2147483648	2147483647	Pos. unit	PnA02
	2	ZONE ID1	DINT	RW	No	Yes	0	-2147483648	2147483647	Pos. unit	PnA06
	3	ZONE ID2	DINT	RW	No	Yes	0	-2147483648	2147483647	Pos. unit	PnA0A
	4	ZONE ID3	DINT	RW	No	Yes	0	-2147483648	2147483647	Pos. unit	PnA0E
	5	ZONE ID4	DINT	RW	No	Yes	0	-2147483648	2147483647	Pos. unit	PnA12
	6	ZONE ID5	DINT	RW	No	Yes	0	-2147483648	2147483647	Pos. unit	PnA16
	7	ZONE ID6	DINT	RW	No	Yes	0	-2147483648	2147483647	Pos. unit	PnA1A
	8	ZONE ID7	DINT	RW	No	Yes	0	-2147483648	2147483647	Pos. unit	PnA1E
	9	ZONE ID8	DINT	RW	No	Yes	0	-2147483648	2147483647	Pos. unit	PnA22
	10	ZONE ID9	DINT	RW	No	Yes	0	-2147483648	2147483647	Pos. unit	PnA26
	11	ZONE ID10	DINT	RW	No	Yes	0	-2147483648	2147483647	Pos. unit	PnA2A
	12	ZONE ID11	DINT	RW	No	Yes	0	-2147483648	2147483647	Pos. unit	PnA2E
	13	ZONE ID12	DINT	RW	No	Yes	0	-2147483648	2147483647	Pos. unit	PnA32
	14	ZONE ID13	DINT	RW	No	Yes	0	-2147483648	2147483647	Pos. unit	PnA36
	15	ZONE ID14	DINT	RW	No	Yes	0	-2147483648	2147483647	Pos. unit	PnA3A
16	ZONE ID15	DINT	RW	No	Yes	0	-2147483648	2147483647	Pos. unit	PnA3E	
2752h	0	ZONE output signal selection 1	USINT	RW	No	Yes	0	0000	0xFFFF	-	PnBA0
2753h	0	ZONE output signal selection 2	USINT	RW	No	Yes	0	0000	0x000F	-	PnBA1
27C0h	Interpolation data record for 1st profile										
	0	Number of entries	USINT	RO	No	No	0	-	-	-	-
	1 to 254	1st set-point to 254 set-point	DINT	RW	No	No	254	-2147483648	2147483647	-	-
27C1h	Interpolation data record for 2nd profile										
	0	Number of entries	USINT	RO	No	No	0	-	-	-	-
	1 to 254	1st set-point to 254 set-point	DINT	RW	No	No	254	-2147483648	2147483647	-	-
27E0h	-	Diag. mode	UINT	RW	No	No	0	0	0xFFFF	-	PnCFE
603Fh	0	Error code	UINT	RO	Yes	No	-	-	-	-	PnB10*4
6040h	0	Controlword	UINT	RW	Yes	No	0	0	0xFFFF	-	PnB11
6041h	0	Statusword	UINT	RO	Yes	No	-	-	-	-	PnB12*4
605Ah	0	Quick stop option code	INT	RW	No	Yes	2	0	4	-	PnB13
605Bh	0	Shutdown option code	INT	RW	No	Yes	0	0	1	-	PnB14
605Ch	0	Disable operation option code	INT	RW	No	Yes	1	0	1	-	PnB15
605Dh	0	Halt option code	INT	RW	No	Yes	1	0	4	-	PnB16
605Eh	0	Fault reaction option code	INT	RW	No	Yes	0	0	0	-	PnB17
6060h	0	Modes of operation	SINT	RW	Yes	Yes	0	0	10	-	PnB18
6061h	0	Modes of operation display	SINT	RO	Yes	No	0	-	-	-	PnB19*4

Continued on next page.

Continued from previous page.

Index	Sub-index	Name	Data Type	Access	PDO Mapping	Saving to EEPROM ^{*1}	Default Value	Lower Limit	Upper Limit	Unit	Parameter No. ^{*2}
6062h	0	Position demand value	DINT	RO	Yes	No	-	-	-	Pos. unit	PnB20 ^{*4}
6063h	0	Position actual internal value	DINT	RO	Yes	No	-	-	-	Inc	PnB22 ^{*4}
6064h	0	Position actual value	DINT	RO	Yes	No	-	-	-	Pos. unit	PnB24 ^{*4}
6065h	0	Following error window	UDINT	RW	No	Yes	5242880	0	1073741823	Pos. unit	PnB26
6066h	0	Following error time out	UINT	RW	No	Yes	0	0	65535	ms	PnB28
6067h	0	Position window	UDINT	RW	No	Yes	30	0	1073741823	Pos. unit	PnB2A
6068h	0	Position window time	UINT	RW	No	Yes	0	0	65535	ms	PnB2C
606Bh	0	Velocity demand value	DINT	RO	Yes	No	-	-	-	Vel. Unit	PnB2E ^{*4}
606Ch	0	Velocity actual value	DINT	RO	Yes	No	-	-	-	Vel. Unit	PnB30 ^{*4}
606Dh	0	Velocity window	UINT	RW	No	Yes	20000	0	65535	Vel. Unit	PnB32
606Eh	0	Velocity window time	UINT	RW	No	Yes	0	0	65535	ms	PnB34
6071h	0	Target torque	INT	RW	Yes	No	0	-32768	32767	0.1 %	PnB36
6072h	0	Max torque	UINT	RW	Yes	No	Motor max torque	0	65535	0.1 %	PnB38
6074h	0	Max current	INT	RO	Yes	No	-	-	-	0.1 %	PnB3A ^{*4}
6076h	0	Motor rated torque	UDINT	RO	No	No	-	-	-	mNm, mN	PnB3C ^{*4}
6077h	0	Torque actual value	INT	RO	Yes	No	-	-	-	0.1 %	PnB3E ^{*4}
607Ah	0	Target position	DINT	RW	Yes	No	0	-2147483648	2147483647	Pos. unit	PnB40
607Ch	-	Home offset	DINT	RW	No	Yes	0	-536870912	536870911	Pos. unit	PnB46
607Dh	Software position limit										
	0	Number of entries	USINT	RO	No	No	2	-	-	-	-
	1	Min position limit	DINT	RW	No	Yes	0	-536870912	536870911	Pos. unit	PnB48
607Fh	2	Max position limit	DINT	RW	No	Yes	0	-536870912	536870911	Pos. unit	PnB4A
	0	Max profile velocity	UDINT	RW	Yes	Yes	2147483647	0	4294967295	Vel. Unit	PnB4C
6081h	0	Profile velocity	UDINT	RW	Yes	Yes	0	0	4294967295	Vel. Unit	PnB4E
6083h	0	Profile acceleration	UDINT	RW	Yes	Yes	1000	0	4294967295	Acc. Unit	PnB50
6084h	0	Profile deceleration	UDINT	RW	Yes	Yes	1000	0	4294967295	Acc. Unit	PnB52
6085h	0	Quick stop deceleration	UDINT	RW	Yes	Yes	1000	0	4294967295	Acc. Unit	PnB54
6086h	0	Motion profile type	INT	RW	Yes	Yes	0	-32768	32767	-	PnB98
6087h	0	Torque slope	UDINT	RW	Yes	Yes	1000	0	4294967295	0.1 %/s	PnB56
6098h	0	Homing method	SINT	RW	Yes	No	35	0	35	-	PnB58
6099h	Homing speeds										
	0	Number of entries	USINT	RO	No	No	2	-	-	-	-
	1	Speed during search for switch	UDINT	RW	Yes	Yes	500000	0	4294967295	Vel. Unit	PnB5A
609Ah	2	Speed during search for zero	UDINT	RW	Yes	Yes	100000	0	4294967295	Vel. Unit	PnB5C
	0	Homing acceleration	UDINT	RW	Yes	Yes	1000	0	4294967295	Acc. Unit	PnB5E

Continued on next page.

Continued from previous page.

Index	Subindex	Name	Data Type	Access	PDO Mapping	Saving to EEPROM*1	Default Value	Lower Limit	Upper Limit	Unit	Parameter No.*2
Profile jerk											
60A4h	0	Number of entries	USINT	RO	No	No	1	-	-	-	-
	1	Profile jerk1	UDINT	RW	No	Yes	25	0	50	%	PnB9A
60B1h	0	Velocity offset	DINT	RW	Yes	No	0	-2147483648	2147483647	Vel. Unit	PnB60
60B2h	0	Torque offset	INT	RW	Yes	No	0	-32768	32767	0.1 %	PnB62
60B8h	0	Touch probe function	UINT	RW	Yes	No	0	0	0xFFFF	-	PnB64
60B9h	0	Touch probe status	UINT	RO	Yes	No	-	-	-	-	PnB66*4
60BAh	0	Touch probe pos1 pos value	DINT	RO	Yes	No	-	-	-	Pos. unit	PnB68*4
60BCh	0	Touch probe pos2 pos value	DINT	RO	Yes	No	-	-	-	Pos. unit	PnB6A*4
60C0h	0	Interpolation sub mode select	INT	RW	No	No	0	-3	0	-	PnB92
Interpolation data record											
60C1h	0	Number of entries	USINT	RO	No	No	1	-	-	-	-
	1	Interpolation data record	DINT	RW	Yes	No	0	-2147483648	2147483647	Pos. unit	PnB70
Interpolation time period											
60C2h	0	Number of entries	USINT	RO	No	No	2	-	-	-	-
	1	Interpolation time period value	USINT	RW	No	No	125	1	250	-	PnB6E
	2	Interpolation time index	SINT	RW	No	No	-6	-6	-3	-	PnB6F
60E0h	0	Positive torque limit value	UINT	RW	Yes	Yes	8000	0	65535	0.1 %	PnB80
60E1h	0	Negative torque limit value	UINT	RW	Yes	Yes	8000	0	65535	0.1 %	PnB82
Additional position actual value											
60E4h	0	Number of entries	USINT	RO	No	No	1	-	-	-	-
	1	External encoder position	DINT	RO	Yes	Yes	0	-	-	-	-
60F4h	0	Following error actual value	DINT	RO	Yes	No	-	-	-	Pos. unit	PnB84*4
60FCh	0	Position demand internal value	DINT	RO	Yes	No	-	-	-	Inc	PnB86*4
60FDh	0	Digital inputs	UDINT	RO	Yes	No	-	-	-	-	PnB88*4
Digital outputs											
60FEh	0	Number of entries	USINT	RO	No	No	2	-	-	-	-
	1	Physical outputs	UDINT	RW	Yes	No	0	0	0xFFFFFFFF	-	PnB8A
	2	Bit mask	UDINT	RW	No	Yes	0x000C0000	0	0xFFFFFFFF	-	PnB8C
60FFh	0	Target velocity	DINT	RW	Yes	No	0	-2147483648	2147483647	Vel. Unit	PnB8E
6502h	0	Supported drive modes	UDINT	RO	No	No	0x03ED	-	-	-	PnB90*4

*1. Write "Save" to object 1010h to save all of the current parameter data to EEPROM.

If the objects are modified by the Digital Operator or SigmaWin+, the data will be directly saved in EEPROM.

*2. The parameter numbers given in the table are the parameter numbers that are used with the Digital Operator and SigmaWin+.

*3. These parameters cannot be written by the Digital Operator.

*4. These parameters are not displayed on the SigmaWin+.

*5. For SGD7S-□□□DA0: 0x02200401.

*6. Both 10F1h and 1F01h have the same function. You can set either object.

*7. Refer to the following section for details on the parameter.

 17.1.2 List of Parameters on page 17-3

Parameter numbers that are not on the list will not be displayed on the SigmaWin+ and Digital Operator.

*8. Use the Edit Zone Table function if setting this parameter using the SigmaWin+.

A zone ID number (not the parameter number) is displayed on the Zone Table Editing Dialog Box. When using the Digital Operator, use the parameter number.

17.3 SDO Abort Code List

The following table gives the SDO abort codes for SDO communications errors.

Value	Meaning
0x05 03 00 00	Toggle bit did not change.
0x05 04 00 00	SDO protocol timeout
0x05 04 00 01	Client/server command specifier is not valid or is unknown.
0x05 04 00 05	Out of memory
0x06 01 00 00	Unsupported access to an object
0x06 01 00 01	Attempt to read to a write-only object
0x06 01 00 02	Attempt to write to a read-only object
0x06 02 00 00	The object does not exist in the object directory.
0x06 04 00 41	The object cannot be mapped to the PDO.
0x06 04 00 42	The number and length of the objects to be mapped would exceed the PDO length.
0x06 04 00 43	General parameter incompatibility
0x06 04 00 47	General internal incompatibility in the device
0x06 06 00 00	Access failed due to a hardware error.
0x06 07 00 10	Data type does not match: length of service parameter does not match.
0x06 07 00 12	Data type does not match: service parameter too long.
0x06 07 00 13	Data type does not match: service parameter too short.
0x06 09 00 11	Subindex does not exist.
0x06 09 00 30	Value range of parameter was exceeded (only for write access).
0x06 09 00 31	Value of parameter that was written is too high.
0x06 09 00 32	Value of parameter that was written is too low.
0x06 09 00 36	The maximum value is less than the minimum value.
0x08 00 00 00	General error
0x08 00 00 20	Data cannot be transferred or stored to the application.
0x08 00 00 21	Data cannot be transferred or stored to the application because of local control.
0x08 00 00 22	Data cannot be transferred or stored to the application because of the present device state.

17.4 Parameter Recording Table

Use the following table to record the settings of the parameters.

Parameter No.	Default Setting					Name	When Enabled
Pn000 (2000h)	0000h					Basic Function Selections 0	After restart
Pn001 (2001h)	0000h					Application Function Selections 1	After restart
Pn002 (2002h)	0001h					Application Function Selections 2	After restart
Pn006 (2006h)	0002h					Application Function Selections 6	Immediately
Pn007 (2007h)	0000h					Application Function Selections 7	Immediately
Pn008 (2008h)	4000h					Application Function Selections 8	After restart
Pn009 (2009h)	0010h					Application Function Selections 9	After restart
Pn00A (200Ah)	0001h					Application Function Selections A	After restart
Pn00B (200Bh)	0000h					Application Function Selections B	After restart
Pn00C (200Ch)	0000h					Application Function Selections C	After restart
Pn00D (200Dh)	0000h					Application Function Selections D	Immediately
Pn00F (200Fh)	0000h					Application Function Selections F	After restart
Pn022 (2022h)	0000h					Application Function Selection 22	After restart
Pn023 (2023h)	0000h					Application Function Selection 23	After restart
Pn080 (2080h)	0000h					Application Function Selections 80	After restart
Pn081 (2081h)	0000h					Application Function Selections 81	After restart
Pn100 (2100h)	400					Speed Loop Gain	Immediately
Pn101 (2101h)	2000					Speed Loop Integral Time Constant	Immediately
Pn102 (2102h)	400					Position Loop Gain	Immediately
Pn103 (2103h)	100					Moment of Inertia Ratio	Immediately
Pn104 (2104h)	400					Second Speed Loop Gain	Immediately
Pn105 (2105h)	2000					Second Speed Loop Integral Time Constant	Immediately
Pn106 (2106h)	400					Second Position Loop Gain	Immediately
Pn109 (2109h)	0					Feedforward	Immediately
Pn10A (210Ah)	0					Feedforward Filter Time Constant	Immediately

Continued on next page.

Continued from previous page.

Parameter No.	Default Setting						Name	When Enabled
Pn10B (210Bh)	0000h						Gain Application Selections	*
Pn10C (210Ch)	200						Mode Switching Level for Torque Reference	Immediately
Pn10D (210Dh)	0						Mode Switching Level for Speed Reference	Immediately
Pn10E (210Eh)	0						Mode Switching Level for Acceleration	Immediately
Pn10F (210Fh)	0						Mode Switching Level for Position Deviation	Immediately
Pn11F (211Fh)	0						Position Integral Time Constant	Immediately
Pn121 (2121h)	100						Friction Compensation Gain	Immediately
Pn122 (2122h)	100						Second Friction Compensation Gain	Immediately
Pn123 (2123h)	0						Friction Compensation Coefficient	Immediately
Pn124 (2124h)	0						Friction Compensation Frequency Correction	Immediately
Pn125 (2125h)	100						Friction Compensation Gain Correction	Immediately
Pn131 (2131h)	0						Gain Switching Time 1	Immediately
Pn132 (2132h)	0						Gain Switching Time 2	Immediately
Pn135 (2135h)	0						Gain Switching Waiting Time 1	Immediately
Pn136 (2136h)	0						Gain Switching Waiting Time 2	Immediately
Pn139 (2139h)	0000h						Automatic Gain Switching Selections 1	Immediately
Pn13D (213Dh)	2000						Current Gain Level	Immediately
Pn140 (2140h)	0100h						Model Following Control-Related Selections	Immediately
Pn141 (2141h)	500						Model Following Control Gain	Immediately
Pn142 (2142h)	1000						Model Following Control Gain Correction	Immediately
Pn143 (2143h)	1000						Model Following Control Bias in the Forward Direction	Immediately
Pn144 (2144h)	1000						Model Following Control Bias in the Reverse Direction	Immediately
Pn145 (2145h)	500						Vibration Suppression 1 Frequency A	Immediately
Pn146 (2146h)	700						Vibration Suppression 1 Frequency B	Immediately
Pn147 (2147h)	1000						Model Following Control Speed Feedforward Compensation	Immediately
Pn148 (2148h)	500						Second Model Following Control Gain	Immediately

Continued on next page.

Continued from previous page.

Parameter No.	Default Setting					Name	When Enabled
Pn149 (2149h)	1000					Second Model Following Gain Control Correction	Immediately
Pn14A (214Ah)	800					Vibration Suppression 2 Frequency	Immediately
Pn14B (214Bh)	100					Vibration Suppression 2 Correction	Immediately
Pn14F (214Fh)	0021h					Control-Related Selections	After restart
Pn160 (2160h)	0010h					Anti-Resonance Control-Related Selections	Immediately
Pn161 (2161h)	1000					Anti-Resonance Frequency	Immediately
Pn162 (2162h)	100					Anti-Resonance Gain Correction	Immediately
Pn163 (2163h)	0					Anti-Resonance Damping Gain	Immediately
Pn164 (2164h)	0					Anti-Resonance Filter Time Constant 1 Correction	Immediately
Pn165 (2165h)	0					Anti-Resonance Filter Time Constant 2 Correction	Immediately
Pn166 (2166h)	0					Anti-Resonance Damping Gain 2	Immediately
Pn170 (2170h)	1401h					Tuning-less Function-Related Selections	*
Pn181 (2181h)	0					Mode Switching Level for Speed Reference	Immediately
Pn182 (2182h)	0					Mode Switching Level for Acceleration	Immediately
Pn205 (2205h)	65535					Multiturn Limit	After restart
Pn207 (2207h)	0010h					Position Control Function Selections	After restart
Pn20A (220Ah)	32768					Number of External Scale Pitches	After restart
Pn20E (220Eh)	1					Electronic Gear Ratio (Numerator)	After restart
Pn210 (2210h)	1					Electronic Gear Ratio (Denominator)	After restart
Pn212 (2212h)	2048					Number of Encoder Output Pulses	After restart
Pn22A (222Ah)	0000h					Fully-closed Control Selections	After restart
Pn230 (2230h)	0000h					Position Control Expansion Function Selections	After restart
Pn231 (2231h)	0					Backlash Compensation	Immediately
Pn233 (2233h)	0					Backlash Compensation Time Constant	Immediately
Pn281 (2281h)	20					Encoder Output Resolution	After restart
Pn282 (2282h)	0					Linear Encoder Pitch	After restart
Pn304 (2304h)	500					Jogging Speed	Immediately

Continued on next page.

Continued from previous page.

Parameter No.	Default Setting						Name	When Enabled
Pn305 (2305h)	0						Soft Start Acceleration Time	Immediately
Pn306 (2306h)	0						Soft Start Deceleration Time	Immediately
Pn308 (2308h)	0						Speed Feedback Filter Time Constant	Immediately
Pn30A (230Ah)	0						Deceleration Time for Servo OFF and Forced Stops	Immediately
Pn30C (230Ch)	0						Speed Feedforward Average Movement Time	Immediately
Pn310 (2310h)	0000h						Vibration Detection Selections	Immediately
Pn311 (2311h)	100						Vibration Detection Sensitivity	Immediately
Pn312 (2312h)	50						Vibration Detection Level	Immediately
Pn316 (2316h)	10000						Maximum Motor Speed	After restart
Pn324 (2324h)	300						Moment of Inertia Calculation Starting Level	Immediately
Pn383 (2383h)	50						Jogging Speed	Immediately
Pn384 (2384h)	10						Vibration Detection Level	Immediately
Pn385 (2385h)	50						Maximum Motor Speed	After restart
Pn401 (2401h)	100						First Stage First Torque Reference Filter Time Constant	Immediately
Pn402 (2402h)	800						Forward Torque Limit	Immediately
Pn403 (2403h)	800						Reverse Torque Limit	Immediately
Pn404 (2404h)	100						Forward External Torque Limit	Immediately
Pn405 (2405h)	100						Reverse External Torque Limit	Immediately
Pn406 (2406h)	800						Emergency Stop Torque	Immediately
Pn407 (2407h)	10000						Speed Limit during Torque Control	Immediately
Pn408 (2408h)	0000h						Torque-Related Function Selections	*
Pn409 (2409h)	5000						First Stage Notch Filter Frequency	Immediately
Pn40A (240Ah)	70						First Stage Notch Filter Q Value	Immediately
Pn40B (240Bh)	0						First Stage Notch Filter Depth	Immediately
Pn40C (240Ch)	5000						Second Stage Notch Filter Frequency	Immediately
Pn40D (240Dh)	70						Second Stage Notch Filter Q Value	Immediately

Continued on next page.

Continued from previous page.

Parameter No.	Default Setting					Name	When Enabled
Pn40E (240Eh)	0					Second Stage Notch Filter Depth	Immediately
Pn40F (240Fh)	5000					Second Stage Second Torque Reference Filter Frequency	Immediately
Pn410 (2410h)	50					Second Stage Second Torque Reference Filter Q Value	Immediately
Pn412 (2412h)	100					First Stage Second Torque Reference Filter Time Constant	Immediately
Pn416 (2416h)	0000h					Torque-Related Function Selections 2	Immediately
Pn417 (2417h)	5000					Third Stage Notch Filter Frequency	Immediately
Pn418 (2418h)	70					Third Stage Notch Filter Q Value	Immediately
Pn419 (2419h)	0					Third Stage Notch Filter Depth	Immediately
Pn41A (241Ah)	5000					Fourth Stage Notch Filter Frequency	Immediately
Pn41B (241Bh)	70					Fourth Stage Notch Filter Q Value	Immediately
Pn41C (241Ch)	0					Fourth Stage Notch Filter Depth	Immediately
Pn41D (241Dh)	5000					Fifth Stage Notch Filter Frequency	Immediately
Pn41E (241Eh)	70					Fifth Stage Notch Filter Q Value	Immediately
Pn41F (241Fh)	0					Fifth Stage Notch Filter Depth	Immediately
Pn423 (2423h)	0000h					Speed Ripple Compensation Selections	*
Pn424 (2424h)	50					Torque Limit at Main Circuit Voltage Drop	Immediately
Pn425 (2425h)	100					Release Time for Torque Limit at Main Circuit Voltage Drop	Immediately
Pn426 (2426h)	0					Torque Feedforward Average Movement Time	Immediately
Pn427 (2427h)	0					Speed Ripple Compensation Enable Speed	Immediately
Pn456 (2456h)	15					Sweep Torque Reference Amplitude	Immediately
Pn460 (2460h)	0101h					Notch Filter Adjustment Selections 1	Immediately
Pn475 (2475h)	0000h					Gravity Compensation-Related Selections	After restart
Pn476 (2476h)	0					Gravity Compensation Torque	Immediately
Pn480 (2480h)	10000					Speed Limit during Force Control	Immediately
Pn481 (2481h)	400					Polarity Detection Speed Loop Gain	Immediately

Continued on next page.

Continued from previous page.

Parameter No.	Default Setting						Name	When Enabled
Pn482 (2482h)	3000						Polarity Detection Speed Loop Integral Time Constant	Immediately
Pn483 (2483h)	30						Forward Force Limit	Immediately
Pn484 (2484h)	30						Reverse Force Limit	Immediately
Pn485 (2485h)	20						Polarity Detection Reference Speed	Immediately
Pn486 (2486h)	25						Polarity Detection Reference Acceleration/Deceleration Time	Immediately
Pn487 (2487h)	0						Polarity Detection Constant Speed Time	Immediately
Pn488 (2488h)	100						Polarity Detection Reference Waiting Time	Immediately
Pn48E (248Eh)	10						Polarity Detection Range	Immediately
Pn490 (2490h)	100						Polarity Detection Load Level	Immediately
Pn495 (2495h)	100						Polarity Detection Confirmation Force Reference	Immediately
Pn498 (2498h)	10						Polarity Detection Allowable Error Range	Immediately
Pn49F (249Fh)	0						Speed Ripple Compensation Enable Speed	Immediately
Pn502 (2502h)	20						Rotation Detection Level	Immediately
Pn503 (2503h)	10						Speed Coincidence Detection Signal Output Width	Immediately
Pn506 (2506h)	0						Brake Reference-Servo OFF Delay Time	Immediately
Pn507 (2507h)	100						Brake Reference Output Speed Level	Immediately
Pn508 (2508h)	50						Servo OFF-Brake Command Waiting Time	Immediately
Pn509 (2509h)	20						Momentary Power Interruption Hold Time	Immediately
Pn50A (250Ah)	1881h						Input Signal Selections 1	After restart
Pn50B (250Bh)	8882h						Input Signal Selections 2	After restart
Pn50E (250Eh)	0000h						Output Signal Selections 1	After restart
Pn50F (250Fh)	0100h						Output Signal Selections 2	After restart
Pn510 (2510h)	0000h						Output Signal Selections 3	After restart
Pn511 (2511h)	6543h						Input Signal Selections 5	After restart
Pn512 (2512h)	0000h						Output Signal Inverse Settings 1	After restart
Pn513 (2513h)	0000h						Output Signal Inverse Settings 2	After restart

Continued on next page.

Continued from previous page.

Parameter No.	Default Setting						Name	When Enabled
Pn514 (2514h)	0000h						Output Signal Selections 4	After restart
Pn515 (2515h)	8888h						Input Signal Selections 6	After restart
Pn516 (2516h)	8888h						Input Signal Selections 7	After restart
Pn51A (251Ah)	0000h						Output Signal Selections 8	After restart
Pn51B (251Bh)	1000						Motor-Load Position Deviation Overflow Detection Level	Immediately
Pn51E (251Eh)	100						Position Deviation Overflow Warning Level	Immediately
Pn520 (2520h)	5242880						Position Deviation Overflow Alarm Level	Immediately
Pn522 (2522h)	7						Positioning Completed Width	Immediately
Pn524 (2524h)	1073741824						Near Signal Width	Immediately
Pn526 (2526h)	5242880						Position Deviation Overflow Alarm Level at Servo ON	Immediately
Pn528 (2528h)	100						Position Deviation Overflow Warning Level at Servo ON	Immediately
Pn529 (2529h)	10000						Speed Limit Level at Servo ON	Immediately
Pn52A (252Ah)	20						Multiplier per Fully-closed Rotation	Immediately
Pn52B (252Bh)	20						Overload Warning Level	Immediately
Pn52C (252Ch)	100						Base Current Derating at Motor Overload Detection	After restart
Pn530 (2530h)	0000h						Program Jogging-Related Selections	Immediately
Pn531 (2531h)	32768						Program Jogging Travel Distance	Immediately
Pn533 (2533h)	500						Program Jogging Movement Speed	Immediately
Pn534 (2534h)	100						Program Jogging Acceleration/Deceleration Time	Immediately
Pn535 (2535h)	100						Program Jogging Waiting Time	Immediately
Pn536 (2536h)	1						Program Jogging Number of Movements	Immediately
Pn550 (2550h)	0						Analog Monitor 1 Offset Voltage	Immediately
Pn551 (2551h)	0						Analog Monitor 2 Offset Voltage	Immediately
Pn552 (2552h)	100						Analog Monitor 1 Magnification	Immediately
Pn553 (2553h)	100						Analog Monitor 2 Magnification	Immediately
Pn55A (255Ah)	1						Power Consumption Monitor Unit Time	Immediately

Continued on next page.

Continued from previous page.

Parameter No.	Default Setting						Name	When Enabled
Pn560 (2560h)	400						Residual Vibration Detection Width	Immediately
Pn561 (2561h)	100						Overshoot Detection Level	Immediately
Pn581 (2581h)	20						Zero Speed Level	Immediately
Pn582 (2582h)	10						Speed Coincidence Detection Signal Output Width	Immediately
Pn583 (2583h)	10						Brake Reference Output Speed Level	Immediately
Pn584 (2584h)	10000						Speed Limit Level at Servo ON	Immediately
Pn585 (2585h)	50						Program Jogging Movement Speed	Immediately
Pn586 (2586h)	0						Motor Running Cooling Ratio	Immediately
Pn587 (2587h)	0000h						Polarity Detection Execution Selection for Absolute Linear Encoder	Immediately
Pn600 (2600h)	0						Regenerative Resistor Capacity	Immediately
Pn601 (2601h)	0						Dynamic Brake Resistor Allowable Energy Consumption	After restart
Pn603 (2603h)	0						Regenerative Resistance	Immediately
Pn604 (2604h)	0						Dynamic Brake Resistance	After restart
Pn61A (261Ah)	0000h						Overheat Protection Selections	After restart
Pn61B (261Bh)	250						Overheat Alarm Level	Immediately
Pn61C (261Ch)	100						Overheat Warning Level	Immediately
Pn61D (261Dh)	0						Overheat Alarm Filter Time	Immediately
PnBA0 (2752h)	0000h						Zone Output Signal Selection 1	After restart
PnBA1 (2753h)	0000h						Zone Output Signal Selection 2	After restart

* The enable timing depends on the digit that is changed. Refer to the following sections for details.

 17.1 List of Parameters on page 17-2

Appendices

18

The appendix provides information on interpreting panel displays, and tables of corresponding SERVOPACK and SigmaWin+ function names.

18.1 Interpreting Panel Displays 18-2

- 18.1.1 Interpreting Status Displays 18-2
- 18.1.2 Alarm and Warning Displays 18-2
- 18.1.3 Hard Wire Base Block Active Display 18-2
- 18.1.4 Overtravel Display 18-2
- 18.1.5 Forced Stop Display 18-2

18.2 Corresponding SERVOPACK and SigmaWin+ Function Names .. 18-3

- 18.2.1 Corresponding SERVOPACK Utility Function Names 18-3
- 18.2.2 Corresponding SERVOPACK Monitor Display Function Names 18-5

18.1 Interpreting Panel Displays

You can check the Servo Drive status on the panel display of the SERVOPACK.
 Also, if an alarm or warning occurs, the alarm or warning number will be displayed.

18.1.1 Interpreting Status Displays

The status is displayed as described below.

Display	Meaning	Display	Meaning
	/TGON (Rotation Detection) Signal Display Lit if the Servomotor speed is higher than the setting of Pn502 or Pn581 and not lit if the speed is lower than the setting. (The default setting is 20 min ⁻¹ or 20 mm/s.)		Reference Input Display Lit while a reference is being input.
	Base Block Display Lit during the base block state (servo OFF). Not lit while the servo is ON.		Connected Display Lit while there is a connection.

18.1.2 Alarm and Warning Displays

If there is an alarm or warning, the code will be displayed one character at a time, as shown below.

Example: Alarm A.E60

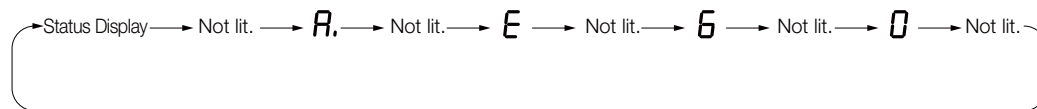

18.1.3 Hard Wire Base Block Active Display

If a hard wire base block (HWBB) is active, the display will change in the following order.

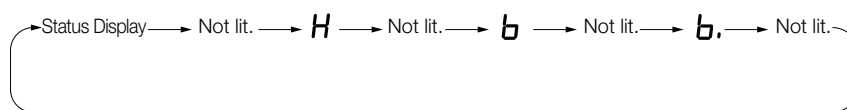

18.1.4 Overtravel Display

If overtravel has occurred, the display will change in the following order.

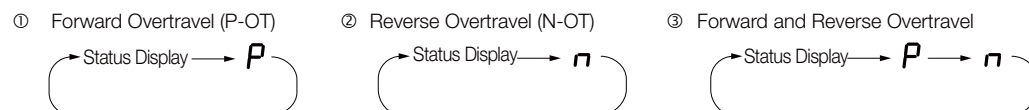

18.1.5 Forced Stop Display

During a forced stop, the following display will appear.

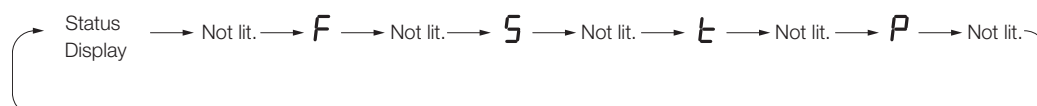

18.2 Corresponding SERVOPACK and SigmaWin+ Function Names

This section gives the names and numbers of the utility functions and monitor display functions used by the SERVOPACKs and the names used by the SigmaWin+.

18.2.1 Corresponding SERVOPACK Utility Function Names

SigmaWin+		SERVOPACK	
Button in Menu Dialog Box	Function Name	Fn No.	Function Name
Basic Functions	Initialize	Fn005	Initializing Parameters
	Software Reset	Fn030	Software Reset
	Setup Wizard	–	–
	I/O Signal Allocation	–	–
	Product Information		Fn011
Fn012			Display Software Version
Fn01E			Display SERVOPACK and Servomotor IDs
Fn01F			Display Servomotor ID from Feedback Option Module
Encoder Setting	Reset Absolute Encoder	Fn008	Reset Absolute Encoder
	Multi-turn Limit Setup	Fn013	Multiturn Limit Setting after Multiturn Limit Disagreement Alarm
	Search Origin	Fn003	Origin Search
	Zero Point Position Setting	Fn020	Set Absolute Linear Encoder Origin
	Polarity Detection	Fn080	Polarity Detection
	Motor Parameter Scale Write	–	–
Trouble-shooting	Display Alarm	Fn000	Display Alarm History
		Fn006	Clear Alarm History
		Fn014	Reset Option Module Configuration Error
	Alarm Trace	–	–
Reset Motor Type Alarm	Fn021	Reset Motor Type Alarm	
Operation	Jog	Fn002	Jog
	Program JOG Operation	Fn004	Jog Program
Monitor	Trace	–	–
	Real Time Trace	–	–
	Monitor	–	–
	Life Monitor	–	–
Tuning	Tuning - Autotuning without Host Reference	Fn201	Advanced Autotuning without Reference
	Tuning - Autotuning with Host Reference	Fn202	Advanced Autotuning with Reference
	Tuning - Custom Tuning	Fn203	One-Parameter Tuning
	Tuning - Custom Tuning - Adjust Anti-resonance Control	Fn204	Adjust Anti-resonance Control
	Tuning - Custom Tuning - Vibration Suppression	Fn205	Vibration Suppression
	System Tuning	–	–
	Response Level Setting	Fn200	Tuning-less Level Setting
Edit Online Parameters	–	–	

Continued on next page.

18.2 Corresponding SERVOPACK and SigmaWin+ Function Names

18.2.1 Corresponding SERVOPACK Utility Function Names

Continued from previous page.

SigmaWin+		SERVOPACK	
Button in Menu Dialog Box	Function Name	Fn No.	Function Name
Diagnostic	Mechanical Analysis	-	-
	Easy FFT	Fn206	Easy FFT
	Ripple Compensation	-	-
	Online Vibration Monitor	-	-
Others	Adjust the Analog Monitor Output	Fn00C	Adjust Analog Monitor Output Offset
		Fn00D	Adjust Analog Monitor Output Gain
	Adjust the Motor Current Detection Offsets	Fn00E	Autotune Motor Current Detection Signal Offset
		Fn00F	Manually Adjust Motor Current Detection Signal Offset
	Initialize Vibration Detection Level	Fn01B	Initialize Vibration Detection Level
	Parameter Converter	-	-
	SERVOPACK Axis Name Setting	-	-
	Write Prohibited Setting	Fn010	Write Prohibition Setting
Motor Parameter SERVOPACK Write	-	-	

18.2.2 Corresponding SERVOPACK Monitor Display Function Names

SigmaWin+		SERVOPACK	
Button in Menu Dialog Box	Name [Unit]	Un No.	Name [Unit]
Motion Monitor	Motor Speed [min^{-1}]	Un000	Motor Speed [min^{-1}]
	Speed Reference [min^{-1}]	Un001	Speed Reference [min^{-1}]
	Torque Reference [%]	Un002	Torque Reference [%] (percentage of rated torque)
	<ul style="list-style-type: none"> Rotary Servomotors: Rotational Angle 1 [encoder pulses] (number of encoder pulses from origin within one encoder rotation) Linear Servomotors: Electrical Angle 1 [linear encoder pulses] (linear encoder pulses from the polarity origin) 	Un003	<ul style="list-style-type: none"> Rotary Servomotors: Rotational Angle 1 [encoder pulses] (number of encoder pulses from origin within one encoder rotation displayed in decimal) Linear Servomotors: Electrical Angle 1 [linear encoder pulses] (linear encoder pulses from the polarity origin displayed in decimal)
	<ul style="list-style-type: none"> Rotary Servomotors: Rotational Angle 2 [deg] (electrical angle from origin within one encoder rotation) Linear Servomotors: Electrical Angle 2 [deg] (electrical angle from polarity origin) 	Un004	<ul style="list-style-type: none"> Rotary Servomotors: Rotational Angle 2 [deg] (electrical angle from polarity origin) Linear Servomotors: Electrical Angle 2 [deg] (electrical angle from polarity origin)
	Input Reference Pulse Speed [min^{-1}]	Un007	Input Reference Pulse Speed [min^{-1}] (displayed only during position control)
	Position Deviation [reference units]	Un008	Position Error Amount [reference units] (displayed only during position control)
	Accumulated Load Ratio [%]	Un009	Accumulated Load Ratio [%] (percentage of rated torque: effective torque in cycles of 10 seconds)
	Regenerative Load Ratio [%]	Un00A	Regenerative Load Ratio [%] (percentage of processable regenerative power: regenerative power consumption in cycles of 10 seconds)
	Input Reference Pulse Counter [reference units]	Un00C	Input Reference Pulse Counter [reference units]
Feedback Pulse Counter [encoder pulses]	Un00D	Feedback Pulse Counter [encoder pulses]	

Continued on next page.

18.2 Corresponding SERVOPACK and SigmaWin+ Function Names

18.2.2 Corresponding SERVOPACK Monitor Display Function Names

Continued from previous page.

SigmaWin+		SERVOPACK	
Button in Menu Dialog Box	Name [Unit]	Un No.	Name [Unit]
Motion Monitor	Fully-closed Loop Feedback Pulse Counter [external encoder resolution]	Un00E	Fully-closed Loop Feedback Pulse Counter [external encoder resolution]
	Upper Limit Setting of Motor Maximum Speed/Upper Limit Setting of Encoder Output Resolution	Un010*1	Upper Limit Setting of Motor Maximum Speed/Upper Limit Setting of Encoder Output Resolution
	Total Operation Time [100 ms]	Un012	Total Operation Time [100 ms]
	Feedback Pulse Counter [reference units]	Un013	Feedback Pulse Counter [reference units]
	Overheat Protection Input [0.01 V]	Un02F	Overheat Protection Input [0.01 V]
	Current Backlash Compensation Value [0.1 reference units]	Un030	Current Backlash Compensation Value [0.1 reference units]
	Backlash Compensation Value Setting Limit [0.1 reference units]	Un031	Backlash Compensation Value Setting Limit [0.1 reference units]
	Power Consumption [W]	Un032	Power Consumption [W]
	Consumed Power [0.001 Wh]	Un033	Consumed Power [0.001 Wh]
	Cumulative Power Consumption [Wh]	Un034	Cumulative Power Consumption [Wh]
	Energy Consumption of the Dynamic Brake Resistor [%]	Un03B	Energy Consumption of the Dynamic Brake Resistor [%] (The percentage of the setting of Pn601 (Dynamic Brake Resistor Allowable Energy Consumption) is displayed.)
	Absolute Encoder Multiturn Data	Un040	Absolute Encoder Multiturn Data
	Position within One Rotation of Absolute Encoder [encoder pulses]	Un041	Position within One Rotation of Absolute Encoder [encoder pulses]
	Lower Bits of Absolute Encoder Position [encoder pulses]	Un042	Lower Bits of Absolute Encoder Position [encoder pulses]
Upper Bits of Absolute Encoder Position [encoder pulses]	Un043	Upper Bits of Absolute Encoder Position [encoder pulses]	
Status Monitor	Polarity Sensor Signal Monitor	Un011	Polarity Sensor Signal Monitor
	Active Gain Monitor	Un014	Effective Gain Monitor (gain settings 1 = 1, gain settings 2 = 2)
Input Signal Monitor	Input Signal Monitor	Un005	Input Signal Monitor
Output Signal Monitor	Output Signal Monitor	Un006	Output Signal Monitor
Service Life Monitor	Installation Environment Monitor – SERVOPACK	Un025	SERVOPACK Installation Environment Monitor [%]
	Installation Environment Monitor – Servomotor*2	Un026	Servomotor Installation Environment Monitor [%]
	Service Life Prediction Monitor – Built-in Fan	Un027	Built-in Fan Remaining Life Ratio [%]
	Service Life Prediction Monitor – Capacitor	Un028	Capacitor Remaining Life Ratio [%]
	Service Life Prediction Monitor – Surge Prevention Circuit	Un029	Surge Prevention Circuit Remaining Life Ratio [%]
	Service Life Prediction Monitor – Dynamic Brake Circuit*3	Un02A	Dynamic Brake Circuit Remaining Life Ratio [%]
	Service Life Prediction Monitor – Built-in Brake Relay	Un036	Built-in Brake Relay Remaining Life Ratio [%]

Continued on next page.

Continued from previous page.

SigmaWin+		SERVOPACK	
Button in Menu Dialog Box	Name [Unit]	Un No.	Name [Unit]
Product Information	Motor – Resolution	Un084	Linear Encoder Pitch (Scale pitch = $Un084 \times 10^{Un085}$ [µm])
		Un085	Linear Encoder Pitch Exponent (Scale pitch = $Un084 \times 10^{Un085}$ [µm])
–	–	Un020	Rated Motor Speed [min^{-1}]
	–	Un021	Maximum Motor Speed [min^{-1}]

- *1. You can use Un010 to monitor the upper limit setting for the maximum motor speed or the upper limit setting for the encoder output resolution.
 You can monitor the upper limit of the encoder output resolution setting (Pn281) for the current maximum motor speed setting (Pn385), or you can monitor the upper limit of the maximum motor speed setting for the current encoder output resolution setting.
 Select which signal to monitor with Pn080 = n.X□□□ (Calculation Method for Maximum Speed or Divided Output Pulses).
 • If Pn080 = n.0□□□, the encoder output resolution (Pn281) that can be set is displayed.
 • If Pn080 = n.1□□□, the maximum motor speed (Pn385) that can be set is displayed in mm/s.
- *2. This applies to the following motors. The display will show 0 for all other models.
 SGM7J, SGM7A, and SGM7G
- *3. With SGD7S-210D, -260D, -280D, and -370D SERVOPACKs, you cannot check the remaining life ratio with the Service Life Prediction Monitor and Un02A because these SERVOPACKs are not equipped with a built-in dynamic brake circuit.

Index

Symbols

/BK - - - - -	6-33
/BK (Brake) signal- - - - -	6-33
/CLT - - - - -	7-30
/CLT (Torque Limit Detection) signal - - - - -	7-30
/COIN - - - - -	7-10
/COIN (Positioning Completion) signal - - - - -	7-10
/HWBB1 - - - - -	4-38
/HWBB2 - - - - -	4-38
/N-CL - - - - -	7-27
/N-CL (Reverse External Torque Limit) signal - - - - -	7-27
/NEAR - - - - -	7-11
/NEAR (Near) signal - - - - -	7-11
/P-CL- - - - -	7-27
/P-CL (Forward External Torque Limit) signal - - - - -	7-27
/S-RDY- - - - -	7-8
/S-RDY (Servo Ready) signal - - - - -	7-8
/TGON - - - - -	7-8
/TGON (Rotation Detection) signal - - - - -	7-8
/V-CMP - - - - -	7-9
/V-CMP (Speed Coincidence Detection) signal - - - - -	7-9
/VLT - - - - -	7-12
/VLT (Speed Limit Detection) signal- - - - -	7-12
/WARN- - - - -	7-7
/WARN (Warning) signal - - - - -	7-7

A

A.CC0 - - - - -	7-37
absolute encoder - - - - -	7-31
origin offset - - - - -	6-52
resetting - - - - -	6-49
wiring - - - - -	4-20
acceleration reference unit- - - - -	15-18
Acceleration User Unit (2703h) - - - - -	15-18
Active Mode Function	
operation example - - - - -	12-19
recovery method - - - - -	12-21
additional adjustment functions - - - - -	9-65
alarm reset possibility - - - - -	16-5
ALM - - - - -	7-7
ALM (Servo Alarm) signal - - - - -	7-7
Analog Monitor Connector- - - - -	4-41
analog monitor factors - - - - -	10-11
anti-resonance control - - - - -	9-50
automatic detection of connected motor - - - - -	6-13
automatic gain switching- - - - -	9-65
automatic notch filters - - - - -	9-31
autotuning with a host reference - - - - -	9-34

autotuning without a host reference - - - - -	9-23
---	------

B

backlash compensation - - - - -	9-72
base block (BB) - - - - -	vi
battery	
replacement - - - - -	16-3
block diagram - - - - -	2-8

C

CCW- - - - -	6-14
CiA402 drive profile - - - - -	2-6, 14-3
clearing alarm history - - - - -	16-44
CN1 - - - - -	4-30
CN2 - - - - -	4-19
CN3 - - - - -	4-41
CN5 - - - - -	4-41
CN6A - - - - -	4-39
CN6B - - - - -	4-39
CN7 - - - - -	4-41
CN8 - - - - -	4-37
coasting - - - - -	6-37
coasting to a stop - - - - -	6-37
coefficient of speed fluctuation - - - - -	2-7
communications connectors - - - - -	2-6
compatible adjustment functions- - - - -	9-87
compliant communications standards - - - - -	2-6
Computer Connector - - - - -	4-41
connecting a safety function device - - - - -	12-16
Controlword (6040h) - - - - -	15-23
countermeasures against noise- - - - -	4-5
current control mode selection - - - - -	9-70
current gain level setting- - - - -	9-71
custom tuning - - - - -	9-41
CW- - - - -	6-14
Cyclic Sync Torque Mode - - - - -	14-20
Cyclic Synchronous Position Mode - - - - -	14-12, 15-43
Cyclic Synchronous Velocity Mode- - - - -	14-18, 15-44

D

DC mode - - - - -	13-8, 13-10
DC power supply input - - - - -	4-12
DC Reactor	
terminals - - - - -	4-11
wiring - - - - -	4-18
decelerating to a stop - - - - -	6-37
deceleration monitoring - - - - -	12-17, 12-18, 12-19
detection timing for Overload Alarms (A.720) - - - - -	6-41
detection timing for Overload Warnings (A.910) - - - - -	6-40
device control- - - - -	14-3
diagnostic output circuits - - - - -	4-38
diagnostic tools - - - - -	9-91

- digital I/O signals - - - - - 14-22
- Digital Inputs (60FDh) - - - - - 15-49
- digital inputs and outputs - - - - - 14-22, 15-49
- Digital Outputs (60FEh) - - - - - 15-50
- DINT - - - - - 1-6
- Disable Operation Option Code (605Ch) - - - - - 15-28
- displaying alarm history - - - - - 16-43
- Distributed Clocks - - - - - 2-6
- drive profile - - - - - 2-6, 14-3
- dynamic brake applied - - - - - 6-37
- Dynamic Brake Resistor
- allowable energy consumption - - - - - 5-9
 - connections - - - - - 5-7
 - resistance - - - - - 5-9
- dynamic brake stopping - - - - - 6-37
- E**
- EasyFFT - - - - - 9-93
- EDM1 - - - - - 12-12
- EDM1 (External Device Monitor) signal - - - - - 12-12
- electronic gear - - - - - 6-42
- emergency messages - - - - - 13-11
- encoder divided pulse output - - - - - 7-18, 11-7
- setting - - - - - 7-23
 - signals - - - - - 7-18
- encoder resolution - - - - - 6-43, 7-23
- Error Code (603Fh) - - - - - 15-23
- estimating the moment of inertia - - - - - 9-16
- EtherCAT commands - - - - - 2-6
- EtherCAT communications - - - - - 2-6
- EtherCAT state machine - - - - - 13-3
- event cycle - - - - - 15-14
- events
- event cycle - - - - - 15-14
 - reception events - - - - - 15-15
 - sync events - - - - - 13-8
 - SYNC0 event - - - - - 13-8
 - trigger events - - - - - 14-23
- example of PDO data exchange timing in DC mode - - 13-10
- External Regenerative Resistor - - - - - 6-55
- external torque limits - - - - - 7-27
- F**
- Fault Reaction Option Code (605Eh) - - - - - 15-29
- feedback pulse counter - - - - - 6-21
- feedforward - - - - - 9-32, 9-87
- feedforward compensation - - - - - 9-87
- FG - - - - - 4-8
- FMMU - - - - - 2-6
- Following Error Actual Value (60F4h) - - - - - 15-36
- Following Error Time Out (6066h) - - - - - 15-35
- Following Error Window (6065h) - - - - - 15-35
- forward direction - - - - - 11-6
- forward rotation - - - - - 6-14
- Free-Run mode - - - - - 13-8
- friction compensation - - - - - 9-32, 9-68
- fully-closed system - - - - - 11-2
- G**
- gain switching - - - - - 9-65
- gravity compensation - - - - - 9-69
- grounding - - - - - 4-8
- group 1 alarms - - - - - 6-38
- group 2 alarms - - - - - 6-38
- H**
- Halt Option Code (605Dh) - - - - - 15-28
- hard wire base block (HWBB) - - - - - 12-5
- detecting errors in HWBB signal - - - - - 12-8
 - HWBB input signal specifications - - - - - 12-9
- hard wire base block (HWBB) state - - - - - 12-6
- resetting - - - - - 12-7
- holding brake - - - - - 6-32
- Home Offset (607Ch) - - - - - 15-33
- homing - - - - - 14-14, 15-33
- Homing Acceleration (609Ah) - - - - - 15-34
- Homing Method (6098h) - - - - - 14-14, 15-33
- Homing Mode - - - - - 15-33
- Homing Speeds (6099h) - - - - - 15-34
- HWBB - - - - - 12-5, 12-6
- detecting errors in HWBB signal - - - - - 12-8
 - HWBB input signal specifications - - - - - 12-9
- HWBB state
- resetting - - - - - 12-7
- I**
- I/O signals
- allocations - - - - - 7-4
 - functions - - - - - 4-30
 - monitoring - - - - - 10-3, 10-5
 - names - - - - - 4-30
 - wiring example - - - - - 4-33
- indicators - - - - - 2-6
- initializing the vibration detection level - - - - - 7-46
- input signals
- allocations - - - - - 7-4
- INT - - - - - 1-6
- internal torque limits - - - - - 7-26
- Interpolated Position Mode - - - - - 14-9, 14-10, 15-37
- interpolated positioning - - - - - 14-12
- Interpolation Data Read/Write Pointer Position Monitor (2741h) - - - - - 15-42
- Interpolation Data Record (60C1h) - - - - - 15-37
- Interpolation Data Record for 1st Profile (27C0h) - - - 15-41
- Interpolation Data Record for 2nd Profile (27C1h) - - - 15-41
- interpolation position reference - - - - - 15-37

interpolation position reference cycle - - - - -15-38
interpolation processing - - - - - 14-9
Interpolation Profile Select (2732h) - - - - -15-41
interpolation speed exceeded - - - - -15-25
Interpolation Submode Select (60C0h) - - - - -15-37
Interpolation Time Period (60C2h) - - - - -15-38
I-P control - - - - - 9-84

J

jogging - - - - - 8-7

L

limiting torque - - - - - 7-26
linear encoder
 feedback resolution - - - - - 6-44
 scale pitch setting - - - - - 6-15
 wiring example - - - - - 4-20
Linear Servomotor - - - - - vi
Linear Servomotor Overheat Protection Input - - - - - 4-30
line-driver output circuits - - - - - 4-36
list of alarms - - - - - 16-5
list of parameters - - - - - 17-2
list of warnings - - - - -16-48

M

mailbox - - - - - 2-6
Main Circuit Cable - - - - - vi
manual tuning - - - - - 9-77
Manufacturer Interpolation Data Configuration
for 1st Profile (2730h) - - - - -15-38
Manufacturer Interpolation Data Configuration
for 2nd Profile (2731h) - - - - -15-39
Max. Profile Velocity (607Fh)- - - - -15-31
Max. Torque (6072h) - - - - -15-46
mechanical analysis - - - - - 9-91
mode switching (changing between proportional
and PI control) - - - - - 9-88
Modes of Operation (6060h)- - - - -15-29
Modes of Operation Display (6061h) - - - - -15-29
Momentary Power Interruption Hold Time - - - - - 7-14
monitor factors - - - - -10-11
Motion Monitor - - - - - 10-3
motor current detection signal
 automatic adjustment - - - - - 7-50
 manual adjustment - - - - - 7-53
 offset - - - - - 7-50
motor direction setting - - - - - 6-14
motor maximum speed - - - - - 7-17
motor overload detection level - - - - - 6-40
Motor Rated Torque (6076h)- - - - -15-45
multiturn limit - - - - - 7-36
Multiturn Limit Disagreement - - - - - 7-37

N

Negative Torque Limit Value (60E1h) - - - - - 15-46
Noise Filter - - - - - -4-6
Noise Filter connection precautions - - - - - -4-7
N-OT- - - - - -6-26
N-OT (Reverse Drive Prohibit) signal - - - - - -6-26
notch filters - - - - - -9-80

O

object dictionary - - - - -13-6
object dictionary list - - - - -15-3
object list - - - - -17-33
operation for momentary power interruptions- - - - -7-14
operation modes - - - - - 14-5, 15-29
origin search - - - - -8-19
output phase form - - - - -7-19
overload warnings - - - - -6-40
overtravel - - - - -6-26
 release method selection - - - - -6-30
 warnings - - - - -6-29

P

PAO - - - - -7-18, 11-7
parameter settings recording table - - - - - 17-43
parameters
 classification - - - - -6-3
 initializing parameter settings - - - - -6-10
 notation (numeric settings) - - - - - vii, 6-4
 notation (selecting functions) - - - - - vii, 6-4
 setting methods - - - - -6-5
 write prohibition setting - - - - -6-7
PBO - - - - -7-18, 11-7
PCO - - - - -7-18, 11-7
PDO mapping objects - - - - -15-9
PDO mappings - - - - -13-6, 15-9
 default settings - - - - -13-7
 object dictionary - - - - -13-6
 object dictionary list - - - - -15-3
 setting procedure - - - - -13-7
photocoupler input circuits - - - - -4-35
photocoupler output circuits - - - - -4-36
physical layer - - - - -2-6
PI control - - - - -9-84
polarity detection - - - - -6-23
polarity sensor - - - - -6-22
Position Actual Internal Value (6063h) - - - - - 15-35
Position Actual Value (6064h)- - - - - 15-35
Position Demand Internal Value (60FCh)- - - - - 15-35
Position Demand Value (6062h) - - - - - 15-35
position integral - - - - -9-90
position loop gain - - - - -9-78
position reference unit - - - - -15-17
Position User Unit (2701h) - - - - -15-17

Position Window (6067h) - - - - -	15-36	SBB-D function - - - - -	12-17
Position Window Time (6068h) - - - - -	15-36	operation example- - - - -	12-17
positioning completed width - - - - -	7-10	recovery method- - - - -	12-17
Positive Torque Limit Value (60E0h) - - - - -	15-46	scale pitch - - - - -	6-15
P-OT - - - - -	6-26	selecting the phase sequence	
P-OT (Forward Drive Prohibit) signal - - - - -	6-26	for a Linear Servomotor - - - - -	6-20
process data - - - - -	2-6	selecting torque limits - - - - -	7-26
Profile Acceleration (6083h) - - - - -	15-32	SEMI F47 function - - - - -	7-15
Profile Deceleration (6084h) - - - - -	15-32	Serial Communications Connector- - - - -	4-41
Profile Position Mode - - - - -	14-6, 15-31	Serial Converter Unit - - - - -	6-15
Profile Torque Mode - - - - -	14-19	Servo Drive - - - - -	vi
Profile Velocity (6081h)- - - - -	15-32	servo gains - - - - -	9-77
Profile Velocity Mode- - - - -	14-17, 15-44	servo lock- - - - -	vi
program jogging - - - - -	8-13	servo OFF- - - - -	vi
operation pattern- - - - -	8-14	servo ON - - - - -	vi
Q		Servo System - - - - -	vi
Quick Stop - - - - -	15-27	Servomotor - - - - -	vi
Quick Stop command - - - - -	15-32	Servomotor stopping method for alarms - - - - -	6-38
Quick Stop Deceleration (6085h) - - - - -	15-32	SERVOPACK - - - - -	vi
Quick Stop Option Code (605Ah)- - - - -	15-27	inspections and part replacement - - - - -	16-2
R		part names - - - - -	1-8
Receive PDO Mapping- - - - -	15-9	ratings - - - - -	2-2
reception events - - - - -	15-15	specifications - - - - -	2-4
reference unit - - - - -	6-42	status displays - - - - -	18-2
Regenerative Resistor - - - - -	6-55	setting the origin - - - - -	6-52
connection - - - - -	4-18	setting the position deviation overflow alarm level - - - - -	9-8
Regenerative Resistor capacity - - - - -	6-55	setting the position deviation overflow alarm level	
resetting alarms- - - - -	16-42	at servo ON- - - - -	9-10
resetting alarms detected in Option Modules - - - - -	16-45	setting the vibration detection level - - - - -	9-10
reverse direction - - - - -	11-6	setup parameters - - - - -	6-3
risk assessment - - - - -	12-5	SG - - - - -	4-31
Rotary Servomotor - - - - -	vi	Shutdown Option Code (605Bh) - - - - -	15-27
S		SigmaWin+ - - - - -	vi
Safe Speed Limit with Delay - - - - -	12-19	signal allocations- - - - -	7-4
operation example - - - - -	12-19	sink circuits- - - - -	4-35
recovery method - - - - -	12-19	SINT - - - - -	1-6
Safety Base Block with Delay - - - - -	12-17	Slave Information IF - - - - -	2-6
operation example - - - - -	12-17	SLS-D function- - - - -	12-19
recovery method - - - - -	12-17	operation example- - - - -	12-19
Safety Function Signals - - - - -	4-37	recovery method- - - - -	12-19
safety functions - - - - -	12-3	software limits - - - - -	7-25
application examples - - - - -	12-13	Software Position Limit (607Dh) - - - - -	15-31
monitoring - - - - -	10-5	software reset - - - - -	7-44
precautions - - - - -	12-4	source circuits - - - - -	4-35
verification test - - - - -	12-15	speed detection method selection- - - - -	9-71
safety input circuits- - - - -	4-37	speed limit during torque control- - - - -	7-12
Safety Module Monitor (2720h) - - - - -	15-22	speed loop gain - - - - -	9-79
Safety Position Monitor with Delay - - - - -	12-18	speed loop integral time constant - - - - -	9-79
operation example - - - - -	12-18	speed reference unit - - - - -	15-18
recovery method - - - - -	12-18	SPM-D function - - - - -	12-18
		operation example- - - - -	12-18
		recovery method- - - - -	12-18

state machine control commands - - - - - 14-4

Status Monitor - - - - - 10-3

Statusword (6041h)- - - - -14-4, 15-25

stopping by applying the dynamic brake- - - - - 6-37

stopping method for servo OFF- - - - - 6-38

storage humidity - - - - - 2-4

storage temperature - - - - - 2-4

STRING - - - - - 1-6

Supported Drive Modes (6502h) - - - - -15-30

surrounding air humidity - - - - - 2-4

surrounding air temperature- - - - - 2-4

switching condition A- - - - - 9-66

Sync Error Settings (10F1h) - - - - -15-15

sync events - - - - - 13-8

Sync Manager Communication Objects - - - - -15-13

Sync Manager Communication Type (1C00h) - - - - -15-13

Sync Manager PDO Assignment
(1C10h to 1C13h)- - - - -15-13

Sync Manager Synchronization
(1C32h and 1C33h)- - - - -15-14

SYNC0 event - - - - - 13-8

synchronization with distributed clocks - - - - - 13-8

SyncManager - - - - - 2-6

T

Target Position (607Ah) - - - - -15-31

Target Torque (6071h) - - - - -15-45

Target Velocity (60FFh) - - - - -15-44

test without a motor - - - - - 8-21

TH - - - - - 4-30

three-phase, 400-VAC power supply input - - - - - 4-11

time required to brake - - - - - 6-32

time required to release brake- - - - - 6-32

Torque Actual Value (6077h)- - - - -15-45

Torque Demand Value (6074h) - - - - -15-45

torque limit function - - - - -15-46

torque limits - - - - -14-21

Torque Offset (60B2h) - - - - -15-43

torque reference filter- - - - - 9-80

Torque Slope (6087h)- - - - -15-45

touch probe - - - - -14-23

 example of execution procedure - - - - -14-24

Touch Probe 1 Position Value (60BAh) - - - - -15-48

Touch Probe 2 Position Value (60BCh) - - - - -15-48

touch probe function - - - - -15-47

Touch Probe Function (60B8h) - - - - -15-47

Touch Probe Status (60B9h)- - - - -15-47

Transmit PDO Mapping - - - - -15-11

trial operation

 EtherCAT (CoE) Communications- - - - - 8-10

trigger events - - - - -14-23

troubleshooting alarms- - - - -16-11

troubleshooting warnings - - - - - 16-49

tuning parameters - - - - - -6-4

tuning-less

 load level - - - - - -9-14

 rigidity level - - - - - -9-14

tuning-less function - - - - - -9-12

U

UDINT - - - - - -1-6

UINT - - - - - -1-6

USINT - - - - - -1-6

V

Velocity Actual Value (606Ch)- - - - - 15-44

Velocity Demand Value (606Bh) - - - - - 15-44

Velocity Offset (60B1h) - - - - - 15-43

Velocity User Unit (2702h)- - - - - 15-18

Velocity Window (606Dh) - - - - - 15-44

Velocity Window Time (606Eh) - - - - - 15-44

vibration suppression - - - - - -9-55

W

writing parameters - - - - - -6-16

Z

zero clamping- - - - - -6-37

ZONE output - - - - - -7-58

ZONE table - - - - - -7-58

 ZONE N- - - - - -7-58

 ZONE P- - - - - -7-58

Revision History

The revision dates and numbers of the revised manuals are given on the bottom of the back cover.

MANUAL NO. SIEP S800001 80B <1>-0
 Web revision number
 Revision number
 Published in Japan October 2015
 Date of publication

Date of Publication	Rev. No.	Web Rev. No.	Section	Revised Contents
September 2021	<13>	0	All chapters	Partly revised.
August 2020	<12>	0	3.4.2, 3.7, 6.5, 6.14.1, 7.5.2, 11.3.5	Partly revised.
February 2020	<11>	0	4.4.3, 6.14.1, 6.16.2	Addition: Information on Linear Encoder from Canon Precision Inc.
November 2019	<10>	0	All chapters	Partly revised.
			Back cover	Revision: Address
February 2019	<9>	0	6.1.4, 8.6.3	Revision: Information in table of restrictions
			10.2.2, 10.2.3, 16.2.6, 16.2.7, 18.2.1	Partly revised.
			16.2.3	Addition: Reset procedure with the SigmaWin+
			Back cover	Revision: Address
October 2018	<8>	0	All chapters	Partly revised.
			1.8	Newly added.
			4.4.3, 6.14.1	Addition: Absolute linear encoder from Fagor Automation S. Coop.
			6.1.4, 8.6.3	Revision: Footnote in Origin Search
			15.6	Revision: Description of value 0 of bit 10 for "Bits 10, 12, and 13: Cyclic Synchronous Position, Velocity, or Torque Mode"
			17.2	Addition: Footnote 4
October 2017	<7>	0	Chapter 5	Addition: Information on dynamic brake
			All chapters	Partly revised.
			Back cover	Revision: Address
January 2017	<6>	0	1.5.1, 1.6.1, 1.6.2, 2.1.1, 2.1.2, 2.1.3, 2.2.1, 2.2.2, 2.3.1, 3.3, 3.4.2, 4.3.1, 4.3.2, 4.3.4, 5.12	Addition: Information on SGD7S-210D to -370D
			4.4.3	Addition: Specifications for diodes to prevent reverse current flow
			5.10.3, 6.13.2	Deletion: Torque from the parameter table for Pn406
			6.14.2, 16.2	Addition: Parameter numbers related to object 2751h
			Back cover	Revision: Address
November 2016	<5>	0	All chapters	Partly revised.
June 2016	<4>	0	2.1.1	Revision: Value of continuous output current (Model: SGD7S-170D)
May 2016	<3>	0	1.5.1, 1.6.1, 1.6.2, 2.1.1, 2.1.2, 2.3.2, 3.3, 3.4.2, 4.3.4, 5.12, 15.2.2	Addition: Information on SGD7S-170D
			1.5.1, 2.1.2, 4.2, 4.3.1, 4.4.4, 5.11.3, 5.11.5, 15.2.2, 16.1.2	Addition: Information on Servomotor brake control
			All chapters	Partly revised.

Date of Publication	Rev. No.	Web Rev. No.	Section	Revised Contents
March 2016	<2>	0	Preface	Revision: Information on Servomotor UL standards and EU Directives
			1.2.6	Revision: Information on torque user unit
			1.5.1, 1.5.2	Revision: Information on interpreting SERVOPACK and Servomotor model numbers
			1.7, 9.5	Addition: Information on alarm tracing
			2.1.1	Revision: Information on control power supply
			2.2	Addition: Connector numbers (CN101, CN102, CN115, and CN201)
			3.4.2	Revision: Information on installing more than one SERVOPACK
			4.3.3	Revision: Time for turning the power supply OFF and ON again (from 100 ms to 1 s)
			4.5.2	Revision: Illustration of I/O signal connectors
			5.14.4, 14.5	Revision: Setting range for torque reference units
			11.1.1	Revision: Description of safety functions
			14.2	Revision: Precaution on Store Parameters Field (1010h)
			14.1, 16.2	Revision: Data types for 27C0h and 27C1h
			16.1.2, 16.4	Deletion: Pn52D
16.4	Addition: Supplemental description of enable timing			
October 2015	<1>	0	All chapters	Partly revised.
			6.14	Addition: Information on ZONE outputs
			Back cover	Revision: Address
June 2015	–	–	–	First edition

Σ-7-Series AC Servo Drive

Σ-7S SERVOPACK with 400V-Input Power and EtherCAT (CoE) Communications References FT/EX Specification ZONE Outputs

Product Manual

IRUMA BUSINESS CENTER (SOLUTION CENTER)

480, Kamifujisawa, Iruma, Saitama, 358-8555, Japan
Phone: +81-4-2962-5151 Fax: +81-4-2962-6138
www.yaskawa.co.jp

YASKAWA AMERICA, INC.

2121, Norman Drive South, Waukegan, IL 60085, U.S.A.
Phone: +1-800-YASKAWA (927-5292) or +1-847-887-7000 Fax: +1-847-887-7310
www.yaskawa.com

YASKAWA ELÉTRICO DO BRASIL LTDA.

777, Avenida Piraporinha, Diadema, São Paulo, 09950-000, Brasil
Phone: +55-11-3585-1100 Fax: +55-11-3585-1187
www.yaskawa.com.br

YASKAWA EUROPE GmbH

Hauptstraße 185, 65760 Eschborn, Germany
Phone: +49-6196-569-300 Fax: +49-6196-569-398
www.yaskawa.eu.com E-mail: info@yaskawa.eu.com

YASKAWA ELECTRIC KOREA CORPORATION

35F, Three IFC, 10 Gukjegeumyung-ro, Yeongdeungpo-gu, Seoul, 07326, Korea
Phone: +82-2-784-7844 Fax: +82-2-784-8495
www.yaskawa.co.kr

YASKAWA ASIA PACIFIC PTE. LTD.

30A, Kallang Place, #06-01, 339213, Singapore
Phone: +65-6282-3003 Fax: +65-6289-3003
www.yaskawa.com.sg

YASKAWA ELECTRIC (THAILAND) CO., LTD.

59, 1F-5F, Flourish Building, Soi Ratchadapisek 18, Ratchadapisek Road, Huaykwang, Bangkok, 10310, Thailand
Phone: +66-2-017-0099 Fax: +66-2-017-0799
www.yaskawa.co.th

YASKAWA ELECTRIC (CHINA) CO., LTD.

22F, Link Square 1, No.222, Hubin Road, Shanghai, 200021, China
Phone: +86-21-5385-2200 Fax: +86-21-5385-3299
www.yaskawa.com.cn

YASKAWA ELECTRIC (CHINA) CO., LTD. BEIJING OFFICE

Room 1011, Tower W3 Oriental Plaza, No.1, East Chang An Avenue,
Dong Cheng District, Beijing, 100738, China
Phone: +86-10-8518-4086 Fax: +86-10-8518-4082

YASKAWA ELECTRIC TAIWAN CORPORATION

12F, No. 207, Section 3, Beishin Road, Shindian District, New Taipei City 23143, Taiwan
Phone: +886-2-8913-1333 Fax: +886-2-8913-1513 or +886-2-8913-1519
www.yaskawa.com.tw

YASKAWA

YASKAWA ELECTRIC CORPORATION

In the event that the end user of this product is to be the military and said product is to be employed in any weapons systems or the manufacture thereof, the export will fall under the relevant regulations as stipulated in the Foreign Exchange and Foreign Trade Regulations. Therefore, be sure to follow all procedures and submit all relevant documentation according to any and all rules, regulations and laws that may apply. Specifications are subject to change without notice for ongoing product modifications and improvements.

© 2015 YASKAWA ELECTRIC CORPORATION

MANUAL NO. SIEP S800001 80N <13>-0

Published in Japan September 2021

19-10-16

Original instructions