

## YASKAWA Z1000 Bypass Option LonWorks Technical Manual

Type: SI-W3

Applicable Products : Z1B1-

To properly use the product, read this manual thoroughly and retain for easy reference, inspection, and maintenance. Ensure the end user receives this manual.

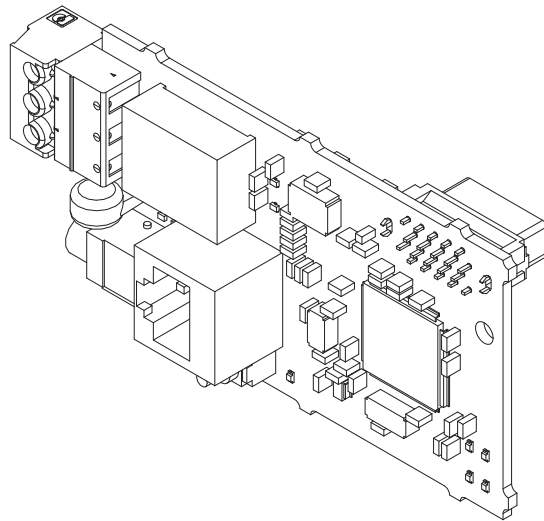

[Download PDF](#)



Copyright © 2016 YASKAWA AMERICA, INC. All rights reserved.

All rights reserved. No part of this publication may be reproduced, stored in a retrieval system, or transmitted, in any form or by any means, mechanical, electronic, photocopying, recording, or otherwise, without the prior written permission of Yaskawa. No patent liability is assumed with respect to the use of the information contained herein. Moreover, because Yaskawa is constantly striving to improve its high-quality products, the information contained in this manual is subject to change without notice. Every precaution has been taken in the preparation of this manual. Yaskawa assumes no responsibility for errors or omissions. Neither is any liability assumed for damages resulting from the use of the information contained in this publication.

# Table of Contents

---

1	PREFACE AND SAFETY.....	4
2	PRODUCT OVERVIEW.....	7
3	RECEIVING.....	9
4	OPTION COMPONENTS.....	10
5	INSTALLATION PROCEDURE.....	11
6	RELATED BYPASS PARAMETERS.....	22
7	COMMON TASKS.....	23
8	NETWORK VARIABLES.....	24
9	DRIVE CONFIGURATION PROPERTIES.....	40
10	TROUBLESHOOTING.....	45
11	FUNCTION MODULES.....	47
12	SPECIFICATIONS.....	71

## 1 Preface and Safety

Yaskawa manufactures products used as components in a wide variety of industrial systems and equipment. The selection and application of Yaskawa products remain the responsibility of the equipment manufacturer or end user. Yaskawa accepts no responsibility for the way its products are incorporated into the final system design. Under no circumstances should any Yaskawa product be incorporated into any product or design as the exclusive or sole safety control. Without exception, all controls should be designed to detect faults dynamically and fail safely under all circumstances. All systems or equipment designed to incorporate a product manufactured by Yaskawa must be supplied to the end user with appropriate warnings and instructions as to the safe use and operation of that part. Any warnings provided by Yaskawa must be promptly provided to the end user. Yaskawa offers an express warranty only as to the quality of its products in conforming to standards and specifications published in the Yaskawa manual. **NO OTHER WARRANTY, EXPRESS OR IMPLIED, IS OFFERED.** Yaskawa assumes no liability for any personal injury, property damage, losses, or claims arising from misapplication of its products.

### ◆ Applicable Documentation

The following manuals are available for the SI-W3 option:

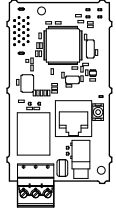
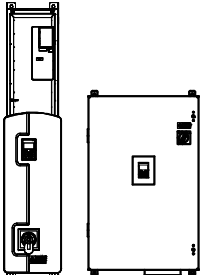
	<p>Yaskawa Bypass 1000-Series Option LonWorks SI-W3 Technical Manual (This manual)</p> <p>The Technical Manual contains information required to install the option and set up related bypass parameters.</p>
	<p>Z1000 Bypass Technical Manual (SIEPYAIZ1B01)</p> <p>This manual provides detailed information on parameter settings and bypass functions. Use this manual to expand bypass functionality and to take advantage of higher performance features. This manual is available for download on our documentation website, <a href="http://yaskawa.com">yaskawa.com</a>.</p>

### ◆ Terms

**Note:** Indicates supplemental information that is not related to safety messages.

**Bypass:** Yaskawa Z1000 Bypass Unit

**Drive:** Yaskawa 1000-Series AC Drive

**Option:** Yaskawa 1000-Series LonWorks SI-W3 Option

### ◆ Registered Trademarks

- LonWorks is a trademark of ECHELON USA.
- All trademarks are the property of their respective owners.

### ◆ Supplemental Safety Information

Read and understand this manual before installing, operating, or servicing this option. The option must be installed according to this manual and local codes.

The following conventions are used to indicate safety messages in this manual. Failure to heed these messages could result in serious or possibly even fatal injury or damage to the products or to related equipment and systems.

 **DANGER**

**Indicates a hazardous situation, which, if not avoided, will result in death or serious injury.**

**⚠ WARNING**

Indicates a hazardous situation, which, if not avoided, could result in death or serious injury.

**WARNING!** may also be indicated by a bold key word embedded in the text followed by an italicized safety message.

**⚠ CAUTION**

Indicates a hazardous situation, which, if not avoided, could result in minor or moderate injury.

**CAUTION!** may also be indicated by a bold key word embedded in the text followed by an italicized safety message.

**NOTICE**

Indicates a property damage message.

**NOTICE:** may also be indicated by a bold key word embedded in the text followed by an italicized safety message.

**■ General Safety****General Precautions**

- The diagrams in this manual may be indicated without covers or safety shields to show details. Replace the covers or shields before operating the drive and run the drive according to the instructions described in this manual.
- Any illustrations, photographs, or examples used in this manual are provided as examples only and may not apply to all products to which this manual is applicable.
- The products and specifications described in this manual or the content and presentation of the manual may be changed without notice to improve the product and/or the manual.
- When ordering a new copy of the manual due to damage or loss, contact your Yaskawa representative or the nearest Yaskawa sales office and provide the manual number shown on the front cover.
- If nameplate becomes worn or damaged, order a replacement from your Yaskawa representative or the nearest Yaskawa sales office.

**⚠ DANGER****Heed the safety messages in this manual.**

Failure to comply will result in death or serious injury.

The operating company is responsible for any injuries or equipment damage resulting from failure to heed the warnings in this manual.

**Electrical Shock Hazard****Do not connect or disconnect wiring while the power is on.**

Failure to comply will result in death or serious injury.

Failure to comply will result in death or serious injury. Before servicing, disconnect all power to the equipment. The internal capacitor remains charged even after the power supply is turned off. The charge indicator LED will extinguish when the DC bus voltage is below 50 Vdc. To prevent electric shock, wait for at least the time specified on the warning label once all indicators are OFF, and then measure the DC bus voltage level to confirm it has reached a safe level.

**NOTICE****Observe proper electrostatic discharge procedures (ESD) when handling the drive and circuit boards.**

Failure to comply may result in ESD damage to the drive circuitry.

**Do not perform a withstand voltage test on any part of the drive.**

Failure to comply could result in damage to the sensitive devices within the drive.

**Do not operate damaged equipment.**

Failure to comply could result in further damage to the equipment.

Do not connect or operate any equipment with visible damage or missing parts.

### NOTICE

**Do not expose the drive to halogen group disinfectants.**

Failure to comply may cause damage to the electrical components in the drive.

Do not pack the drive in wooden materials that have been fumigated or sterilized.

Do not sterilize the entire package after the product is packed.

## 2 Product Overview

### ◆ About this Product

This manual explains the handling, installation and specifications of this product.

The LonWorks Communication Option Card (Model SI-W3) is based on LonTalk. It acts as an interface for connecting an AC bypass to a LonWorks network using the LonTalk protocol.

By installing the option to a bypass unit, the following operations are possible with devices using the LonTalk protocol:

- Operate the bypass
- Operate the drive
- Monitor bypass status
- Monitor drive status
- Change bypass parameter settings

### ◆ Applicable Models

The option can be used with the bypass models in *Table 1*.

**Table 1 Applicable Models**

Drive Series	Bypass Model Z1B1	Software Version <1>
Z1000	D002 to D273	VST800298 and later
	B001 to B304	

<1> See “PRG” on the drive nameplate for the software version number.

◆ Bypass Nameplate

The nameplate is located on the inside right wall of the Z1000 bypass enclosure.

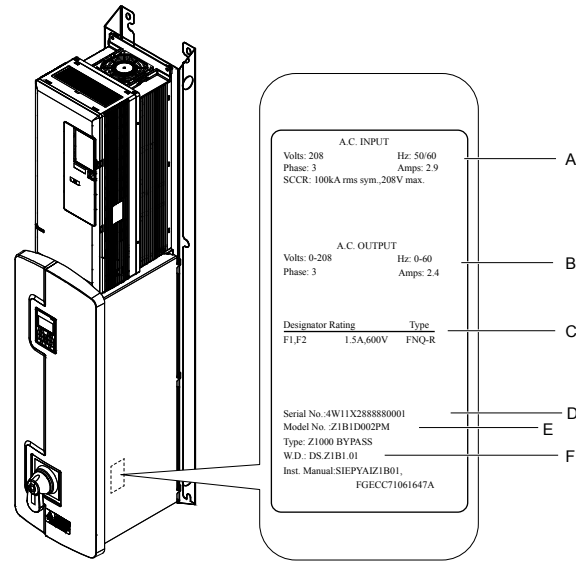

- A – Input specifications**
- B – Output specifications**
- C – Replacement fuse specifications**
- D – Serial number**
- E – Bypass model number**
- F – Schematic document number**

Figure 1 Bypass Nameplate Information Example

◆ Bypass Software Version Number

The software version label for the bypass is located on the bypass PCB. The bypass PCB is located on the inside left wall of the Z1000 Bypass enclosure.

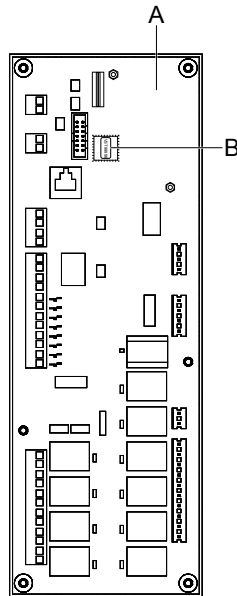

- A – Bypass PCB**
- B – Bypass Software Version Label**

Figure 2 Bypass Software Version Label







### 3 Receiving

Perform the following tasks upon receipt of the option:

- Inspect the option for damage. Contact the shipper immediately if the option appears damaged upon receipt.
- Verify receipt of the correct model by checking the model number printed on the name plate of the option package. *Refer to Option Components on page 10.*
- Contact your supplier if you have received the wrong model or the option does not function properly.

#### ◆ Option Package Contents

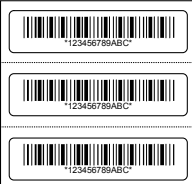
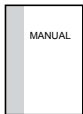
Description	Option	Ground Wire	Screws (M3)	LED Label	Bar Code Label	Installation Manual
-		 </>	 </>	 </>		
Quantity	1	1	3	1	1	1

<1> The ground wire, ground wire screw (1) and LED labels are not required for option card installation to bypass units.

#### ◆ Tools Required for Installation

- A Phillips screwdriver (M3 metric or #1, #2 U.S. standard) is required to install the option and remove bypass front covers. Screw sizes vary by drive capacity. Select a screwdriver appropriate for the bypass capacity.
- Use a short-shaft, magnetic screwdriver when installing the option card into the narrow enclosure models Z1B1D002 to Z1B1D074 and Z1B1B001 to Z1B1B077.
- A straight-edge screwdriver (blade depth: 0.4 mm, width: 2.5 mm) is required to wire the option terminal block.

**Note:** Tools required to prepare the option cables for wiring are not listed in this manual.

## 4 Option Components

### ◆ SI-W3 LonWorks Option

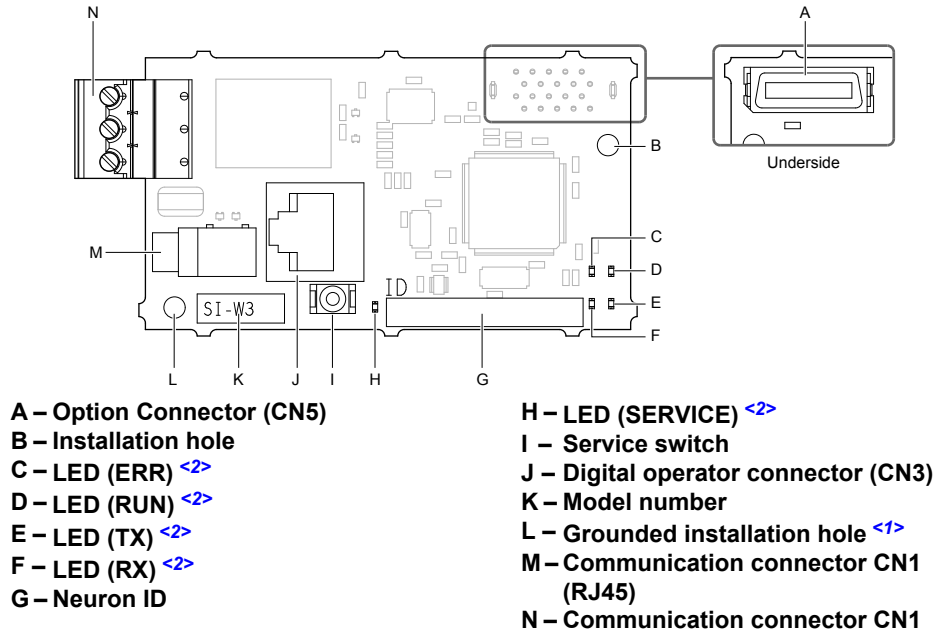

Figure 3 Option Components

- <1> The ground wire packaged loose in the option shipping package is not required for installation to Z1000 bypass units.
- <2> The LEDs are not visible when used in a bypass configuration. Use parameters U6-80 through U6-99 to monitor operation status. [Refer to Option Monitors on page 22.](#)

## 5 Installation Procedure

This section explains how to properly mount and install the communication option card to the Z1000 Bypass.

### ◆ Section Safety

#### DANGER

##### Electrical Shock Hazard

**Do not connect or disconnect wiring while the power is on.**

Failure to comply will result in death or serious injury.

Disconnect all power to the bypass and wait at least the amount of time specified on the bypass front cover safety label. After all indicators are off, measure the DC bus voltage to confirm safe level, and check for unsafe voltages before servicing. The internal capacitor remains charged after the power supply is turned off.

#### WARNING

##### Electrical Shock Hazard

**Do not remove the front covers of the bypass while the power is on.**

Failure to comply could result in death or serious injury.

The diagrams in this section may include options and bypass units without covers or safety shields to show details. Be sure to reinstall covers or shields before operating any devices. The option should be used according to the instructions described in this manual.

**Do not allow unqualified personnel to use equipment.**

Failure to comply could result in death or serious injury.

Maintenance, inspection, and replacement of parts must be performed only by authorized personnel familiar with installation, adjustment, and maintenance of this product.

**Do not touch circuit boards while the power is on.**

Failure to comply could result in death or serious injury.

**Do not use damaged wires, stress the wiring, or damage the wire insulation.**

Failure to comply could result in death or serious injury.

**Do not use damaged wires, place excessive stress on wiring, or damage the wire insulation.**

Failure to comply could result in death or serious injury.

##### Fire Hazard

**Tighten all terminal screws to the specified tightening torque.**

Loose electrical connections could result in death or serious injury by fire due to overheating of electrical connections.

#### NOTICE

**Observe proper electrostatic discharge procedures (ESD) when handling the bypass and circuit boards.**

Failure to comply may result in ESD damage to the bypass circuitry.

**Never shut the power off while the bypass is outputting voltage.**

Failure to comply may cause the application to operate incorrectly or damage the bypass.

**Do not operate damaged equipment.**

Failure to comply may cause further damage to the equipment.

Do not connect or operate any equipment with visible damage or missing parts.

### NOTICE

**Do not use unshielded cable for control wiring.**

Failure to comply may cause electrical interference resulting in poor system performance.

Use shielded twisted-pair wires and ground the shield to the ground terminal of the bypass.

**Properly connect all pins and connectors.**

Failure to comply may prevent proper operation and possibly damage equipment.

**Check wiring to ensure that all connections are correct after installing the option and connecting any other devices.**

Failure to comply could result in damage to the option.

### ◆ Prior to Installing the Option

**NOTICE:** Install communications options on the bypass control PCB. Do not install communications options on the Z1000 drive PCB. Improperly connected communications options will cause erroneous operation.

#### ■ Verify Bypass Operation

Verify that the bypass functions normally without the option installed. Refer to the Z1000 Bypass Technical Manual (SIEPYAIZ1B01) for information on wiring and connecting the bypass unit.

#### ■ Prepare Network Cables

Use only the LonWorks network cables.

Refer to the Echelon web site for more information on network cabling ([www.echelon.com](http://www.echelon.com)). The performance cannot be guaranteed when using the cables other than LonWorks network cables.

Separate the LonWorks cables from the wiring to the main circuit and other lines.

Determine the length of cable required to connect from the option to a network device and attach all connectors to network cables before installing the option.

The communication terminal is a pluggable terminal block that serves as the connection point of the LonWorks network cable to the option.

**Table 2 Terminal CN1 Descriptions**

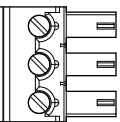
Terminal	Terminal No.	Name	Description
	1	A	Signal Line A
	2	SLD	Shield
	3	B	Signal Line B

**NOTICE:** Heat shrink tubing or electrical tape may be required to ensure that cable shielding does not come into contact with other wiring. Insufficient insulation may cause a short circuit that can damage the option or the drive.

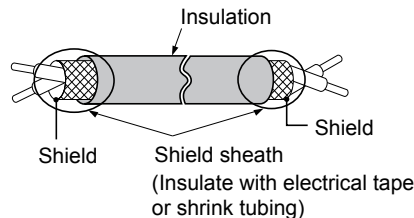

**Figure 4 Preparing Ends of Shielded Cable**

**Note:** Separate network cables from main circuit wiring and other electrical lines.

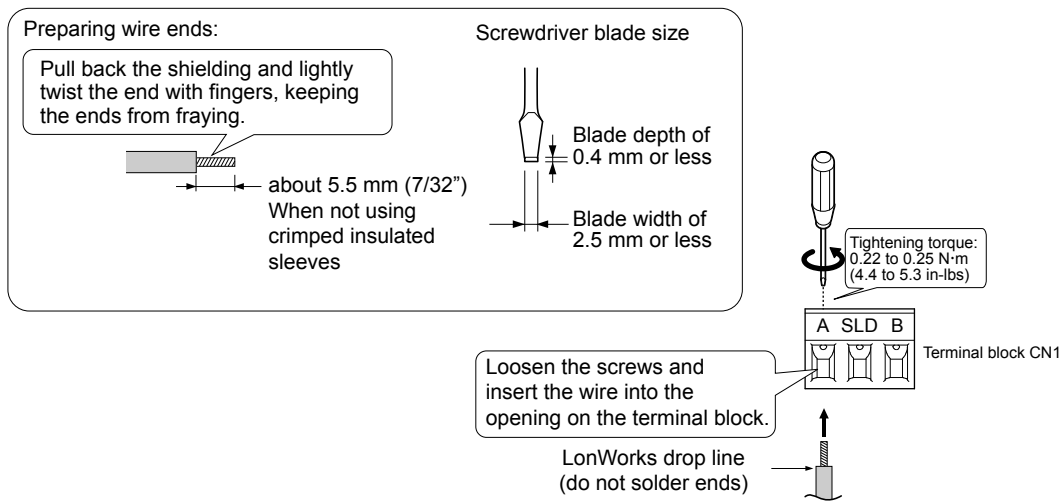

Figure 5 Preparing and Connecting Network Cable Wiring

### ■ Connector CN3 for Digital Operator

**DANGER!** Electric Shock Hazard. Do not touch drive main terminals and control terminals. Failure to comply will result in death or serious injury.

Connecting the CN3 and the digital operator (model: JVOP-182) lets the user set the DDC function parameters. [Refer to Connection of Digital Operator on page 47](#) for details.

### ■ Bypass Unit Components

*Figure 6* shows a front view of the bypass control board with the option connection terminals and related components for reference.

**Note:** Bypass PCB location varies by model.

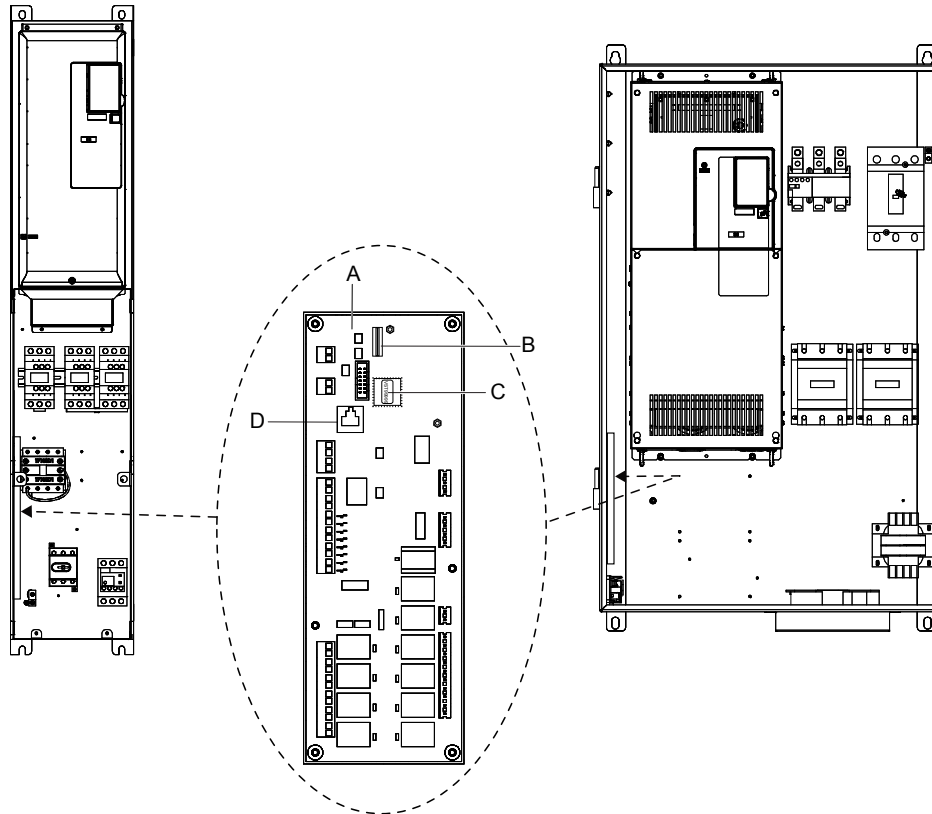

**A – Bypass PCB**

**B – Option card connector (CN5)**

**C – Bypass software version number**

**D – Communications port CN2**

**Figure 6 Front View of Bypass PCB**

## ◆ Remove the Bypass Front Cover

**WARNING!** *Electrical Shock Hazard. Do not open the front cover of the bypass while the power is on. Failure to comply may result in death or serious injury. Make sure that the disconnect handle is in the “OFF” position before attempting to open the front cover.*

### ■ Models Z1B1D002 to D074 and Z1B1B001 to B077

1. Turn the disconnect handle to the “OFF” position and wait the appropriate amount of time for voltage to dissipate. Verify using a multimeter and follow all appropriate lockout/tagout procedures.

**NOTICE:** *Damage to Equipment. Observe proper electrostatic discharge procedures (ESD) when handling the option, bypass, and circuit boards. Failure to comply may result in ESD damage to circuitry.*

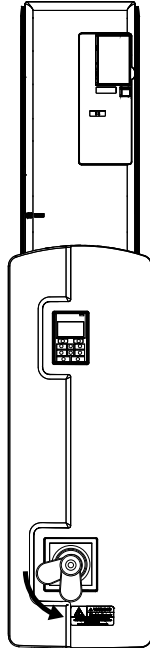

Figure 7 Disconnect Power

## 5 Installation Procedure

2. Remove the two front cover screws using a #2 Phillips screwdriver.

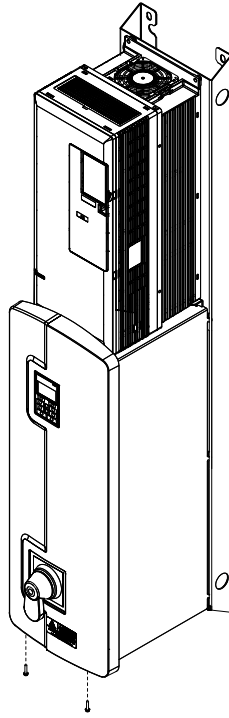

Figure 8 Remove Front Cover Screws

3. Lift the cover up and gently pull forward to remove the front cover.

**NOTICE:** Do not damage the Cat5e cable that connects the keypad to the bypass control PCB when removing the front cover. Failure to comply may cause erroneous operation.

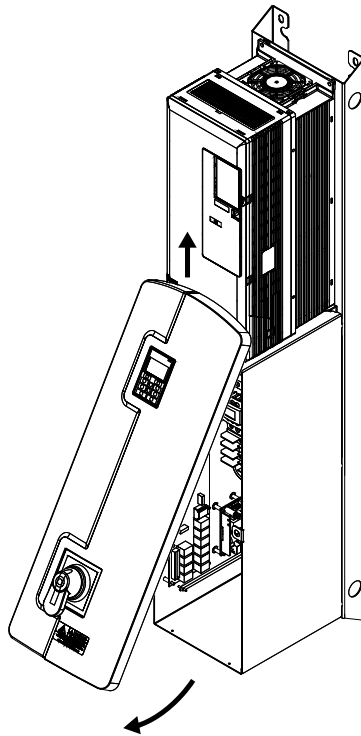

Figure 9 Lift and Remove Front Cover



**Models Z1B1D088 to D273 and Z1B1B096 to B302**

1. Turn the disconnect handle to the “OFF” position and wait the appropriate amount of time for voltage to dissipate. Verify using a multimeter and follow all appropriate lockout/tagout procedures.

**NOTICE:** *Damage to Equipment. Observe proper electrostatic discharge procedures (ESD) when handling the option, bypass, and circuit boards. Failure to comply may result in ESD damage to circuitry.*

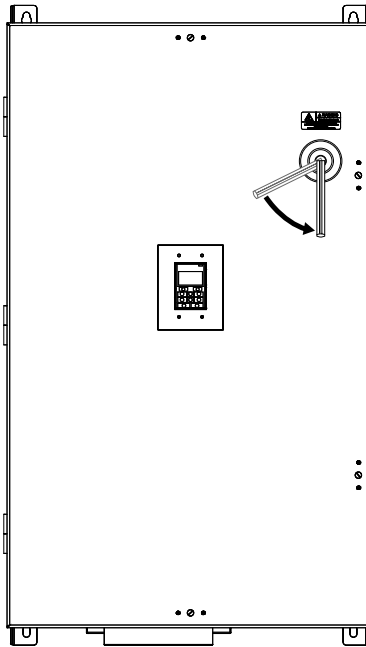

Figure 10 Disconnect Power

2. Turn the flat head screw fasteners on the front cover 1/2 turn counter-clockwise.

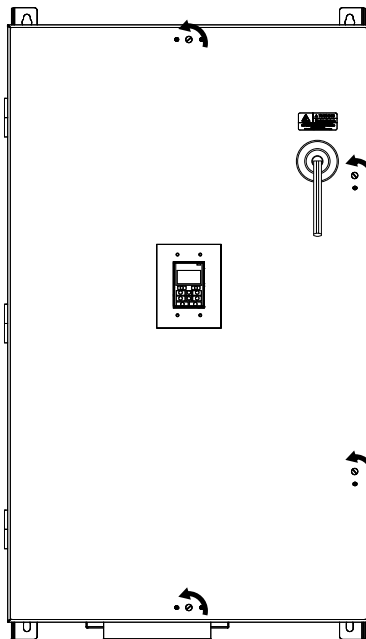

Figure 11 Turn Front Cover Fasteners

## 5 Installation Procedure

---

3. Carefully swing open the bypass front cover door.

**NOTICE:** Do not damage the Cat5e cable that connects the keypad to the bypass control PCB when removing the front cover. Failure to comply may cause erroneous operation.

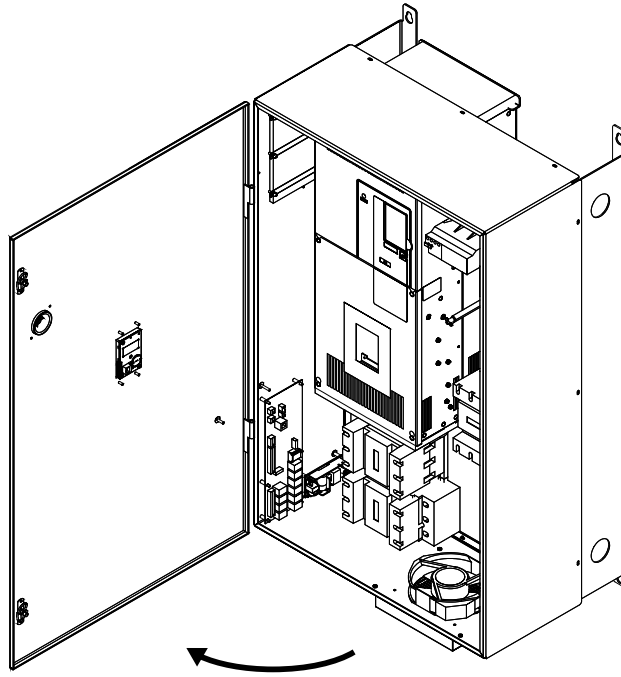

Figure 12 Swing Open Door

## ◆ Install the Option

**DANGER! DANGER! Electrical Shock Hazard.** Do not connect or disconnect wiring while the power is on. Failure to comply could result in death or serious injury. Before installing the option, disconnect all power to the bypass and wait at least the amount of time specified on the bypass front cover safety label. After all indicators are off, measure the DC bus voltage to confirm safe level, and check for unsafe voltages before servicing. The internal capacitor remains charged after the power supply is turned off.

1. Fasten the option card to the metal standoffs on the bypass PCB using two screws included in the option kit. Use a short-shaft, magnetic screwdriver for narrow enclosure models Z1B1D002 to Z1B1D074 and Z1B1B001 to Z1B1B077. Tighten each screw to 0.5 to 0.6 N•m (4.4 to 5.3 in lbs).

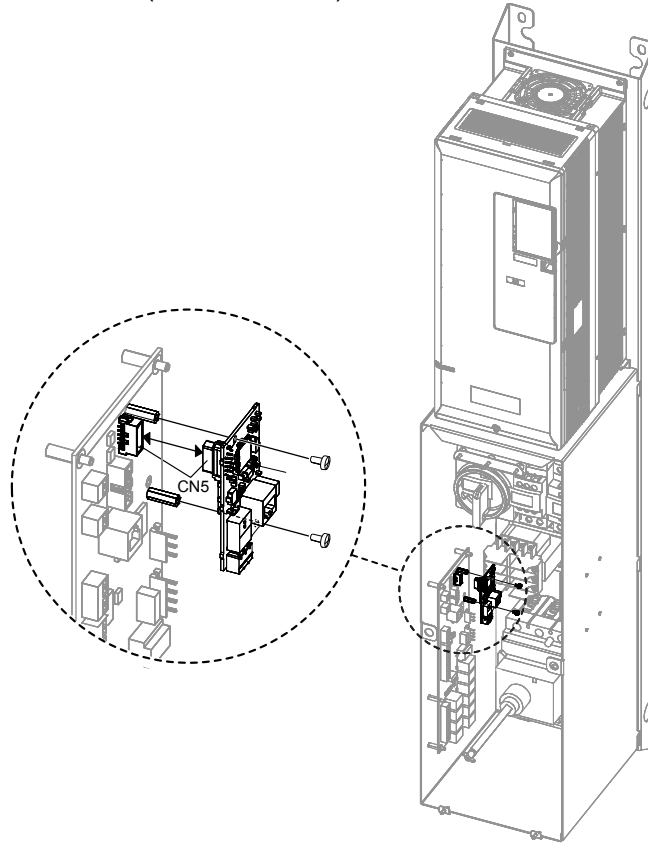
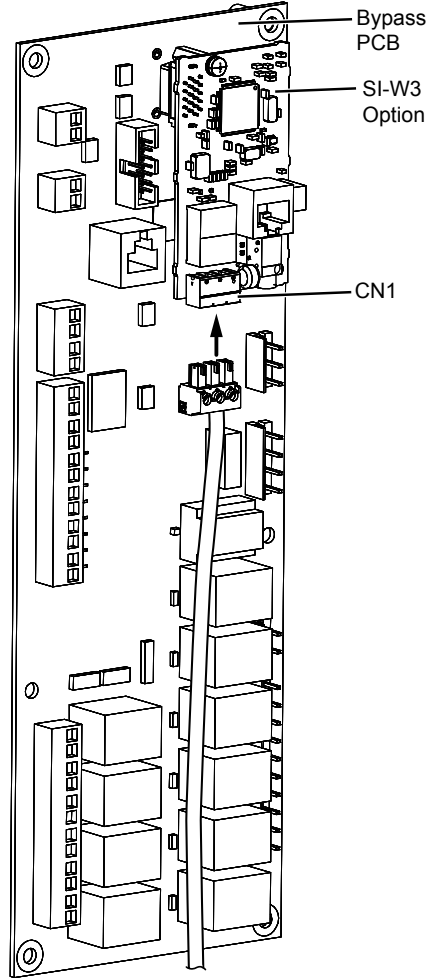

Figure 13 Insert Option into Bypass PCB CN5 Connector Port - Model Z1B1D002

## 5 Installation Procedure

2. Connect the customer-supplied network cable to the option by firmly inserting the CN1 terminal block into the CN1 connection port on the option board.



**Figure 14 Connect Network Cable to Option**

**NOTICE:** Separate control circuit wiring from main circuit wiring and other high-power lines. Improper wiring practices could result in bypass malfunction due to electrical interference.

## Option Connection Diagram

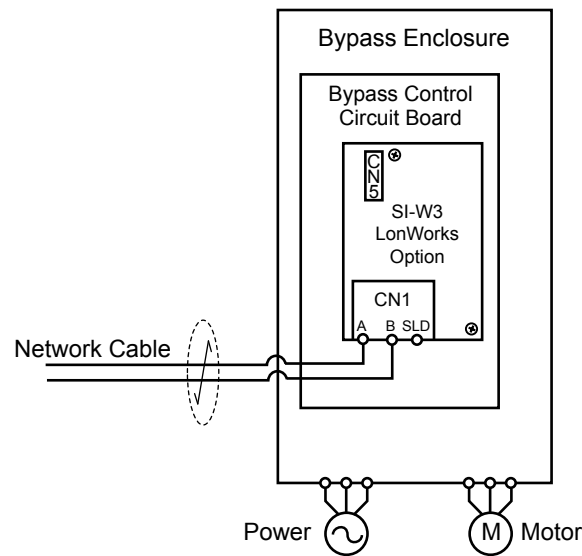

Figure 15 Option Connection Diagram

3. Replace and secure the bypass front cover.
4. Make sure no cables are pinched between the front covers and the bypass when replacing the covers.
5. Set bypass parameters according to Section [6 Related Bypass Parameters](#) on page [22](#).

### ◆ XIF Files, Resource Files

XIF files and the resource files for this option card are not included. For more information, either contact Yaskawa's sales department directly or your nearest Yaskawa representative.

### ◆ Option LED Display

The LEDs are not visible when used in a bypass configuration. Use parameters U6-80 through U6-99 to monitor operation status. [Refer to Option Monitors on page 22](#) for details.

## 6 Related Bypass Parameters

The following parameters are used to set up the bypass for operation with the option. Parameter setting instructions can be found in the drive manual.

Confirm proper setting of the parameters in *Table 3* before starting network communications. After changing parameter settings, cycle power to the bypass for the new settings to take effect.

**Table 3 Related Parameters**

No. (Addr. Hex)	Name	Description	Values
F6-01 (03A2)	Communications Error Operation Selection	0: Ramp to stop. Decelerate to stop using the deceleration time in C1-02. 1: Coast to stop 2: Fast Stop. Decelerate to stop using the deceleration time in C1-09. 3: Alarm only. <1> 4: Alarm (d1-04)	Default: 1 Range: 0 to 4
F6-02 (03A3)	External Fault from Comm. Option Detection Selection	0: Always detected 1: Detection during run only	Default: 0 Range: 0, 1
F6-03 (03A4)	External Fault from Comm. Option Operation Selection	0: Ramp to stop. Decelerate to stop using the deceleration time in C1-02. 1: Coast to stop 2: Fast Stop. Decelerate to stop using the deceleration time in C1-09. 3: Alarm only <1>	Default: 1 Range: 0 to 3
Z1-07 (85CC)	Speed Reference Select <2>	0: Operator 1: Analog Input 2: Bypass Serial 3: Option Board (CN5)	Default: 1 Range: 0 to 3
Z1-08 (85CD)	Run Command Select <2>	0: Operator 1: Bypass Controller Digital Input 2: Bypass Serial 3: Option Board (CN5)	Default: 1 Range: 0 to 3
Z1-38 (85EB)	HOA Source Select	0: Operator 1: Digital Inputs 2: Ser Comm & Opt	Default: 0 Range: 0 to 2
Z1-39 (85EC)	Drive/Bypass Source Select	0: Operator 1: Digital Inputs 2: Serial Communications	Default: 0 Range: 0 to 2

<1> When set to 3, the drive will continue to operate when a fault is detected. Take safety measures, such as installing an emergency stop switch.

<2> Available in bypass controller software versions VST800400 and later.

**Table 4 Option Monitors**

No.	Name	Description	Value Range
U6-80 to U6-83	Online IP Address	IP Address currently available; U6-80 is the most significant octet	0 to 255
U6-84 to U6-87	Online Subnet	Subnet currently available; U6-84 is the most significant octet	0 to 255
U6-88 to U6-91	Online Gateway	Gateway currently available; U6-88 is the most significant octet	0 to 255
U6-92	Online Speed	Link Speed	10: 10 Mbps 100: 100 Mbps
U6-93	Online Duplex	Duplex Setting	0: Half, 1: Full
U6-94	Port 2 Speed	Port 2 Link Speed	10: 10 Mbps 100: 100 Mbps
U6-95	Port 2 Duplex	Port 2 Duplex Setting	0: Half, 1: Full
U6-97	Option Software Version	Option Software Version	–
U6-98	First Fault	First Option Fault	–
U6-99	Current Fault	Current Option Fault	–

## 7 Common Tasks

Common tasks when using an SI-W3 option kit on a Z1000 bypass.

### ◆ Accessing Drive and Bypass Monitors and Parameters

Register addresses can be found in the Z1000 Bypass Technical Manual SIEPYAIZ1B01, MEMOBUS/Modbus Data Table section.

### ◆ Monitor Statuses

Table 5 Monitor Various Statuses

Status	Description	Drive Mode	Bypass Mode
Run	Read this status using Output Network Variable nvoRunStatus (SNVT_switch).	x	-
	Read this status using address 8785H (bit 1) by first writing a value of 34693 to Input Network Variable nviReadParamNum (SNVT_count) then reading the actual status from Output Network Variable nvoReadParamVal (SNVT_count_inc).	x	x
Fault	Read this status using Output Network Variable nvoInvFault (SNVT_switch).	x	-
	First write a value of 34693(8785H) to Input Network Variable nviReadParamNum (SNVT_count), then read the actual status from Output Network Variable nvoReadParamVal (SNVT_count_inc) using address 8785H (bit 2).	x	x
Output Frequency	Output frequency can be read using Output Network Variables nvoDrvSpeed (SNVT_lev_percent) or nvoInvOutFreq (SNVT_freq_hz).	x	x
Output Current	Read using Output Network Variable nvoDrvCurrent (SNVT_amp).	x	-
	Read this status using register 8780H (scaling = 0.1A). Write a value of 34688(8780H) to Input Network Variable nviReadParamNum (SNVT_count), then read the actual status from Output Network Variable nvoReadParamVal (SNVT_count_inc).	-	x

### ◆ Issuing Bypass Commands

Table 6 Issue Various Commands

Command	Description
Frequency Reference	Set parameter Z1-07 to 3. Frequency reference is written using Input Network Variables nvInvSetFreq (SNVT_freq_hz), or nviDrvSpeedRef (SNVT_lev_percent).
Run/Stop	Set parameter Z1-08 to 3. Run/Stop command is written using Input Network Variable nviRunCommand (SNVT_switch).
Fault Reset	Fault Reset command (Drive Mode Only) is written using Input Network Variable nviOpCommands (SNVT_state), (bit 9).
	Fault Reset command (Both Drive and Bypass Modes) is performed by first writing a value of 33792(8400H) to Input Network Variable nviWriteParamNum (SNVT_count). A value of 8192(2000H) must be written to Input Network Variable nviWriteParamVal (SNVT_count_inc).

# 8 Network Variables

## ◆ Drive and Network Variables

Figure 16 outlines the relationship between drive and network variables.

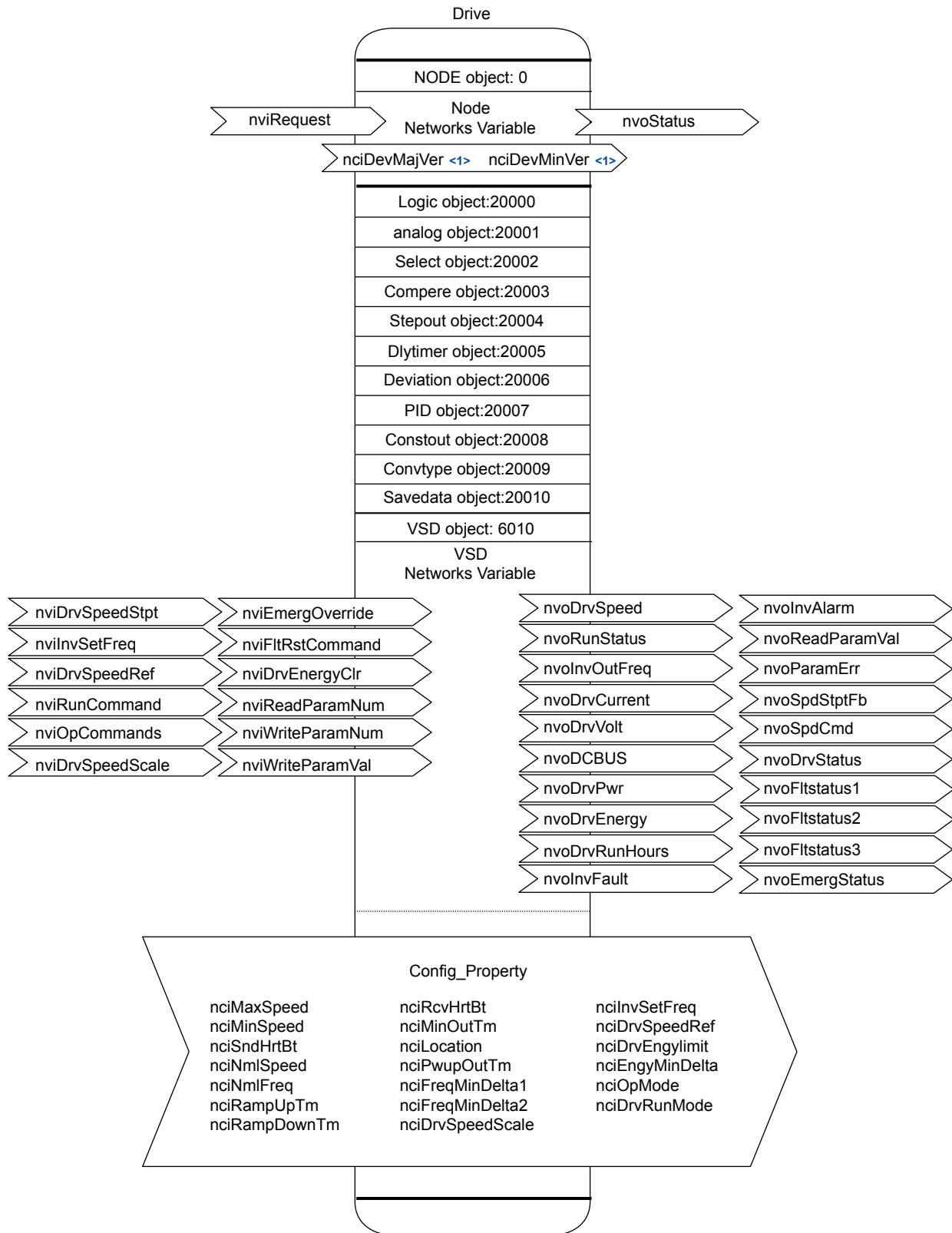

Figure 16 Drive and Network Variables



## ◆ Node Objects

### ■ Object Requests

Input: FSNVT\_obj\_request nviRequest

Requests the status for each object in a node.

Member Name	Description	
object_id	Object ID number	
	0	Entire node
	1	VSD
	2	logic [0]
	3	logic [1]
	4	logic [2]
	5	logic [3]
	6	logic [4]
	7	logic [5]
	8	logic [6]
	9	logic [7]
	10	Analog [0]
	11	Analog [1]
	12	Analog [2]
	13	Analog [3]
	14	Analog [4]
	15	Analog [5]
	16	Analog [6]
	17	Analog [7]
	18	Analog [8]
	19	Analog [9]
	20	Select [0]
	21	Select [1]
	22	Select [2]
	23	Select [3]
	24	Select [4]
	25	Select [5]
	26	Select [6]
	27	Select [7]
	28	Compare [0]
	29	Compare [1]
	30	Compare [2]
	31	Compare [3]
	32	Compare [4]
33	Compare [5]	

## 8 Network Variables

Member Name	Description		
object_id	Object ID number		
	34	Compare [6]	
	35	Compare [7]	
	36	Stepout [0]	
	37	Dlytimer [0]	
	38	Dlytimer [1]	
	39	Deviation [0]	
	40	Pidmodule [0]	
	41	Pidmodule [1]	
	42	Pidmodule [2]	
	43	Pidmodule [3]	
	44	Constout [0]	
	45	Constout [1]	
	46	Constout [2]	
	47	Constout [3]	
	48	Constout [4]	
	49	Constout [5]	
	50	Convtype [0]	
	51	Convtype [1]	
	52	Convtype [2]	
	53	Convtype [3]	
	54	Savedata [0]	
	55	Savedata [1]	
	56	Savedata [2]	
57	Savedata [3]		
Other	invalid_id		
object_request	0	RQ_NORMAL	Enables the object.
	1	RQ_DISABLED	Disable the object
	2	RQ_UPDATE_STATUS	Not supported. (Normal response)
	3	RQ_SELF_TEST	Not supported. (Normal response)
	4	RQ_UPDATE_ALARM	Not supported. (Normal response)
	5	RQ_REPORT_MASK	Not supported. (Returns message: invalid_request.)
	6	RQ_OVERRIDE	Not supported. (Returns message: invalid_request.)
	7	RQ_ENABLE	Enables the object.
	8	RQ_RMV_OVERRIDE	Not supported. (Returns message: invalid_request.)
	9	RQ_CLEAR_STATUS	Not supported. (Returns message: invalid_request.)
	10	RQ_CLEAR_ALARM	Not supported. (Returns message: invalid_request.)
	11	RQ_ALARM_NOTIFY_ENABLED	Not supported. (Returns message: invalid_request.)
	12	RQ_ALARM_NOTIFY_DISABLE D	Not supported. (Returns message: invalid_request.)
	13	RQ_MANUAL_CTRL	Not supported. (Returns message: invalid_request.)
	14	RQ_REMOTE_CTRL	Not supported. (Returns message: invalid_request.)
	15	RQ_PROGRAM	Not supported. (Returns message: invalid_request.)
0xff	RQ_NUL	Not supported. (Returns message: invalid_request.)	

### ■ Object Status

Output: FSNVT\_obj\_status nvoStatus

Displays the status of objects in a node.

Member Name		Description
object_id		Object ID (refer to the object request)
bit 31	invalid_id	Turns ON if the object_id specified by nviRequest is invalid.
bit 30	invalid_request	Turns ON if the object_request specified by nviRequest is invalid.
bit 29	disabled	Indicates whether or not a given object is enabled for operation. Turns ON when an object is disabled.
bit 28	out_of_limits	Not supported. (Always 0)
bit 27	open_circuit	Not supported. (Always 0)
bit 26	out_of_service	Not supported. (Always 0)
bit 25	mechanical_fault	Not supported. (Always 0)
bit 24	feedback_failure	Not supported. (Always 0)
bit 23	over_range	Not supported. (Always 0)
bit 22	under_range	Not supported. (Always 0)
bit 21	electrical_fault	Not supported. (Always 0)
bit 20	unable_to_measure	Not supported. (Always 0)
bit 19	comm_failure	Not supported. (Always 0)
bit 18	fail_self_test	Not supported. (Always 0)
bit 17	self_test_in_progress	Not supported. (Always 0)
bit 16	locked_out	Not supported. (Always 0)
bit 15	manual_control	Not supported. (Always 0)
bit 14	in_alarm	Not supported. (Always 0)
bit 13	in_override	Not supported. (Always 0)
bit 12	report_mask	Not supported. (Always 0)
bit 11	programming_mode	Not supported. (Always 0)
bit 10	programming_fail	Not supported. (Always 0)
bit 9	alarm_notify_disabled	Not supported. (Always 0)
bit 8 to 0	reserved	Always 0

### ◆ VSD Input Network Variables

Name	Variable Type	Description
nviDrvSpeedStpt	SNVT_switch	Drive Speed Setpoint
nviInvSetFreq	SNVT_freq_hz	Drive Frequency Reference (Hz)
nviDrvSpeedRef	SNVT_lev_percent	Drive Speed SetFreq (%)
nviRunCommand	SNVT_switch	Drive Run Reference
nviOpCommands	SNVT_state	Drive Operation Commands
nviDrvSpeedScale	SNVT_lev_percent	Drive Speed Setpoint Scaling
nviEmergOverride	SNVT_hvac_emerg	Drive Emergency
nviFltRstCommand	SNVT_switch	Drive Speed Setpoint Scaling
nviDrvEnergyClr	SNVT_switch	Drive Speed Setpoint Scaling
nviReadParamNum	SNVT_count	Drive Parameter Read
nviWriteParamNum	SNVT_count	Drive Parameter Write
nviWriteParamVal	SNVT_count_inc	Drive Parameter Write Data

## 8 Network Variables

### ■ Drive Speed Setpoint (Drive Speed Operation Command)

Input	SNVT_switch nviDrvSpeedStpt
Default	state = FF; value = 0 Frequency reference = nviDrvSpeedStpt (%) × nviDrvSpeedScale (%) × nciNmlFreq (Hz) <b>Note:</b> When values greater than the maximum output frequency and less than 400 Hz are set, operation is executed at the maximum output frequency. Values greater than 400 Hz are not set in the Drive.
Related network variables, configuration properties	nciRcvHrtBt

This network variable sets Drive run/stop commands and frequency references.

State	Value	Command
0	NA	Drive stop
1	0	Zero-speed operation
1	1 to 200	0.5 to 100.0%
1	201 to 255	100.00%
FF (-1)	NA	Disable

After the power is turned ON, “*ERR*” is displayed at the Operator until data is received.

Also, when a receive heartbeat time is set, a communications error is generated and “*bus*” is displayed at the Operator if no data is received within that time period.

### ■ Drive Frequency Reference (Hz) (Drive Frequency)

Input	SNVT_freq_hz nviInvSetFreq
Setting range	0.0 to 6,553.5 Hz (Effective range: 0.0 to 400.0 Hz)
Default	nciInvSetFreq set value Frequency reference values are restricted by the maximum output frequency and the upper limit frequency that have been set for the Drive. Frequency reference = nviInvSetFreq (Hz)
Related network variables, configuration properties	nciRcvHrtBt, nciInvSetFreq

This network variable sets Drive frequency reference values in Hz.

**Note:** When values greater than the maximum output frequency and less than 400 Hz are set, operation is executed at the maximum output frequency. Values greater than 400 Hz are not set in the Drive.

Frequency reference values are restricted by the maximum output frequency and the upper limit frequency that have been set for the Drive.

After the power is turned ON, “*ERR*” is displayed at the Operator until data is received. Also, when a receive heartbeat time is set, a communications error is generated and “*bus*” is displayed at the Operator if no data is received within that time period.

### ■ Drive Speed SetFreq (%) (Drive Speed Reference)

Input	SNVT_lev_percent nviDrvSpeedRef
Setting range	-163.840 to 163.835% (Effective range: 0.0 to frequency conversion value 400.0 Hz)
Default	nciDrvSpeedRef set value
Related network variables, configuration properties	nciRcvHrtBt

This network variable sets Drive speed reference values in percentages.

**Note:** When values greater than the maximum output frequency and less than 400 Hz are set, operation is executed at the maximum output frequency. Values greater than 400 Hz are not set in the Drive.

After the power is turned ON, “*ERR*” is displayed at the Operator until data is received. Also, when a receive heartbeat time is set, a communications error is generated and “*bus*” is displayed at the Operator if no data is received within that time period.

Speed reference value = nviDrvSpeedRef (%) × nviDrvSpeedScale (%) × nciNmlFreq (Hz)

**■ Drive Run Reference (Drive Run Reference)**

Input	SNVT_switch nviRunCommand
Default	state = FF; value = 0
Related network variables, configuration properties	nciRcvHrtBt

This network variable sets Drive run and stop commands.

State	Value	Command
0	NA	Drive stop
1	NA	Drive run
FF (Default)	NA	Drive stop

After the power is turned ON, “*LLL*” is displayed at the Operator until data is received. Also, when a receive heartbeat time is set, a communications error is generated and “*bus*” is displayed at the Operator if no data is received within that time period.

**■ Drive Operation Commands (Drive Control Commands)**

Input	SNVT_state nviOpCommands
Default	0 0 0 0 0 0 0 0 0 0 0 0 0 0 0 0

These network variables can control operations such as Drive running and stopping.

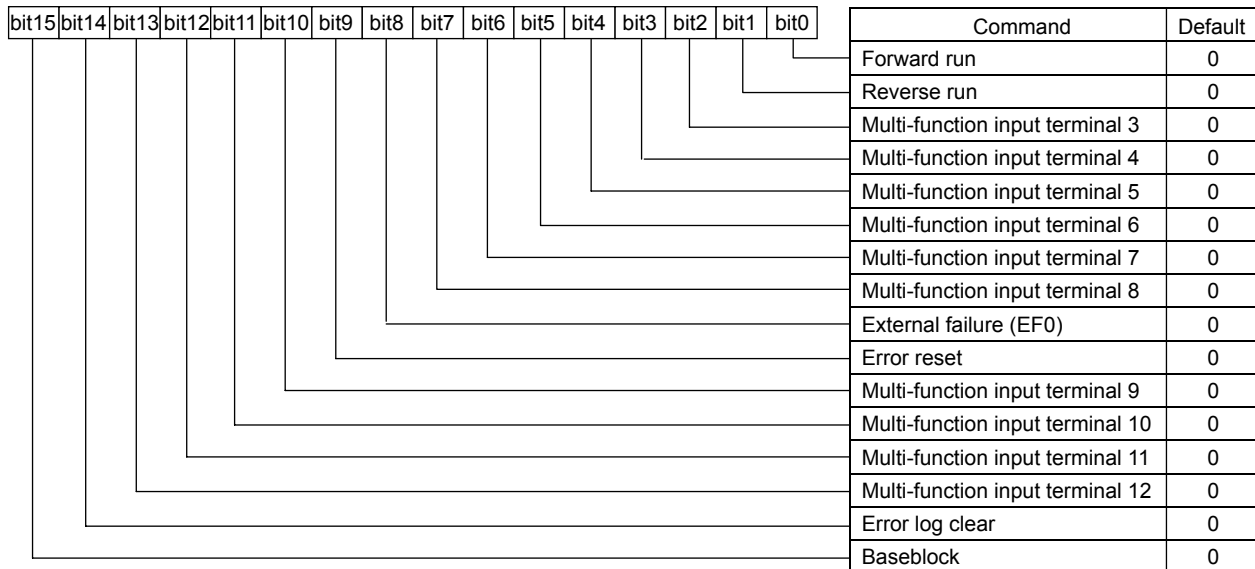

There is a logical OR relationship between commands using these variables and other run command-related network variables and multi-function control terminals.

**■ Drive Speed Setpoint Scaling (Drive Speed Scaling)**

Input	SNVT_lev_percent nviDrvSpeedScale
Setting range	-163.840% to 163.830% (0.005%). 163.835% is taken as 100%.
Default	nciDrvSpeedScale set value
Related network variables, configuration properties	nciRcvHrtBt

This network variable is used for adjusting the motor rotation direction and speed.

Frequency reference = nviDrvSpeedStpt (or nviDrvspeedfref) × nviDrvSpeedScale × nciNmlfreq

## 8 Network Variables

### ■ Drive Emergency (Drive Emergency Stop)

Input	SNVT_hvac_emerg nviEmergOverride
Setting range	0: Emergency stop clear 4: Emergency stop FF: Disabled
Default	FF

This network variable executes Drive emergency stops from the network. When an emergency stop is executed, “ ” is displayed at the Drive.

### ■ Drive Fault Reset Command (Drive Error Reset)

Input	SNVT_switch nviFltRstCommand
Data range	value ••• NA, state •••-1,0,1
Default	value ••• 0, state ••• - Errors are cleared in state1, and not in 0 or -1.

This network variable performs a reset from the network when an Drive error occurs.

### ■ Drive Energy Clear (Cumulative Power Value Clear)

Input	SNVT_switch nviDrvEnergyClr
Data range	value ••• NA, state •••-1 (FFH),0,1
Default	value ••• 0, state •••-1 (FFH) Accumulated power values are cleared in state1, and not in 0 or -1 (FFH).
Related network variables, configuration properties	nvoDrvEnergy, nciDrvEngylimit, nciEngyMinDelta

This network variable clears accumulated power values.

### ■ Drive Parameter Read (Drive Constant Read Request)

Input	SNVT_count nviReadParamNum
Data range	0000 to FFFFH
Default	0 For register numbers, refer to the Z1000 Bypass Technical Manual (SIEPYAIZ1B01).
Related network variables, configuration properties	nnviWriteParamNum, nvoReadParamVal, nvoParamErr

This network variable is used to read Drive constants. Set the register number of the constant that is to be read. After the Drive receives the data, it sets the data for that register number in nvoReadParamVal to be output.

### ■ Drive Parameter Write (Drive Constant Write Request)

Input	SNVT_count nviWriteParamNum
Data range	0000 to FFFFH
Default	0
Related network variables, configuration properties	nviReadParamNum, nvoWriteParamVal, nvoParamErr

This network variable is used to write drive constants. Set the register number of the constant that is to be written. Then set the changed data in nviWriteParamVal. After the Drive receives the data, it sets the data for that register number in nvoReadParamVal to be output.

**Note:** If no data is set in nviWriteParamVal within 30 seconds after this network variable has been set, an error code is stored in nvoParamErr and the data set in nviWriteParamNum is changed to 0.

### ■ Drive Parameter Write Data (Drive Constant Write Data)

Input	SNVT_count_inc nviWriteParamVal
Data range	-32,768 to 32,767
Default	0
Related network variables, configuration properties	nviReadParamNum, nvoWriteParamNum, nvoParamErr

This network variable is used to write drive constants. Set the register number of the constant that is to be written. Then set the changed data in `nviWriteParamVal`. After the Drive receives the data, it sets the data for that register number in `nvoReadParamVal` to be output.

### Run Command and Frequency Reference Combinations and Priority

The Drive provides multiple network variables for run commands and frequency references, but they can only be used one at a time. This section describes various combinations of network variables and their orders of priority.

- Network Variable Combinations for Run Commands and Frequency References

	Combination 1	Combination 2	Combination 3
Frequency (speed) reference	<code>nviInvSetFreq</code>	<code>nviDrvSpeedStpt</code> (value)	<code>nviDrvSpeedFref</code>
Run command	<code>nviRunCommand</code>	<code>nviDrvSpeedStpt</code> (state)	<code>nviRunCommand</code>

- Order of priority  
Combination 1 > Combination 2 > Combination 3 (Default: All disabled)
- Precautions when Making the Settings
- Combination 1  
Set the network variables as follows:  
`nviDrvSpeedStpt` (state) = FF  
`nviDrvSpeedRef` = 7FFF  
Do not execute binding for these network variables.
- Combination 2  
Set the network variables as follows:  
`nviInvSetFreq` = 7FFF (default)  
`nviDrvSpeedRef` = 7FFF (default)  
`nviRunCommand` (state) = FF (default)  
Do not execute binding for these network variables.
- Combination 3  
Set the network variables as follows:  
`nviDrvSpeedStpt` (state) = FF  
`nviInvSetFreq` = 7FFF  
Do not execute binding for these network variables.

### ◆ VSD Output Network Variables

Name	Variable Type	Description
<code>nvoDrvSpeed</code>	SNVT_lev_percent	Drive Speed Feedback (%)
<code>nvoRunStatus</code>	SNVT_switch	Drive Run Status
<code>nvoInvOutFreq</code>	SNVT_freq_hz	Drive Output Frequency
<code>nvoDrvCurrent</code>	SNVT_amp	Drive Output Current
<code>nvoDrvVolt</code>	SNVT_volt	Drive Output Voltage
<code>nvoDCBUS</code>	SNVT_volt	Drive DC Voltage
<code>nvoDrvPwr</code>	SNVT_power_kilo	Drive Output Power
<code>nvoDrvEnergy</code>	SNVT_elec_kwh_l	Cumulative Drive Energy
<code>nvoDrvRunHours</code>	SNVT_time_hour	Drive Total Running Hours
<code>nvoInvFault</code>	SNVT_switch	Drive Fault Status
<code>nvoInvAlarm</code>	SNVT_switch	Drive Alarm Status
<code>nvoReadParamVal</code>	SNVT_count_inc	Drive Parameter Read Data
<code>nvoParamErr</code>	SNVT_count	Drive Parameter Error
<code>nvoSpdStptFb</code>	SNVT_lev_percent	Drive Speed Setpoint Feedback1
<code>nvoSpdCmd</code>	SNVT_lev_percent	Drive Speed Setpoint Feedback2
<code>nvoDrvStatus</code>	SNVT_state	Drive Status
<code>nvoFltstatus1</code>	SNVT_state	Drive Fault Status1
<code>nvoFltstatus2</code>	SNVT_state	Drive Fault Status2
<code>nvoFltstatus3</code>	SNVT_state	Drive Fault Status3
<code>nvoEmergStatus</code>	SNVT_hvac_emerg	Drive Emerg Status

## 8 Network Variables

### ■ Drive Speed Feedback (%) (Drive Speed Monitoring)

Output	SNVT_lev_percent nvoDrvSpeed
Data range	-163.840% to 163.830% (0.005%)
Service type	Default: Authentication type

This network variable outputs the Drive's output frequency as a percentage of the standard motor frequency.

Output Timing	Explanation
Event driven	Sent to network when data is changed.
nciSndHrtBt	When a send heartbeat time is set, the data is output within that time period.
nciMinOutTm	When a minimum output refresh time has been set, data that is changed during the specified time period is not output until that time period has elapsed.
nciFreqMinDelta	Output when the frequency is outside of the recently changed frequency range.

### ■ Drive Run Status (Drive Run Monitoring)

Output	SNVT_switch nvoRunStatus
Data range	State = 0
Service type	Default: Authentication type
Output timing	Event driven, nciSndHrtBt

This network variable monitors Drive run and stop status.

State	Value	Command
0	NA	Drive stopped
1	NA	Drive running
FF (Default)	NA	None

Output Timing	Explanation
Event driven	Sent to network when data is changed.
nciSndHrtBt	When a send heartbeat time is set, the data is output within that time period.

### ■ Drive Output Frequency (Drive Output Frequency Monitoring)

Output	SNVT_freq_hz nvoInvOutFreq
Data range	0 to 6553.4Hz (0.1Hz)
Service type	Default: Authentication type

This network variable outputs Drive output frequency.

Output Timing	Explanation
Event driven	Sent to network when data is changed.
nciSndHrtBt	When a send heartbeat time is set, the data is output within that time period.
nciMinOutTm	When a minimum output refresh time has been set, data that is changed during the specified time period is not output until that time period has elapsed.
nciFrefMinDelta2	Output when the frequency is outside of the recently changed frequency range.

### ■ Drive Output Current (Output Current Monitoring)

Output	SNVT_amp nvoDrvCurrent
Data range	0 to 3,276.6 A
Service type	Default: Authentication type

This network variable outputs Drive output current.

Output Timing	Explanation
Event driven	Sent to network when data is changed.
nciSndHrtBt	When a send heartbeat time is set, the data is output within that time period.
nciMinOutTm	When a minimum output refresh time has been set, data that is changed during the specified time period is not output until that time period has elapsed.



### ■ Drive Output Voltage (Output Voltage Monitoring)

Output	SNVT_volt nvoDrvVolt
Data range	0 to 3276.7 V (Unit: 0.1 V)
Service type	Default: Authentication type

This network variable outputs Drive output voltage.

Output Timing	Explanation
Event driven	Sent to network when data is changed.
nciSndHrtBt	When a send heartbeat time is set, the data is output within that time period.
nciMinOutTm	When a minimum output refresh time has been set, data that is changed during the specified time period is not output until that time period has elapsed.

### ■ Drive DC Voltage (DC Bus Voltage Monitoring)

Output	SNVT_volt nvoDCBus
Data range	0 to 3276.7 V (Unit: 0.1 V)
Service type	Default: Authentication type

This network variable outputs DC bus voltage.

Output Timing	Explanation
Event driven	Sent to network when data is changed.
nciSndHrtBt	When a send heartbeat time is set, the data is output within that time period.
nciMinOutTm	When a minimum output refresh time has been set, data that is changed during the specified time period is not output until that time period has elapsed.

### ■ Drive Output Power (Output Power Monitoring)

Output	network output SNVT_power_kilo nvoDrvPwr
Data range	0 to 6,553.4 kW (Unit: 0.1 kW)
Service type	Default: Authentication type

This network variable outputs Drive output power.

Output Timing	Explanation
Event driven	Sent to network when data is changed.
nciSndHrtBt	When a send heartbeat time is set, the data is output within that time period.
nciMinOutTm	When a minimum output refresh time has been set, data that is changed during the specified time period is not output until that time period has elapsed.

### ■ Cumulative Drive Energy (Cumulative Power Monitoring)

Output	SNVT_elec_kwh_1 nvoDrvEnergy
Cumulative period	100 ms ± 10% (Varies slightly depending on the amount of data sent and received in the network.)
Data range	0 to 429,496,729.4 kwh (Unit: 0.1 kwh)
Service type	Default: Authentication type
Related network variables, configuration properties	nviDrvEnergyClr, nciDrvEngylimit, nciEngyMinDelta

This network variable outputs Drive cumulative power.

Cumulative power value = Previous cumulative power value + [Present output power data × (Present output power value acquire time – Previous output power value acquire time)]

Output Timing	Explanation
Event driven	Sent to network when data is changed.
nciSndHrtBt	When a send heartbeat time is set, the data is output within that time period.
nciMinOutTm	When a minimum output refresh time has been set, data that is changed during the specified time period is not output until that time period has elapsed.
nciEngyMinDelta	Output when changed outside of fixed change range.

**NOTICE:** Do not use this monitoring for accounting system etc as it is used to calculate the charges for power.

## 8 Network Variables

### ■ Drive Total Running Hours (Total Running Hours Monitoring)

Output	SNVT_time_hour nvoDrvRunHours
Data range	0 to 65,534 hours (Unit: 1 hour) The data is invalid when set to FFFF = 65,535 hours.
Service type	Default: Authentication type

This network variable outputs the Drive's accumulated running time.

Output Timing	Explanation
Event driven	Sent to the network when the data is changed by more than 1 hour.

### ■ Drive Fault Status (Drive Fault Monitoring)

Output	SNVT_switch nvoInvFault
Default	state = FF
Service type	Default: Authentication type

This network variable is used to monitor Drive fault status.

State	Value	Command
0	NA	Drive normal (after fault cleared)
1	NA	Drive fault occurring
FF (Default)	NA	Drive normal (from turning ON power until fault occurs)

Output Timing	Explanation
Event driven	Sent when fault occurs and when fault is cleared.

### ◆ Drive Alarm Status (Drive Alarm Monitoring)

Output	SNVT_switch nvoInvAlarm
Data range	state = FF
Service type	Default: Authentication type

This network variable is used to monitor Drive alarm status.

State	Value	Command
0	NA	Drive normal (after alarm cleared)
1	NA	Drive alarm occurring
FF (Default)	NA	Drive normal (from turning ON power until alarm occurs)

Output Timing	Explanation
Event driven	Sent when alarm occurs and when alarm is cleared.

### ■ Drive Parameter Read Data (Drive Constant Read Data)

Output	SNVT_count_inc nvoReadParamVal
Data range	-32,768 to 32,767
Default	0
Related network variables, configuration properties	nviReadParamNum, nviWriteParamNum, nviWriteParamVal

This network variable is used for setting and outputting data for constant numbers requested by nviReadParamNum.

Output Timing	Explanation
Event driven	The constant data is sent after normal reception of nviReadParamNum.

### ■ Drive Parameter Error (Drive Constant Access Error)

Output	SNVT_count nvoParamErr
Related network variables, configuration properties	nviReadParamNum, nviWriteParamNum, nviWriteParamVal

An error code is set at this network variable when inappropriate data is set for nviReadParamNum, nviWriteParamNum, or nviWriteParamVal, or when an Drive constant access-related error occurs.

Table 7 Error Codes

Error Code	Explanation
0 (00H)	Normal
2 (02H)	Invalid register number <ul style="list-style-type: none"> <li>An attempt was made to access a non-existent register number.</li> </ul>
33 (21H)	Data setting error <ul style="list-style-type: none"> <li>A simple upper limit or lower limit error has occurred in the control data or when writing constants.</li> <li>When writing constants, the constant setting was invalid.</li> </ul>
34 (22H)	Write mode error <ul style="list-style-type: none"> <li>An attempt was made to change a constant during operation.</li> <li>An attempt was made to write read-only data.</li> </ul>
35 (23H)	Writing during main circuit undervoltage (UV) error <ul style="list-style-type: none"> <li>An attempt was made to change a constant during a UV (main circuit undervoltage) alarm.</li> </ul>
36 (24H)	An attempt was made to change a constant while it was being processed at the Drive.
255 (FFH)	Command input time over <ul style="list-style-type: none"> <li>More than 30 seconds elapsed at the input interval for nvoWriteParamNum or nvoWriteParamVal.</li> </ul>

Output Timing	Explanation
Event driven	The constant data is sent after normal reception of nviReadParamNum.

### ■ Drive Speed Setpoint Feedback 1 (Drive Speed Reference Monitor 1)

Output	SNVT_lev_percent nvoSpdStptFb
Data range	0 to 163.830% (0.005%)
Service type	Default: Authentication type

This network variable sets and outputs speed reference values from the network.

Output Timing	Explanation
Event driven	The constant data is sent after normal reception of nviReadParamNum.

### ■ Drive Speed Setpoint Feedback 2 (Drive Speed Reference Monitor 2)

Output	SNVT_lev_percent nvoSpdCmd
Data range	0 to 163.835% (0.005%)
Service type	Default: Authentication type

This network variable sets and outputs speed reference values that are set for the Drive. It outputs reference values from the places that have frequency reference rights (i.e., external terminals, Operator, or communications).

Output Timing	Explanation
Event driven	The constant data is sent after normal reception of nviReadParamNum.

### ■ Drive Status (Drive Status Monitoring)

Output	SNVT_state nvoDrvStatus
Service type	Default: Authentication type

## 8 Network Variables

bit15	bit14	bit13	bit12	bit11	bit10	bit9	bit8	bit7	bit6	bit5	bit4	bit3	bit2	bit1	bit0	Status
																Running
																Zero speed
																Reverse operation
																Reset input in progress
																Matching speeds
																Drive ready
																Light fault
																Heavy fault
																oPE error
																Power interrupted/restored (1: Restored)
																Local/remote (1: Remote)
																Terminal M1, M2 output
																Terminal P1 output
																Terminal P2 output
																Motor selection (1: Second Motor)
																Zero-servo end

Output Timing	Explanation
Event driven	Sent when status is changed.

### ■ Drive Fault Status 1 (Drive Fault Status Monitor 1)

Output	SNVT_state nvoFltStatus1
Service type	Default: Authentication type

This network variable is used to output Drive fault status.

bit15	bit14	bit13	bit12	bit11	bit10	bit9	bit8	bit7	bit6	bit5	bit4	bit3	bit2	bit1	bit0	Display	Fault Contents
																$P_{UF}$	Blown fuse
																$U_{u1}$	Main circuit voltage low
																$U_{u2}$	Control power supply voltage low
																$U_{u3}$	MC fault
																-	Not used.
																$G_F$	Ground fault
																$aI$	Overcurrent
																$aU$	Overvoltage
																$aH$	Drive overheating
																$aH1$	Drive overheating
																$aL1$	Motor overload
																$aL2$	Drive overload
																$aL3$	Overtorque 1
																$aL4$	Overtorque 2
																$r_r$	Control transistor fault
																$r_h$	Control resistor overheating

Output Timing	Explanation
Event driven	Sent when any of the above faults occurs.

■ Drive Fault Status 2 (Drive Fault Status Monitor 2)

Output	SNVT_state nvoFltStatus2
Service type	Default: Authentication type

This network variable is used to output Drive fault status.

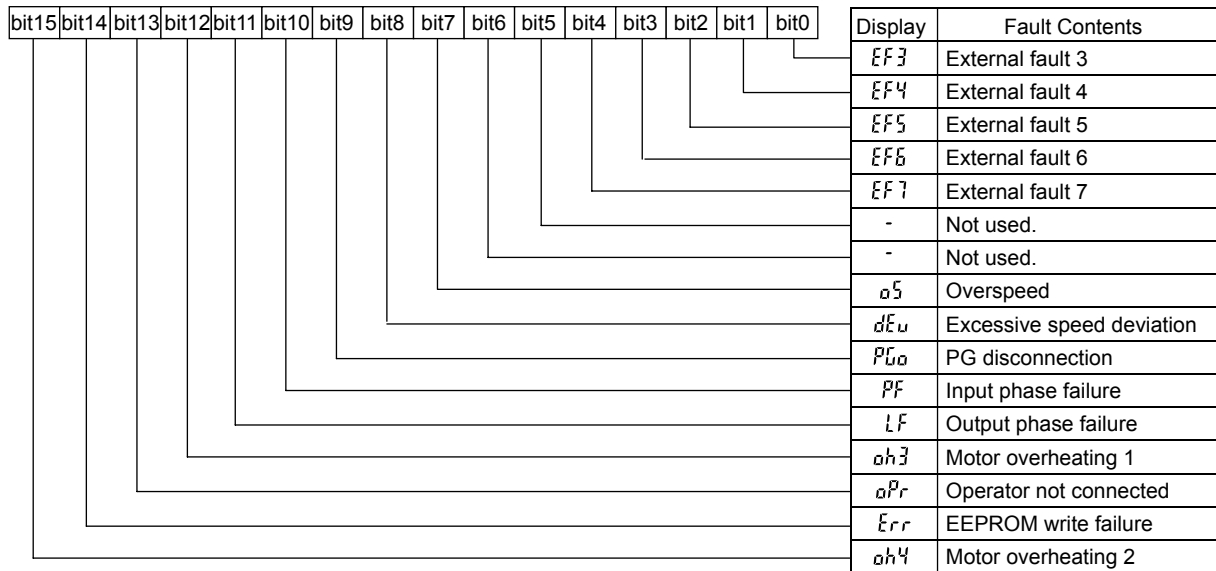

Output Timing	Explanation
Event driven	Sent when any of the above faults occurs.

## 8 Network Variables

### ■ Drive Fault Status 3 (Drive Fault Status Monitor 3)

Output	SNVT_state nvoFltStatus3
Service type	Default: Authentication type

This network variable is used to output Drive fault status.

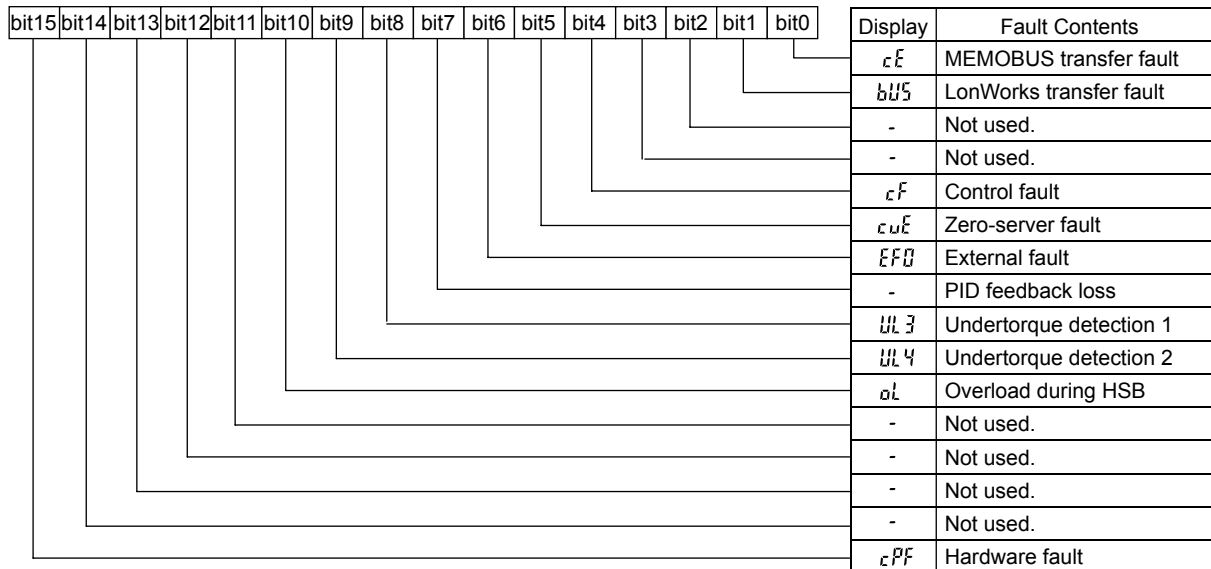

Output Timing	Explanation
Event driven	Sent when any of the above faults occurs.

### ■ Drive Emerg Status (Drive Emergency Stop Status)

Output	SNVT_hvac_emerg nvoEmergStatus
Default	State = FF
Service type	Default: Authentication type

This network variable monitors Drive run and stop status.

Data	Name	Explanation
0	EMERG_NORMAL	Normal
4	EMERG_SHUTDOWN	Emergency stop
FF (Default)	EMERG_NUL	-

Output Timing	Explanation
Event driven	Sent when any of the above heavy faults occurs.

## ◆ Setting Drive Constants from the Network

### ■ Reading Drive Constants

1. Set to nviReadParamNum, in hexadecimal, the register number of the Drive constant that is to be read.
2. When the nviReadParamNum data is refreshed, the Drive will set the data contents of the applicable Drive constant in nvoReadParamVal for output.
3. If invalid data is set in nviReadParamNum due to, for example, the register number for a non-existent Drive constant being specified, an error code will be set in nvoParamErr for output. [Refer to Drive Parameter Error \(Drive Constant Access Error\) on page 34.](#)

Example: Reading the Setting for b1-01 (Reference Selection)

#### Conditions

Frequency selection (b1-01): 180H

b1-01 setting: 3 (Communications)

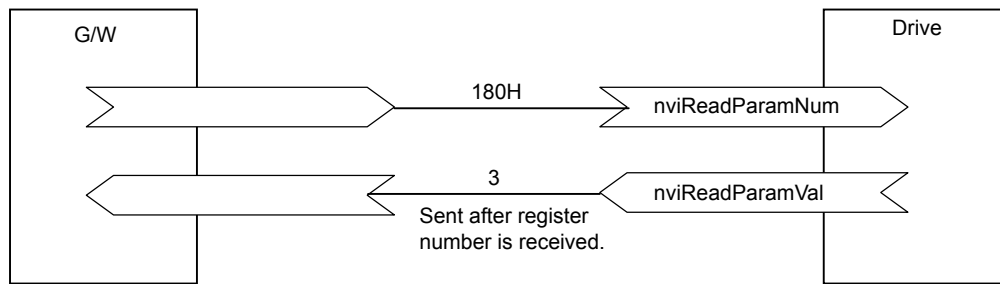

Use the MEMOBUS register number listed on the Drive instructions for the Drive constant.

## ■ Writing Drive Constants

1. Set to nviWriteParamNum, in hexadecimal, the register number of the Drive constant that is to be changed.
2. Enter the settings in nviWriteParamVal. (If the nviWriteParamVal data is not received within 30 seconds after the nviWriteParamNum data is received, the Drive will discard the nviWriteParamNum data.)
3. When the Drive receives nviWriteParamNum and nviWriteParamVal, it processes the Drive constant change. When the change is completed normally, the changed data is then set in nvoReadParamVal for output.
4. If the settings cannot be changed due to, for example, the register number for a non-existent Drive constant being specified, an error code will be set in nvoParamErr for output. **Refer to Drive Parameter Error (Drive Constant Access Error) on page 34.**

**NOTICE:** Sending data to nviWriteParamNum and nviWriteParamVal must be done in the order described in 1 and 2 above. If the order is reversed, the intended settings will not be made and unintended settings may be made instead.

Example: Changing the C1-01 (Ramp Up Time) Setting

Condition:

Ramp up time (C1-01): 200H

C1-01 setting: Changed from 10.0 s to 35.0 s.

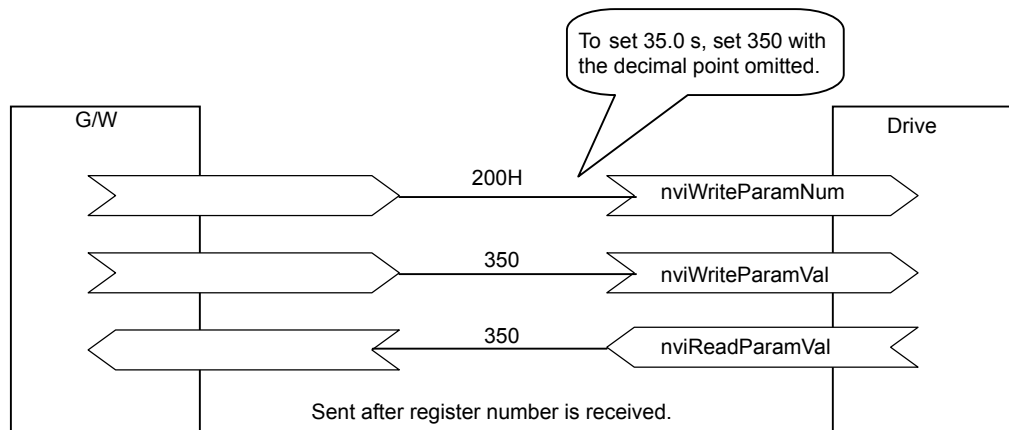

**Note:** Refer to Error Codes on page 35.

## 9 Drive Configuration Properties

### ◆ Drive Related Network Configuration Properties

Table 8

Name	Variable Type	Description
nciMaxSpeed	SNVT_lev_percent	Maximum Motor Speed
nciMinSpeed	SNVT_lev_percent	Minimum Motor Speed
nciSndHrtBt	SNVT_time_sec	Send Heartbeat Time
nciNmlSpeed	SNVT_rpm	Nominal Motor Speed in RPM (Motor Rated Rotation Frequency)
nciNmlFreq	SNVT_freq_hz	Nominal Motor Frequency (Motor Rated Frequency)
nciRampUpTm	SNVT_time_sec	Drive Ramp Up Time (Drive Acceleration Time)
nciRampDownTm	SNVT_time_sec	Minimum Ramp Down Time (Minimum Deceleration Time)
nciRcvHrtBt	SNVT_time_sec	Receive Heartbeat Time
nciMinOutTm	SNVT_time_sec	Minimum Send Time
nciLocation	SNVT_str_asc	Location Label
nciPwupOutTm	SNVT_time_sec	Power delay Timer
nciFreqMinDelta1	SNVT_lev_percent	Output Frequency Monitor Minimum Change Range Setting 1
nciFreqMinDelta2	SNVT_freq_hz	Output Frequency Monitor Minimum Change Range Setting 2
nciDrvSpeedScale	SNVT_lev_percent	nviDrvSpeedScale Default
nciInvSetFreq	SNVT_freq_hz	nviInvSetFreq Default
nciDrvSpeedRef	SNVT_lev_percent	nviDrvSpeedRef Default
nciDrvEngylimit	SNVT_elec_kwh_l	Cumulative Power Monitor Upper Limit: nciDrvEngylimit
nciEngyMinDelta	SNVT_elec_kwh_l	Cumulative Power Monitor Minimum Change Range Setting
nciOpMode	SNVT_count	Reference Selection Mode
nciDrvRunMode	SNVT_switch	Run Command Status Mode

#### ■ Maximum Motor Speed

Network input config	SNVT_lev_percent nciMaxSpeed
Setting range	0.000 to 110.000%
Default	100.000%
SCPT Reference	SCPTmaxSetpoint (50)

Set the motor frequency reference upper limit with the maximum output frequency (E1-04) taken as 100%. This value will be saved in Drive constant d2-01 (frequency reference upper limit). It will not be saved during operation.

Set the minimum speed and the maximum speed as follows:

$$0 \leq \text{minimum speed} \leq \text{maximum speed} \leq 110.000$$

#### ■ Minimum Motor Speed

Network input config	SNVT_lev_percent nciMinSpeed
Setting range	0 to 40.000%
Default	0%
SCPT Reference	SCPTminSetpoint (53)

Set the motor frequency reference lower limit with the maximum output frequency (E1-04) taken as 100%. This value will be saved in Drive constant d2-02 (frequency reference lower limit).

Set the minimum speed and the maximum speed as follows:

$$0 \leq \text{minimum speed} \leq \text{maximum speed} \leq 110.000$$



### ■ Send Heartbeat Time

Network input config	SNVT_time_sec nciSndHrtBt
Setting range	0.0 to 6,553.5 s (0.1 s) 6,553.5 s is handled as 0 s.
Default	0 (Invalid)
SCPT Reference	SCPTmaxSendTime (49)

Set the scheduled output time for the output network variable. When this setting is made, the monitor data is output in fixed cycles.

### ■ Nominal Motor Speed in RPM (Motor's Rated Rotation Frequency)

Network input config	SNVT_rpm nciNmlSpeed
Setting range	0 to 65,534 min-1 (1min-1)
Default	1800 min-1
SCPT Reference	SCPTnomRPM (158)

Set the motor's rated rotation frequency.

### ■ Nominal Motor Frequency (Motor's Rated Frequency)

Network input config	SNVT_freq_hz nciNmlFreq
Setting range	0 to 100 Hz (1 Hz)
Default	60 Hz
SCPT Reference	SCPTnomFreq (159)

Set the motor's rated frequency.

### ■ Drive Ramp Up Time (Drive Acceleration Time)

Network input config	SNVT_time_sec nciRampUpTm
Setting range	0.0 to 6,000.0 s (0.1 s)
Default	10.0 s
SCPT Reference	SCPTrampUpTm (160)

Set the motor ramp up time. This value is saved in the Drive constant C1-01.

### ■ Minimum Ramp Down Time (Minimum Deceleration Time)

Network input config	SNVT_time_sec nciRampDownTm
Setting range	0.0 to 6000.0 s (0.1 s)
Default	10.0 s
SCPT Reference	SCPTrampDownTm (161).14

Set the motor ramp down time. This value is saved in the Drive constant C1-02.

### ■ Receive Heartbeat Time

Network input config	SNVT_time_sec nciRcvHrtBt
Setting range	0.0 to 6,553.4 s (0.1 s) If the set value is 0, no communications error "bUS" is detected.
Default	0 (Invalid)
SCPT Reference	SCPTmaxRcvTime (48)

Set the maximum reception interval for nviDrvSpeedStpt. A communications error "bUS" will be displayed if data is not received within this set time period.

## 9 Drive Configuration Properties

### ■ Minimum Send Time

Network input config	SNVT_time_sec nciMinOutTm
Setting range	0.0 to 6,553.4 s (0.1 s) When the set value is 0, monitor data output is event driven.
Default	0.5 s
SCPT Reference	SCPTminSendTime (52)

Set the minimum output time for monitor data. The monitor data will be output after the set time has elapsed following a change to the data.

### ■ Location Label

Network input config	SNVT_str_asc nciLocation
Setting range	0 to 31 bytes
Default	\0 (Null)
SCPT Reference	SCPT_location (17)

Information regarding the physical position of a node can be set separately from the neuron ID (6 bytes).

### ■ Power Delay Timer

Network input config	SNVT_time_sec nciPwUpOutTm
Setting range	0 to 65534 (1 s)
Default	FFFF (Invalid)
SCPT Reference	SCPT_Pwrupdelay (72)

Set the delay time from when the power is turned ON until network variable output is started.

### ■ Output Frequency Monitor Minimum Change Range Setting 1

Network input config	SNVT_lev_percent nciFreqMinDelta1
Setting range	-163.840% to 163.830 (0.005%) If the set value is 7FFF, it is set as invalid data.
Default	0%
SCPT Reference	SCPTdefScale (162)

Set the minimum output change range for nvoDrvSpeed.

Set the value for when the power is turned ON.

### ■ Output Frequency Monitor Minimum Change Range Setting 2

Network input config	SNVT_freq_hz nciFreqMinDelta2
Setting range	0.0 to 400.0 (Hz) If the set value is 7FFF, it is set as invalid data.
Default	7FFF (Invalid)

Set the minimum output change range for nvoInvOutFreq.

### ■ nviDrvSpeedScale Default

Network input config	SNVT_lev_percent nciDrvSpeedScale
Setting range	-163.840% to 163.835 (0.005%) If the set value is 7FFF = +163.835%, it is set as invalid data.
Default	100.00%
SCPT Reference	SCPTdefScale (162)

Set the value for nviDrvSpeedScale for when the power is turned ON.

■ **nviInvSetFreq Default**

Network input config	SNVT_freq_hz nciInvSetFreq
Setting range	0.0 to 6553.5 (Hz) If the set value is FFFF, it is set as invalid data.
Default	3276.7 (7FFF)FFFF (Invalid)
SCPT Reference	SCPTdefScale (162)

Set the value for nviInvSetFreq for when the power is turned ON.

■ **nviDrvSpeedRef Default**

Network input config	SNVT_lev_percent nciDrvSpeedRef
Setting range	-163.840% to 163.835 (0.005%) If the set value is 7FFF = +163.835%, it is set as invalid data.
Default	7FFF (Invalid)

Set the value for nviDrvSpeedRef for when the power is turned ON.

■ **Cumulative Power Monitor Upper Limit**

Network input config	SNVT_elec_kwh_l nciDrvEngylimit
Setting range	-214,748,364.8 to 214,748,364.6 kwh
Invalid value	0x7FFFFFFF (214,748,364.7) If the set value is invalid, the nvoDrvEnergy value accumulates until the maximum value. If the set value is for less than 0, it is treated as 0 and the cumulative power value does not accumulate.
Default	0x7FFFFFFF (214,748,364.7) (Invalid)

Set the cumulative power monitor (nvoDrvEnergy) upper limit. When the cumulative power monitor value exceeds this set value, the accumulation will start over from 0. (Example: If the set value is 1,000.0, the next number after 999.9 will be 0.)

■ **Cumulative Power Monitor Minimum Change Range Setting**

Network input config	SNVT_elec_kwh_l nciEngyMinDelta
Setting range	-214,748,364.8 to 214,748,364.6 kwh
Valid range	0.1 to 214,748,364.6 No value greater than nvoDrvEngylimit can be set. If nciDrvEngylimit nciEngyMinDelta, the data will be ignored and the set value will not be changed.
Default	Invalid value

Set the minimum change range for the output from the cumulative power monitor (nvoDrvEnergy).

■ **Reference Selection Mode**

Network input config	SNVT_count nciOpMode
----------------------	----------------------

Run command and frequency reference rights can be selected and switched from the network. The selection can be changed as shown below by setting nciOpMode (default: 0) from 0 to 3.

nciOpMode Set Value	0(Default)	1	2	3
Reference selection	b1-01 set value	Communications	b1-01 set value	Communications
Operation method selection	b1-02 set value	b1-02 set value	Communications	Communications

## 9 Drive Configuration Properties

### ■ Run Command Status Mode

Network input config	SNVT_switch nciDrvRunMode
Default	State = 0 x FF

If the Drive is stopped during operation for some reason other than a stop command from the network, determine whether the run command is to be forced OFF in the SI-W3 from communications or whether the run command status is to be held as is.

State	Value	Command
0	NA	Status hold
1	NA	OFF
FF (Default)	NA	Status hold

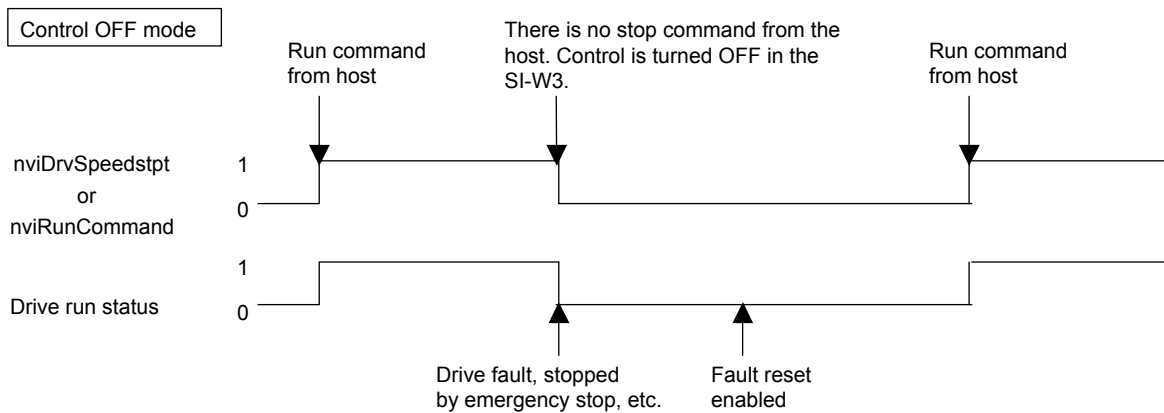
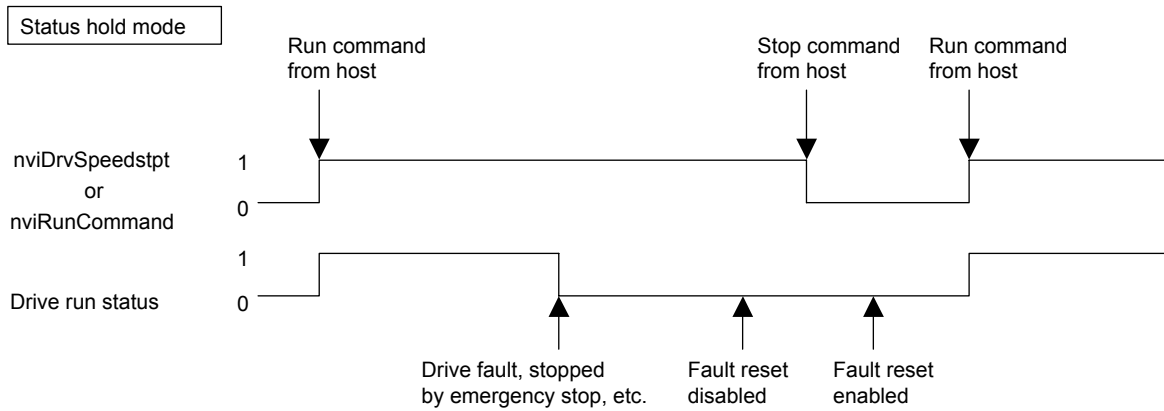

## 10 Troubleshooting

### ◆ Drive-Side Error Codes

Drive-side error codes appear on the bypass digital operator. Causes of the errors and corrective actions are listed below. Refer to the drive manual for additional error codes that may appear on the bypass digital operator.

#### ■ Faults

Both FB12 (option communication fault) and EF0 (option external fault) can appear as a fault. When a fault occurs, the digital operator ALM LED remains lit. When an alarm occurs, the ALM LED flashes.

If communication stops while the drive is running, use the following questions as a guide to help remedy the fault:

- Is the option properly installed?
- Are the communication lines properly connected to the option? Are the wires loose?
- Is the controller program working? Has the controller/PLC CPU stopped?
- Did a momentary power loss interrupt communications?

Digital Operator Display		Fault Name
<i>EF0</i>	EF0	Option Card External Fault
Cause		Possible Solutions
An external fault was received from the PLC and F6-03 is set to a value other than 3.		<ul style="list-style-type: none"> <li>• Remove the cause of the external fault.</li> <li>• Remove the external fault input from the PLC.</li> </ul>

Digital Operator Display		Fault Name
<i>Fb12</i>	Fb12	Option Communication Error
Cause		Possible Solution
Master controller (PLC) has stopped communicating		<ul style="list-style-type: none"> <li>• Check that power is supplied to the PLC</li> <li>• Check that PLC is not in program mode</li> </ul>
Communication cable is not connected properly		<ul style="list-style-type: none"> <li>• Check for faulty wiring</li> <li>• Correct any wiring problems</li> </ul>
A data error occurred due to noise		<ul style="list-style-type: none"> <li>• Check the various options available to minimize the effects of noise</li> <li>• Counteract noise in the control circuit, main circuit, and ground wiring</li> <li>• If a magnetic contactor is identified as a source of noise, install a surge absorber to the contactor coil</li> <li>• Make sure the cable used meets requirements</li> <li>• Make sure the option ground wire is connected between option FE terminal and the drive ground terminal connected to earth ground</li> </ul>
The option is not properly connected to the drive.		Reinstall the option.
Option is damaged		If there are no problems with the wiring and the error continues to occur, replace the option.
Duplicate IP Address		Check if the option shares IP Address with at least one other node. Check the setting values of F7-01 to F7-04 (IP Address).

### ■ Minor Faults and Alarms

Digital Operator Display		Minor Fault Name	
[4P <sub>0</sub> ]	CyPo	Cycle Power to Active Parameters	
		Comm. Option Parameter Not Upgraded	
Cause		Possible Solutions	Minor Fault (H2-□□ = 10)
Drive is not compatible with the option software version.		Turn off the power and upgrade the communication option parameters. <b>Note:</b> An alarm is triggered when the option software version is earlier or an incompatible option is installed to the drive.	YES

# 11 Function Modules

## ◆ Functions

The the functions described in this section require digital operator model JVOP-182. HOA Keypad model JVOP-183 is not compatible.

Do not turn off the power to the bypass for at least 10 seconds after setting the functions with the digital operator. Initialize the bind data when EEP error occurs.

## ◆ Connection of Digital Operator

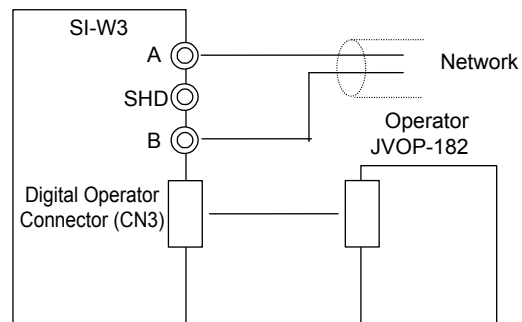

**Figure 17 Digital Operator Connection Diagram**

◆ Digital Operator Display

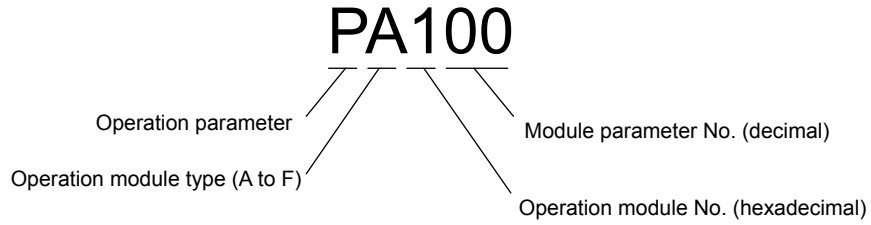



Digital Operator Display		Description
<i>onLn</i>	onLn	Option card in online status
<i>oFFLn</i>	oFFLn	Option card in offline status
<i>UnCFG</i>	UnCFG	Network in unconfigured status
<i>CALL</i>	CALL	Option card in standby status for communications
<i>CPF88</i>	CPF88	Option card in error status
<i>bUS</i>	bUS	Option card in communications error status
<i>EEP</i>	EEP	EEPROM error

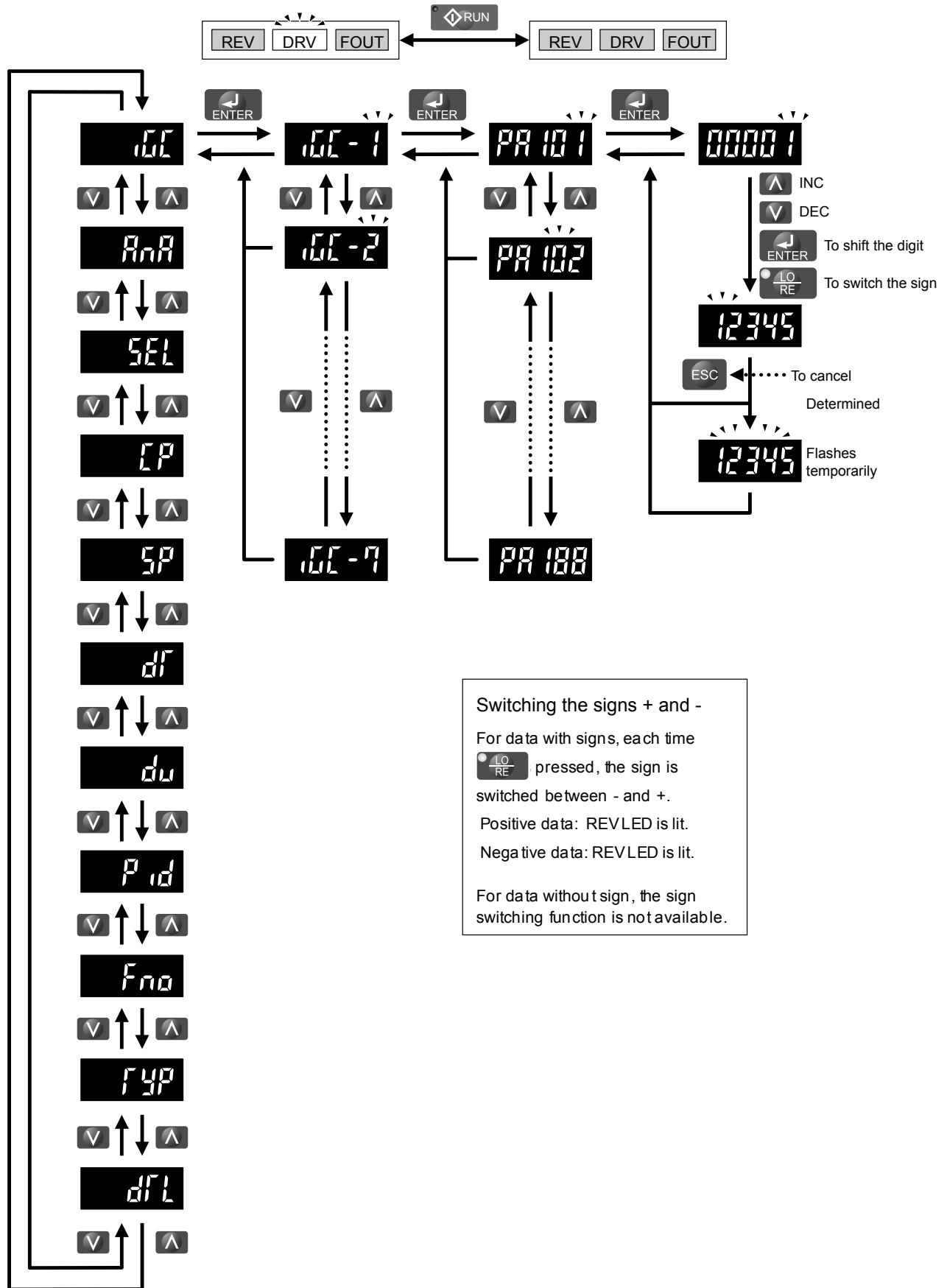

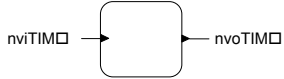
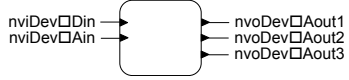
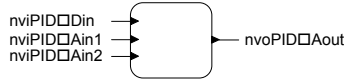

## ◆ List of Functions

Name	Display	Parameter	Function Image	Explanation	Default	Register Number
Logic Operation	LgC-□□: 0 to 7 No. of modules: 8	PA000 to PA100		<p>The following operation modes can be selected by setting PA□□00.</p> <ul style="list-style-type: none"> <li>• 0: AND</li> <li>• 1: OR</li> <li>• 2: Inversion (INV)</li> <li>• 3: Reverse</li> </ul>	1	1001H to 1008H
Analog Operation	ANA-□□: 0 to 9 No. of modules: 10	PB000 to PB928		<p>The following operation modes can be selected by setting PB□□02.</p> <ul style="list-style-type: none"> <li>• 0: Ratio/Bias (R/B)</li> <li>• 1: Analog scheduler (ANA/ SCH)</li> <li>• 2: Variation ratio limiter (LIM)</li> <li>• 3: Primary delay filter (FIL)</li> </ul>	1	1110H to 1209H
Selection Operation	SEL-□□: 0 to 7 No. of modules: 8	PC000 to PC701		<p>The following operation modes can be selected by setting PC□□01.</p> <ul style="list-style-type: none"> <li>• 0: State data based select (SEL) The data of either nviSEL□Ain1 or nviSEL□Ain2 is output according to the state data of SEL□Din.</li> <li>• 1: High select (Hi) The larger of two values is output.</li> <li>• 2: Low select (Lo) The smaller of two values is output.</li> </ul>	1	120AH to 1219H
Comparison Operation	Cp-□□: 0 to 7 No. of modules: 8	Pd000 to Pd702		<p>The following operation modes can be selected by setting Pd□□01.</p> <ul style="list-style-type: none"> <li>• 0: Forward operation The output turns ON when <math>nviCMP□Ain1 \geq nviCMP□Ain2</math>.</li> <li>• 1: Reversed operation The output turns ON when <math>nviCMP□Ain1 \leq nviCMP□Ain2</math>.</li> </ul>	0	121AH to 1231H
Step Output Operation	SP-□□: 0 No. of modules: 1	PE000 to PE018		<p>The following operation modes can be selected by setting PE□□01.</p> <ul style="list-style-type: none"> <li>• 0: First In Last Out (FILO) The outputs nvoStep□Dout1 through 4 turn ON or OFF according to the value of nviStep□Ain in FILO order.</li> <li>• 1: First In First Out (FIFO) The output nvoStep□Dout1 through 4 turn ON or OFF according to the value of nviStep□Ain in FIFO order.</li> </ul>	0	1232H to 123CH

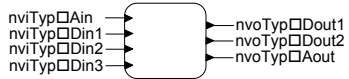
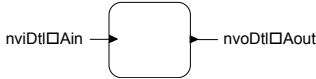
Name	Display	Parameter	Function Image	Explanation	Default	Register Number
Delay Timer	dt-□□: 0 and 1 No. of modules: 2	PF000 to PF104		The following operation modes can be selected by setting PE□00. <ul style="list-style-type: none"> <li>• 0: ON delay The output nvoTIM□ turns ON when the set time period has passed after the input nviTIM□ turned ON.</li> <li>• 1: OFF delay The output nvoTIM□ turns OFF when the set time period has passed after the input nviTIM□ turned OFF.</li> </ul>	0	123DH to 1244H
Deviation Output Operation	dv-□□: 0 No. of modules: 1	PG000 to PG013		The following operation modes can be selected by setting PG□01. <ul style="list-style-type: none"> <li>• 0: Outputs with 3 deviations Three data with the bias set in the data of nviDev□Ain are output.</li> <li>• 1: Outputs with 2 deviations Two data with the bias set in the data of nviDev□Ain are output.</li> </ul>	0	1245H to 124AH
PID	pid-□□: 0 to 3 No. of modules: 4	Ph000 to Ph305		The following operation modes can be selected by setting PH□01. <ul style="list-style-type: none"> <li>• 0: Forward operation PI control on forward operation using the input feedback nviPID□Ain1.</li> <li>• 1: Reverse operation PI control on reversed operation using the input feedback nviPID□Ain1.</li> </ul>	0	124BH to 1266H
Constant Output	fno-□□: 0 to 5 No. of modules: 6	PJ000 to PJ501		The data set in the parameter PJ□01 is output.	0	1267H to 1272H
Variable Type Conversion	typ-□□: 0 to 3 No. of modules: 4	PL000 to PL320		The following operation modes can be selected by setting PL□02. <ul style="list-style-type: none"> <li>• 0: ANA → ANA</li> <li>• 1: ANA → DIG</li> <li>• 2: DIG → ANA</li> </ul>	0	1273H to 12BAH
Save Data	dtl-□□: 0 to 3 No. of modules: 4	Po000 to Po300		The data is saved in EEPROM when inputting data. The saved data will not be cleared whenever the power turns OFF.	0	12BBH to 12BEH

■ Items Common to Functions

Sending Data

- Each Function Module outputs a response data according to its own function using an output network variable after receiving an input network variable.
- The output method of output network variables for each module can be changed using the common configuration properties nciAoutMinOutTm and nciAoutSendHrtBt, and the minDelta prepared at each module.

Configuration Properties Common to All Function Modules

Configuration Property	Explanation	Applicable NVs
nciAoutMinOutTm	Sets a minimum output time of analog data. Analog data is output after the set time period has passed following a change in the data.	ANA data of each Function
nciAoutSendHrtBt	Sets a cycle time to output an analog data. Analog data is output in the set cycle time.	ANA data of each Function
nciDoutSendHrtBt	Sets a cycle time to output the output network variables whose variable type is SNVT_switch. DIG data is output in the set cycle time.	DIG data of each Function

## 11 Function Modules

### Configuration Properties for Each Function Module

Configuration Property	Explanation	Applicable NVs
nciPID0MinDelta to nciPID3MinDelta	Sets an minimum delta of analog data.	PID Function

### ◆ Logic Operation Function

#### ■ Function Block Image

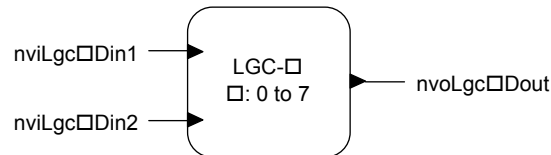

Number of modules: 8 (0 to 7)

#### ■ Network Variables and Parameters

The Logic Operation Function is used to carry out an operation in a number of stages according to the amount of data stored in the input network variable and saves the result in the network variable.

##### Network Variables

Network Variable	Variable Type	Type Change	Name and Function
nviLgc□Din1	SNVT_switch	Impossible	DIG input 1
nviLgc□Din2	SNVT_switch	Impossible	DIG input 2
nvoLgc□Dout	SNVT_switch	Impossible	DIG output Outputs the result of logic operation. When ON: state = 1, value = 100.0 When OFF: state = 0, value = 0.0

##### Parameter

Parameter	Name	Explanation	Default
PA000 to PA700	Operation mode selection	0: AND 1: OR 2: Inversion (INV) 3: Non-equivalence (EQ)	1

#### ■ Operation

The Logic Operation Function has four operation modes. Select a mode by setting the parameter PA□01.

The table below shows the output conditions of each operation mode.

Operation	Set Value in PA□01	Input				Output	
		nviLgc□Din1 (SNVT_switch)		nviLgc□Din2 (SNVT_switch)		nvoLgc□Dout (SNVT_switch)	
		value	state	value	state	value	state
AND	0	NA	1	NA	1	100	1
		NA	1	NA	0 or -1	0	0
		NA	0 or -1	NA	1	0	0
		NA	0 or -1	NA	0 or -1	0	0
OR	1	NA	1	NA	1	100	1
		NA	1	NA	0 or -1	100	1
		NA	0 or -1	NA	1	100	1
		NA	0 or -1	NA	0 or -1	0	0

Operation	Set Value in PA□01	Input				Output	
		nviLgc□Din1 (SNVT_switch)		nviLgc□Din2 (SNVT_switch)		nviLgc□Dout (SNVT_switch)	
		value	state	value	state	value	state
Reverse	2	NA	1	NA	1	100	1
		NA	1	NA	0	0	0
		NA	0	NA	1	0	0
		NA	0	NA	0	100	1
		NA	-1	NA	-1	0	0
Inversion (INV)	3	NA	1	-	-	0	0
		NA	0	-	-	100	1
		NA	-1	-	-	0	0

**Note:** □: Indicates the module number 0 to 7.

Data is sent in event-driven timing. Data is sent when the state changes.

Any modification of the parameter settings is immediately reflected in the operation results in the output network variable.

## ◆ Analog Operation Function

### ■ Function Image



Number of modules: 10 (0 to 9)

### ■ Network Variables and Parameters

The Analog Operation Function is used to carry out an operation in a number of stages or steps according to the amount of data stored in the input network variable and saves the result in the output network variable.

#### Network Variables

Network Variable	Variable Type	Type Change	Function
nviP□Ain	SNVT_lev_percent	Possible	Executes the operation on the base of the data set in this variable according to the operation mode.
nvoP□Aout	SNVT_lev_percent	Possible	Outputs the operation result.

#### Parameters

Parameter	Name	Explanation	Default
Pb□00	Variable type	Indicates the variable type of nviP□Ain. Cannot be set from the digital operator.	0
Pb□01	Variable type	Indicates the variable type of nvoP□Aout. Cannot be set from the digital operator.	0
Pb□02	Operation mode selection	0: Ratio/Bias 1: Scheduler 2: Variation ratio limit 3: Primary delay filter	1
Pb□03	Output cycle	Operation output cycle of nvoP□Aout	1.0 s
Pb□04	Variation ratio limit value	Limits the variation of nvoP□Aout.	0
Pb□05	Delay time	Used for operation with primary delay filter.	0
Pb□06	Operation after initialization	0: Calculates as the previous output was 0. 1: Outputs the input value as it is.	0
Pb□07	Ratio	Sets a inclination when Pb□02 = 0.	1.0
Pb□08	Bias	Sets the bias when Pbo□2 = 0.	0

## 11 Function Modules

Parameter	Name	Explanation	Default
Pb□11	Reference point 1X coordinates	Sets the coordinate value x (input).	0
Pb□12	Reference point 2X coordinates	Sets the coordinate value x (input).	0
Pb□13	Reference point 3X coordinates	Sets the coordinate value x (input).	0
Pb□14	Reference point 4X coordinates	Sets the coordinate value x (input).	0
Pb□15	Reference point 5X coordinates	Sets the coordinate value x (input).	0
Pb□16	Reference point 6X coordinates	Sets the coordinate value x (input).	0
Pb□17	Reference point 7X coordinates	Sets the coordinate value x (input).	0
Pb□18	Reference point 8X coordinates	Sets the coordinate value x (input).	0
Pb□21	Reference point 1Y coordinates	Sets the coordinate value y (input).	0
Pb□22	Reference point 2Y coordinates	Sets the coordinate value y (input).	0
Pb□23	Reference point 3Y coordinates	Sets the coordinate value y (input).	0
Pb□24	Reference point 4Y coordinates	Sets the coordinate value y (input).	0
Pb□25	Reference point 5Y coordinates	Sets the coordinate value y (input).	0
Pb□26	Reference point 6Y coordinates	Sets the coordinate value y (input).	0
Pb□27	Reference point 7Y coordinates	Sets the coordinate value y (input).	0
Pb□28	Reference point 8Y coordinates	Sets the coordinate value y (input).	0

## ■ Operation

The Analog Operation Function has four operation modes that can be selected by setting parameter Pb□02.

The table below shows the output conditions of each operation mode.

Operation Function	Related Parameters	Explanation	Setting
Ratio/Bias	Pb□02	Operation mode selection	0
	Pb□07	Ratio	-3276.8 to 3276.7
	Pb□08	Bias	<1>
Analog Scheduler	Pb□02	Operation mode selection	1
	Pb□11 to □18	Coordinate value x (input)	<1>
	Pb□21 to □28	Coordinate value y (output)	<1>
Variation Ratio Limiter	Pbo□2	Operation mode selection	2
	Pb□03	Output cycle	0.1 to 60.0 s
	Pb□04	Variation ratio limit value	<1>
	Pb□06	Operation after initialization	0 or 1
Primary Delay Filter	Pb□02	Operation mode selection	3
	Pb□03	Output cycle	0.1 to 60.0 s
	Pb□05	Delay time	0 to 65534 s
	Pb□06	Operation after initialization	0 or 1

<1> Depends on variable types.

### Sending Data

The data are sent in event-driven timing or using nciAoutSndHrtBt and nciMinSendTim.

### Ratio/Bias

The data in the input network variable is calculated using the following equation, and the result is sent to the output network variable.

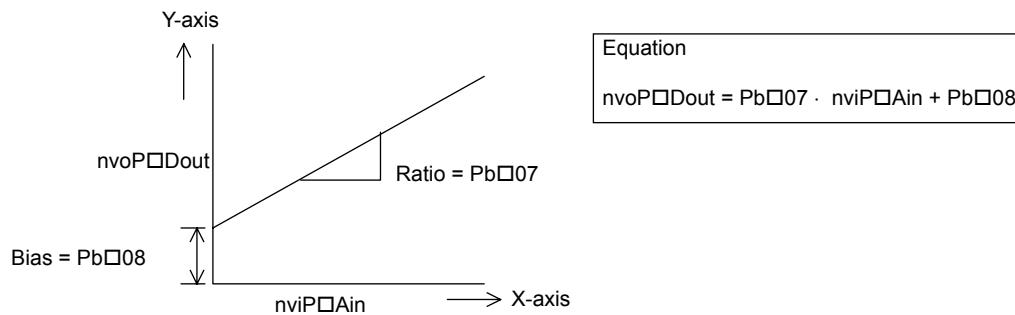

### Analog Scheduler

The analog data of input network variable are compensated using a line graph shown below, and the compensated result is sent to the output network variable.

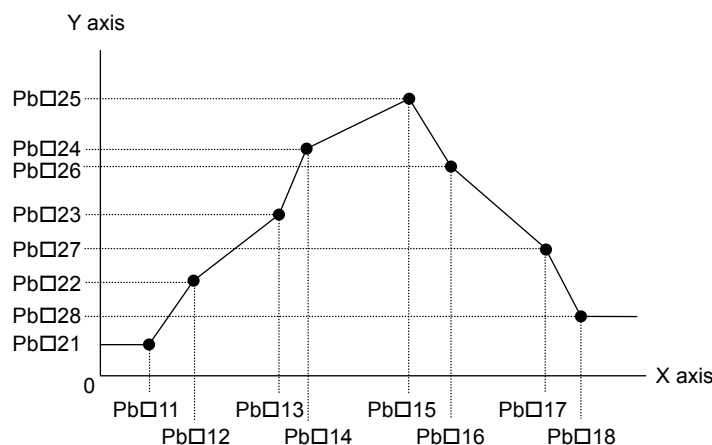

## 11 Function Modules

- Be sure to set the analog input data parameters Pb□11 to Pb□18 in ascending order.
- If any of the parameters Pb□11 to Pb□18 are not set in ascending order, only the setting values of the parameters set in ascending order become valid and the others become invalid. Also at that time, the result from the nvoP□Aout are output and used with the values for the Y-axis set values in correspondence to the parameter set value set in ascending order.

Example: When Pb□13 > Pb□14, the line graph becomes as shown below. The set values of the parameters Pb□14 downward are invalid, and the set value of Pb□13 is used for operation.

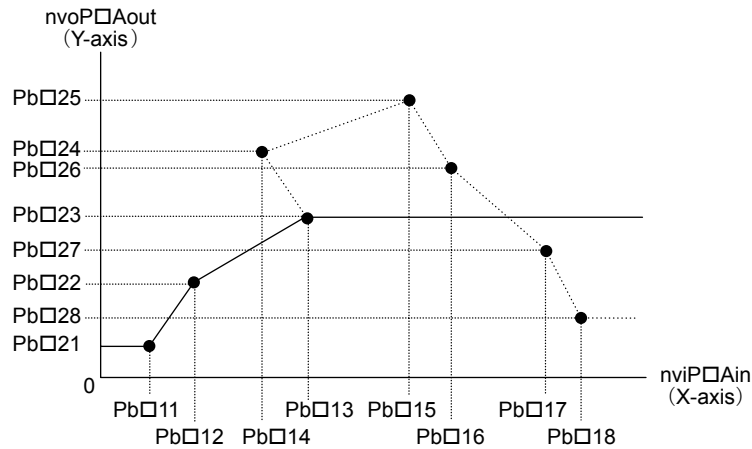

- Note:**
1. For the value of nviP□Ain, the value of nvoP□Aout shown with a solid line is output.
  2. As the parameter Pb□14 was set out of ascending order, the set values of parameters Pb□14 to Pb□18 and Pb□24 to Pb□28 become invalid.

If the value of nviP□Ain is bigger than that of Pb□13 in this case,  $nvoP□Aout = Pb□23$ .

- When the parameters Pb□14 to Pb□18 are set in ascending order:

If  $nviP□Ain < Pb□11$ ,  $nvoP□Aout = Pb□21$

If  $nviP□Ain > Pb□18$ ,  $nvoP□Aout = Pb□28$

### Variation Ratio Limiter

The output variation ratio limit is executed on the analog data of input network variable as shown below, and the result is sent to the output network variable.

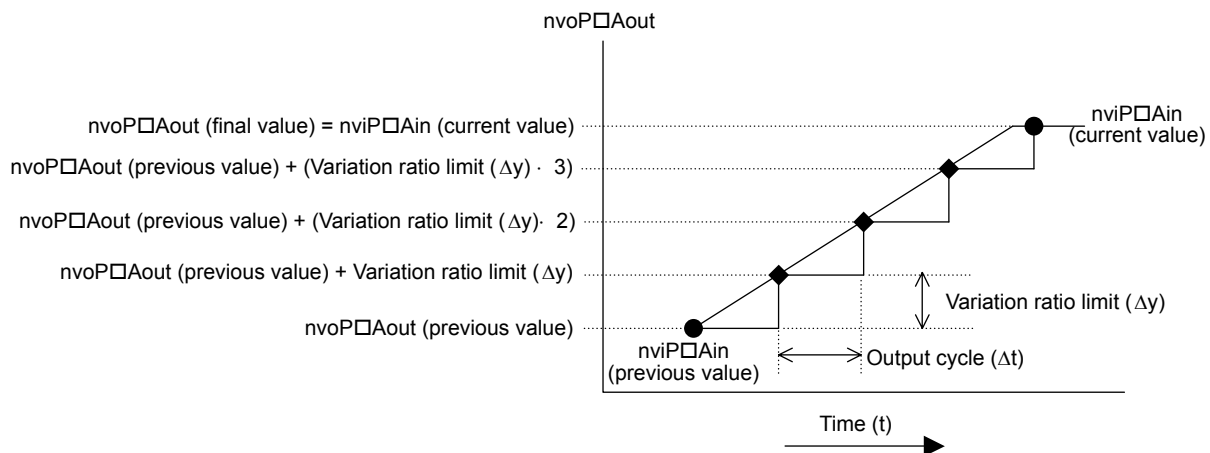

When the value of nviP□Ain changes from nviP□Ain (previous value) to nviP□Ain (current value), the variation ratio limit value is added to the value of nvoP□Aout every output cycle so that the final value of nvoP□Aout is equal to the current value of nviP□Ain.

Example: nvoP□Aout data process when the value of nvoP□Ain changes from 30.000 to 65.000

Input and output network variable type: lev\_percent

Parameter settings: As shown in the table below



Parameter	Explanation	Setting
Pb□02	Operation mode selection	2
Pb□03	Output cycle	1.5 s
Pb□04	Variation ratio limit value	10

After the value of nviP□Ain has changed from 30.000 to 65.000, the value of nvoP□Aout becomes equal to the value of nviP□Ain in six seconds.

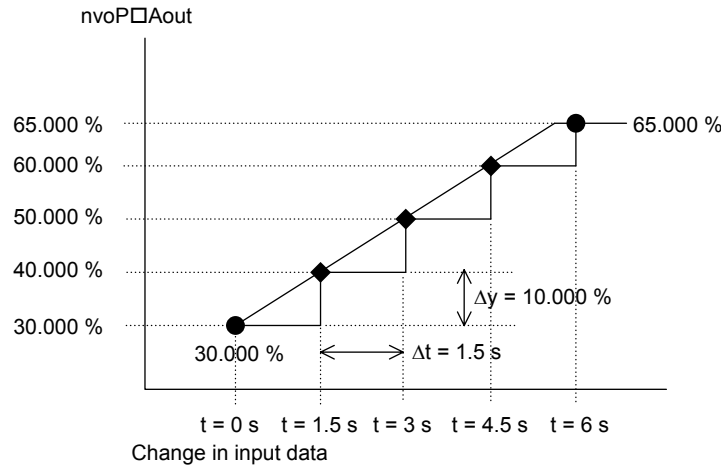

**Primary Delay Filter**

The data of input network variable is calculated using the equation below, and the result is sent to the output network variable.

$$nvoP□Aout(t) = nvoP□Aout(t-1) + Ts / (Ts + TL) \times (nviP□Ain - nvoP□Aout(t-1))$$

- nvoP□Aout(t): Current output value
- nvoP□Aout(t-1): Previous output value
- nviP□Ain: Input value
- Ts: Output cycle (Pb□03)
- TL: Delay time (Pb□05)
- When  $Ts > TL$ , it is judged as  $Ts = TL$ .

**◆ Select Operation Function**

**■ Function Image**



Number of modules: 8 (0 to 7)

**■ Network Variables and Parameters**

The Select Operation Function has three operation modes to be selected by setting the parameter PC□01.

**Network Variables**

Network Variable	Variable Type	Type Change	Name and Function
nviSEL□Din	SNVT_switch	Impossible	Executes the operation on the base of the data in this parameter according to the operation mode.
nviSEL□Ain1	SNVT_lev_percent	Possible	Input data 1
nviSEL□Ain2	SNVT_lev_percent	Possible	Input data 2

## 11 Function Modules

Network Variable	Variable Type	Type Change	Name and Function
nvoSEL□Aout	SNVT_lev_percent	Possible	Outputs the selected data.

### Parameters

Parameter	Name	Explanation	Default
PC□00	Variable type	Indicates the variable type of nviSELoAin1 and 2. It is not possible to set this parameter using the digital operator.	0
PC□01	Operation setting	0: State data based select 1: Hi select (Hi) 2: Lo select (Lo)	1

### ■ Operation

The Select Operation Function has three operation modes to be selected by setting the parameter PC□01.

The table below shows the input conditions of each operation mode.

Function	PC□01 Setting	Input Condition		Output Data nvoSEL□Aout
State Data Based Select	0	nviSEL□Din (SNVT_switch)		-
		value	state	
		NA	1	
		NA	0	
Hi Select	1	nviSEL□Ain1 ≥ nviSEL□Ain2		nviSEL□Ain1
		nviSEL□Ain1 < nviSEL□Ain2		nviSEL□Ain2
Lo Select	2	nviSEL□Ain1 < nviSEL□Ain2		nviSEL□Ain1
		nviSEL□Ain1 ≥ nviSEL□Ain2		nviSELo□Ain2

#### State Data Based Select

The data of either the input network variable nviSEL□Ain1 or nviSEL□Ain2 is selected according to the state data of nviSEL□Din, and the data of the selected input network variable is sent to the output network variable nvoSEL□Aout.

When nviSEL□Din (STATE) = 0, nvoSEL□Aout = nviSEL□Ain1

When nviSEL□Din (STATE) = 1, nvoSEL□Aout = nviSEL□Ain2

When nviSEL□Din (STATE) = -1, nvoSEL□Aout = nviSEL□Ain1

#### Hi Select

The two data of the input network variables nviSEL□Ain1 and nviSEL□Ain2 are compared, and the data of the bigger value is output to the output network variable nvoSEL□Aout.

The input network variable nviSEL□Din is not used.

#### Lo Select

The two data of the input network variables nviSEL□Ain1 and nviSEL□Ain2 are compared, and the data of the smaller value is sent to the output network variable nvoSEL□Aout.

The input network variable nviSEL□Din is not used.

## ◆ Comparison Operation Function

### ■ Function Image

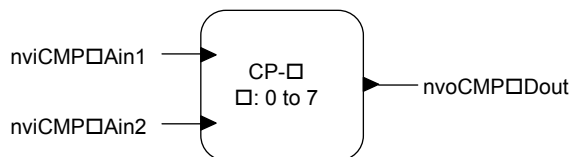

Number of modules: 8 (0 to 7)

## Network Variables and Parameters

The two data of the input network variable nviCMP□Ain2 is compared with that of nviCMP□Ain1. The result is sent to the output network variable according to the forward and the reverse operation.

### Network Variables

Network Variable	Variable Type	Type Change	Name and Function
nviCMP□Ain1	SNVT_lev_percent	Possible	Base data for comparison
nviCMP□Ain2	SNVT_lev_percent	Possible	Data to compare
nvoCMP□Dout	SNVT_switch	Impossible	Outputs according to the operation mode.

### Parameters

Parameter	Name	Explanation	Default
Pd□00	Variable type	Indicates the variable type of nviCMP□Ain1 and nviCMP□Ain2. It is not possible to set this parameter using the digital operator.	0
Pd□01	Operation mode selection	0: Forward operation 1: Reverse operation	0
Pd□02	Hysteresis	Sets the hysteresis of output variation	0

## Operation

### Forward Operation

When the value of nviCMP□Ain2 is greater than that of nviCMP□Ain1, then nvoCMP□Dout (STATE) = 1 (ON).

When the value of nviCMP□Ain2 is less than the value “nviCMP□Ain1 – Pb□02”, nvoCMP□Dout (STATE) = 0 (OFF).

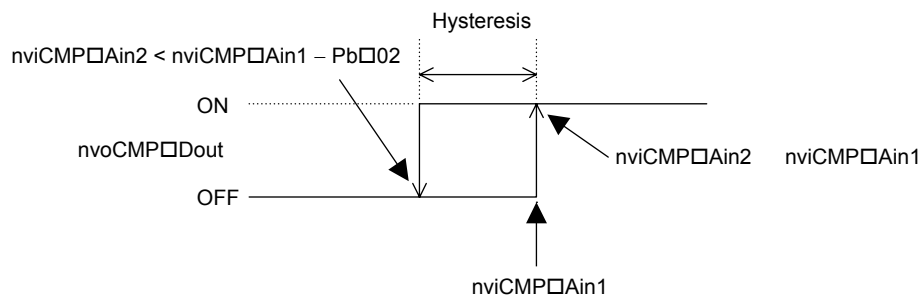

### Reverse Operation

When the value of nviCMP□Ain2 is less than the value of nviCMP□Ain1, nvoCMP□Dout (STATE) = 1 (ON).

When the value of nviCMP□Ain2 is greater than the value “nviCMP□Ain1 + Pb□02”, nvoCMP□Dout (STATE) = 0 (OFF).

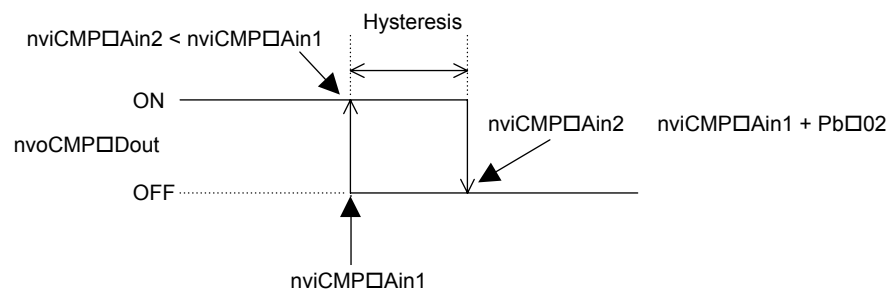

## Step Output Operation Function

### Function Image

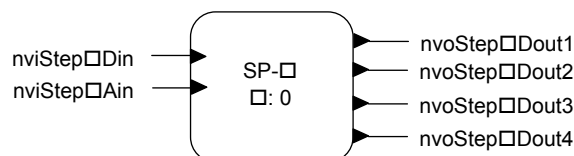

Number of modules: 1 (0)

### ■ Network Variables and Parameters

The Step Output Operation Function is used to carry out an operation in a number of stages according to the amount of data stored in the input network variable and saves the result in the output network variable.

#### Network Variables

Network Variable	Variable Type	Type Change	Name and Function
nviSTEP□Din	SNVT_switch	Impossible	Output interlock state = 0, -1: Interlock state = 1: Release interlock
nviSTEP□Ain	SNVT_lev_percent	Possible	Input data Compares with the reference value, and outputs in order.
nvoSTEP□Dout1	SNVT_switch	Impossible	Step output 1 When ON: state = 1, value = 100.0 When OFF: state = 0, value = 0.0
nvoSTEP□Dout2	SNVT_switch	Impossible	Step output 2 When ON: state = 1, value = 100.0 When OFF: state = 0, value = 0.0
nvoSTEP□Dout3	SNVT_switch	Impossible	Step output 3 When ON: state = 1, value = 100.0 When OFF: state = 0, value = 0.0
nvoSTEP□Dout4	SNVT_switch	Impossible	Step output 4 When ON: state = 1, value = 100.0 When OFF: state = 0, value = 0.0

#### Parameters

Parameter	Name	Explanation	Default
PE□00	Variable type	It is not possible to change this parameter using the digital operator.	0
PE□01	Operation mode selection	0: FILO (First In Last Out, 1: FIFO (First In First Out)	0
PE□02	Hysteresis	Sets the hysteresis to the reference point to turn OFF the output signal.	0
PE□11	STEP 1 reference value	The reference value to turn ON the output signal.	0
PE□12	STEP 2 reference value	The reference value to turn ON the output signal.	0
PE□13	STEP 3 reference value	The reference value to turn ON the output signal.	0
PE□14	STEP 4 reference value	The reference value to turn ON the output signal.	0
PE□15	Timer to increment/decrement the number of ON outputs	When the value of nviSTEP□Ain is greater than the reference value or less than the value "Reference value - Hysteresis value," the timer starts counting and the number of ON outputs increases or decreases by 1 after the set time. (If the value of nviSTEP□Ain does not satisfy the conditions needed to start the timer, the timer is reset.)	10
PE□16	Timer after the output turned ON	The value of nviSTEP□Ain is discarded within this set time after the output has turned ON.	60
PE□17	Timer after the output turned OFF	The value of nviSTEP□Ain is discarded within this set time after the output has turned OFF.	30
PE□18	Base output position	Set the output network variable that turns ON first. 1: nvoSTEP□Dout1, 2: nvoSTEP□Dout2 3: nvoSTEP□Dout3, 4: nvoSTEP□Dout4	1

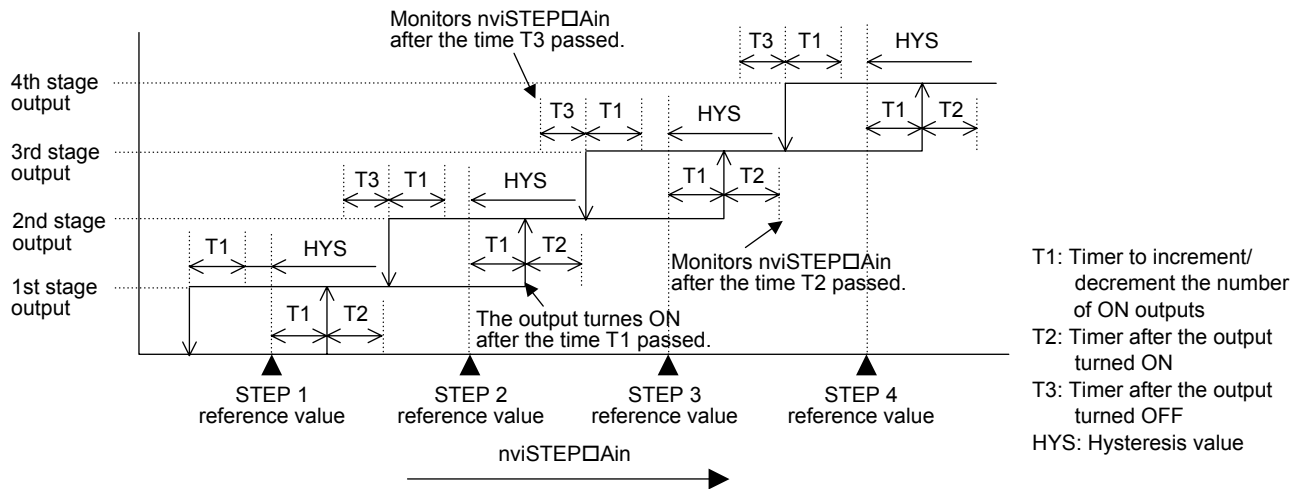

**Note:** The STEP reference values must be set in ascending order. When they are not set in ascending order, only the values that are set in ascending order are valid.  
 STEP 1 reference value < STEP 2 reference value < STEP 2 reference value < STEP 4 reference value

**■ Operation**

**First In Last Out (FILO)**

With this method, the nvoSTEP□Dout that was turned ON first is turned OFF last.

The nvoSTEP□Dout that turns ON first can be specified using the parameter PE□18 (base output position).

Example 1: Order of priority for output when the base position for output is 1.

Output Position	ON Output Order	OFF Output Order
nvoSTEP□Dout1	1	4
nvoSTEP□Dout2	2	3
nvoSTEP□Dout3	3	2
nvoSTEP□Dout4	4	1

Example 2: Order of output priority when the base output position is 2.

Output Position	ON Output Priority	OFF Output Priority
nvoSTEP□Dout1	3	2
nvoSTEP□Dout2	4	1
nvoSTEP□Dout3	1	4
nvoSTEP□Dout4	2	3

While the output is interlocked, all the outputs turns OFF. When the interlock is released, the output turns ON in order from the base output position.

**First In First Out (FIFO)**

With this method, the nvoSTEP□Dout that was turned ON first is turned OFF first.

Also after interlocking, the position of the signal to be turned ON first for the next operation is the next one for the position whose signal was last turned ON.

Example 1: Order of priority for output when the base position for output is 1.

Output Position	ON Output Priority	OFF Output Priority
nvoSTEP□Dout1	1	1
nvoSTEP□Dout2	2	2
nvoSTEP□Dout3	3	3
nvoSTEP□Dout4	4	4

Example 2: Output start position when interlocked (Base output position: 1).

STEP 1 reference value: 10.000%

STEP 2 reference value: 30.000%

## 11 Function Modules

STEP 3 reference value: 50.000%

STEP 4 reference value: 70.000%

Operation Pattern	Output Position	nvoSTEP□Dout1	nvoSTEP□Dout2	nvoSTEP□Dout3	nvoSTEP□Dout4	Data of nviSTEP□Ain
1	0-stage output	○	○	○	○	5.00%
2	1-stage output	●	○	○	○	12.00%
3	On being interlocked	○	○	○	○	35.00%
4	1-stage output	○	●	○	○	35.00%
5	2-stage output	○	●	●	○	35.00%
6	3-stage output	○	●	●	●	50.00%
7	On being interlocked	○	○	○	○	50.00%
8	1-stage output	●	○	○	○	20.00%
9	2-stage output	●	●	○	○	40.00%
10	3-stage output	●	●	●	○	80.00%
11	4-stage output	●	●	●	●	80.00%
12	3-stage output	○	●	●	●	60.00%
13	2-stage output	○	○	●	●	40.00%
14	On being interlocked	○	○	○	○	40.00%
15	1-stage output	●	○	○	○	40.00%
16	2-stage output	●	●	○	○	40.00%

●: Output signal ON, ○: Output signal OFF

The details of the operation pattern described in the table above are in order as follows.

- All the output signals are OFF because the value of the data of nviSTEP□Ain is less than the STEP 1 reference value.
- The output Dout1 turns ON first as the base output position is 1.
- All the outputs are turned OFF by setting the interlock to 0.
- The operation restarts when the interlock is released. The position that turns ON first is not the position set for the base output position but the output step next to the output (nvoSTEP□Dout1) that turned ON last before the outputs have been interlocked in pattern 3: nvoSTEP□Dout2.
- As the value of nviSTEP□Ain increases, the nvoSTEP□Dout3 and nvoSTEP□Dout4 turn ON in order.
- The operation pattern is the same as pattern 5.
- All the outputs are turned OFF by setting the interlock to 0.
- In the same way as in pattern 4, the operation restarts when the interlock is released. The position that turns ON first is not the position set for the base output position but the output next to the output (nvoSTEP□Dout4) that turned ON last before the outputs have been interlocked in pattern 7: nvoSTEP□Dout1.
- As the value of nviSTEP□Ain increases, the nvoSTEP□Dout2, nvoSTEP□Dout3, and nvoSTEP□Dout4 turn ON in order.
- The operation pattern is the same as pattern 5.
- The operation pattern is the same as pattern 5.
- The value of the input data of nviSTEP□Ain becomes less than the STEP 4 reference value. The output nvoSTEP□Dout1 that turned ON first among four outputs turns OFF first.
- The value of nviSTEP□Ain becomes less than the STEP 3 reference value. The output nvoSTEP□Dout2 turns OFF.
- All the outputs are turned OFF by setting the interlock to 0.
- In the same way as in pattern 4 and 8, the operation restarts when the interlock is released. The position that turns ON first is not the position set for the base output position but the output next to the output (nvoSTEP□Dout4) that turned ON last before the outputs have been interlocked in process 11: nvoSTEP□Dout1.
- The value of nviSTEP□Ain is not changed but more than the STEP 2 reference value. The nvoSTEP□Dout2 turns ON after the set time of the timer.

## ◆ Delay Timer Function

### ■ Function Image

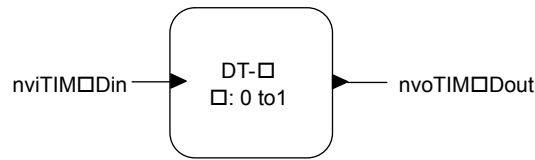

### ■ Network Variables and Parameters

#### Network Variables

Network Variable	Variable Type	Type Change	Name and Function
nviTIM□Din	SNVT_switch	Impossible	Timer start input state = -1: Output OFF state = 0: Depends on the operation mode state = 1: Depends on the operation mode
nvoTIM□Dout	SNVT_switch	Impossible	Output 1 When ON: state = 1, value = 100.0 When OFF: state = 0, value = 0.0

#### Parameters

Parameter	Name	Explanation	Default
PF□00	Operation mode selection	0: ON delay, 1: OFF delay	0
PF□01	ON delay time	Sets the ON delay time in units of 1 s.	0
PF□02	OFF delay time	Sets the OFF delay time in units of 1 s.	0
PF□04	Operation when the power turns ON	0: nvoTIMDout turns ON when the set delay time has passed after nviTIMDin turned ON. 1: nvoTIMDout turns ON when nviTIMDin turns ON without waiting for the set delay time.	0

### ■ Operation

#### ON/OFF Delay

The ON/OFF Delay mode delays the timing to turn ON/OFF the output network variable nvoTIM□Dout according to the data of the input network variable nviTIM□Din for the set time period as shown in the following figure.

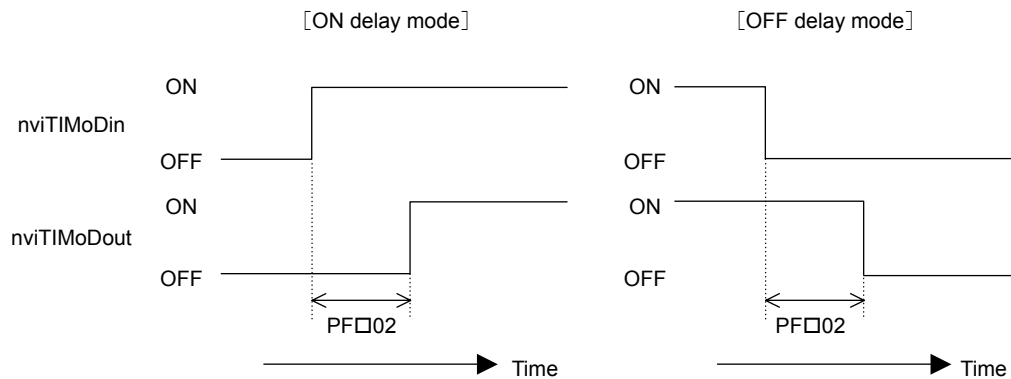

## ◆ Deviation Output Function

### ■ Function Image

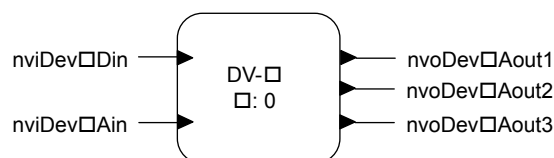

## Network Variables and Parameters

The value of the deviation added to or subtracted from the analog data (set value) of the input network variable is sent to the output network variable.

### Network Variables

Network Variable	Variable Type	Type Change	Name and Function
nviDev□Din	SNVT_switch	Impossible	Used for the operation mode “Outputs with 2 deviation”. <i>Refer to Ratio/Bias on page 55</i> for details.
nviDev□Ain	SNVT_lev_percent	Possible	Input data The base data for the data to be output.
nviDev□Aout1	SNVT_lev_percent	Possible	The deviation is added to or subtracted from the value according to the operation mode, and the result is sent to the nviDev□Ain.
nvoDev□Aout2	SNVT_lev_percent	Possible	The deviation is added to or subtracted from the value according to the operation mode, and the result is sent to the nviDev□Ain.
nvoDev□Aout3	SNVT_lev_percent	Possible	The deviations is added to or subtracted from the value according to the operation mode, and the result is sent to the nviDev□Ain.

### Parameters

Parameter	Name	Explanation	Default
PG□00	Variable type	Impossible to set from the Operator	0
PG□01	Operation mode selection	0: Outputs with 3 deviations 1: Outputs with 2 deviations	0
PG□11	Deviation a	Sets a deviation.	0
PG□12	Deviation b	Sets a deviation.	0
PG□13	Deviation c	Sets a deviation.	0

## Operation

### Outputs with 3 Deviations

Three deviations set in PG11, PG12, PG13 are added to or subtracted from the data of nviDev□Ain as shown below, and the results are sent to nviDev□Aout1, 2, and 3. Each output network variable is calculated using the equation below.

$$nviDev□Aout1 = nviDev□Ain - PG11$$

$$nvoDev□Aout2 = nviDev□Ain + PG12$$

$$nvoDev□Aout3 = nviDev□Ain + PG13$$

### Outputs with 2 Deviations

Two output data are set as follows according to the status of nviDevDin.

- When nviDev□Din = OFF,  
nviDev□Aout1 = 0 (Fixed)  
nvoDev□Aout2 = nviDev□Ain - PG13  
nvoDev□Aout3 = nviDev□Ain
- When nviDev□Din = ON,  
nviDev□Aout1 = nviDev□Ain  
nvoDev□Aout2 = nviDev□Ain + PG11  
nvoDev□Aout3 = 100 (Fixed)

**Note:** If the result of the above operation becomes out of the effective data range, the maximum or minimum value will be output.

## PID Function

### Function Image

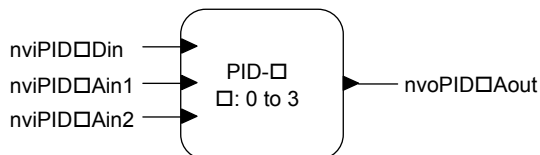



## ■ Network Variables and Parameters

The PID function executes PI control using the data of two input network variables, and sent to the output network variable.

### Network Variables

Network Variable	Variable Type	Type Change	Name and Function
nviPID□Din	SNVT_switch	Impossible	Output interlock 0: Interlock 1: Start control
nviPID□Ain1	SNVT_lev_percent	Possible	Sets value data (SP)
nviPID□Ain2	SNVT_lev_percent	Possible	Process input value (Feedback data) (PV)
nvoPID□Aout	SNVT_lev_percent	Impossible	Outputs the output amount calculated on the base of feedback data. Output range: -5.00 to +105.00%

### Parameters

Parameter	Name	Explanation	Default
PH□00	Variable type	Impossible to set from the Operator	0
PH□01	Operation mode selection	0: Forward operation 1: Reversed operation	0
PH□02	Proportional band	0 to 6553.5 s However, when the input network variable type is set to SNVT_flow or SNVT_ppm, the value below the decimal point is rounded up for operation.	1.0
PH□03	Integral time	0 to 6553.5 s	1.0
PH□04	Output when interlocked	The value of the PID output when interlocked	0
PH□05	Reference point	The reference point to be used for operation	50

## ■ Operation

The PID output when interlocked can be calculated using the following equation.

Forward operation:  $P = P_{(0)} - \{(100 / P_b) \times e_i\} - \{(100 \times \theta) / (T_i \times P_b)\} \times e_i$

Reverse operation:  $P = P_{(0)} + \{(100 / P_b) \times e_i\} - \{(100 \times \theta) / (T_i \times P_b)\} \times e_i$

P: PID output (%) (-5 to +105%)

$P_{(0)}$ : Reference point (PH□05)

$P_b$ : Proportional band (PH□02)

$\theta$ : Operation cycle (100 ms)

$T_i$ : Integral time (PH□03)

$e_i$ : Deviation (nviPID□Ain1 – nviPID□Ain2)

## ◆ Constant Output Function

### ■ Function Image

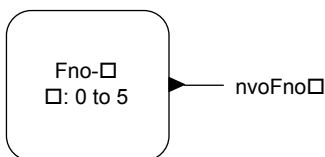

### ■ Network Variables and Parameters

The data set in the parameter is output.

#### Network Variables

Network Variable	Variable Type	Type Change	Name and Function
nvoFno□Aout	SNVT_lev_percent	Possible	The data set in the parameter is output when the power turns ON.

#### Parameters

Parameter	Name	Explanation	Default
PJ□00	Variable type	It is not possible to set this parameter using the digital operator.	0
PJ□01	Constant	Set a desired numerical value.	0

### ■ Operation

The constant set in the parameter is sent to the network variable.

## ◆ Variable Type Conversion Function

### ■ Function Image

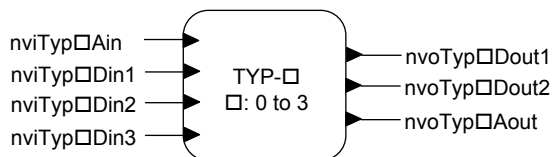

### ■ Network Variables and Parameters

The Variable Type Conversion Function converts DIGIN to ANAOUT, and ANA\_IN to DIG\_OUT.

#### Network Variables

Network Variable	Variable Type	Type Change	Name and Function
nviTyp□Din1	SNVT_switch	Impossible	–
nviTyp□Din2	SNVT_switch	Impossible	–
nviTyp□Din3	SNVT_switch	Impossible	–
nviTyp□Ain	SNVT_lev_percent	Possible	–
nvoTyp□Dout1	SNVT_switch	Impossible	DIG output 1 When ON: state = 1, value = 100.0 When OFF: state = 0, value = 0.0
nvoTyp□Dout2	SNVT_switch	Impossible	DIG output 2 When ON: state = 1, value = 100.0 When OFF: state = 0, value = 0.0
nvoTyp□Aout	SNVT_lev_percent	Possible	–

#### Parameters

Parameter	Name	Explanation	Default
PL□00	Variable type	It is not possible to set this parameter using the digital operator.	0
PL□01	Variable type	It is not possible to set this parameter using the digital operator.	0

Parameter	Name	Explanation	Default
PL□02	Input range 1	Sets the input range when converting from ANA to ANA.	0
PL□03	Input range 2	Sets the input range when converting from ANA to ANA.	0
PL□04	Output range 1	Set the output range when converting from ANA to ANA.	0
PL□05	Output range 2	Set the output range when converting from ANA to ANA.	0
PL□06	Operation mode selection	0: ANA → ANA 1: ANA → DIG 2: DIG → ANA	0
PL□10	Input reference data	The value to turn ON nvoTyp□Dout1 when converting from ANA to DIG	999
PL□11	Input reference data	The value to turn ON nvoTyp□Dout1 when converting from ANA to DIG	999
PL□12	Input reference data	The value to turn ON nvoTyp□Dout1 when converting from ANA to DIG	999
PL□13	Input reference data	The value to turn ON nvoTyp□Dout1 when converting from ANA to DIG	999
PL□14	Input reference data	The value to turn ON nvoTyp□Dout2 when converting from ANA to DIG	999
PL□15	Input reference data	The value to turn ON nvoTyp□Dout2 when converting from ANA to DIG	999
PL□16	Input reference data	The value to turn ON nvoTyp□Dout2 when converting from ANA to DIG	999
PL□17	Input reference data	The value to turn ON nvoTyp□Dout2 when converting from ANA to DIG	999
PL□18	Output reference data	The data to be sent if nviTyp□Din1=ON when converting from DIG to ANA	–
PL□19	Output reference data	The data to be sent if nviTyp□Din2=ON when converting from DIG to ANA	–
PL□20	Output reference data	The data to be sent if nviTyp□Din3=ON when converting from DIG to ANA	–

■ Operation

Conversion from ANA to ANA

(PL□02 (operation mode selection) = 0)

- Example: Conversion from percent to Temp

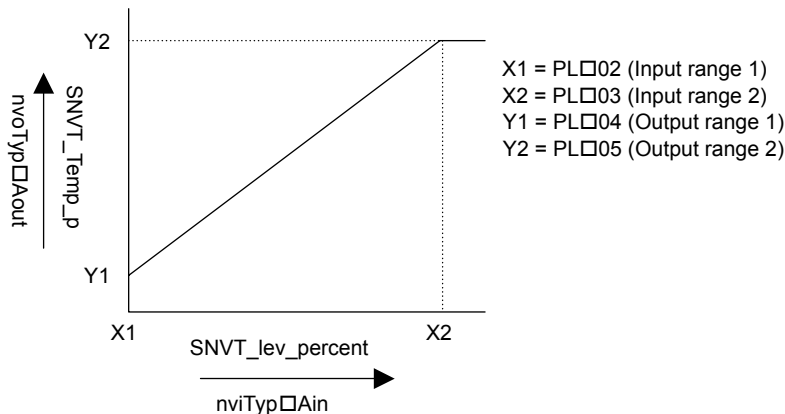

Conversion from ANA to DIG (PL□02 (operation mode selection) = 1)

The value of nviTyp□Ain is compared with the set values of PL□10 to 17, and when the value of nviTyp□Ain agrees with a set value of PL□10 to 17, the Dout corresponding to the parameter of the agreed value turns ON.

If an invalid data is input, the outputs turn OFF.

- Example: Conversion from SNVT\_lev\_percent to SNVT\_switch  
 PL□10: 10.000%, PL□11: 30.000%, PL□12: 50.000%, PL□13: 70.000%,  
 PL□14: 20.000%, PL□15: 40.000%, PL□16: 60.000%, PL□17: 80.000%

ON Output	Data of nviTyp□Ain (SNVT_lev_percent)									
	0	5	10	20	25	30	35	40	80	75
nvoTyp□Dout1	○	○	●	○	○	●	○	○	○	○
nvoTyp□Dout2	○	○	○	●	○	○	○	●	●	○

●: Output signal ON, ○: Output signal OFF

- Example: Conversion from SNVT\_lev\_percent to SNVT\_switch  
 PL□10: 1 (HEAT), PL□11: 3 (COOL), PL□12: 0 (AUTO), PL□13: 2 (WRMUP),  
 PL□14: 2 (WRMUP), PL□15: 6 (OFF), PL□16: 999, PL□17: 999

## 11 Function Modules

ON Output	Data of nviTyp□Ain (SNVT_lev_percent)									
	0	4	6	2	1	6	2	7	3	FF
nvoTyp□Dout1	●	○	○	●	●	○	●	○	●	○
nvoTyp□Dout2	○	○	●	●	○	●	●	○	○	○

●: Output signal ON, ○: Output signal OFF

### Conversion from DIG to ANA (PL□02 (operation mode selection) = 2

When nviTyp□Din1 is ON, the set value of PL□18 is output to nvoTyp□Aout.

When nviTyp□Din2 is ON, the set value of PL□19 is output to nvoTyp□Aout.

When nviTyp□Din3 is ON, the set value of PL□20 is output to nvoTyp□Aout.

When nviTyp□Din1, nviTyp□Din2 and nviTyp□Din3 are ON at the same time, the set values are displayed as follows;

nviTyp□Din3 > nviTyp□Din2 > nviTyp□Din1

## ◆ Save Data Function

### ■ Function Image

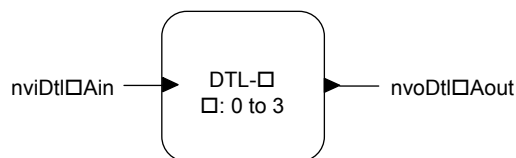

### ■ Network Variables and Parameters

The Save Data function saves the input data at reception. The saved data is not cleared whenever the power turns OFF.

Network Variable	Variable Type	Type Change	Name and Function
nviDtl□Ain	SNVT_lev_percent	Possible	–
nvoDtl□Aout	SNVT_lev_percent	Possible	–

### Parameters

Parameter	Name	Explanation	Default
Po□00	Variable type	Impossible to set from the Operator	0

### ■ Operation

The analog input data is saved in the EEPROM to prevent the data from being lost during a power failure.

Usually, the data of nviDtl□Ain is sent to nvoDtl□Aout.

**Note:** Do not change the input network variables of this function unless necessary because doing so will greatly shorten the life of EEPROM.

## ◆ Standard Network Variable Types (SNVTs)

The following five standard network variable types can be selected from the Operator for SNVT regarded as the data.

Parameter Setting	Name	Variable Type	Descriptions
0	Percent (Humidity, frequency, etc.)	SNVT_lev_percent	SNVT #: 81 Measurement: Percent Level or Humidity Data type: Fixed Point Scalar - signed long Data size: 2 bytes Data range (Resolution): -163.84 to 163.83% (0.005%/bit) The value 0x7FFF represents invalid data.
1	Pressure	SNVT_Press	SNVT #: 30 Measurement: Gauge Pressure Data type: Fixed Point Scalar - signed long Data size: 2 bytes Data range (Resolution): -3,276.8 to 3,276.7 kilopascals (0.1 kPa)
2	Pressure	SNVT_Press_p	SNVT #: 113 Measurement: Gauge Pressure Data type: Fixed Point Scalar - signed long Data size: 2 bytes Data range (Resolution): -32,768 to 32,766 Pascals (1 Pa). The value 0x7FFF represents invalid data.
3	Flow	SNVT_flow	SNVT #: 15 Measurement: Flow Data type: Fixed Point Scalar - unsigned long Data size: 2 bytes Data range (Resolution): 0 to 65,534 l/s (1 l/s) The value 0xFFFF represents invalid data.
4	Temperature	SNVT_temp_p	SNVT #: 105 Measurement: Temperature Data type: Fixed Point Scalar - signed long Data size: 2 bytes Data range (Resolution): -273.17 to 327.66 °C (0.01 °C). The value 0x7FFF represents invalid data.
5	Concentration	SNVT_ppm	SNVT #: 29 Measurement: Concentration Data type: Fixed Point Scalar - unsigned long Data size: 2 bytes Data range (Resolution): 0 .. 65,535 parts per million (1 ppm) The value 0xFFFF (65,535) represents invalid data.
6	HVAC mode	SNVT_HVAC_mode	SNVT #: 108 Contents: HVAC mode Data type: Enumeration Scalar Data size: 1 byte Data range (Resolution): hvac_t Enumeration Typedef File: SNVT_HV.H
	Enum Definitions Value Identifier 0 HVAC_AUTO:Controller automatically changes between application modes 1 HVAC_HEAT:Heating only 2 HVAC_MRNG_WRMUP:Application-specific morning warm-up 3 HVAC_COOL:Cooling only 4 HVAC_NIGHT_PURGE:Application-specific night purge 5 HVAC_PRE_COOL:Application-specific pre-cool 6 HVAC_OFF:Controller not controlling outputs 7 HVAC_TEST:Equipment being tested 8 HVAC_EMERG_HEAT:Emergency heat mode (heat pump) 9 HVAC_FAN_ONLY:Air not conditioned, fan turned on 10 HVAC_FREE_COOL:Cooling with compressor not running 11 HVAC_ICE:Ice-making mode 0xFF HVAC_NUL:Value not available		

## 11 Function Modules

Parameter Setting	Name	Variable Type	Descriptions
7	HVAC mode	SNVT_HVAC_state	SNVT#: 112 Contents: HVAC status Data type: Structure Data size: 12 bytes
	<pre> Structure typedef struct { hvac_t mode; signed longheat_output_primary; signed longheat_output_secondary; signed longcool_output; signed longecon_output; signed longfan_output; unsignedin_alarm; } SNVT_hvac_status; Field Definitions Field Units Valid Range Notes modehvac_tcompatible with SNVT_hvac_mode heat_output_primarySNVT_lev_percent-163.83 .. +163.83% primary heat output heat_output_secondarySNVT_lev_percent-163.83 .. +163.83% secondary heat output cool_outputSNVT_lev_percent-163.83 .. +163.83% cooling output econ_outputSNVT_lev_percent-163.83 .. +163.83% economizer output fan_outputSNVT_lev_percent-163.83 .. +163.83% fan output in_alarmboolean0 .. 11 means unit is in alarm </pre>		

## 12 Specifications

**Table 9 Product Specifications**

Items	Specifications
Model	SI-W3
Node Type	Host Application Node
Communication Speed	78 kbps
Communication IC	Neuron chip FT3120
Communication Driver	FT-X1 (free topology)
Protocol	LonTalk protocol node
Network Variables	Total: 238 (236 for software version 9001) Standard Network Variable Types (SNVT): Variable Speed Motor Drive function profile Ver1.1
Network Variable Alias	Maximum: 50
Maximum Number of Connections	64 (in one segment)
Total Wiring Length	Max 500 m
Ambient Temperature	-10 °C to +50 °C (14 °F to 122 °F)
Humidity	95% RH or lower with no condensation
Storage Temperature	-20 °C to +60 °C (-4 °F to +140 °F) allowed for short-term transport of the product
Area of Use	Indoor (free of corrosive gas, airborne particles, etc.)
Altitude	1000 m (3280 ft.) or lower

---

## Revision History

The revision dates and the numbers of the revised manuals appear on the bottom of the back cover.

Example:  
MANUAL NO. SIEPYAICOM26 Rev: A0  
Published in U.S.A. August 2016 16-8  
Date of publication Date of original publication  
Revision number

Date of Publication	Revision Number	Section	Revised Content
August 2016	-	-	First Edition





# YASKAWA Z1000 Bypass Option LonWorks Technical Manual

---

**YASKAWA AMERICA, INC.**

2121, Norman Drive South, Waukegan, IL 60085, U.S.A.  
Phone: 1-800-YASKAWA (927-5292) or 1-847-887-7000 Fax: 1-847-887-7310  
<http://www.yaskawa.com>

**DRIVE CENTER (INVERTER PLANT)**

2-13-1, Nishimiyaichi, Yukuhashi, Fukuoka, 824-8511, Japan  
Phone: 81-930-25-3844 Fax: 81-930-25-4369  
<http://www.yaskawa.co.jp>

**YASKAWA ELECTRIC CORPORATION**

New Pier Takeshiba South Tower, 1-16-1, Kaigan, Minatoku, Tokyo, 105-6891, Japan  
Phone: 81-3-5402-4502 Fax: 81-3-5402-4580  
<http://www.yaskawa.co.jp>

**YASKAWA ELÉTRICO DO BRASIL LTDA.**

777, Avenida Piraporinha, Diadema, São Paulo, 09950-000, Brasil  
Phone: 55-11-3585-1100 Fax: 55-11-3585-1187  
<http://www.yaskawa.com.br>

**YASKAWA EUROPE GmbH**

185, Hauptstraße, Eschborn, 65760, Germany  
Phone: 49-6196-569-300 Fax: 49-6196-569-398  
<http://www.yaskawa.eu.com>

**YASKAWA ELECTRIC KOREA CORPORATION**

9F, Kyobo Securities Bldg., 26-4, Yeouido-dong, Yeongdeungpo-gu, Seoul, 150-737, Korea  
Phone: 82-2-784-7844 Fax: 82-2-784-8495  
<http://www.yaskawa.co.kr>

**YASKAWA ELECTRIC (SINGAPORE) PTE. LTD.**

151, Lorong Chuan, #04-02A, New Tech Park, 556741, Singapore  
Phone: 65-6282-3003 Fax: 65-6289-3003  
<http://www.yaskawa.com.sg>

**YASKAWA ELECTRIC (THAILAND) CO., LTD.**

252/125-126, 27th Floor, Muang Thai-Phatra Tower B, Rachadapisek Road, Huaykwang, Bangkok, 10310, Thailand  
Phone: 66-2693-2200 Fax: 66-2693-4200  
<http://www.yaskawa.co.th>

**YASKAWA ELECTRIC (CHINA) CO., LTD.**

22F, One Corporate Avenue, No.222, Hubin Road, Shanghai, 200021, China  
Phone: 86-21-5385-2200 Fax: 86-21-5385-3299  
<http://www.yaskawa.com.cn>

**YASKAWA ELECTRIC (CHINA) CO., LTD. BEIJING OFFICE**

Room 1011, Tower W3 Oriental Plaza, No. 1, East Chang An Ave.,  
Dong Cheng District, Beijing, 100738, China  
Phone: 86-10-8518-4086 Fax: 86-10-8518-4082

**YASKAWA ELECTRIC TAIWAN CORPORATION**

9F, 16, Nanking E. Rd., Sec. 3, Taipei, 104, Taiwan  
Phone: 886-2-2502-5003 Fax: 886-2-2505-1280

**YASKAWA INDIA PRIVATE LIMITED**

#17/A, Electronics City, Hosur Road, Bangalore, 560 100 (Karnataka), India  
Phone: 91-80-4244-1900 Fax: 91-80-4244-1901  
<http://www.yaskawaindia.in>

---

## YASKAWA

### YASKAWA AMERICA, INC.

In the event that the end user of this product is to be the military and said product is to be employed in any weapons systems or the manufacture thereof, the export will fall under the relevant regulations as stipulated in the Foreign Exchange and Foreign Trade Regulations. Therefore, be sure to follow all procedures and submit all relevant documentation according to any and all rules, regulations and laws that may apply.

Specifications are subject to change without notice for ongoing product modifications and improvements.

© 2016 YASKAWA AMERICA, INC. All rights reserved.



SIEPYAICOM26

MANUAL NO. SIEPYAICOM26 Rev: A0

Published in USA August 2016 16-8