

YASKAWA

YASKAWA AC Drive P1000

AC Drive Bypass for Industrial Fans and Pumps

Technical Manual

Type: P1B
Models: 208 V: 1/2 to 100 HP
480 V: 3/4 to 500 HP

To properly use the product, read this manual thoroughly and retain for easy reference, inspection, and maintenance. Ensure the end user receives this manual.

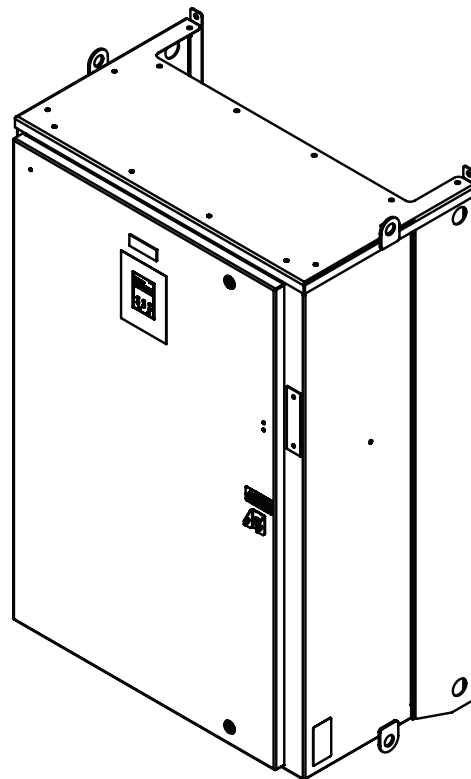

MANUAL NO. SIEP YAIP1B 01D

Receiving	1
Mechanical Installation	2
Electrical Installation	3
Start-Up Programming & Operation	4
Programming	5
Diagnostics & Troubleshooting	6
Periodic Inspection & Maintenance	7
Specifications	A
Parameter List	B
BACnet Communications	C
MEMOBUS/Modbus Communications	D
Standards Compliance	E
Apogee FLN Network Protocol	F
Metasys N2 Network Protocol	G
Quick Reference Sheet	H

This Page Intentionally Blank

Copyright © 2014 YASKAWA AMERICA, INC. All rights reserved.

No part of this publication may be reproduced, stored in a retrieval system, or transmitted, in any form or by any means, mechanical, electronic, photocopying, recording, or otherwise, without the prior written permission of Yaskawa. No patent liability is assumed with respect to the use of the information contained herein. Moreover, because Yaskawa is constantly striving to improve its high-quality products, the information contained in this manual is subject to change without notice. Every precaution has been taken in the preparation of this manual. Yaskawa assumes no responsibility for errors or omissions. Neither is any liability assumed for damages resulting from the use of the information contained in this publication.

Table of Contents

i. PREFACE & GENERAL SAFETY	13
i.1 Preface	14
Product Description	14
Applicable Documentation.....	14
Symbols.....	15
Terms and Abbreviations	15
Trademarks	15
i.2 General Safety	16
Supplemental Safety Information	16
Safety Messages.....	17
General Application Precautions	18
Motor Application Precautions.....	20
Drive Label Warning Example.....	22
Bypass Label Warning Example	23
Warranty Information.....	24
1. RECEIVING	25
1.1 Section Safety	26
1.2 General Description	27
Control Mode Details.....	27
1.3 Model Numbers and Nameplate Checks	28
Drive Nameplate.....	28
Bypass Nameplate	29
Bypass Enclosures.....	31
Bypass Product Options.....	31
1.4 Bypass Component Descriptions	32
Bypass Front Control Panel	32
Front Views	33
2. MECHANICAL INSTALLATION	35
2.1 Section Safety	36
2.2 Mechanical Installation	38
Installation Environment.....	38
3. ELECTRICAL INSTALLATION	39
3.1 Section Safety	40
3.2 Standard Connection Diagram	42

Table of Contents

3.3 Main Circuit Wiring	43
Factory Recommended Branch Circuit Protection	43
Drive Main Circuit Terminal Functions	43
Wire Gauge and Tightening Torque Specifications.....	43
Main Input Circuit and Motor Wiring	43
Wiring the Main Input Circuit	45
3.4 Control Circuit Wiring	46
Electronic Bypass Control Terminal Board A2	46
Bypass Analog Outputs	47
Serial Communications	48
Drive Cover Removal	49
Wiring the Drive Control Circuit Terminal	50
Switches and Jumpers on the Terminal Board.....	51
3.5 Bypass and Drive Control I/O Connections	52
Terminals A1, A2, and A3 Input Signal Selection.....	52
Terminal FM/AM Signal Selection	52
3.6 External Interlock	54
Annunciation Contact Outputs.....	54
Building Automation System Run/Stop Circuit	54
Safety Interlock Circuit	54
Building Automation System Interlock Circuit (Drive and Bypass Enable Input).....	54
Remote Transfer to Bypass.....	55
Smoke Purge Operation.....	55
Spare Multi-Function Digital Inputs	55
4. START-UP PROGRAMMING & OPERATION	57
4.1 Section Safety	58
4.2 Using the HOA Keypad	59
HOA Keypad Keys and Displays.....	59
LCD Display	60
Bypass Control Board LEDs.....	62
ALARM (ALM) LED Displays.....	62
AUTO LED and HAND LED Indications	62
HOA Keypad Menu Structure.....	64
HOA Keypad Parameter Display (Drive Off)	64
4.3 The Drive and Programming Modes	66
Changing Parameter Settings or Values	66
Verifying Parameter Changes: Modified Constants	67
Simplified Setup Using the Quick Setting Group.....	68
4.4 Powering Up the Drive	70
Powering Up the Drive and Operation Status Display.....	70
4.5 Start-Up Procedure	71
Bypass Start-Up Preparation.....	71
Bypass Start-Up Procedure.....	72
4.6 Application Selection	75
4.7 Auto-Tuning	76
Types of Auto-Tuning	76
Before Auto-Tuning the Drive.....	76
Auto-Tuning Interruption and Fault Codes	77

Auto-Tuning Operation Example	77
T1: Parameter Settings during Induction Motor Auto-Tuning	79
5. PROGRAMMING	81
5.1 A: Initialization	82
A1: Initialization	82
5.2 b: Application.....	83
b1: Operation Mode Selection.....	83
b2: DC Injection Braking and Short Circuit Braking.....	85
b3: Speed Search.....	85
b5: PID Control.....	90
5.3 C: Tuning.....	103
C1: Acceleration and Deceleration Times	103
C2: S-Curve Characteristics	103
C4: Torque Compensation	104
C6: Carrier Frequency.....	104
5.4 d: Reference Settings	106
d1: Frequency Reference.....	106
d2: Frequency Upper/Lower Limits	107
d3: Jump Frequency.....	108
5.5 E: Motor Parameters	109
E1: V/f Pattern for Motor 1.....	109
E2: Motor 1 Parameters	113
5.6 F: Options.....	114
F6: Drive/Bypass Communications	114
5.7 H: Terminal Functions.....	115
H1: Multi-Function Digital Inputs	115
H2: Multi-Function Digital Outputs.....	117
H3: Multi-Function Analog Inputs	124
H4: Multi-Function Analog Outputs	131
H5: MEMOBUS/Modbus Serial Communication	133
5.8 L: Protection Functions	134
L1: Motor Protection	134
L2: Momentary Power Loss Ride-Thru.....	135
L3: Stall Prevention	136
L4: Reference Detection.....	139
L5: Fault Restart.....	139
L6: Torque Detection.....	142
L8: Drive Protection.....	145
5.9 n: Special Adjustments.....	148
n1: Hunting Prevention.....	148
n3: High Slip Braking (HSB) and Overexcitation Braking.....	148
5.10 o: Operator-Related Settings	150
o1: HOA Keypad Display Selection.....	150
o2: HOA Keypad Functions.....	152
o4: Maintenance Monitor Settings.....	152
5.11 S: Special Parameters.....	154
S1: Dynamic Audible Noise Control Function	154
S2: Sequence Timers.....	155

Table of Contents

Examples of Sequence Timers	157
T: Motor Tuning	160
5.12 U: Monitor Parameters	161
UB: Bypass Monitors	161
U1: Operation Status Monitors	161
U2: Fault Trace	161
U3: Fault History	161
U4: Maintenance Monitors	161
U5: PID Monitors	161
5.13 Z: Bypass Parameters	162
Z1: Bypass Control System	162
Z2: Bypass Control Input/Output	177
Z3: Bypass Control Communication	180
Z4: Ethernet Option Bypass Control	183
6. DIAGNOSTICS & TROUBLESHOOTING	187
6.1 Section Safety	188
6.2 Motor Performance Fine-Tuning	190
Fine-Tuning V/f Control	190
Parameters to Minimize Motor Hunting and Oscillation	190
6.3 Drive Alarms, Faults, and Errors	191
Types of Alarms, Faults, and Errors	191
Alarm and Error Displays	192
6.4 Fault Detection	194
Fault Displays, Causes, and Possible Solutions	194
6.5 Alarm Detection	209
Alarm Codes, Causes, and Possible Solutions	209
6.6 Programming Errors	216
Programming Error Codes, Causes, and Possible Solutions	216
6.7 Auto-Tuning Fault Detection	219
Auto-Tuning Codes, Causes, and Possible Solutions	219
6.8 Diagnosing and Resetting Faults	221
Fault Occurs Simultaneously with Power Loss	221
If the Drive Still has Power After a Fault Occurs	221
Viewing Fault Trace Data After Fault	221
Fault Reset Methods	222
6.9 Troubleshooting without Fault Display	223
Common Problems	223
Cannot Change Parameter Settings	223
Motor Does Not Rotate Properly after Pressing AUTO Button or after Entering External Run Command	224
Motor is Too Hot	225
oPE02 Error Occurs When Lowering the Motor Rated Current Setting	225
Motor Stalls during Acceleration or Acceleration Time is Too Long	226
Drive Frequency Reference Differs from the Controller Frequency Reference Command	226
Excessive Motor Oscillation and Erratic Rotation	227
Deceleration Takes Longer Than Expected	227
Noise From Drive or Motor Cables When the Drive is Powered On	227
Ground Fault Circuit Interrupter (GFCI) Trips During Run	227

Table of Contents

Connected Machinery Vibrates When Motor Rotates	227
PID Output Fault.....	228
Motor Rotates after the Drive Output is Shut Off (Motor Rotates During DC Injection Braking)	228
Output Frequency is Not as High as Frequency Reference.....	228
Sound from Motor.....	228
Motor Does Not Restart after Power Loss.....	229
7. PERIODIC INSPECTION & MAINTENANCE	231
7.1 Section Safety.....	232
7.2 Inspection	234
Recommended Daily Inspection.....	234
Recommended Periodic Inspection.....	235
7.3 Periodic Maintenance	237
Replacement Parts.....	237
7.4 HOA Keypad Battery Replacement.....	239
Real-Time Clock Adjustment.....	239
7.5 Drive Cooling Fan Replacement	241
A. SPECIFICATIONS	243
A.1 Power Ratings	244
Three-Phase 208 Vac Bypass Drive Models D002 to D030	244
Three-Phase 208 Vac Bypass Drive Models D046 to D211	244
Three-Phase 208 Vac Bypass Drive Models D273 to D396	245
Three-Phase 480 Vac Bypass Drive Models B001 to B027.....	245
Three-Phase 480 Vac Bypass Drive Models B034 to B156.....	246
Three-Phase 480 Vac Bypass Drive Models B180 to B590.....	246
A.2 Drive Specifications	247
A.3 Drive Watt Loss Data	249
A.4 Drive Derating Data	251
Rated Current Depending on Carrier Frequency	251
Altitude Derating.....	252
A.5 Bypass Options	253
Option PA.....	253
Option PK.....	253
Option PM	253
Option PN.....	253
Option PR.....	253
Option PX.....	253
Option PY	253
Option TD.....	253
Option TL.....	253
Option TQ.....	253
Option TW	253
B. PARAMETER LIST.....	255
B.1 Parameter Groups	256
B.2 A: Initialization Parameters	257
A1: Initialization	257
B.3 b: Application.....	258

Table of Contents

b1: Operation Mode Selection.....	258
b2: DC Injection Braking and Short Circuit Braking.....	258
b3: Speed Search.....	258
b5: PID Control.....	259
B.4 C: Tuning.....	262
C1: Acceleration and Deceleration Times.....	262
C2: S-Curve Characteristics.....	262
C4: Torque Compensation.....	262
C6: Carrier Frequency.....	262
B.5 d: References.....	263
d1: Frequency Reference.....	263
d2: Frequency Upper/Lower Limits.....	263
d3: Jump Frequency.....	263
B.6 E: Motor Parameters.....	264
E1: V/f Pattern for Motor 1.....	264
E2: Motor Parameters.....	264
B.7 F: Options.....	265
F6: Drive/Bypass Communications.....	265
B.8 H Parameters: Multi-Function Terminals.....	266
H1: Multi-Function Digital Inputs.....	266
H3: Multi-Function Analog Inputs.....	267
H4: Analog Outputs.....	268
H5: MEMOBUS/Modbus Serial Communication.....	269
B.9 L: Protection Function.....	270
L1: Motor Protection.....	270
L2: Momentary Power Loss Ride-Thru.....	270
L3: Stall Prevention.....	270
L4: Speed Detection.....	271
L5: Fault Restart.....	271
L6: Torque Detection.....	272
L8: Drive Protection.....	272
B.10 n: Special Adjustment.....	273
n1: Hunting Prevention.....	273
n3: High Slip Braking (HSB) and Overexcitation Braking.....	273
B.11 o: Operator-Related Settings.....	274
o1: HOA Keypad Display Selection.....	274
o2: HOA Keypad Functions.....	274
o4: Maintenance Monitor Settings.....	275
B.12 S: Special Application.....	276
S1: Dynamic Noise Control Function.....	276
S2: Sequence Timers.....	276
T: Motor Tuning.....	278
T1: Induction Motor Auto-Tuning.....	278
B.13 U: Monitors.....	280
UB: Bypass Control Monitors.....	280
U1: Operation Status Monitors.....	282
U2: Fault Trace.....	283
U3: Fault History.....	284
U4: Maintenance Monitors.....	285

Table of Contents

U5: PID Monitors	287
B.14 Z: Bypass Parameters.....	289
Z1: Bypass Control System.....	289
Z2: Bypass Control Input/Output.....	293
Z3: Bypass Control Communication.....	294
Z4: Bypass Control Option Boards.....	296
B.15 Defaults by Drive Model.....	298
C. BACNET COMMUNICATIONS	309
C.1 BACnet Configuration.....	310
C.2 Communication Specifications	311
C.3 Connecting to a Network	312
Network Cable Connection.....	312
Wiring Diagram for Multiple Connections	313
Network Termination	313
C.4 BACnet Setup Parameters.....	314
BACnet Serial Communication.....	314
C.5 Bypass Operations by BACnet	317
Observing the Bypass Operation	317
Controlling the Bypass	317
C.6 BACnet Objects Supported	318
Present Value Access	318
Supported Properties of Objects	318
Analog Input Objects	319
Analog Output Objects	319
Analog Value Objects.....	319
Binary Input Objects	320
Binary Output Objects	321
Binary Value Objects.....	321
Device Object.....	323
C.7 Accessing Bypass Parameters and the Enter Command	325
Reading Bypass Parameters.....	325
Writing Bypass Parameters.....	325
Enter Command	325
C.8 Communication Errors	326
C.9 BACnet Protocol Implementation Conformance Statement.....	327
D. MEMOBUS/MODBUS COMMUNICATIONS.....	329
D.1 MEMOBUS/Modbus Configuration	330
D.2 Communication Specifications	331
D.3 Connecting to a Network	332
Network Cable Connection.....	332
Wiring Diagram for Multiple Connections	333
Network Termination	333
D.4 MEMOBUS/Modbus Setup Parameters	334
MEMOBUS/Modbus Serial Communication.....	334
D.5 Bypass Operations by MEMOBUS/Modbus	336
Observing the Bypass Operation	336

Table of Contents

D.6 Communications Timing	337
Command Messages from Master to Bypass	337
Response Messages from Bypass to Master.....	337
D.7 Message Format	338
Message Content	338
Slave Address	338
Function Code	338
Data.....	338
Error Check	338
D.8 Message Examples	340
Reading Drive MEMOBUS/Modbus Register Contents	340
Loopback Test.....	340
Writing to Multiple Registers.....	341
D.9 MEMOBUS/Modbus Data Table	342
Command Data	342
Monitor Data.....	343
Broadcast Messages.....	352
Fault Trace Contents.....	352
Bypass Fault Codes	354
Alarm Register Contents	354
D.10 Enter Command	355
Enter Command Behavior	355
D.11 Communication Errors	356
MEMOBUS/Modbus Error Codes.....	356
Slave Not Responding.....	356
E. STANDARDS COMPLIANCE	357
E.1 Section Safety	358
E.2 European Standards	360
CE Low Voltage Directive Compliance.....	360
EMC Guidelines Compliance	360
E.3 UL/cUL Standards	361
UL Standards Compliance	361
F. APOGEE FLN NETWORK PROTOCOL	363
F.1 APOGEE FLN Set-Up	364
Bypass Parameter Settings for APOGEE FLN Communications.....	364
F.2 Connecting to a Network	365
Network Cable Connection.....	365
Wiring Diagram for Multiple Connections	366
Network Termination	366
Recommended Cable.....	366
F.3 Slope and Intercept Conversion	367
Drive Controlled Feedback.....	367
Field Panel Controlled Feedback	367
Other Functionality	368
F.4 APOGEE FLN Point List Summary	369
F.5 Cable Loss Configuration and Behavior	373

Table of Contents

Drive Behavior at Loss of Communication	373
Apogee FLN Points	373
F.6 Mailbox Function	375
Mailbox Function Points	375
F.7 Fault Codes	376
Communications Fault.....	376
Bypass Faults–Apogee FLN Configuration	376
G. METASYS N2 NETWORK PROTOCOL	379
G.1 N2 Specifications and Configuration.....	380
G.2 Connecting to a Network	381
Network Cable Connection.....	381
Wiring Diagram for Multiple Connections	382
Network Termination	382
G.3 N2 Setup Parameters	383
N2 Serial Communication.....	383
G.4 Bypass Operations by N2	385
Observing the Bypass Operation	385
Controlling the Bypass	385
G.5 Communications Timing.....	389
Command Messages from Master to Bypass	389
Response Messages from Bypass to Master.....	389
G.6 Metasys N2 Point Database.....	390
Metasys N2 Analog Input (AI) Summary	390
Metasys N2 Analog Output (AO) Summary	391
Metasys N2 Binary Input (BI) Summary	391
Metasys N2 Binary Output (BO) Summary	392
G.7 Mailbox Function	393
Reading Drive Parameters	393
Writing Drive Parameters	393
H. QUICK REFERENCE SHEET	395
H.1 P1000 Bypass and Motor Specifications	396
P1000 Bypass Specifications	396
Motor Specifications	396
H.2 Basic Parameter Settings	397
Quick Setting Parameters	397
Motor Setup.....	397
Multi-Function Digital Inputs	397
Analog Inputs	397
Multi-Function Digital Outputs	398
Monitor Outputs.....	398
H.3 User Setting Table.....	399
INDEX	405

Table of Contents

This Page Intentionally Blank

Preface & General Safety

This section provides safety messages pertinent to this product that, if not heeded, may result in fatality, personal injury, or equipment damage. Yaskawa is not responsible for the consequences of ignoring these instructions.

i.1	PREFACE.....	14
i.2	GENERAL SAFETY.....	16

i.1 Preface

i.1 Preface

Yaskawa manufactures products used as components in a wide variety of industrial systems and equipment. The selection and application of Yaskawa products remain the responsibility of the equipment manufacturer or end user. Yaskawa accepts no responsibility for the way its products are incorporated into the final system design. Under no circumstances should any Yaskawa product be incorporated into any product or design as the exclusive or sole safety control. Without exception, all controls should be designed to detect faults dynamically and fail safely under all circumstances. All systems or equipment designed to incorporate a product manufactured by Yaskawa must be supplied to the end user with appropriate warnings and instructions as to the safe use and operation of that part. Any warnings provided by Yaskawa must be promptly provided to the end user. Yaskawa offers an express warranty only as to the quality of its products in conforming to standards and specifications published in the Yaskawa manual. **NO OTHER WARRANTY, EXPRESS OR IMPLIED, IS OFFERED.** Yaskawa assumes no liability for any personal injury, property damage, losses, or claims arising from misapplication of its products.

This manual is designed to ensure correct and suitable application of the P1000 Bypass. Read this manual before attempting to install, operate, maintain, or inspect the bypass unit and keep it in a safe, convenient location for future reference. Be sure you understand all precautions and safety information before attempting application.

◆ Product Description

The P1000 Bypass provides a means of bypassing the drive while allowing the motor to operate at full speed, directly from the AC line. It incorporates an AC Drive and a three-contactor bypass arrangement in a single UL listed enclosure. The two electrically interlocked IEC rated drive output and bypass contactors isolate the drive from the load when operating in Bypass mode. An IEC rated drive input contactor also isolates the drive from the line when operating in Bypass mode.

Control logic provides industry standard Hand/Off/Auto functions, BAS Interlock, and safety circuit interlocks in both Drive and Bypass operating modes.

Bypass components include: a fused 120 Vac control circuit transformer, drive input fuses, motor overload, and an HOA keypad with LCD display.

The P1000 drive, a component of the P1000 Bypass package, is a pulse width modulated drive for three-phase AC induction motors. This type of drive is also known as an adjustable frequency drive, variable frequency drive, AC Drive, AFD, ASD, VFD, and inverter.

The drive is a variable torque AC drive, designed specifically for fans, blowers, and pumps.

The P1000 Bypass has BACnet and Modbus® embedded communications.

The LCD keypad/operator is equipped with Hand/Off/Auto functions. Optional DriveWizard software allows upload/download, as well as graphing and monitoring of drive parameters from a PC for ease of drive management.

Built-in PI control eliminates the need for closed loop output signals from a building automation system. It includes feedback display, inverse, square root and differential control functions, and maintains setpoint for closed loop control of fans and pumps for pressure, flow, or temperature regulation. An additional independent PI control is also provided for external devices.

◆ Applicable Documentation

The following manuals are available for the P1000 Bypass:

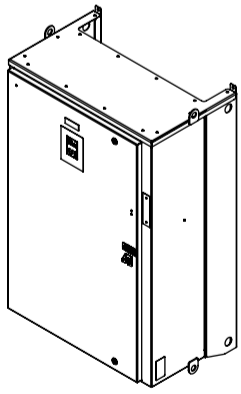
	P1000 Bypass Technical Manual (SIEPYAIP1B01)
	Read this manual first. This manual is packaged together with the product and contains basic information required to install and wire the bypass. It also gives detailed information on fault diagnostics, parameter settings, and BACnet specifications. The purpose of this manual is to prepare the P1000 Bypass for a trial run with an application and for basic operation. This manual is also available for download on the Yaskawa documentation website, www.yaskawa.com .
	P1000-Series AC Drive Quick Start Guide (TOEPYAIP1U01)
	This manual contains basic information required to install and wire the drive. It also gives detailed information on fault diagnostics, parameter settings, and BACnet specifications. The purpose of this manual is to prepare the drive for a trial run with an application and for basic operation. This manual is available for download on the Yaskawa documentation website, www.yaskawa.com .
	P1000-Series AC Drive Technical Manual (SIEPYAIP1U01)
	This manual provides detailed information on parameter settings, drive functions, maintenance, and MEMOBUS/Modbus specifications. Use this manual to expand drive functionality. This manual is available for download on the Yaskawa documentation website, www.yaskawa.com .

◆ Symbols

Note: Indicates a supplement or precaution that does not cause drive damage.



Indicates a term or definition used in this manual.

◆ Terms and Abbreviations



- **Bypass:** Yaskawa P1000 Bypass
- **Drive:** Yaskawa P1000-Series Drive
- **BCD:** Binary Coded Decimal
- **H:** Hexadecimal Number Format
- **IGBT:** Insulated Gate Bipolar Transistor
- **kbps:** Kilobits per Second
- **MAC:** Media Access Control
- **Mbps:** Megabits per Second
- **PCB:** Printer Circuit Board
- **r/min:** Revolutions per Minute
- **V/f:** V/f Control

◆ Trademarks

- APOGEE™ FLN, trademark of Siemens Building Technologies, Inc.
- BACnet is a trademark of the American Society of Heating, Refrigerating, and Air-Conditioning Engineers (ASHRAE).
- CANopen is a trademark of CAN in Automation (CiA).
- CC-Link is a trademark of CC-Link Partner Association (CLPA).
- CompoNet is a trademark of Open DeviceNet Vendor Association, Inc. (ODVA).
- EtherCAT is a trademark of Beckhoff Automation GmbH, Germany.
- EtherNet/IP is a trademark of Open DeviceNet Vendor Association, Inc. (ODVA).
- LONWORKS®, trademark of Echelon Corporation
- MECHATROLINK-I/MECHATROLINK-II are trademarks of MECHATROLINK Members Association (MMA).
- Metasys®, trademark of Johnson Controls Inc.
- Modbus®, trademark of Schneider Automation, Inc.
- PROFNET is a trademark of PROFIBUS International (PI).
- Other companies and product names mentioned in this manual are trademarks of those companies.

i.2 General Safety

◆ Supplemental Safety Information

General Precautions

- The diagrams in this manual may be indicated without covers or safety shields to show details. Replace the covers or shields before operating the drive and run the drive according to the instructions described in this manual.
- Any illustrations, photographs, or examples used in this manual are provided as examples only and may not apply to all products to which this manual is applicable.
- The products and specifications described in this manual or the content and presentation of the manual may be changed without notice to improve the product and/or the manual.
- When ordering a new copy of the manual due to damage or loss, contact your Yaskawa representative or the nearest Yaskawa sales office and provide the manual number shown on the front cover.
- If nameplate becomes worn or damaged, order a replacement from your Yaskawa representative or the nearest Yaskawa sales office.

⚠ WARNING

Read and understand this manual before installing, operating or servicing this bypass. The bypass must be installed according to this manual and local codes.

The following conventions are used to indicate safety messages in this manual. Failure to heed these messages could result in serious or fatal injury or damage to the products or to related equipment and systems.

⚠ DANGER

Indicates a hazardous situation, which, if not avoided, will result in death or serious injury.

⚠ WARNING

Indicates a hazardous situation, which, if not avoided, could result in death or serious injury.

WARNING! may also be indicated by a bold key word embedded in the text followed by an italicized safety message.

⚠ CAUTION

Indicates a hazardous situation, which, if not avoided, could result in minor or moderate injury.

CAUTION! may also be indicated by a bold key word embedded in the text followed by an italicized safety message.

NOTICE

Indicates a property damage message.

NOTICE: may also be indicated by a bold key word embedded in the text followed by an italicized safety message.

◆ Safety Messages

DANGER

Heed the safety messages in this manual.

Failure to comply will result in death or serious injury.

The operating company is responsible for any injuries or equipment damage resulting from failure to heed the warnings in this manual.

Electrical Shock Hazard

Before servicing, disconnect all power to the equipment.

The internal capacitor remains charged even after the power supply is turned off. The charge indicator LED will extinguish when the DC bus voltage is below 50 Vdc. To prevent electric shock, wait for at least the time specified on the warning label, once all indicators are OFF, measure for unsafe voltages to confirm the drive is safe prior to servicing.

Failure to comply will result in death or serious injury.

WARNING

Sudden Movement Hazard

System may start unexpectedly upon application of power, resulting in death or serious injury.

Clear all personnel from the drive, motor and machine area before applying power. Secure covers, couplings, shaft keys and machine loads before applying power to the drive.

Arc Flash Hazard

It is possible that there is more than one source of power for equipment.

Obey the requirements for Electrical Safety in the Workplace and local codes for safe work procedures and applicable personal protective equipment (PPE). Failure to obey can cause serious injury or death.

Electrical Shock Hazard

Do not attempt to modify or alter the drive in any way not explained in this manual.

Failure to comply could result in death or serious injury.

Yaskawa is not responsible for any modification of the product made by the user. This product must not be modified.

Do not allow unqualified personnel to use equipment.

Failure to comply could result in death or serious injury.

Maintenance, inspection, and replacement of parts must be performed only by authorized personnel familiar with installation, adjustment and maintenance of AC drives.

Do not remove covers or touch circuit boards while the power is on.

Failure to comply could result in death or serious injury.

Make sure the protective earthing conductor complies with technical standards and local safety regulations.

Because the leakage current exceeds 3.5 mA in models 4A0414 and larger, IEC/EN 61800-5-1 states that either the power supply must be automatically disconnected in case of discontinuity of the protective earthing conductor or a protective earthing conductor with a cross-section of at least 10 mm² (Cu) or 16 mm² (Al) must be used. Failure to comply may result in death or serious injury.

Always use appropriate equipment for Ground Fault Circuit Interrupters (GFCIs).

The drive can cause a residual current with a DC component in the protective earthing conductor. Where a residual current operated protective or monitoring device is used for protection in case of direct or indirect contact, always use a type B GFCI according to IEC/EN 60755.

i.2 General Safety

⚠ WARNING

Fire Hazard

Do not use an improper voltage source.

Failure to comply could result in death or serious injury by fire.

Verify that the rated voltage of the drive matches the voltage of the incoming power supply before applying power.

Install according to applicable local codes and this Installation Manual. Failure to comply could result in fire and damage to the drive or injury to personnel.

The Bypass includes branch circuit protection and is suitable for use on a circuit capable of delivering not more than 65,000 RMS symmetrical amperes (100,000 RMS with 100 kA Input Circuit Breaker option (PM) added), 208 Vac maximum and 480 Vac maximum.

Crush Hazard

Do not use this drive in lifting applications without installing external safety circuitry to prevent accidental dropping of the load.

The drive does not possess built-in load drop protection for lifting applications.

Failure to comply could result in death or serious injury from falling loads.

Install electrical and/or mechanical safety circuit mechanisms independent of drive circuitry.

NOTICE

Observe proper electrostatic discharge procedures (ESD) when handling the drive and circuit boards. Failure to comply may result in ESD damage to the drive circuitry.

Do not do a withstand voltage test or use a megohmmeter or megger insulation tester on the drive.

Failure to comply could result in damage to the sensitive devices within the drive.

Do not operate damaged equipment.

Failure to comply could result in further damage to the equipment. Do not connect or operate any equipment with visible damage or missing parts.

If a fuse is blown or a Ground Fault Circuit Interrupter (GFCI) is tripped, check the wiring and the selection of the peripheral devices.

Check for short circuits or ground faults on the secondary side of fuses and GFCIs and check the wiring and the selection of peripheral devices. Remove the cause of the problem and then turn the power supply off and on again. If the cause cannot be identified, do not turn on the power supply or attempt to operate the equipment.

Do not restart the drive immediately operate the peripheral devices if a fuse is blown or a GFCI is tripped.

Check the wiring and the selection of peripheral devices to identify the cause. Contact Yaskawa or a Yaskawa representative before restarting the drive or the peripheral devices if the cause cannot be identified.

Do not expose the drive to halogen group disinfectants.

Failure to comply may cause damage to the electrical components in the drive.

Do not pack the drive in wooden materials that have been fumigated or sterilized. Do not sterilize the entire package after the product is packed.

◆ General Application Precautions

■ Selection

Installing a Reactor

Use an AC reactor or DC link choke in the following situations:

- to suppress harmonic current.
- to smooth peak current that results from capacitor switching.
- when the power supply is above 600 kVA.

- when the drive is running from a power supply system with thyristor converters.

Note: A DC link choke is built in to models B052 to B590 and D088 to D396.

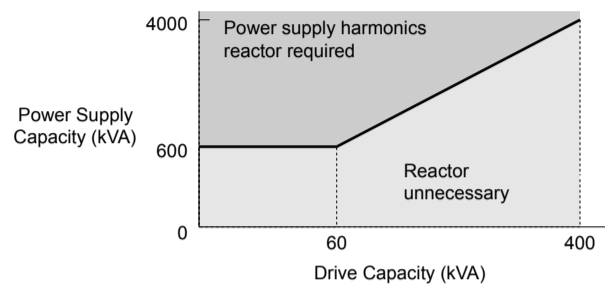

Figure i.1 Installing a Reactor

Drive Capacity

For specialized motors, make sure that the motor rated current is less than the rated output current for the drive.

When running more than one motor in parallel from a single drive, the capacity of the drive should be larger than [total motor rated current \times 1.1].

Starting Torque

The overload rating for the drive determines the starting and accelerating characteristics of the motor. Expect lower torque than when running from line power. To achieve a higher starting torque, use a larger drive or a drive and motor with larger capacity.

Emergency Stop

During a drive fault condition, the output shuts off but the motor does not stop immediately. A mechanical brake may be required when it is necessary to stop the motor faster than the ability of the Fast Stop function of the drive.

Options

NOTICE: The B1, B2, \ominus , $\oplus 1$, $\oplus 2$, and $\oplus 3$ terminals are used to connect optional drive-specific compatible devices only. Connecting non-Yaskawa-approved devices to these terminals may damage the drive.

Repetitive Starting/Stopping

Laundry machines, punching presses, and other applications with frequent starts and stops often approach 150% of their rated output current values. Heat stress generated from repetitive high current will shorten the life span of the IGBTs.

Yaskawa recommends lowering the carrier frequency, particularly when audible noise is not a concern. It is beneficial to reduce the load, increase the acceleration and deceleration times, or switch to a larger drive to help keep peak current levels under 150%. Be sure to check the peak current levels when starting and stopping repeatedly during the initial test run, and make adjustments accordingly.

■ Installation

Enclosure Panels

Keep the drive in a clean environment by installing the drive in an enclosure panel or selecting an installation area free of airborne dust, lint, and oil mist. Be sure to leave the required space between drives to provide for cooling, and take proper measures so the ambient temperature remains within allowable limits and keep flammable materials away from the drive. Yaskawa offers protective designs for drives that must be used in areas subjected to oil mist and excessive vibration. Contact Yaskawa or a Yaskawa representative for details.

Installation Direction

NOTICE: Install the drive upright as specified in the manual. Refer to the Mechanical Installation section for more information on installation. Failure to comply may damage the drive due to improper cooling.

■ Settings

Upper Limits

NOTICE: The drive is capable of running the motor up to 400 Hz. Be sure to set the upper limit for the frequency of the drive to prevent the possible danger of accidentally operating equipment at higher than rated speed. The default setting for the maximum output frequency is 60 Hz.

DC Injection Braking

NOTICE: Excessive current during DC Injection Braking and excessive duration of DC Injection Braking can cause motor overheat.

i.2 General Safety

Acceleration/Deceleration Times

Acceleration and deceleration times are affected by the amount of torque generated by the motor, the load torque, and the moment of inertia. Set a longer accel/decel time when Stall Prevention is enabled. The accel/decel times are lengthened for as long as the Stall Prevention function is in operation. Install one of the available braking options or increase the capacity of the drive for faster acceleration and deceleration.

■ General Handling

Wiring Check

NOTICE: Do not connect power supply lines to output terminals U/T1, V/T2, or W/T3. Failure to comply will destroy the drive. Be sure to perform a final check of all sequence wiring and other connections before turning on the power and also check for short circuits on the control terminals, which may damage the drive.

Inspection and Maintenance

WARNING! Electrical Shock Hazard. Capacitors in the drive do not immediately discharge after shutting off the power. Wait for at least the amount of time specified on the drive before touching any components after shutting off the power. Failure to comply may cause injury to personnel from electrical shock.

Transporting the Drive

NOTICE: Never steam clean the drive. During transport, keep the drive from coming into contact with salts, fluorine, bromine, phthalate ester, and other such harmful chemicals.

◆ Motor Application Precautions

Insulation Tolerance

NOTICE: Consider motor voltage tolerance levels and motor insulation in applications with an input voltage of over 480 V or particularly long wiring distances.

High-Speed Operation

NOTICE: Problems may occur with the motor bearings and dynamic balance of the machine when operating a motor beyond its rated speed. Contact the motor or machine manufacturer.

Torque Characteristics

Torque characteristics differ compared to operating the motor directly from line power. The user should have a full understanding of the load torque characteristics for the application.

Vibration and Shock

The drive allows selection of high carrier PWM control and low carrier PWM. Selecting high carrier PWM can help reduce motor oscillation.

Take particular caution when adding a variable speed drive to an application running a motor from line power at a constant speed. If resonance occurs, install shock-absorbing isolation mounts around the base of the motor and enable the Jump frequency selection to prevent continuous operation in the resonant frequency range.

Audible Noise

The audible noise of the motor varies based on the carrier frequency setting. However, drive current derating may be required. When using a high carrier frequency, audible noise from the motor is comparable to the motor noise generated when running from line power.

Specialized Motors

Multi-Pole Motor

The rated current of a multi-pole motor differs from that of a standard motor, so be sure to check the maximum current when selecting a drive. Always stop the motor before switching between the number of motor poles. The motor will coast to stop if a regenerative overvoltage (ov) fault occurs or if overcurrent (oC) protection is triggered.

Submersible Motor

The rated current of a submersible motor is greater than that of a standard motor, so select the drive accordingly. Use a motor cable large enough to avoid decreasing the maximum torque level from voltage drop caused by a long motor cable.

Explosion-Proof Motor

The motor and the drive must be tested together to be certified as explosion-proof. The drive is not designed for explosion-proof areas.

Geared Motor

Make sure that the gear and the lubricant are rated for the desired speed range to avoid gear damage when operating at low speeds or very high speeds. Consult with the manufacturer for applications that require operation outside the rated speed range of the motor or gear box.

Single-Phase Motor

Variable speed drives are not designed to operate with single phase motors. Using capacitors to start the motor causes a high-frequency current to flow to the capacitors and can damage the capacitors. A split-phase start or a repulsion start can burn out the starter coils because the internal centrifugal switch is not activated. The drive is for use with three-phase motors only.

Motor with Brake

Take caution when using the drive to operate a motor with a built-in holding brake. If the brake is connected to the output side of the drive, it may not release at start due to low voltage levels, so be sure to install a separate power supply for the motor brake. Note that motors with built-in brakes tend to generate a fair amount of noise when running at low speeds.

i.2 General Safety

◆ Drive Label Warning Example

Always heed the warning information listed in *Figure i.2* in the position shown in *Figure i.3*.

⚠ WARNING

⚡ Risk of electric shock.

- Read manual before installing.
- Wait 5 minutes for capacitor discharge after disconnecting power supply.
- To conform to **CE** requirements, make sure to ground the supply neutral for 400V class.
- After opening the manual switch between the drive and motor, please wait 5 minutes before inspecting, performing maintenance or wiring the drive.

🔥 Hot surfaces

- Top and Side surfaces may become hot. Do not touch.

Figure i.2 Warning Information Example

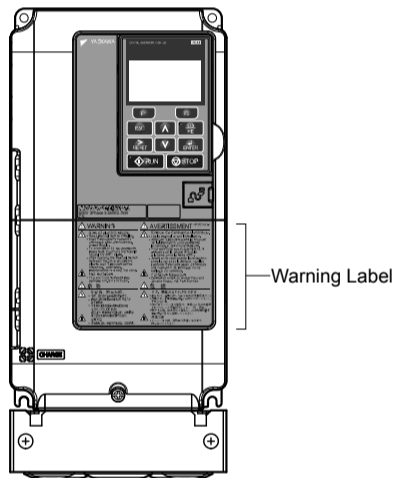

Figure i.3 Warning Information Position

◆ **Bypass Label Warning Example**

Always heed the warning information listed in *Figure i.4* and *Figure i.5* affixed to the bypass cabinet door.

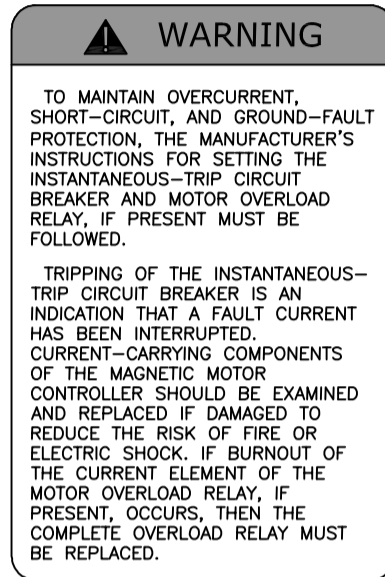

Figure i.4 Warning Information Example A

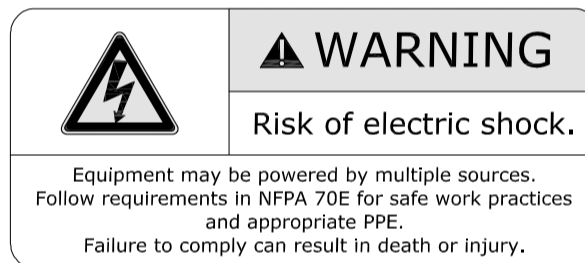

Figure i.5 Warning Information Example B

i.2 General Safety

◆ Warranty Information

■ Scope of Warranty

Inspections

Customers are responsible for periodic inspections of the drive. Upon request, a Yaskawa representative will inspect the drive for a fee. If the Yaskawa representative finds the drive to be defective due to Yaskawa workmanship or materials and the defect occurs during the warranty period, this inspection fee will be waived and the problem remedied free of charge.

Repairs

If a Yaskawa product is found to be defective due to Yaskawa workmanship or materials and the defect occurs during the warranty period, Yaskawa will provide a replacement, repair the defective product, and provide shipping to and from the site free of charge.

However, if the Yaskawa Authorized Service Center determines that the problem with the drive is not due to defective workmanship or materials, the customer will be responsible for the cost of any necessary repairs. Some problems that are outside the scope of this warranty are:

Problems due to improper maintenance or handling, carelessness, or other reasons where the customer is determined to be responsible.

Problems due to additions or modifications made to a Yaskawa product without Yaskawa's understanding.

Problems due to the use of a Yaskawa product under conditions that do not meet the recommended specifications.

Problems caused by natural disaster or fire.

After the free warranty period elapses.

Replenishment or replacement of consumables or expendables.

Defective products due to packaging or fumigation.

Other problems not due to defects in Yaskawa workmanship or materials.

Warranty service is only applicable within the country where the product was purchased. However, after-sales service is available for customers outside of the country where the product was purchased for a reasonable fee.

Contact your local Yaskawa representative for more information.

Exceptions

Any inconvenience to the customer or damage to non-Yaskawa products due to Yaskawa's defective products whether within or outside of the warranty period are NOT covered by warranty.

■ Restrictions

The drive is not designed or manufactured for use in devices or systems that may directly affect or threaten human lives or health.

Customers who intend to use the product described in this manual for devices or systems relating to transportation, health care, space aviation, atomic power, electric power, or in underwater applications must first contact Yaskawa or a Yaskawa representative.

WARNING! *Injury to Personnel. This product has been manufactured under strict quality-control guidelines. However, if this product is to be installed in any location where failure of this product could involve or result in a life-and-death situation or loss of human life or in a facility where failure may cause a serious accident or physical injury, safety devices must be installed to minimize the likelihood of any accident.*

1

Receiving

This chapter explains how to inspect the P1000 Bypass upon receipt, and gives an overview of the different enclosure types and components.

1.1	SECTION SAFETY.....	26
1.2	GENERAL DESCRIPTION.....	27
1.3	MODEL NUMBERS AND NAMEPLATE CHECKS.....	28
1.4	BYPASS COMPONENT DESCRIPTIONS.....	32

1.1 Section Safety

1.1 Section Safety

NOTICE

Observe proper electrostatic discharge procedures (ESD) when handling the drive and circuit boards.

Failure to comply may result in ESD damage to the drive circuitry.

A motor connected to a PWM drive may operate at a higher temperature than a utility-fed motor and the operating speed range may reduce motor cooling capacity.

Ensure that the motor is suitable for drive duty and/or the motor service factor is adequate to accommodate the additional heating with the intended operating conditions.

1.2 General Description

◆ Control Mode Details

Table 1.1 gives an overview of the various features associated with the P1000 Bypass.

Table 1.1 Control Mode Features

Motor Type	Induction Motors	Comments
Control Mode	V/f	–
Basic Description	V/f control	–
Type of Applications	Motor Type	IM
	Multi Motor	YES
	Motor data unknown	YES
	High Speed Accuracy	–
Control Characteristics	Speed Control Range	1:40 May fluctuate with characteristics and motor temperature.
	Speed Accuracy	±2 to 3% Speed deviation when operating at constant speed may fluctuate with characteristics and motor temperature.
	Speed Response	3 Hz (approx.) Max. frequency of a speed reference signal that the drive can follow may fluctuate with characteristics and motor temperature.
	Starting Torque	140% at 3 Hz Starting torque may fluctuate with characteristics and motor temperature. Performance may differ by capacity.
Application-Specific	Speed Search	YES Bi-directional speed detection of a coasting motor to restart it without stopping.
	Energy-Saving Control	YES Saves energy by always operating the motor at its maximum efficiency.
	High Slip Braking	YES Increases motor loss to allow for faster deceleration. Effectiveness may vary based on motor characteristics.
	Kinetic Energy Buffering	YES Decelerates the drive to allow it to ride through a momentary power loss and continue operation.
	Overexcitation Deceleration	YES Provides fast deceleration without using a braking resistor.
	Overvoltage Suppression	YES Prevents overvoltage by increasing speed during regeneration.

1.3 Model Numbers and Nameplate Checks

1.3 Model Numbers and Nameplate Checks

Please perform the following tasks after receiving the P1000 Bypass

- Inspect the P1000 Bypass for damage.

If the P1000 Bypass appears damaged upon receipt, contact the shipper immediately.

- Verify receipt of the correct model by checking the information on the nameplate.
- If you have received the wrong model or the P1000 Bypass does not function properly, contact your supplier.

If you find any irregularities in the above items, contact the shipping company, the distributor or representative you purchased the P1000 Bypass from or your Yaskawa office immediately. The P1000 Bypass is thoroughly tested at the factory. Any damages or shortages evident when the equipment is received must be reported immediately to the commercial carrier that transported the material. Shipping damage is not covered by the Yaskawa warranty. After unpacking and inspecting for damage, verify that internal wire connections have not come loose during shipment by spot checking wire terminations with a screwdriver or the appropriate tool. P1000 Bypass storage must be in a clean and dry location. Maintain the factory packaging and provide covering as needed to protect the P1000 Bypass from construction site dirt, water, debris and traffic prior to and during construction.

◆ Drive Nameplate

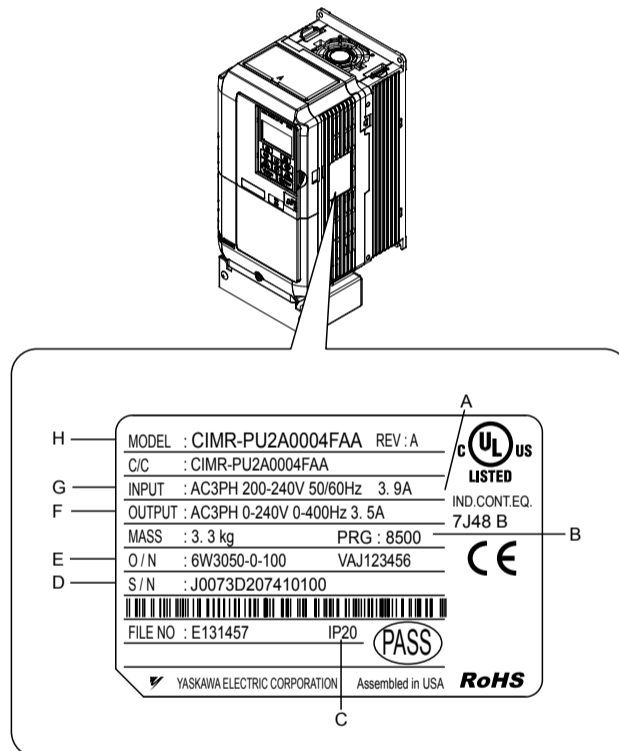

A – Normal Duty Amps
 B – Software version
 C – Enclosure type
 D – Serial number

E – Lot number
 F – Output specifications
 G – Input specifications
 H – AC drive model

Figure 1.1 Drive Nameplate Information Example

1.3 Model Numbers and Nameplate Checks

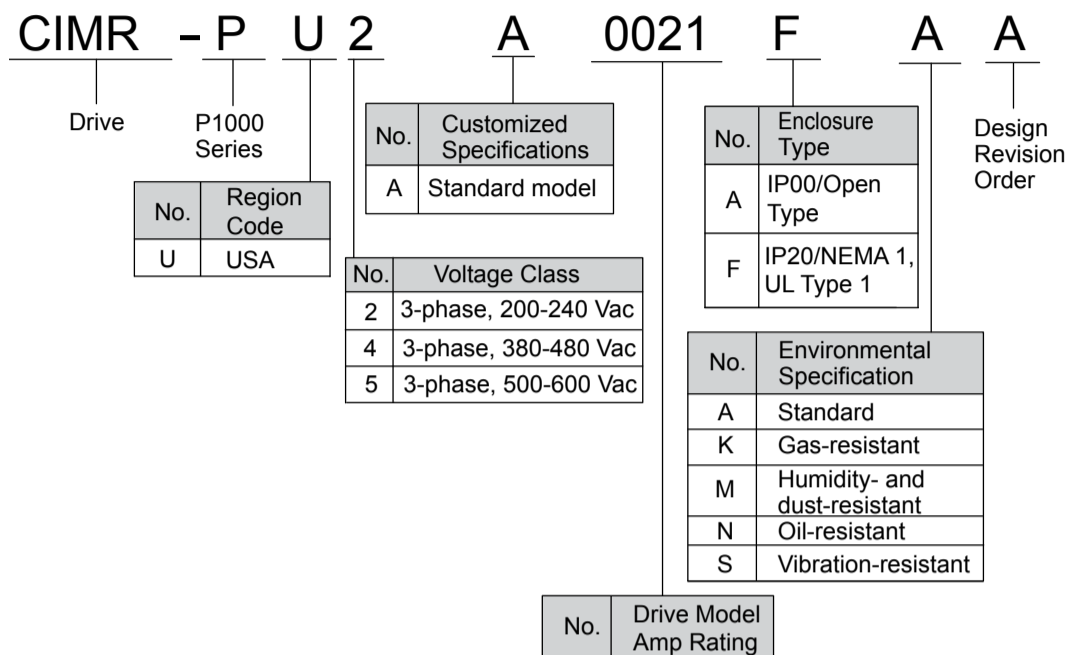

◆ Bypass Nameplate

The nameplate is located on the inside of the P1000 Bypass enclosure door. The nameplate shown below is an example for a standard P1000 Bypass.

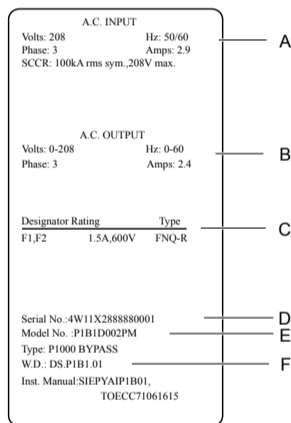

- A – Input specifications**
- B – Output specifications**
- C – Replacement fuse specifications**
- D – Serial number**
- E – Bypass model number**
- F – Schematic document number (document included in packaging)**

Figure 1.2 Bypass Nameplate Information Example

Receiving

1

1.3 Model Numbers and Nameplate Checks

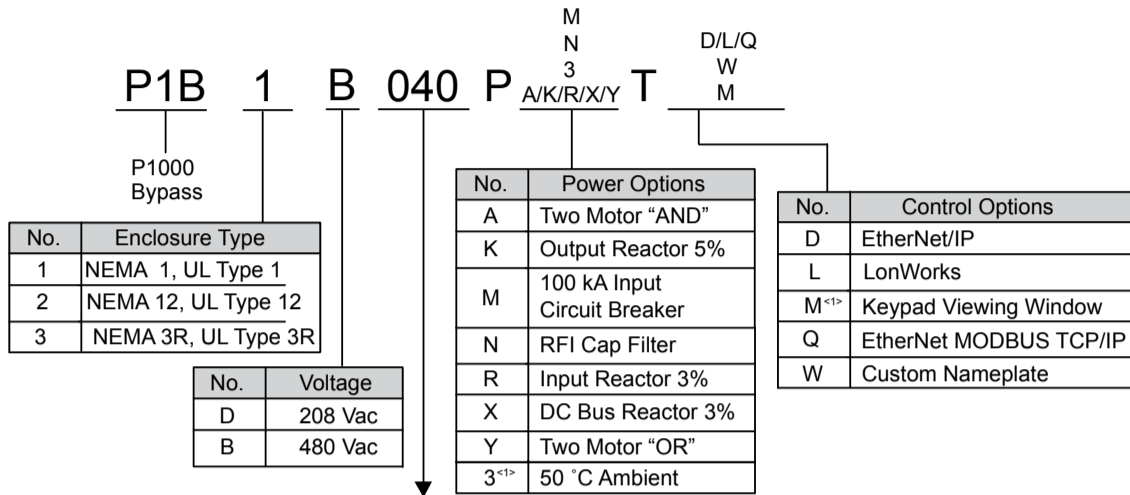

Refer to the following table

<1> Available for NEMA 3R, UL Type 3R enclosures only.

■ Bypass Models, Drive Models, and Capacities

Bypass Model	HP	Input (A)					Output (A)	Drive Model
		P1B1 Models without Power Options	P1B1 Models with PY Option	P1B2 and P1B3 Models without Power Options	P1B2 Models with PY Option	P1B3 Models with P3 and PY Options		
208 Vac Bypass Drive								
D002	0.5	2.7	2.7	2.7	2.7	4.6	2.4	2A0004
D003	0.75	3.9	3.9	3.9	4.6	5.8	3.5	
D004	1	5.6	5.6	5.6	6.3	7.5	4.6	2A0006
D007	2	8.3	8.3	8.3	9.0	10.2	7.5	2A0008
D010	3	12.3	12.3	12.3	13.0	14.2	10.6	2A0012
D016	5	17.7	17.7	17.7	18.4	19.6	16.7	2A0018
D024	7.5	29.8	30.6	29.8	30.6	31.5	24.2	2A0030
D030	10	40.0	40.8	40.0	40.8	41.7	30.8	2A0040
D046	15	56.1	56.8	56.8	56.8	57.8	46.2	2A0056
D059	20	68.9	69.6	69.6	69.6	70.6	59.4	2A0069
D074	25	89.4	90.1	90.1	90.1	90.3	74.8	2A0081
D088	30	89.5	89.5	89.5	89.5	92.4	88.0	2A0110
D114	40	113.1	113.1	113.1	113.1	116.0	114.0	2A0138
D143	50	140.2	140.2	140.2	140.2	142.4	143.0	2A0169
D169	60	165.4	165.4	165.4	165.4	167.6	169.0	
D211	75	201.4	201.4	201.4	201.4	203.6	211.0	2A0211
D273	100	284.9	284.9	284.9	284.9	287.1	273.0	2A0312
D343	125	376.8	376.8	376.8	376.8	380.2	343.0	2A0360
D396	150	450.9	450.9	450.9	450.9	454.2	396.0	2A0415
480 Vac Bypass Drive								
B001	0.75	1.6	1.6	1.6	2.3	2.4	1.6	4A0002
B002	1	2.1	2.1	2.1	2.8	2.9	2.1	
B003	2	3.6	3.6	3.6	4.3	4.4	3.4	4A0004
B004	3	5.2	5.2	5.2	6.0	6.1	4.8	4A0005
B007	5	8.1	8.1	8.1	8.8	9.0	7.6	4A0009
B011	7.5	13.9	13.9	13.9	14.6	14.7	11.0	4A0011

1.3 Model Numbers and Nameplate Checks

Bypass Model	HP	Input (A)					Output (A)	Drive Model
		P1B1 Models without Power Options	P1B1 Models with PY Option	P1B2 and P1B3 Models without Power Options	P1B2 Models with PY Option	P1B3 Models with P3 and PY Options		
B014	10	16.0	16.7	16.0	16.7	16.7	14.0	4A0018
B021	15	21.9	22.6	21.9	22.6	22.6	21.0	4A0023
B027	20	33.1	33.8	33.8	33.8	33.8	27.0	4A0031
B034	25	39.4	40.1	40.1	40.1	40.1	34.0	4A0038
B040	30	47.3	48.0	48.0	48.0	48.0	40.0	4A0044
B052	40	52.7	52.7	52.7	52.7	54.0	52.0	4A0058
B065	50	65.5	65.5	64.8	64.8	66.5	65.0	4A0072
B077	60	76.7	76.7	76.0	76.7	77.6	77.0	4A0088
B096	75	99.3	99.3	98.6	99.3	100.2	96.0	4A0103
B124	100	128.1	128.1	127.4	128.1	129.1	124.0	4A0139
B156	125	162.2	162.2	162.2	162.2	163.1	156.0	4A0165
B180	150	180.6	180.6	180.6	180.6	181.5	180.0	4A0208
B240	200	239.5	239.5	239.5	239.5	241.0	240.0	4A0250
B302	250	290.1	290.1	290.1	290.1	291.6	302.0	4A0362
B361	300	346.5	346.5	346.5	347.4	347.9	361.0	
B414	350	411.4	411.4	412.4	413.6	412.9	414.0	4A0414
B477	400	433.1	433.1	433.1	434.3	435.2	477.0	4A0515
B515	450	467.4	467.4	467.4	468.6	469.5	515.0	
B590	500	576.7	576.7	576.7	577.9	578.8	590.0	4A0675

Receiving

1

◆ Bypass Enclosures

All P1000 Bypass units are intended for non-hazardous locations.

- P1000 Bypass units in NEMA 1, UL Type 1 enclosures are constructed for indoor use to provide a degree of protection against incidental contact with the enclosed electrical equipment and falling dust or dirt.
- P1000 Bypass units in NEMA 12, UL Type 12 enclosures are constructed for indoor use to provide a degree of protection against incidental contact with the enclosed electrical equipment, falling dust or dirt, circulating dust, dirt, lint, fibers and flyings, and dripping at light splashing of liquids.
- P1000 Bypass units in NEMA 3, UL Type 3 enclosures are constructed for indoor or outdoor use to provide a degree of protection against incidental contact with the enclosed electrical equipment, falling dust or dirt, rain, sleet, snow, and wind-blown dust or dirt. NEMA 3, UL Type 3 enclosures will be undamaged by external formation of ice on the enclosure.

◆ Bypass Product Options

Refer to *Bypass Options on page 253* for details on available bypass product configuration options.

1.4 Bypass Component Descriptions

1.4 Bypass Component Descriptions

◆ Bypass Front Control Panel

The external appearance and component names of the P1000 Bypass are shown in *Figure 1.3*.

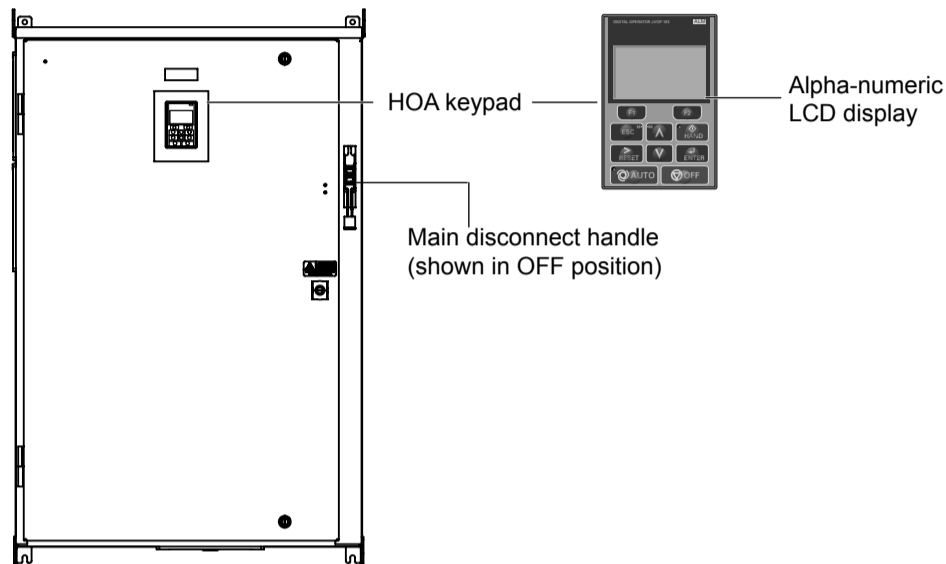

Figure 1.3 P1000 Bypass Control Panel with Keypad Operator Controls

Refer to *Using the HOA Keypad on page 59* for details on the HOA keypad.

■ Input Circuit Breaker

Electrically located on the input power side of the bypass, the input circuit breaker and its main disconnect handle provide a means of disconnecting the bypass from line power for equipment maintenance. The handle must be in the OFF position to open the bypass enclosure door. The handle can be locked in the OFF position using a padlock.

■ Contactors

The P1000 Bypass is a 3-contactor bypass circuit employing IEC rated contactors in an electrically interlocked arrangement to allow mutually exclusive operation in Drive or Bypass modes.

The control logic and “soft start” characteristic of the drive limit the drive input and output contactors to motor FLA current or less. The bypass contactor is exposed to motor inrush current (LRA) when starting the motor across-the-line and therefore may require a higher current rating than the drive input and output contactors.

■ Overload Relay

The adjustable thermal overload relay (OLR) provides overload protection for the motor in Drive and Bypass operating modes. The bypass three-phase output power connection to the motor is made to the output terminals of the OLR. The OLR is set up in the factory to be a manual reset device, requiring operator attention if an overload trip-out is experienced.

■ Control Power Transformer

A Control Power Transformer (CPT) is provided to power the P1000 Bypass 120 Vac control circuit. The VA capacity is determined by the control circuit and optional functions specified for the unit. The CPT primary is fused in both legs, the secondary is fused when required by NEC (transformer VA and wire size dependent). One side of the transformer secondary is grounded to the bypass enclosure.

■ Electronic Bypass Control Logic

Operating elements such as indicating LEDs, selector buttons, and control logic are incorporated into a PCB assembly to eliminate the potential for loose wires after shipment.

The operating elements are located on PCB A3 and the control logic PCB A2 is mounted to the left-hand side of the enclosure and contains the control circuit field wiring terminal blocks TB1 through TB3.

■ Drive/Bypass Logic Interlocks

The P1000 Bypass 120 Vac logic circuit is interconnected with the drive multi-function digital input terminals and multi-function digital output terminals to allow a single customer interface to control both drive and bypass circuits. These drive terminals are not available for field connections. All field control connections are connected to terminal blocks TB1 through TB3 on control logic PCB A2 and drive control PCB A1.

◆ Front Views

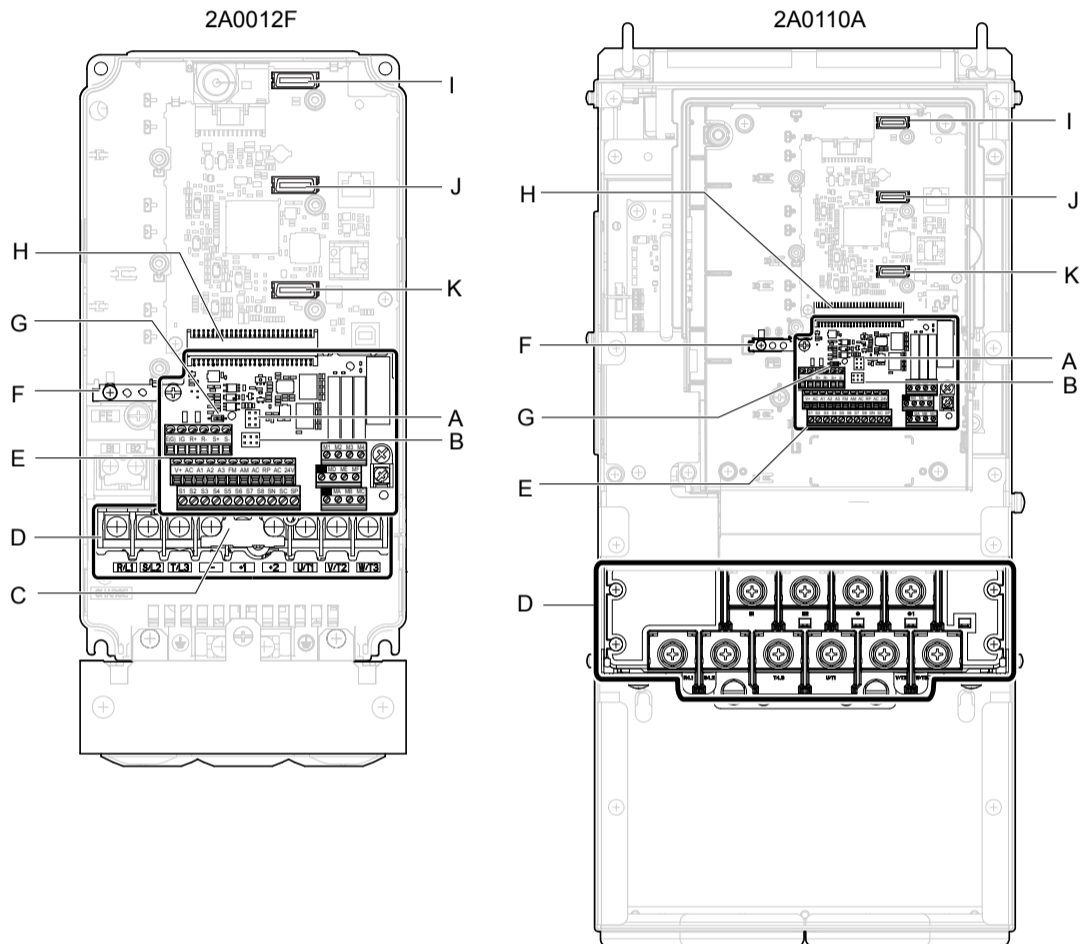

- A – Jumper S5 (Refer to Terminal FM/AM Signal Selection on page 52)
- B – Jumper S1 (Refer to Terminals A1, A2, and A3 Input Signal Selection on page 52)
- C – Protective cover to prevent miswiring
- D – Main circuit terminal (Refer to Wiring the Main Input Circuit on page 45)
- E – Terminal board (Refer to Control Circuit Wiring on page 46)
- F – Ground terminal

- G – DIP switch S2
- H – Terminal board connector
- I – Option card connector (CN5-C)
- J – Option card connector (CN5-B)
- K – Option card connector (CN5-A)

Figure 1.4 Front Views of P1000 Drives

Receiving
1

1.4 Bypass Component Descriptions

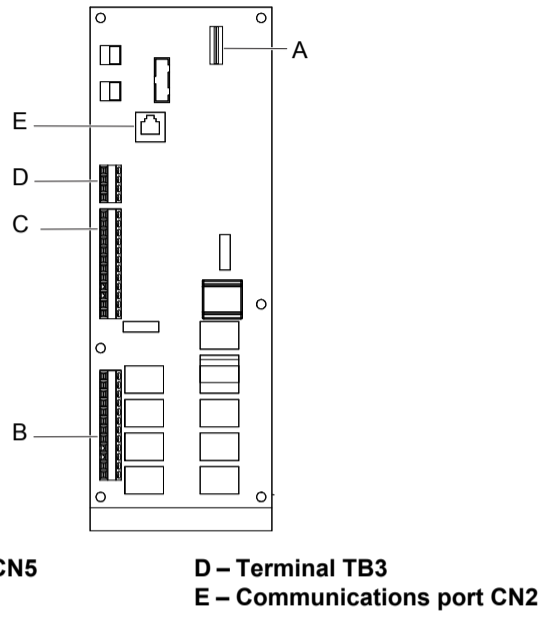

Figure 1.5 Front View of Bypass Control Board

2

Mechanical Installation

This chapter explains how to properly mount and install the P1000 Bypass.

2.1	SECTION SAFETY	36
2.2	MECHANICAL INSTALLATION	38

2.1 Section Safety

2.1 Section Safety

WARNING

Crush Hazard

Use a dedicated lifting device when moving or positioning the drive.

Failure to comply may result in serious injury or death from falling equipment.

Use screws to securely affix the drive front cover, terminal blocks, and other drive components prior to vertical suspension.

Failure to comply may result in serious injury or death from falling equipment.

Do not subject the bypass to vibration or impact greater than 1.96 m/s² (0.2 G) while it is suspended by the cables.

Failure to comply may result in serious injury or death from falling equipment.

Do not attempt to flip the bypass over or leave the drive unattended while it is suspended by the wires.

Failure to comply may result in serious injury or death from falling equipment.

CAUTION

Crush Hazard

Do not carry the bypass by the front cover or the terminal cover.

Failure to comply may result in minor or moderate injury from the main body of the drive falling.

NOTICE

Equipment Hazard

Prevent foreign matter such as metal shavings or wire clippings from falling into the drive or bypass during drive installation and project construction.

Failure to comply could result in damage to the drive and bypass. Place a temporary cover over the top during installation. Be sure to remove the temporary cover before start-up, as the cover will reduce ventilation and cause the unit to overheat.

Observe proper electrostatic discharge (ESD) procedures when handling the bypass and drive.

Failure to comply could result in ESD damage to the drive and bypass circuitry.

Operating the motor in the low-speed range diminishes the cooling effects, increases motor temperature, and may lead to motor damage by overheating.

Reduce the motor torque in the low-speed range whenever using a standard blower cooled motor. If 100% torque is required continuously at low speed, consider using a special drive or vector-control motor. Select a motor that is compatible with the required load torque and operating speed range.

The speed range for continuous operation differs according to the lubrication method and motor manufacturer.

If the motor is to be operated at a speed higher than the rated speed, consult with the manufacturer.

Continuously operating an oil-lubricated motor in the low-speed range may result in burning.

NOTICE

When the input voltage is 480 V or higher or the wiring distance is greater than 100 meters, pay special attention to the motor insulation voltage or use a drive-rated motor with reinforced insulation.

Failure to comply could lead to motor winding failure.

Motor vibration may increase when operating a machine in variable-speed mode, if that machine previously operated at a constant speed.

Install vibration-proof rubber on the motor base or use the frequency jump function to skip a frequency resonating the machine.

The motor may require more acceleration torque with drive operation than with a commercial power supply.

Set a proper V/f pattern by checking the load torque characteristics of the machine to be used with the motor.

The rated input current of submersible motors is higher than the rated input current of standard motors.

Select an appropriate drive according to its rated output current. When the distance between the motor and drive is long, use a cable thick enough to connect the motor to the drive to prevent motor torque reduction.

The current rating for a motor with variable pole pitches differs from a standard motor.

Check the maximum current of the motor before selecting the drive capacity. Only switch motor poles when the motor is stopped. Switching between motor during run will trigger overcurrent protection circuitry or result in overvoltage from regeneration, and the motor will simply coast to stop.

Never lift or move the bypass while the cover is open.

This can damage the bypass components.

2.2 Mechanical Installation

2.2 Mechanical Installation

This section outlines specifications, procedures, and the environment for proper mechanical installation of the drive.

◆ Installation Environment

Install the P1000 Bypass in an environment matching the conditions below to prolong its optimum performance life.

Move the disconnect handle into the OFF position to open the enclosure door for all bypass units. The wall mount units have two full-turn fasteners, CCW to open, that require a flat blade screwdriver to open the enclosure door.

Wall mount units require a minimum 6 inch clearance above and below and a 3 inch clearance to the left to achieve adequate heatsink cooling.

Table 2.1 Installation Environment

Environment	Conditions
Installation Area	Indoors
Ambient Temperature	-10 °C to +40 °C Drive reliability improves in environments without wide temperature fluctuations.
Humidity	95% RH or less and free of condensation
Storage Temperature	-20 to +60 °C
Surrounding Area	Install the bypass in an area free from: <ul style="list-style-type: none">• radioactive materials• combustible materials (e.g., wood)• harmful gases and liquids• excessive vibration• chlorides
Altitude	1000 m or lower, up to 3000 m with derating. <i>Refer to Drive Derating Data on page 251</i> for details.
Vibration	10 to 20 Hz at 3.24 m/s ² (10.6 ft/s ²) 20 to 55 Hz at 2.16 m/s ² (7.1 ft/s ²)
Orientation	Install the bypass vertically to maintain maximum cooling effects.

NOTICE: Avoid placing peripheral devices, transformers, or other electronics near the P1000 Bypass as the noise created can lead to erroneous operation. If such devices must be used in close proximity to the Bypass, take proper steps to shield the bypass from noise.

NOTICE: Prevent foreign matter such as metal shavings and wire clippings from falling into the P1000 Bypass during installation. Failure to comply could result in damage to the bypass. Place a temporary cover over the top of the drive during installation. Remove the temporary cover before bypass start-up, as the cover will reduce ventilation and cause the Bypass to overheat.

3

Electrical Installation

This chapter explains the proper procedures for wiring the control circuit terminals, motor, and power supply.

3.1	SECTION SAFETY.....	40
3.2	STANDARD CONNECTION DIAGRAM.....	42
3.3	MAIN CIRCUIT WIRING.....	43
3.4	CONTROL CIRCUIT WIRING.....	46
3.5	BYPASS AND DRIVE CONTROL I/O CONNECTIONS.....	52
3.6	EXTERNAL INTERLOCK.....	54

3.1 Section Safety

WARNING

Electrical Shock Hazard

Do not connect or disconnect wiring while the power is on.

Failure to comply may result in death or serious injury.

Before servicing, disconnect all power to the equipment. The internal capacitor remains charged even after the power supply is turned off. The charge indicator LED will extinguish when the DC bus voltage is below 50 Vdc. To prevent electric shock, wait for at least the time specified on the warning label, once all indicators are OFF, measure for unsafe voltages to confirm the drive is safe prior to servicing.

Do not operate equipment with covers removed.

Failure to comply could result in death or serious injury.

The diagrams in this section may show drives without covers or safety shields to show details. Be sure to reinstall covers or shields before operating the drives and run the drives according to the instructions described in this manual.

Make sure the protective earthing conductor complies with technical standards and local safety regulations.

Because the leakage current exceeds 3.5 mA, IEC/EN 61800-5-1 states that either the power supply must be automatically disconnected in case of discontinuity of the protective earthing conductor or a protective earthing conductor with a cross-section of at least 10 mm² (Cu) or 16 mm² (Al) must be used. Failure to comply may result in death or serious injury.

Always use appropriate equipment for Ground Fault Circuit Interrupters (GFCIs).

The drive can cause a residual current with a DC component in the protective earthing conductor. Where a residual current operated protective or monitoring device is used for protection in case of direct or indirect contact, always use a type B GFCI according to IEC/EN 60755.

Always ground the motor-side grounding terminal.

Improper equipment grounding could result in death or serious injury by contacting the motor case.

Do not perform work on the drive while wearing loose clothing, jewelry or without eye protection.

Failure to comply could result in death or serious injury.

Remove all metal objects such as watches and rings, secure loose clothing, and wear eye protection before beginning work on the drive.

Do not remove covers or touch circuit boards while the power is on.

Failure to comply could result in death or serious injury.

Do not allow unqualified personnel to perform work on the drive.

Failure to comply could result in death or serious injury.

Installation, maintenance, inspection, and servicing must be performed only by authorized personnel familiar with installation, adjustment, and maintenance of AC drives.

Do not touch any terminals before the capacitors have fully discharged.

Failure to comply could result in death or serious injury.

Before servicing, disconnect all power to the equipment. The internal capacitor remains charged even after the power supply is turned off. The charge indicator LED will extinguish when the DC bus voltage is below 50 Vdc. To prevent electric shock, wait for at least the time specified on the warning label, once all indicators are OFF, measure for unsafe voltages to confirm the drive is safe prior to servicing.

Fire Hazard

Tighten all terminal screws to the specified tightening torque.

Loose electrical connections could result in death or serious injury by fire due to overheating of electrical connections.

Do not use improper combustible materials.

Failure to comply could result in death or serious injury by fire.

Do not install the drive to a combustible surface. Never place combustible materials on the drive.

⚠ WARNING**Do not use an improper voltage source.**

Failure to comply could result in death or serious injury by fire.

Verify that the rated voltage of the drive matches the voltage of the incoming power supply before applying power.

Properly handle the HOA keypad battery.

Improper use of the battery may cause fire by explosion and personal injury.

Correctly install the battery, paying attention to polarity (+/-).

Do not attempt to charge the battery or improperly disassemble the HOA keypad.

NOTICE**Observe proper electrostatic discharge procedures (ESD) when handling the drive and circuit boards.**

Failure to comply may result in ESD damage to the drive circuitry.

Never connect or disconnect the motor from the drive while the drive is outputting voltage.

Improper equipment sequencing could result in damage to the drive.

Do not use unshielded cable for control wiring.

Failure to comply may cause electrical interference resulting in poor system performance. Use shielded, twisted-pair wires and ground the shield to the ground terminal of the drive.

Do not allow unqualified personnel to use the product.

Failure to comply could result in damage to the drive.

Do not modify the or bypass circuitry.

Failure to comply could result in damage to the drive or bypass and will void warranty.

Yaskawa is not responsible for any modification of the product made by the user. This product must not be modified.

Check all the wiring to ensure that all connections are correct after installation.

Failure to comply could result in damage to the drive.

Do not heat or throw the battery into fire.

The battery remains in use even when power to the drive has been shut off. Be sure to also remove the battery in the HOA keypad when the drive will be shut off for long periods of time.

A dead battery left inside the HOA keypad may leak and damage the keypad and drive. Be sure to replace the battery with a new one immediately after the expected lifespan has passed or when the "bAT" error is displayed on the HOA keypad.

Be sure to observe the Perchlorate Best Management Practices (BMPs).

BMPs apply to primary lithium (manganese dioxide) coin batteries sold or distributed in California. Perchlorate Material-special handling may apply, please refer to: www.dtsc.ca.gov/hazardouswaste/perchlorate.

3.2 Standard Connection Diagram

3.2 Standard Connection Diagram

Connect the bypass and peripheral devices as shown in the schematic diagram shipped with the bypass. It is possible to set and run the bypass via the HOA keypad without connecting digital I/O wiring. This section does not discuss drive operation; **Refer to Start-Up Programming & Operation on page 57** for instructions on operating the drive.

WARNING! Fire Hazard. Branch Circuit protection is required to be installed according to applicable local codes and the requirements listed on the P1000 Bypass nameplate. Failure to comply could result in fire and damage to the bypass and drive or injury to personnel. The P1000 Bypass is suitable for use on a circuit capable of delivering not more than 100,000 RMS symmetrical amperes, 208 Vac and 480 Vac with the circuit breaker option (PM) or when protected by class J or class L fuses as specified on the P1000 Bypass nameplate.

NOTICE: When the input voltage is 440 V or higher or the wiring distance is greater than 100 meters, pay special attention to the motor insulation voltage or use a drive duty motor. Failure to comply could lead to motor insulation breakdown.

NOTICE: Do not connect AC control circuit ground to drive enclosure. Improper drive grounding can cause control circuit malfunction.

Note: The minimum load for relay outputs DO-7, DO-8, DO-9, DO-10, M1-M2, M3-M4, M5-M6, and MA-MB-MC is 10 mA.

WARNING! Sudden Movement Hazard. Do not close the wiring for the control circuit unless the multifunction input terminal parameters are properly set. Improper sequencing of run/stop circuitry could result in death or serious injury from moving equipment.

WARNING! Sudden Movement Hazard. Ensure start/stop circuits are wired properly and in the correct state before energizing the drive. Failure to comply could result in death or serious injury from moving equipment. When programmed for 3-Wire control, a momentary closure on terminal S1 may cause the drive to start.

WARNING! Sudden Movement Hazard. When using a 3-Wire sequence, set the drive to 3-Wire sequence prior to wiring the control terminals and set parameter b1-17 to 0 so the drive will not accept a Run command at power up (default). If the drive is wired for a 3-Wire sequence but set up for a 2-Wire sequence (default), and parameter b1-17 is set to 1 so the drive accepts a Run command at power up, the motor will rotate in reverse direction at drive power up and may cause injury.

WARNING! Sudden Movement Hazard. Confirm the drive I/O signals and external sequence before executing the application preset function. Executing the application preset function or setting A1-06 ≠ 0 will change the drive I/O terminal functions and may cause unexpected equipment operation. Failure to comply may cause death or serious injury.

NOTICE: Route motor leads U/T1, V/T2, and W/T3 separate from all other leads to reduce possible interference-related issues. Failure to comply may result in abnormal operation of bypass and nearby equipment.

NOTICE: When using the automatic fault restart function with wiring designed to shut off the power supply upon drive fault, make sure the drive does not trigger a fault output during fault restart (L5-02 = 0, default). Failure to comply will prevent the automatic fault restart function from working properly.

3.3 Main Circuit Wiring

Note: Refer to the documentation packaged with the P1000 Bypass and labels placed in the Bypass enclosure for procedures required to safely and properly wire the Bypass main circuit.

NOTICE: Do not solder the ends of wire connections to the bypass. Soldered wiring connections can loosen over time. Improper wiring practices could result in malfunction due to loose terminal connections.

NOTICE: Do not switch the bypass input to start or stop the motor. Frequently switching the bypass on and off shortens the life of the DC bus charge circuit and the DC bus capacitors, and can cause premature bypass failures. For the full performance life, refrain from switching the bypass on and off more than once every 30 minutes.

◆ Factory Recommended Branch Circuit Protection

WARNING! Fire Hazard. Branch Circuit protection is required to be installed according to applicable local codes and the requirements listed on the P1000 Bypass nameplate. Failure to comply could result in fire and damage to the bypass and drive or injury to personnel. The P1000 Bypass is suitable for use on a circuit capable of delivering not more than 100,000 RMS symmetrical amperes, 208 Vac and 480 Vac with the circuit breaker option or when protected by class J or class L fuses as specified on the P1000 Bypass nameplate.

Yaskawa recommends installing branch circuit protection according to maintain compliance with UL508C. Semiconductor protective type fuses are preferred. Alternate branch circuit protection devices are also listed in this manual.

◆ Drive Main Circuit Terminal Functions

Table 3.1 Main Circuit Terminal Functions

Terminal	Description	Function	Page
R/L1	Main circuit power supply input	Connects line power to the bypass	42
S/L2			
T/L3			
U/T1	Drive output	Connects to the motor	42
V/T2			
W/T3			
⊕	For 200 V Class: 100 Ω or less For 400 V Class: 10 Ω or less	Grounding terminal	44

◆ Wire Gauge and Tightening Torque Specifications

- Note:**
- For 0 to 100 A, use a minimum of 60 °C - 75 °C copper wire.
 - For above 100 A, use a minimum of 75 °C copper wire.
 - Wire gauge recommendations based on drive continuous current ratings using 75 °C 600 Vac vinyl-sheathed wire assuming ambient temperature within 40 °C and wiring distance less than 100 m.

- Consider the amount of voltage drop when selecting wire gauges. Increase the wire gauge when the voltage drop is greater than 2% of motor rated voltage. Ensure the wire gauge is suitable for the terminal block. Use the following formula to calculate the amount of voltage drop:

$$\text{Line drop voltage (V)} = \sqrt{3} \times \text{wire resistance } (\Omega/\text{km}) \times \text{wire length (m)} \times \text{current (A)} \times 10^{-3}$$

- Refer to *UL Standards Compliance on page 361* for information on UL compliance.

◆ Main Input Circuit and Motor Wiring

This section outlines the various steps, precautions, and checkpoints for wiring the main circuit terminals and motor terminals.

WARNING! Electrical Shock Hazard. Do not connect the AC power line to the bypass output terminals. Failure to comply could result in death or serious injury by fire as a result of bypass damage from line voltage application to output terminals.

NOTICE: When connecting the motor to the output terminals T1, T2, and T3, the phase order for the drive and motor should match. Failure to comply with proper wiring practices may cause the motor to run in reverse if the phase order is backward.

NOTICE: Do not connect phase-advancing capacitors or LC/RC noise filters to the output circuits. Failure to comply could result in damage to the drive, phase-advancing capacitors, LC/RC noise filters or ground fault circuit interrupters.

NOTICE: Route motor leads U/T1, V/T2, and W/T3 separate from all other leads to reduce possible interference-related issues. Failure to comply may result in abnormal operation of bypass and nearby equipment.

3.3 Main Circuit Wiring

■ Cable Length Between Bypass and Motor

Voltage drop along the motor cable may cause reduced motor torque when the wiring between the bypass and the motor is too long, especially at low frequency output. This can also be a problem when motors are connected in parallel with a fairly long motor cable. Bypass output current will increase as the leakage current from the cable increases. An increase in leakage current may trigger an overcurrent situation and weaken the accuracy of the current detection.

Adjust the carrier frequency according to **Table 3.2**. If the motor wiring distance exceeds 100 m because of the system configuration, reduce the ground currents. **Refer to C6-02: Carrier Frequency Selection on page 104.**

Table 3.2 Cable Length Between Bypass and Motor

Cable Length	50 m or less	100 m or less	Greater than 100 m
Carrier Frequency	12.5 kHz or less	5 kHz or less	2 kHz or less

- Note:**
1. When setting carrier frequency for bypasses running multiple motors, calculate cable length as the total wiring distance to all connected motors.
 2. Do not use a long distance shielded line if there is an overvoltage problem at start. Either lower the carrier frequency or switch on the internal EMC filter if the power supply has a neutral ground.

■ Ground Wiring

Follow the precautions below when wiring the ground for one bypass or a series of bypasses.

WARNING! Electrical Shock Hazard. Before servicing, disconnect all power to the equipment. The internal capacitor remains charged even after the power supply is turned off. The charge indicator LED will extinguish when the DC bus voltage is below 50 Vdc. To prevent electric shock, wait for at least the time specified on the warning label, once all indicators are OFF, measure for unsafe voltages to confirm the drive is safe prior to servicing.

WARNING! Electrical Shock Hazard. Make sure the protective earthing conductor complies with technical standards and local safety regulations. Because the leakage current exceeds 3.5 mA, IEC 61800-5-1 states that either the power supply must be automatically disconnected in case of discontinuity of the protective earthing conductor or a protective earthing conductor with a cross-section of at least 10 mm² (Cu) or 16 mm² (Al) must be used. Failure to comply may result in death or serious injury.

WARNING! Electrical Shock Hazard. Always use a ground wire that complies with technical standards on electrical equipment and minimize the length of the ground wire. Improper equipment grounding may cause dangerous electrical potentials on equipment chassis, which could result in death or serious injury.

WARNING! Electrical Shock Hazard. Be sure to ground the drive ground terminal (208 Vac bypass drive: ground to 100 Ω or less and 480 Vac bypass drive: ground to 10 Ω or less). Improper equipment grounding could result in death or serious injury by contacting ungrounded electrical equipment.

NOTICE: Do not share the ground wire with other devices such as welding machines or large-current electrical equipment. Improper equipment grounding could result in drive or equipment malfunction due to electrical interference.

NOTICE: When using more than one drive, ground multiple drives according to instructions. Improper equipment grounding could result in abnormal operation of drive or equipment.

Refer to **Figure 3.1** when using multiple drives. Do not loop the ground wire.

The drive ground lug (terminal ⏏) is connected to the enclosure. The enclosure ground lug must be connected to earth ground.

The drive has a second ground lug to accept the motor ground lead.

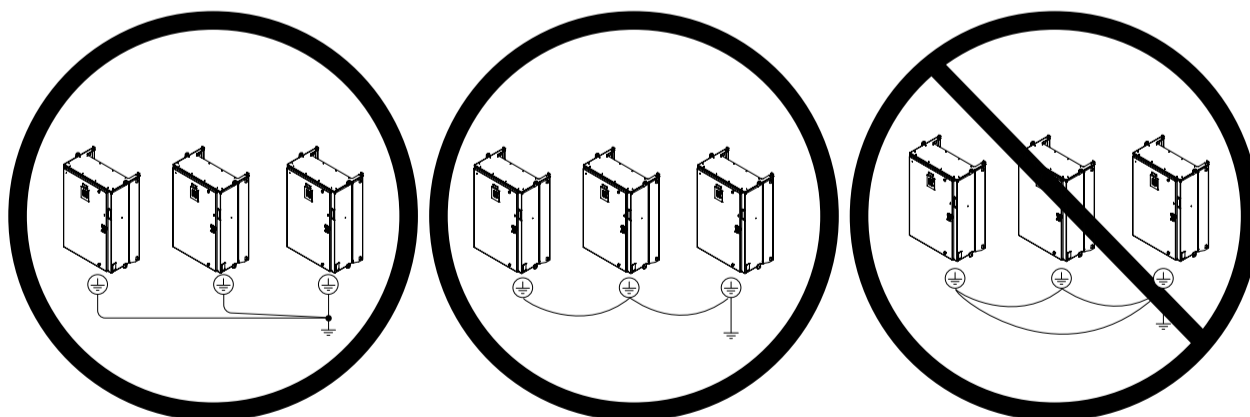

Figure 3.1 Ground Wiring for Multiple Bypass Units

3.3 Main Circuit Wiring

◆ Wiring the Main Input Circuit

WARNING! *Electrical Shock Hazard. Shut off the power supply to the drive before wiring the main circuit terminals. Failure to comply may result in death or serious injury.*

Wire the main circuit terminals after the terminal board has been properly grounded.

3.4 Control Circuit Wiring

3.4 Control Circuit Wiring

Note: Refer to the documentation packaged with the P1000 Bypass and labels placed in the bypass enclosure for procedures required to safely and properly wire the bypass and drive control circuits.

◆ Electronic Bypass Control Terminal Board A2

WARNING! Sudden Movement Hazard. Always check the operation and wiring of control circuits after being wired. Operating a P1000 Bypass with untested control circuits could result in death or serious injury.

WARNING! Sudden Movement Hazard. Confirm the drive I/O signals and external sequence before starting test run. Setting parameter Z1-01 may change the I/O terminal function automatically from the default setting. **Refer to Application Selection on page 75.** Failure to comply may result in death or serious injury.

The functions of the control circuit terminals are shown in **Table 3.3**.

The control circuit terminals are typically located on the interior left side of the bypass enclosure and are arranged as shown in **Figure 3.2**.

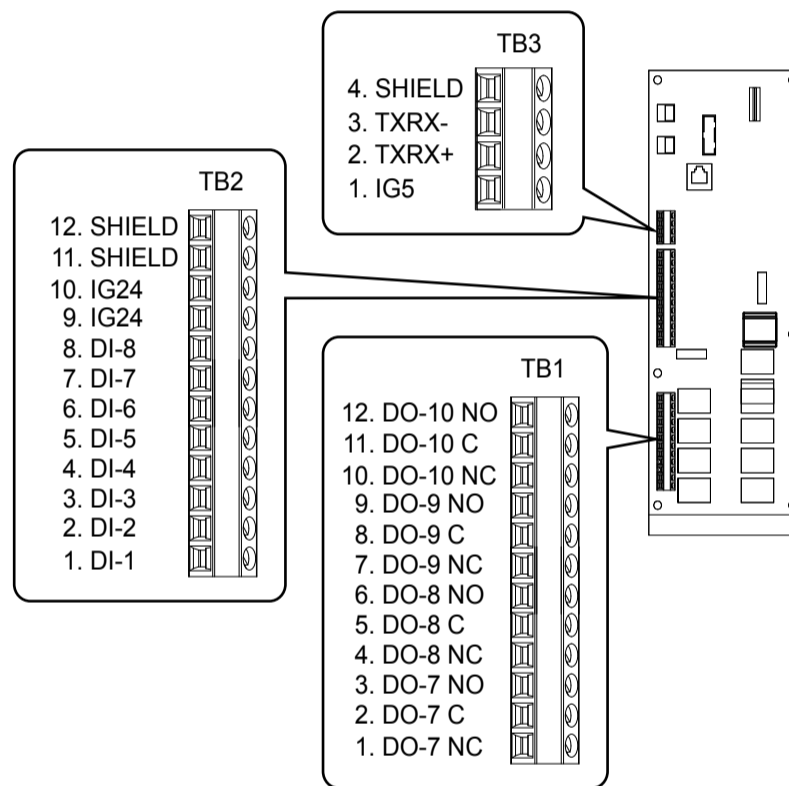

Figure 3.2 Control Circuit Terminal Board A2 Arrangement

Table 3.3 P1000 Bypass Control Circuit Terminal Board A2

Type	Signal Name	Description	Specification
Digital Inputs	DI-1	Digital Input 1	Dry contact rated, photocoupler sinking input to IG, 24 Vdc 8 mA, ground fault protected
	DI-2	Digital Input 2	
	DI-3	Digital Input 3	
	DI-4	Digital Input 4	
	DI-5	Digital Input 5	
	DI-6	Digital Input 6	
	DI-7	Digital Input 7	
	DI-8	Digital Input 8	
	IG24	Isolated Ground	Digital Input Common

3.4 Control Circuit Wiring

Type	Signal Name	Description	Specification
Digital Outputs 120 Vac	DO-1	Digital Output 1	(Factory use only) 120 Vac, 66 VA sealed, 1650 inrush
	DO-2	Digital Output 2	
	DO-3	Digital Output 3	
	DO-4	Digital Output 4	
	DO-5	Digital Output 5	
Digital Outputs	DO-6	Digital Output 6	Relay, dry contact, form C, 30 Vdc or 120 Vac, DO-6 (factory use only), 3.7 Amp 360 VA, DO-7 to DO-10 for customer use, 2 Amp
	DO-7	Digital Output 7	
	DO-8	Digital Output 8	
	DO-9	Digital Output 9	
	DO-10	Digital Output 10	

Table 3.4 lists the available control circuit input terminals on the drive. Text in parenthesis indicates the default setting for each multi-function input.

The drive control circuit terminals are arranged as shown in **Figure 3.3**.

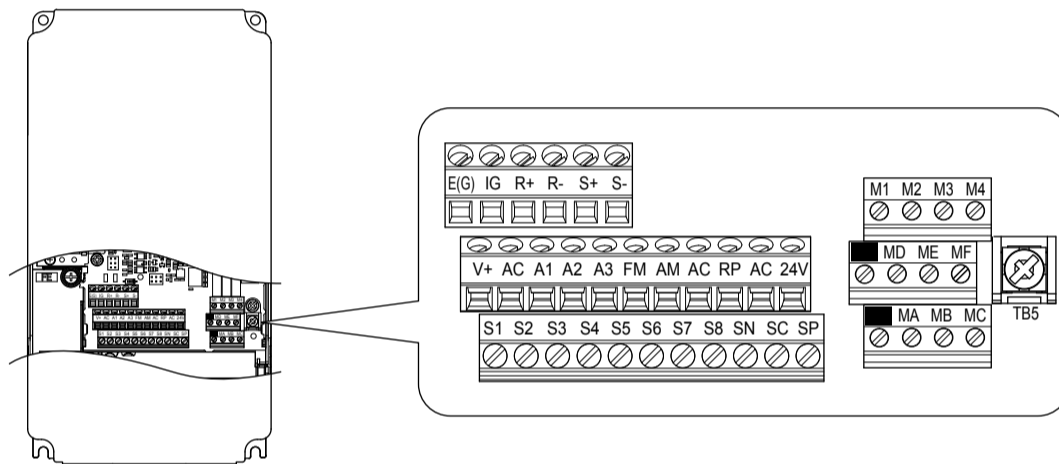

Figure 3.3 Drive Control Circuit Terminal Board Arrangement

Table 3.4 Drive Control Circuit Terminal Board A1

Type	No.	Terminal Name (Function)	Function (Signal Level) Default Setting	Page
Frequency Reference Inputs	+V	Power supply for analog inputs	10.5 Vdc (maximum allowable current 20 mA)	163
	A1	Multi-function analog input 1 (Frequency reference bias)	<ul style="list-style-type: none"> 0 to 10 Vdc/100% (input impedance: 20 kΩ) 4 to 20 mA/100%, 0 to 20 mA/100% (input impedance: 250 Ω) Voltage or current input must be selected by Jumper S1 and H3-01. 	124 163
	A2	Multi-function analog input 2 (Frequency reference bias)	<ul style="list-style-type: none"> 0 to 10 Vdc/100% (input impedance: 20 kΩ) 4 to 20 mA/100%, 0 to 20 mA/100% (input impedance: 250 Ω) Voltage or current input must be selected by Jumper S1 and H3-09. 	127 163 163
	A3	Multi-function analog input 3 (Auxiliary frequency reference 1)	<ul style="list-style-type: none"> -10 to 10 Vdc, 0 to 10 Vdc (input impedance: 20 kΩ) 4 to 20 mA, 0 to 20 mA (input impedance: 250 Ω) Voltage or current input must be selected by jumper S1 and H3-05. 	163
	AC	Frequency reference common	0 V	163
	FE	Ground for shielded lines and option cards	-	-

◆ Bypass Analog Outputs

There are two analog outputs that can be configured for a signal level of 0 to 10 Vdc or 4 to 20 mA. The signal level is controlled by the position of jumpers J2 and J3 on Control PCB A2 and by the values set to drive parameters H4-07 and H4-08.

3.4 Control Circuit Wiring

Serial Communications

Refer to *BACnet Communications on page 309* or *Refer to MEMOBUS/Modbus Communications on page 329* for details depending on the applicable serial communications protocol.

Serial Communication Terminals

Table 3.5 Control Circuit Terminals: Serial Communications

Type	Name	Description	Notes
MEMOBUS/Modbus or BACnet Communication	IG5	Isolated ground	Ground reference for RS-485 signals. This is an isolated ground used only for communications and may be used in certain circumstances to connect to other communication devices floating ground references.
	TXRX+	(+) Differential communication signal	RS-485 signal levels
	TXRX-	(-) Differential communication signal	
	SHIELD	Shield tie point	Connected to chassis ground

Bypass and Drive Control Circuit Wire Size and Torque Specifications

Select appropriate wire type and gauges from *Table 3.6*. For simpler and more reliable wiring, use crimp ferrules on the wire ends. Refer to *Table 3.7* for ferrule terminal types and sizes.

Table 3.6 Wire Gauge and Torque Values: Bypass and Drive Control Circuit

Terminal	Screw Size	Tightening Torque N·m (lb. in)	Bare Wire Terminal		Ferrule-Type Terminal		Wire Type
			Applicable wire size mm ² (AWG)	Recomm. wire size mm ² (AWG)	Applicable wire size mm ² (AWG)	Recomm. wire size mm ² (AWG)	
DO-7, DO-8, DO-9, DO-10 DI-1, DI-2, DI-3, DI-4, DI-5, DI-6, DI-7, DI-8, IG24 IG5, TXRX+, TXRX-, SHIELD	M3	0.5 to 0.6 (4.4 to 5.3)	Stranded wire: 0.2 to 1.0 (24 to 16) Solid wire: 0.2 to 1.5 (24 to 16)	0.75 (18)	0.25 to 0.5 (24 to 20)	0.5 (20)	Shielded wire, etc.
+V, A1, A2, A3, AC FM, AM, AC R+, R-, S+, S-, IG	M3	0.5 to 0.6 (4.4 to 5.3)	Stranded wire: 0.2 to 1.0 (24 to 16) Solid wire: 0.2 to 1.5 (24 to 16)	0.75 (18)	0.25 to 0.5 (24 to 20)	0.5 (20)	Shielded wire, etc.

Ferrule-Type Wire Terminals

Yaskawa recommends using CRIMPFOX 6, a crimping tool manufactured by PHOENIX CONTACT, to prepare wire ends with insulated sleeves before connecting to the drive. See *Table 3.7* for dimensions.

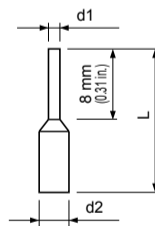

Figure 3.4 Ferrule Dimensions

Table 3.7 Ferrule Terminal Types and Sizes

Size mm ² (AWG)	Type	L mm (in)	d1 mm (in)	d2 mm (in)	Manufacturer
0.25 (24)	AI 0.25-8YE	12.5 (0.49)	0.8 (0.03)	2.0 (0.08)	PHOENIX CONTACT
0.34 (22)	AI 0.34-8TQ	12.5 (0.49)	0.8 (0.03)	2.0 (0.08)	
0.5 (20)	AI 0.5-8WH AI 0.5-8OG	14.0 (0.55)	1.1 (0.04)	2.5 (0.10)	

◆ Drive Cover Removal

Refer to *Table 3.8* and reference the standard P1000 Technical Manual (SIEPYAIP1U01) for detailed procedures on removing and attaching drive covers.

Table 3.8 P1000 Bypass Models by P1000 Drive Model

Bypass Model	Drive Model
208 Vac Bypass Drive	
D002	2A0004
D003	
D004	2A0006
D007	2A0008
D010	2A0012
D016	2A0018
D024	2A0030
D030	2A0040
D046	2A0056
D059	2A0069
D074	2A0081
D088	2A0110
D114	2A0138
D143	2A0169
D169	
D211	2A0211
D273	2A0312
D343	2A0360
D396	2A0415
480 Vac Bypass Drive	
B001	4A0002
B002	
B003	4A0004
B004	4A0005
B007	4A0009
B011	4A0011
B014	4A0018
B021	4A0023
B027	4A0031
B034	4A0038
B040	4A0044
B052	4A0058
B065	4A0072
B077	4A0088
B096	4A0103
B124	4A0139
B156	4A0165
B180	4A0208
B240	4A0250
B302	4A0362
B361	
B414	4A0414
B477	4A0515
B515	
B590	4A0675

3.4 Control Circuit Wiring

◆ Wiring the Drive Control Circuit Terminal

This section describes the proper preparations for wiring the control terminals.

Note: Refer to the P1000 standard Technical Manual (SIEPYAIP1U01) for figures showing correct control circuit wire routing.

WARNING! *Electrical Shock Hazard. Do not remove covers or touch the circuit boards while the power is on. Failure to comply could result in death or serious injury.*

NOTICE: *Separate control circuit wiring from main circuit wiring (terminals R/L1, S/L2, T/L3, -M, +M, -, +1, +3, U/T1, V/T2, W/T3) and other high-power lines. Improper wiring practices could result in drive malfunction due to electrical interference.*

NOTICE: *Route motor leads U/T1, V/T2, and W/T3 separate from all other leads to reduce possible interference-related issues. Failure to comply may result in abnormal operation of bypass and nearby equipment.*

NOTICE: *Separate wiring for digital output terminals MA, MB, MC, and M1 to M6 from wiring to other control circuit lines. Improper wiring practices could result in drive or equipment malfunction or nuisance trips.*

NOTICE: *Use a class 2 power supply when connecting to the control terminals. Improper application of peripheral devices could result in drive performance degradation due to improper power supply. Refer to NEC Article 725 Class 1, Class 2, and Class 3 Remote-Control, Signaling, and Power Limited Circuits for requirements concerning class 2 power supplies.*

NOTICE: *Insulate shields with tape or shrink tubing to prevent contact with other signal lines and equipment. Improper wiring practices could result in drive or equipment malfunction due to short circuit.*

NOTICE: *Connect the shield of shielded cable to the appropriate ground terminal. Improper equipment grounding could result in drive or equipment malfunction or nuisance trips.*

Wire the control circuit only after terminals have been properly grounded and main circuit wiring is complete. **Refer to Terminal Wiring Guide on page 50** for details. Prepare the ends of the control circuit wiring as shown in **Figure 3.6**.

NOTICE: *Do not tighten screws beyond the specified tightening torque. Failure to comply may result in erroneous operation, damage to the terminal block, or cause a fire.*

NOTICE: *Use shielded twisted-pair cables as indicated to prevent operating faults. Improper wiring practices could result in drive or equipment malfunction due to electrical interference.*

Connect control wires as shown in **Figure 3.5**.

Yaskawa recommends Phoenix Contact screwdriver model SZF 0-0.4 x 2.5 or equivalent to wire the terminal block.

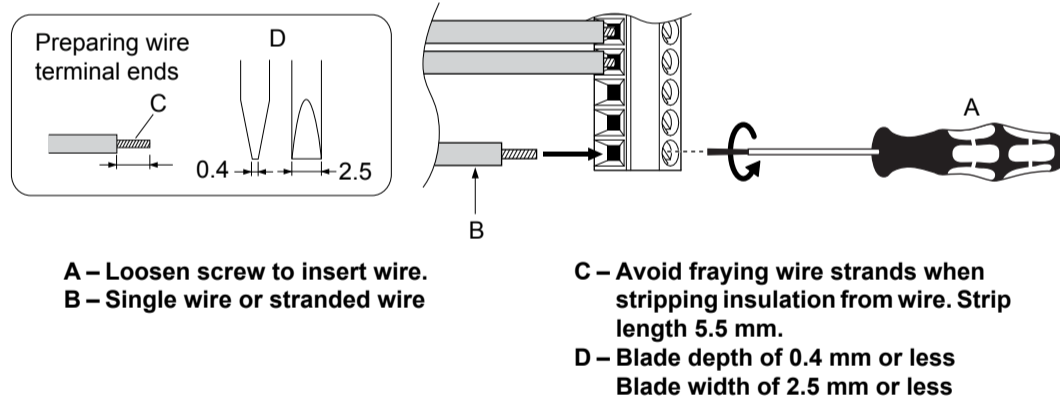
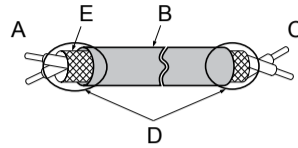

Figure 3.5 Terminal Wiring Guide

Use the cable tie holes and cable hooks when wiring control terminals.

Note: Take proper precautions when wiring the cables so that the front covers will easily fit back onto the drive. Make sure cables are not pinched between the front covers and the drive when replacing the covers.

When setting the frequency by analog reference from an external potentiometer, use shielded twisted-pair wires, preparing wire ends as shown in **Figure 3.6**. Connect the shield to the ground terminal of the drive.



- A – Drive side
- B – Connect shield to ground terminal of drive.
- C – Insulation
- D – Control device side
- E – Shield sheath (insulate with tape)
- F – Shield

Figure 3.6 Preparing the Ends of Shielded Cables

NOTICE: The analog signal wiring between the drive and the operator station or peripheral equipment should not exceed 50 meters when using an analog signal from a remote source to supply the frequency reference. Failure to comply could result in poor system performance.

◆ Switches and Jumpers on the Terminal Board

The terminal board is equipped with several switches used to adapt the drive I/Os to the external control signals. **Figure 3.7** shows the location of these switches. *Refer to Bypass and Drive Control I/O Connections on page 52* for setting instructions.

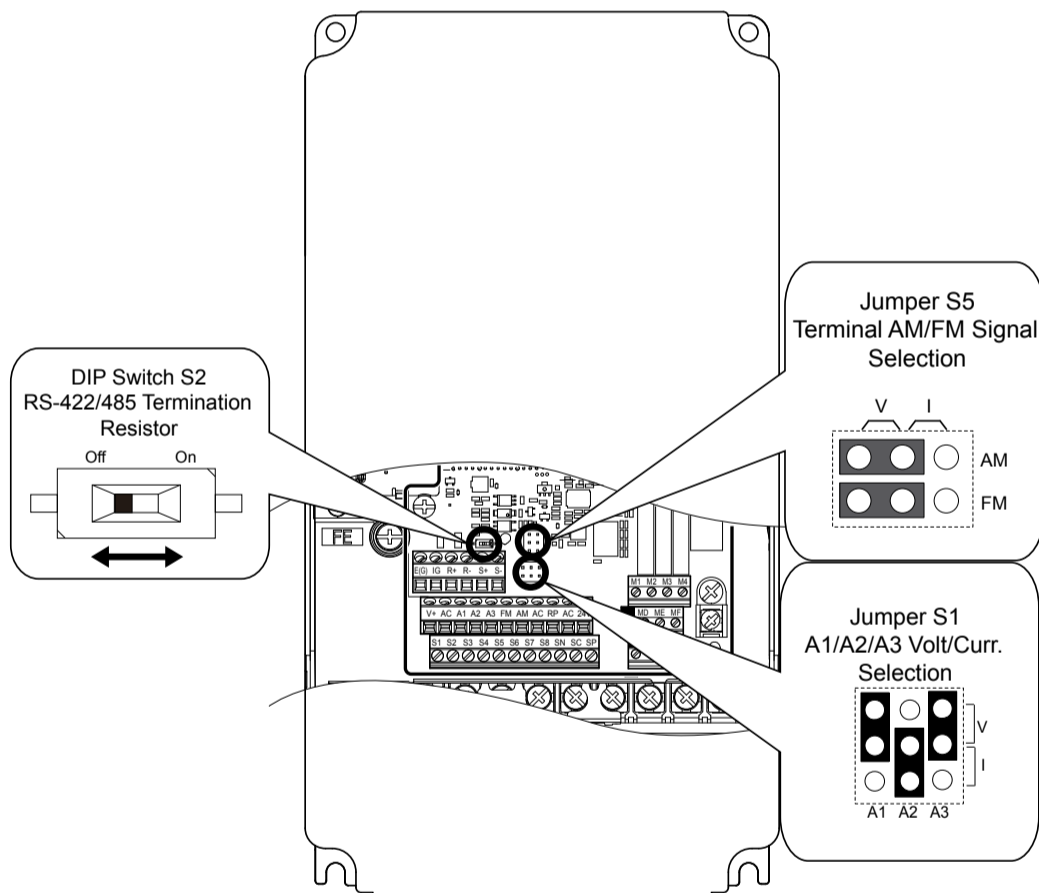

Figure 3.7 Locations of Jumpers and Switches on the Terminal Board

3.5 Bypass and Drive Control I/O Connections

3.5 Bypass and Drive Control I/O Connections

◆ Terminals A1, A2, and A3 Input Signal Selection

Terminals A1, A2, and A3 can be used to input either a voltage or a current signal. Select the signal type using jumper S1 as explained in **Table 3.9**. Set parameters H3-01, H3-05, and H3-09 accordingly as shown in **Table 3.10**. *Refer to Switches and Jumpers on the Terminal Board on page 51* for locating jumper S1.

Note: If terminals A1 and A2 are both set for frequency bias (H3-02 = 0 and H3-10 = 0), both input values will be combined to create the frequency reference.

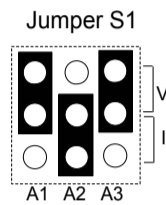

Figure 3.8 Terminal A2 Set to Current Input; A1 and A3 Set to Voltage Input

Table 3.9 Jumper S1 Settings

Setting	Description
V (top position)	Voltage input (-10 to +10 V or 0 to 10 V)
I (bottom position)	Current input (4 to 20 mA or 0 to 20 mA)

Table 3.10 Voltage/Current Selection Parameter Details

No.	Parameter Name	Description	Setting Range	Default Setting
H3-01	Terminal A1 signal level selection	Selects the signal level for terminal A1. 0: 0 to 10 Vdc 1: 0 to 10 Vdc Bipolar 2: 4 to 20 mA 3: 0 to 20 mA	0 to 3	0
H3-05	Terminal A3 signal level selection	Selects the signal level for terminal A3. 0: 0 to 10 Vdc 1: 0 to 10 Vdc Bipolar 2: 4 to 20 mA 3: 0 to 20 mA	0 to 3	0
H3-09	Terminal A2 signal level selection	Selects the signal level for terminal A2. 0: 0 to 10 Vdc 1: 0 to 10 Vdc Bipolar 2: 4 to 20 mA 3: 0 to 20 mA	0 to 3	2

◆ Terminal FM/AM Signal Selection

The signal type for terminals FM and AM can be set to either voltage or current output using jumper S5 on the terminal board as explained in **Table 3.11**. When changing the setting of jumper S5, parameters H4-07 and H4-08 must be set accordingly. The default selection is voltage output for both terminals. *Refer to Switches and Jumpers on the Terminal Board on page 51* for locating jumper S5.

Table 3.11 Jumper S5 Settings

Terminal	Voltage Output	Current Output
Terminal FM		
Terminal AM		

3.5 Bypass and Drive Control I/O Connections

Table 3.12 Parameter H4-07 and H4-08 Details

No.	Parameter Name	Description	Setting Range	Default Setting
H4-07	Terminal FM signal level selection	0: 0 to 10 Vdc 2: 4 to 20 mA	0, 2	0
H4-08	Terminal AM signal level selection			

3.6 External Interlock

3.6 External Interlock

Systems that may be affected during drive fault conditions should be interlocked with the drive fault output and ready signal.

◆ Annunciation Contact Outputs

Annunciation contacts for customer use are provided at terminal blocks TB1 as indicated in **Table 3.13**. Annunciation contacts are used to indicate the status of bypass operation. Contacts are rated for 2 Amps, 24 Vdc/120 Vac +/- 15% maximum.

Table 3.13 Annunciation Contact Details

Function <1>	Name	Terminal Block	Terminals	Type
Motor Run	DO-7	TB1	1-2-3	Form C
Hand Mode	DO-8	TB1	4-5-6	Form C
Auto Mode	DO-9	TB1	7-8-9	Form C
System Fault	DO-10	TB1	10-11-12	Form C

<1> Default settings are shown. Set parameters Z2-23 to Z2-26 to choose other functions.

The function of output relays DO-7 through DO-10 may be reprogrammed via bypass parameters Z2-23 through Z2-26. These form C dry contact relays are for customer use in annunciation to building automation systems (BAS) or other circuits. Each contact is rated for 2 amps at 120 Vac.

Refer to Z2-01 to Z2-08: Digital Input 1 to 8 Function Select on page 177 for descriptions of the programmable functions of annunciation contacts.

◆ Building Automation System Run/Stop Circuit

DI-1 (TB2-1 by default setting in Z2-01) is available to connect the normally open (N.O.) Run/Stop contact from a BAS or other remote controller for auto mode control.

These terminals must have contact closure for the motor to run in AUTO mode.

◆ Safety Interlock Circuit

DI-2 (TB2-2 by default setting in Z2-02) is provided to connect safety devices in a normally-closed series circuit, such as: freeze up thermostats, smoke/fire sensors, high pressure limits, temperature limits or vibration detectors.

The HOA keypad will display the status “Safety Open”, and trigger a Safety Open fault if a N.C. safety circuit is not closed between DI-2 and IG24 (TB2-10) on PCB A2 at power-up with a Run command in HAND or AUTO mode. An open circuit between DI-2 and IG24 will prevent bypass operation.

Take one of the following steps to ensure proper operation prior to startup:

1. Install a N.C. safety circuit between DI-2 and IG24 on PCB A2.
2. Install a jumper between DI-2 and IG24 (on PCB A2). A normally-closed safety circuit may also be used in place of this jumper.

◆ Building Automation System Interlock Circuit (Drive and Bypass Enable Input)

The HOA keypad will display the status “INTRLOCK OPN” and possibly a “BAS Ilock-open” alarm or “BAS Ilock TO” fault if a N.C. safety circuit is not closed between DI-3 (TB2-3 by default setting of Z2-03) and IG24 on PCB A2 at power-up with a Run command in HAND or AUTO mode. An open circuit between TB2-3 and IG24 (TB2-10) will prevent bypass operation.

Take one of the following steps to ensure proper operation prior to startup:

1. Install a N.C. BAS Interlock Circuit/Damper Interlock between DI-3 and IG24 on PCB A2.
2. Install a jumper between DI-3 and IG24 on PCB A2. A normally-closed BAS interlock may also be used in place of this jumper.

◆ Remote Transfer to Bypass

Terminal TB2-4 is a programmable input with a default setting of “Remote Transfer to Bypass” operation. The function of this terminal can be changed using parameter Z2-04.

This function allows a contact closure from a BAS, between terminals TB2-4 and TB2-10, to transfer motor operation from Drive mode to Bypass mode. An open contact allows operation in Drive mode and a closed contact allows operation in Bypass mode.

◆ Smoke Purge Operation

Terminal TB2-5 is a programmable input with a default setting of “Smoke Purge” operation. The function of this terminal can be changed using parameter Z2-05.

This function allows a contact closure between terminals TB2-5 and TB2-10 to transfer motor operation to bypass for smoke purge operation. The motor overload and Safety Interlock circuit are overridden during smoke purge or in emergency fire/smoke situations to place priority on personnel protection.

Note: Smoke purge overrides all control inputs and bypass selector buttons. Smoke purge operation can only be terminated by opening the contact closure at terminal TB2-5 or by opening the disconnect switch.

◆ Spare Multi-Function Digital Inputs

Terminals TB2-6 and TB2-7 are spare programmable inputs. The Bypass +24 V logic circuit is interconnected with the drive multi-function digital inputs to allow a single customer interface to control both drive and bypass circuits. The function of these terminals can be set using parameters Z2-06 and Z2-07.

3.6 External Interlock

This Page Intentionally Blank

4

Start-Up Programming & Operation

This chapter explains HOA keypad functions and gives instructions on programming the P1000 Bypass for initial operation.

4.1	SECTION SAFETY.....	58
4.2	USING THE HOA KEYPAD.....	59
4.3	THE DRIVE AND PROGRAMMING MODES.....	66
4.4	POWERING UP THE DRIVE.....	70
4.5	START-UP PROCEDURE.....	71
4.6	APPLICATION SELECTION.....	75
4.7	AUTO-TUNING.....	76

4.1 Section Safety

4.1 Section Safety

WARNING

Electrical Shock Hazard

Do not connect or disconnect wiring while the power is on.

Failure to comply could result in death or serious injury.

Before servicing, disconnect all power to the equipment. The internal capacitor remains charged even after the power supply is turned off. The charge indicator LED will extinguish when the DC bus voltage is below 50 Vdc. To prevent electric shock, wait for at least the time specified on the warning label, once all indicators are OFF, measure for unsafe voltages to confirm the drive is safe prior to servicing.

Do not operate equipment with covers removed.

Failure to comply could result in death or serious injury.

The diagrams in this section may include drives without covers or safety shields to illustrate details. Be sure to reinstall covers or shields before operating the drives and run the drives according to the instructions described in this manual.

Do not remove covers or touch circuit boards while the power is on.

Failure to comply could result in death or serious injury.

4.2 Using the HOA Keypad

Use the HOA keypad to enter OFF commands, switch AUTO or HAND Mode, change parameters, and display data including fault and alarm information.

◆ HOA Keypad Keys and Displays

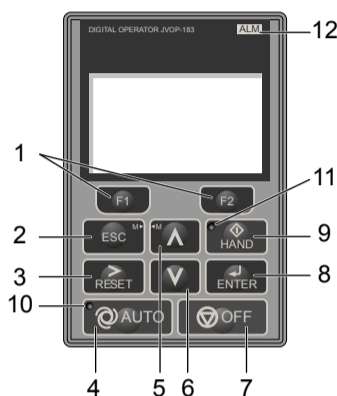

Figure 4.1 Description of HOA Keypad Keys and Displays

No.	Display	Name	Function
1		Function Key F1 (Drive Test)	Selects Drive Test Mode
		Function Key F2 (Bypass/Drive)	Toggles selection between Bypass Mode and Drive Mode.
2		ESC Key	<ul style="list-style-type: none"> Returns to the previous display. Moves the cursor one space to the left. In Drive Mode, pressing and holding this button will return to the Frequency Reference display. In Bypass Mode, pressing and holding this button will return to the Bypass Main Menu. During parameter entry, allows aborting the current edited value and exits the parameter editing mode.
3		RESET Key	<ul style="list-style-type: none"> Moves the cursor to the right. Resets the bypass or drive to clear a fault situation.
4		AUTO Key	Selects AUTO mode.
5		Up Arrow Key	Scrolls up to display the next item, selects parameter numbers, and increments setting values.
6		Down Arrow Key	Scrolls down to display the previous item, selects parameter numbers, and decrements setting values.
7		OFF Key	<p>Selects OFF mode.</p> <p>If the drive was operating the motor, the motor will stop according to the stopping method selected in b1-03.</p> <p>If the bypass was operating the motor, the bypass contactor opens and the motor coasts to a stop.</p>
8		ENTER Key	<ul style="list-style-type: none"> Enters parameter values and settings. Selects a menu item to move between displays.
9		HAND Key	Selects HAND mode.
10		AUTO Light	Lit while the drive is in AUTO mode. Refer to page 62 for details.
11		HAND Light	Lit while the drive is in HAND mode. Refer to page 62 for details.
12		ALM LED Light	<i>Refer to ALARM (ALM) LED Displays on page 62.</i>

4.2 Using the HOA Keypad

◆ LCD Display

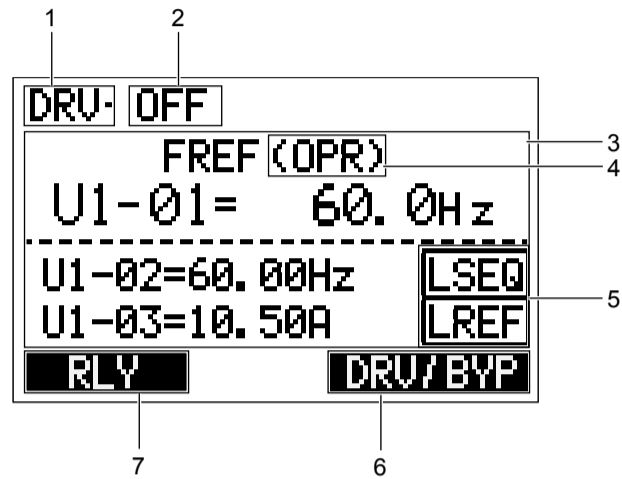











Figure 4.2 LCD Display

Table 4.1 Display and Contents

No.	Name	Display	Content
1	Bypass/Drive Status Display	DRV (not blinking)	Displayed when In Drive Mode. The bypass will run in Drive Mode when a Run command is present.
		DRV (blinking)	Displayed when in Drive Mode, but a condition is making the bypass run in Bypass Mode.
		BYP (not blinking)	Displayed when in Bypass Mode. The Bypass will run in Bypass Mode when a Run command is present. Drive input contactor K1 is open and the drive will be powered down.
		BYP (blinking)	Displayed when in Bypass Mode with Drive Test Mode set. The bypass will run in Bypass Mode when a Run command is present. Drive input contactor K1 is closed and the drive is powered on.

4.2 Using the HOA Keypad

No.	Name	Display	Content
2	Bypass Status Display	POWERUP	Displayed when the bypass is powering up.
		OFF	Displayed when no Run command is present and the safety circuit is closed.
		WAIT_FOR_RUN	Displayed when Run is requested, the safety circuit is closed, and the bypass is waiting for Run input.
		SAFETY_OPEN	Displayed when the safety circuit input is open.
		INTRLOCK_OPN	Displayed when a Run command is present, the safety circuit is closed, but the Interlock input is open.
		PRE_RUN_DRIVE	Displayed when the bypass is running in the Pre-Run State at the programmed frequency for the programmed time.
		RUN_DRIVE	Displayed when running in Drive Mode.
		RUN_BYPASS	Displayed when running in Bypass Mode.
		RMOT_XFER_EN	Displayed when running in Remote Transfer.
		SMOK_PRG_BYP	Displayed when running in Smoke Purge Bypass.
		SMOK_PRG_DRV	Displayed when running in Smoke Purge Drive.
		AUTO_XFER_EN	Displayed when running in Auto Transfer, a fault was detected and switched to Bypass Mode.
		ENRGY_SAVEN	Displayed when running in Energy Savings Mode
		MTR_STOPPING	Displayed when fault is removed but motor is still ramping down.
		FAULTED	Displayed when a fault has been detected causing motor output contactors to open.
3	Data Display	—	Displays specific data and operation data.
4	Frequency Reference Source <1>	OPR	Displayed when the frequency reference source is the HOA keypad.
		COM	Displayed when the frequency reference source is the MEMOBUS/Modbus Communication Inputs of the drive.
		OP	Displayed when the frequency reference source is an option card connected to the drive.
		AI	Displayed when the function reference is assigned to an analog input.
		OFF	Displayed when HAND mode is OFF.
5	LOCAL/REMOTE Display <2>	RSEQ	Displayed when the run command is supplied from a remote source.
		LSEQ	Displayed when the run command is supplied from the operator keypad.
		RREF	Displayed when the run command is supplied from a remote source.
		LREF	Displayed when the run command is supplied from the operator keypad.
6	Function Key 2 (F2)	DATA	Pressing  scrolls to the next display.
		→	Pressing  scrolls the cursor to the right.
		DRV/BYP	Pressing  toggles selection between Bypass Mode and Drive Mode.
7	Function Key 1 (F1)	HELP	Pressing  displays the Help menu.
		←	Pressing  scrolls the cursor to the left.
		HOME	Pressing  returns to the top menu (Frequency Reference).
		ESC	Pressing  returns to the previous display.
		Monitor	Pressing  switches Monitor mode.
		RLY	Pressing  selects/deselects Drive Test Mode. Enters and exits Drive Test Mode when in Bypass Mode (Open/Close K1).

<1> Displayed when in Frequency Reference Mode.

<2> Displayed when in Frequency Reference Mode and Monitor Mode.

4.2 Using the HOA Keypad

◆ Bypass Control Board LEDs

The bypass control board A2 has six bi-color LEDs.



The operational states of the bypass LEDs after completion of the power-up diagnostic LED sequence are described in **Table 4.2**. Wait at least 2 seconds for the power-up diagnostic process to complete before verifying LED states.

Table 4.2 Bypass Control Board LED States

Name	Description	Color	Behavior
MS	Module Status	Red	Not used
		Green	Turns ON when transmitting Turns OFF when receiving
NS	Network Status	Red	Not used
		Green	Turns ON when transmitting Turns OFF when receiving
ST1	ST1, Status 1	Red	Not used
		Green	Round status Toggles ON/OFF every 500 rounds
ST2	ST2, Status 2	Red	Not used
		Green	Scan status Toggles ON/OFF every 500 scans
ST3	ST3, Status 3	Red	Not used
		Green	Not used
ST4	ST4, Status 4	Red	Not used
		Green	Not used



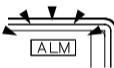







◆ ALARM (ALM) LED Displays

Table 4.3 ALARM (ALM) LED Status and Contents





State	Content	Display
Illuminated	When the drive detects an alarm or error.	
Flashing	<ul style="list-style-type: none"> When an alarm occurs. When an oPE is detected. When a fault or error occurs during Auto-Tuning. 	
Off	Normal operation (no fault or alarm).	

◆ AUTO LED and HAND LED Indications

Table 4.4 AUTO LED and HAND LED Indications

AUTO LED	HAND LED	State
 Off	 Off	OFF mode
 Off	 On solid	HAND mode (Also during DC injection braking)
 Off	 Long blink (50% duty)	HAND mode when the Frequency Reference is 0 and/or decelerating in HAND mode, or during PI Sleep or Snooze.
 On solid	 Off	Running in AUTO mode (Also during DC injection braking)
 Off	 Double blink	HAND mode, cycle the Run command.

4.2 Using the HOA Keypad

AUTO LED	HAND LED	State
 Long blink (50% duty)	 Off	Running in AUTO mode when the Frequency Reference is 0 and/or decelerating in AUTO mode, or during PI Sleep or Snooze. AUTO mode, Ready, No Run command input.
 Double blink	 Off	AUTO mode, stopped by a Fast- Stop from a Multi-Function Digital Input.

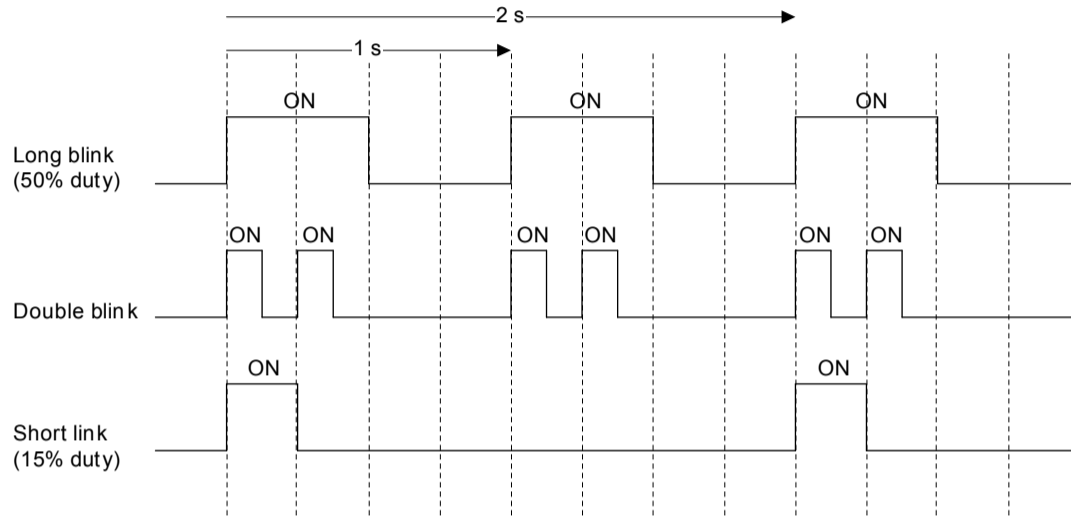

Figure 4.3 AUTO LED and HAND LED Timing Status

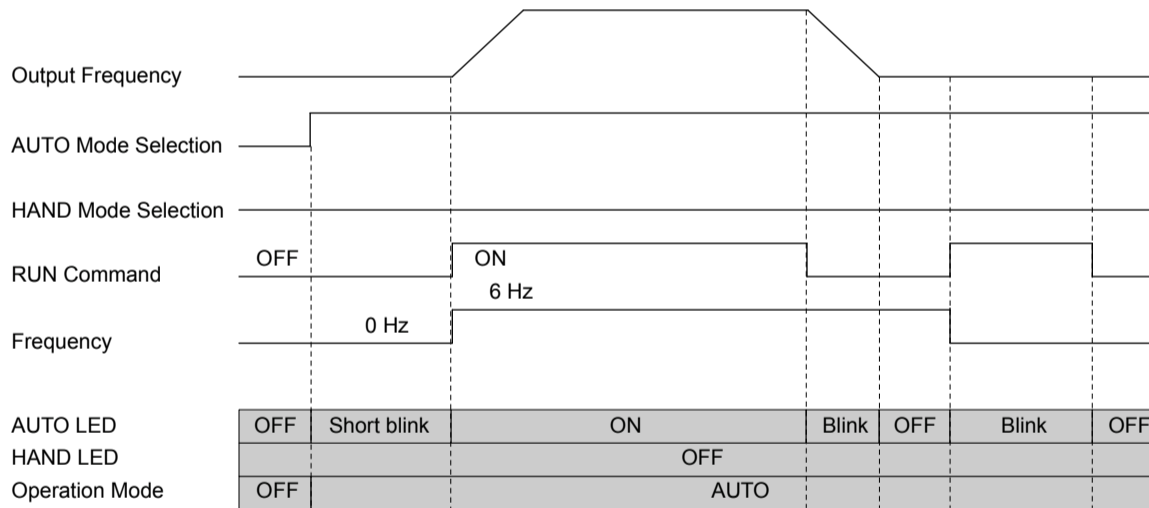

Figure 4.4 LEDs and Drive Operation in AUTO and HAND Modes

4.2 Using the HOA Keypad

◆ HOA Keypad Menu Structure

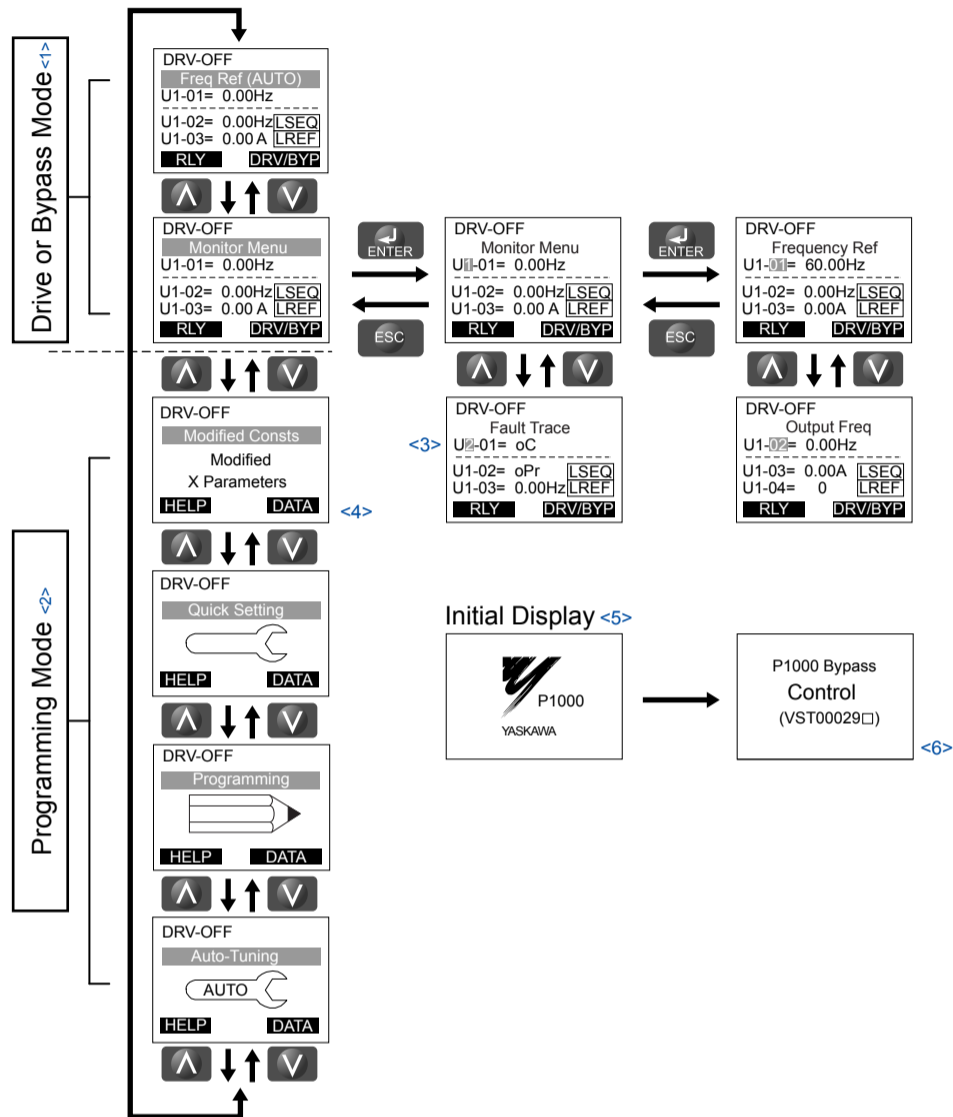





Figure 4.5 HOA Keypad Menu and Screen Structure

- <1> Pressing  or  will start the motor.
- <2> In Programming Mode, the AUTO and HAND keys are ignored.
- <3> Flashing characters are shown with white letters on gray background. (Example: )
- <4> "X" characters are used as examples in this manual. The HOA keypad will display the actual setting values.
- <5> The Frequency Reference appears after the initial display that shows the product name.
- <6> The information that appears on the display will vary depending on the drive.

◆ HOA Keypad Parameter Display (Drive Off)

The display of the drive-specific parameters changes when in bypass mode or when there is no power to the drive.

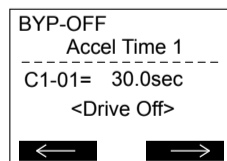

Figure 4.6 Drive-Specific Parameter

4.2 Using the HOA Keypad

Figure 4.6 shows the LCD display with a typical drive-specific parameter displayed and no power to the drive. In this example, the parameter displayed is stored both in the drive and in the bypass controller, so the present value is shown. The parameter cannot be changed when there is no power present on the drive. All drive-specific parameter numbers will NOT begin with the letter “Z”.

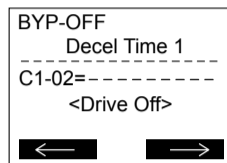

Figure 4.7 Drive-Specific Parameter

Figure 4.7 shows the LCD display with a typical drive-specific parameter displayed and no power to the drive. In this example, the parameter displayed is only stored in the drive so the present value of the parameter is not displayed. This parameter cannot be changed when there is no power present on the drive. All drive-specific parameter numbers will NOT begin with the letter “Z”.

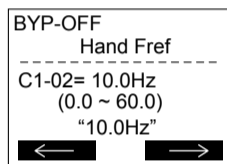

Figure 4.8 Bypass-Specific Parameter

Figure 4.8 shows the LCD display with a typical bypass-specific parameter displayed. This value can be changed regardless if there is power present on the drive or not. All bypass-specific parameter numbers will begin with the letter “Z”.

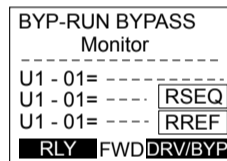

Figure 4.9 Drive-Specific Monitors

Figure 4.9 shows the LCD display with drive-specific monitors displayed and no power to the drive. With no power to the drive, the bypass controller cannot retrieve the information from the drive and the present values of the monitor is replaced with dashes. Drive-specific monitor numbers begin with “U1”, “U2”, “U3”, “U4”, or “U5”.

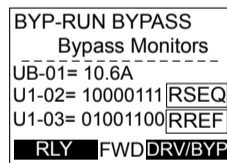

Figure 4.10 Bypass-Specific Monitors

Figure 4.10 shows the LCD display with bypass-specific monitors displayed. Bypass-specific monitor numbers begin with “UB”.

4.3 The Drive and Programming Modes

4.3 The Drive and Programming Modes

The bypass controller has a Drive Mode to operate the motor and a Programming Mode to edit parameter settings..

Drive Mode: In Drive Mode the user can operate the motor and observe U Monitor parameters. Certain parameter settings cannot be edited or changed when in Drive Mode.

Programming Mode: In Programming Mode the user can edit and verify parameter settings and perform Auto-Tuning. When the drive is in Programming Mode, the “AUTO” and “HAND” keys are ignored.

■ Drive Mode Details

The following actions are possible in the Drive Mode:

- Run and stop the drive
- Monitor the operation status of the drive (frequency reference, output frequency, output current, output voltage, etc.)
- View information on an alarm
- View a history of alarms that have occurred

■ Programming Mode Details

The following actions are possible in the Programming Mode:

- **Parameter Setting Mode:** Access and edit all parameter settings.
- **Modified Constants:** View a list of bypass parameters that have been changed from the default values.
- **Quick Setting Group:** Access a list of commonly used parameters to simplify setup
- **Auto-Tuning Mode:** Automatically calculate and set motor parameters to optimize drive performance.

◆ Changing Parameter Settings or Values

This example explains changing C1-02 (Deceleration Time 1) from 30.0 seconds (default) to 20.0 seconds.

Step		Display/Result
1.	Turn on the power to the drive. The initial display appears.	
2.	Press or until the Parameter Setting Mode screen appears.	
3.	Press to enter the parameter menu tree.	
4.	Press or to select the C parameter group.	
5.	Press two times.	
6.	Press or to select parameter C1-02.	

4.3 The Drive and Programming Modes

Step		Display/Result
7.	Press to view the current setting value (30.0 s). The leftmost digit flashes.	
8.	Press , , or until the desired number is selected. "3" flashes.	
9.	Press to change the value to 0020.0.	
10.	Press to confirm the change.	
11.	The display automatically returns to the screen shown in Step 4.	
12.	Press as many times as necessary to return to the initial display.	

◆ Verifying Parameter Changes: Modified Constants

The Modified Constants display lists edited bypass parameters from the Programming Mode. The Modified Constants display helps determine which bypass parameter settings have been changed, and is particularly useful when replacing a P1000 Bypass. If no bypass parameter settings have been changed, the Modified Constants display will read "None". The Modified Constants display also allows users to quickly access and re-edit any parameter settings that have been changed.<1>

To check the list of edited parameters:

Step		Display/Result
1.	Turn on the power to the drive. The initial display appears.	
2.	Press or until the display shows "Modified Consts".	
3.	Press to enter the list of parameters that have been edited from their original default settings. If parameters other than Z1-09 have been changed, use or to view them.	
4.	Press to access the setting value. The most significant digit flashes.	

<1> The "Modified Constants" menu on the P1000 Bypass will only display changed bypass parameters (Z□-□□ parameters). It will not display changed drive parameters.

4.3 The Drive and Programming Modes

◆ Simplified Setup Using the Quick Setting Group

The Quick Setting Group lists only the basic parameters necessary to set up the P1000 Bypass. This group expedites the startup process by showing only the most important parameters.

■ Quick Setting Parameters

Table 4.5 lists the parameters in the Quick Setting Group.

Use the Programming Mode to access parameters not displayed in the Quick Setting Group.

Table 4.5 Quick Setting Group Parameters

No.	Name	Description	Values	Page
Z1-07 (85CC) <input type="checkbox"/> RUN	Speed Reference Select Spd Ref Sel	Determines the source of the Frequency Reference sent from the Bypass Controller to the Drive. 0: Operator 1: Analog Input 2: Bypass Serial 3: Option Board (CN5)	Default: 1 <4> Range: 0 to 3	163
Z1-08 (85CD) <input type="checkbox"/> RUN	Run Command Select Run Cmd Sel	Determines the source of the Auto Mode Run command used by the Bypass Controller. 0: Operator 1: Bypass Controller Digital Input 2: Bypass Serial 3: Option Board (CN5)	Default: 1 Range: 0 to 3	164
Z1-09 (85CE) <input type="checkbox"/> RUN	HAND Mode Drive Speed Reference Hand Fref	This is the speed reference used when the Drive is running in HAND mode. Units are in Hz.	Default: 10.0 Hz <1> Min.: 0.0 Max.: 60.0	166
Z1-37 (85EA) <input type="checkbox"/> RUN	Set Time Set Time	Changes the LCD display to time setting to set the Real Time Clock. 0: Normal display 1: Displays time and date setting modes 2: Reset time <5>	Default: 0 Range: 0 to 2	173
Z3-01 (8500) <input type="checkbox"/> RUN	Serial Communications Protocol Select Serial Protocol	Selects the bypass serial communications protocol. 0: Modbus 1: N2 2: P1 3: BACnet	Default: 3 Range: 0, 3	180
A1-06 (127)	Application Preset Application Sel	0: General-purpose 8: Pump 9: Pump w/PI 10: Fan 11: Fan w/PI Note: This parameter is not settable. It is used as a monitor only.	Default: 0 Range: 0; 8 to 11	82
E1-01 (300)	Input Voltage Setting Input Voltage	This parameter must be set to the power supply voltage. WARNING! Electrical Shock Hazard. Drive input voltage (not motor voltage) must be set in E1-01 for the protective features of the drive to function properly. Failure to do so may result in equipment damage and/or death or personal injury.	Default: 460 V <1> Min.: 310 Max.: 510 <1>	109
E1-05 (304)	Maximum Voltage Max Voltage	Only applicable when E1-03 is set to F.	Default: <3> Min.: 0.0 V Max.: 510.0 V <1>	112
E2-01 (030E)	Motor Rated Current Motor Rated FLA	Sets the motor nameplate full load current in amps. Automatically set during Auto-Tuning.	Default: <1> Min.: 10% of drive rated current Max.: 200% of drive rated current <2>	113
Z3-02 (8501) <input type="checkbox"/> RUN	Serial Communications Node Address Select Node Address	Selects the bypass serial communications node address.	Default: 1 Min.: 0 Max.: 127	180

4.3 The Drive and Programming Modes

No.	Name	Description	Values	Page
Z3-03 (8502) <input type="checkbox"/> RUN	Serial Communications Baud Rate Select Baud Rate	Selects the bypass serial communications speed. 0: 1200 1: 2400 2: 4800 3: 9600 4: 19200 5: 38400 6: 57600 7: 76800 8: 115200	Default: 3 Range: 0 to 8	180
Z3-04 (8503) <input type="checkbox"/> RUN	Serial Communications Parity Select Parity	Selects the bypass serial communications parity. 0: No Parity 1: Even Parity 2: Odd Parity	Default: 0 Range: 0 to 2	181
Z3-05 (8504) <input type="checkbox"/> RUN	Serial Communications Fault Select Fault Select	Selects the action to take when a serial communications fault is detected. 0: Ignore. A serial communications loss will result in no action being taken. 1: Alarm only. 2: Fault with EF0. An EF0 will be sent to the drive. If running in Bypass, the bypass contactor will NOT open and the motor will keep running. 3: Fault with EF0 and Open Contactors. An EF0 fault will be sent to the drive and the bypass contactor (K3) will be opened. 4: Alarm and run at preset speed set in Z3-10. Display AL14 alarm on Operator	Default: 1 Range: 0 to 4	335
Z3-06 (8505) <input type="checkbox"/> RUN	Serial Communications Fault Time Select Fault Time	Sets the time allowed to elapse since receiving serial communications before triggering a communications fault. A setting of 0.0 will never time out.	Default: 2.0 s Min.: 0.0 Max.: 99.9	181
Z3-07 (8506) <input type="checkbox"/> RUN	Serial Communications Receive to Transmit Wait Time Rx to Tx Wait	Sets the time to delay a serial communications response to a serial communications command. This parameter will only appear when Z3-01 = 0, 1, or 2.	Default: 5 ms Min.: 0 Max.: 99 ms	181
Z3-08 (8507) <input type="checkbox"/> RUN	BACnet Device Object Identifier 0 BAC Dev ID0	BACnet only. Sets the least significant word of 22-bit virtual address. This parameter will appear only when Z3-01 = 3.	Default: 1 Min.: 0 Max.: FFFF	181
Z3-09 (8508) <input type="checkbox"/> RUN	BACnet Device Object Identifier 1 BAC Dev ID1	BACnet only. Sets the most significant word of 22-bit virtual address. This parameter will appear only when Z3-01 = 3.	Default: 0 Min.: 0 Max.: 003F	181

<1> Values shown are specific to 480 Vac bypass drives.

<2> The number of decimal places in the parameter value depends on the drive model. *Refer to Defaults by Drive Model on page 298* for details.

<3> Default setting is dependent on parameter o2-04, Drive Model Selection.

<4> Default value is 0 in bypass controller software versions VST800298 and earlier.

<5> Setting 2 is available in bypass controller software versions VST800298 and later.

4.4 Powering Up the Drive

4.4 Powering Up the Drive



◆ Powering Up the Drive and Operation Status Display

■ Powering Up the Drive

Review the following checklist before turning the power on.

Item to Check	Description
Power supply voltage	208 Vac Bypass Drive: Three-phase 200 to 240 Vac 50/60 Hz 480 Vac Bypass Drive: Three-phase 380 to 480 Vac 50/60 Hz
	Properly wire the power supply input terminals (L1, L2, L3).
	Check for proper grounding of drive and motor.
Drive output terminals and motor terminals	Properly wire drive output terminals T1, T2, and T3 with motor terminals U, V, and W.
Control circuit terminals	Check control circuit terminal connections.
Drive control terminal status	Open all control circuit terminals (off).
Status of the load and connected machinery	Decouple the motor from the load.

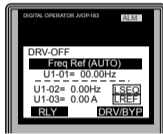
■ Status Display

Status	Name	Description
Normal Operation		The data display area displays the frequency reference. [DRV] is lit.
Fault	 External fault (example)	Data displayed varies by the type of fault. <i>Refer to Fault Displays, Causes, and Possible Solutions on page 194</i> for more information. [ALM] and [DRV] are lit.

4.5 Start-Up Procedure

Follow the steps and procedures outlined below to help ensure proper start-up of the P1000 Bypass.

◆ Bypass Start-Up Preparation

1. Remove power to the P1000 Bypass and verify using a multimeter. Follow all appropriate lockout/tagout procedures.

WARNING! *Electrical Shock Hazard. Do not remove covers or touch circuit boards while the power is on. Failure to comply could result in death or serious injury.*

2. Record the motor nameplate information and verify that the input voltage matches the P1000 Bypass rating. Verify that the motor rated FLA does not exceed the rated output rating of the bypass unit, and verify that the motor FLA falls in the rated range of the thermal overload relay (if present).
3. The P1000 Bypass provides an input circuit breaker. The adjustable trip level must be set using the two dials located on the circuit breaker. The dial marked "FLA" sets the breaker to match the motor FLA. Use a small straight-edge screwdriver and adjust to the appropriate current level. The other dial sets the inrush level. Make sure this dial is set to "Auto 1" (factory setting).
4. Verify that three-phase line power is connected to input circuit breaker.
5. Verify that the grounding terminal of the P1000 Bypass is attached to the appropriate building ground circuit.
6. Verify that wiring connections are properly terminated and connected to appropriate circuits at PCB A2 using the P1000 connection diagram. **Refer to Standard Connection Diagram on page 42** for details.

Please note the following in regards to the safety circuit (DI-2, terminal TB2-2) and the BAS interlock circuit (DI-3, terminal TB3-3):

Safety Interlock Circuit

DI-2 (terminal TB2-2) is provided to connect safety devices in a normally-closed series circuit, such as: freeze up thermostats, smoke/fire sensors, high pressure limits, temperature limits, or vibration detectors.

The HOA keypad will display a Safety Open fault if a N.C. safety circuit is not closed between DI-2 (TB2-2) and IG24 (TB2-10) on PCB A2 at power-up with a Run command in HAND or AUTO mode. An open circuit between DI-2 (TB2-2) and IG24 (TB2-10) will prevent bypass operation.

Take one of the following steps to ensure proper operation prior to startup:

Install a N.C. safety circuit between DI-2 (TB2-2) and IG24 (TB2-10) on PCB A2.

Install a jumper between DI-2 (TB2-2) and IG24 (TB2-10) on PCB A2.

Building Automation System Interlock Circuit (Drive and Bypass Enable Input)

The HOA keypad will display "INTRLOCK OPN" to indicate a BAS Interlock fault is a N.C. safety circuit is not closed between DI-3 (TB2-3) and IG24 (TB2-10) on PCB A2 at power-up with a Run command in HAND or AUTO mode. An open circuit between DI-3 (TB2-3) and IG24 (TB2-10) will prevent bypass operation.

This condition is a fault and will prevent drive and bypass operation.

Take one of the following steps to ensure proper operation prior to startup:

Install a N.C. BAS Interlock Circuit/Damper Interlock between DI-3 (TB2-3) and IG24 (TB2-10) on PCB A2.

Install a jumper between DI-3 (TB2-3) and IG24 (TB2-10) on PCB A2.

7. Verify that the motor is wired for the application voltage if it is a dual voltage motor.
8. Connect the motor to the output terminals of the motor overload.
9. Set the motor overload for the proper FLA of the motor.
10. Verify that the motor ground is connected to the P1000 Bypass drive ground terminal.
11. Record all other connections to the P1000 Bypass by terminal number to determine if special programming of any of the following is required:
 - Multi-function Digital Inputs – Bypass control board TB2 (A2)
 - Multi-function Digital Outputs – Bypass control board TB1 (A2)
 - Analog Inputs – Drive control board (A1)
 - Analog Outputs – Drive control board (A1)
 - Differential PI control – Bypass control board (A2)
 - Serial Communications – Bypass control board TB3 (A2)

4.5 Start-Up Procedure

12. Verify that all control wiring is run in separate conduit from motor or line power and route digital output wiring exceeding 24 V in conduit separate from other control wiring.
13. Verify that the building automation system logic is ready for the start, stop, and speed command functions.

■ Precautions for Connected Machinery











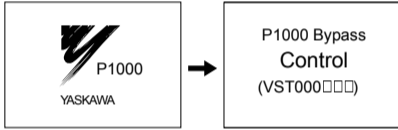
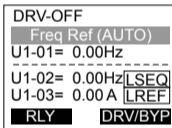

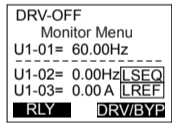
WARNING! Sudden Movement Hazard. Clear all personnel from the drive, motor, and machine area before applying power. System may start unexpectedly upon application of power, causing death or serious injury.

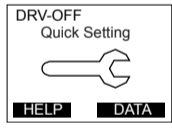
WARNING! Sudden Movement Hazard. Always check the operation of any fast stop circuits after they are wired. Fast stop circuits are required to provide safe and quick shutdown of the drive. Prepare to initiate an emergency stop during the test run. Operating a drive with untested emergency circuits could result in death or serious injury.

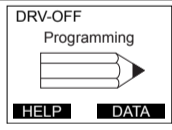
- The motor should come to a complete stop without problems.
- Connect the load and machinery to the motor.
- Fasten all installation screws properly and check that the motor and connected machinery are held in place.

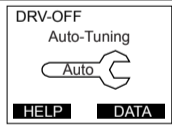

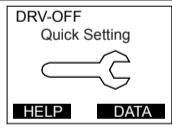

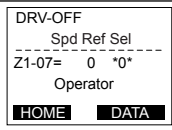







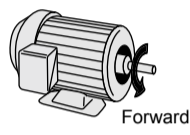

◆ Bypass Start-Up Procedure

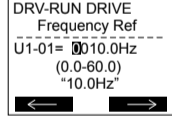
After completing the steps in *Bypass Start-Up Preparation*, replace all P1000 Bypass and drive covers. Connect one end of the HOA keypad cable to the Bypass control board A2 and one end to the door-mounted HOA keypad.







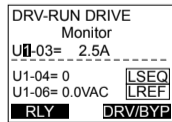

Step		Display/Result
1.	Remove any power source lockouts on the P1000 Bypass then turn the main input disconnect handle clockwise to energize the P1000 Bypass. <i>Refer to Input Circuit Breaker on page 32</i> for details. Use a multimeter to check all three-phase voltages for proper levels and balance and record these levels for future reference. During this sequence, the control logic will briefly (< 3 s) perform a self-test to ensure proper operation.	
2.	The keypad will now display the main startup screen showing that the P1000 Bypass is in Drive mode and currently OFF. It also shows that the Bypass is in "AUTO" mode while displaying the frequency reference.	
3.	Press  one time to display the Monitor Menu. All available drive and bypass monitors can be viewed from this menu. <i>Refer to Parameter List on page 255</i> for a complete list of monitors.	
4.	Press  one time to display the Quick Settings Menu. This is a condensed parameter set specifically selected for the initial drive start-up.	
5.	Press  one time to display the Programming Menu. All available drive and bypass parameters can be accessed through this menu.	
6.	Press  one time to display the Auto-Tuning Menu. The Auto-Tuning function tunes the drive set-up to the characteristics of the motor to which it is applied. Auto-Tuning is essential if bi-directional Speed Search is required and enabled for the application.	
7.	Press  or  until the Quick Settings Menu screen is displayed.	
8.	Press  to access the Quick Settings parameters and adjust each parameter to the appropriate setting for the application. <i>Refer to Quick Setting Parameters on page 68</i> for the list of parameters available in the Quick Setting Menu.	

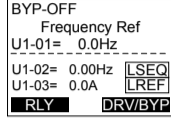
Checking the motor rotation in Drive and Bypass Modes.

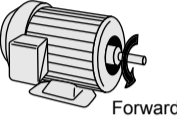
4.5 Start-Up Procedure

Step		Display/Result
Motor Rotation in Drive Mode		
1.	Press  to give the drive a Run command from HAND mode. The HAND light will turn on and the motor will rotate at the value set to parameter Z1-09 (10 Hz default).	
2.	Ensure the motor is rotating in the correct direction and that no faults or alarms occur.	
3.	If the direction of motor rotation is incorrect, press  to stop the motor. The HAND light turns OFF and the motor coasts to stop. Skip to step 6 if the direction of motor rotation is correct.	
4.	Turn off the power to the P1000 Bypass. WARNING! Electrical Shock Hazard. Do not touch any terminals before the capacitors have fully discharged. Failure to comply could result in death or serious injury. Before servicing, disconnect all power to the equipment. The internal capacitor remains charged even after the power supply is turned off. The charge indicator LED will extinguish when the DC bus voltage is below 50 Vdc. To prevent electric shock, wait for at least the time specified on the warning label, once all indicators are OFF, measure for unsafe voltages to confirm the drive is safe prior to servicing. Switch the wires for T1 and T2 on the output terminals of the motor overload relay. Re-tighten the terminal lugs and reapply power.	-
5.	Reapply the power, press  and re-check the rotation direction.	-
6.	Verify that the system is ready to operate at full speed by making sure that the building automation system logic is ready for the start, stop, and speed command functions.	-
7.	Press  to increase the frequency reference in increments of 10 Hz, verifying smooth operation at all speeds. For each frequency, check the drive output current using monitor U1-03. The current should be well below the motor rated current.	
8.	Press  ,  , or  to navigate the cursor through the numerical positions. Use  and  to change the value of the selected numerical place.	-
9.	Press  to confirm the new frequency reference; the drive will begin to accelerate or decelerate.	-
10.	Check the motor current using U1-03 then measure the output voltage (Line-to-Line and Line-to-Ground) using a multimeter and record the values for future reference. Press  to stop the motor.	

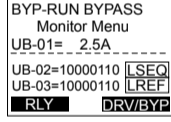
4.5 Start-Up Procedure

Step		Display/Result
Motor Rotation in Bypass Mode		
<p>11. Press  to toggle to the Bypass Mode. The keypad display should show BYP-OFF if the device is ready for Bypass operation.</p>	→	
<p>12. Bump the motor by pressing  then quickly pressing . Ensure the motor is rotating in the correct direction and that no faults or alarms occur.</p>	→	<p style="text-align: center;">Motor</p> 
<p>13. If the direction of motor rotation is incorrect, press  to stop the motor. The HAND light turns OFF and the motor coasts to stop. Skip to step 15 if the direction of motor rotation is correct.</p>	→	
<p>14. Turn off the power to the P1000 Bypass.</p> <p>WARNING! Electrical Shock Hazard. Do not touch any terminals before the capacitors have fully discharged. Failure to comply could result in death or serious injury. Before servicing, disconnect all power to the equipment. The internal capacitor remains charged even after the power supply is turned off. The charge indicator LED will extinguish when the DC bus voltage is below 50 Vdc. To prevent electric shock, wait for at least the time specified on the warning label, once all indicators are OFF, measure for unsafe voltages to confirm the drive is safe prior to servicing.</p> <p>Switch the wires for L1 and L2 on the bypass input circuit breaker. Re-tighten the terminal lugs and reapply power.</p>	-	-
<p>15. Run the motor in Bypass Mode using  and check the motor current using UB-01. Then measure the output voltage (Line-to-Line and Line-to-Ground) using a multimeter and record the values for future reference.</p>	→	
<p>16. The P1000 Bypass should operate normally. Press  to stop the motor. The HAND light is OFF and the motor coasts to stop.</p>	-	-

4.6 Application Selection

Several Application Presets are available to facilitate drive setup for commonly used applications. Selecting one of these Application Presets automatically assigns functions to the input and output terminals, and sets certain parameters to values appropriate for the application that was selected.

Note: An Application Preset can only be selected if all drive parameters are on at their original default settings. It may be necessary to initialize the drive by setting Z1-01 to 1 or 3 prior to selecting an Application Preset.

4.7 Auto-Tuning

4.7 Auto-Tuning

◆ Types of Auto-Tuning

Refer to the tables below to select the type of Auto-Tuning that best suits the application.

■ Auto-Tuning for Induction Motors

This feature automatically sets the V/f pattern and motor parameters E1-□□ and E2-□□ for an induction motor.

Table 4.6 Types of Auto-Tuning for Induction Motors

Type	Setting	Application Conditions and Benefits	Control Mode
			V/f
Stationary Auto-Tuning for Line-to-Line Resistance	T1-01 = 2	<ul style="list-style-type: none"> The drive is used in V/f Control and other Auto-Tuning selections are not possible. Drive and motor capacities differ. This setting tunes the drive after the cable between the drive and motor has been replaced with a cable over 50 m long, assuming that Auto-Tuning has already been performed. This setting should not be used for any vector control modes unless the motor cable has changed. 	YES
Rotational Auto-Tuning for V/f Control	T1-01 = 3	<ul style="list-style-type: none"> This setting is recommended for applications using Speed Estimation Speed Search or using the Energy Saving function in V/f Control. This setting assumes that the motor can rotate while Auto-Tuning is executed and it increases accuracy for certain functions like torque compensation, slip compensation, Energy Saving, and Speed Search. 	YES

Table 4.7 lists the data that must be entered for Auto-Tuning. Make sure this data is available before starting Auto-Tuning. The necessary information is usually listed on the motor nameplate or in the motor test report provided by the motor manufacturer.

Table 4.7 Auto-Tuning Input Data

Input Value	Input Parameter	Unit	Tuning Type (T1-01)	
			2 Line-to-Line Resistance	3 Rotational for V/f Control
Motor rated power	T1-02	kW	YES	YES
Motor rated voltage	T1-03	Vac	–	YES
Motor rated current	T1-04	A	YES	YES
Motor rated frequency	T1-05	Hz	–	YES
Number of motor poles	T1-06	-	–	YES
Motor rated Speed	T1-07	r/min	–	YES
Motor iron loss	T1-11	W	–	YES

◆ Before Auto-Tuning the Drive

Check the items below before Auto-Tuning the drive.

■ Basic Auto-Tuning Preparations

- Auto-Tuning requires the user to input data from the motor nameplate or motor test report. Make sure this data is available before Auto-Tuning the drive.
- For best performance, the drive input supply voltage must be at least equal to or greater than the motor rated voltage.

Note: Better performance is possible when using a motor with a base voltage that is lower than the input supply voltage (20 V for 208 V bypass drive models and 40 V for 480 V bypass drive models). This is particularly important when operating the motor above 90% of base speed, where high torque precision is required.
- To cancel Auto-Tuning, press the OFF key on the HOA keypad.
- When using a motor contactor, make sure it is closed throughout the Auto-Tuning process.

Table 4.8 Auto-Tuning Input Data

Motor Type	Auto-Tuning Type	Digital Input	Digital Output
Induction Motor	Stationary Auto-Tuning for Line-to-Line Resistance	Digital input functions are disabled.	Maintains the status at the start of Auto-Tuning
	Rotational Auto-Tuning for V/f Control		Functions the same as during normal operation

■ Notes on Stationary Auto-Tuning

Stationary Auto-Tuning modes analyze motor characteristics by injecting current into the motor for approximately one minute.

WARNING! Electrical Shock Hazard. When executing stationary Auto-Tuning, voltage is applied to the motor before the motor rotates. Do not touch the motor until Auto-Tuning is completed. Failure to comply may result in injury or death from electrical shock.

WARNING! Sudden Movement Hazard. If installed, do not release the mechanical brake during Stationary Auto-Tuning. Inadvertent brake release may cause damage to equipment or injury to personnel. Ensure that the mechanical brake release circuit is not controlled by the drive multi-function digital outputs.

Stationary Auto-Tuning for Line-to-Line Resistance

- Perform when entering motor data manually while using motor cables longer than 50 m.
- If the motor cables have been replaced with cables more than 50 m long after Auto-Tuning has already been performed, use Stationary Auto-Tuning for line-to-line resistance.

◆ Auto-Tuning Interruption and Fault Codes

If tuning results are abnormal or the OFF key is pressed before completion, Auto-Tuning will be interrupted and a fault code will appear on the HOA keypad.

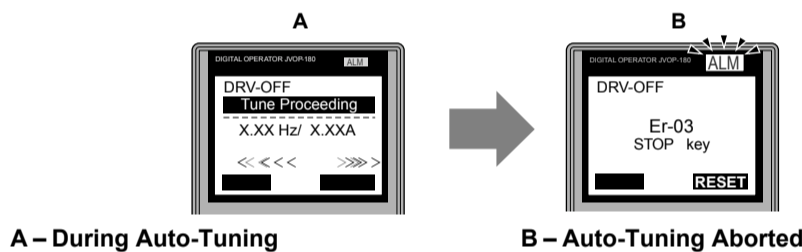

Figure 4.11 Auto-Tuning Aborted Display

◆ Auto-Tuning Operation Example

The following example demonstrates Rotational Auto-Tuning for V/f.

■ Selecting the Type of Auto-Tuning

Step		Display/Result
1.	Turn on the power to the drive. The initial display appears.	
2.	Press ▲ or ▼ until the Auto-Tuning display appears.	
3.	Press ENTER to begin setting parameters.	
4.	Press ENTER to display the value for T1-01.	



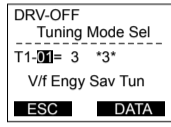







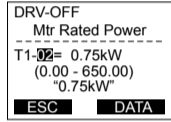

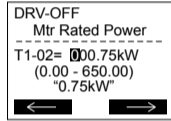
4.7 Auto-Tuning

Step		Display/Result
5.	Save the setting by pressing  .	Entry Accepted
6.	The display automatically returns to the display shown in Step 3.	

■ Enter Data from the Motor Nameplate

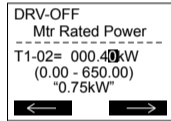
After selecting the type of Auto-Tuning, enter the data required from the motor nameplate.

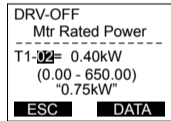
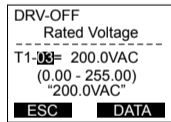
Note: These instructions continue from Step 6 in “Selecting the Type of Auto-Tuning”.

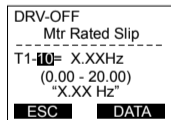
Step		Display/Result
1.	Press  to access the motor output power parameter T1-02.	
2.	Press  to view the default setting.	
3.	Press  left,  right,  ,  , and  to enter the motor power nameplate data in kW.	
4.	Press  to save the setting.	Entry Accepted
5.	The display automatically returns to the display in Step 1.	
6.	Repeat Steps 1 through 5 to set the following parameters: <ul style="list-style-type: none"> • T1-03, Motor Rated Voltage • T1-04, Motor Rated Current • T1-05, Motor Base Frequency • T1-06, Number of Motor Poles • T1-07, Motor Base Frequency 	  

Note:

1. For details on each setting, *Refer to T1: Parameter Settings during Induction Motor Auto-Tuning on page 79.*
2. To execute Stationary Auto-Tuning for line-to-line resistance only, set parameters T1-02 and T1-04.

Starting Auto-Tuning



WARNING! Sudden Movement Hazard. The drive and motor may start unexpectedly during Auto-Tuning, which could result in death or serious injury. Ensure the area surrounding the drive motor and load are clear before proceeding with Auto-Tuning.

WARNING! Electrical Shock Hazard. High voltage will be supplied to the motor when Stationary Auto-Tuning is performed even with the motor stopped, which could result in death or serious injury. Do not touch the motor until Auto-Tuning has been completed.

NOTICE: Rotational Auto-Tuning will not function properly if the motor cannot spin freely. Failure to comply could result in improper operation of the drive. Ensure the motor can freely spin before beginning Auto-Tuning.

Enter the required information from the motor nameplate. Press  to proceed to the Auto-Tuning start display.

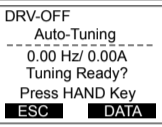
Note: These instructions continue from Step 6 in “Enter Data from the Motor Nameplate”.

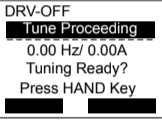
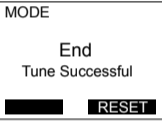
Step	Display/Result
1. After entering the data listed on the motor nameplate, press  to confirm.	
2. Press  to activate Auto-Tuning. DRV flashes. The drive begins by injecting current into the motor for about 1 min, and then starts to rotate the motor.	
3. Auto-Tuning finishes in approximately one to two minutes.	

T1: Parameter Settings during Induction Motor Auto-Tuning

The T1-□□ parameters set the Auto-Tuning input data for induction motor tuning.

Note: For motors operating in the field weakening range, first perform the Auto-Tuning with the base data. After Auto-Tuning is complete, change E1-04, Maximum Output Frequency, to the desired value.

T1-01: Auto-Tuning Mode Selection

Sets the type of Auto-Tuning to be used. Refer to the User Manual packaged with the drive for details on the different types of Auto-Tuning.

No.	Name	Setting Range	Default
T1-01	Auto-Tuning Mode Selection	2, 3	2

Setting 2: Stationary Auto-Tuning for Line-to-Line Resistance

Setting 3: Rotational Auto-Tuning for V/f Control Energy Saving

T1-02: Motor Rated Power

Sets the motor rated power according to the motor nameplate value.

Note: Use the following formula to convert HP to kW: kW = HP x 0.746.

No.	Name	Setting Range	Default
T1-02	Motor Rated Power	0.00 to 650.00 kW	Determined by o2-04

T1-03: Motor Rated Voltage

Sets the motor rated voltage according to the motor nameplate value. Enter the voltage base speed when the motor operates above base speed. Enter the voltage needed to operate the motor under no-load conditions at rated speed to T1-03.

No.	Name	Setting Range	Default
T1-03	Motor Rated Voltage	0.0 to 255.0 V ^{<I>}	200.0 V ^{<I>}

<I> Values shown are specific to 200 V Class. Double the value for 400 V Class.

4.7 Auto-Tuning

■ T1-04: Motor Rated Current

Sets the motor rated current according to the motor nameplate value. Enter the current at the motor base speed.

No.	Name	Setting Range	Default
T1-04	Motor Rated Current	10.0 to 300.0% of drive rated current	Determined by o2-04

■ T1-05: Motor Base Frequency

Sets the motor rated frequency according to the motor nameplate value. If a motor with an extended speed range is used or the motor is used in the field weakening area, enter the maximum frequency to E1-04 after Auto-Tuning is complete.

No.	Name	Setting Range	Default
T1-05	Motor Base Frequency	0.0 to 240.0 Hz	60.0 Hz

■ T1-06: Number of Motor Poles

Sets the number of motor poles according to the motor nameplate value.

No.	Name	Setting Range	Default
T1-06	Number of Motor Poles	2 to 48	4

■ T1-07: Motor Base Speed

Sets the motor rated speed according to the motor nameplate value. Enter the speed at base frequency when using a motor with an extended speed range or if using the motor in the field weakening area.

No.	Name	Setting Range	Default
T1-07	Motor Base Speed		1750 r/min

■ T1-11: Motor Iron Loss

Provides iron loss information to determine the Energy Saving coefficient. T1-11 will first display the value for the motor iron loss that the drive automatically calculated when the motor capacity was entered to T1-02. Enter the motor iron loss value listed to T1-11 if the motor test report is available.

No.	Name	Setting Range	Default
T1-11	Motor Iron Loss	0 to 65535 W	14 W

5

Programming

This chapter provides details of drive parameters for advanced configuration. These parameters are accessible via the drive HOA keypad.

5.1	A: INITIALIZATION.....	82
5.2	B: APPLICATION.....	83
5.3	C: TUNING.....	103
5.4	D: REFERENCE SETTINGS.....	106
5.5	E: MOTOR PARAMETERS.....	109
5.6	F: OPTIONS.....	114
5.7	H: TERMINAL FUNCTIONS.....	115
5.8	L: PROTECTION FUNCTIONS.....	134
5.9	N: SPECIAL ADJUSTMENTS.....	148
5.10	O: OPERATOR-RELATED SETTINGS.....	150
5.11	S: SPECIAL PARAMETERS.....	154
5.12	U: MONITOR PARAMETERS.....	161
5.13	Z: BYPASS PARAMETERS.....	162

5.1 A: Initialization

5.1 A: Initialization

The initialization group contains parameters associated with initial drive setup, including parameters involving the display language, access levels, initialization, and password.

◆ A1: Initialization

■ A1-06: Application Preset

Several Application Presets are available to facilitate drive setup for commonly used applications. Selecting one of these Application Presets automatically assigns functions to the input and output terminals and sets a predefined group of parameters to values appropriate for the selected application.

Refer to Application Selection on page 75 for details on parameter A1-06.

5.2 b: Application

◆ b1: Operation Mode Selection

■ b1-03: Stopping Method Selection

Selects how the drive stops the motor when the Run command is removed or when a Stop command is entered.

No.	Parameter Name	Setting Range	Default
b1-03	Stopping Method Selection	0 to 3	1

Setting 0: Ramp to Stop

When the Run command is removed, the drive will decelerate the motor to stop. The deceleration rate is determined by the active deceleration time. The default deceleration time is set to parameter C1-02.

When the output frequency falls below the level set in parameter b2-01, the drive will start DC injection or Short Circuit Braking depending on the selected control mode.

Setting 1: Coast to Stop

When the Run command is removed, the drive will shut off its output and the motor will coast (uncontrolled deceleration) to stop. The stopping time is determined by the inertia and the friction in the driven system.

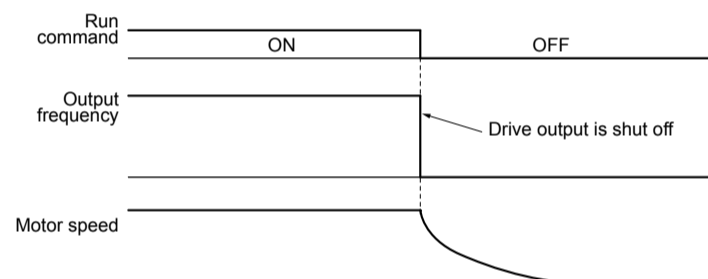

Figure 5.1 Coast to Stop

Note: After a stop is initiated, any subsequent Run command entered will be ignored until the minimum baseblock time (L2-03) has expired. Do not enter Run command until it has come to a complete stop. Use DC Injection at Start (*Refer to b2-03: DC Injection Braking Time at Start on page 85*) or Speed Search (*Refer to b3: Speed Search on page 85*) to restart the motor before it has completely stopped.

Setting 2: DC Injection Braking to Stop

When the Run command is removed, the drive will enter baseblock (turn off its output) for the minimum baseblock time (L2-03). When the minimum baseblock time has expired, the drive will inject the amount DC current set in parameter b2-02^{<1>} into the motor windings to brake the motor. The stopping time in DC Injection Braking to Stop is significantly faster compared to Coast to Stop.

^{<1>} Details on this function can be found in the standard P1000 Technical Manual (SIEPYAIP1U01) at www.yaskawa.com.

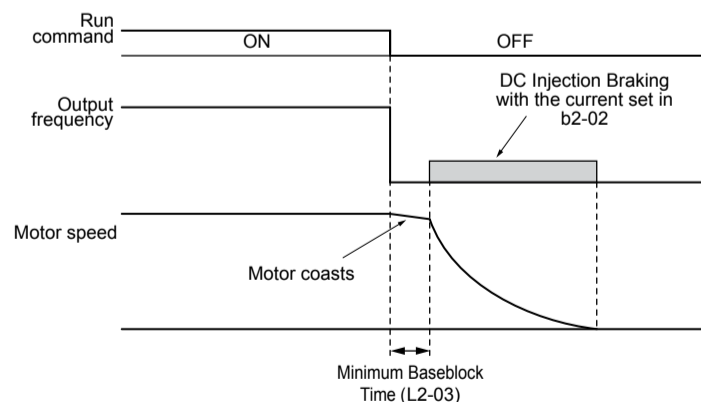

Figure 5.2 DC Injection Braking to Stop

5.2 b: Application

DC Injection Braking time is determined by the value set to b2-04 and the output frequency at the time the Run command is removed. It can be calculated by:

$$\text{DC Injection brake time} = \frac{(b2-04) \times 10 \times \text{Output frequency}}{\text{Maximum output frequency (E1-04)}}$$

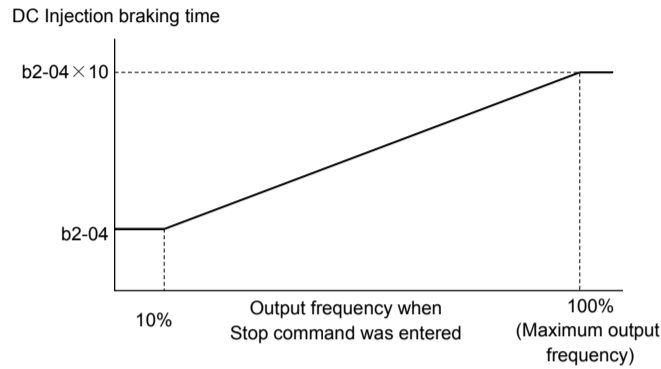

Figure 5.3 DC Injection Braking Time Depending on Output Frequency

Note: If an overcurrent (oC) fault occurs during DC Injection Braking to Stop, lengthen the minimum baseblock time (L2-03) until the fault no longer occurs.

Setting 3: Coast with Timer

When the Run command is removed, the drive will turn off its output and the motor will coast to stop. The drive will not start if a Run command is input before the time t (C1-02) has expired. Cycle the Run command that was activated during time t after t has expired to start the drive.

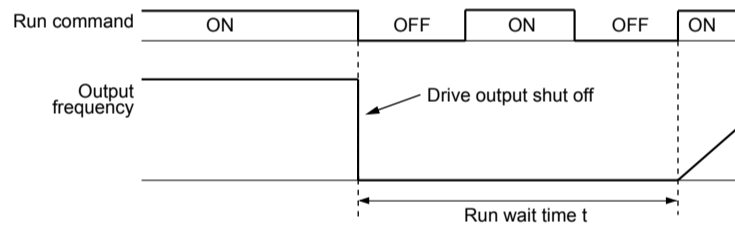

Figure 5.4 Coast with Timer

The wait time t is determined by the output frequency when the Run command is removed and by the active deceleration time.

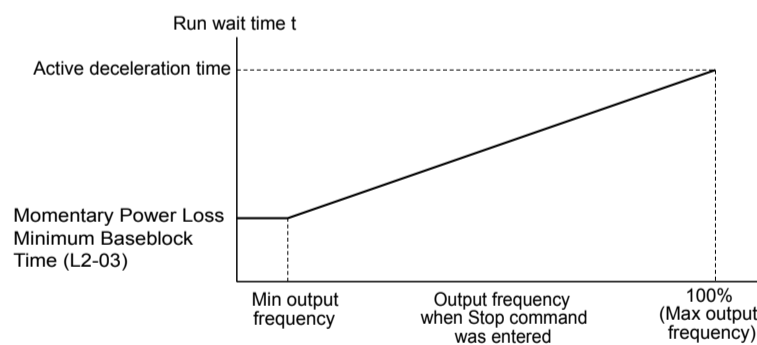

Figure 5.5 Run Wait Time Depending on Output Frequency

■ b1-04: Reverse Operation Selection

Enables and disables Reverse operation. For some applications, reverse motor rotation is not appropriate and may cause problems (e.g., air handling units, pumps, etc.).

No.	Parameter Name	Setting Range	Default
b1-04	Reverse Operation Selection	0, 1	1

Setting 0: Reverse Enabled

Possible to operate the motor in both forward and reverse directions.

Setting 1: Reverse Disabled

Drive disregards a Reverse run command or a negative frequency reference.

◆ b2: DC Injection Braking and Short Circuit Braking

These parameters determine operation of the DC Injection Braking, Zero Speed Control, and Short Circuit Braking features.

■ b2-01: DC Injection Braking Start Frequency

Active when “Ramp to Stop” is selected as the stopping method (b1-03 = 0).

No.	Name	Setting Range	Default
b2-01	DC Injection Braking Start Frequency	0.0 to 10.0 Hz	0.5 Hz

b2-01 sets the starting frequency for DC Injection Braking at Stop. When the output frequency falls below the setting of b2-01, DC Injection Braking is enabled for the time set in parameter b2-04.

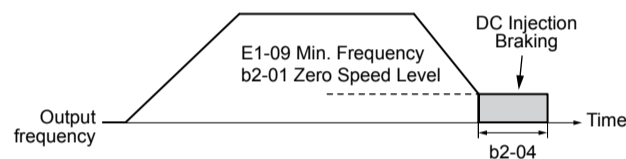

Figure 5.6 DC Injection Braking at Stop for V/f

Note: If b2-01 is set to a smaller value than parameter E1-09 (minimum frequency), then DC Injection Braking will begin as soon as the frequency falls to the value set to E1-09.

■ b2-02: DC Injection Braking Current

Sets the DC Injection Braking current as a percentage of the drive rated current. The carrier frequency is automatically reduced to 1 kHz when this parameter is set to more than 50%.

No.	Name	Setting Range	Default
b2-02	DC Injection Braking Current	0 to 100%	50%

The level of DC Injection Braking current affects the strength of the magnetic field attempting to lock the motor shaft. Increasing the current level will increase the amount of heat generated by the motor windings. Do not set this parameter higher than the level necessary to hold the motor shaft.

■ b2-03: DC Injection Braking Time at Start

Sets the time of DC Injection Braking at start. Used to stop a coasting motor before restarting it or to apply braking torque at start. Disabled when set to 0.00 s.

No.	Name	Setting Range	Default
b2-03	DC Injection Braking Time at Start	0.00 to 10.00 s	0.00 s

Note: Before starting an uncontrolled rotating motor (e.g., a fan motor driven by windmill effect), use DC Injection or Speed Search to stop the motor or detect motor speed before starting it. Otherwise, motor stalling and other faults can occur.

■ b2-04: DC Injection Braking Time at Stop

Sets the time of DC Injection Braking at stop. Used to completely stop a motor with high inertia load after ramp down. Increase the value if the motor still coasts by inertia after it should have stopped. Disabled when set to 0.00 s.

No.	Name	Setting Range	Default
b2-04	DC Injection Braking Time at Stop	0.00 to 10.00 s	0.50 s

◆ b3: Speed Search

The Speed Search function allows the drive to detect the speed of a rotating motor shaft that is driven by external forces and start the motor operation directly from the detected speed without first stopping the machine.

5.2 b: Application

Example: When a momentary loss of power occurs, the drive output shuts off and the motor coasts. When power returns, the drive can find the speed of the coasting motor and restart it directly.

For induction motors, the drive offers two types of Speed Search that can be selected by parameter b3-24 (Speed Estimation and Current Detection). Both methods are explained below and followed by a description of all relevant parameters.

■ Current Detection Speed Search (b3-24 = 0)

Current Detection Speed Search detects the motor speed by looking at motor current in IM motors. When Speed Search is started it reduces the output frequency starting from either the maximum output frequency or the frequency reference while increasing the output voltage using the time set in parameter L2-04^{<1>}. As long as the current is higher than the level set to b3-02, the output frequency is lowered using the time constant set to b3-03. If the current falls below b3-02, the drive assumes that the output frequency and motor speed are the same and accelerates or decelerates to the frequency reference.

<1> Details on this function can be found in the standard P1000 Technical Manual (SIEPYAIP1U01) at www.yaskawa.com.

Be aware that sudden acceleration may occur when using this method of Speed Search with relatively light loads.

Figure 5.7 illustrates Current Detection Speed Search operation after a momentary power loss (L2-01 must be set to 1 or 2):

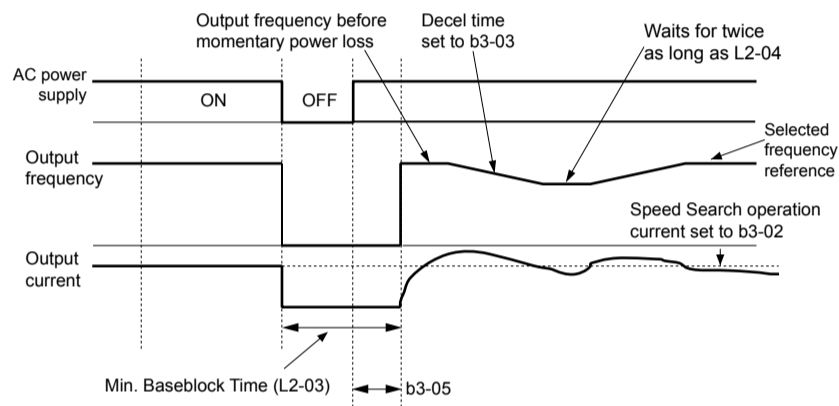

Figure 5.7 Current Detection Speed Search after Power Loss

Note: After power is restored, the drive waits until the time set to b3-05 has passed before performing Speed Search. Thereby the Speed Search may start not at the end of L2-03 but even later.

When Speed Search is applied automatically with the Run command, the drive waits for the minimum baseblock time set to L2-03 before starting Speed Search. If L2-03 is lower than the time set to parameter b3-05, then b3-05 is used as the wait time.

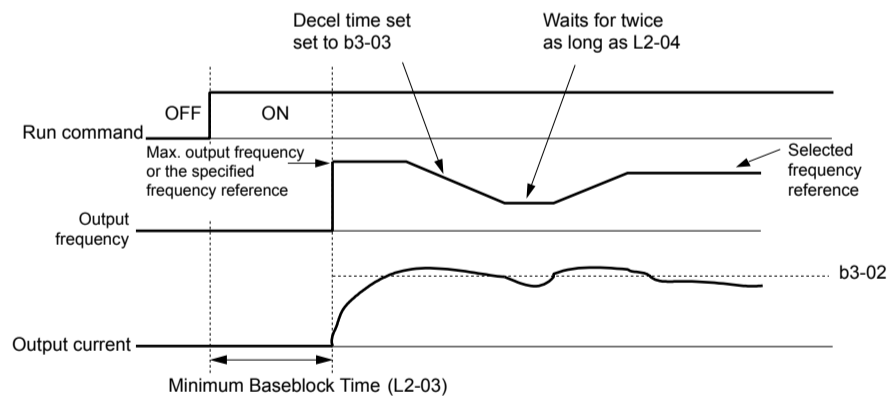

Figure 5.8 Current Detection Speed Search at Start or Speed Search Command by Digital Input

Notes on Using Current Detection Type Speed Search

- Shorten the Speed Search deceleration time set to b3-03 if an oL1 fault occurs while performing Current Detection Speed Search.
- Increase the minimum baseblock time set to L2-03 if an overcurrent or overvoltage fault occurs when performing Speed Search after power is restored following a momentary power loss.

■ **Speed Estimation Type Speed Search (b3-24 = 1)**

This method can be used for a single induction motor connected to a drive. Do not use this method if the motor is one or more frame size smaller than the drive, at motor speeds above 200 Hz, or when using a single drive to operate more than one motor.

Speed Estimation is executed in the two steps described below:

Step 1: Back EMF Voltage Estimation

This method is used by Speed Search after baseblock (e.g., a power loss where the drive CPU continued to run and the Run command was kept active). Here, the drive estimates the motor speed by analyzing the back EMF voltage and outputs the estimated frequency and increases the voltage using the time constant set in parameter L2-04^{<1>}. After that, the motor is accelerated or decelerated to the frequency reference starting from the detected speed. If there is not enough residual voltage in the motor windings to perform the calculations described above, the drive will automatically proceed to step 2.

<1> Details on this function can be found in the standard P1000 Technical Manual (SIEPYAIP1U01) at www.yaskawa.com.

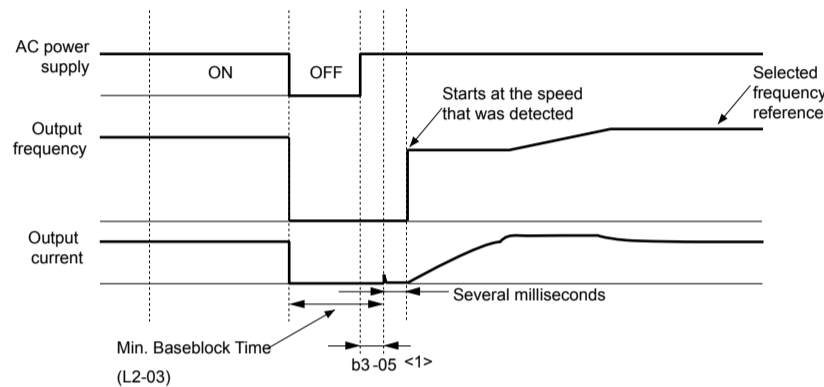

Figure 5.9 Speed Search after Baseblock

<1> After AC power is restored, the drive will wait for at least the time set to b3-05. If the power interruption is longer than the minimum baseblock time set to L2-03, the drive will wait until the time set to b3-05 has passed after power is restored before starting Speed Search.

Step 2: Current Injection

Current Injection is performed when there is insufficient residual voltage in the motor after extended power losses, when Speed Search is applied with the Run command (b3-01 = 1), or when an External search command is used.

This feature injects the amount of DC current set to b3-06 to the motor and detects the speed by measuring the current feedback. The drive then outputs the detected frequency and increases the voltage using the time constant set to parameter L2-04^{<1>} while looking at the motor current.

<1> Details on this function can be found in the standard P1000 Technical Manual (SIEPYAIP1U01) at www.yaskawa.com.

The output frequency is reduced if the current is higher than the level in b3-02. When the current falls below b3-02, the motor speed is assumed to be found and the drive starts to accelerate or decelerate to the frequency reference.

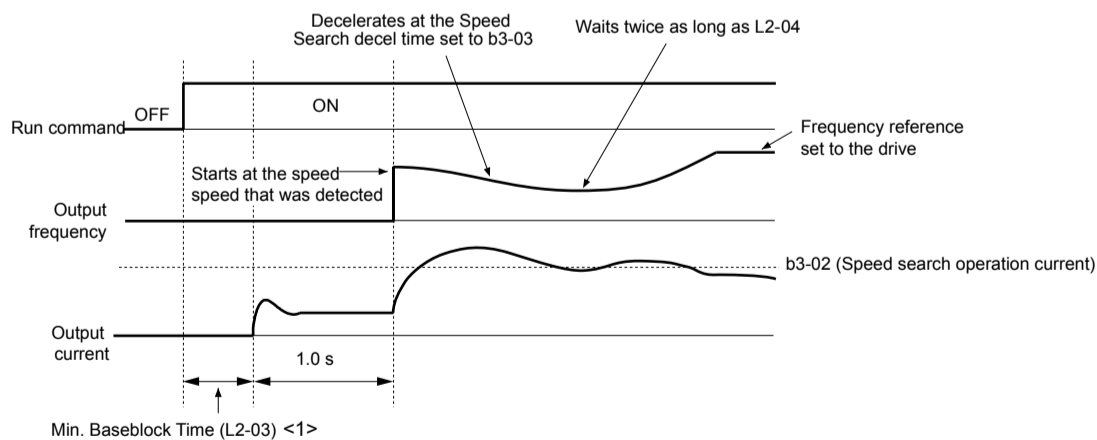

Figure 5.10 Speed Search at Start

5.2 b: Application

<1> The wait time for Speed Search (b3-05) determines the lower limit.

Notes on Using Speed Estimation Speed Search

- Perform Rotational Auto-Tuning for V/f Control (T1-01 = 3) prior to using Speed Estimation in V/f Control and perform Stationary Auto-Tuning for Line-to-Line Resistance (T1-01 = 2) again if there is a change in the cable length between the drive and motor.
- Use Current Detection to search for speeds beyond 200 Hz if the application is running multiple motors from the same drive or if the motor is considerably smaller than the capacity of the drive.
- Speed Estimation may have trouble finding the actual speed if the motor cable is very long. Use Current Detection in these instances.
- Use Current Detection instead of Speed Estimation when operating motors smaller than 1.5 kW because Speed Estimation might not be able to detect the speed or rotation of these smaller motors, in which case Speed Estimation would stop the motor.

Speed Search Activation

Speed Search can be activated using any of the methods 1 through 5 described below. The Speed Search type must be selected in parameter b3-24 independent of the activation method.

Method 1. Automatically activate Speed Search with every Run command. External Speed Search commands are ignored.

Method 2. Activate Speed Search using the digital input terminals.

Use the input functions for H1-□□ in *Table 5.1*.

Table 5.1 Speed Search Activation by Digital Inputs

Setting	Description	b3-24 = 0	b3-24 = 1
61	External Search Command 1	Closed: Activate Current Detection Speed Search from the maximum output frequency.	Activate Speed Estimation Speed Search
62	External Search Command 2	Closed: Activate Current Detection Speed Search from the frequency reference.	

To activate Speed Search by a digital input, the input must be set together with the Run command or the Run command must be entered after giving the Speed Search command.

Method 3. After automatic fault restart.

When the number of maximum fault restarts in parameter L5-01 is set higher than 0, the drive will automatically perform Speed Search as specified by b3-24 following a fault.

Method 4. After momentary power loss.

This mode requires that the Power Loss Ride-Thru function is enabled during CPU operation (L2-01 = 1 or 2). *Refer to L2-01: Momentary Power Loss Operation Selection on page 135.*

Method 5. After external baseblock is released.

The drive will resume the operation starting with Speed Search if the Run command is present and the output frequency is above the minimum frequency when the Baseblock command (H1-□□ = 8 or 9) is released.

b3-01: Speed Search Selection at Start

Determines if Speed Search is automatically performed when a Run command is issued.

No.	Parameter Name	Setting Range	Default
b3-01	Speed Search Selection at Start	0, 1	0

Setting 0: Disabled

This setting starts operating the drive at the minimum output frequency when the Run command is entered. If external Speed Search 1 or 2 is already enabled by a digital input, the drive will start operating with Speed Search.

Setting 1: Enabled

This setting performs Speed Search when the Run command is entered. The drive begins running the motor once Speed Search is complete.

b3-02: Speed Search Deactivation Current

Sets the operating current for Speed Search as a percentage of the drive rated current. Normally there is no need to change this setting. Lower this value if the drive has trouble restarting.

5.2 b: Application

No.	Name	Setting Range	Default
b3-02	Speed Search Deactivation Current	0 to 200%	120%

■ b3-03: Speed Search Deceleration Time

Sets the output frequency reduction ramp used by the Current Injection Method of Speed Estimation (b3-24 = 1). The time entered into b3-03 will be the time to decelerate from maximum frequency (E1-04) to minimum frequency (E1-09).

No.	Name	Setting Range	Default
b3-03	Speed Search Deceleration Time	0.1 to 10.0 s	2.0 s

■ b3-04: V/f Gain during Speed Search (Speed Estimation Type)

During Speed Search, the output voltage calculated from the V/f pattern is multiplied with this value. Changing this value can help reduce the output current during Speed Search.

No.	Name	Setting Range	Default
b3-04	V/f Gain during Speed Search	10 to 100%	Determined by o2-04

■ b3-05: Speed Search Delay Time

In cases where an output contactor is used between the drive and the motor, the contactor must be closed before Speed Search can be performed. This parameter can be used to delay the Speed Search operation, giving the contactor enough time to close completely.

No.	Name	Setting Range	Default
b3-05	Speed Search Delay Time	0.0 to 100.0 s	0.2 s

■ b3-06: Output Current 1 during Speed Search (Speed Estimation Type)

Sets the current injected to the motor at the beginning of Speed Estimation Speed Search as a factor of the motor rated current set in E2-01. If the motor speed is relatively slow when the drive starts to perform Speed Search after a long period of baseblock, it may be helpful to increase the setting value. The output current during Speed Search is automatically limited by the drive rated current.

No.	Name	Setting Range	Default
b3-06	Output Current 1 during Speed Search	0.0 to 2.0	Determined by o2-04

Note: Use Current Detection Speed Search if Speed Estimation is not working correctly even after adjusting b3-06.

■ b3-10: Speed Search Detection Compensation Gain (Speed Estimation Type)

Sets the gain for the detected motor speed of the Speed Estimation Speed Search. Increase the setting only if an overvoltage fault occurs when the drive restarts the motor.

No.	Name	Setting Range	Default
b3-10	Speed Search Detection Compensation Gain	1.00 to 1.20	1.05

■ b3-14: Bi-Directional Speed Search Selection (Speed Estimation Type)

Sets how the drive determines the motor rotation direction when performing Speed Estimation Speed Search.

No.	Parameter Name	Setting Range	Default
b3-14	Bi-Directional Speed Search Selection	0, 1	1

Setting 0: Disabled

The drive uses the frequency reference to determine the direction of motor rotation to restart the motor.

Setting 1: Enabled

The drive detects the motor rotation direction to restart the motor.

5.2 b: Application

■ b3-17: Speed Search Restart Current Level (Speed Estimation Type)

Sets the current level at which Speed Estimation is restarted as a percentage of drive rated current to avoid overcurrent and overvoltage problems since a large current can flow into the drive if the difference between the estimated frequency and the actual motor speed is too big when performing Speed Estimation.

No.	Name	Setting Range	Default
b3-17	Speed Search Restart Current Level	0 to 200%	150%

■ b3-18: Speed Search Restart Detection Time (Speed Estimation Type)

Sets the time for which the current must be above the level set in b3-17 before restarting Speed Search.

No.	Name	Setting Range	Default
b3-18	Speed Search Restart Detection Time	0.00 to 1.00 s	0.10 s

■ b3-19: Number of Speed Search Restarts (Speed Estimation Type)

Sets the number of times the drive should attempt to find the speed and restart the motor. If the number of restart attempts exceeds the value set to b3-19, the SER fault will occur and the drive will stop.

No.	Name	Setting Range	Default
b3-19	Number of Speed Search Restarts	0 to 10	3

■ b3-24: Speed Search Method Selection

Sets the Speed Search method.

No.	Parameter Name	Setting Range	Default
b3-24	Speed Search Method Selection	0, 1	0

Setting 0: Current Detection

Setting 1: Speed Estimation

Note: Refer to *Current Detection Speed Search (b3-24 = 0)* on page 86 and *Refer to Speed Estimation Type Speed Search (b3-24 = 1)* on page 87 for explanations of the Speed Search methods.

■ b3-25: Speed Search Wait Time

Sets the wait time between Speed Search restarts. Increase the wait time if problems occur with overcurrent, overvoltage, or if the SER fault occurs.

No.	Name	Setting Range	Default
b3-25	Speed Search Wait Time	0.0 to 30.0 s	0.5 s

■ b3-27: Speed Search Start Analog Input

Starts Speed Search at 0 or at the given analog input value.

No.	Name	Setting Range	Default
b3-27	Start Speed Search Select	0, 1	0

Setting 0: Start from 0

Setting 1: Start Speed

◆ b5: PID Control

The drive has a built-in Proportional + Integral + Derivative (PID) controller that uses the difference between the target value and the feedback value to adjust the drive output frequency to minimize deviation and provide accurate closed loop control of system variables such as pressure or temperature.

■ P Control

The output of P control is the product of the deviation and the P gain so that it follows the deviation directly and linearly. With P control, only an offset between the target and feedback remains.

■ I Control

The output of I control is the integral of the deviation. It minimizes the offset between target and feedback value that typically remains when pure P control is used. The integral time (I time) constant determines how fast the offset is eliminated.

■ D Control

D control predicts the deviation signal by multiplying its derivative (slope of the deviation) with a time constant, then adds this value to the PID input. This way the D portion of a PID controller provides a braking action to the controller response and can reduce the tendency to oscillate and overshoot.

D control tends to amplify noise on the deviation signal, which can result in control instability. Only use D control when absolutely necessary.

■ PID Operation

To better demonstrate PID functionality, **Figure 5.11** illustrates the PID output when the PID input (deviation) is at a constant level.

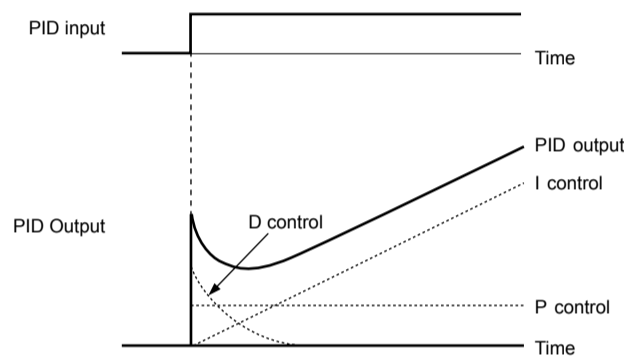

Figure 5.11 PID Operation

■ Using PID Control

Applications for PID control are listed in **Table 5.2**.

Table 5.2 Using PID Control

Application	Description	Sensors Used
Speed Control	Machinery speed is fed back and adjusted to meet the target value. Synchronous control is performed using speed data from other machinery as the target value	Tachometer
Pressure	Maintains constant pressure using pressure feedback.	Pressure sensor
Fluid Control	Keeps flow at a constant level by feeding back flow data.	Flow rate sensor
Temperature Control	Maintains a constant temperature by controlling a fan with a thermostat.	Thermocoupler, Thermistor

■ PID Setpoint Input Methods

The PID setpoint input can be input from one of the sources listed in **Table 5.3**.

If none of the sources listed in **Table 5.3** are used, the frequency reference source in b1-01 (or b1-15) or one of the inputs listed in **Table 5.3** becomes the PID setpoint.

Table 5.3 PID Setpoint Sources

PID Setpoint Source	Settings
Analog Input A1	Set H3-02 = C
Analog Input A2	Set H3-10 = C
Analog Input A3	Set H3-06 = C
MEMOBUS/Modbus Register 0006 H	Set bit 1 in register 000F H to 1 and input the setpoint to register 0006 H
Pulse Input RP	Set H6-01 = 2
Parameter b5-19	Set parameter b5-18 = 1 and input the PID setpoint to b5-19

Note: A duplicate allocation of the PID setpoint input will cause an oPE07 (Multi-Function Analog Input Selection Error) alarm.

5.2 b: Application

■ PID Feedback Input Methods

Input one feedback signal for normal PID control or input two feedback signals can for controlling a differential process value.

Normal PID Feedback

Input the PID feedback signal from one of the sources listed in *Table 5.4*:

Table 5.4 PID Feedback Sources

PID Feedback Source	Settings
Analog Input A1	Set H3-02 = B
Analog Input A2	Set H3-10 = B
Analog Input A3	Set H3-06 = B
Pulse Input RP	Set H6-01 = 1

Note: A duplicate allocation of the PID feedback input will cause an oPE07 (Multi-Function Analog Input Selection Error) alarm.

Differential Feedback

The second PID feedback signal for differential feedback can come from the sources listed in *Table 5.5*. The differential feedback function is automatically enabled when a differential feedback input is assigned.

Table 5.5 PID Differential Feedback Sources

PID Differential Feedback Source	Settings
Analog Input A1	Set H3-02 = 16 (Differential PID Feedback)
Analog Input A2	Set H3-10 = 16 (Differential PID Feedback)
Analog Input A3	Set H3-06 = 16 (Differential PID Feedback)

Note: A duplicate allocation of the PID differential feedback input will cause an oPE07 (Multi-Function Analog Input Selection Error) alarm.

■ PID Block Diagram

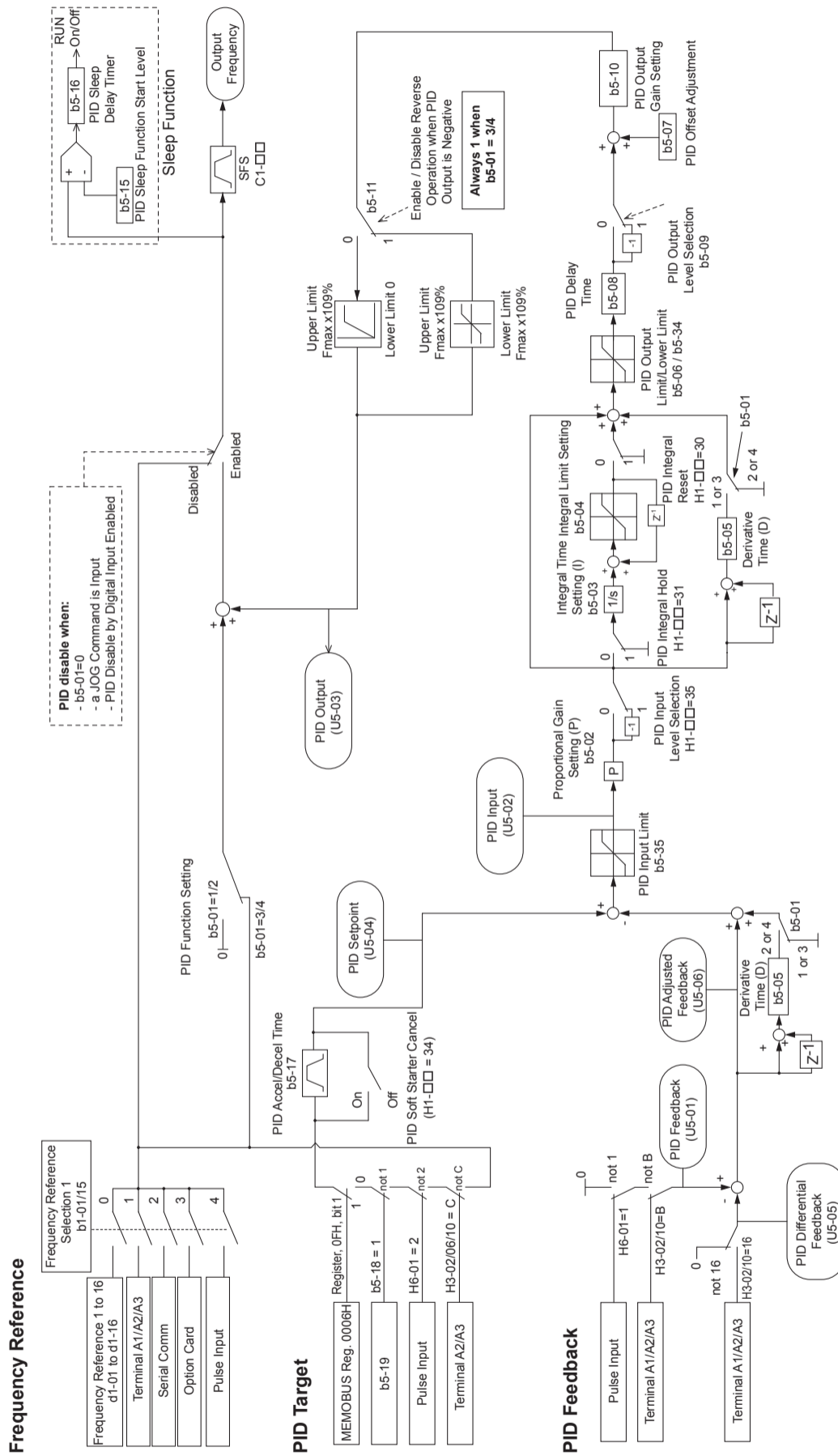

Figure 5.12 PID Block Diagram

5.2 b: Application

■ b5-01: PID Mode

Enables or disables the PID operation and selects the PID operation mode.

No.	Parameter Name	Setting Range	Default
b5-01	PID Mode	0, 1	0

Setting 0: PID Disabled

Setting 1: Enabled D = Feedback

■ b5-02: Proportional Gain Setting (P)

Sets the P gain applied to the PID input. Larger values will tend to reduce the error but may cause oscillations if set too high, while lower values may allow too much offset between the setpoint and feedback.

No.	Name	Setting Range	Default
b5-02	Proportional Gain Setting (P)	0.00 to 25.00	2.00

■ b5-03: Integral Time Setting (I)

Sets the time constant used to calculate the integral of the PID input. The shorter the integral time set to b5-03, the faster the offset will be eliminated. If the integral time is set too short, however, overshoot or oscillation may occur. To turn off the integral time, set b5-03 to 0.00.

No.	Name	Setting Range	Default
b5-03	Integral Time Setting (I)	0.0 to 360.0 s	1.0 s

■ b5-04: Integral Limit Setting

Sets the maximum output possible from the integral block as a percentage of the maximum frequency (E1-04).

No.	Name	Setting Range	Default
b5-04	Integral Limit Setting	0.0 to 100.0%	100.0%

Note: On some applications, especially those with rapidly varying loads, the output of the PID function may show a fair amount of oscillation. Program b5-04 to apply a limit to the integral output and suppress this oscillation.

■ b5-05: Derivative Time (D)

Sets the time the drive predicts the PID input/PID feedback signal based on the derivative of the PID input/PID feedback. Longer time settings improve the response but can cause instability, while shorter time settings reduce the overshoot but reduce controller responsiveness. D control is disabled by setting b5-05 to zero seconds.

No.	Name	Setting Range	Default
b5-05	Derivative Time (D)	0.00 to 10.00 s	0.00 s

■ b5-06: PID Output Limit

Sets the maximum output possible from the entire PID controller as a percentage of the maximum frequency (E1-04).

No.	Name	Setting Range	Default
b5-06	PID Output Limit	0.0 to 100.0%	100.0%

■ b5-07: PID Offset Adjustment

Sets the offset added to the PID controller output as a percentage of the maximum frequency (E1-04).

No.	Name	Setting Range	Default
b5-07	PID Offset Adjustment	-100.0 to 100.0%	0.0%

■ b5-08: PID Primary Delay Time Constant

Sets the time constant for the filter applied to the output of the PID controller. Normally, change is not required.

5.2 b: Application

No.	Name	Setting Range	Default
b5-08	PID Primary Delay Time Constant	0.00 to 10.00 s	0.00 s

Note: Useful when there is a fair amount of oscillation or when rigidity is low. Set to a value larger than the cycle of the resonant frequency. Increasing this time constant may reduce the responsiveness of the drive.

■ b5-09: PID Output Level Selection

Reverses the sign of the PID controller output signal. Normally a positive PID input (feedback smaller than setpoint) leads to positive PID output.

No.	Parameter Name	Setting Range	Default
b5-09	PID Output Level Selection	0, 1	0

Setting 0: Normal Output

A positive PID input causes an increase in the PID output (direct acting).

Setting 1: Reverse Output

A positive PID input causes a decrease in the PID output (reverse acting).

■ b5-10: PID Output Gain Setting

Applies a gain to the PID output and can be helpful when the PID function is used to trim the frequency reference (b5-01 = 3 or 4).

No.	Name	Setting Range	Default
b5-10	PID Output Gain Setting	0.00 to 25.00	1.00

■ b5-11: PID Output Reverse Selection

Determines whether a negative PID output reverses the direction of drive operation. This parameter has no effect when the PID function trims the frequency reference (b5-01 = 3 or 4) and the PID output will not be limited (same as b5-11 = 1).

Note: When using setting 1, make sure reverse operation is permitted by b1-04.

No.	Parameter Name	Setting Range	Default
b5-11	PID Output Reverse Selection	0, 1	0

Setting 0: Reverse Disabled

Negative PID output will be limited to 0 and the drive output will be stopped.

Setting 1: Reverse Enabled

Negative PID output will cause the drive to run in the opposite direction.

■ PID Feedback Loss Detection

The PID feedback loss detection function detects broken sensors or broken sensor wiring. It should be used when PID control is enabled to prevent critical machine conditions (e.g., acceleration to max. frequency) caused by a feedback loss.

Feedback loss can be detected in two ways:

- **Feedback Low Detection**

Detected when the feedback falls below a certain level for longer than the specified time. This function is set up using parameters b5-12 to b5-14.

- **Feedback High Detection**

Detected when the feedback rises above a certain level for longer than the specified time. This function is set up using parameters b5-12, b5-36, and b5-37.

The following figure illustrates the working principle of feedback loss detection when the feedback signal is too low. Feedback high detection works in the same way.

5.2 b: Application

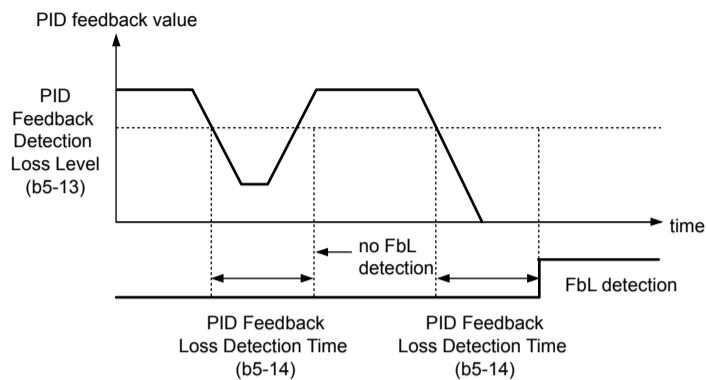

Figure 5.13 PID Feedback Loss Detection

■ b5-12: PID Feedback Loss Detection Selection

Enables or disables the feedback loss detection and sets the operation when a feedback loss is detected.

No.	Parameter Name	Setting Range	Default
b5-12	PID Feedback Loss Detection Selection	0 to 5	0

Setting 0: Multi-Function Digital Outputs Only

Multi-function digital outputs set for “PID feedback low” (H2-□□ = 3E) will be triggered if the PID feedback value is below the detection level set to b5-13 for the time set to b5-14 or longer. Multi-function digital outputs set for “PID feedback high” (H2-□□ = 3F) will be triggered if the PID feedback value is beyond the detection level set to b5-36 for longer than the time set to b5-37. Neither a fault nor an alarm is displayed on the digital operator and the drive will continue operation. The multi-function digital outputs reset when the feedback value leaves the loss detection range.

Setting 1: Feedback Loss Alarm

If the PID feedback value falls below the level set to b5-13 for longer than the time set to b5-14, a “FBL - Feedback Low” alarm will be displayed and a digital output set for “PID feedback low” (H2-□□ = 3E) will be triggered. If the PID feedback value exceeds the level set to b5-36 for longer than the time set to b5-37, a “FBH - Feedback High” alarm will be displayed and a digital output set for “PID feedback high” (H2-□□ = 3F) will be triggered. Both events trigger an alarm output (H2-□□ = 10). The drive will continue operation. The alarm and multi-function digital outputs reset when the feedback value leaves the loss detection range.

Setting 2: Feedback Loss Fault

If the PID feedback value falls below the level set to b5-13 for longer than the time set to b5-14, a “FbL - Feedback Low” fault will be displayed. If the PID feedback value exceeds the level set to b5-36 for longer than the time set to b5-37, a “FbH - Feedback High” fault will be displayed. Both events trigger a fault output (H2-□□ = E) and cause the drive to stop the motor.

Setting 3: Digital Output Always

Same as Setting 0, except that PID must be active and the drive must be running.

Setting 4: Alarm Always

Same as Setting 1, except that PID must be active and the drive must be running.

Setting 5: Fault Always

Same as Setting 2, except that PID must be active and the drive must be running.

■ b5-13: PID Feedback Low Detection Level

Sets the PID feedback detection low level as a percentage of E1-04 (Maximum Output Frequency). The PID feedback must fall below this level for longer than the time set to b5-14 before feedback loss is detected.

No.	Name	Setting Range	Default
b5-13	PID Feedback Low Detection Level	0 to 100%	0%

■ b5-14: PID Feedback Low Detection Time

Sets the time that the PID feedback has to fall below b5-13 before feedback loss is detected.

5.2 b: Application

No.	Name	Setting Range	Default
b5-14	PID Feedback Loss Detection Time	0.0 to 25.5 s	1.0 s

■ b5-36: PID Feedback High Detection Level

Sets the excessive PID feedback detection high level as a percentage of E1-04 (Maximum Output Frequency). The PID feedback must exceed this level for longer than the time set to b5-37 before feedback loss is detected.

No.	Name	Setting Range	Default
b5-36	PID Feedback High Detection Level	0 to 100%	100%

■ b5-37: PID Feedback High Detection Time

Sets the time that the PID feedback must exceed the value set to b5-36 before feedback loss is detected.

No.	Name	Setting Range	Default
b5-37	PID Feedback High Detection Time	0.0 to 25.5 s	1.0 s

■ PID Sleep

The PID Sleep function stops the drive when the PID output or the frequency reference falls below the PID Sleep operation level for a certain time. The drive will resume operating when the PID output or frequency reference rise above the PID Sleep operation level for the specified time. An example of PID Sleep operation appears in the figure below.

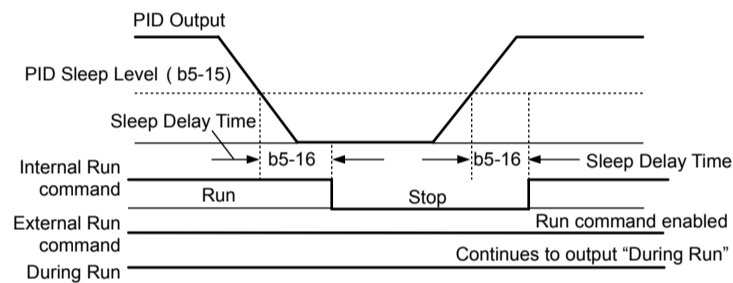

Figure 5.14 PID Sleep Operation

Notes on using the PID Sleep function

- The PID Sleep function is active even when PID control is disabled.
- The PID Sleep function stops the motor according to the stopping method set to b1-03.

The parameters necessary to control the PID Sleep function are explained below.

■ b5-15: PID Sleep Function Start Level

Sets the level that triggers PID Sleep.

The drive goes into Sleep mode if the PID output or frequency reference is smaller than b5-15 for longer than the time set to b5-16. The drive resumes operation when the PID output or frequency reference is above b5-15 for longer than the time set to b5-16.

No.	Name	Setting Range	Default
b5-15	PID Sleep Function Start Level	0.0 to 400.0 Hz	0.0 Hz

5.2 b: Application

■ b5-16: PID Sleep Delay Time

Sets the delay time to activate or deactivate the PID Sleep function.

No.	Name	Setting Range	Default
b5-16	PID Sleep Delay Time	0.0 to 25.5 s	0.0 s

■ b5-17: PID Accel/Decel Time

The PID acceleration/deceleration time is applied on the PID setpoint value.

When the setpoint changes quickly, the normal C1-□□ acceleration times reduce the responsiveness of the system as they are applied after the PID output. The PID accel/decel time helps avoid the hunting and overshoot and undershoot that can result from the reduced responsiveness.

The PID acceleration/deceleration time can be canceled using a digital input programmed for “PID SFS cancel” (H1-□□ = 34).

No.	Name	Setting Range	Default
b5-17	PID Accel/Decel Time	0.0 to 6000.0 s	0.0 s

■ b5-18: PID Setpoint Selection

Enables or disables parameter b5-19 for PID setpoint.

Refer to *Figure 5.15* for the digital operator home screen display when PID is enabled and b5-18 is set to 1, enabling PID Setpoint Selection.

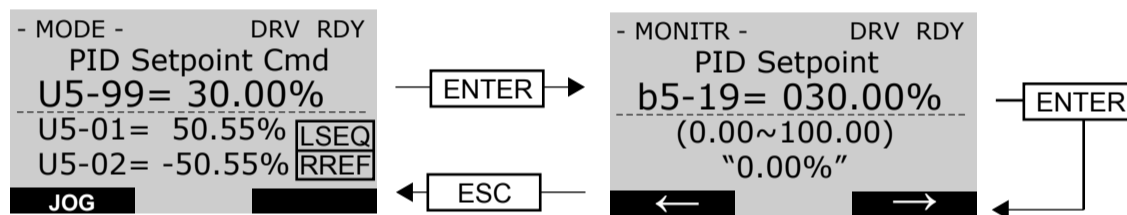

Figure 5.15 PID Setpoint Selection Display

No.	Parameter Name	Setting Range	Default
b5-18	PID Setpoint Selection	0, 1	0

Setting 0: Disabled

Parameter b5-19 is not used as the PID setpoint.

Setting 1: Enabled

Parameter b5-19 is used as PID setpoint.

■ b5-19: PID Setpoint Value

Used as the PID setpoint if parameter b5-18 = 1.

Note: Values set above b5-38 will be internally limited to b5-38.

No.	Name	Setting Range	Default
b5-19	PID Setpoint Value	0.00 to 100.00%	0.00%

■ b5-20: PID Setpoint Scaling

Determines the units for the PID Setpoint Value (b5-19) and monitors U5-01 and U5-04.

No.	Parameter Name	Setting Range	Default
b5-20	PID Setpoint Scaling	0 to 3	1

Setting 0: 0.01 Hz

The setpoint and PID monitors are displayed in Hz with a resolution of 0.01 Hz.

Setting 1: 0.01% (100.00%: Maximum Frequency)

The setpoint and PID monitors are displayed as a percentage with a resolution of 0.01%.

Setting 2: r/min (Set the Motor Poles)

The setpoint and PID monitors are displayed in r/min with a resolution of 1 r/min.

Setting 3: User Defined (Determined by b5-38 and b5-39)

Parameters b5-38 and b5-39 determine the units based on b5-46 setting.

■ b5-34: PID Output Lower Limit

Sets the minimum possible PID controller output as a percentage of the maximum output frequency (E1-04). The lower limit is disabled when set to 0.00%

No.	Name	Setting Range	Default
b5-34	PID Output Lower Limit	-100.0 to 100.0%	0.00%

■ b5-35: PID Input Limit

Sets the maximum allowed PID input as a percentage of the maximum output frequency (E1-04). Parameter b5-35 acts as a bipolar limit.

No.	Name	Setting Range	Default
b5-35	PID Input Limit	0.0 to 1000.0%	1000.0%

■ b5-38, b5-39: PID Setpoint User Display, PID Setpoint Display Digits

When parameter b5-20 is set to 3, parameters b5-38 and b5-39 set a user-defined display for the PID setpoint (b5-19) and PID feedback monitors (U5-01, U5-04).

Parameter b5-38 determines the display value when the maximum frequency is output and parameter b5-39 determines the number of digits. The setting value is equal to the number of decimal places.

No.	Name	Setting Range	Default
b5-38	PID Setpoint User Display	1 to 60000	10000
b5-39	PID Setpoint Display Digits	0 to 3	2

Setting 0: No decimal places**Setting 1: One decimal place****Setting 2: Two decimal places****Setting 3: Three decimal places****■ b5-40: Frequency Reference Monitor Content During PID**

Sets the content of the frequency reference monitor display (U1-01) when PID control is active.

No.	Name	Setting Range	Default
b5-40	Frequency Reference Monitor Content During PID	0, 1	0

Setting 0: Frequency Reference after PID

Monitor U1-01 displays the frequency reference increased or reduced for the PID output.

Setting 1: Frequency Reference before PID

Monitor U1-01 displays the frequency reference value.

5.2 b: Application

■ b5-46: PID Setpoint Monitor Unit Selection

Sets the digital operator display units in U5-01 and U5-04 when b5-20 is set to 3.

No.	Name	Setting Range	Default
b5-46	PID Setpoint Monitor Unit Selection	0 to 15; 25	0

Setting 0: WC (Inch of Water)

Setting 1: PSI (Pounds per Square Inch)

Setting 2: GPM (Gallons per Minute)

Setting 3: F (Degrees Fahrenheit)

Setting 4: CFM (Cubic Feet per Minute)

Setting 5: CMH (Cubic Meters per Hour)

Setting 6: LPH (Liters per Hour)

Setting 7: LPS (Liters per Second)

Setting 8: Bar (Bar)

Setting 9: Pa (Pascal)

Setting 10: C (Degrees Celsius)

Setting 11: Mtr (Meters)

Setting 12: Ft (Feet)

Setting 13: LPN (Liters per Minute)

Setting 14: CMM (Cubic Meters per Minute)

Setting 15: "Hg (Inches of Mercury)

Setting 25: No unit

■ b5-47: PID Output Reverse Selection 2

Determines whether a negative PID output reverses the direction of drive operation. When the PID function is used to trim the frequency reference (b5-01 = 3 or 4), this parameter has no effect and the PID output will not be limited (same as b5-11 = 1).

No.	Name	Setting Range	Default
b5-47	PID Output Reverse Selection 2	0, 1	1

Setting 0: 0 Limit (Reverse Disabled)

Negative PID output will be limited to 0 and the drive output will be stopped.

Setting 1: Reverse Enabled

Negative PID output will cause the drive to run in the opposite direction.

■ Fine-Tuning PID

Follow the directions below to fine tune PID control parameters:

Table 5.6 PID Fine Tuning

Goal	Tuning Procedure	Result
Suppress overshoot	<ul style="list-style-type: none"> Reduce the derivative time (b5-05) Increase the integral time (b5-03) 	
Achieve stability quickly while allowing some overshoot	<ul style="list-style-type: none"> Decrease the integral time (b5-03) Increase the derivative time (b5-05) 	
Suppress long cycle oscillations (longer than the integral time setting)	Increase the integral time (b5-03)	
Suppress short cycle oscillations	<ul style="list-style-type: none"> If oscillation cycle time is close to the derivative time, reduce the derivative time (b5-05). If the derivative time is set to 0.00 s and oscillations are still a problem, reduce the proportional gain (b5-02) or increase the PID primary delay time (b5-08) 	

Programming

5

■ **b5-89: Sleep Method Selection**

Determines how the drive sleeps and wakes-up when using PID.

No.	Name	Setting Range	Default
b5-89	Sleep Method Selection	0, 1	0

Setting 0: Standard

Setting 1: EZ Sleep/Wake-up

■ **b5-90: EZ Sleep Unit**

Sets the unit, range, and resolution of parameters b5-91 and b5-92.

No.	Name	Setting Range	Default
b5-90	EZ Sleep Unit	0, 1 <I>	0

<I> Unit and resolution are determined by b5-20, b5-39, and b5-46. Internally limited to b5-38. Changing b5-20, b5-38 and b5-39 will not automatically update the value of this parameter.

Setting 0: Hz

Setting 1: RPM (number of motor poles must be entered)

■ **b5-91: EZ Minimum Speed**

Sets the PID minimum speed and integral lower limit.

The lower limit of the internal value is the higher of b5-34 and d2-02.

5.2 b: Application

No.	Name	Setting Range	Default
b5-91	EZ Minimum Speed	0.0 to 400.0 Hz ^{<I>} or 0 to 24000 RPM	0.0

<I> Unit and resolution are determined by b5-20, b5-39, and b5-46. Internally limited to b5-38. Changing b5-20, b5-38 and b5-39 will not automatically update the value of this parameter.

■ b5-92: EZ Sleep Level

When the drive output frequency (or speed) is at or below this level for the time set in b5-93, the drive will go to sleep. The internal lower limit of this parameter is b5-91 (EZ Min Speed) + 1 Hz.

No.	Name	Setting Range	Default
b5-92	EZ Sleep Level	0.0 to 400.0 Hz ^{<I>} or 0 to 24000 RPM	0.0

<I> Unit and resolution are determined by b5-20, b5-39, and b5-46. Internally limited to b5-38. Changing b5-20, b5-38 and b5-39 will not automatically update the value of this parameter.

■ b5-93: EZ Sleep Time

The drive will go to sleep when the drive output frequency is at or below the level set to b5-92 for the time set in this parameter.

No.	Name	Setting Range	Default
b5-93	EZ Sleep Tim	0.0 to 10000.0 ^{<I>}	5.0 s

<I> Unit and resolution are determined by b5-20, b5-39, and b5-46. Internally limited to b5-38. Changing b5-20, b5-38 and b5-39 will not automatically update the value of this parameter.

■ b5-94: EZ Wake-up Level

If b5-95 is set to 0 (Absolute), the drive wakes-up when the PID Feedback (H3-□□ = 20) drops below this level for the time set in b5-96. For reverse-acting, the PID Feedback has to be above this level for the time set in b5-96.

If b5-95 is set to 1 (Setpoint Delta), the drive wakes-up when the PID Feedback (H3-□□ = 20) drops below the PID Setpoint minus this level (for normal acting PID) for the time set in b5-96. For reverse-acting, Wake-up level is PID Setpoint plus this level. The PID Feedback has to be above the wake-up level for the time set in b5-96.

No.	Name	Setting Range	Default
b5-94	EZ Wake-up Level	0.00 to 600.00% ^{<I>}	0.00

<I> Unit and resolution are determined by b5-20, b5-39, and b5-46. Internally limited to b5-38. Changing b5-20, b5-38 and b5-39 will not automatically update the value of this parameter.

■ b5-95: EZ Wake-up Mode

Sets how the wake-up level is determined.

No.	Name	Setting Range	Default
b5-95	EZ Wake-up Mode	0, 1 ^{<I>}	0

<I> Unit and resolution are determined by b5-20, b5-39, and b5-46. Internally limited to b5-38. Changing b5-20, b5-38 and b5-39 will not automatically update the value of this parameter.

Setting 0: Absolute

Setting 1: Setpoint Data

■ b5-96: EZ Wake-up Time

The drive will wake up when the PID Feedback drops below the b5-94, EZ Wake-up Level for the time set in this parameter.

No.	Name	Setting Range	Default
b5-96	EZ Wake-up Time	0.0 to 1000.0 ^{<I>}	1.0 s

<I> Unit and resolution are determined by b5-20, b5-39, and b5-46. Internally limited to b5-38. Changing b5-20, b5-38 and b5-39 will not automatically update the value of this parameter.

5.3 C: Tuning

C parameters set the characteristics for acceleration, deceleration, and S-curves. Other parameters in the C group cover settings for slip compensation, torque compensation, and carrier frequency.

◆ C1: Acceleration and Deceleration Times

■ C1-01 and C1-02: Accel, Decel Time 1

Four different sets of acceleration and deceleration times can be set in the drive by digital inputs, motor selection, or switched automatically.

Acceleration time parameters always set the time to accelerate from 0 Hz to the maximum output frequency (E1-04).

Deceleration time parameters always set the time to decelerate from maximum output frequency to 0 Hz. C1-01 and C1-02 are the default active accel/decel settings.

No.	Parameter Name	Setting Range	Default
C1-01	Acceleration Time 1	0.0 to 6000.0 s	10.0 s
C1-02	Deceleration Time 1		

■ C1-09: Fast Stop Time

Sets a special deceleration used when a select group of faults occur or when closing a digital input configured as H1-□□ = 15 (N.O. input) or 17 (N.C. input). A momentary closure of the digital input will trigger the Fast Stop operation; it does not have to be closed continuously.

The drive cannot be restarted after initiating a Fast Stop operation until after completing deceleration, clearing the Fast Stop input, and cycling the Run command.

A digital output programmed for “During Fast Stop” (H2-□□ = 4C^I) will be closed as long as Fast Stop is active.

^I Details on this function can be found in the standard P1000 Technical Manual (SIEPYAIP1U01) at www.yaskawa.com.

No.	Parameter Name	Setting Range	Default
C1-09	Fast Stop Time	0.0 to 6000.0 s	10.0 s

NOTICE: Rapid deceleration can trigger an overvoltage fault. The drive output shuts off when faulted and the motor coasts. Set an appropriate Fast Stop time to C1-09 to avoid this uncontrolled motor state and to ensure that the motor stops quickly and safely.

◆ C2: S-Curve Characteristics

Use S-curve characteristics to smooth acceleration and deceleration and minimize abrupt shock to the load. Set S-curve characteristic time during acceleration/deceleration at start and acceleration/deceleration at stop.

■ C2-01 and C2-02: S-Curve Characteristics

C2-01 and C2-02 set separate S-curves for each section of the acceleration or deceleration.

No.	Parameter Name	Setting Range	Default
C2-01	S-Curve Characteristic at Accel Start	0.00 to 10.00 s	0.20 s
C2-02	S-Curve Characteristic at Accel End		0.20 s

Figure 5.16 illustrates S-curve application.

5.3 C: Tuning

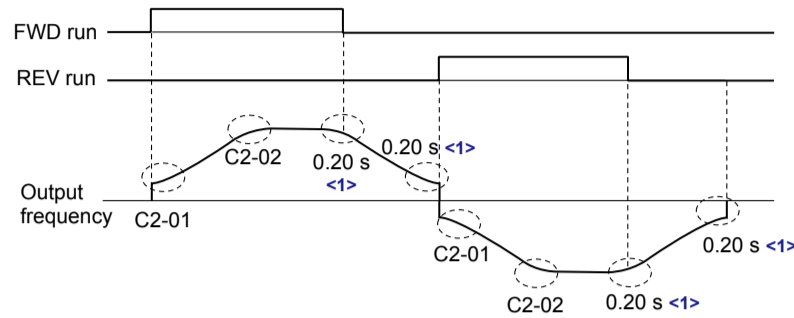

<1> S-Curve characteristic at Decel Start/End is fixed to 0.20 s.

Figure 5.16 S-Curve Timing Diagram - FWD/REV Operation

Setting the S-curve will increase the acceleration and deceleration times.

Actual accel time = accel time setting + (C2-01 + C2-02) / 2

◆ C4: Torque Compensation

The torque compensation function compensates for insufficient torque production at start-up or when a load is applied.

Note: Set the motor parameters and V/f pattern properly before setting torque compensation parameters.

■ C4-01: Torque Compensation Gain

Sets the gain for the torque compensation function.

No.	Parameter Name	Setting Range	Default
C4-01	Torque Compensation Gain	0.00 to 2.50	1.00

Torque Compensation:

The drive calculates the motor primary voltage loss using the output current and the termination resistor value (E2-05) and adjusts the output voltage to compensate insufficient torque at start or when load is applied. The effects of this voltage compensation can be increased or decreased using parameter C4-01.

Adjustment

Although this parameter rarely needs to be changed, it may be necessary to adjust the torque compensation gain in small steps of 0.05 in the following situations:

- Increase this setting when using a long motor cable.
- Decrease this setting when motor oscillation occurs.

Adjust C4-01 so the output current does not exceed the drive rated current.

◆ C6: Carrier Frequency

■ C6-02: Carrier Frequency Selection

Sets the switching frequency of the drive output transistors. Changes to the switching frequency lower audible noise and reduce leakage current.

No.	Parameter Name	Setting Range	Default
C6-02	Carrier Frequency Selection	1 to A	7

Settings:

C6-02	Carrier Frequency	C6-02	Carrier Frequency	C6-02	Carrier Frequency
1	2.0 kHz	5	12.5 kHz	9	Swing PWM 3
2	5.0 kHz	6	15.0 kHz	A	Swing PWM 4
3	8.0 kHz	7	Swing PWM 1		
4	10.0 kHz	8	Swing PWM 2		

Note: Swing PWM uses a carrier frequency of 2.0 kHz as a base, then applies a special PWM pattern to reduce the audible noise.

Guidelines for Carrier Frequency Parameter Setup

Symptom	Remedy
Speed and torque are unstable at low speeds	Lower the carrier frequency.
Noise from the drive affects peripheral devices	
Excessive leakage current from the drive	
Wiring between the drive and motor is too long <1>	Increase the carrier frequency or use Swing PWM. <2>
Audible motor noise is too loud	

<1> The carrier frequency may need to be lowered if the motor cable is too long. Refer to **Table 5.7**.

<2> The default carrier frequency is Swing PWM (C6-02 = 7), using a 2 kHz base. Increasing the carrier frequency is permissible, however the drive rated current is reduced when the carrier frequency is increased.

Table 5.7 Wiring Distance and Carrier Frequency

Wiring Distance	Up to 50 m	Up to 100 m	Greater than 100 m
Recommended setting value for C6-02	1 to F (up to 15 kHz)	1 to 2 (up to 5 kHz), 7 (Swing PWM)	1 (up to 2 kHz), 7 (Swing PWM)

■ C6-05: Carrier Frequency Proportional Gain

Sets a user-defined or a variable carrier frequency. Set C6-02 to F to set the upper and lower limits and the carrier frequency proportional gain.

No.	Parameter Name	Setting Range	Default
C6-05	Carrier Frequency Proportional Gain (V/f Control only)	0 to 99	Determined by C6-02

Setting a Fixed User-Defined Carrier Frequency

A carrier frequency between the fixed selectable values can be entered in parameter C6-03<1> when C6-02 is set to F. In V/f Control, adjust parameter C6-04<1> to the same value as C6-03<1>.

Setting a Variable Carrier Frequency (V/f Control)

In V/f Control, the carrier frequency can be set up to change linearly with the output frequency by setting the upper and lower limits for the carrier frequency and the carrier frequency proportional gain (C6-03<1>, C6-04<1>, C6-05) as shown in **Figure 5.17**.

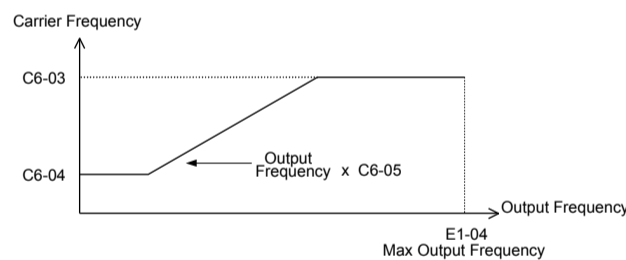

Figure 5.17 Carrier Frequency Changes Relative to Output Frequency

Note: When C6-05 is set lower than 7, C6-04<1> is disabled and the carrier frequency will be fixed to the value set in C6-03<1>.

<1> Details on this function can be found in the standard P1000 Technical Manual (SIEPCYAIP1U01) at www.yaskawa.com.

5.4 d: Reference Settings

5.4 d: Reference Settings

The figure below gives an overview of the reference input, selections, and priorities.

◆ d1: Frequency Reference

■ d1-01 to d1-04: Frequency References 1 to 4

The drive lets the user switch between up to 5 preset frequency references during run (including the Jog reference) through the digital input terminals. The drive uses the acceleration and deceleration times that have been selected when switching between each frequency reference.

The Jog frequency overrides all other frequency references and must be selected by a separate digital input.

The multi-speed references 1 and 2 can be provided by analog inputs.

No.	Parameter Name	Setting Range	Default
d1-01 to d1-04	Frequency Reference 1 to 4	0.00 to 60.00 Hz <I>	0.00 Hz <I>

<I> Setting units are determined by parameter o1-03. The default is “Hz” (o1-03 = 0).

Multi-Step Speed Selection

To use several speed references for a multi-step speed sequence, set the Z2-□□ (dI-□□ Select) parameters to 5 (S5) and 6 (S6). To assign the Jog reference to a digital input, set Z2-□□ (DI-□□ Select) to 7 (S7).

Notes on using analog inputs as Multi-Speed 1 and 2:

- The first frequency reference (Multi-Speed 1) comes from the source specified in Z1-07. When using an analog input terminal to supply the frequency reference, assign the frequency reference source to the control terminals (Z1-07 = 1).
- When an analog input is set to “Auxiliary frequency 1” (H3-02 or H3-10 = 2), the value set to this input will be used as the Multi-Step Speed 2 instead of the value set to parameter d1-02. If no analog inputs are set for “Auxiliary frequency 1”, then d1-02 becomes the reference for Multi-Step Speed 2.

Select the different speed references as shown in **Table 5.8**. **Figure 5.18** illustrates the multi-step speed selection.

Table 5.8 Multi-Step Speed Reference and Terminal Switch Combinations

Reference	Multi-Step Speed Z2-□□ = 5	Multi-Step Speed 2 Z2-□□ = 6	Jog Reference Z2-□□ = 7
Frequency Reference 1 (set in b1-01)	OFF	OFF	OFF
Frequency Reference 2 (d1-02 or input terminal A1, A2, A3)	ON	OFF	OFF
Frequency Reference 3 (d1-03 or input terminal A1, A2, A3)	OFF	ON	OFF
Frequency Reference 4 (d1-04)	ON	ON	OFF

<I> The Jog frequency overrides all other frequency references.

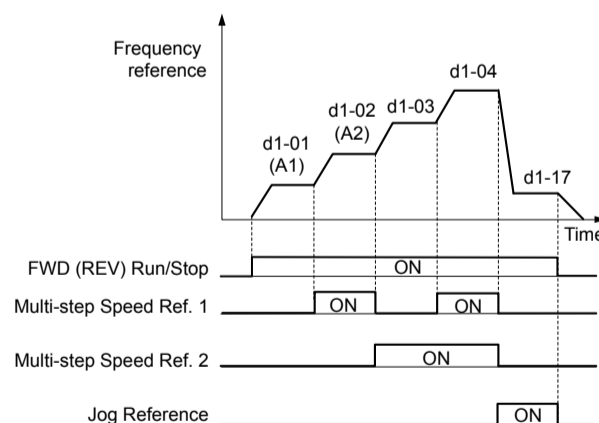

Figure 5.18 Preset Reference Timing Diagram

◆ d2: Frequency Upper/Lower Limits

Upper and lower frequency limits prevent motor speed from going above or below levels that may cause resonance or equipment damage.

■ d2-01: Frequency Reference Upper Limit

Sets the maximum frequency reference as a percentage of the maximum output frequency. This limit applies to all frequency references.

Even if the frequency reference is set to a higher value, the drive internal frequency reference will not exceed this value.

No.	Parameter Name	Setting Range	Default
d2-01	Frequency Reference Upper Limit	0.0 to 110.0%	100.0%

Note: This value is over-written by the energy savings function. If energy savings is enabled, ($Z1-16 = 1$ or 2), this value will be set to 110%. If energy savings is not enabled ($Z1-16 = 0$), then the bypass controller will not change this value.

■ d2-02: Frequency Reference Lower Limit

Sets the minimum frequency reference as a percentage of the maximum output frequency. This limit applies to all frequency references.

If a lower reference than this value is entered, the drive will run at the limit set to d2-02. If the drive is started with a lower reference than d2-02, it will accelerate up to d2-02.

No.	Parameter Name	Setting Range	Default
d2-02	Frequency Reference Lower Limit	0.0 to 110.0%	0.0%

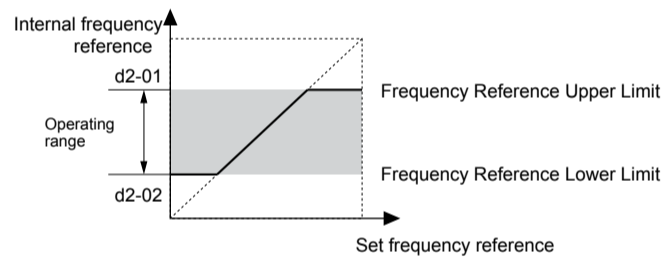

Figure 5.19 Frequency Reference: Upper and Lower Limits

■ d2-03: Master Speed Reference Lower Limit

Sets a lower limit as a percentage of the maximum output frequency that will only affect a frequency reference entered from the analog input terminals (A1, A2, or A3) as the master speed reference. This is unlike parameter d2-02, which affects all frequency references regardless of their source.

Note: When lower limits are set to both parameters d2-02 and d2-03, the drive uses the greater of those two values as the lower limit.

No.	Parameter Name	Setting Range	Default
d2-03	Master Speed Reference Lower Limit	0.0 to 110.0%	0.0%

5.4 d: Reference Settings

◆ d3: Jump Frequency

■ d3-01 to d3-04: Jump Frequencies 1, 2, 3 and Jump Frequency Width

The Jump frequencies are frequency ranges at which the drive will not operate. The drive can be programmed with three separate Jump frequencies to avoid operating at speeds that cause resonance in driven machinery. If the speed reference falls within a Jump frequency dead band, the drive will clamp the frequency reference just below the dead band and only accelerate past it when the frequency reference rises above the upper end of the dead band.

Setting parameters d3-01 through d3-03 to 0.0 Hz disables the Jump frequency function.

No.	Parameter Name	Setting Range	Default
d3-01	Jump Frequency 1	0.0 to 400.0 Hz	0.0 Hz
d3-02	Jump Frequency 2	0.0 to 400.0 Hz	0.0 Hz
d3-03	Jump Frequency 3	0.0 to 400.0 Hz	0.0 Hz
d3-04	Jump Frequency Width	0.0 to 20.0 Hz	1.0 Hz

Figure 5.20 shows the relationship between the Jump frequency and the output frequency.

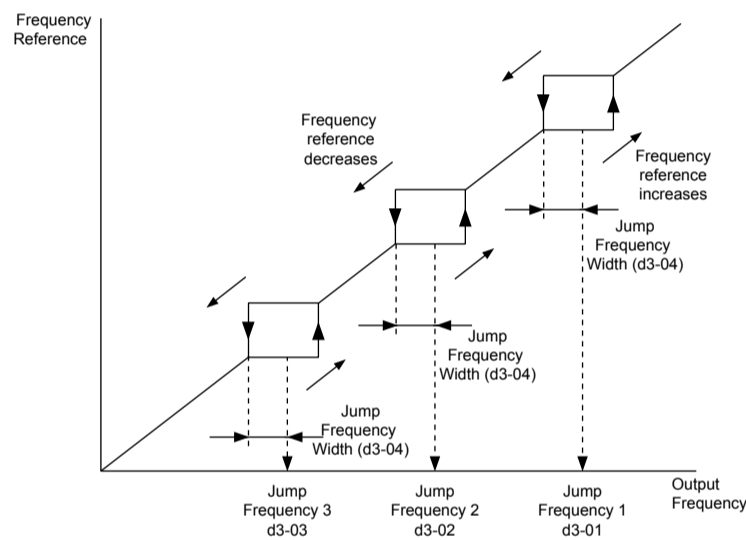

Figure 5.20 Jump Frequency Operation

- Note:**
1. The drive will use the active accel/decel time to pass through the specified dead band range, but will not allow continuous operation in that range.
 2. When setting more than one Jump frequency, make sure that the parameters do not overlap.

5.5 E: Motor Parameters

E parameters cover V/f pattern and motor data settings.

◆ E1: V/f Pattern for Motor 1

■ E1-01: Input Voltage Setting

Adjusts the levels of some protective features of the drive (overvoltage, Stall Prevention, etc.). Set this parameter to the nominal voltage of the AC power supply.

NOTICE: Set parameter E1-01 to match the input voltage of the drive. Drive input voltage (not motor voltage) must be set in E1-01 for the protective features to function properly. Failure to set the correct drive input voltage will result in improper drive operation.

No.	Parameter Name	Setting Range	Default
E1-01	Input Voltage Setting	310 to 510 V	460 V <1>

<1> Values shown are specific to 480 Vac bypass drives.

E1-01 Related Values

The input voltage setting determines the overvoltage and undervoltage detection levels, the KEB function, and the overvoltage suppression function.

Voltage	Setting Value of E1-01	(Approximate Values)
		Uv Detection Level (L2-05)
208 Vac Bypass Drives	All settings	190 V
480 Vac Bypass Drives	Setting > 460 V	440 V

■ V/f Pattern Settings (E1-03)

The drive uses a V/f pattern to adjust the output voltage relative to the frequency reference. There are 15 different predefined V/f patterns (setting 0 to E) from which to select, each with varying voltage profiles, saturation levels (frequency at which maximum voltage is reached), and maximum frequencies. Additionally, one custom V/f pattern is available (setting F) that requires the user to create the pattern using parameters E1-04 through E1-10.

■ E1-03: V/f Pattern Selection

Selects the V/f pattern for the drive and motor from 15 predefined patterns or creates a custom V/f pattern.

No.	Parameter Name	Setting Range	Default
E1-03	V/f Pattern Selection	0 to 9; A to FF	F

Setting a Predefined V/f Pattern (Setting 0 to F)

Choose the V/f pattern that best meets the application demands from the table below. Set the correct value to E1-03. Parameter E1-05 can only be monitored, not changed.

- Note:**
1. Setting an improper V/f pattern may result in low motor torque or increased current due to overexcitation.
 2. Drive initialization does not reset parameter E1-03.

Table 5.9 Predefined V/f Patterns

Setting	Specification	Characteristic	Application
0	50 Hz	Constant torque	For general purpose applications. Torque remains constant regardless of changes to speed.
1	60 Hz Saturation		
2	50 Hz Saturation		
3	72 Hz (with 60 Hz base)		
4	50 Hz, Variable torque 1	Variable torque	For fans, pumps, and other applications where the required torque changes as a function of the speed.
5	50 Hz, Variable torque 2		
6	60 Hz, Variable torque 1		
7	60 Hz, Variable torque 2		

5.5 E: Motor Parameters

Setting	Specification	Characteristic	Application
8	50 Hz, High starting torque 1	High starting torque	Select high starting torque when: <ul style="list-style-type: none"> • Wiring between the drive and motor exceeds 150 m. • A large amount of starting torque is required. • An AC reactor is installed.
9	50 Hz, High starting torque 2		
A	60 Hz, High starting torque 1		
B	60 Hz, High starting torque 2		
C	90 Hz (with 60 Hz base)	Constant output	Output voltage is constant when operating at greater than 60 Hz.
D	120 Hz (with 60 Hz base)		
E	180 Hz (with 60 Hz base)		
F <I>	60 Hz	Variable torque	Used for variable torque applications. The default setting is the same as V/f pattern Setting 7.

<1> Setting F enables a custom V/f pattern by changing parameters E1-05. When the bypass is shipped, the default values for parameter E1-05 are equal to predefined V/f pattern 1.

The following tables show details on predefined V/f patterns.

Predefined V/f Patterns for Models D002 to D024 and B001 to B011

The voltage values in the graphs for settings 0 to E apply to applications with 200 V motors. Double the voltage values for 400 V motors. The voltage values in settings 0 to E do not apply to 208, 230, or 460 V motor applications.

Table 5.10 Constant Torque Characteristics, Settings 0 to 3

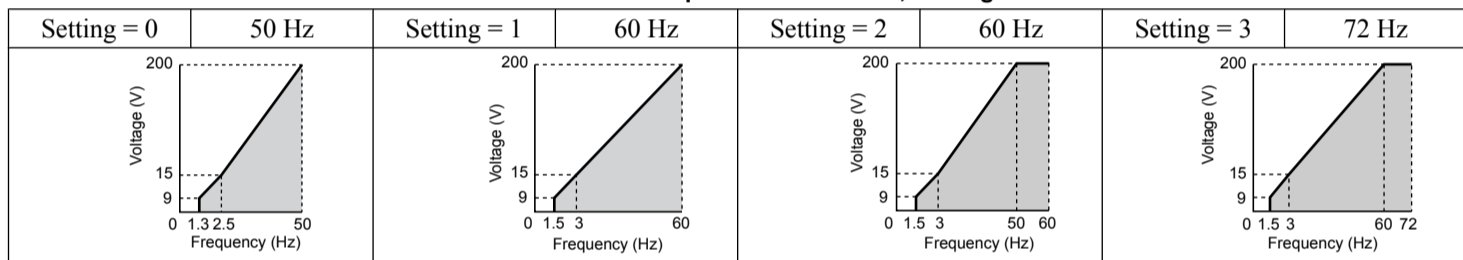

Table 5.11 Variable Torque Characteristics, Settings 4 to 7

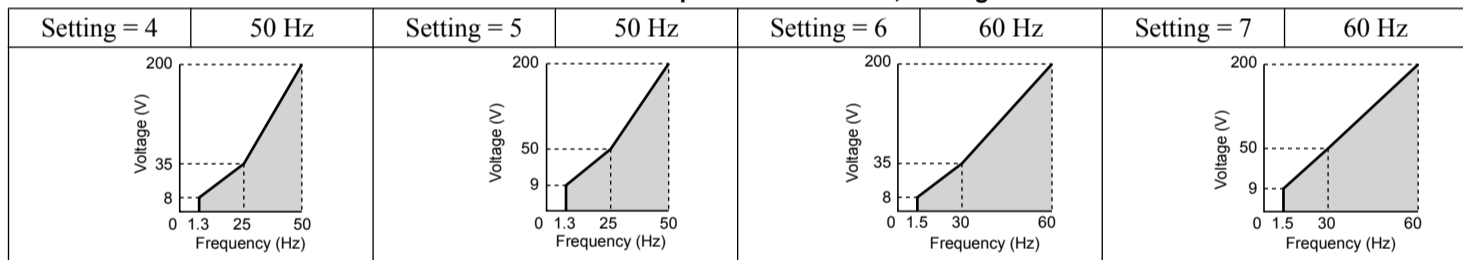

Table 5.12 High Starting Torque, Settings 8 to B

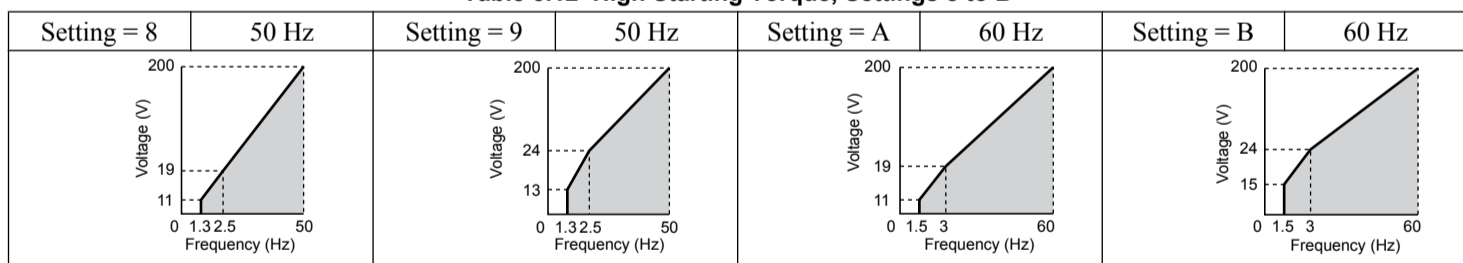
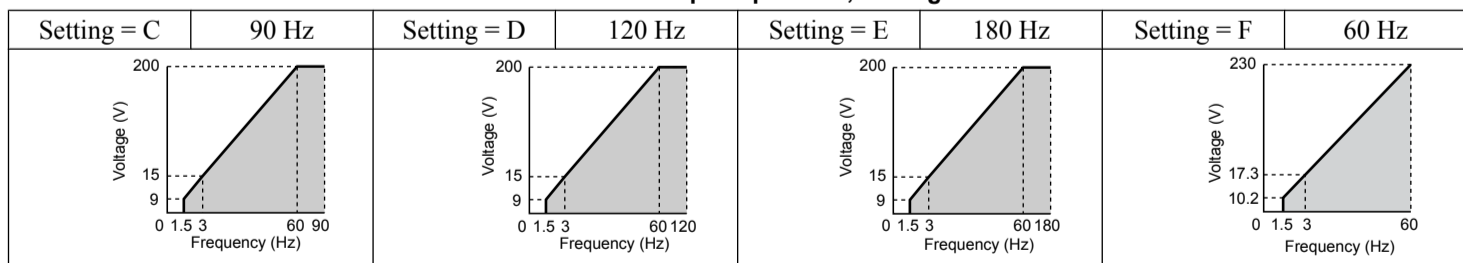

Table 5.13 Rated Output Operation, Settings C to F



5.5 E: Motor Parameters

Predefined V/f Patterns for Models D030 to D211 and B014 to B096

The voltage values in the graphs for settings 0 to E apply to applications with 200 V motors. Double the voltage values for 400 V motors. The voltage values in settings 0 to E do not apply to 208, 230, or 460 V motor applications.

Table 5.14 Rated Torque Characteristics, Settings 0 to 3

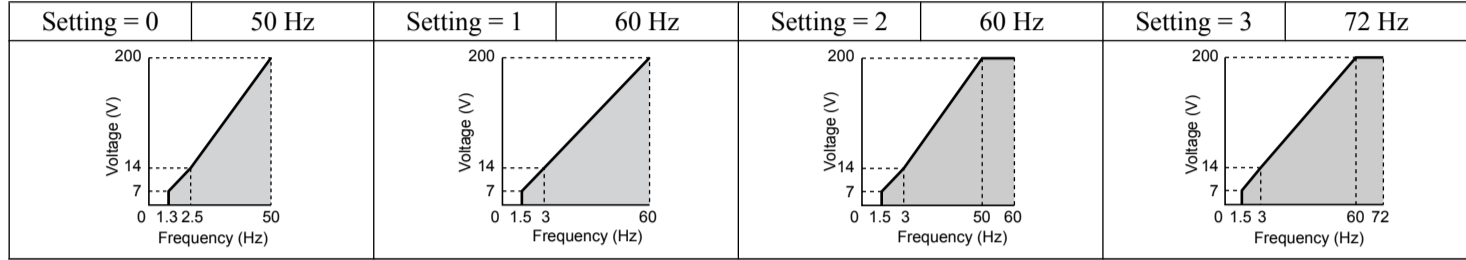

Table 5.15 Variable Torque Characteristics, Settings 4 to 7

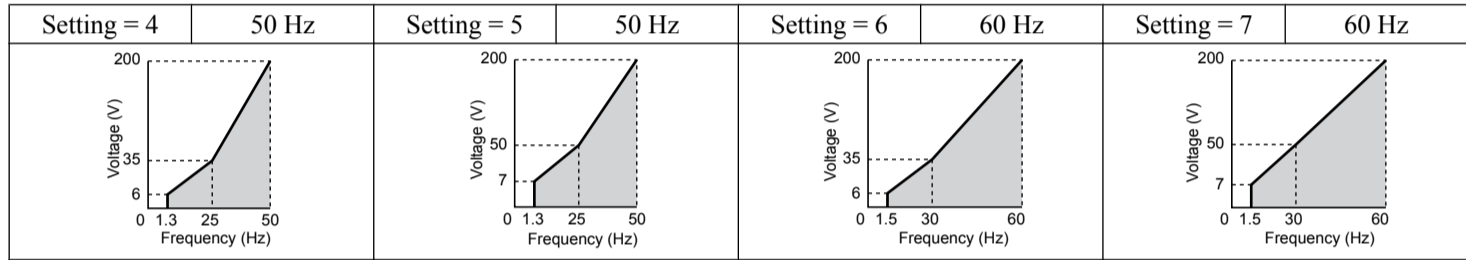

Table 5.16 High Starting Torque, Settings 8 to B

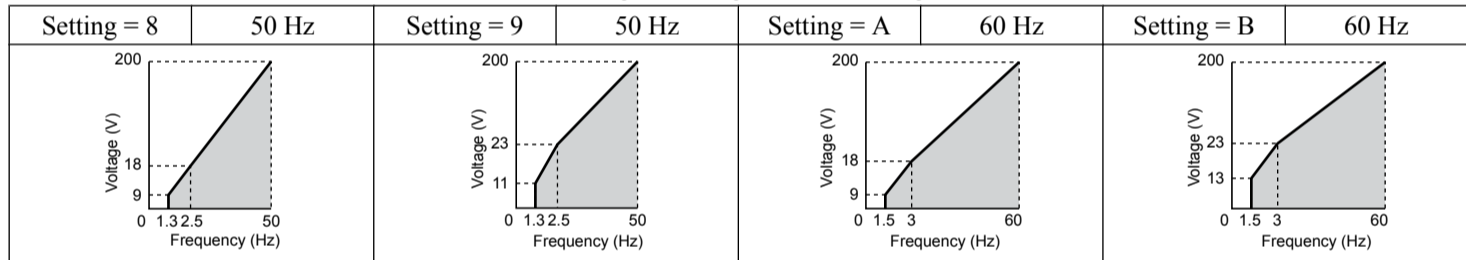
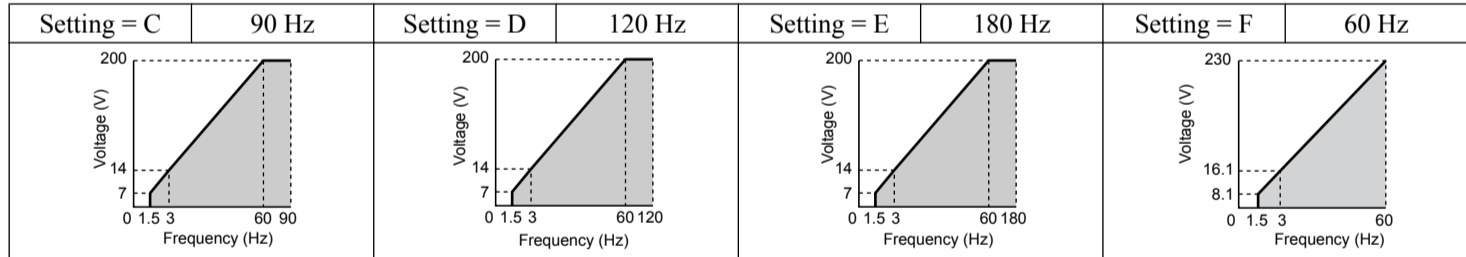

Table 5.17 Constant Output, Settings C to F



5.5 E: Motor Parameters

Predefined V/f Patterns for Models D273 to D396 and B124 to B590

The voltage values in the graphs for settings 0 to E apply to applications with 200 V motors. Double the voltage values for 400 V motors. The voltage values in settings 0 to E do not apply to 208, 230, or 460 V motor applications.

Table 5.18 Rated Torque Characteristics, Settings 0 to 3

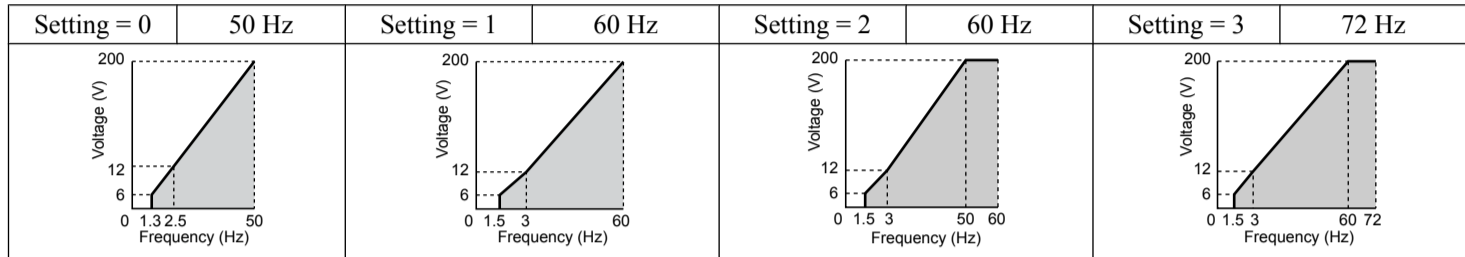

Table 5.19 Variable Torque Characteristics, Settings 4 to 7

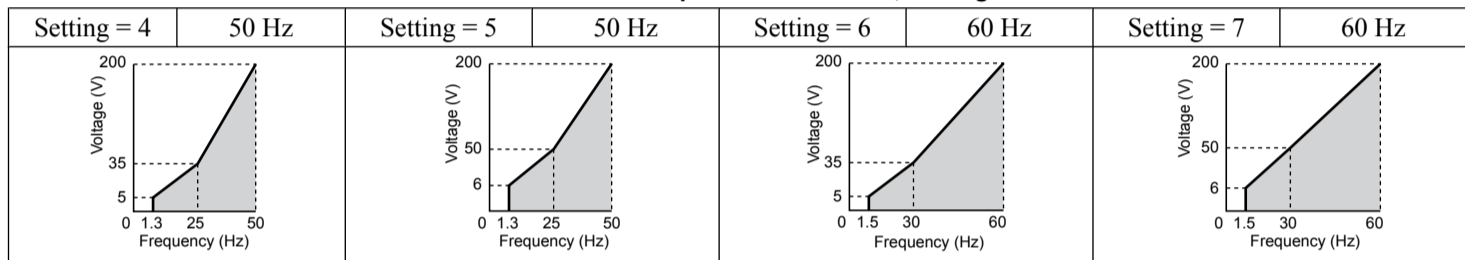

Table 5.20 High Starting Torque, Settings 8 to B

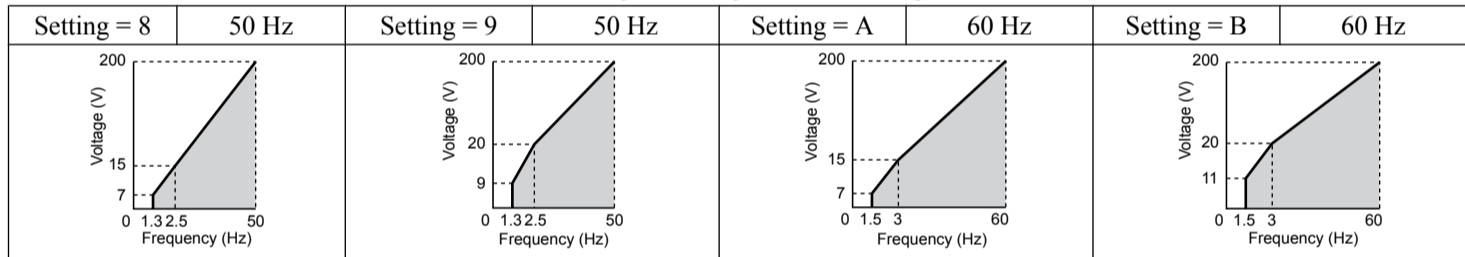
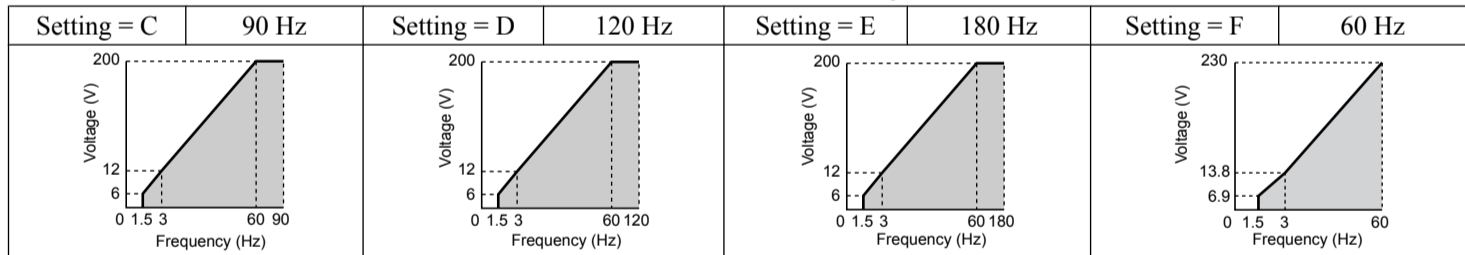

Table 5.21 Constant Output, Settings C to F



Setting a Custom V/f Pattern (Setting F: Default)

Setting parameter E1-03 to F allows the user to set up a custom V/f pattern by changing parameter E1-05.

■ V/f Pattern Settings E1-05

If E1-03 is set to a preset V/f pattern (i.e., a value other than F), the user can monitor the maximum voltage in parameters E1-05. To create a new V/f pattern, set E1-03 to F.

No.	Parameter Name	Setting Range	Default
E1-05	Maximum Voltage	0.0 to 510.0 V <1>	<2>

<1> Values shown are specific to 480 Vac.

<2> Default setting is determined by parameter E1-03, V/f Pattern Selection.

◆ E2: Motor 1 Parameters

These parameters contain the motor data needed for motor 1. Enter the motor data into these parameters when Auto-Tuning cannot be performed.

■ E2-01: Motor Rated Current

Provides motor control, protects the motor, and calculates torque limits. Set E2-01 to the full load amps (FLA) stamped on the motor nameplate.

No.	Parameter Name	Setting Range	Default
E2-01	Motor Rated Current	10% to 200% of the drive rated current	Determined by o2-04

Note: The number of decimal places in the parameter value depends on the drive model. *Refer to Defaults by Drive Model on page 298* for details.

■ E2-03: Motor No-Load Current

Set the no-load current for the motor in amperes when operating at the rated frequency and the no-load voltage. The drive sets E2-03 during the Auto-Tuning process (Rotational Auto-Tuning and Stationary Auto-Tuning 1, 2). The motor no-load current listed in the motor test report can also be entered to E2-03 manually. Contact the motor manufacturer to receive a copy of the motor test report.

No.	Parameter Name	Setting Range	Default
E2-03	Motor No-Load Current	0 to [E2-01] (unit: 0.01 A)	Determined by o2-04

Note: The number of decimal places in the parameter value depends on the drive model. This value has two decimal places (0.01 A) if the drive is set for a maximum applicable motor capacity up to and including 11 kW, and one decimal place (0.1 A) if the maximum applicable motor capacity is higher than 11 kW.

5.6 F: Options

5.6 F: Options

◆ F6: Drive/Bypass Communications

■ F6-01: Communications Error Operation Selection

Determines drive operation when a communication error occurs.

No.	Parameter Name	Setting Range	Default
F6-01	Communications Error Operation Selection	0 to 4	1

Setting 0: Ramp to Stop (Use the Deceleration Time Set to C1-02)

Setting 1: Coast to Stop

Setting 2: Fast Stop (Use the Fast Stop Time Set to C1-09)

Setting 3: Alarm Only (Continue Operation)

Setting 4: Alarm Only (Continue Operation Using the Frequency Reference Set in d1-04)

■ F6-02: External Fault from Bypass Controller Detection Selection

Determines the detection method of an external fault initiated by the bypass controller (EF0).

No.	Parameter Name	Setting Range	Default
F6-02	External Fault from Bypass Controller Detection Selection	0, 1	0

Setting 0: Always detected

Setting 1: Detection during Run only

■ F6-03: External Fault from Bypass Controller Operation Selection

Determines drive operation when an external fault is initiated by the bypass controller (EF0).

No.	Parameter Name	Setting Range	Default
F6-03	External Fault from Bypass Controller Operation Selection	0 to 3	1

Setting 0: Ramp to stop

Setting 1: Coast to stop

Setting 2: Fast Stop

Setting 3: Alarm only (continue operation)

5.7 H: Terminal Functions

H parameters assign functions to the external terminals.

◆ H1: Multi-Function Digital Inputs

■ H1-03 to H1-08: Functions for Terminals S3 to S8

These parameters assign functions to the multi-function digital inputs. The various functions and settings are listed in *Table 5.22*.

No.	Parameter Name	Setting Range	Default
H1-03	Multi-Function Digital Input Terminal S3 Function Selection	3 to 60	24: External Fault
H1-04	Multi-Function Digital Input Terminal S4 Function Selection	3 to 60	14: Fault Reset
H1-05	Multi-Function Digital Input Terminal S5 Function Selection	3 to 60	3: Multi-Step Speed Reference 1
H1-06	Multi-Function Digital Input Terminal S6 Function Selection	3 to 60	4: Multi-Step Speed Reference 2
H1-07	Multi-Function Digital Input Terminal S7 Function Selection	3 to 60	6: Jog Reference Selection
H1-08	Multi-Function Digital Input Terminal S8 Function Selection	3 to 60	F: Not Used

Table 5.22 Multi-Function Digital Input Terminal Settings

Setting	Function	Page	Setting	Function	Page
3	Multi-Step Speed Reference 1	115	13 <2>	Reverse Jog	116
4	Multi-Step Speed Reference 2		14	Fault Reset	117
6	Jog reference Selection	115	19	PID Disable	117
C	Analog Terminal Input Selection	115	24	External Fault	117
F <1>	Not Used (Through Mode)	115	60	Motor Pre-Heat 1	117
10	Up Command	115			
11	Down Command				

<1> Available in bypass controller software versions VST800298 and later.

<2> Available in bypass controller software versions VST800297 and earlier.

Settings 3 and 4: Multi-Step Speed Reference 1 and 2

Switches multi-step speed frequency references d1-01 to d1-04 by digital inputs. *Refer to d1: Frequency Reference on page 106* for details.

Setting 6: Jog Reference Selection

The Jog frequency set in parameter d1-17 becomes the frequency reference when the input terminal closes. *Refer to d1: Frequency Reference on page 106* for details.

Setting C: Analog Terminal Input Selection (Terminals A1, A2, A3)

When closed, the terminals specified in H3-14 are enabled. When open, the drive disregards the input signal to the analog terminals.

Setting F: Not Used (Through Mode)

Select this setting when using the terminal in a pass-through mode. When set to F, an input does not trigger any function in the drive. Setting F, however, still allows the input status to be read out by a PLC via a communication option or MEMOBUS/Modbus communications.

Settings 10 and 11: Up/Down Function

The Up/Down function allows the frequency reference to be set by two push buttons when one digital input is programmed as the Up input (H1-□□= 10) to increase the frequency reference and the other digital input is programmed as the Down input (H1-□□= 11) to decrease the frequency reference.

The Up/Down function takes priority over the frequency references from the HOA keypad, the analog inputs, and the pulse input (b1-01 = 0, 1, 4). When using the Up/Down function, references provided by these sources will be disregarded.

The inputs operate as shown in the table below:

5.7 H: Terminal Functions

Status		Drive Operation
Up (10)	Down (11)	
Open	Open	Hold current frequency reference
Closed	Open	Increase frequency reference
Open	Closed	Decrease frequency reference
Closed	Closed	Hold current frequency reference

- Note:**
1. An oPE03 alarm occurs when only one of the Up/Down functions is programmed to a digital input.
 2. An oPE03 alarm occurs when the Up/Down function is assigned to the terminals and a different digital input is programmed for the Accel/decel ramp hold function. Refer to the Troubleshooting chapter in the User Manual packaged with the drive for more information on alarms.
 3. The Up/Down function can only be used for External reference 1. Consider this when using Up/Down and the external reference switching command (H1-□□ = 2).

Using the Up/Down Function with Frequency Reference Hold (d4-01)

- If the frequency reference hold function is disabled (d4-01 = 0), the Up/Down frequency reference will be reset to 0 when the Run command is cleared or the power is cycled.
- When d4-01 = 1, the drive will save the frequency reference set by the Up/Down function. When the Run command or the power is cycled, the drive will restart with the saved reference value. Close the Up or Down input without an active Run command to reset the saved value.

Using the Up/Down Function with Frequency Reference Limits

The value for the lower frequency reference limit depends on the parameter d4-10 setting. This value can be set by an analog input or parameter d2-02. When a Run command is applied, the lower limits function as follows:

- If the lower limit is set by d2-02 only, the drive accelerates to this limit as soon as a Run command is entered.
- If the lower limit is determined by an analog input only, the drive accelerates to the limit when both the Run command and an Up or Down command are active. The drive will not start running if only the Run command is active.
- If the lower limit is set by both an analog input and d2-02, and the analog limit is higher than the d2-02 value, the drive accelerates to the d2-02 value when a Run command is input. When the d2-02 value is reached, the drive accelerates to the analog limit only if an Up or Down command is set.

Figure 5.21 shows an Up/Down function example with a lower frequency reference limit set by d2-02, and the frequency reference hold function both enabled and disabled.

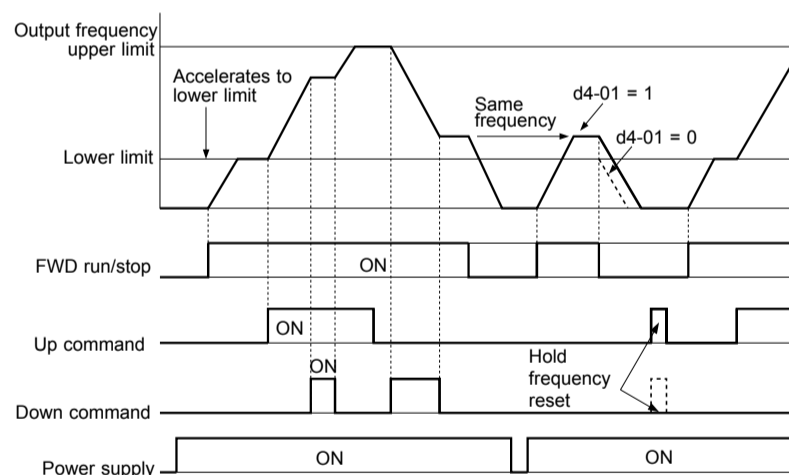

Figure 5.21 Up/Down Command Operation

Setting 13: Reverse Jog

Note: Available in bypass controller software versions VST800298 and earlier.

Digital inputs programmed as Reverse Jog (H1-□□ = 13) are Jog inputs that do not require a Run command. Closing the terminal set for Reverse Jog input will cause the drive to ramp to the Jog frequency reference (d1-17) in the reverse direction.

Note: The Reverse Jog command overrides all other frequency references. However, if the drive is set to prohibit reverse rotation (b1-04 = 1), activating Reverse Jog will have no effect.

Setting 14: Fault Reset

When the drive detects a fault condition, the fault output contact closes, the drive output shuts off, and the motor coasts to stop (specific stopping methods can be selected for some faults such as L1-04 for motor overheat). After removing the Run command, clear the fault either by pressing the RESET key on the HOA keypad or closing a digital input configured as a Fault Reset (H1-□□ = 14).

Note: Remove the Run command prior to resetting a fault. Fault Reset commands are ignored while the Run command is present.

Setting 19: PID Disable

Close a digital input to indefinitely disable the PID function. When the input is released, the drive resumes PID operation. *Refer to PID Block Diagram on page 93.*

Setting 24: External Fault

The External fault command stops the drive when problems occur with external devices.

To use the External fault command, set one of the multi-function digital inputs to 24. The HOA keypad will display EF□ where □ is the number of the terminal to which the external fault signal is assigned.

For example, if an external fault signal is input to terminal DI-3, “EF3” will be displayed.

The conditions of setting 24 are:

- Terminal status is normally open
- Detection condition is always detected
- Stopping method is coast to stop.

Setting 60: DC Injection Braking Command

DC Injection Braking is activated when a DC Injection Braking command is input while the drive is stopped. DC Injection Braking is released when a Run command or a Jog command is input. *Refer to b2: DC Injection Braking and Short Circuit Braking on page 85* for details on setting up the DC Injection Braking function.

The diagram below illustrates DC Injection Braking:

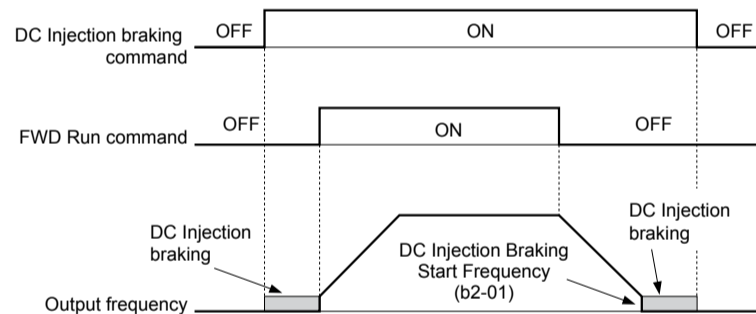

Figure 5.22 DC Injection Braking Input Timing Diagram

◆ **H2: Multi-Function Digital Outputs**

Note: H2-□□ parameters are available in bypass controller software versions VST800298 and later.

■ **H2-01 to H2-03: Terminal M1-M2, M3-M4, and M5-M6 Function Selection**

The bypass has three multi-function output terminals. *Table 5.23* lists the functions available for these terminals using H2-01, H2-02, and H2-03.

No.	Parameter Name	Setting Range	Default
H2-01	Terminal M1-M2 Function Selection (relay)	0 to 160	0: During Run 1
H2-02	Terminal M3-M4 Function Selection (relay)	0 to 160	1: Zero Speed
H2-03	Terminal M5-M6 Function Selection (relay)	0 to 160	2: Speed Agree 1

Table 5.23 Multi-Function Digital Output Terminal Settings

Setting	Function	Page	Setting	Function	Page
0	During Run 1	118	3	User-Set Speed Agree 1	119
1	Zero Speed	118	4	Frequency Detection 1	119
2	Speed Agree 1	118	5	Frequency Detection 2	120

5.7 H: Terminal Functions

Setting	Function	Page	Setting	Function	Page
6	Drive Ready	120	17	Torque Detection 1 (N.C.)	121
7	DC Bus Undervoltage	120	1A	During Reverse	123
8	During Baseblock 1 (N.O.)	120	1B	During Baseblock 2 (N.C.)	123
B	Torque Detection 1 (N.O.)	121	1E	Restart Enabled	123
C	Frequency Reference Loss	121	20	Drive Overheat Pre-Alarm (oH)	123
E	Fault	121	2F	Maintenance Period	123
F	Through Mode	121	37	During Run 2	123
10	Minor Fault	121	39	Watt Hour Pulse Output	124
11	Fault Reset Command Active	121	3D	During Speed Search	124
13	Speed Agree 2	121	4C	During Fast Stop	124
14	User-Set Speed Agree 2	121	4D	oH Pre-Alarm Time Limit	124
15	Frequency Detection 3	122	60	Internal Cooling Fan Alarm	124
16	Frequency Detection 4	122	100 to 160	Functions 0 to 60 with Inverse Output	124

Setting 0: During Run

The output closes when the drive is outputting a voltage.

Status	Description
Open	Drive is stopped.
Closed	A Run command is input or the drive is in deceleration or DC injection.

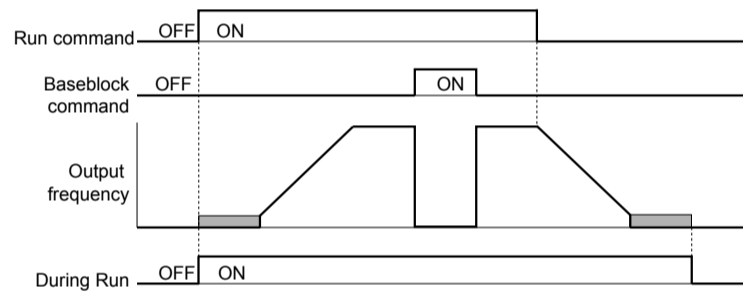

Figure 5.23 During Run Time Chart

Setting 1: Zero Speed

The output closes when the output frequency or motor speed falls below the minimum output frequency set to E1-09 or b2-01.

Status	Description
Open	Output frequency is above the minimum output frequency set to E1-09 or b2-01
Closed	Output frequency is less than the minimum output frequency set to E1-09 or b2-01

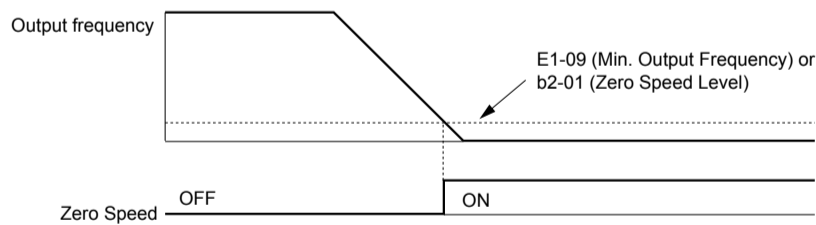

Figure 5.24 Zero-Speed Time Chart

Setting 2: Speed Agree 1 (f_{ref}/f_{out} Agree 1)

The output closes when the actual output frequency or motor speed is within the Speed Agree Width (L4-02) of the current frequency reference regardless of the direction.

5.7 H: Terminal Functions

Status	Description
Open	Output frequency or motor speed does not match the frequency reference while the drive is running.
Closed	Output frequency or motor speed is within the range of frequency reference $\pm L4-02$.

Note: Detection works in forward and reverse.

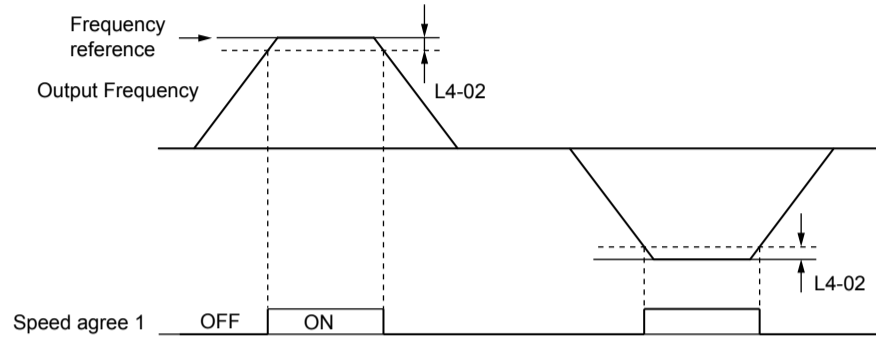

Figure 5.25 Speed Agree 1 Time Chart

Setting 3: User-Set Speed Agree 1 (f_{ref}/f_{set} Agree 1)

The output closes when the actual output frequency or motor speed and the frequency reference are within the speed agree width ($L4-02$) of the programmed speed agree level ($L4-01$).

Status	Description
Open	Output frequency or motor speed and frequency reference are not both within the range of $L4-01 \pm L4-02$.
Closed	Output frequency or motor speed and the frequency reference are both within the range of $L4-01 \pm L4-02$.

Note: Frequency detection works in forward and reverse. The value of $L4-01$ is used as the detection level for both directions.

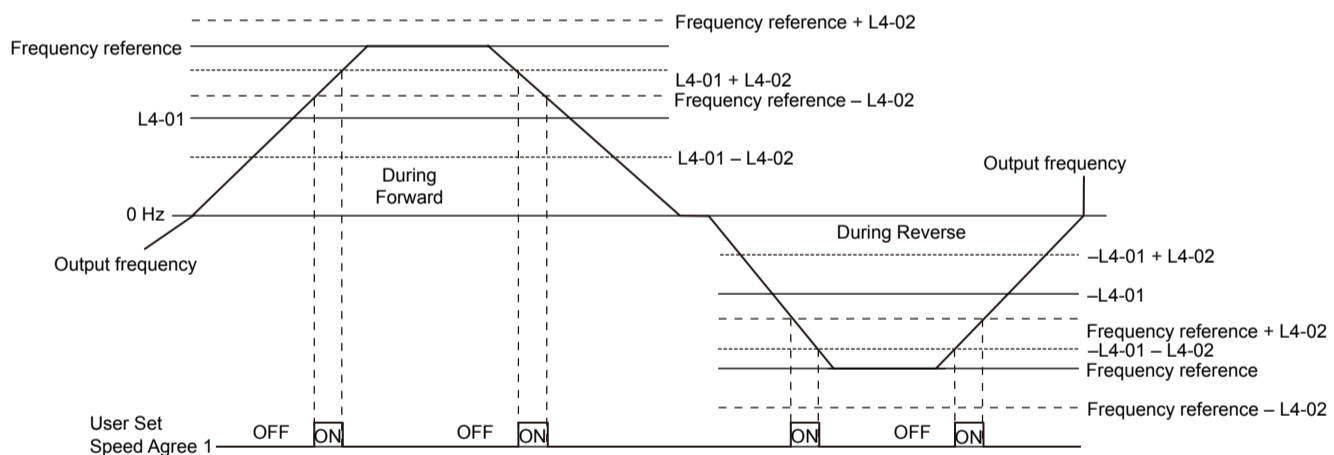

Figure 5.26 User Set Speed Agree 1 Time Chart

Setting 4: Frequency Detection 1

The output opens when the output frequency or motor speed rises above the detection level set in $L4-01$ plus the detection width set in $L4-02$. The terminal remains open until the output frequency or motor speed fall below the level set in $L4-01$.

Status	Description
Open	Output frequency or motor speed exceeded $L4-01 + L4-02$.
Closed	Output frequency or motor speed is below $L4-01$ or has not exceeded $L4-01 + L4-02$.

Note: Frequency detection works in forward and reverse. The value of $L4-01$ is used as the detection level for both directions.

5.7 H: Terminal Functions

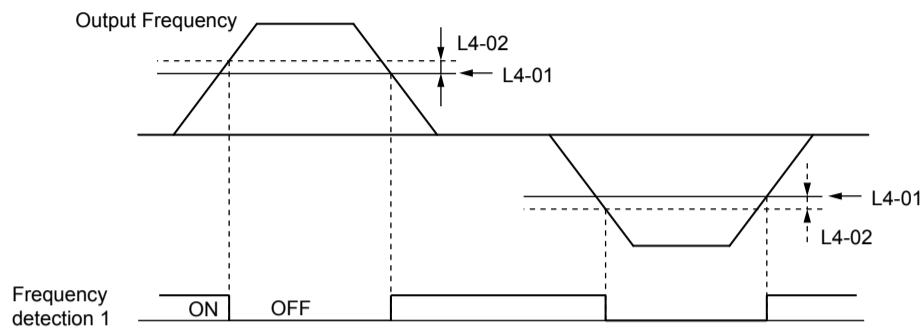

Figure 5.27 Frequency Detection 1 Time Chart

Setting 5: Frequency Detection 2

The output closes when the output frequency or motor speed is above the detection level set in L4-01. The terminal remains closed until the output frequency or motor speed fall below L4-01 minus the setting of L4-02.

Status	Description
Open	Output frequency or motor speed is below L4-01 minus L4-02 or has not exceeded L4-01.
Closed	Output frequency or motor speed exceeded L4-01.

Note: Frequency detection works in forward and reverse. The value of L4-01 is used as the detection level for both directions.

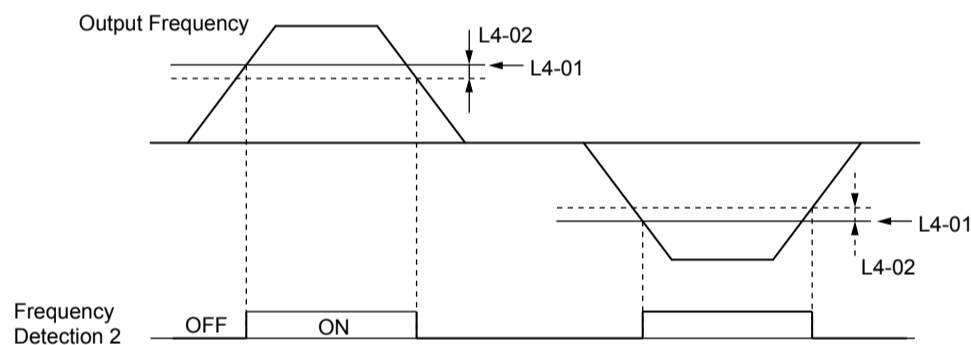

Figure 5.28 Frequency Detection 2 Time Chart

Setting 6: Drive Ready

The output closes when the drive is ready to operate the motor. The terminal will not close under the conditions listed below, and any Run commands will be disregarded.

- When the power is shut off
- During a fault
- When the internal power supply of the drive has malfunctioned
- When a parameter setting error makes it impossible to run
- Although stopped, an overvoltage or undervoltage situation occurs
- While editing a parameter in the Programming Mode (when b1-08 = 0)

Setting 7: DC Bus Undervoltage

The output closes when the DC bus voltage or control circuit power supply drops below the trip level set in L2-05. A fault in the DC bus circuit will also cause the terminal set for “DC bus undervoltage” to close.

Status	Description
Open	DC bus voltage is above the level set to L2-05.
Closed	DC bus voltage has fallen below the trip level set to L2-05.

Setting 8: During Baseblock 1 (N.O.)

The output closes to indicate that the drive is in a baseblock state. While in baseblock, output transistors do not switch and no main circuit voltage is output.

5.7 H: Terminal Functions

Status	Description
Open	Drive is not in a baseblock state.
Closed	Baseblock is being executed.

Settings B and 17: Torque Detection 1 (N.O., N.C.)

These digital output functions signal an overtorque or undertorque situation to an external device.

Set up the torque detection levels and select the output function from the table below.

Setting	Status	Description
B	Closed	Torque detection 1 (N.O.): Output current/torque exceeds (overtorque detection) or is below (undertorque detection) the torque value set in parameter L6-02 for longer than the time specified in parameter L6-03.
17	Open	Torque detection 1 (N.C.): Output current/torque exceeds (overtorque detection) or is below (undertorque detection) the torque value set in parameter L6-02 for longer than the time specified in parameter L6-03.

Setting C: Frequency Reference Loss

The output closes when frequency reference loss is detected.

Setting E: Fault

The output closes when the drive faults (excluding CPF00 and CPF01 faults).

Setting F: Through Mode

Select this setting when using the terminal in a pass-through mode. When set to F, an output does not trigger any function in the drive. Setting F, however, still allows the output status to be read by a PLC via a communication option or MEMOBUS/Modbus communications.

Setting 10: Minor Fault

The output closes when a minor fault condition is present.

Setting 11: Fault Reset Command Active

The output closes when there is an attempt to reset a fault situation from the control circuit terminals, via serial communications, or using a communications option card.

Setting 13: Speed Agree 2 (f_{ref}/f_{out} Agree 2)

The output closes when the actual output frequency or motor speed is within the speed agree width (L4-04) of the current frequency reference, regardless of the direction.

Status	Description
Open	Output frequency or motor speed does not match the frequency reference while the drive is running.
Closed	Output frequency or motor speed is within the range of frequency reference $\pm L4-04$.

Note: Detection works in forward and reverse.

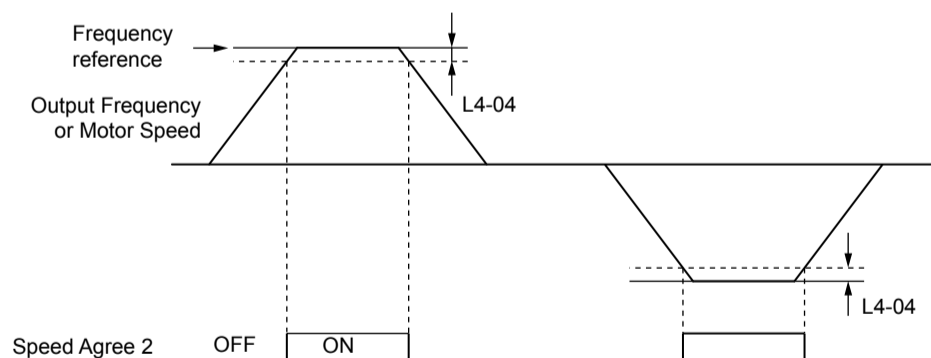

Figure 5.29 Speed Agree 2 Time Chart

Setting 14: User-Set Speed Agree 2 (f_{ref}/f_{set} Agree 2)

The output closes when the actual output frequency or motor speed and the frequency reference are within the speed agree width (L4-04) of the programmed speed agree level (L4-03).

5.7 H: Terminal Functions

Status	Description
Open	Output frequency or motor speed and frequency reference are both outside the range of L4-03 \pm L4-04.
Closed	Output frequency or motor speed and the frequency reference are both within the range of L4-03 \pm L4-04.

Note: The detection level L4-03 is a signed value; detection works in the specified direction only.

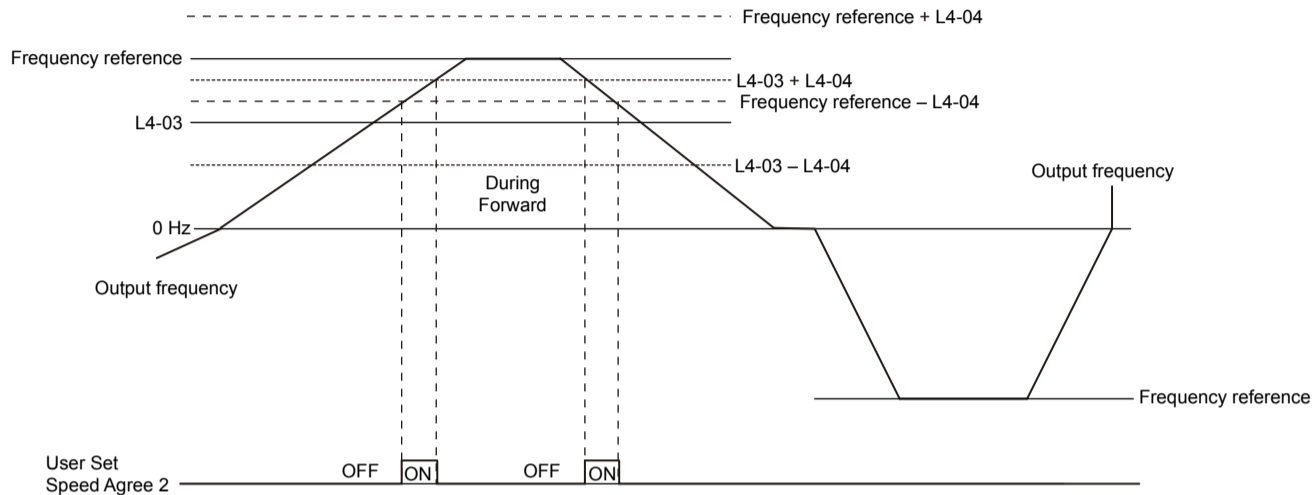

Figure 5.30 User-Set Speed Agree 2 Example with a Positive L3-04 Value

Setting 15: Frequency Detection 3

The output opens when the output frequency or motor speed rises above the detection level set in L4-03 plus the detection with set in L4-04. The terminal remains open until the output frequency or motor speed falls below the level set in L4-03. The detection level L4-03 is a signed value; detection works in the specified direction only.

Status	Description
Open	Output frequency or motor speed exceeded L4-03 plus L4-04.
Closed	Output frequency or motor speed is below L4-03 or has not exceeded L4-03 plus L4-04.

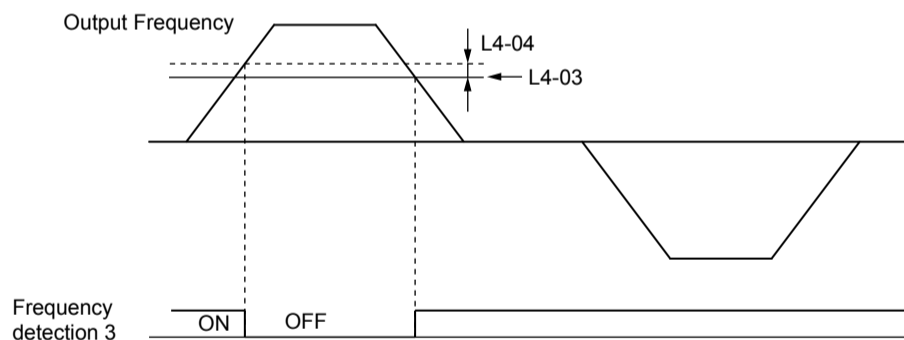

Figure 5.31 Frequency Detection 3 Example with a Positive L3-04 Value

Setting 16: Frequency Detection 4

The output closes when the output frequency or motor speed is above the detection level set in L4-03. The terminal remains closed until the output frequency or motor speed falls below L4-03 minus the setting of L4-04.

Status	Description
Open	Output frequency or motor speed is below L4-03 minus L4-04 or has not exceeded L4-03.
Closed	Output frequency or motor speed exceeded L4-03.

Note: The detection level L4-03 is a signed value; detection works in the specified direction only.

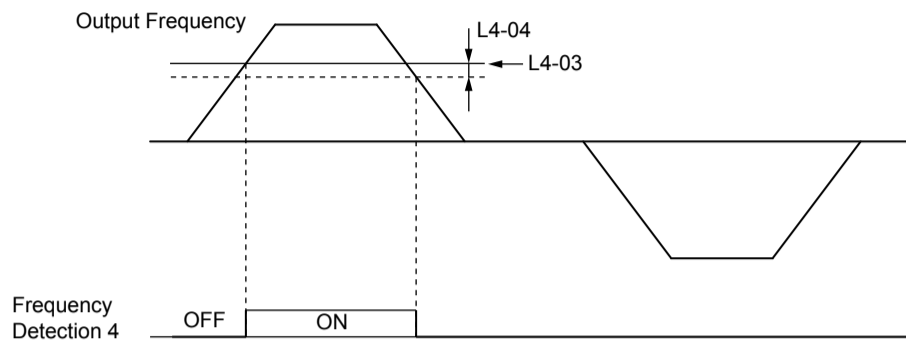

Figure 5.32 Frequency Detection 4 Example with Positive L3-04 Value

Setting 1A: During Reverse

The output closes when the drive is running the motor in the reverse direction.

Status	Description
Open	Motor is being driven in the forward direction or stopped.
Closed	Motor is being driven in reverse.

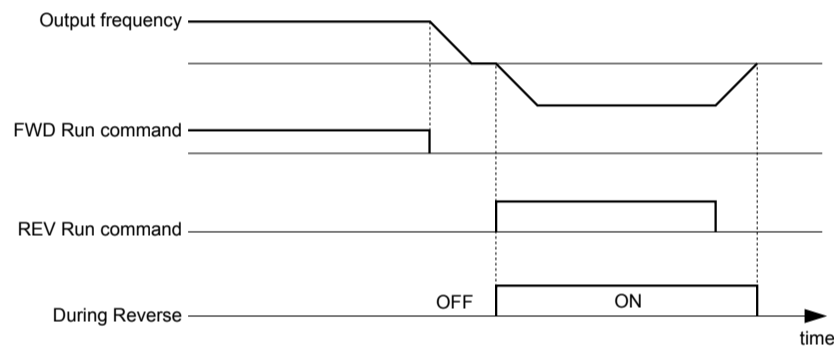

Figure 5.33 Reverse Direction Output Example Time Chart

Setting 1B: During Baseblock 2 (N.C.)

The output opens to indicate that the drive is in a baseblock state. While baseblock is executed, output transistors do not switch and no main circuit voltage is output.

Status	Description
Open	Baseblock is being executed.
Closed	Drive is not in a baseblock state.

Setting 1E: Restart Enabled

The output closes when the drive attempts to restart after a fault has occurred.

The fault restart function allows the drive to automatically clear a fault. The terminal set to 1E will close after the fault is cleared and the drive has attempted to restart. If the drive cannot successfully restart within the number of attempts permitted by L5-01, a fault will be triggered and the terminal set to 1E will open.

Setting 20: Drive Overheat Pre-Alarm (oH)

The output closes when the drive heatsink temperature reaches the level specified by parameter L8-02.

Setting 2F: Maintenance Period

The output closes when the cooling fan, DC bus capacitors, or DC bus pre-charge relay may require maintenance as determined by the estimated performance life span of those components. Components performance life is displayed as a percentage on the HOA keypad screen.

Setting 37: During Run 2

The output closes when the drive is outputting a frequency.

5.7 H: Terminal Functions

Status	Description
Open	Drive is stopped or one of the following functions is being performed: baseblock, DC Injection Braking, Short Circuit Braking.
Closed	Drive is outputting frequency.

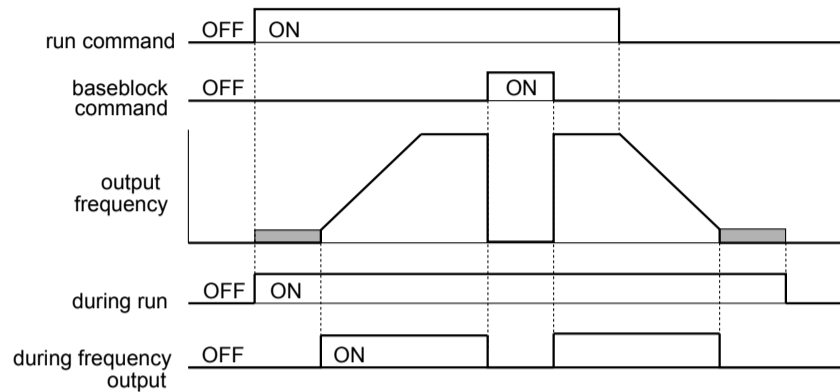

Figure 5.34 During Frequency Output Time Chart

Setting 39: Watt Hour Pulse Output

Outputs a pulse to indicate the watt hours.

Setting 3D: During Speed Search

The output terminal closes while Speed Search is being performed.

Setting 4C: During Fast Stop

The output terminal closes when a Fast Stop is being executed.

Setting 4D: oH Pre-Alarm Time Limit

The output terminal closes when the drive is reducing the speed due to a drive overheat alarm (L8-03 = 4) and the overheat alarm has not disappeared after 10 frequency reduction operation cycles.

Setting 60: Internal Cooling Fan Alarm

The output closes when the drive internal cooling fan has failed.

Setting 100 to 160: Functions 0 to 60 with Inverse Output

These settings have the same function as settings 0 to 60, but with inverse output. Set as 1□□, where the “1” indicates inverse output and the last two digits specify the setting number of the function.

Examples:

- Set 108 for inverse output of “8: During Baseblock 1 (N.O.)”.
- Set 14D for inverse output of “4D: oH Pre-Alarm Time Limit”.

◆ H3: Multi-Function Analog Inputs

The drive is equipped with three multi-function analog input terminals: A1, A2, and A3. *Refer to Multi-Function Analog Input Terminal Settings on page 128* for a listing of the functions that can be set to these terminals.

■ H3-01: Terminal A1 Signal Level Selection

Selects the input signal level for analog input A1. Set jumper S1 on the terminal board accordingly for voltage input or current input.

No.	Name	Setting Range	Default
H3-01	Terminal A1 Signal Level Selection	0 to 3	0

Setting 0: 0 to 10 V with Zero Limit

The input level is 0 to 10 Vdc with zero limit. The minimum input level is limited to 0%, so that a negative input signal due to gain and bias settings will be read as 0%.

Setting 1: 0 to 10 V without Zero Limit

The input level is 0 to 10 Vdc without zero limit. If the resulting voltage is negative after being adjusted by gain and bias settings, then the motor will rotate in reverse.

Setting 2: 4 to 20 mA Current Input

The input level is 4 to 20 mA. Negative input values by negative bias or gain settings are limited to 0%.

Setting 3: 0 to 20 mA Current Input

The input level is 0 to 20 mA. Negative input values by negative bias or gain settings are limited to 0%.

■ H3-02: Terminal A1 Function Selection

Selects the input signal level for analog input A1. *Refer to Multi-Function Analog Input Terminal Settings on page 128* for instructions on adjusting the signal level.

No.	Name	Setting Range	Default
H3-02	Terminal A1 Function Selection	0 to 26	0

■ H3-03, H3-04: Terminal A1 Gain and Bias Settings

Parameter H3-03 sets the level of the selected input value that is equal to 10 Vdc (20 mA) input at terminal A1 (gain).

Parameter H3-04 sets the level of the selected input value that is equal to 0 V (4 mA, 0 mA) input at terminal A1 (bias).

Use both parameters to adjust the characteristics of the analog input signal to terminal A1.

No.	Name	Setting Range	Default
H3-03	Terminal A1 Gain Setting	-999.9 to 999.9%	100.0%
H3-04	Terminal A1 Bias Setting	-999.9 to 999.9%	0.0%

Setting Examples

- Gain H3-03 = 200%, bias H3-04 = 0, terminal A1 as frequency reference input (H3-02 = 0):

A 10 Vdc input is equivalent to a 200% frequency reference and 5 Vdc is equivalent to a 100% frequency reference. Since the drive output is limited by the maximum frequency parameter (E1-04), the frequency reference will be equal to E1-04 above 5 Vdc.

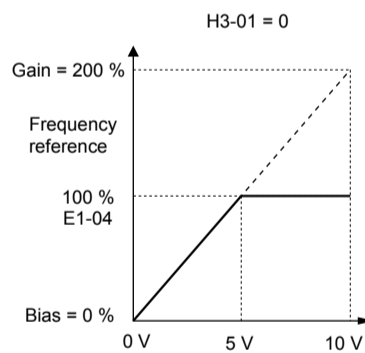

Figure 5.35 Frequency Reference Setting by Analog Input with Increased Gain

- Gain H3-03 = 100%, bias H3-04 = -25%, terminal A1 as frequency reference input:

An input of 0 Vdc will be equivalent to a -25% frequency reference.

When parameter H3-01 = 0, the frequency reference is 0% between 0 and 2 Vdc input.

5.7 H: Terminal Functions

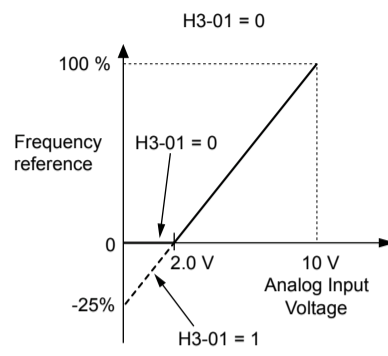

Figure 5.36 Frequency Reference Setting by Analog Input with Negative Bias

■ H3-05: Terminal A3 Signal Level Selection

Determines the function assigned to analog input terminal A3. *Refer to Multi-Function Analog Input Terminal Settings on page 128* for a list of functions and descriptions.

No.	Name	Setting Range	Default
H3-05	Terminal A3 Signal Level Selection	0 to 3	0

Setting 0: 0 to 10 Vdc

The input level is 0 to 10 Vdc. See the explanation provided for H3-01. *Refer to Setting 0: 0 to 10 V with Zero Limit on page 124.*

Setting 1: 0 to 10 Vdc Bipolar

The input level is -10 to 10 Vdc. See the explanation provided for H3-01. *Refer to Setting 1: 0 to 10 V without Zero Limit on page 125.*

Setting 2: 4 to 20 mA

Setting 3: 0 to 20 mA

■ H3-06: Terminal A3 Function Selection

Determines the function assigned to analog input terminal A3. *Refer to Multi-Function Analog Input Terminal Settings on page 128* for a list of functions and descriptions.

No.	Name	Setting Range	Default
H3-06	Terminal A3 Function Selection	0 to 26	2

■ H3-07, H3-08: Terminal A3 Gain and Bias Setting

Parameter H3-07 sets the level of the selected input value that is equal to 10 Vdc input at terminal A3 (gain).

Parameter H3-08 sets the level of the selected input value that is equal to 0 V input at terminal A3 (bias).

No.	Name	Setting Range	Default
H3-07	Terminal A3 Gain Setting	-999.9 to 999.9%	100.0%
H3-08	Terminal A3 Bias Setting	-999.9 to 999.9%	0.0%

■ H3-09: Terminal A2 Signal Level Selection

Selects the input signal level for analog input A2. Set Jumper S1 on the terminal board accordingly for a voltage input or current input.

No.	Name	Setting Range	Default
H3-09	Terminal A2 Signal Level Selection	0 to 3	2

Setting 0: 0 to 10 V with Zero Limit

The input level is 0 to 10 Vdc. Negative input values will be limited to 0. *Refer to Setting 0: 0 to 10 V with Zero Limit on page 124.*

Setting 1: 0 to 10 V without Zero Limit

The input level is 0 to 10 Vdc. Negative input values will be accepted. *Refer to Setting 1: 0 to 10 V without Zero Limit on page 125.*

Setting 2: 4 to 20 mA Current Input

The input level is 4 to 20 mA. Negative input values by negative bias or gain settings will be limited to 0%.

Setting 3: 0 to 20 mA Current Input

The input level is 0 to 20 mA. Negative input values by negative bias or gain settings will be limited to 0%.

■ H3-10: Terminal A2 Function Selection

Determines the function assigned to analog input terminal A2. *Refer to Multi-Function Analog Input Terminal Settings on page 128* for a list of functions and descriptions.

No.	Name	Setting Range	Default
H3-10	Terminal A2 Function Selection	0 to 26	0

5.7 H: Terminal Functions

■ H3-11, H3-12: Terminal A2 Gain and Bias Setting

Parameter H3-11 sets the level of the input value selected that is equal to 10 Vdc input or 20 mA input to terminal A2.

Parameter H3-12 sets the level of the input value selected that is equal to 0 V, 4 mA or 0 mA input at terminal A2.

Use both parameters to adjust the characteristics of the analog input signal to terminal A2. The setting works in the same way as parameters H3-03 and H3-04 for analog input A1.

No.	Name	Setting Range	Default
H3-11	Terminal A2 Gain Setting	-999.9 to 999.9%	100.0%
H3-12	Terminal A2 Bias Setting	-999.9 to 999.9%	0.0%

■ H3-13: A1/A2 Input Filter Time Constant

Parameter H3-13 sets the time constant for a first order filter that will be applied to the analog inputs.

An analog input filter prevents erratic drive control when using a “noisy” analog reference. Drive operation becomes more stable as the programmed time becomes longer, but it also becomes less responsive to rapidly changing analog signals.

No.	Name	Setting Range	Default
H3-13	A1/A2 Input Filter Time Constant	0.00 to 2.00 s	0.03 s

■ H3-14: Analog Input Terminal Enable Selection

When one of the multi-function digital input parameters is set for “Analog input enable” (H1-□□ = C), the value set to H3-14 determines which analog input terminals are enabled when the input is closed. All of the analog input terminals will be enabled all of the time when H1-□□ ≠ C. The terminals not set as the target are not influenced by input signals.

No.	Name	Setting Range	Default
H3-14	Analog Input Terminal Enable Selection	1 to 7	7

Setting 1: A1 Only Enabled

Setting 2: A2 Only Enabled

Setting 3: A1 and A2 Only Enabled

Setting 4: A3 Only Enabled

Setting 5: A1 and A3 Only Enabled

Setting 6: A2 and A3 Only Enabled

Setting 7: All Analog Input Terminals Enabled

■ H3-16 to H3-18: Terminal A1/A2/A3 Offset

Set the offset level of the selected input value to terminals A1, A2, or A3 that is equal to 0 Vdc input. These parameters rarely require adjustment.

No.	Name	Setting Range	Default
H3-16	Terminal A1 Offset	-500 to 500	0
H3-17	Terminal A2 Offset	-500 to 500	0
H3-18	Terminal A3 Offset	-500 to 500	0

■ Multi-Function Analog Input Terminal Settings

See **Table 5.24** for information on how H3-02 and H3-10 determine functions for terminals A1 and A2.

Note: The scaling of all input functions depends on the gain and bias settings for the analog inputs. Set these to appropriate values when selecting and adjusting analog input functions.

Table 5.24 Multi-Function Analog Input Terminal Settings

Setting	Function	Page	Setting	Function	Page
0	Frequency Bias	129	2	Auxiliary Frequency Reference 1	129
1	Frequency Gain	129	3	Auxiliary Frequency Reference 2	129

5.7 H: Terminal Functions

Setting	Function	Page	Setting	Function	Page
4	Output Voltage Bias	129	D	Frequency Bias	130
5	Accel/Decel Time Gain	129	E	Motor Temperature (PTC Input)	130
6	DC Injection Braking Current	129	F	Not used	130
7	Overtorque/Undertorque Detection Level	130	16	Differential PI Feedback	130
8	Stall Prevention Level During Run	130	1F <I>	HAND Reference	131
9	Output Frequency Lower Limit Level	130	25	Secondary PID Setpoint	131
B	PID Feedback	130	26	Secondary PID Feedback	131
C	PID Setpoint	130			

<I> Setting 1F is “HAND Reference” in bypass controller software versions VST800298 and later. Setting 1F is “Not Used (Through Mode)” in bypass controller software versions VST800297 and earlier.

Setting 0: Frequency Bias

The input value of an analog input set to this function will be added to the analog frequency reference value. When the frequency reference is supplied by a different source other than the analog inputs, this function will have no effect. Use this setting also when only one of the analog inputs is used to supply the frequency reference.

By default, analog inputs A1 and A2 are set for this function. Simultaneously using A1 and A2 increases the frequency reference by the total of all inputs.

Example: If the analog frequency reference from analog input terminal A1 is 50% and a bias of 20% is applied by analog input terminal A2, the resulting frequency reference will be 70% of the maximum output frequency.

Setting 1: Frequency Gain

The input value of an analog input set to this function will be multiplied with the analog frequency reference value.

Example: If the analog frequency reference from analog input terminal A1 is 80% and a gain of 50% is applied from analog input terminal A2, the resulting frequency reference will be 40% of the maximum output frequency.

Setting 2: Auxiliary Reference 1

Sets the auxiliary frequency reference 1 when multi-step speed operation is selected. *Refer to Multi-Step Speed Selection on page 106* for details.

Setting 3: Auxiliary Reference 2

Sets the auxiliary frequency reference 2 when multi-step speed operation is selected. *Refer to Multi-Step Speed Selection on page 106* for details.

Setting 4: Output Voltage Bias

Voltage bias boosts the output voltage of the V/f curve as a percentage of the maximum output voltage (E1-05). Available only when using V/f Control.

Setting 5: Accel/Decel Time Gain

Adjusts the gain level for the acceleration and deceleration times set to parameters C1-01 through C1-08.

The drive acceleration time is calculated by multiplying the gain level to C1-□□ as follows:

$C1-□□ \times \text{Accel/decel time gain} = \text{Drive accel/decel time}$

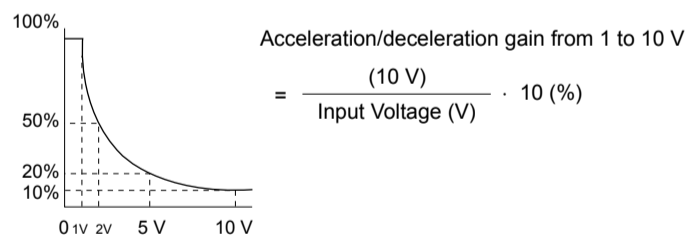

Figure 5.37 Accel/Decel Time Gain with Analog Input Terminal

Setting 6: DC Injection Braking Current

The current level used for DC Injection Braking is set as a percentage of the drive rated current.

5.7 H: Terminal Functions

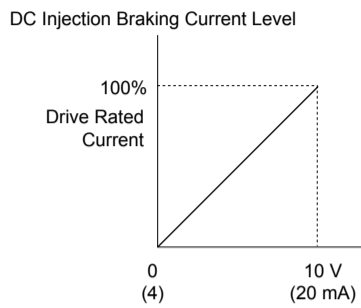

Figure 5.38 DC Injection Braking Current Using an Analog Input Terminal

Setting 7: Torque Detection Level

Using this setting, the overtorque/undertorque detection level for torque detection 1 (L6-01) can be set by an analog input. The analog input replaces the level set to L6-02. An analog input of 100% (10 V or 20 mA) sets a torque detection level equal to 100% drive rated current/motor rated torque. Adjust the analog input gain if higher detection level settings are required. *Refer to L6: Torque Detection on page 142* for details on torque detection.

Setting 8: Stall Prevention Level

Allows an analog input signal to adjust the Stall Prevention level. *Figure 5.39* shows the setting characteristics. The drive will use the lower value of the Stall Prevention level set to L3-06 or the level coming from the selected analog input terminal.

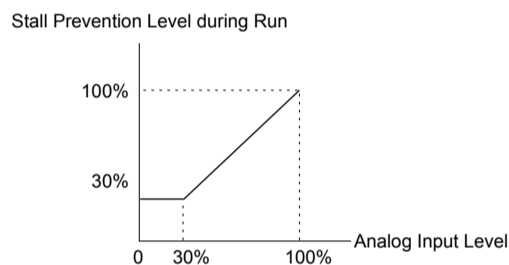

Figure 5.39 Stall Prevention During Run Using an Analog Input Terminal

Setting 9: Output Frequency Lower Limit Level

The user can adjust the lower limit of the output frequency using an analog input signal.

Setting B: PID Feedback

Supplies the PID feedback value. This setting requires PID operation to be enabled in b5-01. *Refer to PID Feedback Input Methods on page 92.*

Setting C: PID Setpoint

Supplies the PID setpoint value and makes the frequency reference selected in parameter b1-01 no longer the PID setpoint. PID operation to be enabled in b5-01 to use this setting. *Refer to PID Setpoint Input Methods on page 91.*

Setting D: Frequency Bias

The input value of an analog input set to this function will be added to the frequency reference. This function can be used with any frequency reference source.

Setting E: Motor Temperature

In addition to motor overload fault detection oL1, it is possible to use a PTC (Positive Temperature Coefficient) thermistor for motor insulation protection.

Setting F: Not used

When set to F, an input does not affect any drive function, but the input level can still be read out by a PLC via a BACnet communication or MEMOBUS/Modbus communications.

Setting 16: Differential PID Feedback

If an analog value is set for this function, the PID controller is set for differential feedback. The difference of the PID feedback input value and the differential feedback input value builds the feedback value used to calculate the PID input. *Refer to PID Feedback Input Methods on page 92.*

Setting 1F: HAND Reference

Sets the frequency reference when in HAND Mode and parameter Z1-41, HAND Speed Reference Selection, is set to 1 (Analog).

Note: Setting 1F is “HAND Reference” in bypass controller software versions VST800298 and later.

Setting 1F: Not Used (Through Mode)

Set this value when using the terminal in the pass-through mode.

Note: Setting 1F is “Not Used (Through Mode)” in bypass controller software versions VST800297 and earlier.

Setting 25: Secondary PI Setpoint

10 V = S3-02 (Maximum Output Frequency).

Setting 26: Secondary PI Feedback

10 V = S3-02 (Maximum Output Frequency).

◆ **H4: Multi-Function Analog Outputs**

These parameters assign functions to analog output terminals FM and AM for monitoring a specific aspect of drive performance.

■ **H4-01, H4-04: Multi-Function Analog Output Terminal FM, AM Monitor Selection**

Sets the desired drive monitor parameter U□-□□ to output as an analog value via terminal FM and AM. *Refer to U: Monitor Parameters on page 161* for a list of all monitors. The “Analog Output Level” column indicates whether a monitor can be used for analog output.

Example: Enter “103” for U1-03.

No.	Name	Setting Range	Default
H4-01	Multi-Function Analog Output Terminal FM Monitor Selection	000 to 621	102
H4-04	Multi-Function Analog Output Terminal AM Monitor Selection	000 to 621	103

A setting of 031 or 000 applies no drive monitor to the analog output. With either of these settings, the output level of the terminals FM and AM can be set by a PLC via a communication option or MEMOBUS/Modbus (through mode).

■ **H4-02, H4-03: Multi-Function Analog Output Terminal FM Gain and Bias**
H4-05, H4-06: Multi-Function Analog Output Terminal AM Gain and Bias

Parameters H4-02 and H4-05 set the terminal FM and AM output signal level when the value of the selected monitor is at 100%. Parameters H4-03 and H4-06 set the terminal FM and AM output signal level when the value of the selected monitor is at 0%. Both are set as a percentage, where 100% equals 10 Vdc or 20 mA analog output and 0% equals 0 V or 4 mA. The output voltage of both terminals is limited to +/-10 Vdc.

The output signal range can be selected between 0 to +10 Vdc or -10 to +10 Vdc, or 4 to 20 mA using parameter H4-07 and H4-08. *Figure 5.40* illustrates how gain and bias settings work.

No.	Name	Setting Range	Default
H4-02	Multi-Function Analog Output Terminal FM Gain	-999.9 to 999.9%	100.0%
H4-03	Multi-Function Analog Output Terminal FM Bias	-999.9 to 999.9%	0.0%
H4-05	Multi-Function Analog Output Terminal AM Gain	-999.9 to 999.9%	50.0%
H4-06	Multi-Function Analog Output Terminal AM Bias	-999.9 to 999.9%	0.0%

Using Gain and Bias to Adjust Output Signal Level

When viewing a gain setting parameter (H4-02 or H4-05) on the HOA keypad, the analog output will supply a voltage signal equal to 100% of the monitor value (including changes made from bias and gain settings). When viewing a bias setting parameter (H4-03 or H4-06), the analog output voltage will supply a signal equal to 0% monitor value.

Example 1: Set H4-02 to 50% for an output signal of 5 V at terminal FM when the monitored value is at 100%.

Example 2: Set H4-02 to 150% for an output signal of 10 V at terminal FM when the monitored value is at 76.7%.

5.7 H: Terminal Functions

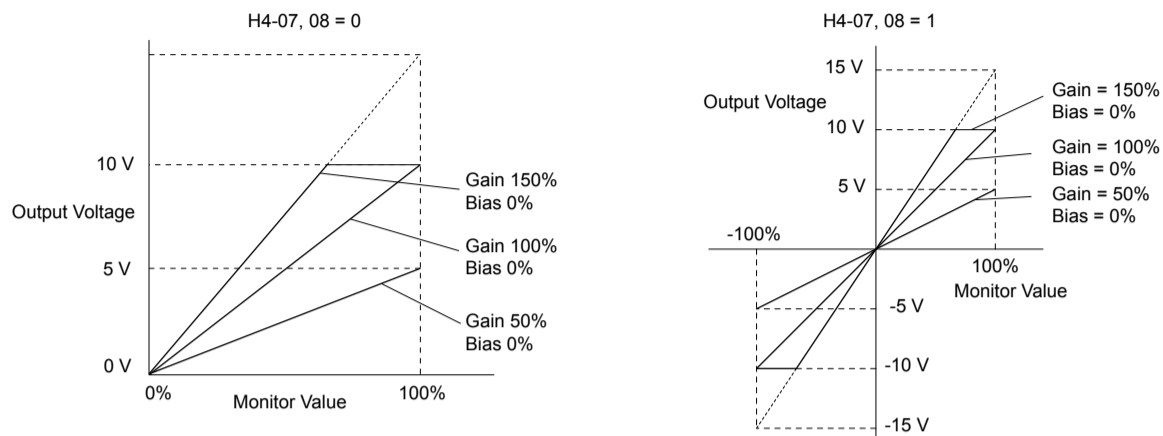

Figure 5.40 Analog Output Gain and Bias Setting Example 1 and 2

Example 3: Set H4-03 to 30% for an output signal of 3 V at terminal FM when the monitored value is at 0%.

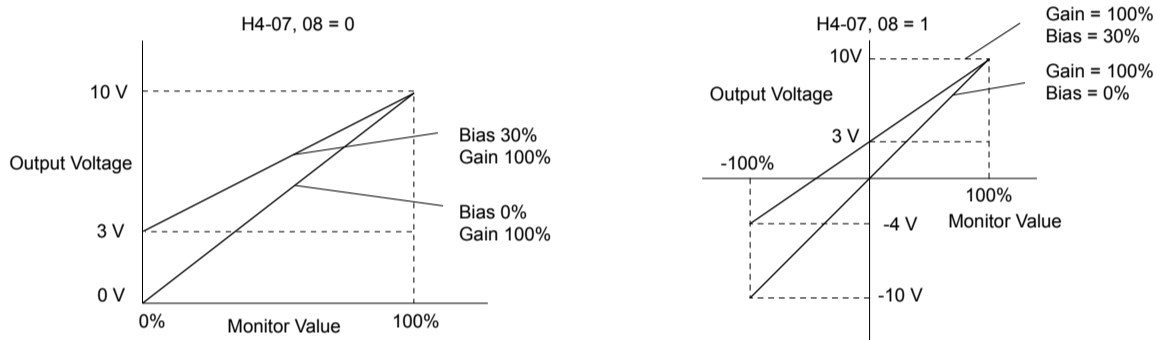

Figure 5.41 Analog Output Gain and Bias Setting Example 3

■ H4-07, H4-08: Multi-Function Analog Output Terminal FM, AM Signal Level Selection

Sets the voltage output level of U parameter (monitor parameter) data to terminal FM and terminal AM using parameters H4-07 and H4-08.

Set jumper S5 on the terminal board accordingly when changing these parameters.

No.	Name	Setting Range	Default
H4-07	Multi-Function Analog Output Terminal FM Signal Level Selection	0 to 2	0
H4-08	Multi-Function Analog Output Terminal AM Signal Level Selection	0 to 2	0

Setting 0: 0 to 10 V

Setting 1: -10 to +10 V

Setting 2: 4 to 20 mA

◆ H5: MEMOBUS/Modbus Serial Communication**■ H5-04: Stopping Method after Communication Error**

Selects the stopping method after the drive loses communication with the P1000 Bypass and causes a communications error (CE).

Note: Available in bypass controller software versions VST800297 and earlier.

No.	Name	Setting Range	Default
H5-04	Stopping Method after CE	0 to 3	3

Setting 0: Ramp to Stop

Uses the deceleration time currently enabled.

Setting 1: Coast to Stop**Setting 2: Fast Stop****Setting 3: Alarm Only - Operation Continues**

5.8 L: Protection Functions

5.8 L: Protection Functions

◆ L1: Motor Protection

■ L1-01: Motor Overload Protection Selection

The drive has an electronic overload protection function that estimates the motor overload level based on output current, output frequency, thermal motor characteristics, and time. When the drive detects a motor overload an oL1 fault is triggered and the drive output shuts off.

L1-01 sets the overload protection function characteristics according to the motor being used.

No.	Name	Setting Range	Default
L1-01	Motor Overload Protection Selection	0, 1	1

- Note:**
- When the motor protection function is enabled (L1-01 ≠ 0), an oL1 alarm can be output through one of the multi-function outputs by setting H2-01 to 1F^P. The output closes when the motor overload level reaches 90% of the oL1 detection level.
 - Set L1-01 to a value between 1 and 5 when running a single motor from the drive to select a method to protect the motor from overheat. An external thermal relay is not necessary.

<1> Details on this function can be found in the standard P1000 Technical Manual (SIEPYAIP1U01) at www.yaskawa.com.

Setting 0: Disabled (Motor Overload Protection Is not Provided)

Use this setting if no motor overheat protection is desired or if multiple motors are connected to a single drive. If multiple motors are connected to a single drive, install a thermal relay for each motor as shown in **Figure 5.42**.

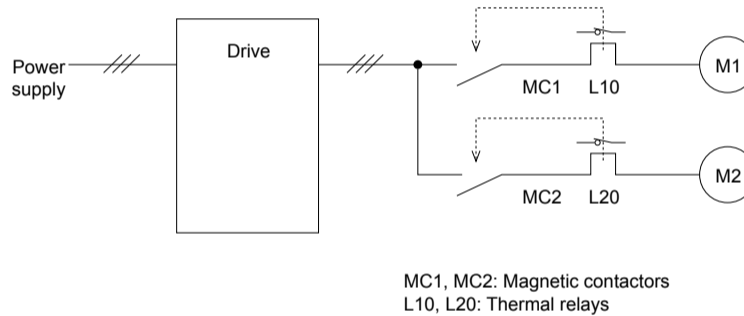

Figure 5.42 Example of Protection Circuit Design for Multiple Motors

NOTICE: Thermal protection cannot be provided when running multi-motors simultaneously with the same drive, or when using motors with a relatively high current rating compared to other standard motors (such as a submersible motor). Failure to comply could result in motor damage. Disable the electronic overload protection of the drive (L1-01 = "0: Disabled") and protect each motor with individual motor thermal overloads.

Note: Close MC1 and MC2 before operating the drive. MC1 and MC2 cannot be switched off during run.

Setting 1: General-Purpose Motor (Standard Self-Cooled)

Because the motor is self-cooled, the overload tolerance drops when the motor speed is lowered. The drive appropriately adjusts the electrothermal trigger point according to the motor overload characteristics, protecting the motor from overheat throughout the entire speed range.

Overload Tolerance	Cooling Ability	Overload Characteristics
<p>A: Max. speed for 200LJ and above B: Max. speed for 160MJ to 180 LJ C: Max. speed for 132MJ and below</p>	<p>Motor designed to operate from line power. Motor cooling is most effective when running at rated base frequency (check the motor nameplate or specifications).</p>	<p>Continuous operation at less than line power frequency with 100% load can trigger motor overload protection (oL1). A fault is output and the motor will coast to stop.</p>

■ **L1-02: Motor Overload Protection Time**

Sets the time for the drive to shut down on motor overload (oL1) when the motor is running with excessive current. Enter the time the motor can withstand operating at 150% current after previously running at 100% current (hot motor overload condition). There is normally no need to change this parameter from the default value.

No.	Name	Setting Range	Default
L1-02	Motor Overload Protection Time	0.1 to 5.0 minutes	1.0 minutes

Defaulted to operate with an allowance of 150% overload operation for one minute in a hot start after continuous operation at 100%.

Figure 5.43 illustrates an example of the electrothermal protection operation time using a general-purpose motor operating at the value of E1-06, Motor Base Speed, with L1-02 set to one minute.

Motor overload protection operates in the area between a cold start and a hot start.

- Cold start: Characteristics of motor protection operation time in response to an overload situation that was suddenly reached when starting a stationary motor.
- Hot start: Characteristics of motor protection operation time in response to an overload situation that occurred while the motor was operating continuously at or below its rated current.

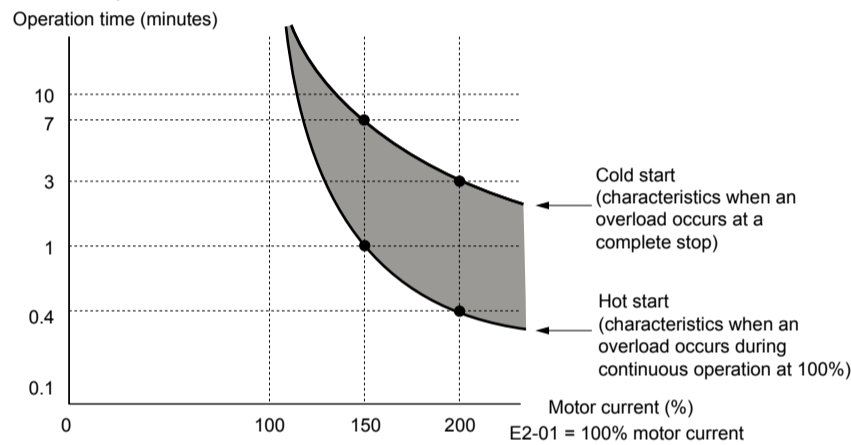

Figure 5.43 Protection Operation Time for General Purpose Motors at the Rated Output Frequency

◆ **L2: Momentary Power Loss Ride-Thru**

■ **L2-01: Momentary Power Loss Operation Selection**

When a momentary power loss occurs (DC bus voltage falls below the level set in L2-05), the drive can automatically return to the operation it was performing prior to the power loss based on certain conditions.

Note: Default is 2 in bypass controller software versions VST800298 and later. Default is 0 in bypass controller software versions VST800297 and earlier.

No.	Name	Setting Range	Default
L2-01	Momentary Power Loss Operation Selection	0 to 2	2

Setting 0: Disabled

If power is not restored within 15 ms, a Uv1 fault will result and the motor coasts to stop.

Setting 1: Recover within L2-02

When a momentary power loss occurs, the drive output will be shut off. If the power returns within the time set to parameter L2-02, the drive will perform Speed Search and attempt to resume operation. If the power does not return within this time, it will trigger a Uv1 fault.

Note: L2-02 value is dependent on drive model selection and is not accessible.

Setting 2: Recover as long as CPU Has Power

When a momentary power loss occurs, the drive output will be shut off. If the power returns and the drive control circuit has power, the drive will attempt to perform Speed Search and resume the operation. This will not trigger a Uv1 fault.

5.8 L: Protection Functions

Notes on Settings 1 and 2

- “Uv” will flash on the operator while the drive is attempting to recover from a momentary power loss. A fault signal is not output at this time.
- When using a magnetic contactor between the motor and the drive, keep the magnetic contactor closed as long as the drive attempts to restart with Speed Search.

■ L2-02: Momentary Power Loss Ride-Thru Time

Sets the maximum time allowed to ride through a power loss. If power loss operation exceeds this time, the drive will attempt to accelerate back to the frequency reference. This parameter is valid if L2-01 = 1.

Note: The amount of time the drive is capable of recovering after a power loss is determined by the capacity of the drive. Drive capacity determines the upper limit for L2-02.

No.	Name	Setting Range	Default
L2-02	Momentary Power Loss Ride-Thru Time	0.0 to 25.5 s	Determined by o2-04

■ L2-03: Momentary Power Loss Minimum Baseblock Time

Sets the minimum baseblock time when power is restored following a momentary power loss. This determines the time the drive waits for the residual voltage in the motor to dissipate. Increase this setting if overcurrent or overvoltage occurs at the beginning of Speed Search, after a power loss, or during DC Injection Braking.

No.	Name	Setting Range	Default
L2-03	Momentary Power Loss Minimum Baseblock Time	0.1 to 5.0 s	Determined by o2-04

■ L2-05: Undervoltage Detection Level (Uv)

Determines the voltage at which a Uv1 fault is triggered or at which the KEB function is activated. This setting rarely needs to be changed.

No.	Name	Setting Range	Default
L2-05	Undervoltage Detection Level	150 to 220 Vdc <I>	Determined by E1-01 and o2-04

<I> Values are specific to 208 Vac bypass drives. Double the value for 480 Vac bypass drives.

- Note:**
1. Install an AC reactor option on the input side of the power supply when setting L2-05 below the default value to prevent damage to drive circuitry.
 2. If using KEB Ride-Thru and L2-05 is set too low, then undervoltage in the DC bus (Uv1) will be triggered before KEB Ride-Thru can be executed. Take caution not to set this value too low.

◆ L3: Stall Prevention

The motor may experience excessive slip because it cannot keep up with the frequency reference when the load is too high or acceleration and deceleration times are too short. If the motor slips during acceleration, it usually causes an overcurrent fault (oC), drive overload (oL2), or motor overload (oL1). If the motor slips during deceleration, it can cause excessive regenerative power to flow back into the DC bus capacitors, and eventually cause the drive to fault out from overvoltage (ov). The Stall Prevention Function prevents the motor from stalling and while allowing the motor to reach the desired speed without requiring the user to change the acceleration or deceleration time settings. The Stall Prevention function can be set separately for acceleration, operating at constant speeds, and deceleration.

■ L3-02: Stall Prevention Level during Acceleration

Sets the output current level at which the Stall Prevention during acceleration is activated.

No.	Name	Setting Range	Default
L3-02	Stall Prevention Level during Acceleration	0 to 120% <I>	120%

<I> The upper limit is determined by parameter L8-38, Carrier Frequency Derating Selection.

- Lower L3-02 if stalling occurs when using a motor that is relatively small compared to the drive.
- Also set parameter L3-03 when operating the motor in the constant power range.

■ L3-03: Stall Prevention Limit during Acceleration

The Stall Prevention level is automatically reduced when the motor is operated in the constant power range. L3-03 sets the lower limit for this reduction as a percentage of the drive rated current.

No.	Name	Setting Range	Default
L3-03	Stall Prevention Limit during Acceleration	0 to 100%	50%

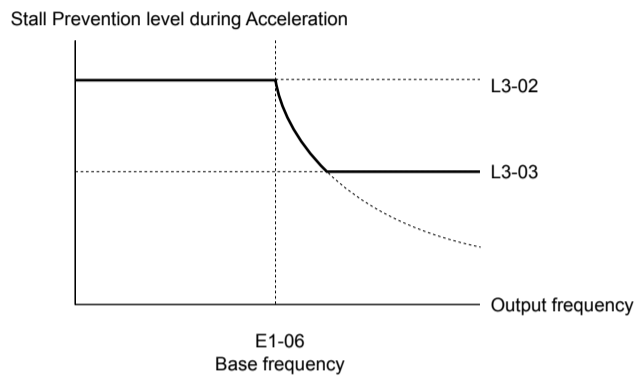

Figure 5.44 Stall Prevention Level and Limit During Acceleration

■ L3-04: Stall Prevention Selection during Deceleration

Stall Prevention during deceleration controls the deceleration based on the DC bus voltage and prevents an overvoltage fault caused by high inertia or rapid deceleration.

No.	Name	Setting Range	Default
L3-04	Stall Prevention Selection During Deceleration	0 to 5 <I>	1

<I> Setting 3 is not available in models 4A0930 or 4A1200.

Setting 0: Disabled

The drive decelerates according to the set deceleration time. With high inertia loads or rapid deceleration, an overvoltage fault may occur. If an overvoltage fault occurs, use dynamic braking options or switch to another L3-04 selection.

Setting 1: General-purpose Stall Prevention

The drive tries to decelerate within the set deceleration time. The drive pauses deceleration when the DC bus voltage exceeds the Stall Prevention level and then continues deceleration when the DC bus voltage drops below that level. Stall Prevention may be triggered repeatedly to avoid an overvoltage fault. The DC bus voltage level for Stall Prevention depends on the input voltage setting E1-01.

Drive Input Voltage	Stall Prevention Level during Deceleration
208 Vac Bypass Drives	377 Vdc
480 Vac Bypass Drives	754 Vdc

- Note:**
1. Do not use this setting in combination with a Dynamic Braking Resistor or other dynamic braking options. If Stall Prevention during deceleration is enabled, it will be triggered before the braking resistor option can operate.
 2. This method may lengthen the total deceleration time compared to the set value. If this is not appropriate for the application consider using a dynamic braking option.

Figure 5.45 illustrates the function of Stall Prevention during deceleration.

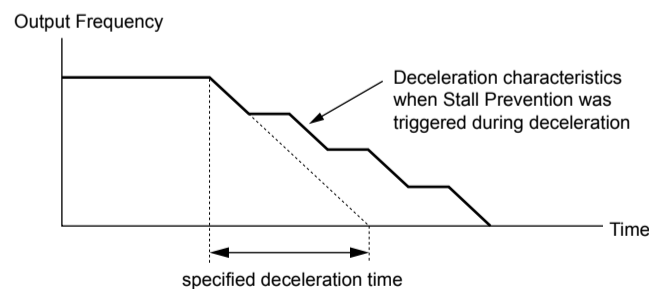

Figure 5.45 Stall Prevention During Deceleration

5.8 L: Protection Functions

Setting 2: Intelligent Stall Prevention

The drive adjusts the deceleration rate so the DC bus voltage is kept at the level set to parameter L3-17. This produces the shortest possible deceleration time while protecting the motor from stalling. The selected deceleration time is disregarded and the achievable deceleration time cannot be smaller than 1/10 of the set deceleration time.

This function uses the following parameters for adjusting the deceleration rate:

- DC bus voltage gain (L3-20)
- Deceleration rate calculations gain (L3-21)
- Inertia calculations for motor acceleration time (L3-24)
- Load inertia ratio (L3-25)

Note: The deceleration time is not constant. Do not use Intelligent Stall Prevention in applications where stopping accuracy is a concern. Use dynamic braking options instead.

Setting 3: StallP + Resistor

Setting 4: High Flux Brake

Setting 5: High Flux Brake 2

■ L3-06: Stall Prevention Level during Run

Sets the current level to trigger Stall Prevention during run. Depending on the setting of parameter L3-23, the level is automatically reduced in the constant power range (speed beyond base speed).

The Stall Prevention level can be adjusted using an analog input.

No.	Name	Setting Range	Default
L3-06	Stall Prevention Level During Run	30 to 120% ^{<1>}	120%

<1> The upper limit is determined by parameter L8-38, Carrier Frequency Derating Selection.

■ L3-11: Overvoltage Suppression Function Selection

Enables or disables the overvoltage suppression function.

No.	Name	Setting Range	Default
L3-11	Overvoltage Suppression Function Selection	0, 1	0

Setting 0: Disabled

The regenerative torque limit and the output frequency are not adjusted. A regenerative load may trip the drive with an overvoltage fault. Use this setting if dynamic braking options are installed.

Setting 1: Enabled

When the DC bus voltage rises due to regenerative load, an overvoltage fault is prevented by decreasing the regenerative torque limit and increasing the output frequency.

■ **L3-25: Load Inertia Ratio**

Determines the ratio between the rotor inertia and the load. Set this parameter when using Single Drive KEB 2 (L2-29 = 1¹), Intelligent Stall Prevention during deceleration (L3-04 = 2), or the overvoltage suppression function (L3-11 = 1).

No.	Name	Setting Range	Default
L3-25	Load Inertia Ratio	1.0 to 1000.0	1.0

When set incorrectly, a fairly large current ripple can result during Single Drive KEB 2 (L2-29 = 1¹). This may cause overvoltage suppression (L3-11 = 1) or other faults such as ov, Uv1, and oC.

Calculate parameter L3-25 in the formula below:

$$L3-25 = \frac{\text{Machine Inertia}}{\text{Motor Inertia}}$$

¹ Details on this function can be found in the standard P1000 Technical Manual (SIEPYAIP1U01) at www.yaskawa.com.

◆ **L4: Reference Detection**

These parameters set up the Loss of Frequency Reference function.

■ **L4-05: Frequency Reference Loss Detection Selection**

The drive can detect a loss of an analog frequency reference from input A1, A2, or A3. Frequency reference loss is detected when the frequency reference drops below 10% of the reference or below 5% of the maximum output frequency within 400 ms.

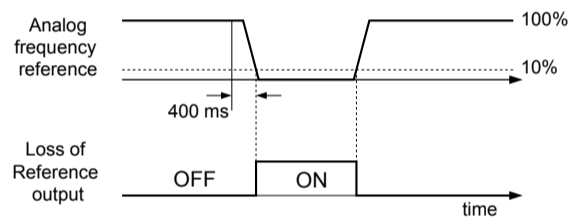

Figure 5.46 Loss of Reference Function

Parameter L4-05 selects the operation when a frequency reference loss is detected.

No.	Name	Setting Range	Default
L4-05	Frequency Reference Loss Detection Selection	0, 1	0

Setting 0: Stop

Drive follows the frequency reference (which is no longer present) and stops the motor.

Setting 1: Continue operation with reduced frequency reference

The drive will continue operation at the frequency reference value set to parameter L4-06. When the external frequency reference value is restored, the operation is continued with the frequency reference.

■ **L4-06: Frequency Reference at Reference Loss**

Sets the frequency reference level at which the drive runs when L4-05 = 1 and when detecting a reference loss. The value is set as a percentage of the frequency reference before the loss was detected.

No.	Name	Setting Range	Default
L4-06	Frequency Reference at Reference Loss	0.0 to 100.0%	80.0%

◆ **L5: Fault Restart**

After a fault has occurred, Fault Restart attempts to automatically restart the motor and continue operation instead of stopping.

5.8 L: Protection Functions

The drive can perform a self-diagnostic check and resume the operation after a fault has occurred. If the self-check is successful and the cause of the fault has disappeared, the drive restarts by first performing Speed Search (*Refer to b3: Speed Search on page 85* for details).

- Note:**
1. The wiring sequence should remove the Forward/Reverse command when a fault is triggered and output is shut off.
 2. When the Forward/Reverse command is removed, the drive can perform a self-diagnostic check and attempt to restart the fault automatically.

WARNING! Sudden Movement Hazard. Do not use the fault restart function in lifting applications. Fault restart may cause the machine to drop the load, which could result in death or serious injury.

The drive can attempt to restart itself following the faults listed below.

Fault	Name	Fault	Name
GF	Ground Fault	oL4	Overtorque 2
LF	Output Open Phase	ov	DC Bus Overvoltage
oC	Overcurrent	PF	Input Phase Loss
oH1	Drive Overheat	rH	Braking Resistor Fault
oL1	Motor Overload	rr	Braking Transistor Fault
oL2	Drive Overload	Uv1	DC Bus Undervoltage ^{<1>}
oL3	Overtorque 1	STo	Pull-Out Detection

<1> When L2-01 is set to 0 through 2 (continue operation during momentary power loss).

Use parameters L5-01 to L5-05 to set up automatic fault restart.

Set H2-01, H2-02, or H2-03 to 1E. to output a signal during fault restart ^{<1>}.

<1> Details on this function can be found in the standard P1000 Technical Manual (SIEPYAIP1U01) at www.yaskawa.com.

■ L5-01: Number of Auto Restart Attempts

Sets the number of times that the drive may attempt to restart itself.

Parameter L5-05 determines the method of incrementing the restart counter. When the counter reaches the number set to L5-01, the operation stops and the fault must be manually cleared and reset.

The restart counter is incremented at each restart attempt, regardless of whether the attempt was successful. When the counter reaches the number set to L5-01, the operation stops and the fault must be manually cleared and reset.

The number of fault restarts is reset to zero when:

- The drive operates normally for 10 minutes following a fault restart.
- A fault is cleared manually after protective functions are triggered.
- The power supply is cycled.

No.	Name	Setting Range	Default
L5-01	Number of Auto Restart Attempts	0 to 10 Times	0 Times

■ L5-02: Auto Restart Fault Output Operation Selection

Determines if a fault output is triggered (H2-□□ = E) when the drive attempts to restart.

No.	Name	Setting Range	Default
L5-02	Auto Restart Fault Output Operation Selection	0, 1	0

Setting 0: No Fault Output

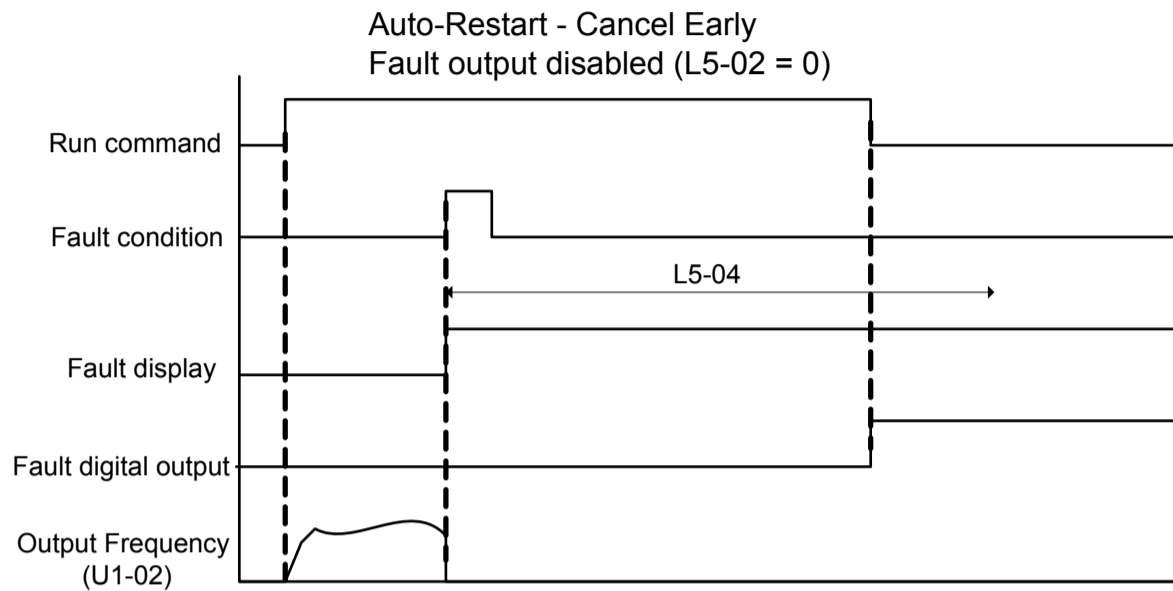

Figure 5.47 Auto Restart Cancel Early

Setting 1: Fault Output Is Set

■ L5-03: Time to Continue Making Fault Restarts (enabled only when L5-05 = 0)

Although the drive will continue to execute fault restarts, this parameter will cause a fault if a fault restart cannot occur after the time set to L5-03 passes.

All major faults will cause the drive to stop. For some faults it is possible to configure the drive to attempt a restart automatically. After the fault occurs, the drive baseblocks for L2-03 seconds. After the baseblock is removed, the drive checks if a fault condition still exists. If no fault condition exists, the drive will attempt to restart the motor. If the restart is successful, the drive performs a Speed Search (Regardless of the status of b3-01 "Speed Search Selection") from the set speed command and the Auto Restart Attempts count is increased by one. Even if the restart fails, the restart count is increased by one as long as the drive attempted to rotate the motor. The restart count will not be incremented if the restart is not attempted due to a continuing fault condition, (i.e., an ov fault). The drive waits L5-03 seconds before attempting another restart.

No.	Name	Setting Range	Default
L5-03	Time to Continue Making Fault Restarts	0.5 to 180.0 s	10.0 s

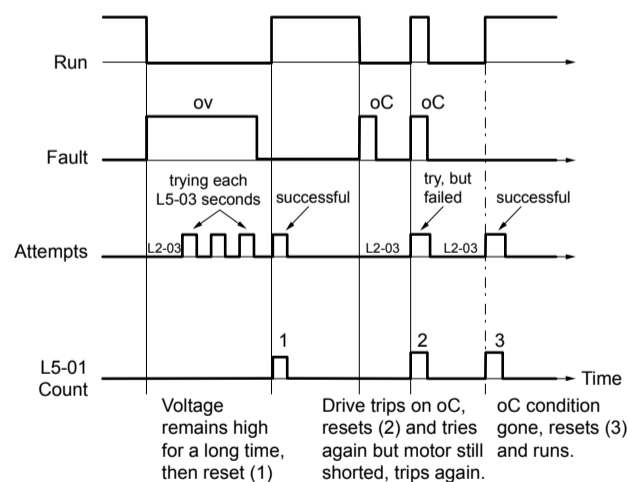

Figure 5.48 Automatic Restart Timing Diagram

The auto restart count is reset back to 0 if any of the following occur:

- No further faults for 10 minutes after the last retry.
- The drive power is turned off (the drive must be without power long enough to let control power dissipate).

5.8 L: Protection Functions

- The RESET key is pushed after the last reset attempt.

The setting of parameter L5-02 determines whether the fault output (MA-MB) will be closed during an auto restart attempt.

The setting of L5-02 can be important when using the drive with other equipment.

The following faults will allow the Auto Restart function to initiate:

- oC (Overcurrent)
- LF (Output Phase Loss)
- PF (Input Phase Loss)
- oL1 (Motor Overload)
- oL3 (Overtorque Detection 1)
- oL2 (Drive Overload)
- ov (Overvoltage)
- GF (Ground Fault)
- Uv1 (Undervoltage)
- oH1 (Heatsink Overheat)

In order for auto restart after a Uv1 fault, Momentary Power Loss Ride-thru must be enabled (L2-01= 1: “Power Loss Ride-thru Time”). Setting H2-01, H2-02 or H2-03 to 1E configures a digital output as “Restart Enabled” to signal if an impending auto restart is possible ^{<1>}.

^{<1>} Details on this function can be found in the standard P1000 Technical Manual (SIEPYAIP1U01) at www.yaskawa.com.

■ L5-04: Fault Reset Interval Time

Determines the amount of time to wait between restart attempts when parameter L5-05 is set to 1.

No.	Name	Setting Range	Default
L5-04	Fault Reset Interval Time	0.5 to 600.0 s	10.0 s

■ L5-05: Fault Reset Operation Selection

No.	Name	Setting Range	Default
L5-05	Fault Reset Operation Selection	0, 1	0

Setting 0: Count Successful Restarts

The drive will continuously attempt to restart. If it restarts successfully, the restart counter is increased. This operation is repeated each time a fault occurs until the counter reaches the value set to L5-01.

Setting 1: Count Restart Attempts

The drive will attempt to restart using the time interval set to parameter L5-04. A record is kept of the number of attempts to restart to the drive, regardless of whether those attempts were successful. When the number of attempted restarts exceeds the value set to L5-01, the drive stops attempting to restart.

◆ L6: Torque Detection

The drive provides two independent torque detection functions that trigger an alarm or fault signal when the load is too heavy (oL), or suddenly drops (UL). These functions are set up using the L6-□□ parameters. Program the digital outputs as shown below to indicate the underload or overload condition to an external device:

Note: When overtorque occurs in the application, the drive may stop due to overcurrent (oC) or overload (oL1). To prevent the drive from stopping, use torque detection to indicate an overload situation to the controller before oC or oL1 occur. Use undertorque detection to discover application problems like a torn belt, a pump shutting off, or other similar trouble.

H2-01, H2-02, H2-03 Setting ^{<1>} ^{<2>}	Description
B	Torque detection 1, N.O. (output closes when overload or underload is detected)
17	Torque detection 1, N.C. (output opens when overload or underload is detected)
18	Torque detection 2, N.O. (output closes when overload or underload is detected)
19	Torque detection 2, N.C. (output opens when overload or underload is detected)

^{<1>} Parameters H2-01, H2-02, and H2-03 are available in bypass controller software versions VST800298 and later.

^{<2>} Details on this function can be found in the standard P1000 Technical Manual (SIEPYAIP1U01) at www.yaskawa.com.

Figure 5.49 and Figure 5.50 illustrate the functions of overtorque and undertorque detection.

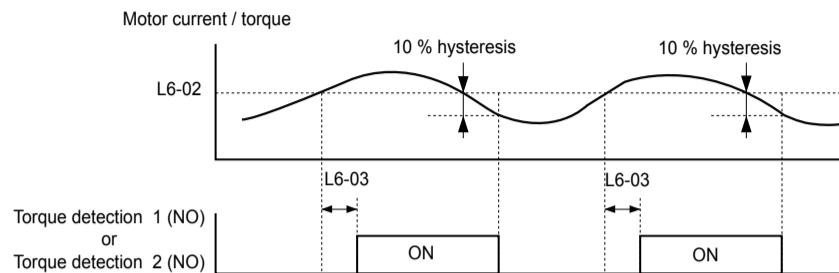

Figure 5.49 Overtorque Detection Operation

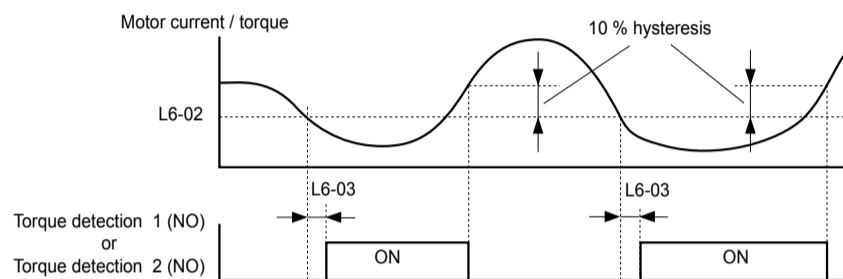

Figure 5.50 Undertorque Detection Operation

- Note:**
1. The torque detection function uses a hysteresis of 10% of the drive rated output current and motor rated torque.
 2. The level is set as a percentage of the drive rated output current.

■ L6-01: Torque Detection Selection 1

The torque detection function is triggered when the current or torque exceed the levels set to L6-02 for longer than the time set to L6-03. L6-01 selects the conditions for detection and the operation that follows.

Note: Parameter is available in bypass controller software versions VST800298 and later.

No.	Name	Setting Range	Default
L6-01	Torque Detection Selection 1	0 to 8	0

Setting 0: Disabled

Setting 1: oL3 at Speed Agree (Alarm)

Overtorque detection is active only when the output speed is equal to the frequency reference (i.e., no detection during acceleration and deceleration). The operation continues after detecting overtorque and triggering an oL3 alarm.

Setting 2: oL3 at Run (Alarm)

Overtorque detection works as long as the Run command is active. The operation continues after detecting overtorque and triggering an oL3 alarm.

Setting 3: oL3 at Speed Agree (Fault)

Overtorque detection is active only when the output speed is equal to the frequency reference (i.e., no detection during acceleration and deceleration). The operation stops and triggers an oL3 fault.

Setting 4: oL3 at Run (Fault)

Overtorque detection works as long as a Run command is active. The operation stops and triggers an oL3 fault.

Setting 5: UL3 at Speed Agree (Alarm)

Undertorque detection is active only when the output speed is equal to the frequency reference (i.e., no detection during acceleration and deceleration). The operation continues after detecting overtorque and triggering a UL3 alarm.

Setting 6: UL3 at Run (Alarm)

Undertorque detection works as long as the Run command is active. The operation continues after detecting overtorque and triggering a UL3 alarm.

5.8 L: Protection Functions

Setting 7: UL3 at Speed Agree (Fault)

Undertorque detection is active only when the output speed is equal to the frequency reference (i.e., no detection during acceleration and deceleration). The operation stops and triggers a UL3 fault.

Setting 8: UL3 at Run (Fault)

Undertorque detection works as long as a Run command is active. The operation stops and triggers a UL3 fault.

■ L6-02: Torque Detection Level 1

Sets the detection levels for torque detection function 1 as a percentage of the drive rated output current.

No.	Name	Setting Range	Default
L6-02	Torque Detection Level 1	0 to 300%	15%

Note: The torque detection level 1 (L6-02) can also be supplied by an analog input terminal set to H3-□□ = 7. Here, the analog value has priority and the setting in L6-02 is disregarded.

■ L6-03: Torque Detection Time 1

Determines the time required to trigger an alarm or fault after exceeding the level in L6-02.

No.	Name	Setting Range	Default
L6-03	Torque Detection Time 1	0.0 to 10.0 s	10.0 s

■ L6-13: Motor Underload Protection Selection

Sets Motor Underload Protection (UL6) based on motor load and determines whether the level of L6-02 refers to fbase or fmax.

Selects the operation of underload detection UL6. Underload is detected when the output current falls below the underload detection level defined by L6-14 and L2-02<1>.

<1> Details on this function can be found in the standard P1000 Technical Manual (SIEPYAIP1U01) at www.yaskawa.com.

No.	Name	Setting Range	Default
L6-13	Motor Underload Protection Selection	0, 1	0

Setting 0: Fbase Motor Load Enabled

Setting 1: Fmax Base Motor Load Enabled

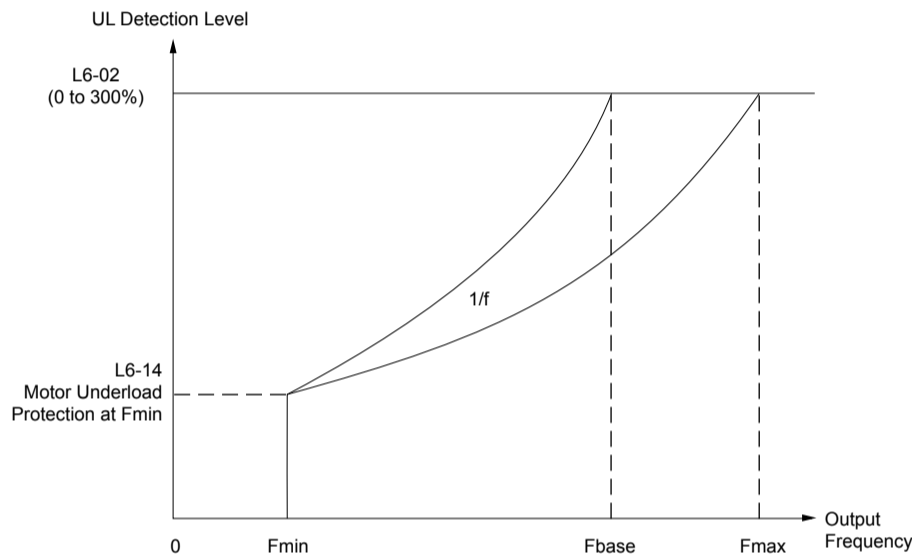

Figure 5.51 Motor Underload Protection

■ L6-14: Motor Underload Protection Level at Minimum Frequency

Sets the UL6 detection level at minimum frequency by percentage of drive rated current

No.	Name	Setting Range	Default
L6-14	Motor Underload Protection Level at Minimum Frequency	0 to 300%	15%

◆ L8: Drive Protection

■ L8-02: Overheat Alarm Level

Sets the overheat alarm (oH) detection level.

The drive outputs an alarm when the heatsink temperature exceeds the overheat alarm level. If the drive is set to continue operation after this alarm occurs (L8-03 = 4<1>) and the temperature reaches the overheat fault level, the drive will trigger an oH1 fault and stop operation.

<1> Details on this function can be found in the standard P1000 Technical Manual (SIEPYAIP1U01) at www.yaskawa.com.

When an output terminal is set for the oH pre-alarm (H2-□□ = 20), the switch will close when the heatsink temperature rises above L8-02.

No.	Name	Setting Range	Default
L8-02	Overheat Alarm Level	50 to 150 °C	Determined by o2-04

■ L8-05: Input Phase Loss Protection Selection

Enables or disables the input phase loss detection.

5.8 L: Protection Functions

No.	Name	Setting Range	Default
L8-05	Input Phase Loss Protection Selection	0, 1	1

Setting 0: Disabled

Setting 1: Enabled

Enables input phase loss detection. Since measuring the DC bus ripple detects input phase loss, a power supply voltage imbalance or main circuit capacitor deterioration may also trigger a phase loss fault (PF).

Detection is disabled if:

- The drive is decelerating.
- No Run command is active.
- Output current is less than or equal to 30% of the drive rated current.

■ L8-06: Input Phase Loss Detection Level

Sets the Input Phase Loss Detection (PF) Level.

Triggers PF fault when there is an imbalance larger than the value set to L8-06 in the drive input power voltage.

Detection Level = 100% = Voltage Class $\times \sqrt{2}$

No.	Name	Setting Range	Default
L8-06	Input Phase Loss Detection Level	0.0 to 50.0%	Determined by o2-04

■ L8-07: Output Phase Loss Protection Selection

Enables or disables the output phase loss detection triggered when the output current falls below 5% of the drive rated current.

Note: Output phase loss detection can mistakenly be triggered if the motor rated current is very small compared to the drive rating. Disable this parameter in such cases.

No.	Name	Setting Range	Default
L8-07	Output Phase Loss Protection Selection	0 to 2	1

Setting 0: Disabled

Setting 1: Fault when One Phase Is Lost

An output phase loss fault (LF) is triggered when one output phase is lost. The output shuts off and the motor coasts to stop.

Setting 2: Fault when Two Phases Are Lost

An output phase loss fault (LF) is triggered when two or more output phases are lost. The output shuts off and the motor coasts to stop.

■ L8-09: Output Ground Fault Detection Selection

Enables or disables the output ground fault detection.

No.	Name	Setting Range	Default
L8-09	Output Ground Fault Detection Selection	0, 1	Determined by o2-04

Setting 0: Disabled

Ground faults are not detected.

Setting 1: Enabled

A ground fault (GF) is triggered when high leakage current or a ground short circuit occurs in one or two output phases.

■ L8-38: Carrier Frequency Reduction Selection

Selects the operation of the carrier frequency reduction function. Reduces the carrier frequency when the output current exceeds a certain level. This temporarily increases the overload capability (oL2 detection), allowing the drive to run through transient load peaks without tripping.

No.	Name	Setting Range	Default
L8-38	Carrier Frequency Reduction Selection	0 to 2	Determined by o2-04

Setting 0: Disabled

No carrier frequency reduction at high current.

Setting 1: Enabled for Output Frequencies below 6 Hz

The carrier frequency is reduced at speeds below 6 Hz when the current exceeds 100% of the drive rated current. The drive returns to the normal carrier frequency when the current falls below 88% or the output frequency exceeds 7 Hz.

Setting 2: Enabled for Entire Frequency Range

The carrier frequency is reduced at the following speeds:

- Below 6 Hz when the current exceeds 100% of the drive rated current.
- Above 7 Hz when the current exceeds 112% of the drive rated current.

The drive uses the delay time set in parameter L8-40^{<1>} and a hysteresis of 12% when switching the carrier frequency back to the set value.

<1> Details on this function can be found in the standard P1000 Technical Manual (SIEPYAIP1U01) at www.yaskawa.com.

5.9 n: Special Adjustments

5.9 n: Special Adjustments

These parameters control a variety of specialized adjustments and functions, including Hunting Prevention and High Slip Braking.

◆ n1: Hunting Prevention

Hunting Prevention prevents the drive from hunting as a result of low inertia and operating with light load. Hunting often occurs with a high carrier frequency and an output frequency below 30 Hz.

■ n1-01: Hunting Prevention Selection

Enables or disables the Hunting Prevention function.

Note: This function is available only when using V/f Control. Disable Hunting Prevention when drive response is more important than suppressing motor oscillation. This function may be disabled without problems in applications with high inertia loads or relatively heavy loads.

No.	Name	Setting Range	Default
n1-01	Hunting Prevention Selection	0, 1	1

Setting 0: Disabled

Setting 1: Enabled

■ n1-02: Hunting Prevention Gain Setting

Sets the gain for the Hunting Prevention Function.

No.	Name	Setting Range	Default
n1-02	Hunting Prevention Gain Setting	0.00 to 2.50	1.00

Although this parameter rarely needs to be changed, it may require adjustment in the following situations:

- If the motor vibrates while lightly loaded and n1-01 = 1, increase the gain by 0.1 until vibration ceases.
- If the motor stalls while n1-01 = 1, decrease the gain by 0.1 until the stalling ceases.

◆ n3: High Slip Braking (HSB) and Overexcitation Braking

■ High Slip Braking (V/f)

HSB works in V/f Control only and decreases the stopping time compared to normal deceleration without using dynamic braking options. HSB reduces the output frequency in large steps to stop the motor and produce a high slip, which dissipates the regenerative energy created from decelerating the load in the motor windings. Due to the increased temperature of the motor windings, do not use HSB to frequently stop the motor. The duty cycle should be around 5% or lower.

Notes on Using High Slip Braking

- The set deceleration time is ignored during HSB. Use Overexcitation Deceleration 1 (L3-04 = 4) to stop the motor within a specified time.
- Braking time varies based on the load inertia and motor characteristics.
- Enabling HSB and KEB Ride-Thru simultaneously will trigger an oPE03 error.
- HSB must be triggered by a digital input set to H1-□□ = 68. After the HSB command is given, the drive will not restart until the motor is completely stopped and the Run command is cycled.
- Use parameters n3-01 through n3-04 to adjust HSB.

■ n3-04: High Slip Braking Overload Time

Sets the time required for an HSB overload fault (oL7) to occur when the drive output frequency does not change during an HSB stop due to excessive load inertia or the load rotating the motor. To protect the motor from overheat, the drive trips with an oL7 fault if these conditions last longer than the time set in n3-04.

No.	Name	Setting Range	Default
n3-04	High Slip Braking Overload Time	30 to 1200 s	40 s

■ n3-13: Overexcitation Deceleration Gain

Multiplies a gain to the V/f pattern output value during Overexcitation Deceleration to determine the level of overexcitation. The drive returns to the normal V/f value after the motor has stopped or when it is accelerating to the frequency reference.

No.	Name	Setting Range	Default
n3-13	Overexcitation Deceleration Gain	1.00 to 1.40	1.10

The optimum setting for n3-13 depends on the motor flux saturation characteristics.

- Gradually increase the gain to 1.25 or 1.30 to improve the braking power of Overexcitation Deceleration.
- Lower n3-13 when flux saturation characteristics cause overcurrent. A high setting sometimes causes overcurrent (oC), motor overload (oL1), or drive overload (oL2). Lowering n3-21 can also help remedy these problems.

5.10 o: Operator-Related Settings

5.10 o: Operator-Related Settings

These parameters control the various functions, features, and display of the HOA keypad.

◆ o1: HOA Keypad Display Selection

These parameters determine the data display on the HOA keypad.

■ o1-01: Drive Mode Unit Monitor Selection

The frequency reference display appears when the drive is powered up. Pressing the up arrow key will display the following data: frequency reference → rotational direction → output frequency → output current → o1-01 selection.

Parameter o1-01 selects the content of the last monitor in this sequence.

No.	Name	Setting Range	Default
o1-01	Drive Mode Unit Monitor Selection	104 to 699 U1-04 (Control Mode) to U6-99 (Option Monitors 20) </>	106 (U1-06)

<1> U2-□□ and U3-□□ parameters cannot be selected.

Note: Available for bypass control software versions VST800401 and later.

■ o1-02: User Monitor Selection after Power Up

Selects which monitor parameter is displayed upon power up by entering the 1- □□ part of U1-□□. Certain monitors are not available in some control modes. *Refer to U: Monitor Parameters on page 161* for a list of monitors.

No.	Name	Setting Range	Default
o1-02	User Monitor Selection after Power Up	1 to 5	1

Setting 1: Frequency Reference (U1-01)

Setting 2: Motor Direction

Setting 3: Output Frequency (U1-02)

Setting 4: Output Current (U1-03)

Setting 5: User Monitor

The monitor value selected by o1-01 will be displayed.

Note: Available for bypass control software versions VST800401 and later.

■ o1-03: HOA Keypad Display Selection

Sets the units used to display the frequency reference and output frequency. Set o1-03 to 3 for user-set units before setting parameters o1-10 and o1-11.

No.	Name	Setting Range	Default
o1-03	HOA Keypad Display Selection	0 to 3	0

Setting 0: 0.01 Hz Units

Setting 1: 0.01% Units (100% = Max Output Frequency)

Setting 2: r/min Units (Calculated by the Max Output Frequency and the Number of Motor Poles)

Setting 3: User-set Units (Use o1-10, o1-11)

Set the value used for the maximum frequency reference to o1-10. Set the placement of the decimal point in this number to o1-11.

For example, to have the maximum output frequency displayed as “100.00”, set o1-10 = 1000 and o1-11 = 2 (i.e., 1000 with 2 decimal points).

- Note:**
- Parameter o1-03 allows the programmer to change the units used in the following parameters and monitors:
U1-01: frequency reference
U1-02: output frequency
U1-16: output frequency after softstarter (accel/decel ramp generator)
d1-01 to d1-17: frequency references
 - Setting o1-03 to 2 requires entering the number of motor poles to E2-04 and E5-04.

5.10 o: Operator-Related Settings

o1-09: Frequency Reference Display Units

Selects the monitor that is shown in the third line. Enter the last three digits of the monitor parameter number to be displayed: U□-□□. For example, set "403" to display monitor parameter U4-03.

Note: Parameter is effective only when o1-06 is set to 1.

No.	Name	Setting Range	Default
o1-09	Frequency Reference Display Units	0 to 15; 24, 25	25

- Setting 0: Inch of Water (WC)
- Setting 1: Pounds per Square Inch (PSI)
- Setting 2: Gallons per Minute (GPM)
- Setting 3: Degrees Fahrenheit (F)
- Setting 4: Cubic Feet per Minute (CFM)
- Setting 5: Cubic Meters per Hour (CMH)
- Setting 6: Liters per Hour (LPH)
- Setting 7: Liters per Second (LPS)
- Setting 8: Bar (Bar)
- Setting 9: Pascals (Pa)
- Setting 10: Degrees Celsius (C)
- Setting 11: Meters (Mtr)
- Setting 12: Feet (Ft)
- Setting 13: Liters per Minute (LPN)
- Setting 14: Cubic Meters per Minute (CMM)
- Setting 15: Inches of Mercury (Hg)
- Setting 24: Custom Units (determined by o1-13 to o1-15)
- Setting 25: No unit

5.10 o: Operator-Related Settings

■ o1-10: User-Set Display Units Maximum Value

Determines the display value that is equal to the maximum output frequency.

No.	Name	Setting Range	Default
o1-10	User-Set Display Units Maximum Value	1 to 60000	Determined by o1-03

■ o1-11: User-Set Display Units Decimal Display

Determines how many decimal points should be used to set and display the frequency reference.

No.	Name	Setting Range	Default
o1-11	User-Set Display Units Decimal Display	0 to 3	Determined by o1-03

Setting 0: No Decimal Point

Setting 1: One Decimal Point

Setting 2: Two Decimal Points

Setting 3: Three Decimal Points

◆ o2: HOA Keypad Functions

These parameters determine the functions assigned to the operator keys.

■ o2-04: Drive Model Selection

Set this parameter when replacing the control board or the terminal board. *Refer to Defaults by Drive Model on page 298* for information on drive model selection.

NOTICE: Drive performance will suffer and protective functions will not operate properly if the correct drive capacity is not set to o2-04.

No.	Name	Setting Range	Default
o2-04	Drive Model Selection	-	Determined by drive capacity

Note: Change o2-04 setting only when necessary.

◆ o4: Maintenance Monitor Settings

■ o4-03: Cooling Fan Operation Time Setting

Sets the value for how long the cooling fan has been operating. This value can be viewed in monitor U4-03. Parameter o4-03 also sets the base value used for the cooling fan maintenance, which is displayed in U4-04. Reset this parameter to 0 after replacing the cooling fan.

- Note:**
1. The value in o4-03 increases after every 10 hours of use. A setting of 30 will set the cooling fan operation time counter to 300 h. "300" will be displayed in monitor U4-03.
 2. The cooling fan may require maintenance at an earlier date in harsher environments.

No.	Name	Setting Range	Default
o4-03	Cooling Fan Operation Time Setting	0 to 9999 h	0 h

■ o4-11: U2-□□, U3-□□, and UB-09 to UB-16 Initialization

Resets the drive and bypass fault trace and fault history monitors.

- Note:**
1. Parameter is available in bypass controller software versions VST800298 and later.
 2. Initializing the drive using A1-03 does not reset these monitors.

No.	Name	Setting Range	Default
o4-11	U2, U3, and UB-09 to UB-16 Initialization	0, 1	0

Setting 0: No Action

The drive and bypass keep the previously saved record concerning fault trace and fault history.

5.10 o: Operator-Related Settings

Setting 1: Reset Fault Data

Resets the data for the U2-□□, U3-□□, and UB-09 to UB-16 monitors. Setting o4-11 to 1 and pressing the ENTER key erases fault data in the bypass and drive and returns the display to 0.

5.11 S: Special Parameters

5.11 S: Special Parameters

◆ S1: Dynamic Audible Noise Control Function

The Dynamic Audible Noise Control Function reduces audible noise by suppressing the output voltage.

This function is available when using V/f Control mode and can help to quickly restore output voltage after an impact has caused a sudden increase in the time constant. Dynamic Audible Noise Control is useful in applications where load impact is common.

Procedure

1. Set S1-01 to 1 to enable Dynamic Audible Noise Control.

Note: 1. When S1-01 is set to 1, the tolerance to impact loading is reduced when compared to V/f Control (without Energy Saving).

2. Disable Dynamic Audible Noise Control for applications without an impact load.

2. Responsiveness is increased because the addition of a load causes the level of the current to rise.

Increase the value of S1-02. The flux will become stronger and the torque will rise, but load movement will be minimized by the Dynamic Audible Noise Control function.

Set S1-03 and S1-04 to a small value. Voltage is recovered quicker during impact load conditions. Under certain conditions voltage stability may become poor.

Lower the value of S1-05. The voltage level will drop and speed up voltage restoration when the load is increased.

3. Increase the value of S1-03 to increase the effectiveness of Dynamic Audible Noise Control if the output voltage remains high.

4. Decrease the value of S1-06 to increase drive response to an impact load.

5. When the output voltage is unstable, increase the difference between S1-03 and S1-04 and increase S1-05 and S1-06 to slow the load response.

■ S1-01: Dynamic Audible Noise Control Selection

Reduces audible noise by decreasing the output voltage in variable torque applications with light loads.

No.	Name	Setting Range	Default
S1-01	Dynamic Audible Noise Control Selection	0 or 1	0

Setting 0: Disabled

Setting 1: Enabled

■ S1-02: Voltage Reduction Rate

Sets the rate at which the output voltage will be reduced as a percentage of the V/f pattern when operating with no load.

No.	Name	Setting Range	Default
S1-02	Voltage Reduction Rate	50.0 to 100.0%	50.0%

■ S1-03: Voltage Restoration Level

Sets the level when the drive should start restoring the voltage as a percentage of the drive rated torque.

The voltage is reduced when the torque output has decreased to the level set in S1-03.

The method used to reduce the voltage level is selected in accordance with the characteristics of the voltage reduction rate defined by the S1-03 and S1-04 settings.

Note: Setting S1-04 to a value less than that of S1-03 + 10.0 will trigger an oPE02 error.

No.	Name	Setting Range	Default
S1-03	Voltage Restoration Level	0.0 to 90.0%	20.0%

■ S1-04: Voltage Restoration Complete Level

Sets the level at which voltage restoration for the V/f pattern is complete as a percentage of the drive rated torque. If the output torque rises above the value of S1-04, then the voltage will be controlled in a manner specified by the V/f pattern setting.

Note: Setting S1-04 to a value less than that of S1-03 + 10.0 will trigger an oPE02 error.

No.	Name	Setting Range	Default
S1-04	Voltage Restoration Complete Level	S1-03 + 10.0 to 100.0%	50.0%

■ S1-05: Voltage Restoration Sensitivity Time Constant

Sets the level of sensitivity of the output torque as well as that of the LPF time constant for the voltage reduction rate. The level of sensitivity can be adjusted in accordance with the load response.

The LPF time constant is used to calculate the value of the output torque sensitivity time constant.

The voltage reduction rate is based on the torque output. Select LPF to prevent voltage fluctuation.

The Dynamic Audible Noise Control Function outputs the rate of voltage reduction as a percentage within the allowable range (Max: 100%, Min: S1-02 value).

No.	Name	Setting Range	Default
S1-05	Voltage Restoration Sensitivity Time Constant	0.000 to 3.000 s	1.000 s

■ S1-06: Voltage Restoration Time Constant at Impact

Sets the voltage restoration time constant if an impact load is added.

Sets the time constant that enables the voltage level to rise if the speed suddenly changes upon impact.

No.	Name	Setting Range	Default
S1-06	Voltage Restoration Time Constant at Impact	0.000 to 1.000 s	0.050 s

◆ S2: Sequence Timers

■ Programmable Run Timers for Real Time Clock (RTC)

Programmable run timers allow the drive to start and stop automatically at specified times. The timers can be configured to run daily, on weekdays, on weekends, or only on specific days of the week.

Sequence Timer 1

When the current time reaches the value set in parameter S2-01 (Sequence Timer 1 Start Time), the drive will execute the action set in parameter S2-04 (Sequence Timer 1 Selection), provided the current day is selected via S2-03 (Sequence Timer 1 Day Selection). The drive will stop executing the S2-04 action when the S2-02 (Sequence Timer 1 Stop Time) is reached.

When S2-04 = 0 or the Disable Sequence Timers multi-function input (H1-□□ = 50) is closed, Sequence Timer 1 has no effect on the drive Run command. The drive runs normally based on the status of the selected run source (b1-02). If S2-04 = 1 or 2 and the Disable Sequence Timers input is open, the drive will run during the Sequence Timer 1 active time, provided the drive has a valid Run command. The frequency reference that is used is set by S2-05 (Sequence Timer 1 Reference Source). When S2-04 = 2, PI control is disabled.

If the Cancel Active Sequence Timer multi-function input (H1-□□ = 51) transitions from open to closed while Sequence Timer 1 is active, the timer will be disabled until the next scheduled sequence timer occurrence. Sequence Timer 1 can be re-enabled by cycling the drive Run command. The Sequence Timer 1 multi-function output (H2-□□ = 50^{<1>}) will close while Sequence Timer 1 is active regardless of the S2-04 selection.

When S2-01 = S2-02, Sequence Timer 1 is active continuously for the days selected in S2-03. The timer will start at the S2-01/S2-02 time on the first day and stop at the same time on the last day. If only one day is selected in S2-03, the timer will stop at 24:00 on that day.

When S2-04 = 1 or 2, Sequence Timer 1 is active and the drive is running, the HOA Keypad will display “Sequence Timer 1 RUN”. When the drive has a run command, S2-04 = 1 or 2 and Sequence Timer 1 is not active, the HOA Keypad will display “Sequence Timer OFF”.

When the drive has a run command, S2-04 = 1 or 2 and Sequence Timer 1 is not active, the drive should not fault on undervoltage or overvoltage conditions (should be Alarm only).

<1> Details on this function can be found in the standard P1000 Technical Manual (SIEPYAIP1U01) at www.yaskawa.com.

5.11 S: Special Parameters

Sequence Timers 2 to 4

These timers operate identically to Sequence Timer 1. Parameters S2-06 to S2-20 configure Sequence Timers 2 to 4.

Priority

If multiple sequence timers overlap, the timer with the lowest number has priority.

Sequence Timer 1 = highest priority

Sequence Timer 4 = lowest priority

■ S2-01/S2-06/S2-11/S2-16: Sequence Timers 1 to 4 Start Time

Sets the start times for timers 1 to 4.

If the Stop Time is set to a higher value than the Start Time, the Sequence Timers will be active starting from the set Start Time, run through midnight, and stop the following day at the set Stop Time.

Note: Setting the sequence timer start time to a higher value than the sequence timer stop time disables that sequence timer in drive software versions PRG: 8551 and earlier.

No.	Name	Setting Range	Default
S2-01	Sequence Timer 1 Start Time	12:00AM to 11:59PM </>	12:00AM </>
S2-06	Sequence Timer 2 Start Time	12:00AM to 11:59PM </>	12:00AM </>
S2-11	Sequence Timer 3 Start Time	12:00AM to 11:59PM </>	12:00AM </>
S2-16	Sequence Timer 4 Start Time	12:00AM to 11:59PM </>	12:00AM </>

<1> Default is 00:00 and range is 00:00 to 24:00 when o4-20 is set to 1 (24-hour).

■ S2-02/S2-07/S2-12/S2-17: Sequence Timers 1 to 4 Stop Time

Sets the stop times for timers 1 to 4. The values must be set greater than or equal to S2-01/S2-06/S2-11/S2-16.

No.	Name	Setting Range	Default
S2-02	Sequence Timer 1 Stop Time	00:00 to 24:00	00:00
S2-07	Sequence Timer 2 Stop Time	00:00 to 24:00	00:00
S2-12	Sequence Timer 3 Stop Time	00:00 to 24:00	00:00
S2-17	Sequence Timer 4 Stop Time	00:00 to 24:00	00:00

■ S2-03/S2-08/S2-13/S2-18: Sequence Timers 1 to 4 Day Selection

Sets the days for which sequence timers 1 to 4 are active.

No.	Name	Setting Range	Default
S2-03	Sequence Timer 1 Day Selection	0 to 10	0
S2-08	Sequence Timer 2 Day Selection	0 to 10	0
S2-13	Sequence Timer 3 Day Selection	0 to 10	0
S2-18	Sequence Timer 4 Day Selection	0 to 10	0

Setting 0: Timer Disabled**Setting 1: Daily****Setting 2: Mon - Fri****Setting 3: Sat - Sun****Setting 4: Monday****Setting 5: Tuesday****Setting 6: Wednesday****Setting 7: Thursday****Setting 8: Friday****Setting 9: Saturday****Setting 10: Sunday****■ S2-04/S2-09/S2-14/S2-19: Sequence Timers 1/2/3/4 Selection**

Sets the action that occurs when sequence timers 1 to 4 are active.

- Note:**
1. Setting 3 is available in drive software versions PRG: 8552 and later.
 2. Setting 3 is not available in drive models 4A0930 and 4A1200.

No.	Name	Setting Range	Default
S2-04	Sequence Timer 1 Selection	0 to 3	0
S2-09	Sequence Timer 2 Selection	0 to 3	0
S2-14	Sequence Timer 3 Selection	0 to 3	0
S2-19	Sequence Timer 4 Selection	0 to 3	0

Setting 0: Digital Output Only**Setting 1: Run****Setting 2: Run - PI Disable****Setting 3: Allow Alternation**

When Sequence Selection is set to Allow Alternation and that timer is enabled (S2-03, S2-08, S2-13, S2-18 > 0), the drive will only allow MEMOBUS alternation to occur during the time specified in the corresponding Sequence Timer. Alternation is disabled when the timer deactivates.

■ S2-05/S2-10/S2-15/S2-20: Sequence Timers 1/2/3/4 Reference Source

Selects the frequency reference source used for running the drive when sequence timers 1 to 4 are active (only applicable when S2-04/S2-09/S2-14/S2-19 are set to 1 or 2).

No.	Name	Setting Range	Default
S2-05	Sequence Timer 1 Reference Source	0 to 5; 7	0
S2-10	Sequence Timer 2 Reference Source	0 to 5; 7	0
S2-15	Sequence Timer 3 Reference Source	0 to 5; 7	0
S2-20	Sequence Timer 4 Reference Source	0 to 5; 7	0

Setting 0: Operator (d1-01)**Setting 1: Operator (d1-02)****Setting 2: Operator (d1-03)****Setting 3: Operator (d1-04)****Setting 4: Terminals****Setting 5: Serial Communication****Setting 7: Pulse Input****◆ Examples of Sequence Timers****■ Sequence Timer Example 1**

Set the parameters as shown in *Table 5.25* to accomplish the timer sequencing in *Figure 5.52*.

5.11 S: Special Parameters

Table 5.25 Sequence Timer Example 1 Parameter Settings

No.	Name	Setting	Comment
S2-01	Sequence Timer 1 Start Time	05:00	
S2-02	Sequence Timer 1 Stop Time	15:00	
S2-03	Sequence Timer 1 Day Selection	2	Mon to Fri
S2-04	Sequence Timer 1 Selection	1	Run
S2-05	Sequence Timer 1 Reference Source	0	Operator (d1-01)
S2-06	Sequence Timer 2 Start Time	19:00	
S2-07	Sequence Timer 2 Stop Time	22:00	
S2-08	Sequence Timer 2 Day Selection	2	Mon to Fri
S2-09	Sequence Timer 2 Selection	2	Run PI Disable
S2-10	Sequence Timer 2 Reference Source	1	Operator (d1-02)
S2-11	Sequence Timer 3 Start Time	06:00	
S2-12	Sequence Timer 3 Stop Time	14:00	
S2-13	Sequence Timer 3 Day Selection	3	Sat to Sun
S2-14	Sequence Timer 3 Selection	1	Run
S2-15	Sequence Timer 3 Reference Source	2	Operator (d1-03)
S2-16	Sequence Timer 4 Start Time	17:00	
S2-17	Sequence Timer 4 Stop Time	21:00	
S2-18	Sequence Timer 4 Day Selection	10	Sun
S2-19	Sequence Timer 4 Selection	0	Digital Output Only
S2-20	Sequence Timer 4 Reference Source	0	n/a

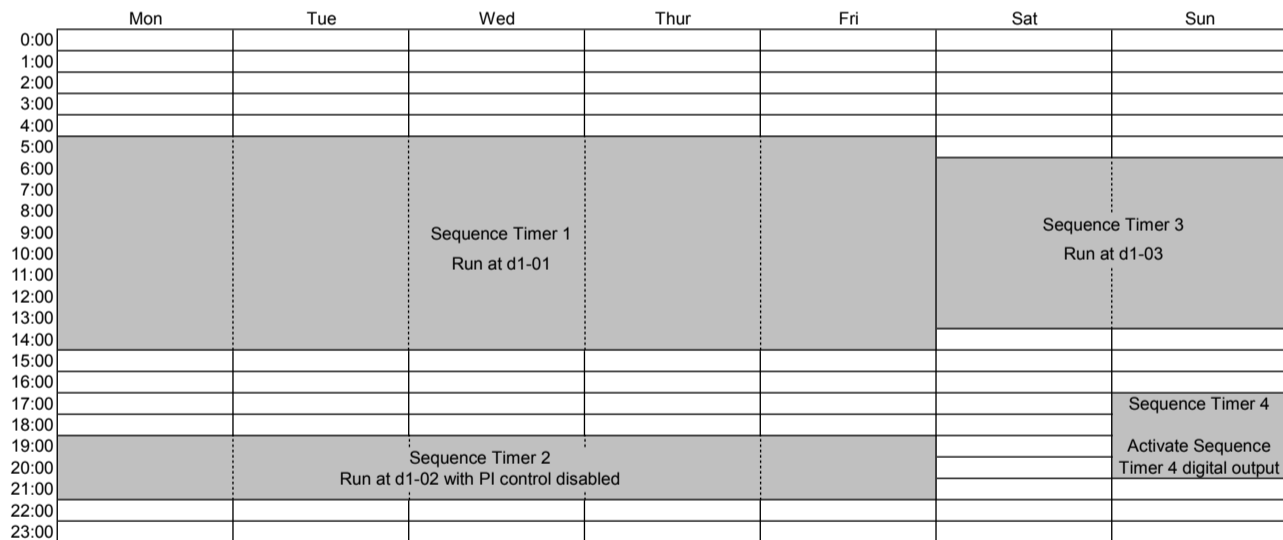

Figure 5.52 Sequence Timer Example 1

■ Sequence Timer Example 2

Set the parameters as shown in **Table 5.26** to accomplish the timer sequencing in **Figure 5.53**.

Table 5.26 Sequence Timer Example 2 Parameter Settings

No.	Name	Setting	Comment
S2-01	Sequence Timer 1 Start Time	00:00	
S2-02	Sequence Timer 1 Stop Time	24:00	
S2-03	Sequence Timer 1 Day Selection	2	Mon to Fri
S2-04	Sequence Timer 1 Selection	1	Run
S2-05	Sequence Timer 1 Reference Source	0	Operator (d1-01)
S2-06	Sequence Timer 2 Start Time	06:00	

5.11 S: Special Parameters

No.	Name	Setting	Comment
S2-07	Sequence Timer 2 Stop Time	06:00	
S2-08	Sequence Timer 2 Day Selection	3	Sat to Sun
S2-09	Sequence Timer 2 Selection	1	Run
S2-10	Sequence Timer 2 Reference Source	2	Operator (d1-03)
S2-11	Sequence Timer 3 Start Time	0:00	n/a
S2-12	Sequence Timer 3 Stop Time	0:00	n/a
S2-13	Sequence Timer 3 Day Selection	0	Timer Disabled
S2-14	Sequence Timer 3 Selection	0	n/a
S2-15	Sequence Timer 3 Reference Source	0	n/a
S2-16	Sequence Timer 4 Start Time	00:00	n/a
S2-17	Sequence Timer 4 Stop Time	00:00	n/a
S2-18	Sequence Timer 4 Day Selection	0	Timer Disabled
S2-19	Sequence Timer 4 Selection	0	n/a
S2-20	Sequence Timer 4 Reference Source	0	n/a

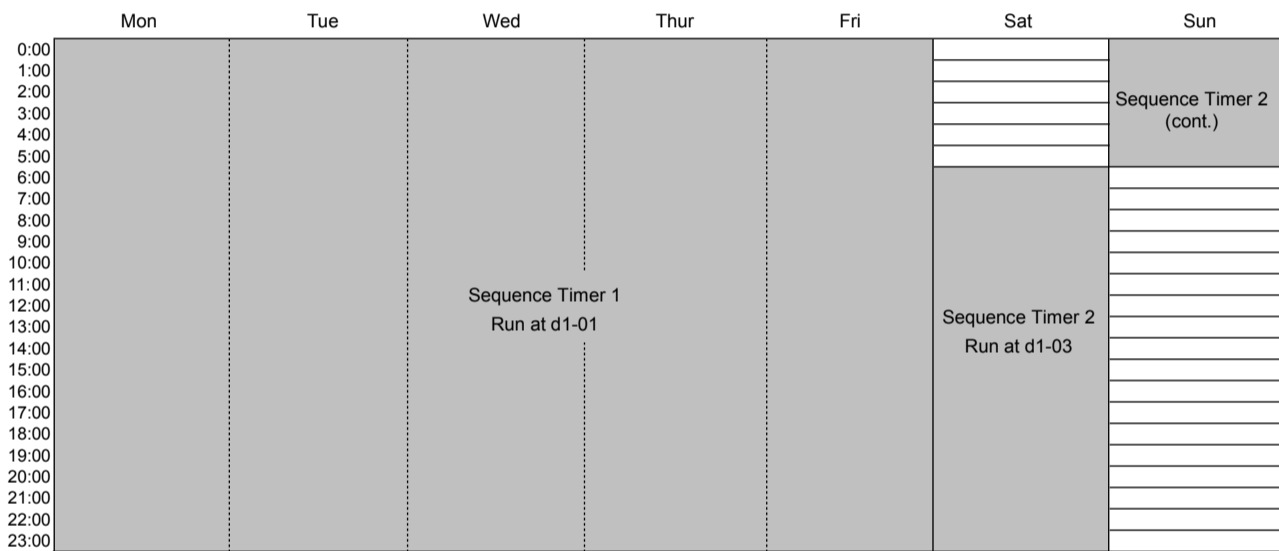

Figure 5.53 Sequence Timer Example 2

■ Sequence Timer Example 3

Set the parameters as shown in **Table 5.27** to accomplish the timer sequencing in **Figure 5.54**.

Table 5.27 Sequence Timer Example 3 Parameter Settings

No.	Name	Setting	Comment
S2-01	Sequence Timer 1 Start Time	05:00	
S2-02	Sequence Timer 1 Stop Time	15:00	
S2-03	Sequence Timer 1 Day Selection	2	Mon to Fri
S2-04	Sequence Timer 1 Selection	1	Run
S2-05	Sequence Timer 1 Reference Source	0	Operator (d1-01)
S2-06	Sequence Timer 2 Start Time	15:00	
S2-07	Sequence Timer 2 Stop Time	22:00	
S2-08	Sequence Timer 2 Day Selection	2	Mon to Fri
S2-09	Sequence Timer 2 Selection	2	Run PI Disable
S2-10	Sequence Timer 2 Reference Source	1	Operator (d1-02)
S2-11	Sequence Timer 3 Start Time	09:00	
S2-12	Sequence Timer 3 Stop Time	24:00	
S2-13	Sequence Timer 3 Day Selection	9	Sat

5.11 S: Special Parameters

No.	Name	Setting	Comment
S2-14	Sequence Timer 3 Selection	1	Run
S2-15	Sequence Timer 3 Reference Source	2	Operator (d1-03)
S2-16	Sequence Timer 4 Start Time	0:00	n/a
S2-17	Sequence Timer 4 Stop Time	0:00	n/a
S2-18	Sequence Timer 4 Day Selection	0	Timer Disabled
S2-19	Sequence Timer 4 Selection	0	n/a
S2-20	Sequence Timer 4 Reference Source	0	n/a

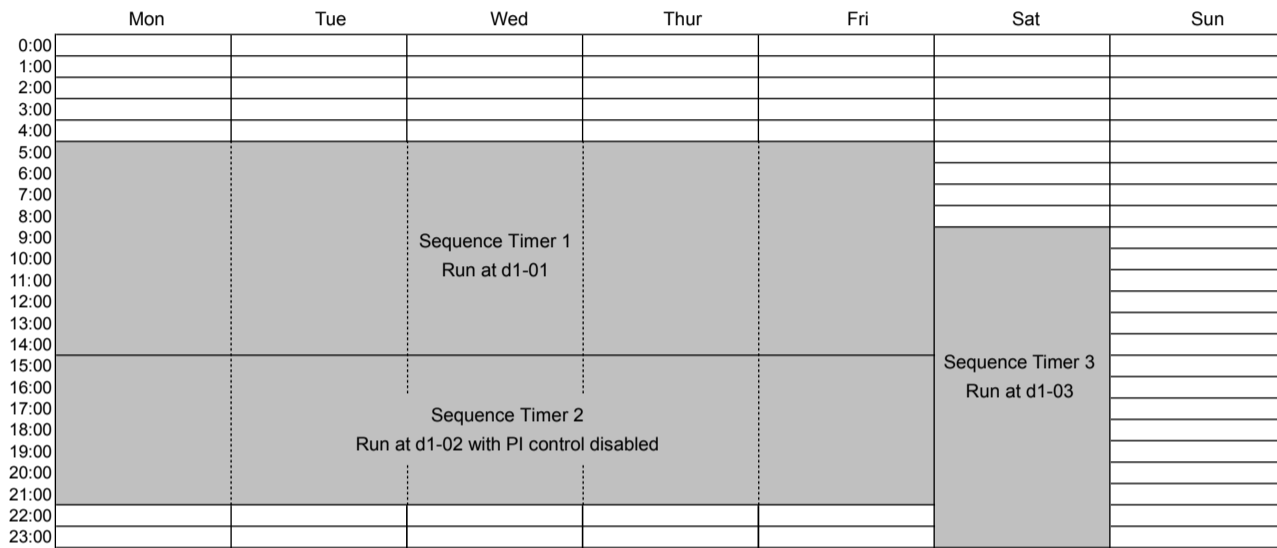

Figure 5.54 Sequence Timer Example 3

◆ T: Motor Tuning

Auto-Tuning automatically sets and tunes parameters required for optimal motor performance.

Refer to Auto-Tuning on page 76 for details on Auto-Tuning parameters.

5.12 U: Monitor Parameters

Monitor parameters let the user view various aspects of drive performance using the HOA keypad display. Some monitors can be output from terminals FM and AM by assigning the specific monitor parameter number (U□-□□) to H4-01 and H4-04. *Refer to H4-01, H4-04: Multi-Function Analog Output Terminal FM, AM Monitor Selection on page 131* for details on assigning functions to an analog output.

◆ UB: Bypass Monitors

These monitors display various aspects of bypass control. *Refer to UB: Bypass Control Monitors on page 280* for a complete list of UB-□□ monitors and descriptions.

◆ U1: Operation Status Monitors

Status monitors display drive status data such as output frequency and output current. *Refer to U1: Operation Status Monitors on page 282* for a complete list of U1-□□ monitors and descriptions.

◆ U2: Fault Trace

Use these monitor parameters to view the status of various drive aspects when a fault occurs.

This information is helpful for determining the cause of a fault. *Refer to U2: Fault Trace on page 283* for a complete list of U2-□□ monitors and descriptions.

U2-□□ monitors are not reset when the drive is initialized.

Note: Fault histories are not kept when CPF00, CPF01, CPF06, CPF24, oFA00, oFb00, oFC00, Uv1, Uv2, or Uv3 occur.

◆ U3: Fault History

These parameters display faults that have occurred during operation as well as the drive operation time when those faults occurred. *Refer to U3: Fault History on page 284* for a complete list of U3-□□ monitors and descriptions.

U3-□□ monitors are not reset when the drive is initialized.

Note: Fault histories are not kept when CPF00, CPF01, CPF06, CPF24, oFA00, oFb00, oFC00, Uv1, Uv2, or Uv3 occur.

◆ U4: Maintenance Monitors

Maintenance monitors show:

- Runtime data of the drive and cooling fans and number of Run commands issued
- Maintenance data and replacement information for various drive components
- kWh data
- Highest peak current that has occurred and output frequency at the time the peak current occurred
- Motor overload status information
- Detailed information about the present Run command and frequency reference source selection

Refer to U4: Maintenance Monitors on page 285 for a complete list of U4-□□ monitors and descriptions.

◆ U5: PID Monitors

These monitors display various aspects of PID control. *Refer to PID Block Diagram on page 93* for details on how these monitors display PID data.

Refer to U5: PID Monitors on page 287 for a complete list of U5-□□ monitors and descriptions.

5.13 Z: Bypass Parameters

5.13 Z: Bypass Parameters

Z parameters control bypass-specific functions.

◆ Z1: Bypass Control System

■ Z1-01: Initialize

Sets parameters to default values.

No.	Name	Setting Range	Default
Z1-01	Initialize	0 to 3; 8008 to 8011	0

Setting 0: No Initialize

Setting 1: Set all parameters to default values

Setting 2: Set only Bypass Controller parameters to default values

Setting 3: Set only Drive Controller parameters to default values

Setting 8008: Pump

Application Preset for pump applications. *Refer to Application Selection on page 75* for a list of parameters and default values for this Application Preset.

Setting 8009: Pump w/ PI

Application Preset for pump applications. *Refer to Application Selection on page 75* for a list of parameters and default values for this Application Preset.

Setting 8010: Fan

Application Preset for pump applications. *Refer to Application Selection on page 75* for a list of parameters and default values for this Application Preset.

Setting 8011: Fan w/ PI

Application Preset for pump applications. *Refer to Application Selection on page 75* for a list of parameters and default values for this Application Preset.

■ Z1-02: Password

Allows and restricts access to all parameters. Setting this value equal to the value in Z1-03 toggles access to all parameter settings, except Z1-02. If the value entered to Z1-02 matches the value entered to Z1-03, the access to all parameters is denied or granted.

No.	Name	Setting Range	Default
Z1-02	Password	–	–

■ Z1-03: Password Change

The value entered to this parameter is the password.

No.	Name	Setting Range	Default
Z1-03	Password Change	0 to 9999	0

■ Z1-05: Auto Transfer to Bypass Upon Drive Fault

Switches operation to Bypass mode when the drive is running and a drive fault occurs. When the fault is cleared, operation will switch back to Drive mode

No.	Name	Setting Range	Default
Z1-05	Auto Transfer to Bypass Upon Drive Fault	0, 1	0

Setting 0: Disable

Setting 1: Enable

Z1-06: Power-Up Mode

Determines the mode of the Bypass Control upon power-up.

No.	Name	Setting Range	Default
Z1-06	Power-Up Mode	0 to 4	0

Setting 0: OFF

When drive powers up, it will be in “OFF” mode and will need an “AUTO” or “HAND” command to run.

Setting 1: AUTO-DRIVE

When drive powers up, the drive will get an “AUTO” command and needs an “OFF” command to stop.

Setting 2: HAND-DRIVE

When drive powers up, the drive will get a "HAND" command and needs an “OFF” command to stop.

Setting 3: AUTO-BYPASS

When drive powers up, the bypass will get an “AUTO” command and needs an “OFF” command to stop.

Setting 4: HAND-BYPASS

When drive powers up, the bypass will get a "HAND" command and needs an “OFF” command to stop.

Z1-07: Speed Reference Select

Selects the frequency reference source 1.

- Note:**
1. Default is 1 in bypass controller software versions VST800298 and later. Default is 0 in bypass controller software versions VST800297 and earlier.
 2. If a Run command is input to the drive, but the frequency reference entered is 0 or below the minimum frequency, the AUTO or HAND indicator LED on the HOA keypad will light and the OFF indicator will flash.

No.	Name	Setting Range	Default
Z1-07	Speed Reference Select	0 to 3	1

Setting 0: HOA Keypad

Using this setting, the frequency reference can be input by:

- switching between the multi-speed references from d1-01 to d1-04.
- entering the frequency reference on the operator keypad.

Setting 1: Terminals (analog input terminals)

Using this setting, an analog frequency reference can be entered as a voltage or current signal from terminals A1, A2, or A3.

Voltage Input

Voltage input can be used at any of the three analog input terminals. Make the settings as described in **Table 5.28** for the input used.

Table 5.28 Analog Input Settings for Frequency Reference Using Voltage Signals

Terminal	Signal Level	Parameter Settings				Notes
		Signal Level Selection	Function Selection	Gain	Bias	
A1	0 to 10 Vdc	H3-01 = 0	H3-02 = 0 (Frequency Reference Bias)	H3-03	H3-04	-
	-10 to +10 Vdc	H3-01 = 1				
A2	0 to 10 Vdc	H3-09 = 0	H3-10 = 0 (Frequency Reference Bias)	H3-11	H3-12	Set jumper S1 on the terminal board to “V” for voltage input.
	-10 to +10 Vdc	H3-09 = 1				
A3	0 to 10 Vdc	H3-05 = 0	H3-06 = 0 (Frequency Reference Bias)	H3-07	H3-08	Set DIP switch S4 on the terminal board to “AI”.
	-10 to +10 Vdc	H3-05 = 1				

5.13 Z: Bypass Parameters

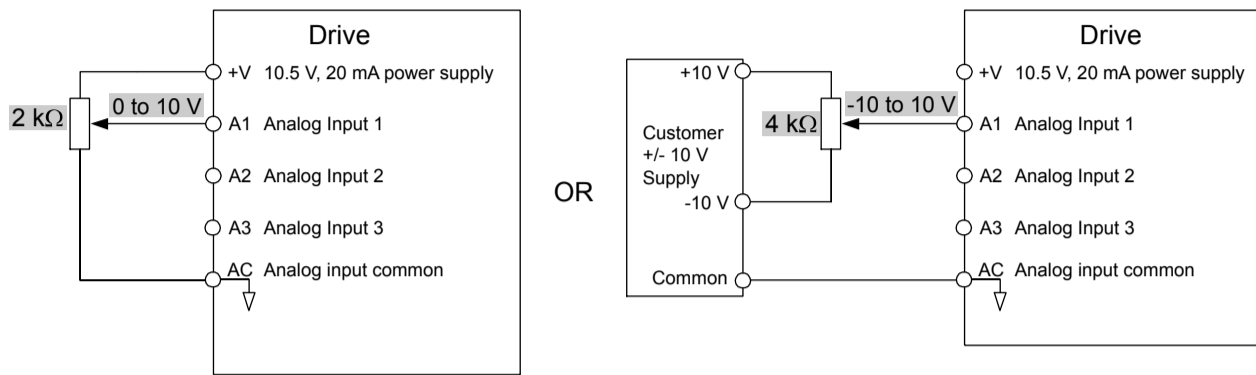

Figure 5.55 Setting the Frequency Reference as a Voltage Signal at Terminal A1

Current Input

Input terminals, A1, A2, and A3 can accept a current input signal.

Table 5.29 Analog Input Settings for Frequency Reference Using a Current Signal

Terminal	Signal Level	Parameter Settings				Notes
		Signal Level Selection	Function Selection	Gain	Bias	
A1	4 to 20 mA	H3-01 = 2	H3-02 = 0 (Frequency Reference Bias)	H3-03	H3-04	Set jumper S1 on the terminal board to "I" for current input.
	0 to 20 mA	H3-01 = 3				
A2	4 to 20 mA	H3-09 = 2	H3-10 = 0 (Frequency Bias)	H3-11	H3-12	
	0 to 20 mA	H3-09 = 3				
A3	4 to 20 mA	H3-05 = 2	H3-06 = 0 (Frequency Reference Bias)	H3-07	H3-08	
	0 to 20 mA	H3-05 = 3				

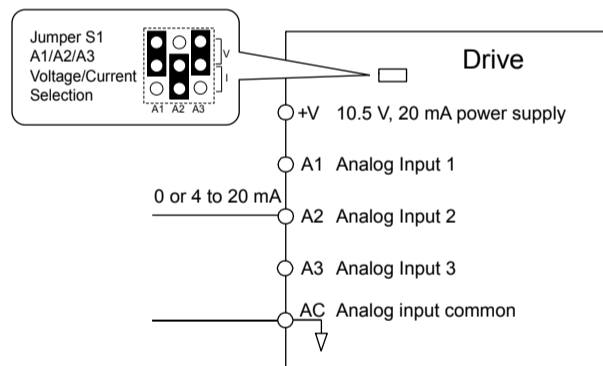

Figure 5.56 Setting the Frequency Reference as a Current Signal to Terminal A2

Switching between Main/Auxiliary Frequency References

The frequency reference input can be switched between the analog terminals A1, A2, and A3 using multi-speed inputs. *Refer to Multi-Step Speed Selection on page 106* for details on using this function.

Setting 2: BACnet or MEMOBUS/Modbus Communications

This setting requires entering the frequency reference via the RS-485 serial communications port (control terminals TXRX+ and TXRX-). *Refer to MEMOBUS/Modbus Configuration on page 330* for instructions.

Setting 3: Option Card

This setting requires entering the frequency reference via an option board plugged into connector CN5 on the bypass control board. Consult the option card manual for instructions on integrating the drive with the communication system.

■ Z1-08: Run Command Select

Determines the source of the Auto Mode RUN command used by the Bypass Controller.

5.13 Z: Bypass Parameters

No.	Name	Setting Range	Default
Z1-08	Run Command Select	0 to 3	1

Setting 0: HOA Keypad

Setting 1: Bypass Controller Digital Input

This setting requires entering the Run command via the digital input terminals.

Setting 2: BACnet or MEMOBUS/Modbus Communications

This setting requires entering the Run command via serial communications by connecting the RS-485 serial communication cable to control terminals TXRX+ and TXRX- on the terminal block. *Refer to MEMOBUS/Modbus Configuration on page 330* for instructions.

Setting 3: Option Card

This setting requires entering the Run command via the communication option board by plugging a communication option board into the CN5 port on the control PCB. Refer to the option card manual for instructions on integrating the bypass into the communication system.

5.13 Z: Bypass Parameters

■ Z1-09: HAND Mode Drive Speed Reference

The speed reference used when the Drive is running in HAND mode.

No.	Name	Setting Range	Default
Z1-09	HAND Mode Drive Speed Reference	0.0 to 60.0 Hz ^{<I>}	10.0 Hz ^{<I>}

<I> Values are given in Hz, but actual values are dependent upon unit settings using drive parameters o1-03, o1-09, o1-10, and o1-11.

■ Z1-10: Smoke Purge Preset Frequency Reference

Sets the speed at which the drive will run when the Smoke Purge Drive input is active.

No.	Name	Setting Range	Default
Z1-10	Smoke Purge Preset Frequency Reference	0.0 to 60.0 Hz ^{<I>}	10.0 Hz ^{<I>}

<I> Values are given in Hz, but actual values are dependent upon unit settings using drive parameters o1-03, o1-09, o1-10, and o1-11.

■ Z1-11: 2-Motor AND/OR Function Select

No.	Name	Setting Range	Default
Z1-11	2-Motor AND/OR Function Select	0 to 10	0

Setting 0: Disabled (Ignore Digital Inputs)

Setting 1: Always Use Only Motor 1

Setting 2: Always Use Only Motor 2

Setting 3: Always Use Motor 1 and Motor 2

Setting 4: OR Function Motor Selected by Digital Input in HAND and AUTO Modes

Setting 5: OR Function Uses Motor 1 in HAND Mode and Motor Selected by Digital Input in AUTO Mode

Setting 6: OR Function Uses Motor 2 in HAND Mode and Motor Selected by Digital Input in AUTO Mode

Setting 7: AND/OR Function Motor Selected (1, 2, or both) by (2) Digital Inputs in HAND and AUTO Modes

Setting 8: AND/OR Function Uses Motor 1 in HAND Mode and Motor Selected (1, 2, or both) by (2) Digital Inputs in AUTO Mode

Setting 9: AND/OR Function Uses Motor 2 in HAND Mode and Motor Selected (1, 2, or both) by (2) Digital Inputs in AUTO Mode

Setting 10: AND/OR Function Uses Motor 1 and Motor 2 in HAND Mode and Motor Selected (1, 2, or both) by (2) Digital Inputs in AUTO Mode

■ Z1-12 to Z1-15: Run Delay with Preset Speed

Parameters Z1-12 to Z1-15 allow running the Bypass at a preset speed before the BAS Interlock Input is active and continuing at the preset speed for a delay time after the BAS Interlock Input becomes active. Refer to **Figure 5.57** to **Figure 5.60** for examples.

■ Z1-12: Run Delay Time

Delays the drive or bypass Run after RUN, RUN ENABLE, and RUN INTERLOCK are all asserted.

No.	Name	Setting Range	Default
Z1-12	Run Delay Time	0.0 to 300.0 s	0.0 s

■ Z1-13: Pre-Interlock Run Select

Allows running at a preset speed starting immediately upon entering a Run command, ignoring the BAS Interlock Input. The drive frequency reference stays at this preset speed until the Run Delay Time (Z1-12) times out.

No.	Name	Setting Range	Default
Z1-13	Pre-Interlock Run Select	0, 1	0

Setting 0: Disabled

Setting 1: Enable Delay Time Only

Z1-14: Run Delay Frequency Reference

Sets the frequency used while delaying the Run command.

No.	Name	Setting Range	Default
Z1-14	Run Delay Frequency Reference	0.0 to 60.0 Hz <1>	60.0 Hz <1>

<1> Values are given in Hz, but actual values are dependent upon unit settings using drive parameters o1-03, o1-09, o1-10, and o1-11.

Z1-15: Interlock Wait Time

When an input is programmed for Interlock and the time set to this parameter is reached before the Interlock input goes active, a fault will be declared. The default setting of 0.0 will never time out.

No.	Name	Setting Range	Default
Z1-15	Interlock Wait Time	0.0 to 300.0 s	0.0 s

Run Delay with Preset Speed Examples

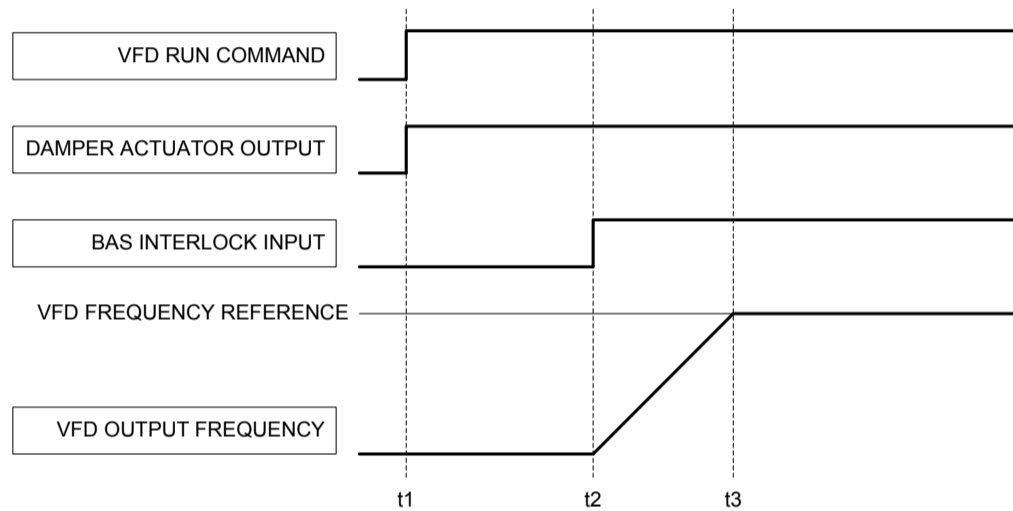

Parameter Settings:
 Z1-12 Run Delay Time = 0.0 sec
 Z1-13 Pre Int Run Sel = 0 (Disabled)
 Z1-14 Run Delay Fref = 60.0 Hz
 Z1-15 Interlock Wait Tm = 0.0 sec (Never Time Out)

Figure 5.57 Run Delay with Preset Speed Example: Default Setting

5.13 Z: Bypass Parameters

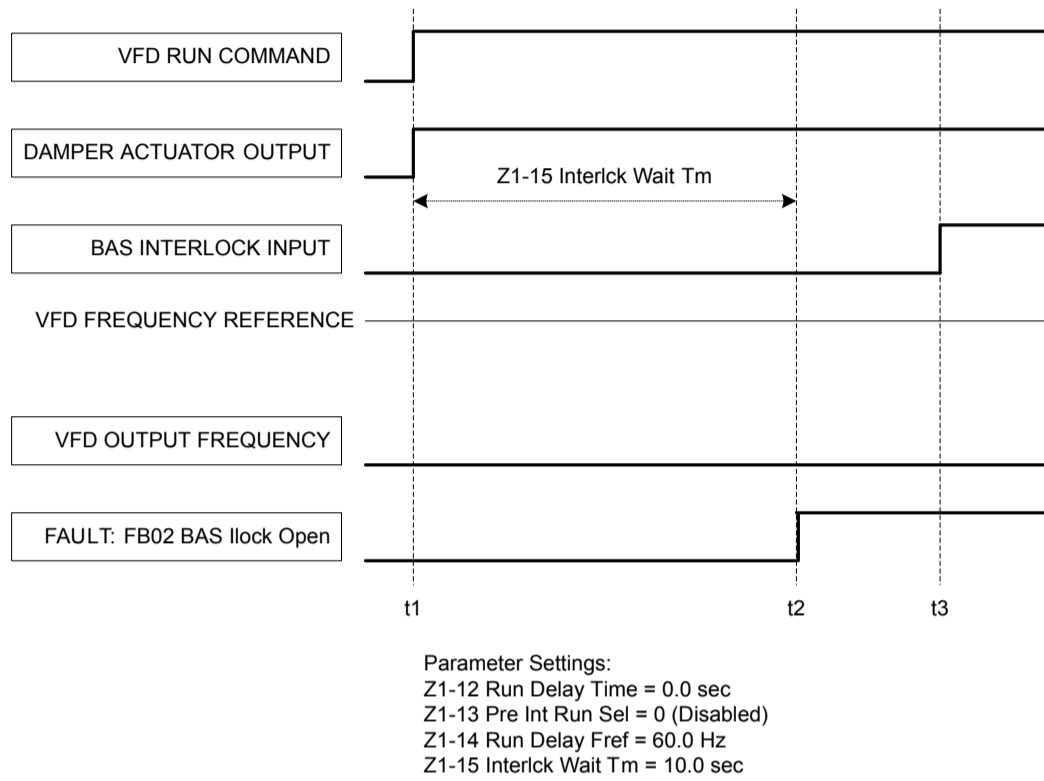

Figure 5.58 Run Delay with Preset Speed Example: BAS Interlock Wait Time Fault

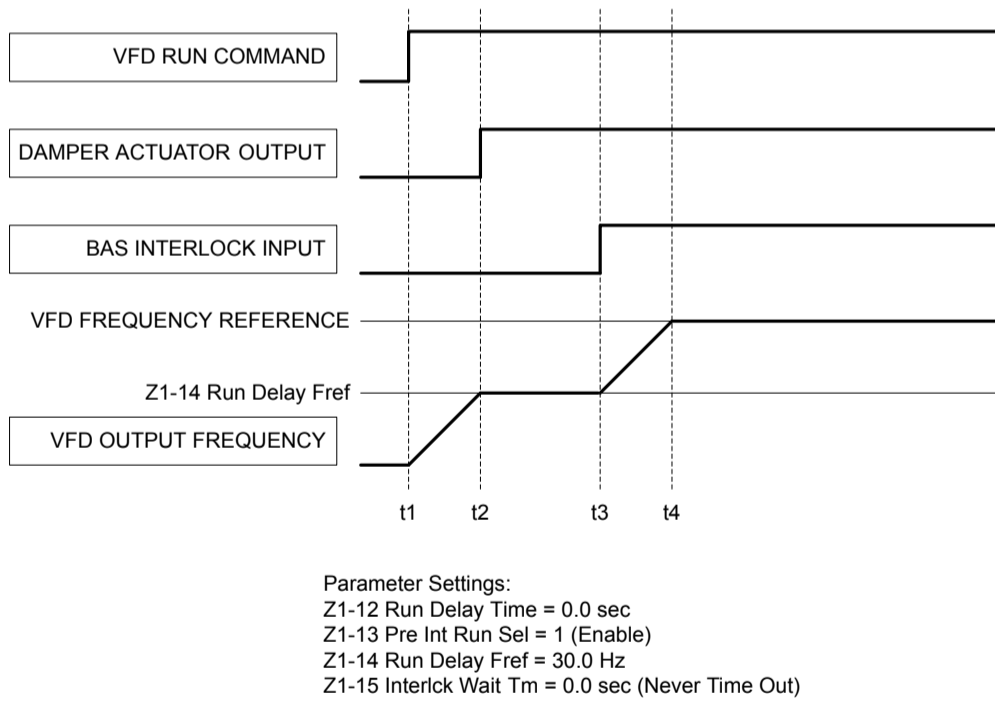
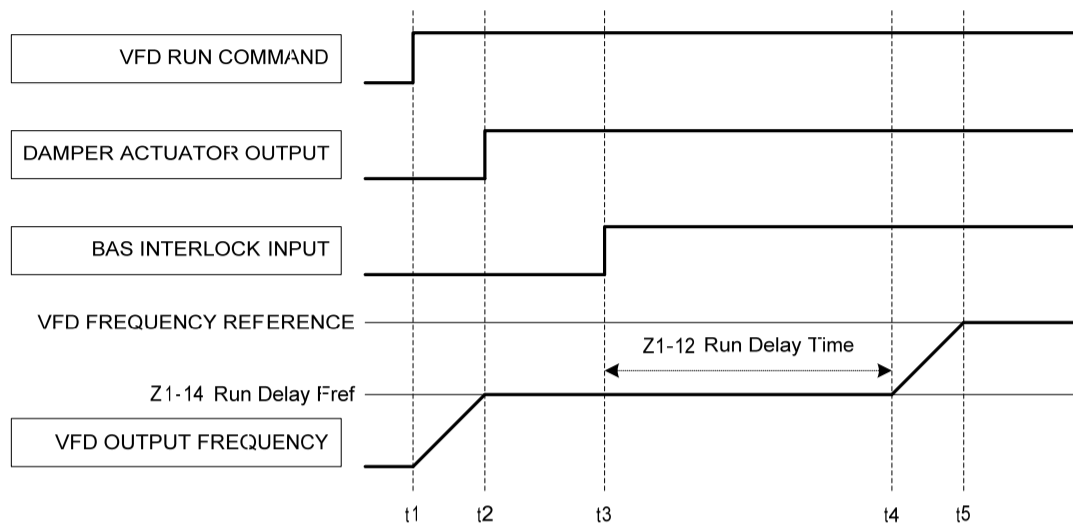

Figure 5.59 Run Delay with Preset Speed Example: Preset Speed



Parameter Settings:
 Z1-12 Run Delay Time = 10.0 sec
 Z1-13 Pre Int Run Sel = 1 (Enable)
 Z1-14 Run Delay Fref = 30.0 Hz
 Z1-15 Interlock Wait Tm = 0.0 sec (Never Time Out)

Figure 5.60 Run Delay with Preset Speed Example: Preset Speed with Run Delay

■ Z1-16 to Z1-25: Bypass Energy Savings

Allows saving energy and reducing harmonics by automatically switching to Bypass while in Drive Mode.

Users can select one of two methods using parameter Z1-16, Energy Savings Mode, to switch into Energy Savings:

Frequency Only Setting Z1-16 to 1 enables Energy Savings based on frequency only. The P1000 Bypass will automatically switch to Bypass when the following conditions are met for Z1-22, Energy Savings Mode Time:

- Drive frequency reference is within the value set to Z1-19, Energy Savings Mode Frequency Reference Deadband, of Z1-17, Energy Savings Mode Frequency.
- Drive output frequency is within the value set to Z1-20: Energy Savings Mode Output Frequency Deadband of Z1-17, Energy Savings Mode Frequency.

Frequency and Output Current Setting Z1-16 to 2 enables Energy Savings based on frequency and output current. The P1000 Bypass will automatically switch to Bypass when the frequency only conditions are met and the drive output current is within Z1-21, Energy Savings Mode Output Current Deadband, of Z1-18, Energy Savings Mode Output Current Level.

When the above conditions are met, the system:

1. Increases the drive frequency reference by the value set to Z1-23, Energy Savings Mode Frequency Reference Increase
2. Waits for the drive output frequency to match the frequency reference
3. Sets the drive to baseblock
4. Removes the effect of Z1-23 from the drive frequency reference
5. Delays per L2-03, Minimum Baseblock time
6. Opens drive output contactor K2
7. Delays per Z1-24, Contactor Open Delay Time
8. Closes Bypass contactor K3 and transfers to Bypass.

When the drive frequency reference falls out of Z1-19, Energy Savings Mode Frequency Reference Deadband, of Z1-17, Energy Savings Mode Frequency, the system:

1. Transfers motor control back to the drive
2. Opens Bypass contactor K3 with the drive still baseblocked
3. Delays per the sum of Z1-24, Contactor Open Delay Time, and L2-03, Minimum Baseblock Time
4. Closes drive output contactor K2
5. Delays per Z1-25, Contact Close Delay Time
6. Releases the drive from baseblock

5.13 Z: Bypass Parameters

7. Then the drive catches a spinning motor via Speed Search and follows frequency reference to take control. Refer to **Figure 5.61** for an example of the sequence that is followed when entering and exiting the Energy Savings Mode.

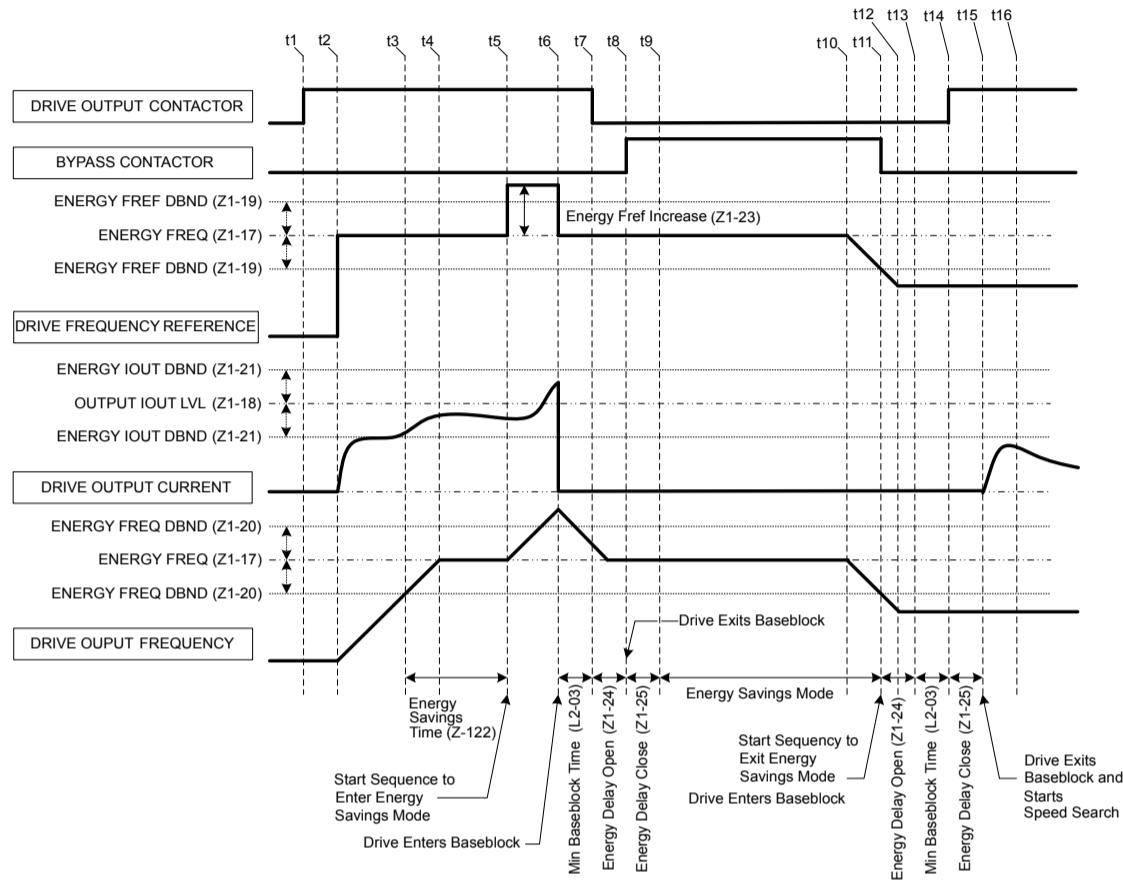

Figure 5.61 Drive Bypass Energy Savings Mode Sequence Example

■ Z1-16: Energy Savings Mode

Enables and disables the Energy Savings Mode.

No.	Name	Setting Range	Default
Z1-16	Energy Savings Mode Enable	0 to 2	0

Setting 0: Disable

Setting 1: Enable (Freq)

Setting 2: Enable (Freq + Output Current)

■ Z1-17: Energy Savings Mode Frequency

Sets the value of the drive frequency reference for use in comparison to enter or exit Energy Savings mode.

No.	Name	Setting Range	Default
Z1-17	Energy Savings Mode Frequency	0.0 to 60.0 Hz ^{<1>}	60.0 Hz ^{<1>}

<1> Values are given in Hz, but actual values are dependent upon unit settings using drive parameters o1-03, o1-09, o1-10, and o1-11.

■ Z1-18: Energy Savings Mode Output Current Level

Allows system to switch when the output current rises above this level of motor rated current for time specified in Z1-22.

No.	Name	Setting Range	Default
Z1-18	Energy Savings Mode Output Current Level	0.0 to 100.0%	0.0%

5.13 Z: Bypass Parameters

■ Z1-19: Energy Savings Mode Frequency Reference Deadband

Sets the tolerance around the drive frequency reference value during comparisons to enter or exit Energy Savings mode

No.	Name	Setting Range	Default
Z1-19	Energy Savings Mode Frequency Reference Deadband	0.0 to 5.0 Hz ^{<1>}	0.5 Hz ^{<1>}

<1> Values are given in Hz, but actual values are dependent upon unit settings using drive parameters o1-03, o1-09, o1-10, and o1-11.

■ Z1-20: Energy Savings Mode Output Frequency Deadband

Sets the tolerance around the drive output frequency value during comparisons to enter or exit Energy Savings mode.

No.	Name	Setting Range	Default
Z1-20	Energy Savings Mode Output Frequency Deadband	0.0 to 5.0 Hz ^{<1>}	0.5 Hz ^{<1>}

<1> Values are given in Hz, but actual values are dependent upon unit settings using drive parameters o1-03, o1-09, o1-10, and o1-11.

■ Z1-21: Energy Savings Mode Output Current Deadband

Sets the tolerance around the drive output current value during comparisons to enter or exit Energy Savings mode as a percentage of motor rated current.

No.	Name	Setting Range	Default
Z1-21	Energy Savings Mode Output Current Deadband	0.0 to 30.0%	15.0%

■ Z1-22: Energy Savings Mode Time

Sets the time that the drive frequency reference and drive output frequency must be within the set limits before transferring to Energy Savings mode.

No.	Name	Setting Range	Default
Z1-22	Energy Savings Mode Time	10 to 60000 s	30 s

■ Z1-23: Energy Savings Mode Frequency Reference Increase

Sets the value to add to the drive Frequency Reference when starting the transfer to bypass mode the drive when entering the Energy Savings Mode.

No.	Name	Setting Range	Default
Z1-23	Energy Savings Mode Frequency Reference Increase	0.0 to 10.0 Hz ^{<1>}	6.0 Hz ^{<1>}

<1> Values are given in Hz, but actual values are dependent upon unit settings using drive parameters o1-03, o1-09, o1-10, and o1-11.

■ Z1-24: Contactor Open Delay Time

Sets the time to delay after commanding the drive output contactor K2 or bypass contactor K3 or 2-Motor AND/OR contactors K4 and K5 to open to allow the contacts to open.

No.	Name	Setting Range	Default
Z1-24	Contactor Open Delay Time	0.0 to 5.0 s	0.2 s

■ Z1-25: Contactor Close Delay Time

Sets the time to delay after commanding the drive output contactor K2 or bypass contactor K3 or 2-Motor AND/OR contactors K4 and K5 to open to allow the contacts to close.

No.	Name	Setting Range	Default
Z1-25	Contactor Close Delay Time	0.0 to 5.0 s	0.2 s

■ Z1-27 to Z1-29: Control Voltage Protection

The Bypass controller monitors the voltage to the contactor coils and the Bypass controller power supply. The controller will detect brownout and blackout conditions. Blackout and brownout conditions will trigger an FB08 or FB09 fault and de-energize the contactor coils.

5.13 Z: Bypass Parameters

■ Z1-27: Phase Loss Brownout Voltage Level

Sets the brownout condition voltage level.

No.	Name	Setting Range	Default
Z1-27	Phase Loss Brownout Voltage Level	0 to 150 V	98 V

■ Z1-28: Phase Loss Brownout Detection Time

Sets the time that the input voltage is continuously measured to be below the Brownout Voltage level before declaring a brownout fault.

No.	Name	Setting Range	Default
Z1-28	Phase Loss Brownout Detection Time	0.0 to 300.0 s	3.0 s

■ Z1-29: Phase Loss Blackout Voltage Level

Sets the voltage level below which is considered a blackout condition.

No.	Name	Setting Range	Default
Z1-29	Phase Loss Blackout Voltage Level	0 to 150 V0	0 V

■ Z1-30: EF0 Fault Delay Time

Sets the time between declaring a drive fault and opening the drive and bypass contactors.

No.	Name	Setting Range	Default
Z1-30	EF0 Fault Delay Time	0.0 to 300.0 s	1.0 s

■ Z1-31: Loss of Load Detection Enable

No.	Name	Setting Range	Default
Z1-31	Loss of Load Detection Enable	0 to 2	0

Setting 0: Disable

Setting 1: Enable and Declare Fault

Setting 2: Enable and Alarm Only

■ Z1-32: Loss of Load Drive Frequency

Sets the value to which the drive output frequency must be equal to or greater than for the drive to detect a loss of load.

No.	Name	Setting Range	Default
Z1-32	Loss of Load Drive Frequency	0.0 to 60.0 Hz ^{<I>}	60.0 Hz ^{<I>}

<I> Values are given in Hz, but actual values are dependent upon unit settings using drive parameters o1-03, o1-09, o1-10, and o1-11.

■ Z1-33: Loss of Load Drive Output Current

Sets the value to which the drive output current must be equal to or less than for the drive to detect a loss of load.

No.	Name	Setting Range	Default
Z1-33	Loss of Load Drive Output Current	0.0 to 999.9 A	0.0 A

■ Z1-34: Loss of Load Drive Time

While in Drive mode, the Loss of Load detection conditions must be met for the length of time entered here before detecting a loss of load.

No.	Name	Setting Range	Default
Z1-34	Loss of Load Drive Time	0.0 to 300.0 s	1.0 s

■ Z1-35: Loss of Load Bypass Output Current

The motor current must be equal to or less than this value to detect a loss of load.

5.13 Z: Bypass Parameters

No.	Name	Setting Range	Default
Z1-35	Loss of Load Bypass Output Current	0.0 to 999.9	0.0 A

■ Z1-36: Loss of Load Bypass Time

While in Bypass mode, the Loss of Load detection conditions must be met for the length of time entered here before detecting a loss of load.

No.	Name	Setting Range	Default
Z1-36	Loss of Load Bypass Time	0.0 to 300.0	1.0 s

■ Z1-37: Set Time

Changes the LCD display to time setting to set the Real Time Clock.

Note: Setting 2 is added in bypass controller software version VST800298. Setting 2 is not available in bypass controller software versions VST800297 and earlier.

No.	Name	Setting Range	Default
Z1-37	Set Time	0 to 2	0

Setting 0: Normal Display

Setting 1: Displays Time and Date Setting Mode

Setting 2: Reset Time

■ Z1-38: HOA Source Select

No.	Name	Setting Range	Default
Z1-38	HOA Source Select	0 to 2	0

Setting 0: Operator

The HOA keypad controls the HAND/OFF/AUTO commands.

Setting 1: Digital Inputs

The H1-□□ multi-function digital input parameters control the HAND/OFF/AUTO commands.

Setting 2: Serial Communications

The serial communications protocol selected in parameter Z3-01 controls the HAND/OFF/AUTO commands.

■ Z1-39: Drive/Bypass Source Select

No.	Name	Setting Range	Default
Z1-39	Drive/Bypass Source Select	0 to 2	0

Setting 0: Operator

The HOA keypad selects the Drive or Bypass as the source.

Setting 1: Digital Inputs

The H1-□□ multi-function digital input parameters select the Drive or Bypass as the source.

Setting 2: Serial Communications

The serial communications protocol selected in parameter Z3-01 selects the Drive or Bypass as the source.

■ Z1-40: Auto Transfer Wait Time

If Auto Transfer is enabled and a drive fault is detected, the bypass controller will wait the length of time entered here before switching to bypass.

No.	Name	LCD Display	Setting Range	Default
Z1-40	Auto Transfer Wait Time	Auto Xfer Wait T	0.0 to 300.0	0.0 s

■ Z1-41: HAND Speed Reference Selection

Selects the frequency reference source when in HAND Mode.

Note: Parameter available in bypass controller software versions VST800298 and later.

5.13 Z: Bypass Parameters

No.	Name	Setting Range	Default
Z1-41	HAND Speed Reference Selection	0, 1	0

Setting 0: Parameter Z1-09

Parameter Z1-09 sets the frequency reference for the drive when in HAND Mode.

Setting 1: Analog

An analog input sets the frequency reference when in HAND Mode.

- Note:**
1. Set H3-02 to “1F - HAND Mode” when using Terminal A1 for HAND Mode frequency reference.
 2. Set H3-10 to “1F - HAND Mode” when using Terminal A2 for HAND Mode frequency reference.

■ Z1-42: Bypass Device Type

Selects either contactor or soft-starter bypass type. This parameter should be set to 1 at the factory on bypasses with the softstarter option PW. It is not necessary for the customer to adjust this setting.

Note: Parameter available in bypass controller software versions VST800299 and later.

No.	Name	Setting Range	Default
Z1-42	Bypass Device Type	0, 1	0

Setting 0: Contactor

The cabinet blowers operate only when the drive is running.

Setting 1: Soft Starter

The cabinet blowers operate in drive and bypass run modes.

■ Z1-50: Bypass Unbalanced Current Detection Level

Sets the current unbalance level between phases as a percentage of parameter E2-01 when operating in Bypass Mode. This function is used in conjunction with parameter Z1-51 to detect input or output phase loss during bypass operation.

The unbalance level is determined by measuring the RMS current in each of the output phases. The amount of current unbalance between the phases is calculated using the following formula:

$$\text{Unbalance Level} = (I_{(\max)} - I_{(\min)}) / I_{(\max)} \times 100\%$$

When the unbalance level exceeds the Z1-50 setting for longer than the time set to Z1-51, an “FB15 – Input Phase Loss” fault is triggered and the drive will coast to stop.

This parameter rarely needs to be changed.

Note: Parameter available in bypass controller software versions VST800298 and later.

No.	Name	Setting Range	Default
Z1-50	Bypass Unbalanced Current Detection Level	5.0 to 50.0%	25.0%

■ Z1-51: Bypass Unbalance Trip Time Detection Level

Sets the trip time for an unbalance condition when operating in Bypass Mode. This function is used in conjunction with parameter Z1-50 to detect input or output phase loss during bypass operation.

- Note:**
1. Parameter available in bypass controller software versions VST800298 and later.
 2. Setting this parameter to 0.0 will disable unbalance (bypass phase loss) protection.

No.	Name	Setting Range	Default
Z1-51	Bypass Unbalance Trip Time Detection Level	0.0 to 30.0 s	5.0 s

■ Z1-52: Bypass Phase Rotation

Input phase rotation is ignored when operating in Drive Mode. Input phase rotation determines motor direction when operating in Bypass Mode.

If input phase rotation is reversed and this parameter is set to 1, an “AL16 – Inp Phase Rotation” alarm will be displayed when operation starts in Bypass Mode and operation continues.

If input phase rotation is reversed and this parameter is set to 2, an “FB16 – Inp Phase Rotation” fault will be displayed when operation starts in Bypass Mode and the drive will coast to stop.

5.13 Z: Bypass Parameters

Controls the behavior of the bypass phase rotation detection when operating in Bypass Mode.

Note: Parameter available in bypass controller software versions VST800298 and later.

No.	Name	Setting Range	Default
Z1-52	Bypass Phase Rotation	0 to 2	1

Setting 0: Disabled

Setting 1: Alarm

Setting 2: Fault

■ Z1-53: Load Verification Fault Select

Enables and disables verification that the motor is running when commanded to run.

When this function is enabled and the bypass detects a loss of output current, such as an open external motor disconnect, or a zero frequency reference command for longer than 10 seconds, the bypass will display a “Load Lost” fault, coast to stop, and any digital output programmed to “Damper Act Out” (Z2-2□ = 20) will open.

The "Load Lost" fault is disabled during smoke purge operation.

Note: Parameter available in bypass controller software versions VST800400 and later.

No.	Name	Setting Range	Default
Z1-53	Load Verification Fault Select	0 to 1	0

Setting 0: Disabled

Setting 1: Enabled

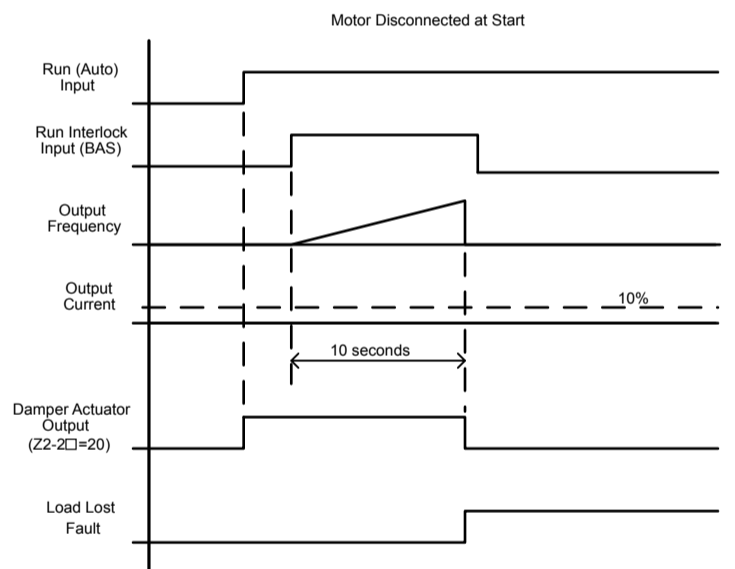

Figure 5.62 Motor Disconnected at Start

5.13 Z: Bypass Parameters

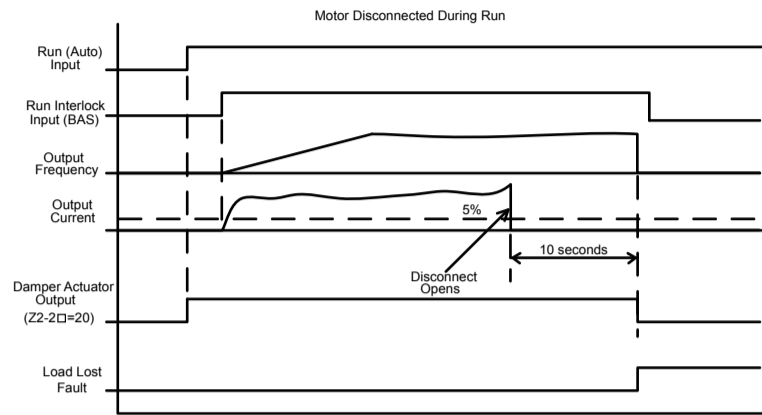

Figure 5.63 Motor Disconnected During Run

■ Z1-54: LCD Contrast Control

Sets the contrast of the LCD operator display on the bypass.

Note: Parameter available in bypass controller software versions VST800400 and later.

No.	Name	Setting Range	Default
Z1-54	LCD Contrast Control	1 to 5	3

■ Z1-55: Welded K3 Contactor Fault Select

Enables and disables monitoring of bypass contactor K3 for a "welded contactor" condition.

This detection is active when the bypass is taken out of bypass run mode or when power is first applied to the bypass package.

The bypass will display an "FB18 - K3 Welded" fault upon detection of the condition. Cycle power to the bypass package to clear this fault.

Note: Parameter available in bypass controller software versions VST800400 and later.

No.	Name	Setting Range	Default
Z1-55	Welded K3 Contactor Fault Select	0, 1	0

Setting 0: Disabled

Setting 1: Enabled

■ Z1-60: Black Out Selection

Determines the bypass behavior when contactor voltage drops below Z1-29 setting.

Note: Parameter available in bypass controller software versions VST800401 and later.

No.	Name	Setting Range	Default
Z1-60	Black Out Selection	0, 1	0

Setting 0: Fault

Setting 1: Restart

■ Z1-61: Restart Delay

Sets the time delay for restart.

Note: Parameter available in bypass controller software versions VST800401 and later.

No.	Name	Setting Range	Default
Z1-61	Restart Delay	1 to 300 s	10 s

◆ Z2: Bypass Control Input/Output

■ Z2-01 to Z2-08: Digital Input 1 to 8 Function Select

No.	Name	Setting Range	Default
Z2-01	Digital Input 1 Function Select	0 to 36	21
Z2-02	Digital Input 2 Function Select	0 to 36	22
Z2-03	Digital Input 3 Function Select	0 to 36	23
Z2-04	Digital Input 4 Function Select	0 to 36	24
Z2-05	Digital Input 5 Function Select	0 to 36	25
Z2-06	Digital Input 6 Function Select	0 to 36	0
Z2-07	Digital Input 7 Function Select	0 to 36	0
Z2-08	Digital Input 8 Function Select	0 to 36	29

■ Bypass Digital Input Terminal Settings

Table 5.30 Bypass Digital Input Terminal Settings

Setting	Function	Page	Setting	Function	Page
0 <1>	Unused (Available for Serial Comms)	177	23	Run Interlock (BAS)	178
	Note: Multiple digital input terminals can be programmed for “Unused (Available for Serial Comms)” (Z2-0□ = 0). The drive will run only when all digital inputs programmed for “0” are active. This feature applies to settings 0 and 22. Set all other selections only once in parameters Z2-01 to Z2-08.		24	Remote Transfer to Bypass	178
3	DRV Multi-Function Input S3 (H1-03 Setting)	177	25	Smoke Purge Bypass Run to Destruction	178
4	DRV Multi-Function Input S4 (H1-04 Setting)	177	26	Smoke Purge Drive Run to Destruction at Smoke Purge Preset Speed	178
5	DRV Multi-Function Input S5 (H1-05 Setting)	178	27	Motor OR Select	178
6	DRV Multi-Function Input S6 (H1-06 Setting)	178	28	Motor AND Select	178
7	DRV Multi-Function Input S7 (H1-07 Setting)	178	29	Motor 1 Overload Contact	178
8 <2>	DRV Multi-Function Input S8 (H1-08 Setting)	178	30	Motor 2 Overload Contact	178
	21	Run (AUTO Mode)	178	31	HAND Select
22 <1>	Run Enable (Safety)	178	32	AUTO Select	178
	Note: Multiple digital input terminals can be programmed for “Run Enable (Safety)” (Z2-0□ = 22) in bypass controller software versions VST800298 and later. The drive will run only when all digital inputs programmed for “22” are active. This feature applies to settings 0 and 22. Set all other selections only once in parameters Z2-01 to Z2-08.		33	DRIVE/BYPASS Select	179
			34	Fault Reset	179
			35	External Fault (EFO)	179
			36	External Fault (EFB)	179

<1> Can be set to multiple digital input parameters simultaneously in bypass controller software versions VST800298 and later.

<2> Available in bypass controller software versions VST800299 and later.

Setting 0: Unused (Available for Serial Comms)

Note: Multiple digital input terminals can be programmed for “Unused (Available for Serial Comms)” (Z2-0□ = 0). The drive will run only when all digital inputs programmed for “0” are active. This feature applies to settings 0 and 22. All other selections should only be set once in parameters Z2-01 to Z2-08.

Setting 3: DRV Multi-Function Input S3 (H1-03 Setting)

Refer to H1-03 to H1-08: Functions for Terminals S3 to S8 on page 115 for available H1-03 multi-function input settings.

Setting 4: DRV Multi-Function Input S4 (H1-04 Setting)

Refer to H1-03 to H1-08: Functions for Terminals S3 to S8 on page 115 for available H1-04 multi-function input settings.

5.13 Z: Bypass Parameters

Setting 5: DRV Multi-Function Input S5 (H1-05 Setting)

Refer to H1-03 to H1-08: Functions for Terminals S3 to S8 on page 115 for available H1-05 multi-function input settings.

Setting 6: DRV Multi-Function Input S6 (H1-06 Setting)

Refer to H1-03 to H1-08: Functions for Terminals S3 to S8 on page 115 for available H1-06 multi-function input settings.

Setting 7: DRV Multi-Function Input S7 (H1-07 Setting)

Refer to H1-03 to H1-08: Functions for Terminals S3 to S8 on page 115 for available H1-07 multi-function input settings.

Setting 8: DRV Multi-Function Input S8 (H1-08 Setting)

Refer to H1-03 to H1-08: Functions for Terminals S3 to S8 on page 115 for available H1-08 multi-function input settings.

Setting 21: Run (AUTO Mode)

Starts and stops the bypass when Z1-08 is set to 1.

Setting 22: Run Enable (Safety)

Stops the drive from running regardless of Z1-08 setting. Z2-31 controls the message displayed on the HOA keypad when this input is open.

Note: Multiple digital input terminals can be programmed for “Run Enable (Safety)” (Z2-0□ = 22) in bypass controller software versions VST800298 and later. The drive will run only when all digital inputs programmed for “22” are active. This feature applies to settings 0 and 22. All other selections should only be set once in parameters Z2-01 to Z2-08.

Setting 23: Run Interlock (BAS)

Stops the drive and triggers alarm AL02. Use parameters Z1-13 and Z1-15 to modify Interlock settings.

Setting 24: Remote Transfer to Bypass

Stops the drive and turns on the bypass when a Run command is issued while in Drive Mode. The fault for this mode is controlled by parameter Z1-05. Parameter Z1-40 controls the length of time that the drive must be faulted before switching to Bypass Mode.

Setting 25: Smoke Purge Bypass Run to Destruction

Stops the drive, turns on the bypass, and triggers alarm AL03. The bypass runs continuously regardless of any faults or alarms.

Setting 26: Smoke Purge Drive Run to Destruction at Smoke Purge Preset Speed

Bypass controller will stay in this state even if the drive faults or is unavailable. The preset speed is equal to the value set to Z1-10.

Setting 27: Motor OR Select

2-Motor OR function; 0/1 for Motor 1/2. Behavior defined by Z1-11.

Setting 28: Motor AND Select

2-Motor AND function; 0/1 for 1/2 motor. If 1 motor, then look to Motor OR input for selected motor. Behavior defined by Z1-11.

Setting 29: Motor 1 Overload Contact

When input is open, declare an oL Fault, issue an EF0 fault to the drive, delay per EF0 Fault Delay Time (Z1-30), and open Bypass (K3) contactors.

Setting 30: Motor 2 Overload Contact

When input is open, declare an oL Fault, issue an EF0 fault to the drive, delay per EF0 Fault Delay Time (Z1-30), and open Bypass (K3) contactors.

Setting 31: HAND Select

When this is selected, the HAND function command will come from a digital input while the HAND key on the HOA operator will be ignored. If both HAND and AUTO functions are configured to come from digital inputs, the lack of both of these inputs being active will put the HOA function into the OFF state. The OFF key on the HOA operator will always place the HOA function to the OFF state.

Setting 32: AUTO Select

When this is selected, the AUTO function command will come from a digital input while the AUTO key on the HOA operator will be ignored. If both HAND and AUTO functions are configured to come from digital inputs, the lack of both of these inputs being active will put the HOA function into the OFF state. The OFF key on the HOA operator will always place the HOA function to the OFF state.

5.13 Z: Bypass Parameters

Setting 33: DRIVE/BYPASS Select

When this is selected, the DRIVE/BYPASS select function command will come from a digital input while the DRV/BYP key on the HOA operator will be ignored.

Input OFF: Drive Mode is selected.

Input ON: Bypass Mode is selected.

Setting 34: Fault Reset

Resets any faults that are present.

Setting 35: External Fault (EF0)

Issues external fault EF0 to the drive from the bypass. Use parameter Z1-30 to modify the fault delay time.

Setting 36: External Fault (EFB)

Triggers external EFB on the bypass.

Setting 37: Run Reverse (AUTO Mode)

Starts and stops the bypass in reverse when Z1-08 is set to 1.

■ Z2-09 to Z2-16: Digital Input 1 to 8 Invert Select

No.	Name	Setting Range	Default
Z2-09	Digital Input 1 Invert Select	0, 1	0
Z2-10	Digital Input 2 Invert Select	0, 1	1
Z2-11	Digital Input 3 Invert Select	0, 1	0
Z2-12	Digital Input 4 Invert Select	0, 1	0
Z2-13	Digital Input 5 Invert Select	0, 1	0
Z2-14	Digital Input 6 Invert Select	0, 1	0
Z2-15	Digital Input 7 Invert Select	0, 1	0
Z2-16	Digital Input 8 Invert Select	0, 1	1

■ Bypass Digital Input Invert Settings

Setting 0: Normal

Lack of input signal = OFF

Setting 1: Inverted

Lack of input signal = ON

■ Z2-23 to Z2-26: Digital Output 7 to 10 Function Select

No.	Name	Setting Range	Default
Z2-23	Digital Output 7 Function Select	0 to 23; 99	7
Z2-24	Digital Output 8 Function Select	0 to 23; 99	10
Z2-25	Digital Output 9 Function Select	0 to 23; 99	12
Z2-26	Digital Output 10 Function Select	0 to 23; 99	15

■ Bypass Digital Output Terminal Settings

Table 5.31 Bypass Digital Output Terminal Settings

Setting	Function	Setting	Function
0	Serial Comm Controlled	7	RUN Active (Drive or Bypass)
1	K1 Drive Input Contactor	8	Drive RUN Active
2	K2 Drive Output Contactor	9	Bypass RUN Active
3	K3 Bypass Contactor	10	HAND Mode Active
4	K4 Motor 1 Select	11	OFF Mode Active
5	K5 Motor 2 Select	12	AUTO Mode Active
6	READY (Drive and Bypass)	13	Drive Mode Selected

5.13 Z: Bypass Parameters

Setting	Function	Setting	Function
14	Bypass Mode Selected	22	Loss of Load Detected
15	Drive or Bypass Fault Active	23 <I>	Run Verify The digital output closes when the drive or bypass output current exceeds 10% of the value set in E2-01. The digital output opens when the drive or bypass output current falls below 5% of the value set in E2-01.
16	Drive Fault Active		
17	Bypass Fault Active	99	Not Used (Through Mode) This setting allows serial communications to control the output.
18	Auto Transfer Active		
19	Serial Run Command Active		
20	Damper Actuator Output		
21	ON Always		

<I> Available in bypass controller software versions VST800298 and later.

■ Z2-31: Safety Open Message Selection

Sets the fault message displayed when an FB01 fault is triggered. This parameter also determines the text that is displayed on the top line of the HOA keypad.

Note: Parameter available in bypass controller software versions VST800298 and later.

No.	Name	Setting Range	Default
Z2-31	Safety Open Message Selection	0 to 6	0

Setting 0: Safety Open

Setting 1: Fire Stat

Setting 2: Freeze Stat

Setting 3: Smoke Alarm

Setting 4: Over Pressure

Setting 5: Low Suction

Setting 6: Vibration Switch

◆ Z3: Bypass Control Communication

■ Z3-01: Serial Communications Protocol Select

Selects the bypass serial communications protocol.

No.	Name	Setting Range	Default
Z3-01	Serial Communications Protocol Select	0 to 3	3

Setting 0: Modbus

Setting 1: N2

Setting 2: P1

Setting 3: BACnet

■ Z3-02: Serial Communications Node Select

Selects the bypass serial communications node address.

Note: Each slave must be assigned a unique slave address for serial communications to work properly. Slave addresses do not need to be assigned in sequential order, but no two slaves may share the same address.

No.	Name	Setting Range	Default
Z3-02	Serial Communications Node Select	0 to 127	1

■ Z3-03: Serial Communications Baud Rate Select

Selects the bypass serial communications speed.

Selecting settings 0, 1, or 2 will trigger an oPE29 error when using BACnet communication (Z3-01 = 3) in bypass controller software versions VST800400 and later.

No.	Name	Setting Range	Default
Z3-03	Serial Communications Baud Rate Select	0 to 8	3

Setting 0: 1200 bps
 Setting 1: 2400 bps
 Setting 2: 4800 bps
 Setting 3: 9600 bps
 Setting 4: 19200 bps
 Setting 5: 38400 bps
 Setting 6: 57600 bps
 Setting 7: 76800 bps
 Setting 8: 115200 bps

■ Z3-04: Serial Communications Parity Select

Selects the bypass serial communications parity. This setting is ignored when BACnet protocol is selected.

No.	Name	Setting Range	Default
Z3-04	Serial Communications Parity Select	0 to 2	0

Setting 0: No Parity
 Setting 1: Even Parity
 Setting 2: Odd Parity

■ Z3-05: Serial Communications Fault Select

Selects the action to take when a serial communications fault is detected. A serial communications fault is detected when after last communicating, no communications occurs within the time set to Z3-06.

No.	Name	Setting Range	Default
Z3-05	Serial Communications Fault Select	0 to 4	1

Setting 0: Ignore
 Setting 1: Alarm Only
 Setting 2: Fault with EF0

An EF0 fault will be sent to the drive.

Setting 3: Fault with EF0 and Open Contactors

An EF0 fault will be sent to the drive and the bypass contactor (K3) will be opened.

Setting 4: Alarm and run at preset speed set in Z3-10

Display AL14 alarm on operator.

■ Z3-06: Serial Communications Fault Time Select

Sets the time allowed to elapse since receiving serial communications before triggering a communications fault.

A value of 0.0 means to never time out.

No.	Name	Setting Range	Default
Z3-06	Serial Communications Fault Time Select	0.0 s to 99.9 s	2.0 s

■ Z3-07: Serial Communications Receive to Transmit Wait Time

Sets the time to delay a serial communications response to a serial communications command.

No.	Name	Setting Range	Default
Z3-07	Serial Communications Receive to Transmit Wait Time	0 to 99 ms	5 ms

■ Z3-08, Z3-09: BACnet Device Object Identifier

These parameters set the Instance Identifier of the BACnet Device Object, where Z3-08 is the least significant word and Z3-09 is the most significant word.

No.	Name	Setting Range	Default
Z3-08	BACnet Device Object Identifier 0	0 to FFFFH	1
Z3-09	BACnet Device Object Identifier 1	0 to 003FH	0

5.13 Z: Bypass Parameters

Example 1: Set Device Object Instance Identifier of “1234”.

1234 decimal is equal to 4D2H (hexadecimal).

Set Z3-08 to 4D2H and set Z3-09 to 0.

Example 2: Set Device Object Instance Identifier of “123456”.

123456 decimal is equal to 1E240H.

Set Z3-08 to D687H and set Z3-09 to 12H.

■ Z3-10: Cable Loss Pre-set Speed

When a serial communications fault is detected and Z3-05 = 4, the value here will become the frequency reference.

No.	Name	Setting Range	Default
Z3-10	Cable Loss Pre-set Speed	0.0 to 60.0 Hz	0.0 Hz

■ Z3-11: Communication Fault Detection Selection

No.	Name	Setting Range	Default
Z3-11	Communication Fault Detection Selection	0 to 1	1

Setting 0: Disabled

Ignore setting in Z3-05.

Setting 1: Enabled

Behavior defined by Z3-05.

■ Z3-12: Network Digital Input Select

Determines whether the serial communication digital input simulation is active.

Note: Parameter available in bypass controller software versions VST800298 and later.

No.	Name	Setting Range	Default
Z3-12	Network Digital Input Select	0, 1	0

Setting 0: Disable

Serial communications physical digital inputs are ignored.

For MEMOBUS/Modbus (Z3-01 = 0): Command Register 8402H is disabled.

For Metasys N2 (Z3-01 = 1): Binary Outputs B05, B06, B07, B08, and B09 are disabled.

For P1 Apogee (Z3-01 = 2): Points LDO44, LDO45, LDO46, LDO47, and LDO48 are disabled.

For BACnet (Z3-01 = 3): BV72, BV73, BV74, BV75, BV76, BV77, BV78, and BV79 are disabled.

Setting 1: Enable

Physical digital inputs S1 to S8 are logically OR'd with the serial communications digital inputs.

WARNING! Sudden Movement Hazard. Setting this parameter to 1 may cause the system to run unexpectedly or not stop when required even if the physical digital input is de-energized, resulting in death or serious injury. Clear all personnel from the drive, motor and machine area before applying power. Set this parameter to 0 to prevent serial communications from triggering undesired and unexpected system operation.

■ Z3-13: BACNet Command Register Retention

WARNING! Sudden Movement Hazard. Setting this parameter to 2 or 3 will allow the bypass unit to start before receiving a valid network message. Clear all personnel from the drive, motor, and machine area before reapplying power. Failure to comply could result in injury to personnel.

Determines whether to restore the frequency reference, bypass command, or both upon the reapplication of power after losing power. The feature restores all bypass command register values except the fault reset bit.

Set Z1-06 ≠ 0 or Z1-38 = 2 to allow the bypass to start running upon application of power.

- Note:**
- Parameter is effective only when Z3-01 = 3 (Serial Communications Protocol Select = BACnet), Z1-07 = 2 (Speed Reference Select = Bypass Serial), and/or Z1-08 = 2 (Run Command Select = Bypass Serial).
 - Parameter is available in bypass controller software versions VST800400 and later.

5.13 Z: Bypass Parameters

No.	Name	Setting Range	Default
Z3-13	BACNet Command Register Retention	0 to 3	0

Setting 0: Disabled

Reapplying power will not restore any BACNet objects.

Setting 1: Reference Only

Reapplying power restores the frequency reference object (AV2).

Setting 2: Run/Stop Only

Reapplying power restores various command objects including the Run commands. *Refer to BACNet Values Restored When Z3-13 = 2 or 3 on page 183* for a list of command objects.

Setting 3: Ref & Run/Stop

Reapplying power restores the frequency reference object (AV2) and various command objects. *Refer to BACNet Values Restored When Z3-13 = 2 or 3 on page 183* for a list of command objects.

Table 5.32 BACNet Values Restored When Z3-13 = 2 or 3

Object ID	Object Name
BV58	BYP Run Fwd CMD
BV59	BYP Run Rev CMD
BV61	BYP Xfer to BYP CMD
BV62	BYP Smok Prg BYP CMD
BV63	BYP Smok Prg DRV CMD
BV64	BYP Mtr OR Sel CMD
BV65	BYP Mtr AND Sel CMD
BV66	BYP HAND Select CMD
BV67	BYP Auto Select CMD
BV69	BYP BYPASS Sel CMD
BV71	BYP Ext Fault CMD (EFB)

◆ Z4: Ethernet Option Bypass Control

■ Z4-01 to Z4-04: IP Address 1 to 4

Sets the network static IP address. Z4-01 is the most significant octet of the network static IP address; Z4-04 is the least significant.

No.	Parameter Name	Setting Range	Default
Z4-01	IP Address 1	0 to 255	192
Z4-02	IP Address 2		168
Z4-03	IP Address 3		1
Z4-04	IP Address 4		20

■ Z4-05 to Z4-08: Subnet Mask 1 to 4

Sets the network static subnet mask. Z4-05 is the most significant octet of the network static subnet mask; Z4-08 is the least significant.

No.	Parameter Name	Setting Range	Default
Z4-05	Subnet Mask 1	0 to 255	255
Z4-06	Subnet Mask 2		255
Z4-07	Subnet Mask 3		255
Z4-08	Subnet Mask 4		0

■ Z4-09 to Z4-12: Gateway Address 1 to 4

Sets the network gateway address. Z4-09 is the most significant octet of the network gateway address; Z4-12 is the least significant.

5.13 Z: Bypass Parameters

No.	Parameter Name	Setting Range	Default
Z4-09	Gateway Address 1	0 to 255	192
Z4-10	Gateway Address 2		168
Z4-11	Gateway Address 3		1
Z4-12	Gateway Address 4		1

■ Z4-13: Address Startup Mode

Selects the option address setting method.

No.	Name	Setting Range	Default
Z4-13	Address Startup Mode	0 to 2	2

Setting 0: User-Defined (Static IP)

Setting 1: BOOTP

Setting 2: DHCP

■ Z4-14: Duplex Mode Setting

No.	Name	Setting Range	Default
Z4-14	Duplex Mode Setting	0 to 2	1

Setting 0: Forced Half Duplex

Setting 1: Auto Negotiate Duplex Mode and Communication Speed

This setting also auto-negotiates Z4-15, Speed Mode Setting.

Setting 2: Forced Full Duplex

■ Z4-15: Speed Mode Setting

No.	Name	Setting Range	Default
Z4-15	Speed Mode Setting	10, 100	10

Setting 10: 10 Mbps

Setting 100: 100 Mbps

■ Z4-16: Timeout

Sets the Control Connection Timeout value for detection of communication loss in tenths of a second. A value of 0 disables the connection timeout.

Example: An entered value of 100 represents 10.0 seconds.

No.	Name	Setting Range	Default
Z4-16	Timeout	0 to 300 s	0 s

■ Z4-17 to Z4-22: Scaling Factors

These parameters define scaling factors for drive monitors in the ODVA AC/DC Drive Object (Class 2AH), Instance 1, and the attribute given below:

Speed Scale is attribute 22

Current Scale is attribute 23

Torque Scale is attribute 24

Power Scale is attribute 26

Voltage Scale is attribute 27

Time Scale is attribute 28.

5.13 Z: Bypass Parameters

No.	Parameter Name	Setting Range	Default
Z4-17	Speed Scaling	-15 to 15	0
Z4-18	Current Scaling		0
Z4-19	Torque Scaling		0
Z4-20	Power Scaling		0
Z4-21	Voltage Scaling		0
Z4-22	Time Scaling		0

■ Z4-23 to Z4-32: Dynamic Output Assembly Parameters

Parameters used in Output Assembly 116. Each parameter contains a MEMOBUS/Modbus address. The value received for Output Assembly 116 will be written to this corresponding MEMOBUS/Modbus address. A MEMOBUS/Modbus address value of 0 means that the value received for Output Assembly 116 will not be written to any MEMOBUS/Modbus register.

No.	Parameter Name	Setting Range	Default
Z4-23	DOA116 1	0 to FFFFH	0
Z4-24	DOA116 2	0 to FFFFH	0
Z4-25	DOA116 3	0 to FFFFH	0
Z4-26	DOA116 4	0 to FFFFH	0
Z4-27	DOA116 5	0 to FFFFH	0
Z4-28	DOA116 6	0 to FFFFH	0
Z4-29	DOA116 7	0 to FFFFH	0
Z4-30	DOA116 8	0 to FFFFH	0
Z4-31	DOA116 9	0 to FFFFH	0
Z4-32	DOA116 10	0 to FFFFH	0

■ Z4-33 to Z4-42: Dynamic Input Assembly Parameters

Parameters used in Input Assembly 166. Each parameter contains a MEMOBUS/Modbus address. The value sent for Input Assembly 166 will be read from this corresponding MEMOBUS/Modbus address. A MEMOBUS/Modbus address value of 0 means that the value sent for Input Assembly 166 is not defined by the user, therefore the option default register value will be returned.

No.	Parameter Name	Setting Range	Default
Z4-33	DIA116 1	0 to FFFFH	0
Z4-34	DIA116 2	0 to FFFFH	0
Z4-35	DIA116 3	0 to FFFFH	0
Z4-36	DIA116 4	0 to FFFFH	0
Z4-37	DIA116 5	0 to FFFFH	0
Z4-38	DIA116 6	0 to FFFFH	0
Z4-39	DIA116 7	0 to FFFFH	0
Z4-40	DIA116 8	0 to FFFFH	0
Z4-41	DIA116 9	0 to FFFFH	0
Z4-42	DIA116 10	0 to FFFFH	0

5.13 Z: Bypass Parameters

This Page Intentionally Blank

6

Diagnosics & Troubleshooting

This chapter provides descriptions of the P1000 Bypass faults, alarms, errors, related displays, and guidance for troubleshooting. This chapter can also serve as a reference guide for tuning the P1000 Bypass during a trial run.

6.1	SECTION SAFETY.....	188
6.2	MOTOR PERFORMANCE FINE-TUNING.....	190
6.3	DRIVE ALARMS, FAULTS, AND ERRORS.....	191
6.4	FAULT DETECTION.....	194
6.5	ALARM DETECTION.....	209
6.6	PROGRAMMING ERRORS.....	216
6.7	AUTO-TUNING FAULT DETECTION.....	219
6.8	DIAGNOSING AND RESETTING FAULTS.....	221
6.9	TROUBLESHOOTING WITHOUT FAULT DISPLAY.....	223

6.1 Section Safety

WARNING

Electrical Shock Hazard

Do not connect or disconnect wiring while the power is on.

Failure to comply could result in death or serious injury.

Before servicing, disconnect all power to the equipment. The internal capacitor remains charged even after the power supply is turned off. The charge indicator LED will extinguish when the DC bus voltage is below 50 Vdc. To prevent electric shock, wait for at least the time specified on the warning label; after all indicators are OFF, measure for unsafe voltages to confirm the drive is safe prior to servicing.

Do not operate equipment with covers removed.

Failure to comply could result in death or serious injury.

The diagrams in this section may illustrate drives without covers or safety shields to display details. Be sure to reinstall covers or shields before operating the drives and run the drives according to the instructions described in this manual.

Always ground the motor-side grounding terminal.

Improper equipment grounding could result in death or serious injury by contacting the motor case.

Do not touch terminals before the capacitors have fully discharged.

Failure to comply could result in death or serious injury.

Before servicing, disconnect all power to the equipment. The internal capacitor remains charged even after the power supply is turned off. The charge indicator LED will extinguish when the DC bus voltage is below 50 Vdc. To prevent electric shock, wait for at least the time specified on the warning label; after all indicators are OFF, measure for unsafe voltages to confirm the drive is safe prior to servicing.

After blowing a fuse or tripping a GFCI, do not attempt to restart the drive or operate peripheral devices until five minutes pass and CHARGE lamp is OFF.

Failure to comply could result in death, serious injury, and damage to the drive.

Check wiring and peripheral device ratings to identify the cause of trips.

Contact your supplier if the cause cannot be identified.

Do not allow unqualified personnel to perform work on the drive.

Failure to comply could result in death or serious injury.

Installation, maintenance, inspection and servicing must be performed only by authorized personnel familiar with installation, adjustment and maintenance of AC drives.

Do not perform work on the drive while wearing loose clothing, jewelry, or without eye protection.

Failure to comply could result in death or serious injury.

Remove all metal objects such as watches and rings, secure loose clothing and wear eye protection before beginning work on the drive.

Do not remove covers or touch circuit boards while the power is on.

Failure to comply could result in death or serious injury.

Fire Hazard

Tighten all terminal screws to the specified tightening torque.

Loose electrical connections could result in death or serious injury by fire due to overheating of electrical connections.

Do not use an improper voltage source.

Failure to comply could result in death or serious injury by fire.

Verify that the rated voltage of the drive matches the voltage of the incoming drive input power before applying power.

⚠ WARNING**Do not use improper combustible materials.**

Failure to comply could result in death or serious injury by fire.

Attach the drive to metal or other noncombustible material.

NOTICE**Observe proper electrostatic discharge procedures (ESD) when handling the drive and circuit boards.**

Failure to comply may result in ESD damage to the drive circuitry.

Never connect or disconnect the motor from the drive while the drive is outputting voltage.

Improper equipment sequencing could result in damage to the drive.

Do not use unshielded cable for control wiring.

Failure to comply may cause electrical interference resulting in poor system performance. Use shielded twisted-pair wires and ground the shield to the ground terminal of the drive.

Do not modify the drive circuitry.

Failure to comply could result in damage to the drive and will void warranty.

Yaskawa is not responsible for modification of the product made by the user.

Check all the wiring after installing the bypass to ensure that all connections are correct.

Failure to comply could result in damage to the bypass.

6.2 Motor Performance Fine-Tuning

6.2 Motor Performance Fine-Tuning

This section offers helpful information for counteracting oscillation, hunting, and other problems that occur while performing a trial run. Refer to the appropriate control method in this section.

Note: This section describes commonly edited parameters that may be set incorrectly. Consult Yaskawa for more information on detailed settings and for fine-tuning the drive.

◆ Fine-Tuning V/f Control

Table 6.1 Parameters for Fine-Tuning Performance in V/f

Problem	Parameter No.	Corrective Action	Default	Suggested Setting
Motor hunting and oscillation at speeds between 10 and 40 Hz	Hunting Prevention Gain (n1-02)	<ul style="list-style-type: none"> Reduce the setting if insufficient motor torque relative to the size of the load causes hunting. Increase the setting when motor hunting and oscillation occur with a light load. Reduce the setting if hunting occurs when using a motor with a relatively low inductance, such as a high-frequency motor or a motor with a larger frame size. 	1.00	0.10 to 2.00
<ul style="list-style-type: none"> Motor noise Motor hunting and oscillation at speeds up to 40 Hz 	Carrier Frequency Selection (C6-02)	<ul style="list-style-type: none"> Increase the carrier frequency if the motor noise is too loud. Lower the carrier frequency when motor hunting and oscillation occur at speeds up to 40 Hz. The default setting for the carrier frequency depends on the drive capacity (o2-04). 	1 (2 kHz)	1 to max. setting
<ul style="list-style-type: none"> Poor torque or speed response Motor hunting and oscillation 	Torque Compensation Primary Delay Time (C4-02)	<ul style="list-style-type: none"> Reduce the setting if motor torque and speed response are too slow. Increase the setting if motor hunting and oscillation occur. 	Depends on o2-04, Drive Model Selection	100 to 1000 ms
<ul style="list-style-type: none"> Poor motor torque at speeds below 10 Hz Motor hunting and oscillation 	Torque Compensation Gain (C4-01)	<ul style="list-style-type: none"> Increase the setting if motor torque is insufficient at speeds below 10 Hz. Reduce the setting if motor hunting and oscillation occur with a relatively light load. 	1.00	0.50 to 1.50
<ul style="list-style-type: none"> Poor motor torque at low speeds Motor instability at motor start 	V/f Pattern Selection (E1-03)	<ul style="list-style-type: none"> Increase the setting if motor torque is insufficient at speeds below 10 Hz. Reduce the setting if motor instability occurs at motor start. Set E1-03 to a pattern that fits the application. 	Depends on o2-04	Default setting ±5 V

◆ Parameters to Minimize Motor Hunting and Oscillation

In addition to the parameters discussed in *Table 6.1*, parameters in *Table 6.2* indirectly affect motor hunting and oscillation.

Table 6.2 Parameters that Affect Control Performance in Applications

Name (Parameter No.)	Application
Accel/Decel Time (C1-01 through C1-11)	Adjusting accel and decel times will affect the torque presented to the motor during acceleration or deceleration.
S-Curve Characteristics (C2-01 and C2-02)	Prevents shock at the beginning and end of acceleration and deceleration.
Jump Frequency (d3-01 through d3-04)	Skips over the resonant frequencies of connected machinery.
Analog Filter Time Constant (H3-13)	Prevents fluctuation in the analog input signal due to noise.
Stall Prevention (L3-01 through L3-06, L3-11)	<ul style="list-style-type: none"> Prevents motor speed loss and overvoltage when the load is too heavy or during sudden acceleration/ deceleration. Adjustment is not normally necessary because Stall Prevention is enabled as a default.

6.3 Drive Alarms, Faults, and Errors

◆ Types of Alarms, Faults, and Errors

Check the HOA keypad for information about possible faults if the drive or motor fails to operate. *Refer to Using the HOA Keypad on page 59.*

If problems occur that are not covered in this manual, contact the nearest Yaskawa representative with the following information:

- P1000 Bypass model (located on nameplate)
- Software version (UB-18)
- Date of purchase
- Description of the problem

Table 6.3 contains descriptions of the various types of alarms, faults, and errors that may occur while operating the drive.

Table 6.3 Types of Alarms, Faults, and Errors

Type	Drive Response
Faults	<p>When the P1000 Bypass detects a fault:</p> <ul style="list-style-type: none"> • The HOA keypad displays text indicating the specific fault and the ALM indicator LED remains lit until the fault is reset. • The fault interrupts drive output and the motor coasts to a stop. • Some faults allow the user to select the stopping method when the fault occurs. • Fault output terminals TB1 11 and 12 will close, and TB1 10 and 11 will open. <p>The P1000 Bypass will remain inoperable until the fault is cleared. <i>Refer to Fault Reset Methods on page 222.</i></p>
Minor Faults and Alarms	<p>When the drive detects an alarm or a minor fault:</p> <ul style="list-style-type: none"> • The HOA keypad displays text indicating the specific alarm or minor fault, and the ALM indicator LED flashes. • The drive continues running the motor, although some alarms allow the user to select a stopping method when the alarm occurs. • The HOA keypad displays text indicating a specific alarm and the ALM indicator LED flashes. <p>Remove the cause of the problem to reset a minor fault or alarm.</p>
Operation Errors	<p>An operation error occurs when parameter settings conflict or do not match hardware settings (such as with an option card). When the drive detects an operation error:</p> <ul style="list-style-type: none"> • The HOA keypad displays text indicating the specific error. • Multi-function contact outputs do not operate. <p>The P1000 Bypass will not operate the motor until the error has been reset. Correct the settings that caused the operation error to clear the error.</p>
Tuning Errors	<p>Tuning errors occur while performing Auto-Tuning. When the drive detects a tuning error:</p> <ul style="list-style-type: none"> • The HOA keypad displays text indicating the specific error. • Multi-function contact outputs do not operate. • Motor coasts to stop. <p>Remove the cause of the error and repeat the Auto-Tuning process.</p>

6.3 Drive Alarms, Faults, and Errors

◆ Alarm and Error Displays

■ Faults

Table 6.4 gives an overview of possible fault codes. Conditions such as overvoltages can trip faults and alarms. It is important to distinguish between faults and alarms to determine the proper corrective actions.

When the drive detects a fault, the ALM indicator LED lights, the fault code appears on the HOA keypad, and the fault contact DO-10 triggers. An alarm is present if the ALM LED blinks and the fault code on the HOA keypad flashes. *Refer to Minor Faults and Alarms on page 193* for a list of alarm codes.

Table 6.4 Fault Displays

HOA Keypad Display	Name	Page	HOA Keypad Display	Name	Page
bAT	HOA Keypad Battery Voltage Low	194	FB14	Serial Communications Fault	199
bUS	Option Communication Error	194	FB15 <3>	Input Phase Loss	200
CE	MEMOBUS/Modbus Communication Error	194	FB16 <3>	Input Phase Rotation	200
CoF	Current Offset Fault	194	FbH	Excessive PI Feedback	200
CPF00, CPF01 <1>	Control Circuit Error	195	FbL	PI Feedback Loss	200
CPF02	A/D Conversion Error	195	GF	Ground Fault	200
CPF03	Control Board Connection Error	195	LF	Output Phase Loss	201
CPF06	EEPROM Memory Data Error	195	LF2	Current Imbalance	201
CPF07, CPF08	Terminal Board Connection Error	195	nSE	Node Setup Error	201
CPF20, CPF21 <2>	Control Circuit Error	196	oC	Overcurrent	201
CPF22	Hybrid IC Error	196	oFA00	Option Card Connection Error (CN5)	202
CPF23	Control Board Connection Error	196	oH	Heatsink Overheat	202
CPF24	Drive Unit Signal Fault	196	oH1	Heatsink Overheat	203
EF0	Option Card External Fault	196	oH3	Motor Overheat Alarm (PTC input)	203
Err	EEPROM Write Error	196	oH4	Motor Overheat Fault (PTC input)	203
FAn	Internal Fan Fault	196	oL1	Motor Overload	203
Fn1	External Fan Fault	200	oL2	Drive Overload	204
FB01	Safety Open	197	oL3	Overtorque Detection 1	204
FB02	BAS Interlock Open Time Out	197	oL7	High Slip Braking oL	204
FB03	External Fault Bypass (EFB)	197	oPr	Operator Connection Fault	205
FB05	Motor Overload	197	ov	Overvoltage	205
FB06	External Motor 1 Overload	198	PF	Input Phase Loss	205
FB07	External Motor 2 Overload	198	SEr	Too Many Speed Search Restarts	206
FB08	Phase Loss Brownout	198	STo	Pull-Out Detection	206
FB09	Phase Loss Blackout	198	TdE	Time Data Error	206
FB10	No Drive Comms	199	TIM	Time Not Set	206
FB11	Bypass Board Hardware Error	199	UL3	Undertorque Detection 1	206
FB12	Option Board Comms	199	UL6	Motor Underload	207
FB13	Loss of Load	199	Uv1	Undervoltage	207
			Uv2	Control Power Supply Undervoltage	207
			Uv3	Soft Charge Circuit Fault	207
			voF	Output Voltage Detection Fault	208

<1> Displayed as CPF00 when occurring at drive power up. When one of the faults occurs after successfully starting the drive, the display will show CPF01.

<2> Displayed as CPF20 when occurring at drive power up. When one of the faults occurs after successfully starting the drive, the display will show CPF21.

<3> Available in bypass controller software versions VST800298 and later.

■ Minor Faults and Alarms

Refer to **Table 6.5** for an overview of possible alarm codes. Conditions such as overvoltages can trip faults and alarms. It is important to distinguish between faults and alarms to determine the proper corrective actions.

When the drive detects an alarm, the ALM indicator LED blinks and the alarm code display flashes. A fault (not an alarm) is present if the ALM LED lights without blinking. *Refer to Faults on page 192* for information on fault codes.

Table 6.5 Minor Fault and Alarm Displays

HOA Keypad Display	Name	Page	HOA Keypad Display	Name	Page
AL02	BAS Interlock Open	209	LT-1	Cooling Fan Maintenance Time	212
AL03	Smoke Purge in Bypass	209	LT-2	Capacitor Maintenance Time	213
AL04	Smoke Purge in Drive	209	LT-3	Soft Charge Bypass Relay Maintenance Time	213
AL09 <1>	Run Active during Restart Delay	209	oH	Heatsink Overheat	213
AL13	Loss of Load	209	oH2	Drive Overheat	213
AL14	Serial Communications Fault	209	oH3	Motor Overheat	213
AL16 <2>	Input Phase Rotation	210	oL3	Overtorque 1	214
bAT	HOA Keypad Battery Voltage Low	194	ov	Overvoltage	214
bb	Drive Baseblock	210	PASS	MEMOBUS/Modbus Test Mode Complete	214
bUS	Option Card Communications Error	210	SAFE	Customer Safety	214
CE	MEMOBUS/Modbus Communication Error	211	SE	MEMOBUS/Modbus Test Mode Fault	214
CrST	Cannot Reset	211	TdE	Thermistor Disconnect	214
EF	Run Command Input Error	211	TIM	Time Not Set	206
EF0	Option Card External Fault	211	UL3	Undertorque 1	215
FAn	Internal Fan Fault	196	UL6	Undertorque 6	215
FbH	Excessive PI Feedback	212	Uv	Undervoltage	215
FbL	PI Feedback Loss	212	voF	Output Voltage Detection Fault	215
Fn1	External Fan Fault	200	WrUn	Waiting for Run	215
inTLK <1>	Interlock Open	212			

<1> ALM LED will not blink.

<2> Available in bypass controller software versions VST800298 and later.

■ Operation Errors

Table 6.6 Operation Error Displays

HOA Keypad Display	Name	Page	HOA Keypad Display	Name	Page
oPE01	Drive Unit Setting Error	216	oPE09	PI Control Selection Error	217
oPE02	Parameter Setting Range Error	216	oPE10	V/f Data Setting Error	217
oPE03	Multi-Function Input Setting Error	216	oPE11	Carrier Frequency Setting Error	217
oPE05	Run Command Selection Error	217	oPE28	Sequence Timer Error	218
oPE07	Multi-Function Analog Input Selection Error	217			

■ Auto-Tuning Errors

Table 6.7 Auto-Tuning Error Displays

HOA Keypad Display	Name	Page	HOA Keypad Display	Name	Page
End3	Rated Current Setting Alarm	219	Er-03	OFF Button Input	220
End4	Adjusted Slip Value Fell Below Lower Limit	219	Er-04	Line-to-Line Resistance Error	220
End5	Resistance Between Lines Error	219	Er-05	No-Load Current Error	220
End7	No-Load Current Alarm	219	Er-08	Rated Slip Error	220
Er-01	Motor Data Error	219	Er-09	Acceleration Error	220
Er-02	Alarm	219	Er-12	Current Detection Error	220

6.4 Fault Detection

6.4 Fault Detection

◆ Fault Displays, Causes, and Possible Solutions

Faults are detected for drive protection, and cause the drive to stop while triggering the fault output terminal TB1 10, 11, and 12. Remove the cause of the fault and manually clear the fault before attempting to run the drive again.

Table 6.8 Detailed Fault Displays, Causes, and Possible Solutions

HOA Keypad Display	Fault Name
bAT	HOA Keypad Battery Voltage Low
Cause	Possible Solution
The HOA keypad battery is low	Replace the HOA keypad battery.
HOA Keypad Display	Fault Name
bUS	Option Communication Error
	<ul style="list-style-type: none"> The connection was lost after establishing initial communication. Only detected when the run command frequency reference is assigned to an option card.
Cause	Possible Solution
No signal was received from the PLC	<ul style="list-style-type: none"> Check for faulty wiring.
Faulty communications wiring or an existing short circuit	<ul style="list-style-type: none"> Correct the wiring. Check for disconnected cables and short circuits and repair as needed.
Communication data error occurred due to noise	<ul style="list-style-type: none"> Check the various options available to minimize the effects of noise. Counteract noise in the control circuit, main circuit, and ground wiring. Ensure that other equipment such as switches or relays do not cause noise. Use surge absorbers if necessary. Use only recommended cables or other shielded line. Ground the shield on the controller side or the drive input power side. Separate all communication wiring from drive power lines.
The option card is damaged	Replace the option card if there are no problems with the wiring and the error continues to occur.
The option card is not properly connected to the drive	<ul style="list-style-type: none"> The connector pins on the option card do not line up properly with the connector pins on the drive. Reinstall the option card.
HOA Keypad Display	Fault Name
CE	MEMOBUS/Modbus Communication Error
	Control data was not received for the CE detection time set to H5-09.
Cause	Possible Solution
Faulty communications wiring or an existing short circuit	<ul style="list-style-type: none"> Check for faulty wiring. Correct the wiring. Check for disconnected cables and short circuits and repair as needed.
Communication data error occurred due to noise	<ul style="list-style-type: none"> Check the various options available to minimize the effects of noise. Counteract noise in the control circuit, main circuit, and ground wiring. Use only recommended cables or other shielded line. Ground the shield on the controller side or the drive input power side. Ensure that other equipment such as switches or relays do not cause noise. Use surge suppressors if required. Separate all communication wiring from drive power lines.
Communications between the bypass controller and the drive have stopped for longer than 2 seconds.	Check the communication cable, terminal CN6 on the bypass board, and terminals R+, R-, S+, and S- on the drive terminal strip. Note: This fault may also occur when the bypass is initialized by setting Z1-01 to 1, 2, or 3. Cycle power on the bypass to clear.
HOA Keypad Display	Fault Name
CoF	Current Offset Fault
Cause	Possible Solution

6.4 Fault Detection

HOA Keypad Display	Fault Name
The drive tried to adjust the current offset value beyond the allowable range. This is due to residual induction current in the motor (e.g., during sudden deceleration or when coasting) when the drive attempted to start the motor.	<ul style="list-style-type: none"> • Create a motor restart sequence that allows enough time for residual induction voltage to dissipate. • Enable Speed Search at start (b3-01 = 1).
The current sensor in the drive is damaged	If the problem continues, replace the control board or the entire drive. Contact Yaskawa or a Yaskawa representative for instructions on replacing the control board.

HOA Keypad Display	Fault Name
CPF00 or CPF01	Control Circuit Error
Cause	Possible Solution
There is a self-diagnostic error in the control circuit	<ul style="list-style-type: none"> • Cycle power to the drive. • If the problem continues, replace the control board or the entire drive. Contact Yaskawa or a Yaskawa representative for instructions on replacing the control board.
Connector on the operator is damaged	Replace the operator.

HOA Keypad Display	Fault Name
CPF02	A/D Conversion Error
Cause	An A/D conversion error or control circuit error occurred.
Cause	Possible Solution
Control circuit is damaged	<ul style="list-style-type: none"> • Cycle power to the drive. • If the problem continues, replace the control board or the entire drive. Contact Yaskawa or a Yaskawa representative for instructions on replacing the control board.

HOA Keypad Display	Fault Name
CPF03	Control Board Connection Error
Cause	Connection error between the control board and the drive
Cause	Possible Solution
There is a connection error	<ul style="list-style-type: none"> • Turn off the power and check the connection between the control board and the drive. • If the problem continues, replace the control board or the entire drive. Contact Yaskawa or a Yaskawa representative for instructions on replacing the control board.
Drive fails to operate properly due to noise interference	<ul style="list-style-type: none"> • Check the various options available to minimize the effects of noise. • Counteract noise in the control circuit, main circuit, and ground wiring. • Use only recommended cables or other shielded line. Ground the shield on the controller side or the drive input power side. • Ensure that other equipment such as switches or relays do not cause noise. Use surge suppressors if required. • Separate all communication wiring from drive power lines.

HOA Keypad Display	Fault Name
CPF06	EEPROM Memory Data Error
Cause	Error in the data saved to EEPROM
Cause	Possible Solution
There is an error in EEPROM control circuit	<ul style="list-style-type: none"> • Turn off the power and check the connection between the control board and the drive. • If the problem continues, replace the control board or the entire drive. Contact Yaskawa or a Yaskawa representative for instructions on replacing the control board.
The power supply was switched off while parameters were being saved to the drive	Reinitialize the drive using parameter A1-03.

HOA Keypad Display	Fault Name
CPF07	Terminal Board Connection Error
CPF08	
Cause	Possible Solution
There is a faulty connection between the terminal board and the control board	<ul style="list-style-type: none"> • Turn off the power and check the connection between the control board and the drive. • If the problem continues, replace the control board or the entire drive. Contact Yaskawa or a Yaskawa representative for instructions on replacing the control board.

6.4 Fault Detection

HOA Keypad Display	Fault Name
CPF20 or CPF21	Control Circuit Error
Cause	Possible Solution
Hardware is damaged	<ul style="list-style-type: none"> • Cycle power to the drive. • If the problem continues, replace the control board or the entire drive. Contact Yaskawa or a Yaskawa representative for instructions on replacing the control board.
HOA Keypad Display	Fault Name
CPF22	Hybrid IC Failure
Cause	Possible Solution
Hybrid IC failure on the power board	<ul style="list-style-type: none"> • Cycle power to the drive. • If the problem continues, replace the power board or the entire drive. Contact Yaskawa or a Yaskawa representative for instructions on replacing the power board.
HOA Keypad Display	Fault Name
CPF23	Control Board Connection Error
	Connection error between the control board and the drive
Cause	Possible Solution
Hardware is damaged	<ul style="list-style-type: none"> • Turn off the power and check the connection between the control board and the drive. • If the problem continues, replace the control board or the entire drive. Contact Yaskawa or a Yaskawa representative for instructions on replacing the control board.
HOA Keypad Display	Fault Name
CPF24	Drive Unit Signal Fault
	The drive capacity cannot be detected correctly (drive capacity is checked when the drive is powered up).
Cause	Possible Solution
Hardware is damaged	If the problem continues, replace the control board or the entire drive. Contact Yaskawa or a Yaskawa representative for instructions on replacing the control board.
HOA Keypad Display	Fault Name
EF0	Option Card External Fault
	An external fault condition is present.
Cause	Possible Solution
An external fault was received from the serial communications network	<ul style="list-style-type: none"> • Remove the cause of the external fault. • Remove the external fault input from the controller. • Verify that the controller program is correct.
An external fault (EF0) digital input became active.	Remove the cause of the external fault.
Faults FB01 to FB09, FB13, or FB14 were declared by the bypass controller.	Remove the cause of the bypass controller fault.
HOA Keypad Display	Fault Name
Err	EEPROM Write Error
	Data cannot be written to the EEPROM
Cause	Possible Solution
Noise has corrupted data while writing to the EEPROM	<ul style="list-style-type: none"> • Press “ENTER” on the HOA keypad. • Correct the parameter setting. • Cycle power to the drive. • If the problem continues, replace the control board or the entire drive. Contact Yaskawa or a Yaskawa representative for instructions on replacing the control board.
Hardware problem	If the problem continues, replace the control board or the entire drive. Contact Yaskawa or a Yaskawa representative for instructions on replacing the control board.
HOA Keypad Display	Fault Name
FAn	Internal Fan Fault
	Fan or magnetic contactor failure

6.4 Fault Detection

HOA Keypad Display	Fault Name
Cause	Possible Solution
Internal cooling fan has malfunctioned	<ul style="list-style-type: none"> • Cycle power to the drive. • Check for fan operation. • Verify the cumulative operation time of the fan with monitor U4-03, and verify the cumulative operation time of the fan maintenance timer with U4-04. • If the cooling fan has exceeded its expected performance life or is damaged in any other way, follow the replacement instructions in the <i>Periodic Inspection & Maintenance</i> chapter.
Fault detected in the internal cooling fan or magnetic contactor to the power supply	<ul style="list-style-type: none"> • Cycle power to the drive. • If the fault continues to occur, replace the power board/gate drive board or the entire drive. • Contact Yaskawa or a Yaskawa representative for instructions on replacing the power board/gate drive board.

HOA Keypad Display	Fault Name
Cause	Possible Solution
FB01	Safety Open ^{<1>} Note: A fault reset is not required. Bypass contactor K3 is opened.
The digital input set to Safety open is open	<ul style="list-style-type: none"> • Install a NC safety circuit between DI-□ and IG-24 on PCB A2 • Install a jumper between DI-2 and IG-24 on PCB A2. Use this method if a safety circuit will be added in the future or is no safety circuit will be used at all.

<1> Parameter Z2-31, Safety Open Message Selection, determines the fault message displayed when FB01 is triggered.

HOA Keypad Display	Fault Name
Cause	Possible Solution
FB02	BAS Interlock Open Time Out Note: A fault reset is required. An EF0 is sent to the drive and bypass contactor K3 is not affected.
	BAS/Damper Interlock Open, Interlock Wait Timer Expired
The digital input set to BAS Interlock is open	<ul style="list-style-type: none"> • Install a NC BAS Interlock Circuit/Damper Interlock between DI-□ and IG-24 on PCB A2 • Install a jumper between DI-2 and IG-24 on PCB A2. Use this method if a safety circuit will be added in the future or is no safety circuit will be used at all. • Verify that the input assigned for the BAS Interlock is active within the timeout period set in Z1-15.

HOA Keypad Display	Fault Name
Cause	Possible Solution
FB03	External Fault Bypass (EFB) Note: A fault reset is required. An EF0 is sent to the drive and drive output contactor K2 and Bypass contactor K3 are opened.
	External fault to bypass set
An external fault (EFB) digital input became active.	Remove the cause of the external fault.
An external fault (EFB) was received from the serial communications network.	<ul style="list-style-type: none"> • Remove the cause of the external fault • Remove the external fault input from the controller. • Verify that the controller program is correct.

HOA Keypad Display	Fault Name
Cause	Possible Solution
FB05	Motor Overload Note: A fault reset is required. An EF0 is sent to the drive and Bypass contactor K3 is opened.
	Motor Overload detected
Load is too heavy	Reduce the load.
Cycle times are too short during acceleration and deceleration.	Increase the acceleration and deceleration times (C1-01 and C1-02).
A general-purpose motor is driven below the rated speed with a high load	<ul style="list-style-type: none"> • Reduce the load. • Increase the speed. • If the motor is supposed to operate at low speeds, either increase the motor capacity or use a motor specifically designed to operate in the desired speed range.

6.4 Fault Detection

HOA Keypad Display	Fault Name
The wrong motor rated current is set to E2-01	<ul style="list-style-type: none"> Check the motor-rated current. Enter the motor rated current to parameter E2-01 as indicated on the motor nameplate.
The maximum output frequency is set incorrectly	Check the E1-03 setting.
Multiple motors are running off the same bypass	Set L1-01 to 0 to disable the motor protection function and then install a thermal relay to each motor.
The electrical thermal protection characteristics and motor overload characteristics do not match.	<ul style="list-style-type: none"> Check the motor characteristics. Correct the type of motor protection that has been selected (L1-01). Install an external thermal relay.
The electrical thermal relay is operating at the wrong level.	<ul style="list-style-type: none"> Check the current rating listed on the motor nameplate. Check the value set for the motor rated current (E2-01)

HOA Keypad Display	Fault Name
FB06	External Motor 1 Overload Note: A fault reset is not required. An EF0 is sent to the drive and bypass Contactor K3 is opened.
	External overload input is active for motor 1
Cause	Possible Solution
Load is too heavy	Reduce the load.
Cycle times are too short during acceleration and deceleration	Increase the acceleration and deceleration times (C1-01 and C1-02).
A general-purpose motor is driven below the rated speed with a high load	<ul style="list-style-type: none"> Reduce the load. Increase the speed. If the motor is supposed to operate at low speeds, either increase the motor capacity or use a motor specifically designed to operate in the desired speed range.

HOA Keypad Display	Fault Name
FB07	External Motor 2 Overload Note: A fault reset is not required. An EF0 is sent to the drive and bypass contactor K3 is opened.
	External overload input is active for motor 2
Cause	Possible Solution
Load is too heavy	Reduce the load.
Cycle times are too short during acceleration and deceleration	Increase the acceleration and deceleration times (C1-01 and C1-02).
A general-purpose motor is driven below the rated speed with a high load	<ul style="list-style-type: none"> Reduce the load. Increase the speed. If the motor is supposed to operate at low speeds, either increase the motor capacity or use a motor specifically designed to operate in the desired speed range.

HOA Keypad Display	Fault Name
FB08	Phase Loss Brownout Note: A fault reset is required. An EF0 is sent to the drive and drive output contactor K2 and Bypass contactor K3 are opened.
	The contactor coil voltage was continuously detected below the configured brownout voltage level for the configured brownout time.
Cause	Possible Solution
Input power is too low.	Verify input power is sufficient to power the bypass.
Settings for brownout are incorrect.	Verify Z1-27 (Brownout Voltage Level) and Z1-28 (Brownout Time) are set properly.

HOA Keypad Display	Fault Name
FB09	Phase Loss Blackout Note: A fault reset is required. An EF0 is sent to the drive and drive output contactor K2 and Bypass contactor K3 are opened.
	The contactor coil voltage was detected below the configured blackout voltage level.
Cause	Possible Solution
Input power is too low or has dipped too low.	Verify input power is sufficient to power the bypass.
Settings for blackout are incorrect.	Verify Z1-29 (Blackout Voltage Level) is set properly.

6.4 Fault Detection

HOA Keypad Display	Fault Name
FB10	No Drive Comms Note: A fault reset is required. An EF0 is not sent to the drive and Bypass contactor K3 is not affected.
	An unexpected loss of communication to the drive lasting more than 15 seconds has been detected.
Cause	Possible Solution
The cable between the bypass controller and the drive is disconnected or has been damaged.	Verify the cable between the bypass controller board (A2) connector CN6 to drive terminal TB4 is connected at both ends and is not damaged.
The bypass controller circuit has become defective.	Replace the bypass control board.
The drive circuitry has become defective.	Replace the drive.

HOA Keypad Display	Fault Name
FB11	Bypass Board Hardware Error Note: A fault reset is not required. An EF0 is not sent to the drive. The drive output contactor K2 and and bypass contactor K3 are opened.
	The bypass control board failed.
Cause	Possible Solution
An unexpected event occurred with the bypass controller circuitry.	Replace the bypass controller board.

HOA Keypad Display	Fault Name
FB12	Option Board Comms Note: Fault reset will not remove the fault.
	Loss of communication to the communication option board. This fault can only occur if the bypass is programmed to be controlled by the option card (one or more of the following): Z1-07 = 3, Z1-08 = 2, Z1-38 = 2, or Z1-39 = 2.
Cause	Possible Solution
Communication between the option card and bypass board have timed out and communication has stopped	Ensure the option card is mounted properly. Replace the option card and cycle power to the bypass board.

HOA Keypad Display	Fault Name
FB13	Loss of Load Note: A fault reset is required. An EF0 fault is sent to the drive and drive output contactor K2 and bypass contactor K3 are opened.
	The conditions were such that it appears the motor has become disconnected from the load.
Cause	Possible Solution
The motor is disconnect from the drive	Check the continuity between the drive/bypass and the motor.
The load has been disconnected from the motor	Check the belt/coupling between the motor and the load
The Loss of Load settings are not proper.	Review and adjust the Loss of Load parameters Z1-31 to Z1-36.

HOA Keypad Display	Fault Name
FB14	Serial Communications Fault Note: A fault reset is required. Behavior of the drive and the contactors during an FB14 is determined by parameter Z3-05.
	Serial communications timeout
Cause	Possible Solution
Faulty communication wiring or an existing short circuit.	<ul style="list-style-type: none"> Check for faulty serial communication wiring Correct the wiring Check for disconnected cables and short circuits and repair as needed.
Communication data error occurred due to noise.	<ul style="list-style-type: none"> Check the various options available to minimize the effects of noise Counteract noise in the control circuit, main circuit, and ground wiring Use only recommended cables or other shielded line. Ground the shield on the controller side Ensure that other equipment such as switches or relays do not cause noise. Use surge suppressors if required Separate all communication wiring from power lines. When the lines must cross, make the lines cross at a right angle to minimize noise coupling.

6.4 Fault Detection

HOA Keypad Display	Fault Name
Communication Error timeout time not set properly.	Verify the setting of the serial communications fault time (Z3-06) is set properly.
Controller is not sending data soon enough to stop the timeout.	Verify the scan rate in the controller that is communicating with the bypass controller is proper. Adjust as necessary.

HOA Keypad Display	Fault Name
FB15 <I>	Input Phase Loss
Cause	Possible Solutions
Bypass Mode current unbalance condition exceeded the unbalance level limit set by Z1-50 for the amount of time specified in Z1-51.	<ul style="list-style-type: none"> • Check input wiring including fuses, breakers, and connections upstream from the bypass. • Check the motor wiring and connections.

<I> Available in bypass controller software versions VST800298 and later.

HOA Keypad Display	Fault Name
FB16 <I>	Input Phase Rotation
Cause	Possible Solution
Incorrect phase rotation while Z1-52 is set to 2 in Bypass Mode.	Check the sequence (phase rotation) of the input wiring to the bypass package.

<I> Available in bypass controller software versions VST800298 and later.

HOA Keypad Display	Fault Name
Fn1	External Fan Fault
	External fan failure
Cause	Possible Solution
External cooling fan has malfunctioned	<ul style="list-style-type: none"> • Cycle power to the drive. • Check for fan operation. • Verify the cumulative operation time of the fan with monitor U4-03, and verify the cumulative operation time of the fan maintenance timer with U4-04. • If the cooling fan has exceeded its expected performance life or is damaged in any other way, follow the replacement instructions in the <i>Periodic Inspection & Maintenance</i> chapter.

HOA Keypad Display	Fault Name
FbH	Excessive PI Feedback
	PI feedback input is greater than the level set to b5-36 for longer than the time set to b5-37. Set b5-12 to 2 or 5 to enable fault detection.
Cause	Possible Solution
Parameters are set inappropriately	Check b5-36 and b5-37 settings.
Incorrect PI feedback wiring	Correct the wiring.
There is a problem with the feedback sensor	<ul style="list-style-type: none"> • Check the sensor on the control side. • Replace the sensor if damaged.

HOA Keypad Display	Fault Name
FbL	PI Feedback Loss
	This fault occurs when PI feedback loss detection is programmed to trigger a fault (b5-12 = 2) and the PI feedback level is below the detection level set to b5-13 for longer than the time set to b5-14.
Cause	Possible Solution
Parameters are set inappropriately	Check b5-13 and b5-14 settings.
Incorrect PI feedback wiring	Correct the wiring.
There is a problem with the feedback sensor	<ul style="list-style-type: none"> • Check the sensor on the control side. • Replace the sensor if damaged.

HOA Keypad Display	Fault Name
GF	Ground Fault
	<ul style="list-style-type: none"> • A current short to ground exceeded 50% of rated current on the output side of the drive. • Setting L8-09 to 1 enables ground fault detection in models D074 to D273 and B052 to B302.
Cause	Possible Solution

6.4 Fault Detection

HOA Keypad Display	Fault Name
Motor insulation is damaged	<ul style="list-style-type: none"> Check the insulation resistance of the motor. Replace the motor.
A damaged motor cable is creating a short circuit	<ul style="list-style-type: none"> Check the motor cable. Remove the short circuit and reapply power to the drive Check the resistance between the cable and the ground terminal ⊕. Replace the cable.
Excessive leakage current at the drive output	<ul style="list-style-type: none"> Reduce the carrier frequency. Reduce the amount of stray capacitance.
The drive started to run during a current offset fault or while coasting to a stop	Set b3-01 to 1 to enable Speed Search at Start.
Hardware problem	If the problem continues, replace the control board or the entire drive. Contact Yaskawa or a Yaskawa representative for instructions on replacing the control board.

HOA Keypad Display	Fault Name
LF	Output Phase Loss
	<ul style="list-style-type: none"> Phase loss on the output side of the drive. Setting L8-07 to 1 or 2 enables Phase Loss Detection.
Cause	Possible Solution
The output cable is disconnected	<ul style="list-style-type: none"> Check for wiring errors and properly connect the output cable. Correct the wiring.
The motor winding is damaged	<ul style="list-style-type: none"> Check the resistance between motor lines. Replace the motor if the winding is damaged.
The output terminal is loose	<ul style="list-style-type: none"> Apply the tightening torque specified in this manual to fasten the terminals. <i>Refer to Wire Gauge and Tightening Torque Specifications on page 43</i> for details.
The rated current of the motor being used is less than 5% of the drive rated current	Check the drive and motor capacities.
An output transistor is damaged	If the problem continues, replace the control board or the entire drive. Contact Yaskawa or a Yaskawa representative for instructions on replacing the control board.
A single-phase motor is being used	The drive cannot operate a single phase motor.

HOA Keypad Display	Fault Name
LF2	Output Current Imbalance
	One or more of the phases in the output current are lost.
Cause	Possible Solution
Phase loss has occurred on the output side of the drive	<ul style="list-style-type: none"> Check for faulty wiring or poor connections on the output side of the drive. Correct the wiring.
Terminal wires are loose on the output side of the drive	Apply the tightening torque specified in this manual to fasten the terminals. <i>Refer to Wire Gauge and Tightening Torque Specifications on page 43</i> for details.
The output circuit is damaged	If the problem continues, replace the control board or the entire drive. Contact Yaskawa or a Yaskawa representative for instructions on replacing the control board.
Motor impedance or motor phases are uneven	<ul style="list-style-type: none"> Measure the line-to-line resistance for each motor phase. Ensure all values match. Replace the motor.

HOA Keypad Display	Fault Name
nSE	Node Setup Error
	A terminal assigned to the node setup function closed during run.
Cause	Possible Solution
The node setup terminal closed during run	Stop the drive when using the node setup function.
A Run command was issued while the node setup function was active	

HOA Keypad Display	Fault Name
oC	Overcurrent
	Drive sensors detected an output current greater than the specified overcurrent level.
Cause	Possible Solution

6.4 Fault Detection

HOA Keypad Display	Fault Name
The motor has been damaged due to overheating or the motor insulation is damaged	<ul style="list-style-type: none"> Check the insulation resistance. Replace the motor.
One of the motor cables has shorted out or there is a grounding problem	<ul style="list-style-type: none"> Check the motor cables. Remove the short circuit and reapply power to the drive.
	<ul style="list-style-type: none"> Check the resistance between the motor cables and the ground terminal ⊕. Replace damaged cables.
The load is too heavy	<ul style="list-style-type: none"> Measure the current flowing into the motor. Replace the drive with a larger capacity drive if the current value exceeds the rated current. Determine if there is sudden fluctuation in the current level. Reduce the load to avoid sudden changes in the current level or switch to a larger drive.
The acceleration or deceleration times are too short	<p>Calculate the torque needed during acceleration relative to the load inertia and the specified acceleration time. If it is not possible to set the proper amount of torque, make the following changes:</p> <ul style="list-style-type: none"> Increase the acceleration time (C1-01) Increase the S-curve characteristics (C2-01 and C2-02) Increase the capacity of the drive.
The drive is attempting to operate a specialized motor or a motor larger than the maximum size allowed	<ul style="list-style-type: none"> Check the motor capacity. Ensure that the rated capacity of the drive is greater than or equal to the capacity rating found on the motor nameplate.
Magnetic contactor (MC) on the output side of the drive has turned on or off	Set up the operation sequence so the MC does not trip while the drive is outputting current.
V/f setting is not operating as expected	<ul style="list-style-type: none"> Check the ratios between the voltage and frequency. Lower the voltage if it is too high relative to the frequency.
Excessive torque compensation	<ul style="list-style-type: none"> Check the amount of torque compensation. Reduce the torque compensation gain (C4-01) until there is no speed loss and less current.
Drive fails to operate properly due to noise interference	<ul style="list-style-type: none"> Review the possible solutions provided for handling noise interference. Review the section on handling noise interference on page 227 and check the control circuit lines, main circuit lines, and ground wiring.
Overexcitation gain is set too high	<ul style="list-style-type: none"> Check if the fault occurs simultaneously with overexcitation function operation. Consider motor flux saturation and reduce the value of n3-13 (Overexcitation Deceleration Gain).
Run command was applied while motor was coasting	Set b3-01 to 1 to enable Speed Search at Start.
The rated output current of the drive is too small	Use a larger drive.

HOA Keypad Display	Fault Name
oFA00	Option Card Connection Error at Option Port CN5
	Option compatibility error
Cause	Possible Solution
The option card installed into port CN5 is incompatible with the drive	Check if the drive supports the option card to be installed. Contact Yaskawa for assistance.

HOA Keypad Display	Fault Name
oH	Heatsink Overheat
	The heatsink temperature exceeded the overheat pre-alarm level set to L8-02. The default value for L8-02 is determined by drive capacity (o2-04).
Cause	Possible Solution
Surrounding temperature is too high	<ul style="list-style-type: none"> Check the temperature surrounding the drive. Verify temperature is within drive specifications. Improve the air circulation within the enclosure panel. Install a fan or air conditioner to cool the surrounding area. Remove anything near the drive that might be producing excessive heat.
Load is too heavy	<ul style="list-style-type: none"> Measure the output current. Decrease the load. Lower the carrier frequency (C6-02).
External cooling fan is stopped	<ul style="list-style-type: none"> Replace the cooling fan. After replacing the cooling fan, set parameter o4-03 to 0 to reset the cooling fan maintenance.

6.4 Fault Detection

HOA Keypad Display	Fault Name
oH1	Overheat 1 (Heatsink Overheat)
	The heatsink temperature exceeded the drive overheat level. Overheat level is determined by drive capacity (o2-04).
Cause	Possible Solution
Surrounding temperature is too high	<ul style="list-style-type: none"> Check the temperature surrounding the drive. Improve the air circulation within the enclosure panel. Install a fan or air conditioner to cool the surrounding area. Remove anything near the drive that might be producing excessive heat.
Load is too heavy	<ul style="list-style-type: none"> Measure the output current. Lower the carrier frequency (C6-02). Reduce the load.

HOA Keypad Display	Fault Name
oH3	Motor Overheat Alarm (PTC Input)
	<ul style="list-style-type: none"> The motor overheat signal to analog input terminals A1, A2, or A3 exceeded the alarm detection level. Detection requires setting multi-function analog inputs H3-02, H3-10, or H3-06 to E.
Cause	Possible Solution
Motor has overheated	<ul style="list-style-type: none"> Check the size of the load, the accel/decel times, and the cycle times. Decrease the load. Increase the acceleration and deceleration times (C1-01 and C1-02).
	Adjust the preset V/f pattern. Try setting E1-03 to 6.
	<ul style="list-style-type: none"> Check the motor rated current. Enter the motor rated current to parameter E2-01 as indicated on the motor nameplate. Ensure the motor cooling system is operating normally. Repair or replace the motor cooling system.

HOA Keypad Display	Fault Name
oH4	Motor Overheat Fault (PTC Input)
	<ul style="list-style-type: none"> The motor overheat signal to analog input terminals A1, A2, or A3 exceeded the alarm detection level. Detection requires setting multi-function analog inputs H3-02, H3-10, or H3-06 to E.
Cause	Possible Solution
Motor has overheated	<ul style="list-style-type: none"> Check the size of the load, the accel/decel times, and the cycle times. Decrease the load. Increase the acceleration and deceleration times (C1-01 and C1-02).
	Adjust the preset V/f pattern. Set E1-03 to 6.
	<ul style="list-style-type: none"> Check the motor rated current. Enter the motor rated current to parameter E2-01 as indicated on the motor nameplate. Ensure the motor cooling system is operating normally. Repair or replace the motor cooling system.

HOA Keypad Display	Fault Name
oL1	Motor Overload
	The electronic motor overload protection tripped
Cause	Possible Solution
Load is too heavy	Reduce the load.
Cycle times are too short during acceleration and deceleration	Increase the acceleration and deceleration times (C1-01 and C1-02).
A general-purpose motor is driven below the rated speed with a high load	<ul style="list-style-type: none"> Reduce the load. Increase the speed. If the motor is supposed to operate at low speeds, either increase the motor capacity or use a motor specifically designed to operate in the desired speed range.
The output voltage is too high	<ul style="list-style-type: none"> Adjust the V/f pattern. Set E1-03 to 6. Do not set E1-08 and E1-10 too low. This reduces load tolerance at low speeds.

6.4 Fault Detection

HOA Keypad Display	Fault Name
The wrong motor rated current is set to E2-01	<ul style="list-style-type: none"> Check the motor-rated current. Enter the motor rated current to parameter E2-01 as indicated on the motor nameplate.
The maximum output frequency is set incorrectly	<ul style="list-style-type: none"> Check the rated frequency indicated on the motor nameplate. Set E1-03 to a V/f pattern matching the application.
Multiple motors are running off the same drive	Set L1-01 to 0 to disable the motor protection function and then install a thermal relay to each motor.
The electrical thermal protection characteristics and motor overload characteristics do not match	<ul style="list-style-type: none"> Check the motor characteristics. Correct the type of motor protection that has been selected (L1-01). Install an external thermal relay.
The electrical thermal relay is operating at the wrong level	<ul style="list-style-type: none"> Check the current rating listed on the motor nameplate. Check the value set for the motor rated current (E2-01).
Motor overheated by overexcitation operation	<ul style="list-style-type: none"> Overexcitation increases the motor loss and the motor temperature. Excessive duration of overexcitation may cause motor damage. Prevent excessive overexcitation operation or apply proper cooling to the motor. Reduce the excitation deceleration gain (n3-13). Set L3-04 (Stall Prevention during Deceleration) to a value other than 4.
Parameters related to Speed Search are set incorrectly	<ul style="list-style-type: none"> Check values set to Speed Search related parameters. Adjust the Speed Search current and Speed Search deceleration times (b3-02 and b3-03 respectively).
Output current fluctuation due to input phase loss	Check the power supply for phase loss.

HOA Keypad Display	Fault Name
oL2	Drive Overload
	The thermal sensor of the drive triggered overload protection.
Cause	Possible Solution
Load is too heavy	Reduce the load.
Acceleration or deceleration time is too short	Increase the settings for the acceleration and deceleration times (C1-01 and C1-02).
The output voltage is too high	<ul style="list-style-type: none"> Set E1-03 to a V/f pattern matching the application. Do not lower E1-08 and E1-10 excessively. This reduces load tolerance at low speeds.
Drive capacity is too small	Replace the drive with a larger model.
Overload occurred when operating at low speeds	<ul style="list-style-type: none"> Reduce the load when operating at low speeds. Replace the drive with a model that is one frame size larger. Lower the carrier frequency (C6-02).
Excessive torque compensation	Reduce the torque compensation gain in parameter C4-01 until there is no speed loss but less current.
Parameters related to Speed Search are set incorrectly	<ul style="list-style-type: none"> Check the settings for all Speed Search related parameters. Adjust the current used during Speed Search (b3-03) and the Speed Search deceleration time (b3-02). After Auto-Tuning, set b3-24 to 1 to enable Speed Estimation Speed Search.
Output current fluctuation due to input phase loss	Check the power supply for phase loss.

HOA Keypad Display	Fault Name
oL3	Overtorque Detection 1
	The current has exceeded the value set for torque detection (L6-02) for longer than the allowable time (L6-03).
Cause	Possible Solution
Parameter settings are not appropriate for the load	Check L6-02 and L6-03 settings.
Fault on the machine side (e.g., machine is locked up)	Check the status of the load. Remove the cause of the fault.

HOA Keypad Display	Fault Name
oL7	High Slip Braking oL
	The output frequency stayed constant for longer than the time set to n3-04 during High Slip Braking.
Cause	Possible Solution

6.4 Fault Detection

HOA Keypad Display	Fault Name
Excessive load inertia	Reduce deceleration time in parameter C1-02 for applications that do not use High Slip Braking.
Motor is driven by the load	
Something on the load side is restricting deceleration	
The overload time during High Slip Braking is too short	<ul style="list-style-type: none"> • Increase parameter n3-04 (High-slip Braking Overload Time). • Install a thermal relay and increase the setting of n3-04 to maximum value.

HOA Keypad Display	Fault Name
oPr	HOA Keypad Connection Fault
	The HOA keypad has been disconnected from the drive. Note: An oPr fault will occur when The Run command is assigned to the keypad (Z1-07 = 0 and OFF mode has been selected).
Cause	Possible Solution
External operator is not properly connected to the drive	<ul style="list-style-type: none"> • Check the connection between the operator and the drive. • Replace the cable if damaged. • Turn off the drive input power and disconnect the operator. Reconnect the operator and reapply drive input power.

HOA Keypad Display	Fault Name
ov	Overvoltage
	Voltage in the DC bus has exceeded the overvoltage detection level. <ul style="list-style-type: none"> • For 208 V Bypass Drives: approximately 410 V • For 480 V Bypass Drives: approximately 820 V (740 V when E1-01 is less than 400)
Cause	Possible Solution
Deceleration time is too short and regenerative energy is flowing from the motor into the drive	<ul style="list-style-type: none"> • Increase the deceleration time (C1-02). • Set L3-04 to 1 to enable stall prevention during deceleration. Stall Prevention is enabled as the default setting.
Fast acceleration time causes the motor to overshoot the speed reference	<ul style="list-style-type: none"> • Check if sudden drive acceleration triggers an overvoltage alarm. • Increase the acceleration time. • Use longer S-curve acceleration and deceleration times. • Enable the Overvoltage Suppression function (L3-11 = 1). • Lengthen the S-curve at acceleration end.
Ground fault in the output circuit causes the DC bus capacitor to overcharge	<ul style="list-style-type: none"> • Check the motor wiring for ground faults. • Correct grounding shorts and reapply power.
Improper parameters related to Speed Search (including Speed Search after a momentary power loss and after a fault restart)	<ul style="list-style-type: none"> • Check the settings for Speed Search-related parameters. • Enable Speed Search restart function (b3-19 greater than or equal to 1 to 10). • Adjust the current level during Speed Search and the deceleration time (b3-02 and b3-03 respectively). • Perform Stationary Auto-Tuning for line-to-line resistance and then set b3-14 to 1 to enable Speed Estimation Speed Search.
Drive input power voltage is too high	<ul style="list-style-type: none"> • Check the voltage. • Lower drive input power voltage within the limits listed in the specifications.
Drive fails to operate properly due to noise interference	<ul style="list-style-type: none"> • Review the list of possible solutions provided for controlling noise. • Review the section on handling noise interference on page 227 and check the control circuit lines, main circuit lines, and ground wiring.
Load inertia is set incorrectly	<ul style="list-style-type: none"> • Check the load inertia settings when using KEB, overvoltage suppression, or Stall Prevention during deceleration. • Adjust the load inertia ratio in L3-25 to better match the load.
Motor hunting occurs	<ul style="list-style-type: none"> • Adjust the parameters that control hunting. • Set the gain for Hunting Prevention (n1-02).

HOA Keypad Display	Fault Name
PF	Input Phase Loss
	Drive input power has an open phase or has a large imbalance of voltage between phases. Detected when L8-05 is set 1 (enabled).
Cause	Possible Solution

6.4 Fault Detection

HOA Keypad Display	Fault Name
There is phase loss in the drive input power	<ul style="list-style-type: none"> Check for wiring errors in the main circuit drive input power. Correct the wiring.
There is loose wiring in the drive input power terminals	<ul style="list-style-type: none"> Ensure the terminals are tightened properly. Apply the tightening torque as specified in this manual. <i>Refer to Wire Gauge and Tightening Torque Specifications on page 43</i> for details.
There is excessive fluctuation in the drive input power voltage	<ul style="list-style-type: none"> Check the voltage from the drive input power. Review the possible solutions for stabilizing the drive input power.
There is poor balance between voltage phases	Stabilize drive input power or disable phase loss detection.
The main circuit capacitors are worn	<ul style="list-style-type: none"> Check the maintenance time for the capacitors (U4-05). Replace the capacitor if U4-05 is greater than 90%. For instructions on replacing the capacitor, contact Yaskawa or a Yaskawa representative.
	Check for problems with the drive input power. If drive input power appears normal but the alarm continues to occur, replace either the control board or the entire drive. For instructions on replacing the control board, contact Yaskawa or a Yaskawa representative.

HOA Keypad Display	Fault Name
SEr	Too Many Speed Search Restarts
	The number of Speed Search restarts exceeded the value set to b3-19.
Cause	Possible Solution
Parameters related to Speed Search are set to the wrong values	<ul style="list-style-type: none"> Reduce the detection compensation gain during Speed Search (b3-10). Increase the current level when attempting Speed Search (b3-17). Increase the detection time during Speed Search (b3-18).
The motor is coasting in the opposite direction of the Run command	Set b3-14 to 1 to enable Bi-Directional Speed Search.

HOA Keypad Display	Fault Name
STo	Motor Pull Out or Step Out Detection
	Motor pull out or step out has occurred. Motor has exceeded its pull-out torque.
Cause	Possible Solution
Load is too heavy	<ul style="list-style-type: none"> Increase the pull-in current during accel/decel (n8-51). Reduce the load. Increase the motor or drive capacity.
Acceleration and deceleration times are too short	<ul style="list-style-type: none"> Increase the acceleration and deceleration times (C1-01 and C1-02). Increase the S-curve acceleration and deceleration times (C2-01).

HOA Keypad Display	Fault Name
TdE	Time Data Error
Cause	Possible Solution
An error has occurred in the Real-Clock Time function of the HOA keypad	Replace the HOA keypad. For instructions on replacing the HOA keypad, contact Yaskawa or your nearest sales representative.
A communication error has occurred with the Real-Clock Time function of the HOA keypad	

HOA Keypad Display	Fault Name
TIM	Time Not Set
Cause	Possible Solution
The time for the HOA keypad has not been set	Set the time for the HOA keypad.
The HOA keypad battery is low or the battery has been replaced	Replace the HOA keypad battery and set the current time.
An error has occurred in the Real-Time Clock function of the HOA keypad	Replace the HOA keypad. For instructions on replacing the HOA keypad, contact Yaskawa or your nearest sales representative.

HOA Keypad Display	Fault Name
UL3	Undertorque Detection 1
	The current has fallen below the minimum value set for torque detection (L6-02) for longer than the allowable time (L6-03).
Cause	Possible Solution

6.4 Fault Detection

HOA Keypad Display	Fault Name
Parameter settings are not appropriate for the load	Check the settings of parameters L6-02 and L6-03.
There is a fault on the machine side	Check the load for any problems.

HOA Keypad Display	Fault Name
UL6	Motor Underload The weight of the load has fallen below the underload curve defined in L6-14.
Cause	Possible Solution
The output current has fallen below the motor underload curve defined in L6-14 for longer than the time set to L6-03	Adjust the value set to L6-14 so that output current remains above the motor underload curve during normal operation.

HOA Keypad Display	Fault Name
Uv1	DC Bus Undervoltage Voltage in the DC bus fell below the undervoltage detection level (L2-05). • For 208 V Bypass Drives: approximately 190 V • For 480 V Bypass Drives: approximately 440 V The fault is output only if L2-01 is set to 0 or 1 and the DC bus voltage has fallen below the level set to L2-05 for longer than the time set to L2-02 <1>.
Cause	Possible Solution
Input power phase loss	<ul style="list-style-type: none"> The main circuit drive input power is wired incorrectly. Correct the wiring.
One of the drive input power wiring terminals is loose	<ul style="list-style-type: none"> Ensure there are no loose terminals. Apply the tightening torque specified in this manual to fasten the terminals. <i>Refer to Wire Gauge and Tightening Torque Specifications on page 43</i> for details.
There is a problem with the voltage from the drive input power	<ul style="list-style-type: none"> Check the voltage. Correct the voltage to be within the range listed in drive input power specifications. If there is no problem with the power supply to the main circuit, check for problems with the main circuit magnetic contactor.
The power has been interrupted	Correct the drive input power.
The main circuit capacitors are worn	<ul style="list-style-type: none"> Check the maintenance time for the capacitors (U4-05). Replace either the control board or the entire drive if U4-05 exceeds 90%. For instructions on replacing the control board, contact Yaskawa or a Yaskawa representative.
The relay or contactor on the soft-charge bypass circuit is damaged	<ul style="list-style-type: none"> Cycle power to the drive and see if the fault reoccurs. If the problem continues, replace either the control board or the entire drive. For instructions on replacing the control board, contact Yaskawa or a Yaskawa representative. Check monitor U4-06 for the performance life of the soft-charge bypass. Replace either the control board or the entire drive if U4-06 exceeds 90%. For instructions on replacing the control board, contact Yaskawa or a Yaskawa representative.

<1> Details on this function can be found in the standard P1000 Technical Manual (SIEPYAIP1U01) at www.yaskawa.com.

HOA Keypad Display	Fault Name
Uv2	Control Power Supply Voltage Fault Voltage is too low for the control drive input power.
Cause	Possible Solution
Internal circuitry is damaged	<ul style="list-style-type: none"> Cycle power to the drive. Check if the fault reoccurs. If the problem continues, replace either the control board or the entire drive. For instructions on replacing the control board, contact Yaskawa or a Yaskawa representative.

HOA Keypad Display	Fault Name
Uv3	Undervoltage 3 (Soft-Charge Circuit Fault) The soft-charge bypass circuit failed.
Cause	Possible Solution

6.4 Fault Detection

HOA Keypad Display	Fault Name
The relay or contactor on the soft-charge bypass circuit is damaged	<ul style="list-style-type: none"> • Cycle power to the drive and see if the fault reoccurs. • If the problem continues, replace either the control board or the entire drive. For instructions on replacing the control board, contact Yaskawa or a Yaskawa representative. • Check monitor U4-06 for the performance life of the soft-charge bypass. • Replace either the control board or the entire drive if U4-06 exceeds 90%. For instructions on replacing the control board, contact Yaskawa or a Yaskawa representative.
HOA Keypad Display	Fault Name
voF	Output Voltage Detection Fault
	Problem detected with the voltage on the output side of the drive.
Cause	Possible Solution
Hardware is damaged	Replace the control board or the entire drive. For instructions on replacing the control board, contact Yaskawa or a Yaskawa representative.

6.5 Alarm Detection

◆ Alarm Codes, Causes, and Possible Solutions

Alarms are drive protection functions that do not necessarily cause the drive to stop. Once the cause of an alarm is removed, the drive will return to the same status it was before the alarm occurred.

When an alarm has been triggered, the ALM light on the HOA keypad display blinks and the alarm code display flashes. If a multi-function output is set for an alarm (H2-□□ = 10), that output terminal will be triggered^{<1>}.

Note: If a multi-function output is set to close when an alarm occurs (H2-□□ = 10), it will also close when maintenance periods are reached, triggering alarms LT-1 through LT-4 (triggered only if H2-□□ = 2F^{<1>}).

<1> Details on this function can be found in the standard P1000 Technical Manual (SIEPYAIP1U01) at www.yaskawa.com.

Table 6.9 Detailed Alarm Codes, Causes, and Possible Solutions

HOA Keypad Display	Fault Name
AL02	BAS Interlock Open
Cause	Possible Solution
The digital input set to Bas interlock is open	Check to see if the damper is functioning properly. The damper may be in the process of opening and the end switch may not have closed.
HOA Keypad Display	Fault Name
AL03	Smoke Purge in Bypass Note: Also referred to as “Fireman's Override” (Bypass).
Cause	Possible Solution
Smoke Purge Bypass input is activated	This is typically an intentional emergency run state. Check the digital input settings (Z2-□□) to determine which is set to 25. Then check to the physical digital input terminal DI-□□ to determine why it is closed.
HOA Keypad Display	Fault Name
AL04	Smoke Purge in Drive Note: Also referred to as “Fireman's Override” (Drive).
Cause	Possible Solution
Smoke Purge Drive input is activated	This is typically an intentional emergency run state. Check the digital input settings (Z2-□□) to determine which is set to 25. Then check to the physical digital input terminal DI-□□ to determine why it is closed.
HOA Keypad Display	Fault Name
AL09	Run Active during Restart Delay
Cause	Possible Solution
Drive run command is asserted during the restart delay.	This is not a fault condition, just informative to show why the drive is not running. If the run command to the drive is removed, the AL09 alarm will not be shown.
HOA Keypad Display	Fault Name
AL13	Loss of Load
Cause	Possible Solution
The conditions were such that it appears that the motor has been disconnected from the load.	Replace the belt or coupling between the motor and the load. In the event of a false detection, review parameters Z1-27 to Z1-32 and set them to more appropriate values.
HOA Keypad Display	Fault Name
AL14	Serial Comm Fault
Cause	Possible Solution
Faulty communication wiring or an existing short circuit.	<ul style="list-style-type: none"> • Check for faulty serial communication wiring • Correct the wiring • Check for disconnected cables and short circuits and repair as needed.

6.5 Alarm Detection

Communication data error occurred due to noise.	<ul style="list-style-type: none"> • Check the various options available to minimize the effects of noise • Counteract noise in the control circuit, main circuit, and ground wiring • Use only recommended cables or other shielded line. Ground the shield on the controller side • Ensure that other equipment such as switches or relays do not cause noise. Use surge suppressors if required • Separate all communication wiring from power lines. When the lines must cross, make the lines cross at a right angle to minimize noise coupling.
Communication Error timeout time not set properly.	Verify the setting of the serial communications fault time (Z3-06) is set properly.
Controller is not sending data soon enough to stop the timeout.	Verify the scan rate in the controller that is communicating with the bypass controller is proper. Adjust as necessary.

HOA Keypad Display	Minor Fault Name
AL16 <1>	Input Phase Rotation
Cause	Possible Solution
Incorrect phase rotation while Z1-52 is set to 1 in Bypass Mode.	Check the sequence (phase rotation) of the input wiring to the bypass package.

<1> Available in bypass controller software versions VST800298 and later.

Table 6.10 Alarm Codes, Causes, and Possible Solutions

HOA Keypad Display	Minor Fault Name
bb	Baseblock
	Drive output interrupted as indicated by an external baseblock signal.
Cause	Possible Solutions
External baseblock signal was entered via one of the multi-function input terminals (S1 to S7)	Check external sequence and baseblock signal input timing.

HOA Keypad Display	Minor Fault Name
bb	Baseblock
	Drive output interrupted as indicated by an external baseblock signal.
Cause	Possible Solutions
External baseblock signal was entered via one of the multi-function input terminals (S1 to S7)	Check external sequence and baseblock signal input timing.
Connection is broken or master controller stopped communicating	<ul style="list-style-type: none"> • Check for faulty wiring. • Correct the wiring. • Check for disconnected cables and short circuits. Repair as needed.

HOA Keypad Display	Minor Fault Name
bUS	Option Communication Error
	<ul style="list-style-type: none"> • The connection was lost after initial communication was established. • Assign a Run command frequency reference to the option.
Cause	Possible Solutions
Connection is broken or master controller stopped communicating	<ul style="list-style-type: none"> • Check for faulty wiring. • Correct the wiring. • Check for disconnected cables and short circuits. Repair as needed.
Option is damaged	If there are no problems with the wiring and the fault continues to occur, replace the option.
The option is not properly connected to the drive	<ul style="list-style-type: none"> • The connector pins on the option are not properly lined up with the connector pins on the drive. • Reinstall the option.
A data error occurred due to noise	<ul style="list-style-type: none"> • Check options available to minimize the effects of noise. • Take steps to counteract noise in the control circuit wiring, main circuit lines and ground wiring. • Try to reduce noise on the controller side. • Use surge absorbers on magnetic contactors or other equipment causing the disturbance. • Use recommended cables or some other type of shielded line. Ground the shield to the controller side or on the input power side. • Separate the wiring for communication devices from the drive input power lines.

6.5 Alarm Detection

HOA Keypad Display	Minor Fault Name
CALL	Serial Communication Transmission Error Communication has not yet been established.
Cause	Possible Solutions
Communications wiring is faulty, there is a short circuit, or something is not connected properly	<ul style="list-style-type: none"> Check for wiring errors. Correct the wiring. Check for disconnected cables and short circuits. Repair as needed.
Programming error on the master side	Check communications at start-up and correct programming errors.
Communications circuitry is damaged	<ul style="list-style-type: none"> Perform a self-diagnostics check. If the problem continues, replace either the control board or the entire drive. For instructions on replacing the control board, contact Yaskawa or your nearest sales representative.
Termination resistor setting is incorrect	Install a termination resistor at both ends of a communication line. Set the internal termination resistor switch correctly on slave drives. Place DIP switch S2 to the ON position.

HOA Keypad Display	Minor Fault Name
CE	MEMOBUS/Modbus Communication Error Control data was not received correctly for two seconds.
Cause	Possible Solutions
A data error occurred due to noise	<ul style="list-style-type: none"> Check options available to minimize the effects of noise. Take steps to counteract noise in the control circuit wiring, main circuit lines, and ground wiring. Reduce noise on the controller side. Use surge absorbers for the magnetic contactors or other components that may be causing the disturbance. Use only recommended shielded line. Ground the shield on the controller side or on the drive input power side. Separate all wiring for communication devices from drive input power lines.
Communication protocol is incompatible	<ul style="list-style-type: none"> Check the Z3 parameter settings and the protocol setting in the controller. Ensure settings are compatible.
The CE detection time (H5-09) is set shorter than the time required for a communication cycle to take place	<ul style="list-style-type: none"> Check the PLC. Change the software settings in the PLC. Set a longer CE detection time using parameter Z3-06.
Incompatible PLC software settings or there is a hardware problem	<ul style="list-style-type: none"> Check the PLC. Remove the cause of the error on the controller side.
Communications cable is disconnected or damaged	<ul style="list-style-type: none"> Check the connector to make sure the cable has a signal. Replace the communications cable.

HOA Keypad Display	Minor Fault Name
CrST	Cannot Reset
Cause	Possible Solutions
Fault reset was being executed when a Run command was entered	<ul style="list-style-type: none"> Ensure that a Run command cannot be entered from the external terminals or option during fault reset. Turn off the Run command.

HOA Keypad Display	Minor Fault Name
EF	Forward/Reverse Run Command Input Error Both forward run and reverse run closed simultaneously for longer than 0.5 s.
Cause	Possible Solutions
Sequence error	Check the forward and reverse command sequence and correct the problem. Note: When minor fault EF detected, motor ramps to stop.

HOA Keypad Display	Minor Fault Name
EF0	Option Card External Fault An external fault condition is present.
Cause	Possible Solutions
An external fault was received from the PLC with F6-03 set to 3, which allows the drive to continue running after an external fault occurs	<ul style="list-style-type: none"> Remove the cause of the external fault. Remove the external fault input from the PLC.

6.5 Alarm Detection

HOA Keypad Display	Minor Fault Name
There is a problem with the PLC program	Check the PLC program and correct problems.
HOA Keypad Display	Minor Fault Name
FbH	Excessive PI Feedback The PI feedback input is higher than the level set to b5-36 for longer than the time set to b5-37, and b5-12 is set to 1 or 4.
Cause	Possible Solutions
Parameter settings for b5-36 and b5-37 are incorrect	Check parameters b5-36 and b5-37.
PI feedback wiring is faulty	Correct the wiring.
Feedback sensor has malfunctioned	Check the sensor and replace it if damaged.
Feedback input circuit is damaged	Replace either the control board or the entire drive. For instructions on replacing the control board, contact Yaskawa or your nearest sales representative.
HOA Keypad Display	Minor Fault Name
FbL	PI Feedback Loss The PI feedback input is lower than the level set to b5-13 for longer than the time set to b5-14, and b5-12 is set to 1 or 4.
Cause	Possible Solutions
Parameter settings for b5-13 and b5-14 are incorrect	Check parameters b5-13 and b5-14.
PI feedback wiring is faulty	Correct the wiring.
Feedback sensor has malfunctioned	Check the sensor and replace it if damaged.
Feedback input circuit is damaged	Replace either the control board or the entire drive. For instructions on replacing the control board, contact Yaskawa or your nearest sales representative.
HOA Keypad Display	Minor Fault Name
HCA	Current Alarm Drive current exceeded overcurrent warning level (150% of the rated current).
Cause	Possible Solutions
Load is too heavy	Reduce the load for applications with repetitive operations (i.e., stops and starts), or replace the drive.
Acceleration and deceleration times are too short	<ul style="list-style-type: none"> Calculate the torque required during acceleration and for the inertia moment. If the torque level is not right for the load, take the following steps: <ul style="list-style-type: none"> Increase the acceleration and deceleration times (C1-01 to C1-04). Increase the capacity of the drive.
A special-purpose motor is being used, or the drive is attempting to run a motor greater than the maximum allowable capacity	<ul style="list-style-type: none"> Check the motor capacity. Use a motor appropriate for the drive. Ensure the motor is within the allowable capacity range.
The current level increased due to Speed Search after a momentary power loss or while attempting to perform a fault restart	The alarm will only appear briefly. There is no need to take action to prevent the alarm from occurring in such instances.
HOA Keypad Display	Minor Fault Name
inTLK	Interlock Open ALM LED will not blink
Cause	Possible Solutions
BAS Interlock multi-function input is open	Check the cause of interlock.
HOA Keypad Display	Minor Fault Name
LT-1	Cooling Fan Maintenance Time The cooling fan has reached its expected maintenance period and may need to be replaced.
Cause	Possible Solutions
The cooling fan has reached 90% of its expected performance life	Replace the cooling fan and set o4-03 to 0 to reset the Maintenance Monitor.

6.5 Alarm Detection

HOA Keypad Display	Minor Fault Name
LT-2	Capacitor Maintenance Time
	The main circuit and control circuit capacitors are nearing the end of their expected performance life.
Cause	Possible Solutions
The main circuit and control circuit capacitors have reached 90% of their expected performance lives	Replace either the control board or the entire drive. For instructions on replacing the control board, contact Yaskawa or your nearest sales representative.
HOA Keypad Display	Minor Fault Name
LT-3	Soft Charge Bypass Relay Maintenance Time
	The DC bus soft charge relay is nearing the end of its expected performance life.
Cause	Possible Solutions
The DC bus soft charge relay has reached 90% of expected performance life	Replace either the control board or the entire drive. For instructions on replacing the control board, contact Yaskawa or your nearest sales representative.
HOA Keypad Display	Minor Fault Name
LT-4	IGBT Maintenance Time (50%)
	IGBTs have reached 50% of their expected performance life.
Cause	Possible Solutions
IGBTs have reached 50% of their expected performance life	Check the load, carrier frequency, and output frequency.
HOA Keypad Display	Minor Fault Name
oH	Heatsink Overheat
	The temperature of the heatsink exceeded the overheat pre-alarm level set to L8-02 (90-100 °C). Default value for L8-02 is determined by drive capacity (o2-04).
Cause	Possible Solutions
Surrounding temperature is too high	<ul style="list-style-type: none"> Check the surrounding temperature. Improve the air circulation within the enclosure panel. Install a fan or air conditioner to cool surrounding area. Remove anything near drive that may cause extra heat.
Internal cooling fan has stopped	<ul style="list-style-type: none"> Replace the cooling fan. After replacing the drive, set parameter o4-03 to 0 to reset the cooling fan operation time.
Airflow around the drive is restricted	<ul style="list-style-type: none"> Provide proper installation space around the drive as indicated in the manual. Allow for the proper space and ensure that there is sufficient circulation around the control panel. Check for dust or other foreign materials clogging the cooling fan. Clear debris caught in the fan that restricts air circulation.
HOA Keypad Display	Minor Fault Name
oH2	Drive Overheat Warning
Cause	Possible Solutions
An external device triggered an overheat warning in the drive	Search for the device that tripped the overheat warning. Remove the cause of the problem.
HOA Keypad Display	Minor Fault Name
oH3	Motor Overheat
	The motor overheat signal entered to a multi-function analog input terminal exceeded the alarm level (H3-02 or H3-10 = E).
Cause	Possible Solutions
Motor thermostat wiring is faulty (PTC input).	Repair the PTC input wiring.
There is a fault on the machine side (e.g., the machine is locked up)	<ul style="list-style-type: none"> Check the status of the machine. Remove the cause of the fault.

6.5 Alarm Detection

HOA Keypad Display	Minor Fault Name
Motor has overheated	<ul style="list-style-type: none"> • Check the load size, accel/decel times, and cycle times. • Decrease the load. • Increase accel and decel times (C1-01 and C1-02). • Adjust the preset V/f pattern. Set E1-03 to 6. • Check the motor-rated current. • Enter motor-rated current on motor nameplate (E2-01). • Ensure the motor cooling system is operating normally. • Repair or replace the motor cooling system.
HOA Keypad Display	Minor Fault Name
oL3	Overtorque 1
	Drive output current was greater than L6-02 for longer than the time set to L6-03.
Cause	Possible Solutions
Inappropriate parameter settings	Check parameters L6-02 and L6-03.
There is a fault on the machine side (e.g., the machine is locked up)	<ul style="list-style-type: none"> • Check the status of the machine. • Remove the cause of the fault.
HOA Keypad Display	Minor Fault Name
ov	DC Bus Overvoltage
	The DC bus voltage exceeded the trip point.
	<ul style="list-style-type: none"> • For 208 V Bypass Drives: approximately 410 V • For 480 V Bypass Drives: approximately 820 V
Cause	Possible Solutions
Surge voltage present in the drive input power	<ul style="list-style-type: none"> • Install an AC reactor. • Voltage surge can result from a thyristor convertor and a phase advancing capacitor operating on the same drive input power system.
The motor is short-circuited	<ul style="list-style-type: none"> • Check the motor power cable, relay terminals and motor terminal box for short circuits. • Correct grounding shorts and turn the power back on.
Ground current has overcharged the main circuit capacitors via the drive input power	
Noise interference causes the drive to operate incorrectly	<ul style="list-style-type: none"> • Review possible solutions for handling noise interference. • Review section on handling noise interference and check control circuit lines, main circuit lines and ground wiring. • If the magnetic contactor is identified as a source of noise, install a surge protector to the MC coil.
	Set number of fault restarts (L5-01) to a value other than 0.
HOA Keypad Display	Minor Fault Name
PASS	MEMOBUS/Modbus Comm. Test Mode Complete
Cause	Possible Solutions
MEMOBUS/Modbus test has finished normally	This verifies that the test was successful.
HOA Keypad Display	Minor Fault Name
SAFE	Customer Safety
	Customer Safeties mult-function input is open. This alarm has display priority over the Interlock Open (inTLK).
Cause	Possible Solutions
External contact from customer wiring is open.	Check the cause of the open safety.
HOA Keypad Display	Minor Fault Name
SE	MEMOBUS/Modbus Communication Test Mode Error
Cause	Possible Solutions
A digital input set to 67H (MEMOBUS/Modbus test) was closed while the drive was running	Stop the drive and run the test again.
HOA Keypad Display	Minor Fault Name
TrPC	IGBT Maintenance Time (90%)
	IGBTs have reached 90% of their expected performance life.

6.5 Alarm Detection

HOA Keypad Display	Minor Fault Name
Cause	Possible Solutions
IGBTs have reached 90% of their expected performance life	Replace the drive.
HOA Keypad Display	Minor Fault Name
UL3	Undertorque Detection 1
Cause	Possible Solutions
Inappropriate parameter settings	Check parameters L6-02 and L6-03.
Load has dropped or decreased significantly	Check for broken parts in the transmission system.
HOA Keypad Display	Minor Fault Name
UL6	Undertorque Detection 6
Cause	Possible Solutions
The load has dropped or decreased under the motor underload curve	Check parameters L6-13 and L6-14.
HOA Keypad Display	Minor Fault Name
Uv	Undervoltage
Cause	Possible Solutions
Phase loss in the drive input power	Check for wiring errors in the main circuit drive input power. Correct the wiring.
Loose wiring in the drive input power terminals	<ul style="list-style-type: none"> Ensure the terminals have been properly tightened. Apply the tightening torque to the terminals as specified. <i>Refer to Wire Gauge and Tightening Torque Specifications on page 43.</i>
There is a problem with the drive input power voltage	<ul style="list-style-type: none"> Check the voltage. Lower the voltage of the drive input power so that it is within the limits listed in the specifications.
Drive internal circuitry is worn	<ul style="list-style-type: none"> Check the maintenance time for the capacitors (U4-05). Replace either the control board or the entire drive if U4-05 exceeds 90%. For instructions on replacing the control board, contact Yaskawa or your nearest sales representative.
The drive input power transformer is too small and voltage drops when the power is switched on	<ul style="list-style-type: none"> Check for an alarm when the magnetic contactor, line breaker, and leakage breaker are closed. Check the capacity of the drive input power transformer.
Air inside the drive is too hot	Check the temperature inside the drive.
The CHARGE light is broken or disconnected	Replace either the control board or the entire drive. For instructions on replacing the control board, contact Yaskawa or your nearest sales representative.
HOA Keypad Display	Minor Fault Name
voF	Output Voltage Detection Fault
Cause	Possible Solutions
Hardware is damaged	Replace either the control board or the entire drive. For instructions on replacing the control board, contact Yaskawa or your nearest sales representative.
HOA Keypad Display	Minor Fault Name
WrUn	Waiting for Run
Cause	Possible Solutions
After a Run command has been entered, the drive must wait for the time set to b1-11 to pass before it can begin to operate the motor	This is not an error.

6.6 Programming Errors

6.6 Programming Errors

◆ Programming Error Codes, Causes, and Possible Solutions

A Programming Error (oPE) occurs when a contradictory parameter is set or an individual parameter is set to an inappropriate value.

The drive will not operate until the parameter or parameters causing the problem are set correctly. An oPE, however, does not trigger an alarm or fault output. If an oPE occurs, investigate the cause and refer to **Table 6.11** for the appropriate action. When an oPE appears on the HOA keypad display, press the ENTER button to view U1-18 and see which parameter is causing the oPE.

Table 6.11 oPE Codes, Causes, and Possible Solutions

HOA Keypad Display	Error Name
oPE01	Drive Capacity Setting Fault
	Drive capacity and the value set to o2-04 do not match.
Cause	Possible Solutions
The drive model selection (o2-04) and the actual capacity of the drive are not the same	Correct the value set to o2-04.
HOA Keypad Display	Error Name
oPE02	Parameter Range Setting Error
	Use U1-18 to find parameters set outside the range.
Cause	Possible Solutions
Parameters were set outside the possible setting range	<ul style="list-style-type: none"> Set parameters to the proper values by checking the modified constants menu and verifying that settings are within the limits. Set Z1-01 to 1 to re-initialize the drive and bypass. Set parameters to the proper values by checking the modified constants menu and verifying that settings are within the limits.
Note:	When multiple errors occur simultaneously, other errors are given precedence over oPE02
HOA Keypad Display	Error Name
oPE03	Multi-Function Input Selection Error
	A contradictory setting is assigned to multi-function contact inputs Z2-01 to Z2-08.
Cause	Possible Solutions
<ul style="list-style-type: none"> The same function is assigned to two multi-function inputs Excludes “Not used” and “External Fault” Settings for N.C. and N.O. input for the following functions were selected simultaneously: <ul style="list-style-type: none"> External Search Command 1 and External Search Command 2 (61 vs. 62) Fast Stop N.O. and Fast Stop N.C. (15 vs. 17) KEB for Momentary Power Loss and High Slip Braking (65, 66, 7A, 7B vs. 68) KEB Command 1 and KEB Command 2 (65, 66 vs. 7A, 7B) FWD Run Command (or REV) and FWD/REV Run Command (2-wire) (40, 41 vs. 42, 43) Drive Enable (60 vs. 6A) 	<ul style="list-style-type: none"> Ensure all multi-function inputs are assigned to different functions. Re-enter the multi-function settings to ensure this does not occur. <ul style="list-style-type: none"> Check if contradictory settings have simultaneously been assigned to the multi-function input terminals. Correct setting errors.

6.6 Programming Errors

HOA Keypad Display	Error Name
oPE05	Run Command/Frequency Reference Source Selection Error
Cause	Possible Solutions
Frequency reference is assigned to an option card (Z1-07) and an input option card is not connected to the drive	Reconnect the input option card to the drive.
The Run command is assigned to an option card (Z1-08) and an input option card is not connected to the drive	

HOA Keypad Display	Error Name
oPE07	Multi-Function Analog Input Selection Error
Cause	Possible Solutions
A contradictory setting is assigned to multi-function analog inputs H3-02 or H3-10 and PI functions conflict.	Change the settings to H3-02 and H3-10 so that functions no longer conflict. Note: Both 0 (Frequency Reference Bias) and F (Not Used) can be set to H3-02 and H3-10 simultaneously.
At least two analog input terminals are set to the same function (i.e., at least two of these parameters have the same setting: H3-02 or H3-10)	
The following simultaneous contradictory settings: H3-02 or H3-10 = C (PI Target Value) while b5-18 = 1 (enables b5-19 as the target PI value)	Disable one of the PI selections.

HOA Keypad Display	Error Name
oPE09	PI Control Selection Fault
Cause	Possible Solutions
PI control function selection is incorrect. Requires that PI control is enabled (b5-01 = 1 or 3).	<ul style="list-style-type: none"> Set b5-15 to a value other than 0.0. Set the stopping method to coast to stop or ramp to stop (b1-03 = 0 or 1).
The following simultaneous contradictory settings have occurred: <ul style="list-style-type: none"> b5-15 is not set to 0.0 (PI Sleep Function Operation Level) The stopping method is set to either DC Injection Braking or coast to stop with a timer (b1-03 = 2 or 3) 	
b5-01 is set to 1, enabling PI control, but the lower limit for the frequency reference (d2-02) is not set to 0 while reverse output is enabled (b5-11 = 1)	Correct the parameter settings.
b5-01 is set to 3, enabling PI control, but the lower limit for the frequency reference (d2-01) is not 0. Parameter d2-01 is not accessible.	Correct the parameter settings.

HOA Keypad Display	Error Name
oPE10	V/f Data Setting Error
Cause	Possible Solutions
V/f pattern setting error	Set E1-03 to the pattern that fits the application.

HOA Keypad Display	Error Name
oPE11	Carrier Frequency Setting Error
Cause	Possible Solutions
Correct the setting for the carrier frequency.	Correct the parameter settings.
The following simultaneous contradictory settings have occurred: C6-05 > 6 and C6-04 > C6-03 (carrier frequency lower limit is greater than the upper limit) If C6-05 ≤ 6, the drive operates at C6-03 <I>	
The upper and lower limits between C6-02 and C6-05 are contradictory	

<I> Details on this function can be found in the standard P1000 Technical Manual (SIEPYAIP1U01) at www.yaskawa.com.

6.6 Programming Errors

HOA Keypad Display	Error Name
oPE28	Sequence Timer Error
	One or more of the sequence timers is not set in the correct order.
Cause	Possible Solutions
One of the following contradictory settings is true: <ul style="list-style-type: none">• S2-01 > S2-02• S2-06 > S2-07• S2-11 > S2-12• S2-16 > S2-17	Correct the parameter settings.

6.7 Auto-Tuning Fault Detection

When the Auto-Tuning faults shown below are detected, the fault is displayed on the operator and the motor coasts to a stop. Auto-Tuning faults do not trigger a multi-function terminal set for fault or alarm output.

An End□ error indicates that although Auto-Tuning has successfully completed, there is some discrepancy in the calculations. If an End□ error occurs, check for the cause of the error using the table in this section, and perform Auto-Tuning again or manually set the motor parameters after fixing the problem. Start the application if no problem can be diagnosed despite the existence of the End□ error.

◆ Auto-Tuning Codes, Causes, and Possible Solutions

Table 6.12 Auto-Tuning Codes, Causes, and Possible Solutions

HOA Keypad Display	Error Name
End3	Rated Current Setting Alarm (displayed after Auto-Tuning is complete)
Cause	Possible Solutions
The correct current rating printed on the motor nameplate was not entered into T1-04	<ul style="list-style-type: none"> • Check the setting of parameter T1-04. • Check the motor data and repeat Auto-Tuning.
HOA Keypad Display	Error Name
End4	Adjusted Slip Calculation Error
Cause	Possible Solutions
The calculated slip is outside the allowable range	Make sure the data entered for Auto-Tuning is correct.
HOA Keypad Display	Error Name
End5	Resistance Tuning Error
Cause	Possible Solutions
The calculated resistance value is outside the allowable range	<ul style="list-style-type: none"> • Double-check the data entered for the Auto-Tuning process. • Check the motor and motor cable connection for faults.
HOA Keypad Display	Error Name
End7	No-Load Current Alarm
Cause	Possible Solutions
The entered no-load current value was outside the allowable range	Check and correct faulty motor wiring.
Auto-Tuning results were less than 5% of the motor rated current	Double-check the data entered for the Auto-Tuning process.
HOA Keypad Display	Error Name
Er-01	Motor Data Error
Cause	Possible Solutions
Motor data or data entered during Auto-Tuning was incorrect	<ul style="list-style-type: none"> • Check that the motor data entered to T1 parameters matches motor nameplate input before Auto-Tuning. • Restart Auto-Tuning and enter the correct information.
Motor output power and motor-rated current settings (T1-02 and T1-04) do not match	<ul style="list-style-type: none"> • Check the drive and motor capacities. • Correct the settings of parameters T1-02 and T1-04.
Motor rated current and detected no-load current are inconsistent	<ul style="list-style-type: none"> • Check the motor rated current and no-load current. • Correct the settings of parameters T1-04 and E2-03.
Base frequency and motor rated speed (T1-05 and T1-07) do not match	<ul style="list-style-type: none"> • Correct the settings of parameters T1-05 and T1-07. • Check that the correct number of poles were entered to T1-06.
HOA Keypad Display	Error Name
Er-02	Minor Fault
Cause	Possible Solutions
An alarm was triggered during Auto-Tuning	Exit the Auto-Tuning menu, check the alarm code, remove the alarm cause, and repeat Auto-Tuning.

6.7 Auto-Tuning Fault Detection

HOA Keypad Display	Error Name
Er-03	OFF Button Input
Cause	Possible Solutions
Auto-Tuning canceled by pressing the OFF button	Auto-Tuning did not complete properly. Restart Auto-Tuning.
HOA Keypad Display	Error Name
Er-04	Line-to-Line Resistance Error
Cause	Possible Solutions
Motor data entered during Auto-Tuning was incorrect	<ul style="list-style-type: none"> Make sure the data entered to the T1 parameters match the information written on the motor nameplate. Restart Auto-Tuning and enter the correct information.
Results from Auto-Tuning are outside the parameter setting range or the tuning process took too long	Check and correct faulty motor wiring.
Faulty motor cable or cable connection	
HOA Keypad Display	Error Name
Er-05	No-Load Current Error
Cause	Possible Solutions
Motor data entered during Auto-Tuning was incorrect	<ul style="list-style-type: none"> Make sure the data entered to the T1 parameters match the information written on the motor nameplate. Restart Auto-Tuning and enter the correct information.
Results from Auto-Tuning are outside the parameter setting range or the tuning process took too long	Check and correct faulty motor wiring.
HOA Keypad Display	Error Name
Er-08	Rated Slip Error
Cause	Possible Solutions
Motor data entered during Auto-Tuning was incorrect	<ul style="list-style-type: none"> Make sure the data entered to the T1 parameters match the information written on the motor nameplate. Restart Auto-Tuning and enter the correct information.
Results from Auto-Tuning are outside the parameter setting range or the tuning process took too long	Check and correct faulty motor wiring.
HOA Keypad Display	Error Name
Er-09	Acceleration Error
Cause	Possible Solutions
The motor did not accelerate for the specified acceleration time	<ul style="list-style-type: none"> Increase the acceleration time (C1-01). Disconnect the machine from the motor if possible.
HOA Keypad Display	Error Name
Er-12	Current Detection Error
Cause	Possible Solutions
One of the motor phases is missing: (U/T1, V/T2, W/T3)	Check motor wiring and correct any problems.
The current exceeded the current rating of the drive	<ul style="list-style-type: none"> Check motor wiring for a short between motor lines. Close any magnetic contactors used between motors. Replace the control board or the entire drive. For instructions on replacing the control board, contact Yaskawa or your nearest sales representative.
The current is too low	
Attempted Auto-Tuning without motor connected to the drive	Connect the motor and restart Auto-Tuning.
Current detection signal error	Replace the control board or the entire drive. For instructions on replacing the control board, contact Yaskawa or your nearest sales representative.

6.8 Diagnosing and Resetting Faults

When a fault occurs and the drive stops, follow the instructions below to remove whatever conditions triggered the fault, then restart the drive.

Note: An oC/SC fault will be displayed in the event of an IGBT failure. It may not be possible to reset this fault until the IGBT problem is corrected.

◆ Fault Occurs Simultaneously with Power Loss

WARNING! Electrical Shock Hazard. Ensure there are no short circuits between the main circuit terminals (R/L1, S/L2, and T/L3) or between the ground and main circuit terminals before restarting the drive. Failure to comply may result in serious injury or death and will cause damage to equipment.

1. Turn on the drive input power.
2. Use monitor parameters U2-□□ to display data on the operating status of the drive just before the fault occurred.
3. Remove the cause of the fault and reset.

Note:

1. To find out what faults were triggered, check the fault history in U2-02. Information on drive status when the fault occurred such as the frequency, current, and voltage can be found in U2-03 through U2-32. **Refer to Viewing Fault Trace Data After Fault on page 221** for information on how to view fault data.
2. When the fault continues to be displayed after cycling power, remove the cause of the fault and reset.

◆ If the Drive Still has Power After a Fault Occurs

1. Look at the HOA keypad for information on the fault that occurred.
2. **Refer to Fault Displays, Causes, and Possible Solutions on page 194.**
3. Reset the fault. **Refer to Fault Reset Methods on page 222.**



◆ Viewing Fault Trace Data After Fault

Step		Display/Result
1. Turn on the drive input power. The first screen displays.	→	
2. Press or until the monitor screen is displayed.	→	
3. Press to display the parameter setting screen.	→	
4. Press and to scroll to monitor U2-02. The fault code shown in U2-02 is the fault that occurred most recently.	→	
5. Press to view drive status information when fault occurred. Parameters U2-03 through U2-32 help determine the cause of a fault. Parameters to be monitored differ depending on the control mode.	→	

6.8 Diagnosing and Resetting Faults

◆ Fault Reset Methods

When a fault occurs, the cause of the fault must be removed and the drive must be restarted. The table below lists the different ways to restart the drive.

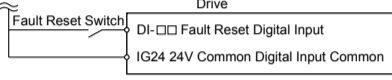
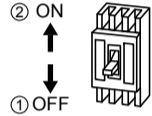
After the Fault Occurs	Procedure	
Fix the cause of the fault, restart the drive, and reset the fault	Press  on the HOA keypad.	
Resetting via Fault Reset Digital Input DI-□□ Resetting via Fault Reset serial command.	Close then open the fault signal digital input via the digital input defined as Fault Reset (one of Z2-01 through Z2-08 set to 34).	
Turn off the main power supply if the above methods do not reset the fault. Reapply power after the HOA keypad display has turned off. When an “SC” error occurs, contact Yaskawa or a Yaskawa agent before cycling the power to the drive.		

Note: If the Run command is present, the drive will disregard any attempts to reset the fault. Remove the Run command or press “OFF” on the HOA keypad before attempting to clear a fault situation.

6.9 Troubleshooting without Fault Display

This section describes troubleshooting problems that do not trip an alarm or fault.



The following symptoms indicate that the drive is not set correctly for proper performance with the motor. *Refer to Motor Performance Fine-Tuning on page 190* for guidance on troubleshooting.

- Motor hunting and oscillation
- Poor motor torque
- Poor speed precision
- Poor motor torque and speed response
- Motor noise

◆ Common Problems

Common Problems		Page
Cannot Change Parameter Settings		223
Motor Does Not Rotate Properly after Pressing the AUTO Button or after Entering External Run Command	Motor Does Not Rotate	224
	Motor Rotates in the Opposite Direction from the Run Command	225
	Motor Rotates in One Direction Only	225
Motor is Too Hot		225
oPE02 Error Occurs When Lowering the Motor Rated Current Setting		225
Motor Stalls During Acceleration or With Large Loads		226
Drive Frequency Reference Differs from the Controller Frequency Reference Command		226
Excessive Motor Oscillation and Erratic Rotation		227
Deceleration Takes Longer Than Expected		227
Noise From Drive or Motor Cables When the Drive is Powered On		227
Ground Fault Circuit Interrupter (GFCI) Trips During Run		227
Connected Machinery Vibrates When Motor Rotates	Unexpected Noise from Connected Machinery	227
	Oscillation or Hunting	227
PI Output Fault		228
Motor Rotates After the Drive Output is Shut Off (Motor Rotates During DC Injection Braking)		228
Output Frequency is not as High as Frequency Reference		228
Sound from Motor		228
Motor Does Not Restart after Power Loss		229

◆ Cannot Change Parameter Settings





Cause	Possible Solutions
The drive is running the motor (i.e., the Run command is present).	<ul style="list-style-type: none"> • Stop the drive and switch over to the Programming Mode. • Most parameters cannot be edited during run.
The operator is not in the Parameter Setup Mode (the screen will display “PAR”).	<ul style="list-style-type: none"> • See what mode the operator is currently set for. • Parameters cannot be edited when in the Setup Mode (“STUP”). Switch modes so that “PAR” appears on the screen. <i>Refer to The Drive and Programming Modes on page 66.</i>
A multi-function contact input terminal is set to allow or restrict parameter editing (H1-01 through H1-07 = 1B).	<ul style="list-style-type: none"> • When the terminal is open, parameters cannot be edited. • Turn on the multi-function contact input set to 1B.
The wrong password was entered.	<ul style="list-style-type: none"> • If the password entered to A1-04 does not match the password saved to A1-05, then drive settings cannot be changed. • Reset the password. <p>If you cannot remember the password:</p> <ul style="list-style-type: none"> • Scroll to Z1-02. Press  and  simultaneously. Parameter Z1-03 will appear. • Set a new password to parameter Z1-03.

6.9 Troubleshooting without Fault Display

Cause	Possible Solutions
Undervoltage was detected.	<ul style="list-style-type: none"> Check the drive input power voltage by looking at the DC bus voltage (U1-07). Check all main circuit wiring.

◆ Motor Does Not Rotate Properly after Pressing AUTO Button or after Entering External Run Command

■ Motor Does Not Rotate

Cause	Possible Solutions
The drive is not in the Drive Mode.	<ul style="list-style-type: none"> Check if the DRV light on the HOA keypad is lit. Enter the Drive Mode to begin operating the motor. <i>Refer to The Drive and Programming Modes on page 66.</i>
 was pushed.	<p>Stop the drive and check if the correct frequency reference source is selected. If the operator keypad shall be the source, the LO/RE button LED must be on. If the source is REMOTE, it must be off. Take the following steps to solve the problem:</p> <ul style="list-style-type: none"> Push .
Auto-Tuning has just completed.	<ul style="list-style-type: none"> When Auto-Tuning completes, the drive is switched back to the Programming Mode. The Run command will not be accepted unless the drive is in the Drive Mode. Use the HOA keypad to enter the Drive Mode. <i>Refer to The Drive and Programming Modes on page 66.</i>
A Fast Stop was executed and has not yet been reset.	Reset the Fast Stop command.
Settings are incorrect for the source that provides the Run command.	<p>Check parameter Z1-08 (Run Command Selection). Set Z1-08 so that it corresponds with the correct Run command source.</p> <p>0: HOA keypad 1: Control circuit terminal (default setting) 2: MEMOBUS/Modbus communications 3: Option card</p>
There is faulty wiring in the control circuit terminals.	<ul style="list-style-type: none"> Check the wiring for the control terminal. Correct wiring mistakes. Check the input terminal status monitor (U1-10).
The drive has been set to accept the frequency reference from the incorrect source.	<p>Check parameter b1-01 (Frequency Reference Selection 1). Set b1-01 to the correct source of the frequency reference.</p> <p>0: HOA keypad 1: Control circuit terminal (default setting) 2: MEMOBUS/Modbus communications 3: Option card</p>
The terminal set to accept the main speed reference is set to the incorrect voltage and/or current.	If the frequency reference is set at terminal A1, check parameter H3-01 for the correct signal level selection. If terminal A2 is used, check parameter H3-09. If terminal A3 is used, check parameter H3-05. <i>Refer to Terminals A1, A2, and A3 Input Signal Selection on page 52.</i>
Selection for the sink/source mode and the internal/external power supply is incorrect.	Check wire jumper connection between terminals SC and SP.
Frequency reference is too low.	Check the frequency reference monitor (U1-01).
Multi-function analog input is set up to accept gain for the frequency reference, but no voltage (current) has been provided.	<ul style="list-style-type: none"> Check the multi-function analog input settings. Check if analog inputs A1, A2, or A3 are set for frequency reference gain (H3-02, H3-10 = 1). If so, check if the correct signal is applied to the terminal. The gain and the frequency reference will be 0 if no signal is applied to the gain input. Check if H3-02, H3-10, and H3-06 have been set to the proper values. Check if the analog input value has been set properly. (U1-13, U1-14, and U1-15)
 was pressed when the drive was started from a REMOTE source.	<ul style="list-style-type: none"> Pressing  will decelerate the drive to stop. Switch off the Run command and then re-enter a new Run command. Set o2-02 to 0 to disable .
Motor starting torque is too low.	<i>Refer to Motor Performance Fine-Tuning on page 190.</i>
Frequency reference value is too low or the drive does not accept the value entered.	Enter a value that is above the minimum output frequency determined by E1-09.

6.9 Troubleshooting without Fault Display

■ Motor Rotates in the Opposite Direction from the Run Command

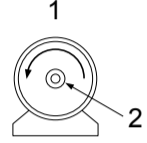
Cause	Possible Solutions
Phase wiring between the drive and motor is incorrect.	<ul style="list-style-type: none"> Check the motor wiring. Switch two motor cables (U, V, and W) to reverse motor direction. Connect drive output terminals U/T1, V/T2, and W/T3 in the right order to match motor terminals U, V, and W. Change the setting of parameter b1-14.
The forward direction for the motor is set up incorrectly.	<p>Typically, forward is designated as being counterclockwise when looking from the motor shaft (see figure below).</p>  <ol style="list-style-type: none"> Forward Rotating Motor (looking down the motor shaft) Motor Shaft
The motor is running at almost 0 Hz and the Speed Search estimated the speed to be in the opposite direction.	<ul style="list-style-type: none"> Disable bi-directional search (b3-14 = 0) so that Speed Search is performed only in the specified direction.

Note: Check the motor specifications for the forward and reverse directions. The motor specifications will vary depending on the manufacturer of the motor.

■ Motor Rotates in One Direction Only

Cause	Possible Solutions
The drive prohibits reverse rotation.	<ul style="list-style-type: none"> Check parameter b1-04. Set parameter b1-04 to 0 to allow the motor to rotate in reverse.

◆ Motor is Too Hot

Cause	Possible Solutions
The load is too heavy.	<p>If the load is too heavy for the motor, the motor will overheat as it exceeds its rated torque value for an extended period of time. Keep in mind that the motor also has a short-term overload rating in addition to the possible solutions provided below:</p> <ul style="list-style-type: none"> Reduce the load. Increase the acceleration and deceleration times. Check the values set for the motor protection (L1-01, L1-02) as well as the motor rated current (E2-01). Increase motor capacity.
The air around the motor is too hot.	<ul style="list-style-type: none"> Check the ambient temperature. Cool the area until it is within the specified temperature range.
Insufficient voltage insulation between motor phases.	<p>When the motor cable is long, high voltage surges occur between the motor coils and drive switching. Normally, surges can reach up to three times the drive input power supply voltage.</p> <ul style="list-style-type: none"> Use a motor with a voltage tolerance higher than the max voltage surge. Use an inverter-duty motor rated for use with AC drives. Install an AC reactor on the output side of the drive. The carrier frequency should be set to 2 kHz when installing an AC reactor.
The motor fan has stopped or is clogged.	Check the motor fan.
The carrier frequency is too low.	Increase the carrier frequency to lower the current harmonic distortion and lower the motor temperature.

◆ oPE02 Error Occurs When Lowering the Motor Rated Current Setting

Cause	Possible Solutions
Motor rated current and the motor no-load current setting in the drive are incorrect.	<ul style="list-style-type: none"> The user is trying to set the motor rated current in E2-01 to a value lower than the no-load current set in E2-03. Make sure that value set in E2-01 is higher than E2-03. If it is necessary to set E2-01 lower than E2-03, first lower the value set to E2-03, then change the setting in E2-01 as needed.

6.9 Troubleshooting without Fault Display

◆ Motor Stalls during Acceleration or Acceleration Time is Too Long

Cause	Possible Solutions
Torque limit has been reached or current suppression keeps the drive from accelerating.	Take the following steps to resolve the problem: <ul style="list-style-type: none"> • Reduce the load. • Increase motor capacity. Note: Although the drive has a Stall Prevention function and a Torque Compensation Limit function, accelerating too quickly or trying to drive an excessively large load can exceed the capabilities of the motor.
Load is too heavy.	
Torque limit is not set properly.	Check the torque limit setting.
Frequency reference is too low.	<ul style="list-style-type: none"> • Check the maximum output frequency (E1-04). • Increase E1-04 if it is set too low.
	Check U1-01 for proper frequency reference.
	Check if a frequency reference signal switch has been set to one of the multi-function input terminals.
Load is too heavy.	Check for low gain level set to terminals A1, A2, or A3 (H3-03, H3-11, H3-07).
	<ul style="list-style-type: none"> • Reduce the load so that the output current remains within the motor rated current. • In extruder and mixer applications, the load will sometimes increase as the temperature drops. • Increase the acceleration time. • Check if the mechanical brake is fully releasing as it should.
	Check if the acceleration time parameters have been set too long (C1-01, C1-03).
Motor characteristics and drive parameter settings are incompatible with one another.	<ul style="list-style-type: none"> • Set the correct V/f pattern so that it matches the characteristics of the motor being used. • Check the V/f pattern set to E1-03. • Execute Rotational Auto-Tuning.
Incorrect frequency reference setting.	<ul style="list-style-type: none"> • Check the multi-function analog input settings. Multi-function analog input terminal A1, A2, or A3 is set for frequency gain (H3-02, H3-10, or H3-06 is set to "1"), but there is no voltage or current input provided. • Make sure H3-02, H3-10, and H3-06 are set to the proper values. • See if the analog input value is set to the right value (U1-13 to U1-15).
The Stall Prevention level during acceleration and deceleration set too low.	<ul style="list-style-type: none"> • Check the Stall Prevention level during acceleration (L3-02). • If L3-02 is set too low, acceleration may be taking too long. • Increase L3-02.
The Stall Prevention level during run has been set too low.	<ul style="list-style-type: none"> • Check the Stall Prevention level during run (L3-06). • If L3-06 is set too low, speed will drop as the drive outputs torque. • Increase the setting value.
Drive reached the limitations of the V/f motor control method.	<ul style="list-style-type: none"> • The motor cable may be long enough (over 50 m) to require Auto-Tuning for line-to-line resistance. • Be aware that V/f Control is comparatively limited when it comes to producing torque at low speeds.

◆ Drive Frequency Reference Differs from the Controller Frequency Reference Command

Cause	Possible Solutions
The analog input gain and bias for the frequency reference input are set to incorrect values.	<ul style="list-style-type: none"> • Check the gain and bias settings for the analog inputs that are used to set the frequency reference. Check parameters H3-03 and H3-04 for input A1, check parameters H3-11, and H3-12 for input A2, and check parameters H3-07 and H3-08 for input A3. • Set these parameters to the appropriate values.
A frequency bias signal is being entered via analog input terminals A1 to A3.	<ul style="list-style-type: none"> • If more than one of multi-function analog inputs A1 to A3 is set for frequency reference bias (H3-02, H3-10, or H3-06 is set to "0"), then the sum of all signals builds the frequency reference. • Make sure that H3-02, H3-10, and H3-06 are set appropriately. • Check the input level set for terminals A1 to A3 (U1-13 to U1-15).
PID control is enabled, and the drive is consequently adjusting the output frequency to match the PID setpoint. The drive will only accelerate to the maximum output frequency set in E1-04 while PID control is active.	If PID control is not necessary for the application, disable it by setting b5-01 to 0.

6.9 Troubleshooting without Fault Display

◆ Excessive Motor Oscillation and Erratic Rotation

Cause	Possible Solutions
Poor balance between motor phases.	Check drive input power voltage to ensure that it provides stable power.
Hunting prevention function is disabled.	Set n1-01 to 1 to enable Hunting Prevention.

◆ Deceleration Takes Longer Than Expected

Cause	Possible Solutions
L3-04 is set incorrectly.	Check the Stall Prevention level during deceleration (L3-04).
The deceleration time is set too long.	Set deceleration to more appropriate time (C1-02).
Insufficient motor torque.	<ul style="list-style-type: none"> Assuming parameter settings are normal and that no overvoltage occurs when there is insufficient torque, it is likely that the demand on the motor has exceeded the motor capacity. Use a larger motor.
Load exceeded the internal torque limit determined by the drive rated current.	Switch to a larger capacity drive.

◆ Noise From Drive or Motor Cables When the Drive is Powered On

Cause	Possible Solutions
Relay switching in the drive generates excessive noise.	<ul style="list-style-type: none"> Lower the carrier frequency (C6-02). Install a noise filter on the input side of drive input power. Install a noise filter on the output side of the drive. Place the wiring inside a metal conduit to shield it from switching noise. Ground the drive and motor properly. Separate the main circuit wiring and the control lines. Make sure wires and the motor have been properly grounded.

◆ Ground Fault Circuit Interrupter (GFCI) Trips During Run

Cause	Possible Solutions
Excessive leakage current trips GFCI.	<ul style="list-style-type: none"> Check the wiring and rating of peripheral devices. Increase the GFCI sensitivity or use GFCI with a higher threshold. Lower the carrier frequency (C6-02). Reduce the length of the cable used between the drive and the motor. Disable the internal EMC filter.

◆ Connected Machinery Vibrates When Motor Rotates

■ Unexpected Noise from Connected Machinery

Cause	Possible Solutions
The carrier frequency is at the resonant frequency of the connected machinery.	Adjust the carrier frequency using parameters C6-02 through C6-05.
The drive output frequency is the same as the resonant frequency of the connected machinery.	<ul style="list-style-type: none"> Adjust the parameters used for the Jump frequency function (d3-01 through d3-04) to skip the problem-causing bandwidth. Place the motor on a rubber pad to reduce vibration.

Note: The drive may have trouble assessing the status of the load due to white noise generated from using Swing PWM (C6-02 = 7 to A).

■ Oscillation or Hunting

Cause	Possible Solutions
Gain is too low when using PI control.	<i>Refer to b5: PID Control on page 90</i> for details.
The frequency reference is assigned to an external source and the signal is noisy.	<ul style="list-style-type: none"> Ensure that noise is not affecting the signal lines. Separate main circuit wiring and control circuit wiring. Use twisted-pair cables or shielded wiring for the control circuit. Increase the analog input time filter constant (H3-13).

6.9 Troubleshooting without Fault Display

Cause	Possible Solutions
The cable between the drive and motor is too long.	<ul style="list-style-type: none"> Perform Auto-Tuning for line-to-line resistance. Reduce the length of the cable.

◆ PID Output Fault

Cause	Possible Solutions
No PID feedback input.	<ul style="list-style-type: none"> Check the multi-function analog input terminal settings. Set multi-function analog input terminal A1, A2, or A3 for PID feedback (H3-02, H3-10, or H3-06 = B). A signal input to the terminal selection for PID feedback is needed. Check the connection of the feedback signal. Check the various PID-related parameter settings. No PID feedback input to the terminal causes the value detected to be 0, causing a PID fault and the drive to operate at max frequency.
The level of detection and the target value do not correspond with each other.	<ul style="list-style-type: none"> PID control keeps the difference between target and detection values at 0. Set the input level for the values relative to one another. Use analog input gains H3-03, H3-07, and H3-11 to adjust PID target and feedback signal scaling.
Reverse drive output frequency and speed detection. When output frequency rises, the sensor detects a speed decrease.	Set PID output for reverse characteristics (b5-09 = 1).
Adjustment made to PID parameter settings are insufficient.	<i>Refer to b5: PID Control on page 90 for details.</i>

◆ Motor Rotates after the Drive Output is Shut Off (Motor Rotates During DC Injection Braking)

Cause	Possible Solutions
DC Injection Braking is set too low and the drive cannot decelerate properly.	<ul style="list-style-type: none"> Adjust the DC Injection braking settings. Increase the current level for DC Injection Braking Current (b2-02). Increase the DC Injection Braking time at stop (b2-04).
The stopping method is set so that the drive coasts to stop.	Set b1-03 (Stopping Method Selection) to 0 or 2.

◆ Output Frequency is Not as High as Frequency Reference

Cause	Possible Solutions
Frequency reference is set within the range of the Jump frequency.	<ul style="list-style-type: none"> Adjust the parameters used for the Jump frequency function (d3-01, d3-02, d3-03). Enabling the Jump frequency prevents the drive from outputting the frequencies specified in the Jump range.
Large load triggered Stall Prevention function during acceleration.	<ul style="list-style-type: none"> Reduce the load. Adjust the Stall Prevention level during acceleration (L3-02).

◆ Sound from Motor

Cause	Possible Solutions
Exceeded 110% of the rated output current of the drive while operating at low speeds.	<ul style="list-style-type: none"> If the output current rises too high at low speeds, the carrier frequency is automatically reduced and causes a whining or buzzing sound. If the sound is coming from the motor, disable carrier frequency derating (L8-38 = 0). Disabling the automatic carrier frequency derating increases the chances of an overload fault (oL2). Switch to a larger capacity motor if oL2 faults occur too frequently.

6.9 Troubleshooting without Fault Display

◆ Motor Does Not Restart after Power Loss

Cause	Possible Solutions
The Run command was not issued again when power was restored.	<ul style="list-style-type: none">• Check the sequence and wiring that has been set up to enter the Run command.• A relay should be set up to make sure the Run command remains enabled throughout any power loss.
The relay that is supposed to maintain the Run command has been switched off.	Check wiring and circuitry for the relay intended to keep the Run command enabled.

6.9 Troubleshooting without Fault Display

This Page Intentionally Blank

7

Periodic Inspection & Maintenance

This chapter describes the periodic inspection and maintenance of the P1000 Bypass to ensure that it receives the proper care to maintain overall performance.

7.1	SECTION SAFETY.....	232
7.2	INSPECTION.....	234
7.3	PERIODIC MAINTENANCE.....	237
7.4	HOA KEYPAD BATTERY REPLACEMENT.....	239
7.5	DRIVE COOLING FAN REPLACEMENT.....	241

7.1 Section Safety

WARNING

Electrical Shock Hazard

Do not connect or disconnect wiring while the power is on.

Failure to comply could result in death or serious injury.

Before servicing, disconnect all power to the equipment. The internal capacitor remains charged even after the power supply is turned off. The charge indicator LED will extinguish when the DC bus voltage is below 50 Vdc. To prevent electric shock, wait for at least the time specified on the warning label; after all indicators are OFF, measure for unsafe voltages to confirm the drive is safe prior to servicing.

Do not operate equipment with covers removed.

Failure to comply could result in death or serious injury.

The diagrams in this section may show drives without covers or safety shields to show details. Be sure to reinstall covers or shields before operating the drives and run the drives according to the instructions described in this manual.

Always ground the motor-side grounding terminal.

Improper equipment grounding could result in death or serious injury by contacting the motor case.

Do not remove covers or touch circuit boards while the power is on.

Failure to comply could result in death or serious injury.

Do not allow unqualified personnel to perform work on the bypass.

Failure to comply could result in death or serious injury.

Installation, maintenance, inspection, and servicing must be performed only by authorized personnel familiar with installation, adjustment, and maintenance of AC drives.

Do not perform work on the drive while wearing loose clothing, jewelry or without eye protection.

Failure to comply could result in death or serious injury.

Remove all metal objects such as watches and rings, secure loose clothing, and wear eye protection before beginning work on the drive.

Do not touch any terminals before the capacitors have fully discharged.

Failure to comply could result in death or serious injury.

Before servicing, disconnect all power to the equipment. The internal capacitor remains charged even after the power supply is turned off. The charge indicator LED will extinguish when the DC bus voltage is below 50 Vdc. To prevent electric shock, wait for at least the time specified on the warning label; after all indicators are OFF, measure the DC bus voltage level to confirm it has reached a safe level.

Fire Hazard

Tighten all terminal screws to the specified tightening torque.

Loose electrical connections could result in death or serious injury by fire due to overheating of electrical connections.

Do not use an improper voltage source.

Failure to comply could result in death or serious injury by fire.

Verify that the rated voltage of the drive matches the voltage of the incoming power supply before applying power.

Do not use improper combustible materials.

Failure to comply could result in death or serious injury by fire.

Attach the drive to metal or other noncombustible material.

NOTICE

Observe proper electrostatic discharge procedures (ESD) when handling the drive and circuit boards.

Failure to comply may result in ESD damage to the drive circuitry.

Follow cooling fan replacement instructions. The cooling fan cannot operate properly when it is installed incorrectly and could seriously damage the drive.

Follow the instructions in this manual to replace the cooling fan, making sure that the label is on top before inserting the cooling fan into the drive. To ensure maximum useful product life, replace both cooling fans when performing maintenance.

Never connect or disconnect the motor from the drive while the drive is outputting voltage.

Improper equipment sequencing could result in damage to the drive.

Do not use unshielded cable for control wiring.

Failure to comply may cause electrical interference resulting in poor system performance. Use shielded, twisted-pair wires and ground the shield to the ground terminal of the drive.

Do not allow unqualified personnel to use the product.

Failure to comply could result in damage to the drive or braking circuit.

Maintenance, inspection, and replacement of parts must be performed only by authorized personnel familiar with installation, adjustment and maintenance of AC drives.

Do not modify the drive or bypass circuitry.

Failure to comply could result in damage to the drive or bypass and will void warranty.

Yaskawa is not responsible for any modification of the product made by the user. This product must not be modified.

Check all the wiring to ensure that all connections are correct after installing the bypass.

Failure to comply could result in damage to the equipment.

Comply with proper wiring practices.

The motor may run in reverse if the phase order is backward.

Connect motor input terminals U, V and W to drive output terminals U/T1, V/T2, and W/T3. The phase order for the drive and motor should match.

Frequently switching the drive power supply to stop and start the motor can damage the drive.

To get the full performance life out of the electrolytic capacitors and circuit relays, refrain from switching the drive power supply off and on more than once every 30 minutes. Frequent use can damage the drive. Use the drive to stop and start the motor.

Do not operate damaged equipment.

Failure to comply could result in further damage to the equipment.

Do not connect or operate any equipment with visible damage or missing parts.

7.2 Inspection

7.2 Inspection

Power electronics have limited life and may exhibit changes in characteristics or performance deterioration after years of use under normal conditions. To help avoid such problems, it is important to perform preventive maintenance and periodic inspection on the drive.

Drives contain a variety of power electronics such as power transistors, semiconductors, capacitors, resistors, fans, and relays. The electronics in the drive serve a critical role in maintaining proper motor control.

Follow the inspection lists provided in this chapter as a part of a regular maintenance program.

Note: The drive will require more frequent inspection if it is placed in harsh environments, such as:

- High ambient temperatures
- Frequent starting and stopping
- Fluctuations in the AC supply or load
- Excessive vibrations or shock loading
- Dust, metal dust, salt, sulfuric acid, chlorine atmospheres
- Poor storage conditions.

Perform the first equipment inspection one to two years after installation.

◆ Recommended Daily Inspection

Table 7.1 outlines the recommended daily inspection for Yaskawa drives. Check the following items on a daily basis to avoid premature deterioration in performance or product failure. Copy this checklist and mark the “Checked” column after each inspection.

Table 7.1 General Recommended Daily Inspection Checklist

Inspection Category	Inspection Points	Corrective Action	Checked
Motor	Inspect for abnormal oscillation or noise coming from the motor.	<ul style="list-style-type: none"> • Check the load coupling. • Measure motor vibration. • Tighten all loose components. 	
Cooling	Inspect for abnormal heat generated from the drive or motor and visible discoloration.	Check for the following: <ul style="list-style-type: none"> • Excessive load. • Loose connections. • Dirty heatsink or motor. • Ambient temperature. 	
	Inspect drive cooling fan and circulation fan operation.	Check for the following: <ul style="list-style-type: none"> • Clogged or dirty fan. • Correct Fan operation parameter setting. 	
Environment	Verify the drive environment complies with the specifications listed in <i>Installation Environment</i> on page 38.	Eliminate the source of contaminants or correct poor environment.	
Load	The drive output current should not be higher than the motor or drive rating for an extended period of time.	Check for the following: <ul style="list-style-type: none"> • Excessive load. • Correct motor parameter settings. 	
Power Supply Voltage	Check main power supply and control voltages.	<ul style="list-style-type: none"> • Correct the voltage or power supply to within nameplate specifications. • Verify all main circuit phases. 	

◆ Recommended Periodic Inspection

Table 7.2 outlines the recommended periodic inspections for Yaskawa drive installations. Although periodic inspections should generally be performed once a year; the drive may require more frequent inspection in harsh environments or with rigorous use. Operating and environmental conditions, along with experience in each application, will determine the actual inspection frequency for each installation. Periodic inspection will help to avoid premature deterioration in performance or product failure. Copy this checklist and mark the “Checked” column after each inspection.

■ Periodic Inspection

WARNING! Electrical Shock Hazard. Do not inspect, connect, or disconnect any wiring while the power is on. Failure to comply can result in serious personal injury. Before servicing, disconnect all power to the equipment. The internal capacitor remains charged even after the power supply is turned off. The charge indicator LED will extinguish when the DC bus voltage is below 50 Vdc. To prevent electric shock, wait for at least the time specified on the warning label; after all indicators are OFF, measure for unsafe voltages to confirm the drive is safe prior to servicing.

Table 7.2 Periodic Inspection Checklist

Inspection Area	Inspection Points	Corrective Action	Checked
Main Circuit Periodic Inspection			
General	<ul style="list-style-type: none"> Inspect equipment for discoloration from overheating or deterioration. Inspect for damaged or deformed parts. 	<ul style="list-style-type: none"> Replace damaged components as required. The drive has few serviceable parts and may require complete drive replacement. 	
	Inspect for dirt, foreign particles, or dust collection on components.	<ul style="list-style-type: none"> Inspect enclosure door seal if used. Remove foreign particles and dust with a vacuum cleaner to avoid touching parts. Replace components if cleaning is not possible. 	
Conductors and Wiring	<ul style="list-style-type: none"> Inspect wiring and connections for discoloration, damage, or heat stress. Inspect wire insulation and shielding for wear. 	Repair or replace damaged wiring.	
Terminals	Inspect terminals for stripped, damaged, or loose connections.	Tighten loose screws and replace damaged screws or terminals.	
Relays and Contactors	<ul style="list-style-type: none"> Inspect contactors and relays for excessive noise during operation. Inspect coils for signs of overheating such as melted or cracked insulation. 	<ul style="list-style-type: none"> Check coil voltage for overvoltage or undervoltage conditions. Replace damaged removable relays, contactors, or circuit board. 	
Electrolytic Capacitor	<ul style="list-style-type: none"> Inspect for leaking, discoloration, or cracks. Check if the cap has come off, for any swelling, or if the sides have burst open. 	The drive has few serviceable parts and may require complete drive replacement.	
Diode, IGBT (Power Transistor)	Inspect for dust or other foreign material collected on the surface.	Remove foreign particles and dust with a vacuum cleaner to avoid touching parts.	
Motor Periodic Inspection			
Operation Check	Check for increased vibration or abnormal noise.	Stop the motor and contact qualified maintenance personnel as required.	
Control Circuit Periodic Inspection			
General	<ul style="list-style-type: none"> Inspect terminals for stripped, damaged, or loose connections. Make sure all terminals have been properly tightened. 	<ul style="list-style-type: none"> Tighten loose screws and replace damaged screws or terminals. If terminals are integral to a circuit board, then board or drive replacement may be required. 	
	Check for any odor, discoloration, and rust. Make sure connections are properly fastened and that no dust or oil mist has accumulated on the surface of the board.	<ul style="list-style-type: none"> Fix any loose connections. If an antistatic cloth or vacuum plunger cannot be used, replace the board. Do not use any solvents to clean the board. Remove foreign particles and dust with a vacuum cleaner to avoid touching parts. <p>The drive has few serviceable parts and may require complete drive replacement.</p>	
Cooling System Periodic Inspection			
Cooling Fan, Circulation Fan, Control Board Cooling Fan	<ul style="list-style-type: none"> Check for abnormal oscillation or unusual noise. Check for damaged or missing fan blades. 	<ul style="list-style-type: none"> Replace as required. Refer to the P1000 Technical Manual (SIEPYAIP1U01) for information on cleaning or replacing the fan. 	

7.2 Inspection

Inspection Area	Inspection Points	Corrective Action	Checked
Heatsink	Inspect for dust or other foreign material collected on the surface.	Remove foreign particles and dust with a vacuum cleaner to avoid touching parts.	
Air Duct	Inspect air intake and exhaust openings. They must be free from obstruction and properly installed.	<ul style="list-style-type: none">• Visually inspect the area.• Clear obstructions and clean air duct as required.	
Display Periodic Inspection			
HOA Keypad	<ul style="list-style-type: none">• Make sure data appears on the display properly.• Inspect for dust or other foreign material that may have collected on surrounding components.	<ul style="list-style-type: none">• Contact the nearest sales office if there is any trouble with the display or keypad.• Clean the HOA keypad	

7.3 Periodic Maintenance

The drive has Maintenance Monitors that keep track of component wear. This feature provides advance maintenance warning and eliminates the need to shut down the entire system for unexpected problems. The drive allows the user to check predicted maintenance periods for the components listed below.

- Cooling Fan, Circulation Fan, Control Board Cooling Fan
- Electrolytic Capacitors
- Inrush Prevention Circuit
- IGBTs

For replacement parts, contact the distributor where the drive was purchased or contact Yaskawa directly.

◆ Replacement Parts

Table 7.3 contains the estimated performance life of components that require replacement during the life of the drive. Only use Yaskawa replacement parts for the appropriate drive model and revision.

Table 7.3 Estimated Performance Life

Component	Estimated Performance Life
Cooling Fan, Circulation Fan	10 years
Electrolytic Capacitors	10 years <1>

<1> Electrolytic capacitors cannot be replaced on some lower capacity models. Complete drive replacement may be required for these models.

NOTICE: Estimated performance life based on specific usage conditions. These conditions are provided for the purpose of replacing parts to maintain performance. Some parts may require more frequent replacement due to poor environments or rigorous use.

Usage conditions for estimated performance life:

Ambient temperature: Yearly average of 40 °C (IP20/IP00 enclosure)

Yearly average of 30 °C (side-by-side mounting/NEMA 1, UL type 1 enclosure drive or external heatsink installation)

■ Performance Life Monitors Maintenance Monitors

The drive calculates the maintenance period for components that may require replacement during the life of the drive. A percentage of the maintenance period is displayed on the HOA keypad by viewing the appropriate monitor parameter.

When the maintenance period reaches 100%, there is increased risk that the drive may malfunction. Yaskawa recommends checking the maintenance period regularly to ensure maximum performance life.

Refer to **Recommended Periodic Inspection on page 235** for more details.

Table 7.4 Performance Life Monitors Used for Component Replacement

Parameter	Component	Contents
U4-03	Cooling Fan Circulation Fan Control Board Cooling Fan	Displays the accumulated operation time of the fan, from 0 to 99999 hours. This value is automatically reset to 0 once it reaches 99999.
U4-04		Displays the accumulated fan operation time as a percentage of the specified maintenance period.
U4-05	DC Bus Capacitors	Displays the accumulated time the capacitors are used as a percentage of the specified maintenance period.
U4-06	Inrush (pre-charge) Relay	Displays the number of times the drive is powered up as a percentage of the performance life of the inrush circuit.

7.3 Periodic Maintenance

■ Alarm Outputs for Maintenance Monitors

An output can be set up to inform the user when a specific components has neared its expected performance life.

When one of multi-function digital output terminals has been assigned the maintenance monitor function (H2-□□ = 2F<I>), the terminal will close when the cooling fan, DC bus capacitors, or DC bus pre-charge relay reach 90% of the expected performance life, or when the IGBTs have reached 50% of their expected performance life. Additionally the HOA keypad will display an alarm like shown in **Table 7.5** to indicate the specific components that may need maintenance.

Details on this function can be found in the standard P1000 Technical Manual (SIEPYAIP1U01) at www.yaskawa.com.

Table 7.5 Maintenance Alarms

HOA Keypad Alarm Display		Function	Corrective Action
LT-1	LT-1	The cooling fans have reached 90% of their designated life time.	Replace the cooling fan.
LT-2	LT-2	The DC bus capacitors have reached 90% of their designated life time.	Contact a Yaskawa representative or the nearest Yaskawa sales office on possible drive replacement.
LT-3	LT-3	The DC bus charge circuit has reached 90% of its designated life time.	Contact a Yaskawa representative or the nearest Yaskawa sales office on possible drive replacement.

7.4 HOA Keypad Battery Replacement

The HOA keypad contains a monitor battery that allows the user to check drive functions. The battery requires periodic replacement because the lifespan of the battery is shorter than the performance life of the HOA keypad.

WARNING! Fire Hazard. Properly handle the HOA keypad battery. Improper use of the battery may cause fire by explosion and injury. Correctly install the battery, paying attention to polarity (+/-). Do not charge the battery or improperly disassemble the HOA keypad.

When replacing the battery, use a Hitachi Maxell CR1220 Lithium Manganese Dioxide Battery or an equivalent battery with the following specifications:

- Nominal Voltage 3 V
- Operating Temperature Range -20 °C to +85 °C
- Nominal battery life of 2 years (ambient temperature of +20 °C).

NOTICE: Do not heat or throw the battery into fire. The battery remains in use even when power to the drive has been shut off. Be sure to also remove the battery in the HOA keypad when the drive will be shut off for long periods of time. A dead battery left inside the HOA keypad may leak and damage the keypad and drive. Replace the battery with a new one immediately after the expected lifespan has passed or when the "bAT" error is displayed on the HOA keypad.

NOTICE: Observe Perchlorate Best Management Practices (BMPs). BMPs apply to primary lithium (manganese dioxide) coin batteries sold or distributed in California. Perchlorate Material special handling may apply, please refer to: www.dtsc.ca.gov/hazardouswaste/perchlorate.

◆ Real-Time Clock Adjustment

The HOA keypad will display the Real Time Clock Adjustment Display as shown in **Figure 7.1** where the user can adjust the Real-Time Clock. Refer to **Manual Clock Adjustment Procedure on page 240** for the Real-Time Clock setting procedure.

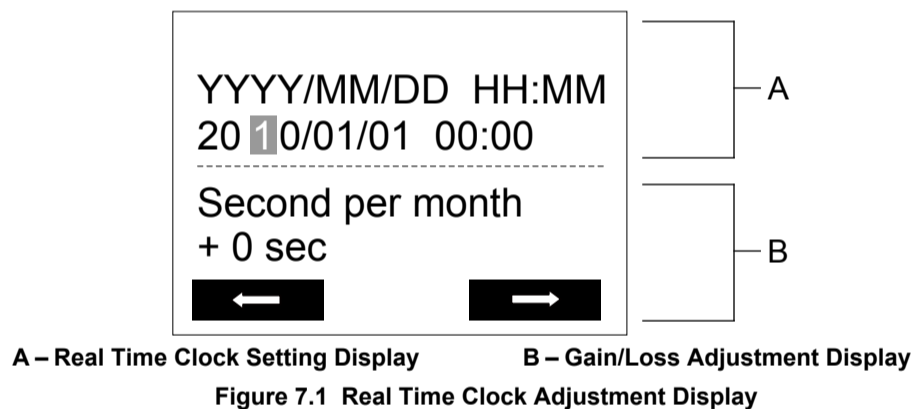

Display	Description
YYYY	Set the year with the last two digits.
MM	Set the month with two digits.
DD	Set the day with two digits.
HH:MM	Set the hours and minutes, with two digits for each.
Second per month	Set the gain or loss in seconds per month.

Moving the Cursor

Pressing the F2 key or the RESET key will move the cursor to the digit on the right. Pressing the F1 key will move the cursor to the left.

Changing Settings

- **Changing YYYY/MM/DD HH:MM:** Pressing the up arrow key will increase the number selected by the cursor from 0 to 9. Pressing the down arrow key will decrease the number selected by the cursor from 0 to 9.
- **Setting the Seconds per Month:** Pressing the up arrow key will increase the number selected by the cursor from -504 to +488 in increments of 8. Pressing the down arrow key will decrease the number selected by the cursor from -504 to +488 in increments of 8.

Verifying the New Time Setting

After pressing ENTER, the display will indicate "Entry accepted" and the new time value will be saved to the Real-Time Clock (RTC).

7.4 HOA Keypad Battery Replacement

If there is a problem with the entered time, the operator will indicate “Input error” and the screen will return to the time setting display.

Canceling the Input

Pressing the ESC key will display “Aborted” on the operator, and no value will be saved to the RTC. Pressing OFF will abort the setting process without any display, and no setting changes will be saved to the RTC.

Exiting from the Time Setting Screen Without Making Any Changes

If no changes are entered, the display will exit Real Time Clock Adjustment Display after a few seconds and no changes will be saved.

Manual Clock Adjustment by Setting Z1-37 to 1

If time and date stamps are required by the user for faults and other data, the Real-time clock will need to be set upon receipt of the Bypass or after HOA keypad battery replacement.

Refer to Z1-37: Set Time on page 173 for details on parameter Z1-37.

The following actions are possible in the Clock Adjustment Mode:

- Set the current time
- Check the time set to the drive Real-Time Clock

Table 7.6 illustrates how to set the Real-Time Clock manually.

Table 7.6 Manual Clock Adjustment Procedure

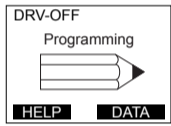
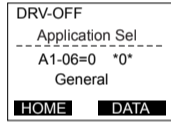
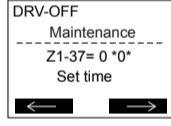
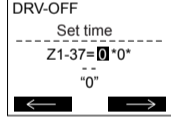
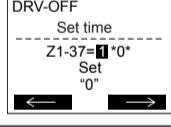
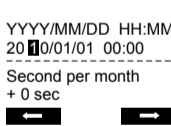
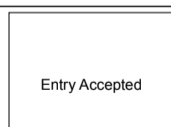
Procedure		Display
1	Use the up and down arrow keys to scroll through display menu until the screen shows “Programming”.	
2	Press the ENTER key to enter select the parameter setting mode.	
3	Use the up and down arrow keys to scroll through display menu until parameter Z1-37 appears.	
4	Press the ENTER key until “0” flashes.	
5	Press the up arrow key so that the display changes to “1”.	
6	Press the ENTER key and the time setting screen will appear. Use the right arrow key to select the desired digit, then set the correct date and time using the up and down arrow keys.	
7	After entering the correct time, press the ENTER key to save the changes.	

7.5 Drive Cooling Fan Replacement

NOTICE: Follow the drive cooling fan replacement instructions outlined in the P1000 Technical Manual (SIEPYAIP1U01). Cooling fans will not operate properly when installed incorrectly and could seriously damage the drive. To ensure maximum useful product life, replace all cooling fans when performing maintenance.

Refer to **Table 7.7** to determine the drive cooling fans by bypass unit.

Contact a Yaskawa representative or the nearest Yaskawa sales office to order replacement cooling fans as required.

For drives with multiple cooling fans, replace all the fans when performing maintenance to ensure maximum product performance life.

Table 7.7 Drive Cooling Fans by Bypass Model

Bypass Model	Drive Model	Cooling Fans	Circulation Fans	Control Board Cooling Fans
208 Vac Bypass Drives				
D002 D003	2A0004	–	–	–
D004	2A0006	–	–	–
D007	2A0008	–	–	–
D010	2A0012	–	–	–
D016	2A0018	1	–	–
D024	2A0030	2	–	–
D030	2A0040	2	–	–
D046	2A0056	2	–	–
D059	2A0069	2	–	–
D074	2A0081	2	–	–
D088	2A0110	2	–	–
D114	2A0138	2	–	–
D143 D169	2A0169	2	–	–
D211	2A0211	2	–	–
D273	2A0312	2	–	–
D343	2A0360	3	1	–
D396	2A0415	3	1	–
480 Vac Bypass Drives				
B001 B002	4A0002	–	–	–
B003	4A0004	–	–	–
B004	4A0005	–	–	–
B007	4A0009	1	–	–
B011	4A0011	1	–	–
B014	4A0018	2	–	–
B021	4A0023	2	–	–
B027	4A0031	2	–	–
B034	4A0038	2	–	–
B040	4A0044	2	–	–
B052	4A0058	2	–	–
B065	4A0072	2	–	–
B077	4A0088	2	–	–
B096	4A0103	2	–	–
B124	4A0139	2	–	–
B156	4A0165	2	–	–
B180	4A0208	2	–	–
B240	4A0250	3	–	–
B302 B361	4A0362	3	1	–
B414	4A0414	3	1	–

7.5 Drive Cooling Fan Replacement

Bypass Model	Drive Model	Cooling Fans	Circulation Fans	Control Board Cooling Fans
B477 B515	4A0515	3	2	2
B590	4A0675	3	2	2

Appendix: A

Specifications

A.1	POWER RATINGS.....	244
A.2	DRIVE SPECIFICATIONS.....	247
A.3	DRIVE WATT LOSS DATA.....	249
A.4	DRIVE DERATING DATA.....	251
A.5	BYPASS OPTIONS.....	253

A.1 Power Ratings

A.1 Power Ratings

◆ Three-Phase 208 Vac Bypass Drive Models D002 to D030

Table A.1 Power Ratings (Three-Phase 208 Vac)

Item		Specification							
Bypass Model P1B□		D002	D003	D004	D007	D010	D016	D024	D030
Maximum Applicable Motor Capacity (HP) <1>		0.5	0.75	1	2	3	5	7.5	10
Input	Input Current Range (A) <2>	2.7 to 4.6	3.9 to 5.8	5.6 to 7.5	8.3 to 10.2	12.3 to 14.2	17.7 to 19.6	29.8 to 31.5	40.0 to 41.7
	Rated Voltage Rated Frequency	Three-phase 208 Vac 50/60 Hz							
	Allowable Voltage Fluctuation	-15 to 10%							
	Allowable Frequency Fluctuation	±5%							
Output	Rated Output Current (A)	2.4	3.5	4.6	7.5	10.6	16.7	24.2	30.8
	Overload Tolerance	ND Rating: 120% of rated output current for 60 s (Derating may be required for applications that start and stop frequently)							
	Carrier Frequency <3>	User-adjustable between 2 and 15 kHz							
	Maximum Output Voltage (V)	Three-phase 208 Vac							
	Maximum Output Frequency (Hz)	400 Hz (user-set)							

<1> The motor capacity (HP) refers to a NEC rated 4-pole motor. The rated output current of the drive output amps should be equal to or greater than the motor current. Select the appropriate capacity drive if operating the motor continuously above motor nameplate current.

<2> Assumes operation at the rated output current. Input current rating varies depending on the power supply transformer, input reactor, wiring connections, and power supply impedance. Refer to the bypass data nameplate affixed to the inside of the enclosure door for actual input current.

<3> Carrier frequency is set to 2 kHz. Current derating is required to raise the carrier frequency.

◆ Three-Phase 208 Vac Bypass Drive Models D046 to D211

Table A.2 Power Ratings (Three-Phase 208 Vac)

Item		Specification							
Bypass Model P1B□		D046	D059	D074	D088	D114	D143	D169	D211
Maximum Applicable Motor Capacity (HP) <1>		15	20	25	30	40	50	60	75
Input	Input Current Range (A) <2>	56.1 to 57.8	68.9 to 70.6	89.4 to 90.3	89.5 to 92.4	113.1 to 116.0	140.2 to 142.4	165.4 to 167.6	201.4 to 203.6
	Rated Voltage Rated Frequency	Three-phase 208 Vac 50/60 Hz							
	Allowable Voltage Fluctuation	-15 to 10%							
	Allowable Frequency Fluctuation	±5%							
Output	Rated Output Current (A)	46.2	59.4	74.8	88.0	114	143	169	211
	Overload Tolerance	ND Rating: 120% of rated output current for 60 s (Derating may be required for applications that start and stop frequently)							
	Carrier Frequency <3>	User-adjustable between 2 and 15 kHz						User-adjustable between 2 and 10 kHz	
	Maximum Output Voltage (V)	Three-phase 208 Vac							
	Maximum Output Frequency (Hz)	400 Hz (user-set)							

<1> The motor capacity (HP) refers to a NEC rated 4-pole motor. The rated output current of the drive output amps should be equal to or greater than the motor current. Select the appropriate capacity drive if operating the motor continuously above motor nameplate current.

<2> Assumes operation at the rated output current. Input current rating varies depending on the power supply transformer, input reactor, wiring connections, and power supply impedance. Refer to the bypass data nameplate affixed to the inside of the enclosure door for actual input current.

<3> Carrier frequency is set to 2 kHz. Current derating is required to raise the carrier frequency.

◆ Three-Phase 208 Vac Bypass Drive Models D273 to D396

Table A.3 Power Ratings (Three-Phase 208 Vac)

Item		Specification		
Bypass Model P1B□		D273	D343	D396
Maximum Applicable Motor Capacity (HP) <1>		100	125	150
Input	Input Current Range (A) <2>	284.9 to 287.1	376.8 to 380.2	450.9 to 454.2
	Rated Voltage Rated Frequency	Three-phase 208 Vac 50/60 Hz		
	Allowable Voltage Fluctuation	-15 to 10%		
	Allowable Frequency Fluctuation	±5%		
Output	Rated Output Current (A)	273	343	396
	Overload Tolerance	ND Rating: 120% of rated output current for 60 s (Derating may be required for applications that start and stop frequently)		
	Carrier Frequency <3>	User-adjustable between 2 and 10 kHz		
	Maximum Output Voltage (V)	Three-phase 208 Vac		
	Maximum Output Frequency (Hz)	400 Hz (user-set)		

- <1> The motor capacity (HP) refers to a NEC rated 4-pole motor. The rated output current of the drive output amps should be equal to or greater than the motor current. Select the appropriate capacity drive if operating the motor continuously above motor nameplate current.
- <2> Assumes operation at the rated output current. Input current rating varies depending on the power supply transformer, input reactor, wiring connections, and power supply impedance. Refer to the bypass data nameplate affixed to the inside of the enclosure door for actual input current.
- <3> Carrier frequency is set to 2 kHz. Current derating is required to raise the carrier frequency.

◆ Three-Phase 480 Vac Bypass Drive Models B001 to B027

Table A.4 Power Ratings (Three-Phase 480 Vac)

Item		Specification								
Bypass Model P1B□		B001	B002	B003	B004	B007	B011	B014	B021	B027
Maximum Applicable Motor Capacity (HP) <1>		0.75	1	2	3	5	7.5	10	15	20
Input	Input Current Range (A) <2>	1.6 to 2.4	2.1 to 2.9	3.6 to 4.4	5.2 to 6.1	8.1 to 9.0	13.9 to 14.7	16.0 to 16.7	21.9 to 22.6	33.1 to 33.8
	Rated Voltage Rated Frequency	Three-phase 480 Vac 50/60 Hz								
	Allowable Voltage Fluctuation	-15 to 10%								
	Allowable Frequency Fluctuation	±5%								
Output	Rated Output Current (A)	1.6	2.1	3.4	4.8	7.6	11.0	14.0	21.0	27.0
	Overload Tolerance	ND Rating: 120% of rated output current for 60 s (Derating may be required for applications that start and stop frequently)								
	Carrier Frequency <3>	User-adjustable between 2 and 15 kHz								
	Maximum Output Voltage (V)	Three-phase 480 Vac								
	Maximum Output Frequency (Hz)	400 Hz (user-set)								

- <1> The motor capacity (HP) refers to a NEC rated 4-pole motor. The rated output current of the drive output amps should be equal to or greater than the motor current. Select the appropriate capacity drive if operating the motor continuously above motor nameplate current.
- <2> Assumes operation at the rated output current. Input current rating varies depending on the power supply transformer, input reactor, wiring connections, and power supply impedance. Refer to the bypass data nameplate affixed to the inside of the enclosure door for actual input current.
- <3> Carrier frequency is set to 2 kHz. Current derating is required to raise the carrier frequency.

Specifications

A

A.1 Power Ratings

◆ Three-Phase 480 Vac Bypass Drive Models B034 to B156

Table A.5 Power Ratings (Three-Phase 480 Vac)

Item		Specification								
Bypass Model P1B□		B034	B040	B052	B065	B077	B096	B124	B156	
Maximum Applicable Motor Capacity (HP) <1>		25	30	40	50	60	75	100	125	
Input	Input Current Range (A) <2>	39.4 to 40.1	47.3 to 48.0	52.7 to 54.0	65.5 to 66.5	76.7 to 77.6	99.3 to 100.2	128.1 to 129.1	162.2 to 163.1	
	Rated Voltage Rated Frequency	Three-phase 480 Vac 50/60 Hz								
	Allowable Voltage Fluctuation	-15 to 10%								
	Allowable Frequency Fluctuation	±5%								
Output	Rated Output Current (A)	34.0	40.0	52.0	65.0	77.0	96.0	124.0	156.0	
	Overload Tolerance	ND Rating: 120% of rated output current for 60 s (Derating may be required for applications that start and stop frequently)								
	Carrier Frequency <3>	User-adjustable between 2 and 15 kHz						User-adjustable between 2 and 10 kHz		
	Maximum Output Voltage (V)	Three-phase 480 Vac								
	Maximum Output Frequency (Hz)	400 Hz (user-set)								

<1> The motor capacity (HP) refers to a NEC rated 4-pole motor. The rated output current of the drive output amps should be equal to or greater than the motor current. Select the appropriate capacity drive if operating the motor continuously above motor nameplate current.

<2> Assumes operation at the rated output current. Input current rating varies depending on the power supply transformer, input reactor, wiring connections, and power supply impedance. Refer to the bypass data nameplate affixed to the inside of the enclosure door for actual input current.

<3> Carrier frequency is set to 2 kHz. Current derating is required to raise the carrier frequency.

◆ Three-Phase 480 Vac Bypass Drive Models B180 to B590

Table A.6 Power Ratings (Three-Phase 480 Vac)

Item		Specification								
Bypass Model P1B□		B180	B240	B302	B361	B414	B477	B515	B590	
Maximum Applicable Motor Capacity (HP) <1>		150	200	250	300	350	400	450	500	
Input	Input Current Range (A) <2>	180.6 to 181.5	239.5 to 241.0	290.1 to 291.6	346.5 to 347.9	411.4 to 412.9	433.1 to 435.2	467.4 to 469.5	576.7 to 578.8	
	Rated Voltage Rated Frequency	Three-phase 480 Vac 50/60 Hz								
	Allowable Voltage Fluctuation	-15 to 10%								
	Allowable Frequency Fluctuation	±5%								
Output	Rated Output Current (A)	180.0	240.0	302.0	361.0	414.0	477.0	515.0	590.0	
	Overload Tolerance	ND Rating: 120% of rated output current for 60 s (Derating may be required for applications that start and stop frequently)								
	Carrier Frequency <3>	User-adjustable between 2 and 10 kHz				User-adjustable between 2 and 5 kHz				
	Maximum Output Voltage (V)	Three-phase 480 Vac								
	Maximum Output Frequency (Hz)	400 Hz (user-set)								

<1> The motor capacity (HP) refers to a NEC rated 4-pole motor. The rated output current of the drive output amps should be equal to or greater than the motor current. Select the appropriate capacity drive if operating the motor continuously above motor nameplate current.

<2> Assumes operation at the rated output current. Input current rating varies depending on the power supply transformer, input reactor, wiring connections, and power supply impedance. Refer to the bypass data nameplate affixed to the inside of the enclosure door for actual input current.

<3> Carrier frequency is set to 2 kHz. Current derating is required to raise the carrier frequency.

A.2 Drive Specifications

- Note:**
1. Perform rotational Auto-Tuning to obtain the performance specifications given below.
 2. For optimum performance life of the drive, install the drive in an environment that meets the required specifications.

Table A.7 Specifications

Item	Specification	
Control Characteristics	Control Method	V/f Control (V/f)
	Frequency Control Range	0.01 to 400 Hz
	Frequency Accuracy (Temperature Fluctuation)	Digital input: within $\pm 0.01\%$ of the max output frequency (-10 to +40 °C) Analog input: within $\pm 0.1\%$ of the max output frequency (25 °C ± 10 °C)
	Frequency Setting Resolution	Digital inputs: 0.01 Hz Analog inputs: 1/2048 of the maximum output frequency setting (11 bit plus sign) Resolution of analog inputs A1 and A3 is 10 bit + sign in current mode
	Output Frequency Resolution	0.001 Hz
	Frequency Setting Signal	Main speed frequency reference: DC -10 to +10 V (20 k Ω), DC 0 to +10 V (20 k Ω), 4 to 20 mA (250 Ω), 0 to 20 mA (250 Ω) Main speed reference: Pulse train input (max. 32 kHz)
	Starting Torque <1>	V/f: 150% at 3 Hz
	Speed Control Range <1>	V/f: 1:40
	Accel/Decel Time	0.0 to 6000.0 s (2 selectable combinations of independent acceleration and deceleration settings)
	Braking Torque	Approx. 20% (approx. 125% when using braking resistor) <2> <ul style="list-style-type: none"> • Short-time decel torque <3> : over 100% for 0.4/ 0.75 kW motors, over 50% for 1.5 kW motors, and over 20% for 2.2 kW and above motors <4> (overexcitation braking/High Slip Braking: approx. 40%) • Continuous regenerative torque: approx. 20% <4> (approx. 125% with dynamic braking resistor option <2> : 10% ED, 10s)
	Braking Transistor	Models 2A0004 to 2A0138, and 4A0002 to 4A0072 have a built-in braking transistor.
	V/f Characteristics	User-selected programs and V/f preset patterns possible
Protection Functions	Main Control Functions	Droop Control, Feed Forward Control, Momentary Power Loss Ride-Thru, Speed Search, Overtorque/Undertorque Detection, Torque Limit, 17 Step Speed (max), Accel/decel Switch, S-curve Accel/decel, 3-wire Sequence, Auto-tuning (rotational, stationary tuning), Dwell, Cooling Fan on/off Switch, Slip Compensation, Torque Compensation, Frequency Jump, Upper/lower Limits for Frequency Reference, DC Injection Braking at Start and Stop, Overexcitation Braking, High Slip Braking, PI Control (with sleep function), Energy Saving Control, MEMOBUS/Modbus Comm. (RS-422/RS-485 max, 115.2 kbps), Fault Restart, Application Presets, Removable Terminal Block with Parameter Backup Function, Online Tuning, KEB, Overexcitation Deceleration, Overvoltage Suppression, High Frequency Injection, Dynamic Noise Control
	Motor Protection	Electronic thermal overload relay
	Momentary Overcurrent Protection	Drive stops when output current exceeds 170% of rated output current
	Overload Protection	Drive stops when rated output current is 120% for 60 s <5>
	Overvoltage Protection	208 Vac Bypass Drive: Stops when DC bus voltage exceeds approx. 410 V 480 Vac Bypass Drive: Stops when DC bus voltage exceeds approx. 820 V
	Undervoltage Protection	208 Vac Bypass Drive: Stops when DC bus voltage falls below approx. 190 V 480 Vac Bypass Drive: Stops when DC bus voltage falls below approx. 380 V

Specifications

A

A.2 Drive Specifications

Item		Specification
Protection Functions	Momentary Power Loss Ride-Thru	Immediately stop after 15 ms or longer power loss <6> .
	Heatsink Overheat Protection	Thermistor
	Braking Resistor Overheat Protection	Overheat input signal for braking resistor (Optional ERF-type, 3% ED)
	Stall Prevention	Stall Prevention is available during acceleration, deceleration, and during run.
	Ground Protection	Electronic circuit protection <7>
	DC Bus Charge LED	Remains lit until DC bus voltage falls below 50 V
Environment	Area of Use	Indoors
	Ambient Temperature	-10 to +40 °C
	Humidity	95 RH% or less (no condensation)
	Storage Temperature	-20 to +60 °C (short-term temperature during transportation)
	Altitude	Up to 1000 meters without derating, up to 3000 m with output current and voltage derating. <i>Refer to Altitude Derating on page 252</i> for details.
	Vibration/Shock	10 to 20 Hz: 9.8 m/s ² 20 to 55 Hz: 5.9 m/s ² (2A0004 to 2A0211 and 4A0002 to 4A0165) 2.0 m/s ² (2A0250 to 2A0415 and 4A0208 to 4A0675)
Safety Standard		UL 508C (Power Conversion), UL/cUL listed, CSA 22.2 No. 14-05 (Industrial Control Equipment), CE marked, RoHS compliant, EN 61800-5-1 (LVD), EN 61800-3 (EMC), IEC60529

- <1> The accuracy of these values depends on motor characteristics, ambient conditions, and drive settings. Specifications may vary with different motors and with changing motor temperature. Contact Yaskawa for consultation.
- <2> Disable Stall Prevention during deceleration (L3-04 = 0) when using a regenerative converter, a regenerative unit, a braking resistor or the Braking Resistor Unit. The default setting for the Stall Prevention function will interfere with the braking resistor.
- <3> Instantaneous average deceleration torque refers to the torque required to decelerate the motor (uncoupled from the load) from the rated motor speed down to zero in the shortest time.
- <4> Actual specifications may vary depending on motor characteristics.
- <5> Overload protection may be triggered when operating with 150% of the rated output current if the output frequency is less than 6 Hz.
- <6> May be shorter due to load conditions and motor speed.
- <7> Ground protection cannot be provided when the impedance of the ground fault path is too low, or when the drive is powered up while a ground fault is present at the output.

A.3 Drive Watt Loss Data

Table A.8 Watt Loss 208 Vac Three-Phase Bypass Drive Models

Drive Model	Normal Duty			
	Rated Amps (A) <1>	Heatsink Loss (W)	Interior Unit Loss (W)	Total Loss (W)
2A0004	3.5	18.4	47	66
2A0006	6.0	31	51	82
2A0008	8.0	43	52	95
2A0010	9.6	57	58	115
2A0012	12.0	77	64	141
2A0018	17.5	101	67	168
2A0021	21	138	83	222
2A0030	30	262	117	379
2A0040	40	293	145	437
2A0056	56	371	175	546
2A0069	69	491	205	696
2A0081	81	527	257	785
2A0110	110	719	286	1005
2A0138	138	842	312	1154
2A0169	169	1014	380	1394
2A0211	211	1218	473	1691
2A0250	250	1764	594	2358
2A0312	312	2020	665	2686
2A0360	360	2698	894	3591
2A0415	415	2672	954	3626

<1> Value assumes the carrier frequency is 2 kHz (C6-02 = 1, 7, 8, 9, or A).

Table A.9 Watt Loss 480 Vac Three-Phase Bypass Drive Models

Drive Model	Normal Duty			
	Rated Amps (A) <1>	Heatsink Loss (W)	Interior Unit Loss (W)	Total Loss (W)
4A0002	2.1	20	48	68
4A0004	4.1	32	49	81
4A0005	5.4	45	53	97
4A0007	6.9	62	59	121
4A0009	8.8	66	60	126
4A0011	11.1	89	73	162
4A0018	17.5	177	108	285
4A0023	23	216	138	354
4A0031	31	295	161	455
4A0038	38	340	182	521
4A0044	44	390	209	599
4A0058	58	471	215	686
4A0072	72	605	265	870
4A0088	88	684	308	993
4A0103	103	848	357	1205
4A0139	139	1215	534	1749
4A0165	165	1557	668	2224
4A0208	208	1800	607	2408
4A0250	250	2379	803	3182
4A0296	296	2448	905	3353
4A0362	362	3168	1130	4298

Specifications

A

A.3 Drive Watt Loss Data

Drive Model	Normal Duty			
	Rated Amps (A) <1>	Heatsink Loss (W)	Interior Unit Loss (W)	Total Loss (W)
4A0414	414	3443	1295	4738
4A0515	515	4850	1668	6518
4A0675	675	4861	2037	6898

<1> Value assumes the carrier frequency is 2 kHz (C6-02 = 1, 7, 8, 9, or A).

A.4 Drive Derating Data

The drive can be operated at above the rated temperature, altitude, and default carrier frequency by derating the drive capacity.

◆ Rated Current Depending on Carrier Frequency

The tables below show the drive output current depending on the carrier frequency settings.

The 2 kHz values shown for ND below are equal to the drive rated current shown on the drive nameplate. Increasing the carrier frequency above 2 kHz will reduce the ND rated output current of the drive.

Table A.10 Three-Phase 208 Vac Bypass Drive Carrier Frequency and Current Derating

Three-Phase 208 Vac Bypass Drives			
Drive Model	Rated Current [A]		
	Normal Duty Rating (ND)		
	2 kHz	8 kHz	15 kHz
2A0004	3.5	3.2	2.56
2A0006	6	5	4
2A0008	8	6.9	5.5
2A0010	9.6	8	6.4
2A0012	12	11	8.8
2A0018	17.5	14	11.2
2A0021	21	17.5	14
2A0030	30	25	20
2A0040	40	33	26.4
2A0056	56	47	37.6
2A0069	69	60	48
2A0081	81	75	53
2A0110	110	85	60
2A0138	138	115	81

Three-Phase 208 Vac Bypass Drives			
Drive Model	Rated Current [A]		
	Normal Duty Rating (ND)		
	2 kHz	5 kHz	10 kHz
2A0169	169	145	116
2A0211	211	180	144
2A0250	250	215	172
2A0312	312	283	226
2A0360	360	346	277
2A0415	415	415	332

Table A.11 Three-Phase 480 Vac Bypass Drive Carrier Frequency and Current Derating

Three-Phase 480 Vac Bypass Drives			
Drive Model	Rated Current [A]		
	Normal Duty Rating (ND)		
	2 kHz	8 kHz	15 kHz
4A0002	2.1	1.8	1.1
4A0004	4.1	3.4	2
4A0005	5.4	4.8	2.9
4A0007	6.9	5.5	3.3
4A0009	8.8	7.2	4.3
4A0011	11.1	9.2	5.5
4A0018	17.5	14.8	8.9

A.4 Drive Derating Data

Three-Phase 480 Vac Bypass Drives			
Drive Model	Rated Current [A]		
	Normal Duty Rating (ND)		
	2 kHz	8 kHz	15 kHz
4A0023	23	18	10.8
4A0031	31	24	14.4
4A0038	38	31	18.6
4A0044	44	39	23.4
4A0058	58	45	27
4A0072	72	60	36
4A0088	88	75	45
4A0103	103	91	55

Three-Phase 480 Vac Bypass Drives			
Drive Model	Rated Current [A]		
	Normal Duty Rating (ND)		
	2 kHz	5 kHz	10 kHz
4A0139	139	112	78
4A0165	165	150	105
4A0208	208	180	126
4A0250	250	216	151
4A0296	296	260	182
4A0362	362	304	213
4A0414	414	370	–
4A0515	515	397	–
4A0675	675	528	–

◆ Altitude Derating

The drive standard ratings are valid for installation altitudes up to 1000 m. For installations from 1000 m to 3000 m, the drive rated output current must be derated for 0.2% per 100 m.

A.5 Bypass Options

The following configurations are available for the P1000 Bypass.

◆ Option PA

Two motor “AND” option. Allows simultaneous control of two identical motors.

◆ Option PK

Output reactor option. Adds 5% load reactor.

◆ Option PM

Input Circuit Breaker 100 kA option. A 65 kA circuit breaker (MCCB) or a motor circuit protector (MCP) is supplied as standard. An optional 100 kA is available. Drive input fuses are also provided as standard.

◆ Option PN

Input filter option.

◆ Option PR

Input reactor option. Adds 3% line reactor.

◆ Option PX

DC bus reactor option. Adds 3% bus reactor.

◆ Option PY

Two motor “OR” option. Allows control of one of two motors.

◆ Option TD

Ethernet/IP serial communication option board.

◆ Option TL

LonWorks serial communication option board.

◆ Option TQ

EtherNet Modbus TCP/IP serial communication option board.

◆ Option TW

Custom Nameplate: Provides a custom nameplate for placement on the front of the P1000 Bypass.

A.5 Bypass Options

This Page Intentionally Blank

Appendix: B

Parameter List

This appendix contains a full listing of all parameters and settings available in the drive.

B.1	PARAMETER GROUPS.....	256
B.2	A: INITIALIZATION PARAMETERS.....	257
B.3	B: APPLICATION.....	258
B.4	C: TUNING.....	262
B.5	D: REFERENCES.....	263
B.6	E: MOTOR PARAMETERS.....	264
B.7	F: OPTIONS.....	265
B.8	H PARAMETERS: MULTI-FUNCTION TERMINALS.....	266
B.9	L: PROTECTION FUNCTION.....	270
B.10	N: SPECIAL ADJUSTMENT.....	273
B.11	O: OPERATOR-RELATED SETTINGS.....	274
B.12	S: SPECIAL APPLICATION.....	276
B.13	U: MONITORS.....	280
B.14	Z: BYPASS PARAMETERS.....	289
B.15	DEFAULTS BY DRIVE MODEL.....	298

B.1 Parameter Groups

B.1 Parameter Groups

Table B.1 Parameter Groups

Parameter Group	Name	Page	Parameter Group	Name	Page
A1	Initialization Parameters	257	L4	Speed Detection	271
b1	Operation Mode Selection	258	L5	Fault Restart	271
b2	DC Injection Braking and Short Circuit Braking	258	L6	Torque Detection	272
b3	Speed Search	258	L8	Drive Protection	272
b5	PID Control	259	n1	Hunting Prevention	273
C1	Acceleration and Deceleration Times	262	n3	High Slip Braking (HSB) and Overexcitation Braking	273
C2	S-Curve Characteristics	262	o1	HOA Keypad Display Selection	274
C4	Torque Compensation	262	o2	HOA Keypad Functions	274
C6	Carrier Frequency	262	o4	Maintenance Monitor Settings	275
d1	Frequency Reference	263	S1	Dynamic Noise Control Function	276
d2	Frequency Upper/Lower Limits	263	S2	Sequence Timer Operation	276
d3	Jump Frequency	263	T1	Induction Motor Auto-Tuning	278
E1	V/f Pattern for Motor 1	264	UB	Bypass Control Monitors	280
E2	Motor 1 Parameters	264	U1	Operation Status Monitors	282
F6	Drive/Bypass Communications	265	U2	Fault Trace	283
H1	Multi-Function Digital Inputs	266	U3	Fault History	284
H2 ^{<1>}	Multi-Function Digital Outputs	117	U4	Maintenance Monitors	285
H3	Multi-Function Analog Inputs	267	U5	PID Monitors	287
H4	Multi-Function Analog Outputs	268	Z1	Bypass Control System	289
H5 ^{<2>}	MEMOBUS/Modbus Serial Communication	269	Z2	Bypass Control Input/Output	293
L1	Motor Protection	270	Z3	Bypass Control Communication	294
L2	Momentary Power Loss Ride-Thru	270	Z4	Bypass Control Option Boards	296
L3	Stall Prevention	270			

<1> Available in bypass controller software versions VST800298 and later.

<2> Available in bypass controller software versions VST800297 and earlier.

Table B.2 Symbols and Icons Used in Parameter Descriptions

Symbol	Description
RUN	Parameter can be changed during run.

B.2 A: Initialization Parameters

◆ A1: Initialization

No. (Addr. Hex)	Name	Description	Values	Page
A1-06 (127)	Application Preset	0: General-purpose 8: Pump 9: Pump w/PI 10: Fan 11: Fan w/PI Note: This parameter is not settable. It is used as a monitor only.	Default: 0 Range: 0; 8 to 11	82

B.3 b: Application

B.3 b: Application

Application parameters configure the source of the Run command, DC Injection Braking, Speed Search, timer functions, PID control, the Dwell function, Energy Savings, and a variety of other application-related settings.

◆ b1: Operation Mode Selection

No. (Addr. Hex)	Name	Description	Values	Page
b1-03 (182)	Stopping Method Selection	0: Ramp to stop 1: Coast to stop 2: DC Injection Braking to stop 3: Coast with timer	Default: 1 Range: 0 to 3	83
b1-04 (183)	Reverse Operation Selection	0: Reverse enabled 1: Reverse disabled	Default: 1 Range: 0, 1	84

◆ b2: DC Injection Braking and Short Circuit Braking

No. (Addr. Hex)	Name	Description	Values	Page
b2-01 (189)	DC Injection Braking Start Frequency	Sets the frequency at which DC Injection Braking starts when “Ramp to stop” (b1-03 = 0) is selected.	Default: 0.5 Hz Min.: 0.0 Max.: 10.0	85
b2-02 (18A)	DC Injection Braking Current	Sets the DC Injection Braking current as a percentage of the drive rated current.	Default: 50% Min.: 0 Max.: 100	85
b2-03 (18B)	DC Injection Braking Time at Start	Sets DC Injection Braking time at start. Disabled when set to 0.00 seconds.	Default: 0.00 s Min.: 0.00 Max.: 10.00	85
b2-04 (18C)	DC Injection Braking Time at Stop	Sets DC Injection Braking time at stop.	Default: 0.50 s Min.: 0.00 Max.: 10.00	85

◆ b3: Speed Search

No. (Addr. Hex.)	Name	Description	Values	Page
b3-01 (191)	Speed Search Selection at Start	0: Disabled 1: Enabled	Default: 0 Range: 0, 1	88
b3-02 (192)	Speed Search Deactivation Current	Sets the current level at which the speed is assumed to be detected and Speed Search is ended. Set as a percentage of the drive rated current.	Default: 120% Min.: 0 Max.: 200	88
b3-03 (193)	Speed Search Deceleration Time	Sets output frequency reduction time during Speed Search.	Default: 2.0 s Min.: 0.1 Max.: 10.0	89
b3-04 (194)	V/f Gain during Speed Search	Determines how much to lower the V/f ratio during Speed Search. Output voltage during Speed Search equals the V/f setting multiplied by b3-04.	Default: <I> Min.: 10% Max.: 100%	89
b3-05 (195)	Speed Search Delay Time	When using an external contactor on the output side, b3-05 delays executing Speed Search after a momentary power loss to allow time for the contactor to close.	Default: 0.2 s Min.: 0.0 Max.: 100.0	89
b3-06 (196)	Output Current 1 during Speed Search	Sets the current injected to the motor at the beginning of Speed Estimation Speed Search. Set as a coefficient for the motor rated current.	Default: <I> Min.: 0.0 Max.: 2.0	89
b3-10 (19A)	Speed Search Detection Compensation Gain	Sets the gain which is applied to the speed detected by Speed Estimation Speed Search before the motor is reaccelerated. Increase this setting if ov occurs when performing Speed Search after a relatively long period of baseblock.	Default: 1.05 Min.: 1.00 Max.: 1.20	89
b3-14 (19E)	Bi-Directional Speed Search Selection	0: Disabled (uses the direction of the frequency reference) 1: Enabled (drive detects which way the motor is rotating)	Default: 1 Range: 0, 1	89

B.3 b: Application

No. (Addr. Hex.)	Name	Description	Values	Page
b3-17 (1F0)	Speed Search Restart Current Level	Sets the Speed Search restart current level as a percentage of the drive rated current.	Default: 150% Min.: 0 Max.: 200	90
b3-18 (1F1)	Speed Search Restart Detection Time	Sets the time to detect Speed Search restart.	Default: 0.10 s Min.: 0.00 Max.: 1.00	90
b3-19 (1F2)	Number of Speed Search Restarts	Sets the number of times the drive can attempt to restart when performing Speed Search.	Default: 3 Min.: 0 Max.: 10	90
b3-24 (1C0)	Speed Search Method Selection	0: Current Detection 1: Speed Estimation	Default: 0 Range: 0, 1	90
b3-25 (1C8)	Speed Search Wait Time	Sets the time the drive must wait between each Speed Search restart attempt.	Default: 0.5 s Min.: 0.0 Max.: 30.0	90
b3-27 (1C9)	Start Speed Search Select	Selects a condition to activate Speed Search Selection at Start (b3-01) or External Speed Search Command 1 or 2 from the multi-function input. 0: Triggered when a Run command is issued (normal). 1: Triggered when an external baseblock is released.	Default: 0 Range: 0, 1	90

<1> Default setting is dependent on parameter o2-04, Drive Model Selection.

◆ b5: PID Control

No. (Addr. Hex.)	Name	Description	Values	Page
b5-01 (1A5)	PID Function Setting	0: Disabled 1: Enabled (PID output becomes output frequency reference, deviation D controlled)	Default: 0 Range: 0, 1	94
b5-02 (1A6) [RUN]	Proportional Gain Setting (P)	Sets the proportional gain of the PID controller.	Default: 1.00 Min.: 0.00 Max.: 25.00	94
b5-03 (1A7) [RUN]	Integral Time Setting (I)	Sets the integral time for the PID controller.	Default: 1.0 s Min.: 0.0 Max.: 360.0	94
b5-04 (1A8) [RUN]	Integral Limit Setting	Sets the maximum output possible from the integrator as a percentage of the maximum output frequency.	Default: 100.0% Min.: 0.0 Max.: 100.0	94
b5-05 (1A9)	Derivative Time (D)	Sets D control derivative time.	Default: 0.00 s Min.: 0.00 Max.: 10.00	94
b5-06 (1AA) [RUN]	PID Output Limit	Sets the maximum output possible from the entire PID controller as a percentage of the maximum output frequency.	Default: 100.0% Min.: 0.0 Max.: 100.0	94
b5-07 (1AB) [RUN]	PID Offset Adjustment	Applies an offset to the PID controller output. Set as a percentage of the maximum output frequency.	Default: 0.0% Min.: -100.0 Max.: 100.0	94
b5-08 (1AC) [RUN]	PID Primary Delay Time Constant	Sets a low pass filter time constant on the output of the PID controller.	Default: 0.00 s Min.: 0.00 Max.: 10.00	94
b5-09 (1AD)	PID Output Level Selection	0: Normal output (direct acting) 1: Reverse output (reverse acting)	Default: 0 Range: 0, 1	95
b5-10 (1AE)	PID Output Gain Setting	Sets the gain applied to the PID output.	Default: 1.00 Min.: 0.00 Max.: 25.00	95
b5-11 (1AF)	PID Output Reverse Selection	0: Negative PID output triggers zero limit. 1: Rotation direction reverses with negative PID output. Note: When using setting 1, make sure reverse operation is permitted by b1-04.	Default: 0 Range: 0, 1	95

Parameter List

B

B.3 b: Application

No. (Addr. Hex)	Name	Description	Values	Page
b5-12 (1B0)	PID Feedback Loss Detection Selection	0: No fault, Digital output only. 0: DO Only - Always 1: Fault detection, Alarm output, drive continues operation. 1: Alarm - Always 2: Fault detection, Fault output, drive output is shut off. 2: Fault - Always 3: Digital Output Always 3: DO Only@PID Enbl 4: Feedback Loss Alarm 4: Alarm @ PID Enbl 5: Feedback Loss Fault 5: Fault @ PID Enbl	Default: 0 Range: 0 to 5	96
b5-13 (1B1)	PID Feedback Loss Detection Level	Sets the PID feedback loss detection level as a percentage of the maximum output frequency.	Default: 0% Min.: 0 Max.: 100	96
b5-14 (1B2)	PID Feedback Loss Detection Time	Sets a delay time for PID feedback loss.	Default: 1.0 s Min.: 0.0 Max.: 25.5	96
b5-15 (1B3)	PID Sleep Function Start Level	Sets the frequency level that triggers the sleep function.	Default: 0.0 Hz Min.: 0.0 Max.: 400.0	97
b5-16 (1B4)	PID Sleep Delay Time	Sets a delay time before the sleep function is triggered.	Default: 0.0 s Min.: 0.0 Max.: 25.5	98
b5-17 (1B5)	PID Accel/Decel Time	Sets the acceleration and deceleration time to PID setpoint.	Default: 0.0 s Min.: 0.0 Max.: 6000.0	98
b5-18 (1DC)	PID Setpoint Selection	0: Disabled 1: Enabled	Default: 0 Range: 0, 1	98
b5-19 (1DD)	PID Setpoint Value	Sets the PID target value as a percentage of the maximum output frequency when b5-18 is set to 1. Note: Values set above b5-38 will be internally limited to b5-38	Default: 0.00% Min.: 0.00 Max.: 100.00	98
b5-20 (1E2)	PID Setpoint Scaling	0: 0.01 Hz units 1: 0.01% units (100% = max output frequency) 2: RPM (number of motor poles must entered) 3: User-set (set scaling to b5-38 and b5-39, units based on b5-46 setting)	Default: 1 Range: 0 to 3	98
b5-34 (19F) [RUN]	PID Output Lower Limit	Sets the minimum output possible from the PID controller as a percentage of the maximum output frequency.	Default: 0.0% Min.: -100.0 Max.: 100.0	99
b5-35 (1A0) [RUN]	PID Input Limit	Limits the PID control input (deviation signal) as a percentage of the maximum output frequency. Acts as a bipolar limit.	Default: 1000.0% Min.: 0.0 Max.: 1000.0	99
b5-36 (1A1)	PID Feedback High Detection Level	Sets the PID feedback high detection level as a percentage of the maximum output frequency.	Default: 100% Min.: 0 Max.: 100	97
b5-37 (1A2)	PID Feedback High Detection Time	Sets the PID feedback high level detection delay time.	Default: 1.0 s Min.: 0.0 Max.: 25.5	97
b5-38 (1FE)	PID Setpoint User Display	Scales the PID units to the maximum output frequency.	Default: 10000 Min.: 1 Max.: 60000	99
b5-39 (1FF)	PID Setpoint Display Digits	0: No decimal places 1: One decimal place 2: Two decimal places 3: Three decimal places	Default: 2 Range: 0 to 3	99
b5-40 (17F)	Frequency Reference Monitor Content during PID	0: Display the frequency reference (U1-01) after PID compensation has been added. 1: Display the frequency reference (U1-01) before PID compensation has been added.	Default: 0 Range: 0, 1	99

B.3 b: Application

No. (Addr. Hex)	Name	Description	Values	Page
b5-46 (165)	PID Units Selection	Sets the display units for parameter b5-19, and monitors U5-01, U5-04 and U5-99 0: WC (Inch of water) 1: PSI (Pounds per square inch) 2: GPM (Gallons per minute) 3: F (Degrees Fahrenheit) 4: CFM (Cubic feet per minute) 5: CMH (Cubic meters per hour) 6: LPH (Liters per hour) 7: LPS (Liters per second) 8: Bar (Bar) 9: Pa (Pascal) 10: C (Degrees Celsius) 11: Mtr (Meters) 12: Ft (Feet) 13: LPM (Liters per minute) 14: CMM (Cubic meters per minute) 15: "Hg (Inches of Mercury) 25: No unit	Default: 0 Range: 0 to 15; 25	100
b5-47 (17D)	Reverse Operation Selection 2 by PID Output	0: Zero limit when PID output is a negative value. 1: Reverse operation when PID output is a negative value (Zero limit if the reverse operation is prohibited by b1-04).	Default: 1 Range: 0, 1	100
b5-89 (B89) [RUN]	Sleep Method Selection	Determines how the drive sleeps and wakes-up when using PID. 0: Standard 1: EZ Sleep/Wake-up	Default: 0 Range: 0, 1	101
b5-90 (B90) <2>	EZ Sleep Unit	Sets the unit, range, and resolution of parameters b5-91 and b5-92. 0: Hz 1: RPM (number of motor poles must be entered)	Default: 0 Range: 0, 1	101
b5-91 (B91) [RUN] <2>	EZ Minimum Speed	Sets the PID minimum speed and integral lower limit. The internal value is lower limited to the higher setting between b5-34 and d2-02.	Default: 0.0 Hz Range: 0.0 to 400.0 Hz or 0 to 24000 RPM <3>	101
b5-92 (B92) [RUN] <2>	EZ Sleep Level	The drive will go to sleep when the drive output frequency (or speed) is at or below this level for the time set in b5-93. This parameter is internally lower limited to b5-91 (EZ Min Speed) + 1Hz.	Default: 0.0 Hz Range: 0.0 to 400.0 Hz or 0 to 24000 RPM <3>	102
b5-93 (B93) [RUN] <2>	EZ Sleep Time	The drive will go to sleep when the drive output frequency is at or below the level set to b5-92 for the time set in this parameter.	Default: 5.0 s Min.: 0.0 Max.: 1000.0	102
b5-94 (B94) [RUN] <2>	EZ Wake-up Level	When b5-95 is set to 0 (Absolute), the drive wakes-up when the PID Feedback (H3-□□ = 20) drops below this level for the time set in b5-96. For reverse-acting, the PID Feedback must be above this level for the time set in b5-96. When b5-95 is set to 1 (Setpoint Delta), the drive wakes-up when the PID Feedback (H3-□□ = 20) drops below the PID Setpoint minus this level (for normal acting PID) for the time set in b5-96. For reverse-acting, Wake-up level is PID Setpoint plus this level. The PID Feedback must be above the wake-up level for the time set in b5-96.	Default: 0.00% Min.: 0.00 Max.: 600.00	102
b5-95 (B95) <2>	EZ Wake-up Mode	Sets how the wake-up level is determined. 0: Absolute 1: Setpoint Delta	Default: 0 Range: 0, 1	102
b5-96 (B96) [RUN] <2>	EZ Wake-up Time	The drive will wake up when the PID Feedback drops below the b5-94, EZ Wake-up Level for the time set in this parameter.	Default: 1.0 s Min.: 0.0 Max.: 1000.0	102

<2> Parameter is only effective when EZ Sleep is enabled by setting b5-89 to 1.

<3> Unit, range and resolution is determined by b5-90. Changing b5-90 will not automatically update the value of this parameter.

Parameter List

B

B.4 C: Tuning

B.4 C: Tuning

C parameters are used to adjust the acceleration and deceleration times and carrier frequency selections.

◆ C1: Acceleration and Deceleration Times

No. (Addr. Hex)	Name	Description	Values	Page
C1-01 (200) RUN	Acceleration Time 1	Sets the time to accelerate from 0 to maximum frequency.	Default: 10.0 s Min.: 0.0 Max.: 6000.0	103
C1-02 (201) RUN	Deceleration Time 1	Sets the time to decelerate from maximum frequency to 0.		103
C1-09 (208)	Fast Stop Time	Sets the time for the Fast Stop function.	Default: 10.0 s Min.: 0.0 Max.: 6000.0	103

◆ C2: S-Curve Characteristics

No. (Addr. Hex)	Name	Description	Values	Page
C2-01 (20B)	S-Curve Characteristic at Accel Start	<p>The S-curve can be controlled at the four points shown below.</p> <p>Run Command: ON, OFF Output Frequency: C2-01, C2-02, 0.20 s <1>, 0.20 s <1> Time</p>	Default: 0.20 s Min.: 0.00 Max.: 10.00	103
C2-02 (20C)	S-Curve Characteristic at Accel End		Default: 0.20 s Min.: 0.00 Max.: 10.00	103

<1> S-curve characteristics at decel start/end are fixed to 0.20 s.

◆ C4: Torque Compensation

No. (Addr. Hex)	Name	Description	Values	Page
C4-01 (215) RUN	Torque Compensation Gain	Sets the gain for the automatic torque (voltage) boost function and helps to produce better starting torque. Used for motor 1.	Default: 1.00 Min.: 0.00 Max.: 2.50	104

◆ C6: Carrier Frequency

No. (Addr. Hex)	Name	Description	Values	Page
C6-02 (224)	Carrier Frequency Selection	1: 2.0 kHz 1: Fc = 2.0 kHz 2: 5.0 kHz 2: Fc = 5.0 kHz 3: 8.0 kHz 3: Fc = 8.0 kHz 4: 10.0 kHz 4: Fc = 10.0 kHz 5: 12.5 kHz 5: Fc = 12.5 kHz 6: 15.0 kHz (12.0 kHz) 7: Swing PWM1 (Audible sound 1) 8: Swing PWM2 (Audible sound 2) 9: Swing PWM3 (Audible sound 3) A: Swing PWM4 (Audible sound 4)	Default: 7 Range: 1 to A	104
C6-05 (227)	Carrier Frequency Proportional Gain	Determines the proportional gain for the carrier frequency.	Default: <1> Min.: 0 Max.: 99	105

<1> Default setting value is dependent on parameter C6-02, Carrier Frequency Selection.

B.5 d: References

Reference parameters set the various frequency reference values during operation.

◆ d1: Frequency Reference

No. (Addr. Hex)	Name	Description	Values	Page
d1-01 (280) RUN	Frequency Reference 1	Sets the frequency reference for the drive. Setting units are determined by parameter o1-03.	Default: 0.00 Hz Min.: 0.00 Max.: 60.00	106
d1-02 (281) RUN	Frequency Reference 2	Sets the frequency reference for the drive. Setting units are determined by parameter o1-03.	Default: 0.00 Hz Min.: 0.00 Max.: 60.00	106
d1-03 (282) RUN	Frequency Reference 3	Sets the frequency reference for the drive. Setting units are determined by parameter o1-03.	Default: 0.00 Hz Min.: 0.00 Max.: 60.00	106
d1-04 (283) RUN	Frequency Reference 4	Sets the frequency reference for the drive. Setting units are determined by parameter o1-03.	Default: 0.00 Hz Min.: 0.00 Max.: 60.00	106

◆ d2: Frequency Upper/Lower Limits

No. (Addr. Hex.)	Name	Description	Setting	Page
d2-01 (289)	Frequency Reference Upper Limit	Sets the frequency reference upper limit as a percentage of the maximum output frequency.	Default: 100.0% Min.: 0.0 Max.: 110.0	107
d2-02 (28A)	Frequency Reference Lower Limit	Sets the frequency reference lower limit as a percentage of the maximum output frequency.	Default: 0.0% Min.: 0.0 Max.: 110.0	107
d2-03 (293)	Master Speed Reference Lower Limit	Sets the lower limit for frequency references from analog inputs as a percentage of the maximum output frequency.	Default: 0.0% Min.: 0.0 Max.: 110.0	107

◆ d3: Jump Frequency

No. (Addr. Hex)	Name	Description	Values	Page
d3-01 (294)	Jump Frequency 1	Eliminates problems with resonant vibration of the motor/machine by avoiding continuous operation in predefined frequency ranges. The drive accelerates and decelerates the motor through the prohibited frequency ranges. Setting 0.0 disables this function. Parameters must be set so that $d3-01 \geq d3-02 \geq d3-03$.	Default: 0.0 Hz Min.: 0.0 Max.: 400.0	108
d3-02 (295)	Jump Frequency 2	Eliminates problems with resonant vibration of the motor/machine by avoiding continuous operation in predefined frequency ranges. The drive accelerates and decelerates the motor through the prohibited frequency ranges. Setting 0.0 disables this function. Parameters must be set so that $d3-01 \geq d3-02 \geq d3-03$.	Default: 0.0 Hz Min.: 0.0 Max.: 400.0	108
d3-03 (296)	Jump Frequency 3	Eliminates problems with resonant vibration of the motor/machine by avoiding continuous operation in predefined frequency ranges. The drive accelerates and decelerates the motor through the prohibited frequency ranges. Setting 0.0 disables this function. Parameters must be set so that $d3-01 \geq d3-02 \geq d3-03$.	Default: 0.0 Hz Min.: 0.0 Max.: 400.0	108
d3-04 (297)	Jump Frequency Width	Sets the dead-band width around each selected prohibited frequency reference point.	Default: 1.0 Hz Min.: 0.0 Max.: 20.0	108

B.6 E: Motor Parameters

B.6 E: Motor Parameters

◆ E1: V/f Pattern for Motor 1

No. (Addr. Hex)	Name	Description	Values	Page
E1-01 (300)	Input Voltage Setting	This parameter must be set to the power supply voltage. WARNING! Electrical Shock Hazard. Drive input voltage (not motor voltage) must be set in E1-01 for the protective features of the drive to function properly. Failure to do so may result in equipment damage and/or death or personal injury.	Default: 460 V <1> Min.: 310 Max.: 510 <1>	109
E1-03 (302)	V/f Pattern Selection	0: 50 Hz, Constant torque 1 1: 60 Hz Saturation 2: 50 Hz Saturation 3: 72 Hz, Constant torque 4 (60 Hz base) 4: 50 Hz, Variable torque 1 5: 50 Hz, Variable torque 2 6: 60 Hz, Variable torque 1 7: 60 Hz, Variable torque 2 8: 50 Hz, High starting torque 1 9: 50 Hz, High starting torque 2 A: 60 Hz, High starting torque 3 B: 60 Hz, High starting torque 4 C: 90 Hz (60 Hz base) D: 120 Hz (60 Hz base) E: 180 Hz (60 Hz base) F: Custom V/f E1-05 setting defines the V/f pattern	Default: F <2> Range: 0 to 9; A to F	109
E1-05 (304)	Maximum Voltage	Only applicable when E1-03 is set to F.	Default: <3> Min.: 0.0 V Max.: 510.0 V <1>	112

<1> Values shown are specific to 480 Vac bypass drives.

<2> Parameter setting value is not reset to the default value when the drive is initialized.

<3> Default setting is dependent on parameter o2-04, Drive Model Selection.

◆ E2: Motor Parameters

No. (Addr. Hex)	Name	Description	Values	Page
E2-01 (030E)	Motor Rated Current	Sets the motor nameplate full load current in amps. Automatically set during Auto-Tuning.	Default: <1> Min.: 10% of drive rated current Max.: 200% of drive rated current <2>	113
E2-03 (310)	Motor No-Load Current	Sets the no-load current for the motor. Automatically set during Auto-Tuning.	Default: <1> Min.: 0 A Max.: E2-01 <2>	113

<1> Default setting is dependent on parameter o2-04, Drive Model Selection.

<2> The number of decimal places in the parameter value depends on the drive model. *Refer to Defaults by Drive Model on page 298* for details.

B.7 F: Options

F parameters control the communication between the drive and the bypass.

◆ F6: Drive/Bypass Communications

No. (Addr. Hex)	Name	Description	Values	Page
F6-01	Communication Error Operation Selection	Selects the drive behavior when the drive detects a CE fault. 0: Ramp to Stop. Decelerate to stop using the deceleration time in C1-02. 1: Coast to Stop. 2: Fast-Stop. Decelerate to stop using the deceleration time in C1-09. 3: Alarm only. 4: Alarm (d1-04)	Default: 1 Range: 0 to 4	114
F6-02 (03A3)	External Fault from Bypass Controller Detection Selection	Selects when the drive should detect an EF0 fault issued by the bypass controller. 0: Always detected 1: Only during run	Default: 0 Range: 0, 1	114
F6-03 (03A4)	External Fault from Bypass Controller Operation Selection	0: Ramp to Stop. Decelerate to stop using the deceleration time in C1-02. 1: Coast to Stop. 2: Fast-Stop. Decelerate to stop using the deceleration time in C1-09. 3: Alarm Only.	Default: 1 Range: 0 to 3	114

B.8 H Parameters: Multi-Function Terminals

B.8 H Parameters: Multi-Function Terminals

H parameters assign functions to the multi-function input and output terminals.

◆ H1: Multi-Function Digital Inputs

No. (Addr. Hex)	Name	Description	Values	Page
H1-03 (400)	Multi-Function Digital Input Terminal S3 Function Selection	Assigns a function to the multi-function digital inputs through Z2-□□ = 3. Refer to Table B.3 for descriptions of setting values. Note: Set unused terminals to F.	Default: 24 Min.: 3 Max.: 60	115
H1-04 (401)	Multi-Function Digital Input Terminal S4 Function Selection	Assigns a function to the multi-function digital inputs through Z2-□□ = 4. Refer to Table B.3 for descriptions of setting values. Note: Set unused terminals to F.	Default: 14 Min.: 3 Max.: 60	115
H1-05 (402)	Multi-Function Digital Input Terminal S5 Function Selection	Assigns a function to the multi-function digital inputs through Z2-□□ = 5. Refer to Table B.3 for descriptions of setting values. Note: Set unused terminals to F.	Default: 3 Min.: 3 Max.: 60	115
H1-06 (403)	Multi-Function Digital Input Terminal S6 Function Selection	Assigns a function to the multi-function digital inputs through Z2-□□ = 6. Refer to Table B.3 for descriptions of setting values. Note: Set unused terminals to F.	Default: 4 Min.: 3 Max.: 60	115
H1-07 (404)	Multi-Function Digital Input Terminal S7 Function Selection	Assigns a function to the multi-function digital inputs through Z2-□□ = 7. Refer to Table B.3 for descriptions of setting values. Note: Set unused terminals to F.	Default: 6 Min.: 3 Max.: 60	115
H1-08 (405)	Multi-Function Digital Input Terminal S8 Function Selection	Assigns a function to the multi-function digital inputs through Z2-□□ = 8. Refer to Table B.3 for descriptions of setting values. Note: Set unused terminals to F.	Default: F Min.: 3 Max.: 60	115

Table B.3 H1 Multi-Function Digital Input Selections

H1-□□ Setting	Function	Description	Page
3	Multi-Step Speed Reference 1	When input terminals are set to Multi-Step Speed References 1 through 3, switching combinations of those terminals will create a multi-step speed sequence using the frequency references set in d1-01 through d1-08.	115
4	Multi-Step Speed Reference 2	When input terminals are set to Multi-Step Speed References 1 through 3, switching combinations of those terminals will create a multi-step speed sequence using the frequency references set in d1-01 through d1-08.	115
6	Jog reference selection	Closed: Jog frequency reference (d1-17) selected. Jog has priority over all other reference sources.	115
C	Analog terminal input selection	Open: Function assigned by H3-14 is disabled. Closed: Function assigned by H3-14 is enabled.	115
F <I>	Not Used (Through Mode)	Allows serial communications to control the output.	115
10	Up command	The drive accelerates when the Up command terminal closes, and decelerates when the Down command closes. When both terminals are closed or both are open, the drive holds the frequency reference. The Up and Down commands must always be used in conjunction with one another.	115
11	Down command	The drive accelerates when the Up command terminal closes, and decelerates when the Down command closes. When both terminals are closed or both are open, the drive holds the frequency reference. The Up and Down commands must always be used in conjunction with one another.	115
13 <2>	Reverse Jog	Closed: Runs reverse at the Jog frequency d1-17	116
14	Fault Reset	Closed: Resets faults if the cause is cleared and the Run command is removed.	117
19	PID disable	Open: PID control enabled Closed: PID control disabled	117
24	External fault	Normally Open, Always Detected, Coast to Stop	117
60	DC Injection Braking command	Closed: Triggers DC Injection Braking.	117

<1> Available in bypass controller software versions VST800298 and later.

<2> Available in bypass controller software versions VST800297 and earlier.

◆ H3: Multi-Function Analog Inputs

No. (Addr. Hex)	Name	Description	Values	Page
H3-01 (410)	Terminal A1 Signal Level Selection	0: 0 to 10 V with zero limit 1: 0 to 10 V without zero limit 2: 4 to 20 mA 3: 0 to 20 mA Note: Use jumper switch S1 to set input terminal A1 for current or voltage.	Default: 0 Range: 0 to 3	124
H3-02 (434)	Terminal A1 Function Selection	Sets the function of terminal A1.	Default: 0 Range: 0 to 26	125
H3-03 (411) RUN	Terminal A1 Gain Setting	Sets the level of the input value selected in H3-02 when 10 V is input at terminal A1.	Default: 100.0% Min.: -999.9 Max.: 999.9	125
H3-04 (412) RUN	Terminal A1 Bias Setting	Sets the level of the input value selected in H3-02 when 0 V is input at terminal A1.	Default: 0.0% Min.: -999.9 Max.: 999.9	125
H3-05 (413)	Terminal A3 Signal Level Selection	0: 0 to 10 V with zero limit 1: 0 to 10 V without zero limit 2: 4 to 20 mA 3: 0 to 20 mA Note: Use Jumper S1 to set input terminal A3 for a current or voltage input signal.	Default: 0 Range: 0 to 3	127
H3-06 (414)	Terminal A3 Function Selection	Sets the function of terminal A3.	Default: 2 Range: 0 to 26	127
H3-07 (415) RUN	Terminal A3 Gain Setting	Sets the level of the input value selected in H3-06 when 10 V is input at terminal A3.	Default: 100.0% Min.: -999.9 Max.: 999.9	127
H3-08 (416) RUN	Terminal A3 Bias Setting	Sets the level of the input value selected in H3-06 when 0 V is input at terminal A3.	Default: 0.0% Min.: -999.9 Max.: 999.9	127
H3-09 (417)	Terminal A2 Signal Level Selection	0: 0 to 10 V with zero limit 1: 0 to 10 V without zero limit 2: 4 to 20 mA 3: 0 to 20 mA Note: Use jumper switch S1 to set input terminal A2 for current or voltage input signal.	Default: 2 Range: 0 to 3	127
H3-10 (418)	Terminal A2 Function Selection	Sets the function of terminal A2.	Default: 0 Range: 0 to 26	127
H3-11 (419) RUN	Terminal A2 Gain Setting	Sets the level of the input value selected in H3-10 when 10 V (20 mA) is input at terminal A2.	Default: 100.0% Min.: -999.9 Max.: 999.9	128
H3-12 (41A) RUN	Terminal A2 Bias Setting	Sets the level of the input value selected in H3-10 when 0 V (0 or 4 mA) is input at terminal A2.	Default: 0.0% Min.: -999.9 Max.: 999.9	128
H3-13 (41B)	A1/A2 Input Filter Time Constant	Sets a primary delay filter time constant for terminals A1 and A2. Used for noise filtering.	Default: 0.03 s Min.: 0.00 Max.: 2.00	128
H3-14 (41C)	Analog Input Terminal Enable Selection	Determines which analog input terminals will be enabled when a digital input programmed for "Analog input enable" (H1-□□ = C) is activated. 1: Terminal A1 only 2: Terminal A2 only 3: Terminals A1 and A2 only 4: Terminal A3 only 5: Terminals A1 and A3 6: Terminals A2 and A3 7: All terminals enabled	Default: 7 Range: 1 to 7	128
H3-16 (2F0)	Terminal A1 Offset	Adds an offset when the analog signal to terminal A1 is at 0 V.	Default: 0 Min.: -500 Max.: 500	129

Parameter List

B

B.8 H Parameters: Multi-Function Terminals

No. (Addr. Hex)	Name	Description	Values	Page
H3-17 (2F1)	Terminal A2 Offset	Adds an offset when the analog signal to terminal A2 is at 0 V.	Default: 0 Min.: -500 Max.: 500	129
H3-18 (2F2)	Terminal A3 Offset	Adds an offset when the analog signal to terminal A3 is at 0 V.	Default: 0 Min.: -500 Max.: 500	128

H3 Multi-Function Analog Input Settings				
H3-□□ Setting	Function	Description	Values	Page
0	Frequency bias	10 V = E1-04 (maximum output frequency)		129
1	Frequency gain	0 to 10 V signal allows a setting of 0 to 100%. -10 to 0 V signal allows a setting of -100 to 0%.		129
2	Auxiliary frequency reference 1 (used as a Multi-Step Speed 2)	10 V = E1-04 (maximum output frequency)		129
3	Auxiliary frequency reference 2 (3rd step analog)	10 V = E1-04 (maximum output frequency)		129
4	Output voltage bias	10 V = E1-05 (motor rated voltage)		129
5	Accel/decel time gain	10 V = 100%		129
6	DC Injection Braking current	10 V = Drive rated current		129
7	Overtorque/undertorque detection level	10 V = Drive rated current (V/f)		130
8	Stall Prevention level during run	10 V = Drive rated current		130
9	Output frequency lower limit level	10 V = E1-04 (maximum output frequency)		130
B	PID feedback	10 V = 100%		130
C	PID setpoint	10 V = 100%		130
D	Frequency bias	10 V = E1-04 (maximum output frequency)		130
E	Motor temperature (PTC input)	10 V = 100%		130
F	Not Used	Set this value when using the terminal in the pass-through mode.		130
16	Differential PID feedback	10 V = 100%		130
1F </>	HAND Reference	Sets the frequency reference when in HAND Mode and parameter Z1-41, HAND Speed Reference Selection, is set to 1 (Analog).		131
25	Secondary PI setpoint	10 V = S3-02 (maximum output frequency)		131
26	Secondary PI feedback	10 V = S3-02 (maximum output frequency)		131

<1> Setting 1F is "HAND Reference" in bypass controller software versions VST800298 and later. Setting 1F is "Not Used (Through Mode)" in bypass controller software versions VST800297 and earlier.

◆ H4: Analog Outputs

No. (Addr. Hex)	Name	LCD Display	Description	Values	Page
H4-01 (41D)	Multi-Function Analog Output Terminal FM Monitor Selection	Term FM FuncSel	Selects the data to be output through multi-function analog output terminal FM. Set the desired monitor parameter to the digits available in U□-□□. For example, enter "103" for U1-03.	Default: 102 Range: 000 to 621	131
H4-02 (41E) RUN	Multi-Function Analog Output Terminal FM Gain	Terminal FM Gain	Sets the signal level at terminal FM that is equal to 100% of the selected monitor value.	Default: 100.0% Min.: -999.9 Max.: 999.9	131
H4-03 (41F) RUN	Multi-Function Analog Output Terminal FM Bias	Terminal FM Bias	Sets the signal level at terminal FM that is equal to 0% of the selected monitor value.	Default: 0.0% Min.: -999.9 Max.: 999.9	131

B.8 H Parameters: Multi-Function Terminals

No. (Addr. Hex)	Name	LCD Display	Description	Values	Page
H4-04 (420)	Multi-Function Analog Output Terminal AM Monitor Selection	Terminal AM Sel	Selects the data to be output through multi-function analog output terminal AM. Set the desired monitor parameter to the digits available in U□-□□. For example, enter "103" for U1-03.	Default: 103 Range: 000 to 621	131
H4-05 (421) [RUN]	Multi-Function Analog Output Terminal AM Gain	Terminal AM Gain	Sets the signal level at terminal AM that is equal to 100% of the selected monitor value.	Default: 50.0% Min.: -999.9 Max.: 999.9	131
H4-06 (422) [RUN]	Multi-Function Analog Output Terminal AM Bias	Terminal AM Bias	Sets the signal level at terminal AM that is equal to 0% of the selected monitor value.	Default: 0.0% Min.: -999.9 Max.: 999.9	131
H4-07 (423)	Multi-Function Analog Output Terminal FM Signal Level Selection	Term FM Lvl Sel	0: 0 to 10 V 1: -10 to +10 V 2: 4 to 20 mA	Default: 0 Range: 0 to 2	132
H4-08 (424)	Multi-Function Analog Output Terminal AM Signal Level Selection	Term AM Lvl Sel	0: 0 to 10 V 1: -10 to +10 V 2: 4 to 20 mA	Default: 0 Range: 0 to 2	132

◆ H5: MEMOBUS/Modbus Serial Communication

No. (Addr. Hex)	Name	Description	Values	Page
H5-04 (428) <1>	Stopping Method after Communication Error (CE)	0: Ramp to Stop 1: Coast to Stop 2: Fast-Stop 3: Alarm only	Default: 3 Range: 0 to 3	133

<1> Parameter is only available in bypass controller software versions VST800297 and earlier.

B.9 L: Protection Function

B.9 L: Protection Function

L parameters provide protection to the drive and motor, including control during momentary power loss, stall prevention, frequency detection, fault restarts, overtorque and undertorque detection, and other types of hardware protection.

◆ L1: Motor Protection

No. (Addr. Hex)	Name	Description	Values	Page
L1-01 (480)	Motor Overload Protection Selection	0: Disabled 1: General purpose motor (standard fan cooled) The drive may not be able to provide protection when using multiple motors, even if overload is enabled in L1-01. Set L1-01 to 0 and install separate thermal relays to each motor.	Default: 1 Range: 0, 1	134
L1-02 (481)	Motor Overload Protection Time	Sets the motor thermal overload protection (oL1) time.	Default: 1.0 min Min.: 0.1 Max.: 5.0	135

◆ L2: Momentary Power Loss Ride-Thru

No. (Addr. Hex)	Name	Description	Values	Page
L2-01 (485)	Momentary Power Loss Operation Selection	0: Disabled. Drive trips on Uv1 fault when power is lost. 1: Recover within the time set in L2-02. Uv1 will be detected if power loss is longer than L2-02. Note: L2-02 is dependent on drive model selection and is not accessible. 2: Recover as long as CPU has power. Uv1 is not detected.	Default: 2 <1> Range: 0 to 2	135
L2-02 (486)	Momentary Power Loss Ride-Thru Time	Sets the Power Loss Ride-Thru time. Enabled only when L2-01 = 1 or 3.	Default: <2> Min.: 0.0 s Max.: 25.5 s	136
L2-03 (487)	Momentary Power Loss Minimum Baseblock Time	Sets the minimum wait time for residual motor voltage decay before the drive output reenergizes after performing Power Loss Ride-Thru. Increasing the time set to L2-03 may help if overcurrent or overvoltage occur during Speed Search or during DC Injection Braking.	Default: <2> Min.: 0.1 s Max.: 5.0 s	136
L2-05 (489)	Undervoltage Detection Level (Uv1)	Sets the DC bus undervoltage trip level.	Default: 190 Vdc <3> <4> Min.: 150 Vdc Max.: 220 Vdc <4>	136

<1> Default is 0 in bypass controller software versions VST800297 and earlier.

<2> Default setting is dependent on parameter o2-04, Drive Model Selection.

<3> Default setting is dependent on parameters o2-04, Drive Model Selection, and E1-01, Input Voltage Setting.

<4> Values shown are specific to 208 Vac. Double the value for 480 Vac.

◆ L3: Stall Prevention

No. (Addr. Hex)	Name	Description	Values	Page
L3-02 (490)	Stall Prevention Level during Acceleration	Used when L3-01 = 1 or 2. 100% is equal to the drive rated current.	Default: 120% Min.: 0 Max.: 120 <1>	136
L3-03 (491)	Stall Prevention Limit during Acceleration	Sets Stall Prevention lower limit during acceleration when operating in the constant power range. Set as a percentage of drive rated current.	Default: 50% Min.: 0 Max.: 100	137

B.9 L: Protection Function

No. (Addr. Hex)	Name	Description	Values	Page
L3-04 (492)	Stall Prevention Selection during Deceleration	0: Disabled. Deceleration at the active deceleration rate. An ov fault may occur. 1: General purpose. Deceleration is paused when the DC bus voltage exceeds the Stall Prevention level. 2: Intelligent. Decelerate as fast as possible while avoiding ov faults. 3: Stall Prevention with braking resistor. Stall Prevention during deceleration is enabled in coordination with dynamic braking. 4: High Flux Brake 5: High Flux Brake 2	Default: 1 Range: 0 to 5	137
L3-06 (494)	Stall Prevention Level during Run	Enabled when L3-05 is set to 1 or 2. 100% is equal to the drive rated current.	Default: 120% Min.: 30 Max.: 120 <1>	138
L3-11 (4C7)	Overvoltage Suppression Function Selection	Enables or disables the ov suppression function, which allows the drive to change the output frequency as the load changes to prevent an ov fault.	Default: 0 Range: 0, 1	138
L3-25 (46F)	Load Inertia Ratio	Sets the ratio between the motor and machine inertia.	Default: 1.0 Min.: 1.0 Max.: 1000.0	139

<1> Upper limit is dependent on parameter L8-38, Frequency Reduction Selection.

◆ L4: Speed Detection

No. (Addr. Hex)	Name	Description	Values	Page
L4-05 (49D)	Frequency Reference Loss Detection Selection	0: Stop. Drive stops when the frequency reference is lost. 1: Run. Drive runs at a reduced speed when the frequency reference is lost.	Default: 0 Range: 0, 1	139
L4-06 (4C2)	Frequency Reference at Reference Loss	Sets the percentage of the frequency reference that the drive should run with when the frequency reference is lost.	Default: 80.0% Min.: 0.0 Max.: 100.0	139

◆ L5: Fault Restart

No. (Addr. Hex)	Name	LCD Display	Description	Values	Page
L5-01 (49E)	Number of Auto Restart Attempts	Num of Restarts	Sets the number of times the drive may attempt to restart after the following faults occur: GF, LF, oC, ov, PF, oL1, oL2, oL3, STo, Uv1.	Default: 0 Min.: 0 Max.: 10	140
L5-02 (49F)	Auto Restart Fault Output Operation Selection	Restart Sel 0: Flt Outp Disabld 1: Flt Outp Enabled	0: Fault output not active. 1: Fault output active during restart attempt.	Default: 0 Range: 0, 1	140
L5-03 (4A0)	Time to Continue Making Fault Restarts	Max Restart Time	Enabled only when L5-05 is set to 0. Causes a fault if a fault restart cannot occur after the set time passes.	Default: 180.0 s Min.: 0.5 Max.: 180.0	140
L5-04 (46C)	Fault Reset Interval Time	Flt Reset Wait T	Sets the amount of time to wait between performing fault restarts.	Default: 10.0 s Min.: 0.5 Max.: 600.0	142
L5-05 (467)	Fault Reset Operation Selection	Fault Reset Sel 0: Continuous 1: Use L5-04 Time	0: Continuously attempt to restart while incrementing restart counter only at a successful restart (same as F7 and G7). 1: Attempt to restart with the interval time set in L5-04 and increment the restart counter with each attempt (same as V7).	Default: 0 Range: 0, 1	142

Parameter List

B

B.9 L: Protection Function

◆ L6: Torque Detection

No. (Addr. Hex)	Name	Description	Values	Page
L6-01 (4A1) <I>	Torque Detection Selection 1	0: Disabled 1: oL3 detection only active during speed agree, operation continues after detection 2: oL3 detection always active during run, operation continues after detection 3: oL3 detection only active during speed agree, output shuts down on an oL3 fault 4: oL3 detection always active during run, output shuts down on an oL3 fault 5: UL3 detection only active during speed agree, operation continues after detection 6: UL3 detection always active during run, operation continues after detection 7: UL3 detection only active during speed agree, output shuts down on an oL3 fault 8: UL3 detection always active during run, output shuts down on an oL3 fault	Default: 0 Range: 0 to 8	143
L6-02 (4A2)	Torque Detection Level 1	Sets the overtorque and undertorque detection level.	Default: 15% Min.: 0 Max.: 300	144
L6-03 (4A3)	Torque Detection Time 1	Sets the time an overtorque or undertorque condition must exist to trigger torque detection 1.	Default: 10.0 s Min.: 0.0 Max.: 10.0	144
L6-13 (62E)	Motor Underload Protection Selection	Sets the motor underload protection (UL□) based on motor load. 0: Overtorque/undertorque detection enabled 1: Base frequency motor load enabled	Default: 0 Range: 0, 1	145
L6-14 (62F)	Motor Underload Protection Level at Minimum Frequency	Sets the UL6 detection level at minimum frequency by percentage of drive rated current.	Default: 15% Min.: 0 Max.: 300	145

<I> Available in bypass controller software versions VST800298 and later.

◆ L8: Drive Protection

No. (Addr. Hex)	Name	Description	Values	Page
L8-02 (4AE)	Overheat Alarm Level	An overheat alarm occurs when heatsink temperature exceeds the L8-02 level.	Default: <I> Min.: 50 °C Max.: 150 °C	145
L8-05 (4B1)	Input Phase Loss Protection Selection	Selects the detection of input current phase loss, power supply voltage imbalance, or main circuit electrolytic capacitor deterioration. 0: Disabled 1: Enabled	Default: 1 Range: 0, 1	145
L8-06 (4B2)	Input Phase Detection Level	When ripple is observed in the DC bus, expansion of the input bias is calculated. This value becomes the input phase if the difference between the maximum and minimum values of the ripple is greater than the value set to L8-06. Detection Level = 100% = Voltage class x $\sqrt{2}$	Default: <I> Min.: 0.0% Max.: 50.0%	145
L8-07 (4B3)	Output Phase Loss Protection Selection	0: Disabled 1: Enabled (triggered by a single phase loss) 2: Enabled (triggered when two phases are lost)	Default: 1 Range: 0 to 2	146
L8-09 (4B5)	Output Ground Fault Detection Selection	0: Disabled 1: Enabled	Default: <I> Range: 0, 1	146
L8-38 (4EF)	Carrier Frequency Reduction	0: Disabled 1: Enabled below 6 Hz 2: Enabled for the entire speed range	Default: <I> Range: 0 to 2	147

<I> Default setting is dependent on parameter o2-04, Drive Model Selection.

B.10 n: Special Adjustment

The n parameters adjust more advanced performance characteristics such as Hunting Prevention, speed feedback detection, High Slip Braking, and Online Tuning for motor line-to-line resistance.

◆ n1: Hunting Prevention

No. (Addr. Hex)	Name	Description	Values	Page
n1-01 (580)	Hunting Prevention Selection	0: Disabled 1: Enabled	Default: 1 Range: 0, 1	148
n1-02 (581)	Hunting Prevention Gain Setting	If the motor vibrates while lightly loaded, increase the gain by 0.1 until vibration ceases. If the motor stalls, decrease the gain by 0.1 until the stalling ceases.	Default: 1.00 Min.: 0.00 Max.: 2.50	148

◆ n3: High Slip Braking (HSB) and Overexcitation Braking

No. (Addr. Hex)	Name	Description	Values	Page
n3-04 (58B)	High-Slip Braking Overload Time	Sets the time required for an HSB overload fault (oL7) to occur when the drive output frequency does not change during an HSB stop. This parameter does not typically require adjustment.	Default: 40 s Min.: 30 Max.: 1200	148
n3-13 (531)	Overexcitation Deceleration Gain	Sets the gain applied to the V/f pattern during Overexcitation Deceleration (L3-04 = 4).	Default: 1.10 Min.: 1.00 Max.: 1.40	149

B.11 o: Operator-Related Settings

B.11 o: Operator-Related Settings

The o parameters set up the digital operator displays.

◆ o1: HOA Keypad Display Selection

No. (Addr. Hex)	Name	Description	Values	Page
o1-01 (500) RUN <I>	Drive Mode Unit Monitor Selection	Selects the content of the last monitor that is shown when scrolling through Drive Mode display. Enter the last three digits of the monitor parameter number to be displayed: U□-□□.	Default: 106 Range: 104 to 699	150
o1-02 (501) RUN <I>	Drive Mode Unit Monitor Power Up	1: Frequency reference (U1-01) 2: Direction 3: Output frequency (U1-02) 4: Output current (U1-03) 5: User Monitor	Default: 1 Range: 1 to 5	150
o1-03 (502)	HOA Keypad Operator Display Selection	Sets the units the drive should use to display the frequency reference and motor speed monitors. 0: 0.01 Hz 1: 0.01% (100% = E1-04) 2: r/min (calculated using the number of motor poles setting in E2-04, E4-04, or E5-04) 3: User-selected units (set by o1-10 and o1-11)	Default: 0 Range: 0 to 3	150
o1-09 (51C)	Frequency Reference Display Units	Sets unit display for the frequency reference parameters and frequency related monitors when o1-03 = 3. 0: WC (Inch of water) 1: PSI (Pounds per square inch) 2: GPM (Gallons per minute) 3: F (Degrees Fahrenheit) 4: CFM (Cubic feet per minute) 5: CMH (Cubic meters per hour) 6: LPH (Liters per hour) 7: LPS (Liters per second) 8: Bar (Bar) 9: Pa (Pascal) 10: C (Degrees Celsius) 11: Mtr (Meters) 12: Ft (Feet) 13: LPM (Liters per minute) 14: CMM (Cubic meters per minute) 15: "Hg (inches of mercury) 24: Custom units (determined by o1-13 to o1-15) 25: No unit	Default: 25 Range: 0 to 15; 24, 25	151
o1-10 (520)	User-Set Display Units Maximum Value	These settings define the display values when o1-03 is set to 3. o1-10 sets the display value that is equal to the maximum output frequency. o1-11 sets the position of the decimal position.	Default: <2> Range: 1 to 60000	152
o1-11 (521)	User-Set Display Units Decimal Display	0: No decimal point 1: One decimal point 2: Two decimal points 3: Three decimal points	Default: <2> Range: 0 to 3	152

<1> Available in bypass controller software versions VST800401 and later.

<2> Default setting is dependent on parameter o1-03, HOA Keypad Display Selection.

◆ o2: HOA Keypad Functions

No. (Addr. Hex)	Name	Description	Values	Page
o2-04 (508)	Drive Model Selection	Enter the drive model. Setting required only if installing a new control board.	Default: Determined by drive capacity	152

◆ o4: Maintenance Monitor Settings

No. (Addr. Hex)	Name	Description	Values	Page
o4-03 (50E)	Cooling Fan Operation Time Setting	Sets the value of the fan operation time monitor U4-03 in units of 10 h.	Default: 0 h Min.: 0 Max.: 9999	152
o4-11 (0510) <I>	U2, U3, and UB-09 to UB-16 Initialization	0: The drive and bypass keep the previously saved record concerning fault trace and fault history. 1: Resets the data for the U2-□□, U3-□□, and UB-09 to UB-16 monitors. Setting o4-11 to 1 and pressing the ENTER key erases fault data in the bypass and drive and returns the display to 0.	Default: 0 Range: 0, 1	152

<I> Available in bypass controller software versions VST800298 and later.

B.12 S: Special Application

B.12 S: Special Application

◆ S1: Dynamic Noise Control Function

No. (Addr. Hex)	Name	LCD Display	Description	Values	Page
S1-01 (3200)	Dynamic Audible Noise Control Function Selection	Dyn Noise Ctrl 0: Disabled 1: Enabled	Reduces audible noise by decreasing the output voltage in variable torque applications with light loads. 0: Disabled 1: Enabled	Default: 0 Range: 0, 1	154
S1-02 (3201)	Voltage Reduction Rate	Volt Reduce Amt	Sets the rate at which the output voltage will be reduced as a percentage of the V/f pattern when operating with no load.	Default: 50.0% Min.: 50.0 Max.: 100.0	154
S1-03 (3202)	Voltage Restoration Level	V Reduce On Lvl	Sets the level when the drive should start restoring the voltage as a percentage of the drive rated torque.	Default: 20.0% Min.: 0.0 Max.: 90.0	154
S1-04 (3203)	Voltage Restoration Complete Level	V Reduce Off Lvl	Sets the level at which voltage restoration for the V/f pattern is complete as a percentage of the drive rated torque. If the output torque rises above the value of S1-04, then the voltage will be controlled in a manner specified by the V/f pattern setting.	Default: 50.0% Min.: S1-03 + 10.0 Max.: 100.0	155
S1-05 (3204)	Voltage Restoration Sensitivity Time Constant	Sensitivity Time	Sets the level of sensitivity of the output torque and LPF time constant for the voltage reduction rate. The level of sensitivity can be adjusted in accordance with the load response.	Default: 1.000 s Min.: 0.000 Max.: 3.000	155
S1-06 (3205)	Voltage Restoration Time Constant at Impact	Impact Load Time	Sets the voltage restoration time constant if an impact load is added.	Default: 0.050 s Min.: 0.000 Max.: 1.000	155

◆ S2: Sequence Timers

No. (Addr. Hex)	Name	LCD Display	Description	Values	Page
S2-01 (3206)	Sequence Timer 1 Start Time	Tmr 1 Start Time	Sets the start time for timer 1. The value must be set less than or equal to S2-02.	Default: 00:00 Min.: 00:00 Max.: 24:00	156
S2-02 (3207)	Sequence Timer 1 Stop Time	Tmr 1 Stop Time	Sets the stop time for timer 1. The value must be set greater than or equal to S2-01.	Default: 00:00 Min.: 00:00 Max.: 24:00	156
S2-03 (3208)	Sequence Timer 1 Day Selection	Tmr 1 Day Sel 0: Timer disabled 1: Daily 2: Mon - Fri 3: Sat - Sun 4: Monday 5: Tuesday 6: Wednesday 7: Thursday 8: Friday 9: Saturday 10: Sunday	Sets the days for which sequence timer 1 is active. 0: Timer disabled 1: Daily 2: Mon - Fri 3: Sat - Sun 4: Monday 5: Tuesday 6: Wednesday 7: Thursday 8: Friday 9: Saturday 10: Sunday	Default: 0 Range: 0 to 10	156
S2-04 (3209)	Sequence Timer 1 Selection	Tmr 1 Seq Sel 0: Digital out only 1: Run 2: Run - PI Disable	Sets the action that occurs when sequence timers 1 is active. 0: Digital output only 1: Run 2: Run - PI disable	Default: 0 Range: 0 to 2	157
S2-05 (320A)	Sequence Timer 1 Reference Source	Tmr 1 Ref Source 0: Operator (d1-01) 1: Operator (d1-02) 2: Operator (d1-03) 3: Operator (d1-04) 4: Terminals 5: Serial Com 7: Pulse input	Selects the frequency reference source used for running the drive when sequence timer 1 is active (only applicable when S2-04 is set to 1 or 2). 0: Operator (d1-01) 1: Operator (d1-02) 2: Operator (d1-03) 3: Operator (d1-04) 4: Terminals 5: Serial communication 7: Pulse input	Default: 0 Range: 0 to 5; 7	157

B.12 S: Special Application

No. (Addr. Hex)	Name	LCD Display	Description	Values	Page
S2-06 (320B)	Sequence Timer 2 Start Time	Tmr 2 Start Time	Sets the start time for timer 2. The value must be set less than or equal to S2-07.	Default: 00:00 Min.: 00:00 Max.: 24:00	156
S2-07 (320C)	Sequence Timer 2 Stop Time	Tmr 2 Stop Time	Sets the stop time for timer 2. The value must be set greater than or equal to S2-06.	Default: 00:00 Min.: 00:00 Max.: 24:00	156
S2-08 (320D)	Sequence Timer 2 Day Selection	Tmr 2 Day Sel 0: Timer disabled 1: Daily 2: Mon - Fri 3: Sat - Sun 4: Monday 5: Tuesday 6: Wednesday 7: Thursday 8: Friday 9: Saturday 10: Sunday	Sets the days for which sequence timer 2 is active. 0: Timer disabled 1: Daily 2: Mon - Fri 3: Sat - Sun 4: Monday 5: Tuesday 6: Wednesday 7: Thursday 8: Friday 9: Saturday 10: Sunday	Default: 0 Range: 0 to 10	156
S2-09 (320E)	Sequence Timer 2 Selection	Tmr 2 Seq Sel 0: Digital Out Only 1: Run 2: Run - PI Disable	Sets the action that occurs when sequence timers 2 is active. 0: Digital output only 1: Run 2: Run - PI disable	Default: 0 Range: 0 to 2	157
S2-10 (320F)	Sequence Timer 2 Reference Source	Tmr 2 Ref Source 0: Operator (d1-01) 1: Operator (d1-02) 2: Operator (d1-03) 3: Operator (d1-04) 4: Terminals 5: Serial Com 7: Pulse input	Selects the frequency reference source used for running the drive when sequence timer 1 is active (only applicable when S2-04 is set to 1 or 2). 0: Operator (d1-01) 1: Operator (d1-02) 2: Operator (d1-03) 3: Operator (d1-04) 4: Terminals 5: Serial communication 7: Pulse input	Default: 0 Range: 0 to 5; 7	157
S2-11 (3210)	Sequence Timer 3 Start Time	Tmr 3 Start Time	Sets the start time for timer 3. The value must be set less than or equal to S2-12.	Default: 00:00 Min.: 00:00 Max.: 24:00	156
S2-12 (3211)	Sequence Timer 3 Stop Time	Tmr 3 Stop Time	Sets the stop time for timer 3. The value must be set greater than or equal to S2-11.	Default: 00:00 Min.: 00:00 Max.: 24:00	156
S2-13 (3212)	Sequence Timer 3 Day Selection	Tmr 3 Day Sel 0: Timer disabled 1: Daily 2: Mon - Fri 3: Sat - Sun 4: Monday 5: Tuesday 6: Wednesday 7: Thursday 8: Friday 9: Saturday 10: Sunday	Sets the days for which sequence timer 3 is active. 0: Timer disabled 1: Daily 2: Mon - Fri 3: Sat - Sun 4: Monday 5: Tuesday 6: Wednesday 7: Thursday 8: Friday 9: Saturday 10: Sunday	Default: 0 Range: 0 to 10	156
S2-14 (3213)	Sequence Timer 3 Selection	Tmr 3 Seq Sel 0: Digital Out Only 1: Run 2: Run - PI Disable	Sets the action that occurs when sequence timer 3 is active. 0: Digital output only 1: Run 2: Run - PI disable	Default: 0 Range: 0 to 2	157
S2-15 (3214)	Sequence Timer 3 Reference Source	Tmr 3 Ref Source 0: Operator (d1-01) 1: Operator (d1-02) 2: Operator (d1-03) 3: Operator (d1-04) 4: Terminals 5: Serial Com 7: Pulse input	Selects the frequency reference source used for running the drive when sequence timer 1 is active (only applicable when S2-04 is set to 1 or 2). 0: Operator (d1-01) 1: Operator (d1-02) 2: Operator (d1-03) 3: Operator (d1-04) 4: Terminals 5: Serial communication 7: Pulse input	Default: 0 Range: 0 to 5; 7	157
S2-16 (3215)	Sequence Timer 4 Start Time	Tmr 4 Start Time	Sets the start time for timer 4. The value must be set less than or equal to S2-17.	Default: 00:00 Min.: 00:00 Max.: 24:00	156

Parameter List

B

B.12 S: Special Application

No. (Addr. Hex)	Name	LCD Display	Description	Values	Page
S2-17 (3216)	Sequence Timer 4 Stop Time	Tmr 4 Stop Time	Sets the stop time for timer 4. The value must be set greater than or equal to S2-16.	Default: 00:00 Min.: 00:00 Max.: 24:00	156
S2-18 (3217)	Sequence Timer 4 Day Selection	Tmr 4 Day Sel 0: Timer disabled 1: Daily 2: Mon - Fri 3: Sat - Sun 4: Monday 5: Tuesday 6: Wednesday 7: Thursday 8: Friday 9: Saturday 10: Sunday	Sets the days for which sequence timer 4 is active. 0: Timer disabled 1: Daily 2: Mon - Fri 3: Sat - Sun 4: Monday 5: Tuesday 6: Wednesday 7: Thursday 8: Friday 9: Saturday 10: Sunday	Default: 0 Range: 0 to 10	156
S2-19 (3218)	Sequence Timer 4 Selection	Tmr 4 Seq Sel 0: Digital Out Only 1: Run 2: Run - PI Disable	Sets the action that occurs when sequence timer 4 is active. 0: Digital output only 1: Run 2: Run - PI disable	Default: 0 Range: 0 to 2	157
S2-20 (3219)	Sequence Timer 4 Reference Source	Tmr 4 Ref Source 0: Operator (d1-01) 1: Operator (d1-02) 2: Operator (d1-03) 3: Operator (d1-04) 4: Terminals 5: Serial Com 7: Pulse input	Selects the frequency reference source used for running the drive when sequence timer 1 is active (only applicable when S2-04 is set to 1 or 2). 0: Operator (d1-01) 1: Operator (d1-02) 2: Operator (d1-03) 3: Operator (d1-04) 4: Terminals 5: Serial communication 7: Pulse input	Default: 0 Range: 0 to 5; 7	157

◆ T: Motor Tuning

Enter data into the following parameters to tune the motor and drive for optimal performance. When the drive is not accessible, the current values of these parameters are not accessible. The default values are set by the Bypass Controller when a Bypass Control Parameter Initialize (Z1-01 = 1, 2, or 3) command is given.

◆ T1: Induction Motor Auto-Tuning

No. (Addr. Hex)	Name	Description	Values	Page
T1-00 (0700)	Motor 1/Motor 2 Selection	1: Motor 1 2: Motor 2	Default: 1 Range: 1, 2	79
T1-01 (0701) </>	Auto-Tuning Mode Selection	2: Stationary Auto-Tuning for Line-to-Line Resistance 3: Rotational Auto-Tuning for V/f Control Energy Saving	Default: 2 Range: 2, 3	79
T1-02 (0702)	Motor Rated Power	Sets the motor rated power as specified on the motor nameplate. Note: Use the following formula to convert horsepower into kilowatts: 1HP = 0.746 kW.	Default: <2> Min.: 0.00 kW Max.: 650.00 kW	79
T1-03 (0703)	Motor Rated Voltage	Sets the motor rated voltage as specified on the motor nameplate.	Default: 200.0 V <3> Min: 0.0 Max: 255.0 <3>	79
T1-04 (0704)	Motor Rated Current	Sets the motor rated current as specified on the motor nameplate.	Default: <2> Min.: 10% of drive rated current Max.: 200% of drive rated current	80
T1-05 (0705)	Motor Base Frequency	Sets the rated frequency of the motor as specified on the motor nameplate.	Default: 60.0 Hz Min.: 0.0 Max.: 240.0	80
T1-06 (0706)	Number of Motor Poles	Sets the number of motor poles as specified on the motor nameplate.	Default: 4 Min.: 2 Max.: 48	80

B.12 S: Special Application

No. (Addr. Hex)	Name	Description	Values	Page
T1-07 (0707)	Motor Base Speed	Sets the rated speed of the motor as specified on the motor nameplate.	Default: 1750 r/min Min.: 0 Max.: 14400	80
T1-11 (070B)	Motor Iron Loss	Sets the iron loss for determining the Energy Saving coefficient. The value is set to E2-10 (motor iron loss) set when the power is cycled. If T1-02 is changed, a default value appropriate for the motor capacity that was entered will appear.	Default: 14 W ^{<4>} Min.: 0 Max.: 65535	80

- <1> The availability of certain Auto-Tuning methods depends on the control mode selected for the drive.
- <2> Default setting is dependent on parameter o2-04, Drive Model Selection.
- <3> Values shown are specific to 208 V bypass drives. Double the value for 480 V bypass drives..
- <4> Default setting value differs depending on the motor code value and motor parameter settings.

B.13 U: Monitors

B.13 U: Monitors

Monitor parameters allow the user to view drive status, fault information, and other data concerning drive operation.

◆ UB: Bypass Control Monitors

No. (Addr. Hex)	Name	Description	Unit
UB-01 (8780)	Motor Current	Format is XXX.x amps.	Amp
UB-02 (8781)	Bypass Digital Input States	View status of bypass digital inputs XXXXXXXX Where X = 0 (not asserted) or 1 (asserted) The right-most digit is the status of digital input 1.	-
UB-03 (8782)	Bypass Digital Output States	View status of bypass digital outputs XXXXXXXX Where X = 0 (not asserted) or 1 (asserted) The right-most digit is the status of digital output 1.	-
UB-04 (8783)	Bypass Digital Output States	View status of bypass digital outputs XXXXXXXX Where X = 0 (not asserted) or 1 (asserted) The right-most digit is the status of digital output 9.	-
UB-05 (8784)	Bypass Controller Status Register 1	<p>UB-05 = 00000000</p> <ul style="list-style-type: none"> <input type="checkbox"/> HAND Mode <input type="checkbox"/> OFF Mode <input type="checkbox"/> AUTO Mode <input type="checkbox"/> DRIVE Mode <input type="checkbox"/> BYPASS Mode <input type="checkbox"/> Smoke Purge Bypass Active <input type="checkbox"/> Smoke Purge Drive Active <input type="checkbox"/> Safety Open 	-
UB-06 (8785)	Bypass Controller Status Register 2	<p>UB-06 = 00000000</p> <ul style="list-style-type: none"> <input type="checkbox"/> BAS Interlock Open <input type="checkbox"/> RUN Active <input type="checkbox"/> Fault Active <input type="checkbox"/> Auto Transfer Active <input type="checkbox"/> Remote Transfer Active <input type="checkbox"/> Energy Savings Active <input type="checkbox"/> Motor 1 Selected <input type="checkbox"/> Motor 2 Selected <p>Note: When read over serial communications, address 8785H, contains two more bits of information: Bit 8: "0" when Z1-07 = 2, otherwise "1". Bit 9: "0" when Z1-08 = 2, otherwise "1".</p>	-
UB-07 (8786)	Bypass Controller Active Faults Register 1	<p>UB-07 = 00000000</p> <ul style="list-style-type: none"> <input type="checkbox"/> Drive Fault <input type="checkbox"/> Safety Open <input type="checkbox"/> BAS Interlock Open Time Out <input type="checkbox"/> External Fault Bypass (EFB) <input type="checkbox"/> Reserved <input type="checkbox"/> Motor Overload <input type="checkbox"/> External Motor 1 Overload <input type="checkbox"/> External Motor 2 Overload 	-

B.13 U: Monitors

No. (Addr. Hex)	Name	Description	Unit
UB-08 (8787)	Bypass Controller Active Faults Register 2	<p style="text-align: center;">UB-08 = 00000000</p> <ul style="list-style-type: none"> 0 Phase Loss Brownout 0 Phase Loss Blackout 0 No Drive Comms 0 Available 0 Option Board Comms 0 Loss of Load 0 Serial Communications Fault 0 Available 	-
UB-09 (8788)	Current Fault	Displays the current fault.	-
UB-10 (8789)	Current Fault Year	Displays the year of the current fault.	-
UB-11 (878A)	Current Fault Month Day	Displays the month and day of the current fault.	-
UB-12 (878B)	Current Fault Hour Minute	Displays the hour and minute of the current fault.	-
UB-13 (878C)	Previous Fault	Displays the previous fault.	-
UB-14 (878D)	Previous Fault Year	Displays the year of the previous fault.	-
UB-15 (878E)	Previous Fault Month Day	Displays the month and day of the previous fault.	-
UB-16 (878F)	Previous Fault Hour Minute	Displays the hour and minute of the previous fault.	-
UB-17 (878F)	Contactors Voltage (120 VAC)	Displays the measured voltage for the power going to the contactor coils.	1 Vac
UB-18 (8791)	Software Version	Displays the software version currently programmed into the bypass.	-
UB-19 (8792)	Date Year	Displays the current year.	-
UB-20 (8793)	Date Month & Day	Displays the current date (Month and Date).	-
UB-21 (8794)	Time Hour & Minute	Displays the current time (Hours and Minutes).	-
UB-90 (87A0)	Service Register 0	Unfiltered CT1 current	-
UB-91 (87A1)	Service Register 1	Unfiltered CT2 current	-
UB-92 (87A2)	Service Register 2	Electronic overload calculations	-
UB-93 (87A3)	Service Register 3	BACnet messages sent	-
UB-94 (87A4)	Service Register 4	BACnet received messages errored	-
UB-95 (87A5)	Service Register 5	-	-
UB-96 (87DF) <1>	Bypass Unbalance Level	Displays the percent of current unbalance when operating in Bypass Mode.	0.0 to 100.0%

Parameter List

B

<1> Available in bypass controller software versions VST800298 and later.

B.13 U: Monitors

◆ U1: Operation Status Monitors

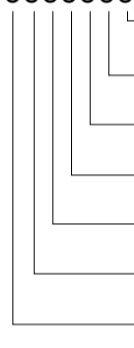
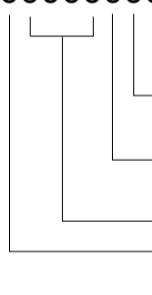
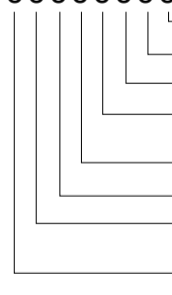
No. (Addr. Hex)	Name	Description	Analog Output Level	Unit
U1-01 (40)	Frequency Reference	Monitors the frequency reference. Display units are determined by o1-03.	10 V: Max frequency	0.01 Hz
U1-02 (41)	Output Frequency	Displays the output frequency. Display units are determined by o1-03.	10 V: Max frequency	0.01 Hz
U1-03 (42)	Output Current	Displays the output current.	10 V: Drive rated current	0.1 A <2>
U1-04 (43)	Control Method	0: V/f Control	No signal output available	-
U1-06 (45)	Output Voltage Reference	Displays the output voltage.	10 V: 200 Vrms <3>	0.1 Vac
U1-07 (46)	DC Bus Voltage	Displays the DC bus voltage.	10 V: 400 V <3>	1 Vdc
U1-08 (47)	Output Power	Displays the output power (this value is calculated internally).	10 V: Drive rated power (kW)	<1>
U1-10 (49)	Input Terminal Status	Displays the input terminal status. U1 - 10 = 00000000  <ul style="list-style-type: none"> 1 Digital input 1 (terminal S1 enabled) 1 Digital input 2 (terminal S2 enabled) 1 Digital input 3 (terminal S3 enabled) 1 Digital input 4 (terminal S4 enabled) 1 Digital input 5 (terminal S5 enabled) 1 Digital input 6 (terminal S6 enabled) 1 Digital input 7 (terminal S7 enabled) 	No signal output available	-
U1-11 (4A)	Output Terminal Status	Displays the output terminal status. U1 - 11 = 00000000  <ul style="list-style-type: none"> 1 Multi-Function Digital Output (terminal MD-ME-MF) enabled 1 Multi-Function Digital Output (terminal M1-M2) enabled 1 Multi-Function Digital Output (terminal M3-M4) enabled 0 Not Used 1 Fault Relay (terminal MA-MC closed, MA open) enabled 	No signal output available	-
U1-12 (4B)	Drive Status	Verifies the drive operation status. U1 - 12 = 00000000  <ul style="list-style-type: none"> 1 During run 1 During zero-speed 1 During REV 1 During fault reset signal input 1 During speed agree 1 Drive ready 1 During alarm detection 1 During fault detection 	No signal output available	-
U1-13 (4E)	Terminal A1 Input Level	Displays the signal level to analog input terminal A1.	10 V: 100%	0.1%

B.13 U: Monitors

No. (Addr. Hex)	Name	Description	Analog Output Level	Unit
U1-14 (4F)	Terminal A2 Input Level	Displays the signal level to analog input terminal A2.	10 V: 100%	0.1%
U1-15 (50)	Terminal A3 Input Level	Displays the signal level to analog input terminal A3.	10 V: 100%	0.1%
U1-16 (53)	Output Frequency after Soft Starter	Displays output frequency with ramp time and S-curves. Units determined by o1-03.	10 V: Max frequency	0.01 Hz
U1-18 (61)	oPE Fault Parameter	Displays the parameter number that caused the oPE□□ or Err (EEPROM write error) error.	No signal output available	–
U1-25 (4D)	Software Number (Flash)	FLASH ID	No signal output available	–
U1-26 (5B)	Software No. (ROM)	ROM ID	No signal output available	–
U1-75 (851)	Time-Hour/Minute	Displays the current time (Hours and Minutes).	No signal output available	–
U1-76 (852)	Date – Year	Displays the current year.	No signal output available	–
U1-77 (853)	Date – Month/Day	Displays the current date (Month and Date).	No signal output available	–
U1-78 (854)	Date – Week Day	Displays the current date of the week. 0: Sunday 1: Monday 2: Tuesday 3: Wednesday 4: Thursday 5: Friday 6: Saturday	No signal output available	–

<1> The number of decimal places in the parameter value depends on the drive model. *Refer to Defaults by Drive Model on page 298* for details.

<2> When reading the value of this monitor via MEMOBUS/Modbus, a value of 8192 is equal to 100% of the drive rated output current.

<3> Values shown are specific to 208 V bypass drives. Double the value for 480 V bypass drives.

◆ U2: Fault Trace

No. (Addr. Hex)	Name	Description	Analog Output Level	Unit
U2-01 (80)	Current Fault	Displays the current fault.	No signal output available	–
U2-02 (81)	Previous Fault	Displays the previous fault.	No signal output available	–
U2-03 (82)	Frequency Reference at Previous Fault	Displays the frequency reference at the previous fault.	No signal output available	0.01 Hz
U2-04 (83)	Output Frequency at Previous Fault	Displays the output frequency at the previous fault.	No signal output available	0.01 Hz
U2-05 (84)	Output Current at Previous Fault	Displays the output current at the previous fault.	No signal output available	<1> <2>
U2-07 (86)	Output Voltage at Previous Fault	Displays the output voltage at the previous fault.	No signal output available	0.1 Vac
U2-08 (87)	DC Bus Voltage at Previous Fault	Displays the DC bus voltage at the previous fault.	No signal output available	1 Vdc
U2-09 (88)	Output Power at Previous Fault	Displays the output power at the previous fault.	No signal output available	0.1 kW
U2-11 (8A)	Input Terminal Status at Previous Fault	Displays the input terminal status at the previous fault. Displayed as in U1-10.	No signal output available	–
U2-12 (8B)	Output Terminal Status at Previous Fault	Displays the output status at the previous fault. Displays the same status displayed in U1-11.	No signal output available	–
U2-13 (8C)	Drive Operation Status at Previous Fault	Displays the operation status of the drive at the previous fault. Displays the same status displayed in U1-12.	No signal output available	–
U2-14 (8D)	Cumulative Operation Time at Previous Fault	Displays the cumulative operation time at the previous fault.	No signal output available	1 h

Parameter List

B

B.13 U: Monitors

No. (Addr. Hex)	Name	Description	Analog Output Level	Unit
U2-15 (7E0)	Soft Starter Speed Reference at Previous Fault	Displays the speed reference for the soft starter at the previous fault.	No signal output available	0.01 Hz
U2-16 (7E1)	Motor q-Axis Current at Previous Fault	Displays the q-axis current for the motor at the previous fault.	No signal output available	0.10%
U2-20 (8E)	Heatsink Temperature at Previous Fault	Displays the temperature of the heatsink when the most recent fault occurred.	No signal output available	1 °C
U2-27 (07FA)	Motor Temperature at Previous Fault (NTC)	Displays the temperature of the motor when the most recent fault occurred.	No signal output available	–
U2-30 (3008)	Date Year at Previous Fault	Displays the year when the most recent fault occurred.	No signal output available	–
U2-31 (3009)	Date Month and Day at Previous Fault	Displays the date and day when the most recent fault occurred.	No signal output available	–
U2-32 (300A)	Time Hours and Minutes at Previous Fault	Displays the time when the most recent fault occurred.	No signal output available	–

<1> The number of decimal places in the parameter value depends on the drive model. *Refer to Defaults by Drive Model on page 298* for details.

<2> When reading the value of this monitor via MEMOBUS/Modbus, a value of 8192 is equal to 100% of the drive rated output current.

◆ U3: Fault History

No. (Addr. Hex)	Name	Description	Analog Output Level	Unit
U3-01 to U3-04 (90 to 93 (800 to 803))	First to 4th Most Recent Fault	Displays the first to the fourth most recent faults.	No signal output available	–
U3-05 to U3-10 (804 to 809)	5th to 10th Most Recent Fault	Displays the fifth to the tenth most recent faults. After ten faults, data for the oldest fault is deleted. The most recent fault appears in U3-01, with the next most recent fault appearing in U3-02. The data is moved to the next monitor parameter each time a fault occurs.	No signal output available	–
U3-11 to U3-14 (94 to 97 (80A to 80D))	Cumulative Operation Time at 1st to 4th Most Recent Fault	Displays the cumulative operation time when the first to the fourth most recent faults occurred.	No signal output available	1 h
U3-15 to U3-20 (80E to 813)	Cumulative Operation Time at 5th to 10th Most Recent Fault	Displays the cumulative operation time when the fifth to the tenth most recent faults occurred.	No signal output available	1 h
U3-21 (300B)	Date Year at Most Recent Fault	Displays the year when the most recent fault occurred.	No signal output available	–
U3-22 (300C)	Date Month and Day at Most Recent Fault	Displays the date and day when the most recent faults occurred.	No signal output available	–
U3-23 (300D)	Time Hours and Minutes at Most Recent Fault	Displays the time when the most recent fault occurred.	No signal output available	–
U3-24 (300E)	Date Year at 2nd Most Recent Fault	Displays the year when the second most recent fault occurred.	No signal output available	–
U3-25 (300F)	Date Month and Day at 2nd Most Recent Fault	Displays the date and day when the second most recent fault occurred.	No signal output available	–
U3-26 (3010)	Time Hours and Minutes at 2nd Most Recent Fault	Displays the time when the second most recent fault occurred.	No signal output available	–
U3-27 (3011)	Date Year at 3rd Most Recent Fault	Displays the year when the most third recent fault occurred.	No signal output available	–
U3-28 (3012)	Date Month and Day at 3rd Most Recent Fault	Displays the date and day when the third most recent fault occurred.	No signal output available	–
U3-29 (3013)	Time Hours and Minutes at 3rd Most Recent Fault	Displays the time when the third most recent fault occurred.	No signal output available	–

B.13 U: Monitors

No. (Addr. Hex)	Name	Description	Analog Output Level	Unit
U3-30 (3014)	Date Year at 4th Most Recent Fault	Displays the year when the fourth most recent fault occurred.	No signal output available	–
U3-31 (3015)	Date Month and Day at 4th Most Recent Fault	Displays the date and day when the fourth most recent fault occurred.	No signal output available	–
U3-32 (3016)	Time Hours and Minutes at 4th Most Recent Fault	Displays the time when the fourth most recent fault occurred.	No signal output available	–
U3-33 (3017)	Date Year at 5th Most Recent Fault	Displays the year when the fifth most recent fault occurred.	No signal output available	–
U3-34 (3018)	Date Month and Day at 5th Most Recent Fault	Displays the date and day when the fifth most recent fault occurred.	No signal output available	–
U3-35 (3019)	Time Hours and Minutes at 5th Most Recent Fault	Displays the time when the fifth most recent fault occurred.	No signal output available	–
U3-36 (301A)	Date Year at 6th Most Recent Fault	Displays the year when the sixth most recent fault occurred.	No signal output available	–
U3-37 (301B)	Date Month and Day at 6th Most Recent Fault	Displays the date and day when the sixth most recent fault occurred.	No signal output available	–
U3-38 (301C)	Time Hours and Minutes at 6th Most Recent Fault	Displays the time when the most sixth recent fault occurred.	No signal output available	–
U3-39 (301D)	Date Year at 7th Most Recent Fault	Displays the year when the most seventh recent fault occurred.	No signal output available	–
U3-40 (301E)	Date Month and Day at 7th Most Recent Fault	Displays the date and day when the seventh most recent fault occurred.	No signal output available	–
U3-41 (301F)	Time Hours and Minutes at 7th Most Recent Fault	Displays the time when the seventh most recent fault occurred.	No signal output available	–
U3-42 (3020)	Date Year at 8th Most Recent Fault	Displays the year when the eighth most recent fault occurred.	No signal output available	–
U3-43 (3021)	Date Month and Day 8th at Most Recent Fault	Displays the date and day when the eighth most recent fault occurred.	No signal output available	–
U3-44 (3022)	Time Hours and Minutes at 8th Most Recent Fault	Displays the time when the eighth most recent fault occurred.	No signal output available	–
U3-45 (3023)	Date Year at 9th Most Recent Fault	Displays the year when the ninth most recent fault occurred.	No signal output available	–
U3-46 (3024)	Date Month and Day at 9th Most Recent Fault	Displays the date and day when the ninth most recent fault occurred.	No signal output available	–
U3-47 (3025)	Time Hours and Minutes at 9th Most Recent Fault	Displays the time when the ninth most recent fault occurred.	No signal output available	–
U3-48 (3026)	Date Year at 10th Most Recent Fault	Displays the year when the tenth most recent fault occurred.	No signal output available	–
U3-49 (3027)	Date Month and Day at 10th Most Recent Fault	Displays the date and day when the tenth most recent fault occurred.	No signal output available	–
U3-50 (3028)	Time Hours and Minutes at 10th Most Recent	Displays the time when the tenth most recent fault occurred.	No signal output available	–

◆ U4: Maintenance Monitors

No. (Addr. Hex)	Name	Description	Analog Output Level	Unit
U4-01 (4C)	Cumulative Operation Time	Displays the cumulative operation time of the drive. The value for the cumulative operation time counter can be reset in parameter o4-01. Use parameter o4-02 to determine if the operation time should start as soon as the power is switched on or only while the Run command is present. The maximum number displayed is 65535. Note: This monitor is only updated every 10 operating hours.	No signal output available	1 h
U4-02 (75)	Number of Run Commands	Displays the number of times the Run command is entered. Reset the number of Run commands using parameter o4-13. This value will reset to 0 and start counting again after reaching 65535.	No signal output available	1 Time

Parameter List

B

B.13 U: Monitors

No. (Addr. Hex)	Name	Description	Analog Output Level	Unit
U4-03 (67)	Cooling Fan Operation Time	Displays the cumulative operation time of the cooling fan. The default value for the fan operation time is reset in parameter o4-03. The maximum number displayed is 65535. Note: This monitor is only updated every 10 operating hours.	No signal output available	1 h
U4-04 (7E)	Cooling Fan Maintenance	Displays main cooling fan usage time as a percentage of its expected performance life. Parameter o4-03 can be used to reset this monitor.	No signal output available	1%
U4-05 (7C)	Capacitor Maintenance	Displays main circuit capacitor usage time as a percentage of their expected performance life. Parameter o4-05 can be used to reset this monitor.	No signal output available	1%
U4-06 (07D6)	Soft Charge Bypass Relay Maintenance	Displays the soft charge bypass relay maintenance time as a percentage of its estimated performance life. Parameter o4-07 can be used to reset this monitor.	No signal output available	1%
U4-07 (07D7)	IGBT Maintenance	Displays IGBT usage time as a percentage of the expected performance life. Parameter o4-09 can be used to reset this monitor.	No signal output available	1%
U4-08 (68)	Heatsink Temperature	Displays the heatsink temperature.	10 V: 100 °C	1 °C
U4-09 (5E)	LED Check	Lights all segments of the LED to verify that the display is working properly.	No signal output available	–
U4-10 (5C)	kWh, Lower 4 Digits	Monitors the drive output power. The value is shown as a 9-digit number displayed across two monitor parameters, U4-10 and U4-11.	No signal output available	1 kWh
U4-11 (5D)	kWh, Upper 5 Digits	Example: 12345678.9 kWh is displayed as: U4-10: 678.9 kWh U4-11: 12345 MWh	No signal output available	1 MWh
U4-13 (7CF)	Peak Hold Current	Displays the highest current value that occurred during run.	No signal output available	0.01 A <I>
U4-14 (7D0)	Peak Hold Output Frequency	Displays the output frequency when the current value shown in U4-13 occurred.	No signal output available	0.01 Hz
U4-16 (7D8)	Motor Overload Estimate (oL1)	Shows the value of the motor overload detection accumulator. 100% is equal to the oL1 detection level.	10 V: 100%	0.1%
U4-18 (7DA)	Frequency Reference Source Selection	Displays the source for the frequency reference as XY-nn. X: indicates which reference is used: 0 = OFF 1 = AUTO 2 = HAND Y-nn: indicates the reference source 0-01 = HOA keypad 1-00 = Analog (not assigned) 1-01 = Analog (terminal A1) 1-02 = Analog (terminal A2) 1-03 = Analog (terminal A3) 2-02 to 17 = Multi-step speed (d1-02 to 17) 3-01 = MEMOBUS/Modbus communications 4-01 = Communication option card 9-01 = Up/Down	No signal output available	–
U4-19 (7DB)	Frequency Reference from MEMOBUS/Modbus Comm.	Displays the frequency reference provided by MEMOBUS/Modbus (decimal).	No signal output available	0.01%
U4-20 (7DC)	Option Frequency Reference	Displays the frequency reference input by an option card (decimal).	No signal output available	–

B.13 U: Monitors

No. (Addr. Hex)	Name	Description	Analog Output Level	Unit
U4-21 (7DD)	Run Command Source Selection	Displays the source for the Run command as XY-nn. X: Indicates which Run source is used: 0 = OFF 1 = AUTO 2 = HAND Y: Input power supply data 0 = HOA keypad 1 = External terminals 3 = BACnet or MEMOBUS/Modbus communications 4 = Communication option card nn: Run command limit status data 00: No limit status. 01: Run command was left on when stopped in the PRG mode 02: Run command was left on when switching from LOCAL to REMOTE operation 03: Waiting for soft charge bypass contactor after power up (Uv or Uv1 flashes after 10 s) 04: Waiting for "Run command prohibited" time period to end 05: Fast Stop (digital input, HOA keypad) 06: b1-17 (Run command given at power-up) 07: During baseblock while coast to stop with timer 08: Frequency reference is below minimal reference during baseblock 09: Waiting for Enter command	No signal output available	–
U4-22 (7DE)	MEMOBUS/Modbus Communications Reference	Displays the drive control data set by MEMOBUS/Modbus communications register no. 0001H as a four-digit hexadecimal number.	No signal output available	–
U4-23 (7DF)	Communication Option Card Reference	Displays drive control data set by an option card as a four-digit hexadecimal number.	No signal output available	–

<1> When reading the value of this monitor via MEMOBUS/Modbus, a value of 8192 is equal to 100% of the drive rated output current.

◆ U5: PID Monitors

No. (Addr. Hex)	Name	Description	Analog Output Level	Unit
U5-01 (57)	PID Feedback 1	Displays the PID feedback value.	10 V: 100%	0.01% <I>
U5-02 (63)	PID Input	Displays the amount of PID input (deviation between PID setpoint and feedback).	10 V: 100%	0.01%
U5-03 (64)	PID Output	Displays PID control output.	10 V: 100%	0.01%
U5-04 (65)	PID Setpoint	Displays the PID setpoint.	10 V: 100%	0.01% <I>
U5-05 (7D2)	PID Differential Feedback	Displays the 2nd PID feedback value if differential feedback is used (H3-□□ = 16).	10 V: 100%	0.01%
U5-06 (7D3)	PID Adjusted Feedback	Displays the difference of both feedback values if differential feedback is used (U5-01 - U5-05). If differential feedback is not used, then U5-01 and U5-06 will be the same.	10 V: 100%	0.01%
U5-30 (3000)	Time Hr Min HHMM	Displays the current time (Hours and Minutes).	No signal output available	1
U5-31 (3001)	Date Year	Displays the current year.	No signal output available	1
U5-32 (3002)	Date Mo Day MMDD	Displays the current date (Month and Day).	No signal output available	1
U5-33 (3003)	Date Week 000W	Displays the current date of the week. 0: Sunday 1: Monday 2: Tuesday 3: Wednesday 4: Thursday 5: Friday 6: Saturday	No signal output available	1

Parameter List

B

B.13 U: Monitors

No. (Addr. Hex)	Name	Description	Analog Output Level	Unit
U5-99 (1599)	PID Setpoint Command	Displays the PID Setpoint commanded by the source.	No signal output available	0.01% <I>

<1> Unit, range and resolution is determined by b5-20, b5-38, b5-39, and b5-46

B.14 Z: Bypass Parameters

◆ Z1: Bypass Control System

No. (Addr. Hex)	Name	LCD Display	Description	Values	Page
Z1-01 (85C6) <input type="checkbox"/> RUN	Initialize	Initialize 0: No init 1: Set All Def 2: Set Byp Def 3: Set Drv Def 8008: Pump 8009: Pump w/ PI 8010: Fan 8011: Fan w/ PI	0: No Initialize 1: Set all parameters to their default values. For drive parameters, first issues two-wire reset, then sets individual parameter default values. 2: Set only Bypass Controller parameters to their default values. 3: Set only Drive Controller parameters to their default values. First issues two-wire reset, then sets individual parameter default values. 8008: Pump 8009: Pump w/ PI 8010: Fan 8011: Fan w/ PI	Default: 0 Range: 0 to 3; 8008 to 8011	162
Z1-02 (85C7) <input type="checkbox"/> RUN	Password	Password	Allows and restricts access to all parameters. Setting this value equal to the value in Z1-03 toggles access to all parameter settings except this parameter. If the value entered to Z1-02 matches the value entered to Z1-03, the access to all parameters is denied or granted.	Default: — Min.: — Max.: —	162
Z1-03 (85C8) <input type="checkbox"/> RUN	Password Change	Pass Chg	The value entered here is the password.	Default: 0 Min.: 0 Max.: 9999	162
Z1-05 (85CA) <input type="checkbox"/> RUN	Auto Transfer to Bypass Upon Drive Fault	Auto Xfr Byp Flt	When the drive is running and a drive fault occurs, operation will switch to Bypass mode. When the fault is cleared, operation will switch back to Drive mode 0: Disable 1: Enable	Default: 0 Range: 0, 1	162
Z1-06 (85CB) <input type="checkbox"/> RUN	Power-Up Mode	Power-Up	Determines the mode of the Bypass Control upon power-up. 0: OFF 1: AUTO-DRIVE 2: HAND-DRIVE 3: AUTO-BYPASS 4: HAND-BYPASS	Default: 0 Range: 0 to 4	163
Z1-07 (85CC) <input type="checkbox"/> RUN	Speed Reference Select	Spd Ref Sel	Determines the source of the Frequency Reference sent from the Bypass Controller to the Drive. 0: Operator 1: Analog Input 2: Bypass Serial 3: Option Board (CN5)	Default: 1 </> Range: 0 to 3	163
Z1-08 (85CD) <input type="checkbox"/> RUN	Run Command Select	Run Cmd Sel	Determines the source of the Auto Mode Run command used by the Bypass Controller. 0: Operator 1: Bypass Controller Digital Input 2: Bypass Serial 3: Option Board (CN5)	Default: 1 Range: 0 to 3	164
Z1-09 (85CE) <input type="checkbox"/> RUN	HAND Mode Drive Speed Reference	Hand Fref	This is the speed reference used when the Drive is running in HAND mode. Units are in Hz.	Default: 10.0 Hz <2> Min.: 0.0 Max.: 60.0	166
Z1-10 (85CF) <input type="checkbox"/> RUN	Smoke Purge Preset Frequency Reference	Smoke Purge	Sets the speed at which the drive will run when the Smoke Purge Drive input is active.	Default: 60.0 Hz <2> Min.: 0.0 Max.: 60.0	166

B.14 Z: Bypass Parameters

No. (Addr. Hex)	Name	LCD Display	Description	Values	Page
Z1-11 (85D0) <input type="checkbox"/> RUN	2-Motor AND/OR Function Select	2-Mtr AND/OR Sel	0: Disabled (ignore digital inputs) 1: Always use only motor 1 2: Always use only motor 2 3: Always use motors 1 AND 2 4: OR function motor selected by digital input in HAND and AUTO modes 5: OR function use motor 1 in HAND mode and motor selected by digital input in AUTO mode 6: OR function use motor 2 in HAND mode and motor selected by digital input in AUTO mode 7: AND/OR function motor selected (1, 2, or both) by (2) digital inputs in HAND and AUTO mode 8: AND/OR function use motor 1 in HAND mode and motor selected (1, 2, or both) by (2) digital inputs in AUTO mode 9: AND/OR function use motor 2 in HAND mode and motor selected (1, 2, or both) by (2) digital inputs in AUTO mode 10: AND/OR function use motors 1 AND 2 in HAND mode and motor selected (1, 2, or both) by (2) digital inputs in AUTO mode	Default: 0 Range: 0 to 10	166
Z1-12 (85D1) <input type="checkbox"/> RUN	Run Delay Time	Run Delay Time	Delays the drive or bypass Run from when commanded (after RUN, RUN ENABLE, and RUN INTERLOCK are all asserted).	Default: 0.0 s Min.: 0.0 Max.: 300.0	166
Z1-13 (85D2) <input type="checkbox"/> RUN	Pre-Interlock Run Select	Pre Int Run Sel	Allows running at a preset speed starting immediately upon a Run command, ignoring the BAS Interlock Input. The drive frequency reference stays at this preset speed until the Run Delay time (Z1-12) times out. 0: Disabled 1: Enable delay time only	Default: 0 Range: 0, 1	166
Z1-14 (85D3) <input type="checkbox"/> RUN	Run Delay Frequency Reference	Run Delay Fref	Frequency used while delaying the Run command.	Default: 60.0 Hz <2> Min.: 0.0 Max.: 60.0	167
Z1-15 (85D4) <input type="checkbox"/> RUN	Interlock Wait Time	Interlck Wait	Upon entering a Run command, the damper actuator output will be asserted. When an input is programmed for Interlock and the time set to this parameter is reached before the Interlock input goes active, a fault will be declared. A setting of 0.0 will never time out.	Default: 0.0 s Min.: 0.0 Max.: 300.0	167
Z1-16 (85D5)	Energy Savings Mode Enable	Engry Savings En	0: Disable 1: Enable (Freq) 2: Enable (Freq + Cur) Note: Energy Savings will not function if the motor is running in reverse.	Default: 0 Range: 0 to 2	170
Z1-17 (85D6) <input type="checkbox"/> RUN	Energy Savings Mode Frequency	Energy Freq	Sets the value of the drive frequency reference for use in comparison to enter or exit Energy Savings mode.	Default: 60.0 Hz <2> Min.: 0.0 Max.: 60.0	170
Z1-18 (85D7) <input type="checkbox"/> RUN	Energy Savings Mode Output Current Level	Energy Iout Lvl	Allows system to switch when the output current rises above this level of motor rated current for time specified in Energy Time.	Default: 0.0% Min.: 0.0 Max.: 100.0	170
Z1-19 (85D8) <input type="checkbox"/> RUN	Energy Savings Mode Frequency Reference Deadband	Engry Fref Dbnd	Sets the tolerance around the drive frequency reference value during comparisons to enter or exit Energy Savings mode	Default: 0.5 Hz <2> Min.: 0.0 Max.: 5.0	171
Z1-20 (85D9) <input type="checkbox"/> RUN	Energy Savings Mode Output Frequency Deadband	Energy Freq Dbnd	Sets the tolerance around the drive output frequency value during comparisons to enter or exit Energy Savings mode.	Default: 0.5 Hz <2> Min.: 0.0 Max.: 5.0	171
Z1-21 (85DA) <input type="checkbox"/> RUN	Energy Savings Mode Output Current Deadband	Energy Iout Dbnd	Sets the tolerance around the drive output current value during comparisons to enter or exit Energy Savings mode as a percentage of motor rated current.	Default: 15.0% Min.: 0.0 Max.: 30.0	171
Z1-22 (85DB) <input type="checkbox"/> RUN	Energy Savings Mode Time	Energy Time	Sets the time that the drive frequency reference and drive output frequency must be within the set limits before transferring to Energy Savings mode.	Default: 30 s Min.: 10 Max.: 60000	171

B.14 Z: Bypass Parameters

No. (Addr. Hex)	Name	LCD Display	Description	Values	Page
Z1-23 (85DC) RUN	Energy Savings Mode Frequency Reference Increase	Energy Fref Incr	Sets the value to add to the drive Frequency Reference when starting the transfer to bypass mode the drive when entering the Energy Savings Mode.	Default: 6.0 Hz <2> Min.: 0.0 Max.: 10.0	171
Z1-24 (85DD) RUN	Contactor Open Delay Time	Kx Open Delay	Sets the time to delay after commanding the drive output contactor K2 or bypass contactor K3 or 2-Motor OR/AND contactors K4 and K5 to open to allow the contacts to open.	Default: 0.2 s Min.: 0.0 Max.: 5.0	171
Z1-25 (85DE) RUN	Contactor Close Delay Time	Kx Close Delay	Sets the time to delay after commanding the drive output contactor K2 or bypass contactor K3 or 2-Motor OR/AND contactors K4 and K5 to close to allow the contacts to close.	Default: 0.2 s Min.: 0.0 Max.: 5.0	171
Z1-27 (08E0) RUN	Phase Loss Brownout Voltage Level	PL Brownout V	Sets the voltage level below which is considered a brownout condition.	Default: 98 V Min.: 0 V Max.: 150 V	172
Z1-28 (85E1) RUN	Phase Loss Brownout Detection Time	PL Brownout T	Sets the time that the input voltage is continuously measured to be below the Brownout Voltage level before declaring a Brownout fault.	Default: 3.0 s Min.: 0.0 Max.: 300.0	172
Z1-29 (85E2) RUN	Phase Loss Blackout Voltage Level	PL Blackout V	Sets the voltage level below which is considered a blackout condition. When the input voltage is measured below this level, a Blackout fault will be declared.	Default: 0 V Min.: 0 V Max.: 150 V	172
Z1-30 (85E3) RUN	EF0 Fault Delay Time	EF0 Flt Delay T	Sets the time between declaring a drive fault and opening the drive and bypass contactors.	Default: 1.0 s Min.: 0.0 Max.: 300.0	172
Z1-31 (85E4) RUN	Loss of Load Detection Enable	Loss of Load En 0: Disable 1: Enable Fault 2: Enable Alarm	0: Disable 1: Enable and declare fault. 2: Enable and alarm only	Default: 0 Range: 0 to 2	172
Z1-32 (85E5) RUN	Loss of Load Drive Frequency	Load Drive Freq	Sets the value to which the drive output frequency must be equal to or greater than for the drive to detect a loss of load.	Default: 60.0 Hz <2> Min.: 0.0 Max.: 60.0	172
Z1-33 (85E6) RUN	Loss of Load Drive Output Current	Load Drive Curr	The drive output current must be equal to or less than this value to detect a loss of load.	Default: 0.0 A Min.: 0.0 Max.: 999.9	172
Z1-34 (85E7) RUN	Loss of Load Drive Time	Load Drive Time	The conditions must be met for the length of time entered here before detecting a loss of load while in Drive mode.	Default: 1.0 s Min.: 0.0 Max.: 300.0	172
Z1-35 (85E8) RUN	Loss of Load Bypass Output Current	Load Byp Cur	The motor current must be equal to or less than this value to detect a loss of load.	Default: 0.0 A Min.: 0.0 Max.: 999.9	172
Z1-36 (85E9) RUN	Loss of Load Bypass Time	Load Byp Time	The conditions must be met for the length of time entered to this parameter before detecting a loss of load while in Bypass mode.	Default: 1.0 s Min.: 0.0 Max.: 300.0	173
Z1-37 (85EA) RUN	Set Time	Set Time 0: Normal display 1: Time Setting	Changes the LCD display to time setting to set the Real Time Clock. 0: Normal display 1: Displays time and date setting mode 2: Reset time <3>	Default: 0 Range: 0 to 2	173
Z1-38 (85EB) RUN	HOA Source Select	HOA Select 0: Operator 1: Digital Inputs 2: Ser Comm & Opt	0: Operator 1: Digital Inputs 2: Serial Communications	Default: 0 Range: 0 to 2	173
Z1-39 (85EC) RUN	Drive/Bypass Source Select	Drv/Byp Select 0: Operator 1: Digital Inputs 2: Ser Comm & Opt	0: Operator 1: Digital Inputs 2: Serial Communications	Default: 0 Range: 0 to 2	173

Parameter List

B

B.14 Z: Bypass Parameters

No. (Addr. Hex)	Name	LCD Display	Description	Values	Page
Z1-40 (85ED) RUN	Auto Transfer Wait Time	Auto Xfer Wait T	If Auto Transfer is enabled and a drive fault is detected, the bypass controller will wait this length of time before switching to bypass.	Default: 0.0 s Min.: 0.0 Max.: 300.0	173
Z1-41 (85EE) <3>	Hand Speed Reference Selection	Hand Spd Ref Sel	Selects the frequency reference source when in Hand Mode. 0: Parameter Z1-09 1: Analog	Default: 0 Range: 0, 1	173
Z1-42 (85EF) <4>	Bypass Device Type	Byp Device Type	Selects the type of device that is used for the bypass. 0: Contactor 1: Soft Starter Note: Setting 1 is required for bypasses with the softstarter option PW. This parameter is set to the correct value at the factory. It should not require adjustment.	Default: 0 Range: 0, 1	174
Z1-50 (85F7) <3>	Bypass Unbalanced Current Detection Level	Byp Unbal Level	Sets the current unbalance level between phases when operating in Bypass Mode.	Default: 25.0% Min.: 5.0 Max.: 25.0	174
Z1-51 (85F8) <3>	Bypass Unbalance Trip Time Detection Level	Byp Unbal Time	Sets the trip time for an unbalance condition operating in Bypass Mode. Note: Setting this parameter to 0.0 will disable unbalance detection.	Default: 5.0 s Min.: 0.0 Max.: 30.0	174
Z1-52 (85F9) <3>	Bypass Phase Rotation	Byp Phs Rotation	Determines the action to take when Bypass Mode phase rotation is incorrect 0: Disabled 1: Alarm 2: Fault	Default: 1 Range: 0 to 2	174
Z1-53 (85FA) <5>	Load Verification Fault Select	Load Verify	Enables and disables verification that the motor is running when commanded to run. 0: Disabled 1: Enabled	Default: 0 Range: 0, 1	175
Z1-54 (85FB) <5>	LCD Contrast Control	LCD Contrast	Sets the contrast of the LCD operator display on the bypass.	Default: 3 Range: 1 to 5	176
Z1-55 (85FC) <5>	Welded K3 Contactor Fault Select	Welded Contactor	Enables and disables detection of K3 "welded contactor" condition. 0: Disabled 1: Enabled	Default: 0 Range: 0, 1	176
Z1-60 (8601) <6>	Black Out Selection	Black out Selection	Determines the bypass behavior when contactor voltage drops below Z1-29 setting. 0: Fault 1: Restart	Default: 0 Range: 0, 1	176
Z1-61 (8602) <6>	Restart Delay	Restart Delay	Sets the time delay for restart.	Default: 10 s Min.: 10 s Max.: 300 s	176

<1> Default is 0 in bypass controller software versions VST800297 and earlier.

<2> Values are given in Hz, but actual values are dependent upon unit settings using drive parameters o1-03, o1-09, o1-10, and o1-11.

<3> Available in bypass controller software versions VST800298 and later.

<4> Available in bypass controller software versions VST800299 and later.

B.14 Z: Bypass Parameters

<5> Available in bypass controller software versions VST800400 and later.

<6> Available in bypass controller software versions VST800401 and later.

◆ Z2: Bypass Control Input/Output

No. (Addr. Hex)	Name	Description	Values	Page
Z2-01 (8563) <input type="checkbox"/> RUN	Digital Input 1 Function Select	0: Unused (Available for Serial Comms) 3: DRV Multi-Function Input S3 (H1-03 Setting) 4: DRV Multi-Function Input S4 (H1-04 Setting) 5: DRV Multi-Function Input S5 (H1-05 Setting) 6: DRV Multi-Function Input S6 (H1-06 Setting) 7: DRV Multi-Function Input S7 (H1-07 Setting)	Default: 21 Range: 0 to 36	177
Z2-02 (8564) <input type="checkbox"/> RUN	Digital Input 2 Function Select	8: DRV Multi-Function Input S8 (H1-08 Setting) <1/> 21: Run (AUTO Mode)	Default: 22 Range: 0 to 36	177
Z2-03 (8565) <input type="checkbox"/> RUN	Digital Input 3 Function Select	22: Run Enable (Safety) 23: Run Interlock (BAS) 24: Remote Transfer to Bypass 25: Smoke Purge Bypass Run to Destruction	Default: 23 Range: 0 to 36	177
Z2-04 (8566) <input type="checkbox"/> RUN	Digital Input 4 Function Select	26: Smoke Purge Drive Run to Destruction at Smoke Purge Preset Speed (See Z1-10). Bypass controller will stay in this state even if the drive faults or is unavailable. 27: Motor OR Select (2-Motor OR function; 0/1 for Motor 1/2. Behavior defined by Z1-11)	Default: 24 Range: 0 to 36	177
Z2-05 (8567) <input type="checkbox"/> RUN	Digital Input 5 Function Select	28: Motor AND Select (2-Motor AND function; 0/1 for 1/2 motor. If 1 motor, then look to Motor OR input for selected motor. Behavior defined by Z1-11) 29: Motor 1 Overload Contact. When input is open, declare an OL Fault, issue an EF0 fault to the drive, delay per EF0 Fault Delay Time (Z1-30), and open Drive Output (K2) and Bypass (K3) contactors. 30: Motor 2 Overload Contact. When input is open, declare an OL Fault, issue an EF0 fault to the drive, delay per EF0 Fault Delay Time (Z130), and open Drive Output (K2) and Bypass (K3) contactors. 31: HAND Select 32: AUTO Select 33: DRIVE/BYPASS Select (0/1 for Drive/Bypass)	Default: 25 Range: 0 to 36	177
Z2-06 (8568) <input type="checkbox"/> RUN	Digital Input 6 Function Select	34: Fault Reset 35: External Fault (EF0) 36: External Fault (EFB) 37: Run Reverse	Default: 0 Range: 0 to 36	177
Z2-07 (8569)	Digital Input 7 Function Select		Default: 0 Range: 0 to 36	177
Z2-08 (856A) <input type="checkbox"/> RUN	Digital Input 8 Function Select		Default: 29 Range: 0 to 36	177
Z2-09 (856B) <input type="checkbox"/> RUN	Digital Input 1 Invert Select	0: Normal. Lack of input signal = OFF 1: Inverted. Lack of input signal = ON	Default: 0 Range: 0, 1	179
Z2-10 (856C) <input type="checkbox"/> RUN	Digital Input 2 Invert Select	0: Normal. Lack of input signal = OFF 1: Inverted. Lack of input signal = ON	Default: 1 Range: 0, 1	179
Z2-11 (856D) <input type="checkbox"/> RUN	Digital Input 3 Invert Select	0: Normal. Lack of input signal = OFF 1: Inverted. Lack of input signal = ON	Default: 0 Range: 0, 1	179
Z2-12 (856E) <input type="checkbox"/> RUN	Digital Input 4 Invert Select	0: Normal. Lack of input signal = OFF 1: Inverted. Lack of input signal = ON	Default: 0 Range: 0, 1	179
Z2-13 (856F) <input type="checkbox"/> RUN	Digital Input 5 Invert Select	0: Normal. Lack of input signal = OFF 1: Inverted. Lack of input signal = ON	Default: 0 Range: 0, 1	179
Z2-14 (8570) <input type="checkbox"/> RUN	Digital Input 6 Invert Select	0: Normal. Lack of input signal = OFF 1: Inverted. Lack of input signal = ON	Default: 0 Range: 0, 1	179

Parameter List

B

B.14 Z: Bypass Parameters

No. (Addr. Hex)	Name	Description	Values	Page
Z2-15 (8571) RUN	Digital Input 7 Invert Select	0: Normal. Lack of input signal = OFF 1: Inverted. Lack of input signal = ON	Default: 0 Range: 0, 1	179
Z2-16 (8572) RUN	Digital Input 8 Invert Select	0: Normal. Lack of input signal = OFF 1: Inverted. Lack of input signal = ON	Default: 1 Range: 0, 1	179
Z2-23 (8579) RUN	Digital Output 7 Function Select	Digital Output 1 Function Select 0: Serial Comm Controlled 1: K1 Drive Input Contactor 2: K2 Drive Output Contactor 3: K3 Bypass Contactor	Default: 7 Range: 0 to 23; 99	170
Z2-24 (857A) RUN	Digital Output 8 Function Select	4: K4 Motor 1 Select 5: K5 Motor 2 Select 6: READY (Drive and Bypass)	Default: 10 Range: 0 to 23; 99	170
Z2-25 (857B) RUN	Digital Output 9 Function Select	7: RUN Active (Drive or Bypass) 8: Drive RUN Active 9: Bypass RUN Active 10: HAND Mode Active	Default: 12 Range: 0 to 23; 99	170
Z2-26 (857C) RUN	Digital Output 10 Function Select	11: OFF Mode Active 12: AUTO Mode Active 13: Drive Mode Selected 14: Bypass Mode Selected 15: Drive or Bypass Fault Active 16: Drive Fault Active 17: Bypass Fault Active 18: Auto Transfer Active 19: Serial RUN Command Active 20: Damper Actuator Output 21: ON Always 22: Loss of Load Detected 23: Run Verify <2> 99: Not Used	Default: 15 Range: 0 to 23; 99	170
Z2-31 (8581) <2>	Safety Open Message Selection	Sets the fault message displayed when an FB01 fault is triggered. 0: Safety Open 1: Fire Stat 2: Freeze Stat 3: Smoke Alarm 4: Over Pressure 5: Low Suction 6: Vibration Switch	Default: 0 Range: 0 to 6	180

<1> Available in bypass controller software versions VST800299 and later.

<2> Available in bypass controller software versions VST800298 and later.

◆ Z3: Bypass Control Communication

No. (Addr. Hex)	Name	Description	Values	Page
Z3-01 (8500) RUN	Serial Communications Protocol Select	Selects the bypass serial communications protocol. 0: Modbus 1: N2 2: P1 3: BACnet	Default: 3 Range: 0 to 3	180
Z3-02 (8501) RUN	Serial Communications Node Address Select	Selects the bypass serial communications node address.	Default: 1 Min.: 0 Max.: 127	180

B.14 Z: Bypass Parameters

No. (Addr. Hex)	Name	Description	Values	Page
Z3-03 (8502) <input type="checkbox"/> RUN	Serial Communications Baud Rate Select	Selects the bypass serial communications speed. 0: 1200 bps <2> 1: 2400 bps <2> 2: 4800 bps <2> 3: 9600 bps 4: 19200 bps 5: 38400 bps 6: 57600 bps 7: 76800 bps 8: 115200 bps	Default: 3 Range: 0 to 8	180
Z3-04 (8503) <input type="checkbox"/> RUN	Serial Communications Parity Select	Selects the bypass serial communications parity. 0: No Parity 1: Even Parity 2: Odd Parity	Default: 0 Range: 0 to 2	181
Z3-05 (8504) <input type="checkbox"/> RUN	Serial Communications Fault Select	Selects the action to take when a serial communications fault is detected. 0: Ignore. A serial communications loss will result in no action being taken. 1: Alarm only. 2: Fault with EF0. An EF0 will be sent to the drive. If running in Bypass mode, the bypass contactor will NOT open and the motor will keep running. 3: Fault with EF0 and Open Contactors. An EF0 fault will be sent to the drive and the bypass contactor (K3) will be opened. 4: Alarm and run at preset speed set in Z3-10. Display AL14 alarm on Operator.	Default: 1 Range: 0 to 4	335
Z3-06 (8505) <input type="checkbox"/> RUN	Serial Communications Fault Time Select	Sets the time allowed to elapse since receiving serial communications before triggering a communications fault. A setting of 0.0 will never time out.	Default: 2.0 s Min.: 0.0 Max.: 99.9	181
Z3-07 (8506) <input type="checkbox"/> RUN	Serial Communications Receive to Transmit Wait Time	Sets the time to delay a serial communications response to a serial communications command.	Default: 5 ms Min.: 0 Max.: 99 ms	181
Z3-08 (8507) <input type="checkbox"/> RUN	BACnet Device Object Identifier 0	BACnet only. Sets the least significant word of 22-bit virtual address.	Default: 1 Min.: 0 Max.: FFFF	181
Z3-09 (8508) <input type="checkbox"/> RUN	BACnet Device Object Identifier 1	BACnet only. Sets the most significant word of 22-bit virtual address.	Default: 0 Min.: 0 Max.: 003F	181
Z3-10 (8509) <input type="checkbox"/> RUN	Cable Loss Preset Frequency	When a serial communications fault is detected and Z3-05=4, the resulting value will become the frequency reference.	Default: 0 Min.: 0.0 Hz Max.: 60.0 Hz	181
Z3-11 (850A) <input type="checkbox"/> RUN	Communication Fault Detection Selection	Communication Fault Detection Selection 0: Disabled. Serial communications fault detection is completely disabled. 1: Enabled. Behavior defined by Z3-05.	Default: 1 Range: 0, 1	181
Z3-12 (850B) <1>	Network Digital Input Select	Enables and disables control of the digital inputs over a network. Wiring to the physical digital input is not required. 0: Disable 1: Enable	Default: 0 Range: 0, 1	182
Z3-13 (850C) <3> <4>	BACNet Command Register Retention	Determines whether to restore the frequency reference, bypass command, or both upon the reapplication of power after losing power. WARNING! Sudden Movement Hazard. Setting this parameter to 2 or 3 will allow the bypass unit to start before receiving a valid network message. Clear all personnel from the drive, motor, and machine area before reapplying power. Failure to comply could result in injury to personnel. 0: Disable 1: Reference Only 2: Run/Stop Only 3: Ref & Run/Stop	Default: 0 Range: 0 to 3	182

Parameter List

B

<1> Available in bypass controller software versions VST800298 and later.

<2> Selecting settings 0, 1, or 2 will trigger an oPE29 error when using BACNet communication in bypass controller software versions VST800400 and later.

B.14 Z: Bypass Parameters

<3> Available in bypass controller software versions VST800400 and later.

<4> Parameter is effective only when Z3-01 = 3 (Serial Communications Protocol Select = BACnet), Z1-07 = 2 (Speed Reference Select = Bypass Serial), and/or Z1-08 = 2 (Run Command Select = Bypass Serial).

◆ Z4: Bypass Control Option Boards

No. (Addr. Hex)	Name	Description	Values	Page
Z4-01 (8700) <input type="checkbox"/> RUN	IP Address 1	Sets the most significant octet of network static IP address.	Default: 192 Range: 0 to 255	183
Z4-02 (8701) <input type="checkbox"/> RUN	IP Address 2	Sets the second most significant octet of network static IP address.	Default: 168 Range: 0 to 255	183
Z4-03 (8702) <input type="checkbox"/> RUN	IP Address 3	Sets the third most significant octet of network static IP address.	Default: 1 Range: 0 to 255	183
Z4-04 (8703) <input type="checkbox"/> RUN	IP Address 4	Sets the fourth most significant octet of network static IP address.	Default: 20 Range: 0 to 255	183
Z4-05 (8704) <input type="checkbox"/> RUN	Subnet Mask 1	Sets the most significant octet of network static subnet mask.	Default: 255 Range: 0 to 255	183
Z4-06 (8705) <input type="checkbox"/> RUN	Subnet Mask 2	Sets the second most significant octet of network static subnet mask.	Default: 255 Range: 0 to 255	183
Z4-07 (8706) <input type="checkbox"/> RUN	Subnet Mask 3	Sets the third most significant octet of network static subnet mask.	Default: 255 Range: 0 to 255	183
Z4-08 (8707) <input type="checkbox"/> RUN	Subnet Mask 4	Sets the fourth most significant octet of network static subnet mask.	Default: 0 Range: 0 to 255	183
Z4-09 (8708) <input type="checkbox"/> RUN	Gateway IP Address 1	Sets the most significant octet of network gateway address.	Default: 192 Range: 0 to 255	183
Z4-10 (8709) <input type="checkbox"/> RUN	Gateway IP Address 2	Sets the second most significant octet of network gateway address.	Default: 168 Range: 0 to 255	183
Z4-11 (870A) <input type="checkbox"/> RUN	Gateway IP Address 3	Sets the third most significant octet of network gateway address.	Default: 1 Range: 0 to 255	183
Z4-12 (870B) <input type="checkbox"/> RUN	Gateway IP Address 4	Sets the fourth most significant octet of network gateway address.	Default: 1 Range: 0 to 255	183
Z4-13 (870C) <input type="checkbox"/> RUN	IP Address Mode Select	0: User-Defined (Static IP) 1: BOOTP 2: DHCP	Default: 2 Range: 0 to 2	184
Z4-14 (870D) <input type="checkbox"/> RUN	Duplex Select	0: Forced Half Duplex 1: Auto Negotiate Duplex Mode and Communication Speed 2: Forced Full Duplex	Default: 1 Range: 0 to 2	184
Z4-15 (870E) <input type="checkbox"/> RUN	Speed Mode Setting	10: 10 Mbps 100: 100 Mbps	Default: 10 Range: 10, 100	184

B.14 Z: Bypass Parameters

No. (Addr. Hex)	Name	Description	Values	Page
Z4-16 (870F) <input type="checkbox"/> RUN	Communication Loss Timeout	Control connection timeout value for detection of communication loss.	Default: 0 s Min.: 0 Max.: 300	184
Z4-17 (8710) <input type="checkbox"/> RUN	Ethernet Speed Scale	AC/DC Drive Object, Instance 1, Attribute 22	Default: 0 Min.: -15 Max.: 15	184
Z4-18 (8711) <input type="checkbox"/> RUN	Ethernet Current Scale	AC/DC Drive Object, Instance 1, Attribute 23	Default: 0 Min.: -15 Max.: 15	184
Z4-19 (8712) <input type="checkbox"/> RUN	Ethernet Torque Scale	AC/DC Drive Object, Instance 1, Attribute 24	Default: 0 Min.: -15 Max.: 15	184
Z4-20 (8713) <input type="checkbox"/> RUN	Ethernet Power Scale	AC/DC Drive Object, Instance 1, Attribute 26	Default: 0 Min.: -15 Max.: 15	184
Z4-21 (8714) <input type="checkbox"/> RUN	Ethernet Voltage Scale	AC/DC Drive Object, Instance 1, Attribute 27	Default: 0 Min.: -15 Max.: 15	184
Z4-22 (8715) <input type="checkbox"/> RUN	Ethernet Time Scale	AC/DC Drive Object, Instance 1, Attribute 28	Default: 0 Min.: -15 Max.: 15	184
Z4-23 to Z4-32 (8716 to 871F) <input type="checkbox"/> RUN	Dynamic Output Assembly Parameters DOA116 1 to DOA116 10	Parameters used in Output Assembly 116	Default: 0 Range: 0 to FFFF	185
Z4-33 to Z4-42 (8720 to 8729) <input type="checkbox"/> RUN	Dynamic Input Assembly Parameters DIA166 1 to DIA166 10	Parameters used in Output Assembly 166	Default: 0 Range: 0 to FFFF	185

B.15 Defaults by Drive Model

B.15 Defaults by Drive Model

The following tables show parameters and default settings that change with the drive model selection (o2-04).

Table B.4 208 Vac Bypass Drive Default Settings by Drive Model Selection

No.	Name	Unit	Default Settings		
			2A0004	2A0006	2A0008
-	Drive Model	-	2A0004	2A0006	2A0008
	Bypass Model	-	D002 D003	D004	D007
o2-04	Drive Model Selection	Hex.	62	63	64
E2-11	Motor Rated Output	kW (HP)	0.75 (0.75)	1.1 (1)	1.5 (2)
b3-04	V/f Gain during Speed Search	%	100	100	100
b3-06	Output Current 1 during Speed Search	-	1	0.5	0.5
b3-07	Output Current 2 during Speed Search (Speed Estimation Type)	-	-	-	-
b3-26	Start Speed Search Select	-	-	-	-
b8-03	Energy Saving Control Filter Time Constant	s	0.50	0.50	0.50
b8-04	Energy Saving Coefficient Value	-	223.7	196.6	169.4
C5-17	Motor Inertia	kgm ²	0.0028	0.0068	0.0068
C6-02	Carrier Frequency Selection	-	7	7	7
E2-01	Motor Rated Current	A	3.3	4.9	6.2
E2-02	Motor Rated Slip	Hz	2.5	2.6	2.6
E2-03	Motor No-Load Current	A	1.8	2.3	2.8
E2-05	Motor Line-to-Line Resistance	Ω	5.156	3.577	1.997
E2-06	Motor Leakage Inductance	%	13.8	18.5	18.5
E2-10	Motor Iron Loss for Torque Compensation	W	26	38	53
L2-02	Momentary Power Loss Ride-Thru Time	s	0.1	0.2	0.3
L2-03	Momentary Power Loss Minimum Baseblock Time	s	0.3	0.4	0.4
L2-04	Momentary Power Loss Voltage Recovery Time	s	0.3	0.3	0.3
L3-24	Motor Acceleration Time for Inertia Calculations	s	0.142	0.142	0.166
L8-02	Overheat Alarm Level	°C	115	115	115
L8-35	Installation Method Selection	-	2	2	2
L8-38	Carrier Frequency Reduction Selection	-	2	2	2
n1-03	Hunting Prevention Time Constant	ms	10	10	10

B.15 Defaults by Drive Model

No.	Name	Unit	Default Settings		
			2A0012	2A0018	2A0030
–	Drive Model	–	D010	D016	D024
	Bypass Model		D010	D016	D024
o2-04	Drive Model Selection	Hex.	66	67	6A
E2-11	Motor Rated Output	kW (HP)	3.0 (3)	3.7 (5)	7.5 (10)
b3-04	V/f Gain during Speed Search	%	100	100	100
b3-06	Output Current 1 during Speed Search	–	0.5	0.5	0.5
b3-07	Output Current 2 during Speed Search (Speed Estimation Type)	–	–	–	–
b3-26	Start Speed Search Select	–	–	–	–
b8-03	Energy Saving Control Filter Time Constant	s	0.50	0.50	0.50
b8-04	Energy Saving Coefficient Value	–	136.4	122.9	72.69
C5-17	Motor Inertia	kgm ²	0.0158	0.0158	0.037
C6-02	Carrier Frequency Selection	–	7	7	7
E2-01	Motor Rated Current	A	11.4	14	26.6
E2-02	Motor Rated Slip	Hz	2.7	2.73	1.3
E2-03	Motor No-Load Current	A	3.7	4.5	8
E2-05	Motor Line-to-Line Resistance	Ω	1.034	0.771	0.288
E2-06	Motor Leakage Inductance	%	19	19.6	15.5
E2-10	Motor Iron Loss for Torque Compensation	W	91	112	262
L2-02	Momentary Power Loss Ride-Thru Time	s	0.5	1	1
L2-03	Momentary Power Loss Minimum Baseblock Time	s	0.5	0.6	0.8
L2-04	Momentary Power Loss Voltage Recovery Time	s	0.3	0.3	0.3
L3-24	Motor Acceleration Time for Inertia Calculations	s	0.145	0.154	0.175
L8-02	Overheat Alarm Level	°C	125	110	120
L8-35	Installation Method Selection	–	2	2	2
L8-38	Carrier Frequency Reduction Selection	–	2	2	2
n1-03	Hunting Prevention Time Constant	ms	10	10	10

B.15 Defaults by Drive Model

No.	Name	Unit	Default Settings			
			2A0040	2A0056	2A0069	2A0081
–	Drive Model	–	D030	D046	D059	D074
	Bypass Model		D030	D046	D059	D074
o2-04	Drive Model Selection	Hex.	6B	6D	6E	6F
E2-11	Motor Rated Power	kW (HP)	11 (15)	15 (20)	18.5 (25)	22 (30)
b3-04	V/f Gain during Speed Search	%	100	100	100	100
b3-06	Output Current 1 during Speed Search	–	0.5	0.5	0.5	0.5
b3-07	Output Current 2 during Speed Search (Speed Estimation Type)	–	–	–	–	–
b3-26	Start Speed Search Select	–	–	–	–	–
b8-03	Energy Saving Control Filter Time Constant	s	0.50	0.50	0.50	0.50
b8-04	Energy Saving Coefficient Value	–	70.44	63.13	57.87	51.79
C5-17	Motor Inertia	kgm ²	0.053	0.076	0.138	0.165
C6-02	Carrier Frequency Selection	–	7	7	7	7
E2-01	Motor Rated Current	A	39.7	53	65.8	77.2
E2-02	Motor Rated Slip	Hz	1.7	1.6	1.67	1.7
E2-03	Motor No-Load Current	A	11.2	15.2	15.7	18.5
E2-05	Motor Line-to-Line Resistance	Ω	0.23	0.138	0.101	0.079
E2-06	Motor Leakage Inductance	%	19.5	17.2	15.7	19.5
E2-10	Motor Iron Loss for Torque Compensation	W	245	272	505	538
L2-02	Momentary Power Loss Ride-Thru Time	s	1	2	2	2
L2-03	Momentary Power Loss Minimum Baseblock Time	s	0.9	1	1	1
L2-04	Momentary Power Loss Voltage Recovery Time	s	0.3	0.6	0.6	0.6
L3-24	Motor Acceleration Time for Inertia Calculations	s	0.265	0.244	0.317	0.355
L8-02	Overheat Alarm Level	°C	125	120	120	125
L8-35	Installation Method Selection	–	2	2	2	2
L8-38	Carrier Frequency Reduction Selection	–	2	2	2	2
n1-03	Hunting Prevention Time Constant	ms	10	10	10	10

B.15 Defaults by Drive Model

No.	Name	Unit	Default Settings			
			2A0110	2A0138	2A0169	2A0211
–	Drive Model	–	2A0110	2A0138	2A0169	2A0211
	Bypass Model		D088	D114	D143 D169	D211
o2-04	Drive Model Selection	Hex.	70	72	73	74
E2-11	Motor Rated Power	kW (HP)	30 (40)	37 (50)	45 (60)	55 (75)
b3-04	V/f Gain during Speed Search	%	80	80	80	80
b3-06	Output Current 1 during Speed Search	–	0.5	0.5	0.5	0.5
b3-07	Output Current 2 during Speed Search (Speed Estimation Type)	–	–	–	–	–
b3-26	Start Speed Search Select	–	–	–	–	–
b8-03	Energy Saving Control Filter Time Constant	s	0.50	0.50	0.50	2.00
b8-04	Energy Saving Coefficient Value	–	46.27	38.16	35.78	31.35
C5-17	Motor Inertia	kgm ²	0.220	0.273	0.333	0.490
C6-02	Carrier Frequency Selection	–	7	7	7	7
E2-01	Motor Rated Current	A	105	131	160	190
E2-02	Motor Rated Slip	Hz	1.8	1.33	1.6	1.43
E2-03	Motor No-Load Current	A	21.9	38.2	44	45.6
E2-05	Motor Line-to-Line Resistance	Ω	0.064	0.039	0.03	0.022
E2-06	Motor Leakage Inductance	%	20.8	18.8	20.2	20.5
E2-10	Motor Iron Loss for Torque Compensation	W	699	823	852	960
L2-02	Momentary Power Loss Ride-Thru Time	s	2	2	2	2
L2-03	Momentary Power Loss Minimum Baseblock Time	s	1.1	1.1	1.2	1.3
L2-04	Momentary Power Loss Voltage Recovery Ramp Time	s	0.6	0.6	1	1
L3-24	Motor Acceleration Time for Inertia Calculations	s	0.323	0.32	0.387	0.317
L8-02	Overheat Alarm Level	°C	130	130	130	125
L8-35	Installation Method Selection	–	0	0	0	0
L8-38	Carrier Frequency Reduction Selection	–	2	2	2	2
n1-03	Hunting Prevention Time Constant	ms	10	10	10	10

B.15 Defaults by Drive Model

No.	Name	Unit	Default Settings		
			2A0312	2A0360	2A0415
–	Drive Model	–	2A0312	2A0360	2A0415
	Bypass Model		D273	D343	D396
o2-04	Drive Model Selection	Hex.	76	77	78
E2-11	Motor Rated Power	kW (HP)	37 (125)	45 (150)	55 (175)
b3-04	V/f Gain during Speed Search	%	80	80	80
b3-06	Output Current 1 during Speed Search	–	0.7	0.7	0.7
b3-07	Output Current 2 during Speed Search (Speed Estimation Type)	–	–	–	–
b3-26	Start Speed Search Select	–	–	–	–
b8-03	Energy Saving Control Filter Time Constant	s	2.00	2.00	2.00
b8-04	Energy Saving Coefficient Value	–	20.65	18.12	18.12
C5-17	Motor Inertia	kgm ²	1.10	1.90	1.90
C6-02	Carrier Frequency Selection	–	7	7	7
E2-01	Motor Rated Current	A	260	260	260
E2-02	Motor Rated Slip	Hz	1.39	1.39	1.39
E2-03	Motor No-Load Current	A	72	72	72
E2-05	Motor Line-to-Line Resistance	Ω	0.023	0.023	0.023
E2-06	Motor Leakage Inductance	%	20	20	20
E2-10	Motor Iron Loss for Torque Compensation	W	1200	1200	1200
L2-02	Momentary Power Loss Ride-Thru Time	s	2	2	2
L2-03	Momentary Power Loss Minimum Baseblock Time	s	1.5	1.7	1.7
L2-04	Momentary Power Loss Voltage Recovery Ramp Time	s	1	1	1
L3-24	Motor Acceleration Time for Inertia Calculations	s	0.592	0.646	0.646
L8-02	Overheat Alarm Level	°C	120	120	120
L8-35	Installation Method Selection	–	0	0	0
L8-38	Carrier Frequency Reduction Selection	–	2	2	2
n1-03	Hunting Prevention Time Constant	ms	10	100	100

B.15 Defaults by Drive Model

Table B.5 400 V Class Drives Default Settings by Drive Model

No.	Name	Unit	Default Settings		
			4A0002	4A0004	4A0005
–	Drive Model	–	B001 B002	B003	B004
	Bypass Model				
o2-04	Drive Model Selection	Hex.	92	93	94
E2-11	Motor rated power	kW (HP)	0.75 (0.75)	1.5 (2)	2.2 (3)
b3-04	V/f Gain during Speed Search	%	100	100	100
b3-06	Output Current 1 during Speed Search	–	0.5	0.5	0.5
b3-07	Output Current 2 during Speed Search (Speed Estimation Type)	–	–	–	–
b3-26	Start Speed Search Select	–	–	–	–
b8-03	Energy Saving Control Filter Time Constant	s	0.50	0.50	0.50
b8-04	Energy Saving Coefficient Value	–	447.4	338.8	313.6
C5-17	Motor Inertia	kgm ²	0.0028	0.0068	0.0088
C6-02	Carrier Frequency Selection	–	7	7	7
E2-01	Motor Rated Current	A	1.6	3.1	4.2
E2-02	Motor Rated Slip	Hz	2.6	2.5	3
E2-03	Motor No-Load Current	A	0.8	1.4	1.5
E2-05	Motor Line-to-Line Resistance	Ω	22.459	10.1	6.495
E2-06	Motor Leakage Inductance	%	14.3	18.3	18.7
E2-10	Motor Iron Loss for Torque Compensation	W	26	53	77
L2-02	Momentary Power Loss Ride-Thru Time	s	0.1	0.2	0.3
L2-03	Momentary Power Loss Min. Baseblock Time	s	0.3	0.4	0.5
L2-04	Momentary Power Loss Voltage Recovery Time	s	0.3	0.3	0.3
L3-24	Motor Acceleration Time for Inertia Calculations	s	0.142	0.166	0.145
L8-02	Overheat Alarm Level	°C	110	110	110
L8-35	Installation Method Selection	–	2	2	2
L8-38	Carrier Frequency Reduction Selection	–	2	2	2
n1-03	Hunting Prevention Time Constant	ms	10	10	10

B.15 Defaults by Drive Model

No.	Name	Unit	Default Settings			
			4A0009	4A0011	4A0018	4A0023
–	Drive Model	–	4A0009	4A0011	4A0018	4A0023
	Bypass Model		B007	B011	B014	B021
o2-04	Drive Model Selection	Hex.	96	97		9A
E2-11	Motor Rated Power	kW (HP)	3.7 (5)	5.5 (7.5)	7.5 (10)	11 (15)
b3-04	V/f Gain during Speed Search	%	100	100	100	100
b3-06	Output Current 1 during Speed Search	–	0.5	0.5	0.5	0.5
b3-07	Output Current 2 during Speed Search (Speed Estimation Type)	–	–	–	–	–
b3-26	Start Speed Search Select	–	–	–	–	–
b8-03	Energy Saving Control Filter Time Constant	s	0.50	0.50	0.50	0.50
b8-04	Energy Saving Coefficient Value	–	245.8	189.5	145.38	140.88
C5-17	Motor Inertia	kgm ²	0.0158	0.0255	0.037	0.053
C6-02	Carrier Frequency Selection	–	7	7	7	7
E2-01	Motor Rated Current	A	7	9.8	13.3	19.9
E2-02	Motor Rated Slip	Hz	2.7	1.5	1.3	1.7
E2-03	Motor No-Load Current	A	2.3	2.6	4	5.6
E2-05	Motor Line-to-Line Resistance	Ω	3.333	1.595	1.152	0.922
E2-06	Motor Leakage Inductance	%	19.3	18.2	15.5	19.6
E2-10	Motor Iron Loss for Torque Compensation	W	130	193	263	385
L2-02	Momentary Power Loss Ride-Thru Time	s	0.5	0.5	0.8	1
L2-03	Momentary Power Loss Min. Baseblock Time	s	0.6	0.7	0.8	0.9
L2-04	Momentary Power Loss Voltage Recovery Time	s	0.3	0.3	0.3	0.3
L3-24	Motor Acceleration Time for Inertia Calculations	s	0.154	0.168	0.175	0.265
L8-02	Overheat Alarm Level	°C	110	110	110	115
L8-35	Installation Method Selection	–	2	2	2	2
L8-38	Carrier Frequency Reduction Selection	–	2	2	2	2
n1-03	Hunting Prevention Time Constant	ms	10	10	10	10

B.15 Defaults by Drive Model

No.	Name	Unit	Default Settings			
			4A0031	4A0038	4A0044	4A0058
–	Drive Model	–	B027	B034	B040	B052
o2-04	Drive Model Selection	Hex.	9C	9D	9E	9F
E2-11	Motor Rated Power	kW (HP)	15 (20)	18.5 (25)	22 (30)	30 (40)
b3-04	V/f Gain during Speed Search	%	100	100	100	100
b3-06	Output Current 1 during Speed Search	–	0.5	0.5	0.5	0.5
b3-07	Output Current 2 during Speed Search (Speed Estimation Type)	–	–	–	–	–
b3-26	Start Speed Search Select	–	–	–	–	–
b8-03	Energy Saving Control Filter Time Constant	s	0.50	0.50	0.50	0.50
b8-04	Energy Saving Coefficient Value	–	126.26	115.74	103.58	92.54
C5-17	Motor Inertia	kgm ²	0.076	0.138	0.165	0.220
C6-02	Carrier Frequency Selection	–	7	7	7	7
E2-01	Motor Rated Current	A	26.5	32.9	38.6	52.3
E2-02	Motor Rated Slip	Hz	1.6	1.67	1.7	1.8
E2-03	Motor No-Load Current	A	7.6	7.8	9.2	10.9
E2-05	Motor Line-to-Line Resistance	Ω	0.55	0.403	0.316	0.269
E2-06	Motor Leakage Inductance	%	17.2	20.1	23.5	20.7
E2-10	Motor Iron Loss for Torque Compensation	W	440	508	586	750
L2-02	Momentary Power Loss Ride-Thru Time	s	2	2	2	2
L2-03	Momentary Power Loss Minimum Baseblock Time	s	1	1	1	1.1
L2-04	Momentary Power Loss Voltage Recovery Time	s	0.6	0.6	0.6	0.6
L3-24	Motor Acceleration Time for Inertia Calculations	s	0.244	0.317	0.355	0.323
L8-02	Overheat Alarm Level	°C	120	120	115	120
L8-35	Installation Method Selection	–	2	2	2	0
L8-38	Carrier Frequency Reduction Selection	–	2	2	2	2
n1-03	Hunting Prevention Time Constant	ms	10	10	10	10

B.15 Defaults by Drive Model

No.	Name	Unit	Default Settings			
			4A0072	4A0088	4A0103	4A0139
–	Drive Model	–	4A0072	4A0088	4A0103	4A0139
	Bypass Model		B065	B077	B096	B124
o2-04	Drive Model Selection	Hex.	A1	A2	A3	A4
E2-11	Motor rated power	kW (HP)	37 (50)	45 (60)	55 (75)	75 (100)
b3-04	V/f Gain during Speed Search	%	100	100	80	60
b3-06	Output Current 1 during Speed Search	–	0.5	0.5	0.5	0.7
b3-07	Output Current 2 during Speed Search (Speed Estimation Type)	–	–	–	–	–
b3-26	Start Speed Search Select	–	–	–	–	–
b8-03	Energy Saving Control Filter Time Constant	s	0.50	0.50	2.00	2.00
b8-04	Energy Saving Coefficient Value	–	76.32	71.56	67.2	46.2
C5-17	Motor Inertia	kgm ²	0.273	0.333	0.490	0.90
C6-02	Carrier Frequency Selection	–	7	7	7	7
E2-01	Motor Rated Current	A	65.6	79.7	95	130
E2-02	Motor Rated Slip	Hz	1.33	1.6	1.46	1.39
E2-03	Motor No-Load Current	A	19.1	22	24	36
E2-05	Motor Line-to-Line Resistance	Ω	0.155	0.122	0.088	0.092
E2-06	Motor Leakage Inductance	%	18.8	19.9	20	20
E2-10	Motor Iron Loss for Torque Compensation	W	925	1125	1260	1600
L2-02	Momentary Power Loss Ride-Thru Time	s	2	2	2	2
L2-03	Momentary Power Loss Min. Basebl. Time	s	1.1	1.2	1.2	1.3
L2-04	Momentary Power Loss Volt. Recov. Time	s	0.6	0.6	1	1
L3-24	Motor Acceleration Time for Inertia Calculations	s	0.32	0.387	0.317	0.533
L8-02	Overheat Alarm Level	°C	120	110	120	130
L8-35	Installation Method Selection	–	0	0	0	0
L8-38	Carrier Frequency Reduction Selection	–	2	2	2	2
n1-03	Hunting Prevention Time Constant	ms	10	10	10	30

B.15 Defaults by Drive Model

No.	Name	Unit	Default Settings		
			4A0165	4A0208	4A0250
–	Drive Model	–	4A0165	4A0208	4A0250
	Bypass Model		B156	B180	B240
o2-04	Drive Model Selection	Hex.	A5	A6	A7
E2-11	Motor rated power	kW (HP)	90 (125)	110 (150)	132 (200)
b3-04	V/f Gain during Speed Search	%	60	60	60
b3-06	Output Current 1 during Speed Search	–	0.7	0.7	0.7
b3-07	Output Current 2 during Speed Search (Speed Estimation Type)	–	–	–	–
b3-26	Start Speed Search Select	–	–	–	–
b8-03	Energy Saving Control Filter Time Constant	s	2.00	2.00	2.00
b8-04	Energy Saving Coefficient Value	–	38.91	36.23	32.79
C5-17	Motor Inertia	kgm ²	1.10	1.90	2.10
C6-02	Carrier Frequency Selection	–	7	7	7
E2-01	Motor Rated Current	A	156	190	223
E2-02	Motor Rated Slip	Hz	1.4	1.4	1.38
E2-03	Motor No-Load Current	A	40	49	58
E2-05	Motor Line-to-Line Resistance	Ω	0.056	0.046	0.035
E2-06	Motor Leakage Inductance	%	20	20	20
E2-10	Motor Iron Loss for Torque Compensation	W	1760	2150	2350
L2-02	Momentary Power Loss Ride-Thru Time	s	2	2	2
L2-03	Momentary Power Loss Min. Basebl. Time	s	1.5	1.7	1.7
L2-04	Momentary Power Loss Volt. Recov. Time	s	1	1	1
L3-24	Motor Acceleration Time for Inertia Calculations	s	0.592	0.646	0.673
L8-02	Overheat Alarm Level	°C	130	120	120
L8-35	Installation Method Selection	–	0	0	0
L8-38	Carrier Frequency Reduction Selection	–	2	2	2
n1-03	Hunting Prevention Time Constant	ms	30	30	30

B.15 Defaults by Drive Model

No.	Name	Unit	Default Settings			
			4A0362	4A0414	4A0515	4A0675
–	Drive Model	–	4A0362	4A0414	4A0515	4A0675
	Bypass Model		B302 B361	B414	B515	B590
o2-04	Drive Model Selection	Hex.	A9	AA	AC	AE
E2-11	Motor rated power	kW (HP)	185 (300)	220 (350)	250 (400 -450)	355 (500 -550)
b3-04	V/f Gain during Speed Search	%	60	60	60	60
b3-06	Output Current 1 during Speed Search	–	0.7	0.7	0.7	0.7
b3-07	Output Current 2 during Speed Search (Speed Estimation Type)	–	–	–	–	–
b3-26	Start Speed Search Select	–	–	–	–	–
b8-03	Energy Saving Control Filter Time Constant	s	2.00	2.00	2.00	2.00
b8-04	Energy Saving Coefficient Value	–	30.57	27.13	21.76	23.84
C5-17	Motor Inertia	kgm ²	3.60	4.10	6.50	12.00
C6-02	Carrier Frequency Selection	–	7	7	7	7
E2-01	Motor Rated Current	A	310	370	500	650
E2-02	Motor Rated Slip	Hz	1.3	1.3	1.25	1
E2-03	Motor No-Load Current	A	81	96	130	130
E2-05	Motor Line-to-Line Resistance	Ω	0.025	0.02	0.014	0.012
E2-06	Motor Leakage Inductance	%	20	20	20	20
E2-10	Motor Iron Loss for Torque Compensation	W	3200	3700	4700	5560
L2-02	Momentary Power Loss Ride-Thru Time	s	2	2	2	2
L2-03	Momentary Power Loss Min. Basebl. Time	s	1.9	2	2.1	2.3
L2-04	Momentary Power Loss Volt. Recov. Time	s	1	1	1	1
L3-24	Motor Acceleration Time for Inertia Calculations	s	0.864	0.91	1.392	1.667
L8-02	Overheat Alarm Level	°C	130	140	140	140
L8-35	Installation Method Selection	–	0	0	0	0
L8-38	Carrier Frequency Reduction Selection	–	2	2	2	2
n1-03	Hunting Prevention Time Constant	ms	30	100	100	100

Appendix: C

BACnet Communications

C.1	BACNET CONFIGURATION.....	310
C.2	COMMUNICATION SPECIFICATIONS.....	311
C.3	CONNECTING TO A NETWORK.....	312
C.4	BACNET SETUP PARAMETERS.....	314
C.5	BYPASS OPERATIONS BY BACNET.....	317
C.6	BACNET OBJECTS SUPPORTED.....	318
C.7	ACCESSING BYPASS PARAMETERS AND THE ENTER COMMAND.....	325
C.8	COMMUNICATION ERRORS.....	326
C.9	BACNET PROTOCOL IMPLEMENTATION CONFORMANCE STATEMENT....	327

C.1 BACnet Configuration

C.1 BACnet Configuration

The P1000 Bypass system can be monitored and controlled by a controller on a Building Automation and Control network (BACnet) using RS-485 technology and MS/TP (Master-Slave/Token-Passing) protocol. The P1000 Bypass conforms to the BACnet application specific controller (B-ASC) device profile. BACnet MS/TP connection is made to the bypass controller. Parameters and monitors in both the drive and the bypass controller are made accessible from this one connection.

Up to 127 bypasses can communicate on a single BACnet MS/TP network. If more bypasses or BACnet devices are required, then a BACnet router is required to allow another MS/TP network to be available with up to another 127 bypasses.

The BACnet node address is configurable by a parameter in the P1000 Bypass. This defines the physical address of the bypass on the MS/TP network. In addition, both the Device Object instance ID and the Device Object Name are configurable. These allow the bypass to have a virtual address, and simplify the controller configuration.

Once the addressing is set, a controller can initiate communication to the P1000 Bypass. The bypass will perform the specified function and then send a response back to the controller. The bypass will usually respond immediately, but may delay its response until it gets the token for commands that may take extra local processing time.

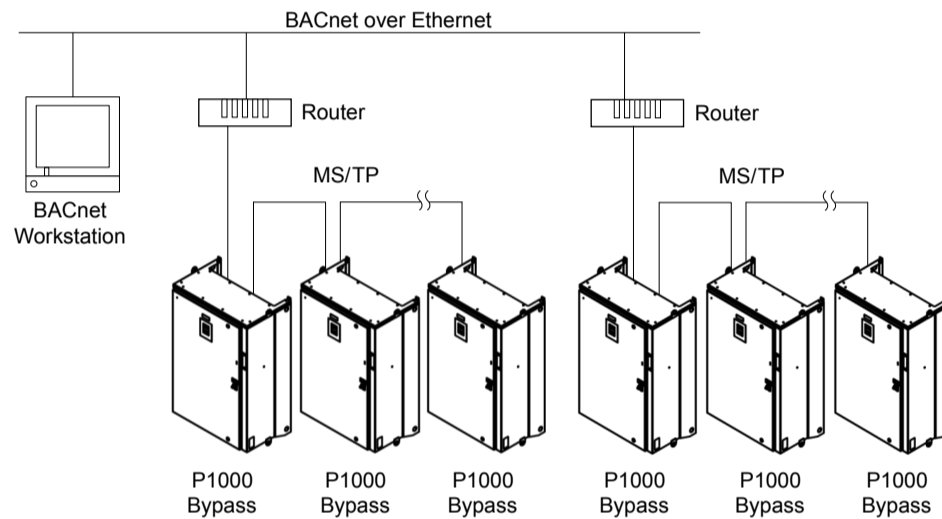

Figure C.1 Connecting Multiple P1000 Bypasses to a BACnet Workstation

C.2 Communication Specifications

BACnet specifications appear in the following table:

Item	Specifications
Interface	MS/TP (Master-Slave/Token-Passing) RS-485
Communication Parameters	Communication Speeds: 1200, 2400, 4800, 9600, 19200, 38400, 57600, 76800, 115200 bps
Protocol	BACnet MS/TP
Max Number of Bypasses	127 per MS/TP Network Segment

C.3 Connecting to a Network

C.3 Connecting to a Network

This section explains how to connect the P1000 Bypass to a BACnet network and the network termination required for a connection.

◆ Network Cable Connection

Follow the instructions below to connect the P1000 Bypass to a BACnet network.

1. With the power shut off, connect the communications cable to the bypass and the master. Use terminal TB3 on the Electronic Bypass Control Board A2 for BACnet.

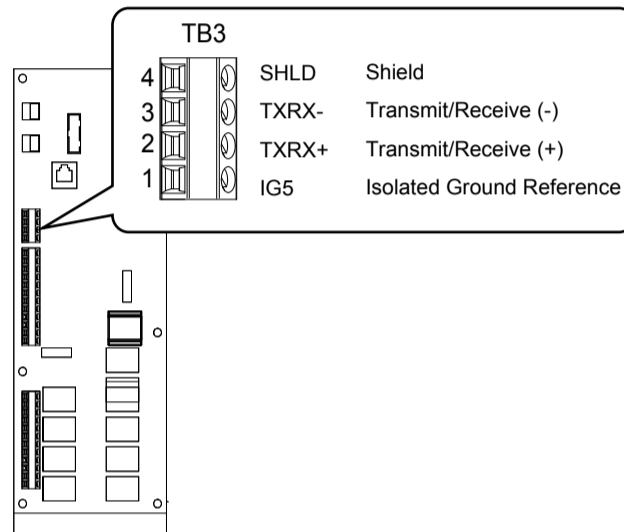

Figure C.2 Serial Communications Cable Connection Terminal (TB3)

Note: Separate the communications cables from the main circuit cables and other wiring and power cables. Use shielded cables for the communications cables, and properly shielded clamps to prevent problems caused by electrical interference.

2. Check or set the termination resistor selection at all slaves. Use the description in **Network Termination** on page 313 for slaves that are P1000 Bypasses.
3. Switch the power on.
4. Set the parameters needed for serial communications (Z3-01 through Z3-09) using the digital operator.
5. Shut the power off and wait until the display on the digital operator goes out completely.
6. Turn the power back on.
7. The P1000 Bypass is now ready to begin communicating with the master.

◆ **Wiring Diagram for Multiple Connections**

Figure C.3 explains the wiring diagrams for multiple connections using BACnet communication.

■ **MS/TP Interface**

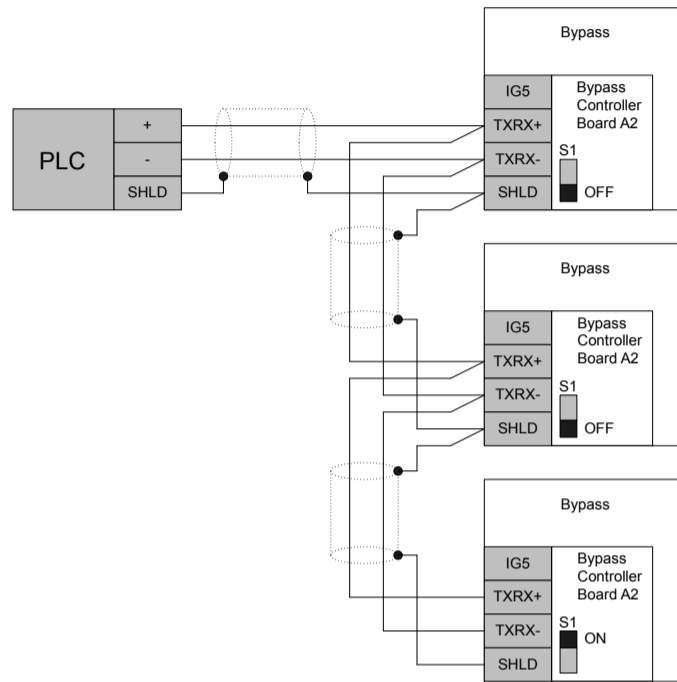

Figure C.3 Connection Diagram for Multiple Connections

Note: Turn on DIP switch S1 on the bypass that is located at the end of the network. If S1 is missing, then an external 120 ohm resistor must be placed across terminals TXRX+ and TXRX-. All other slave devices must have this DIP switch set to the OFF position (or if S1 is missing, no external resistor must be used).

◆ **Network Termination**

The two ends of the BACnet network line have to be terminated with a 120 ohm resistor between the TXRX+ and TXRX- signals. The P1000 Bypass has a built in termination resistor that can be enabled or disabled using DIP switch S1. If a bypass is located at the end of a network line, enable the termination resistor by setting DIP switch S1 to the ON position. Disable the termination resistor on all slaves that are not located at the network line end.

Note: Some bypass controllers do not have DIP switch S1. If this is the case, then an external 120 ohm resistor must be placed across the TXRX+ and TXRX- signals if the bypass controller is at the end of a network line.

C.4 BACnet Setup Parameters

◆ BACnet Serial Communication

This section describes parameters necessary to set up BACnet communications.

■ Z3-01: Serial Communications Protocol Select

Selects the bypass serial communications protocol.

No.	Name	Setting Range	Default
Z3-01	Serial Communications Protocol Select	0 to 3	3

Setting 0: Modbus

Setting 1: N2

Setting 2: P1

Setting 3: BACnet

■ Z3-02: Serial Communications Node Select

Selects the bypass serial communications node address.

Note: Each slave must be assigned a unique slave address for serial communications to work properly. Slave addresses do not need to be assigned in sequential order, but no two slaves may share the same address.

No.	Name	Setting Range	Default
Z3-02	Serial Communications Node Select	0 to 127	1

■ Z3-03: Serial Communications Baud Rate Select

Selects the bypass serial communications speed.

Selecting settings 0, 1, or 2 will trigger an oPE29 error when using BACnet communication (Z3-01 = 3) in bypass controller software versions VST800400 and later.

No.	Name	Setting Range	Default
Z3-03	Serial Communications Baud Rate Select	0 to 8	3

Setting 0: 1200 bps

Setting 1: 2400 bps

Setting 2: 4800 bps

Setting 3: 9600 bps

Setting 4: 19200 bps

Setting 5: 38400 bps

Setting 6: 57600 bps

Setting 7: 76800 bps

Setting 8: 115200 bps

■ Z3-05: Serial Communications Fault Select

Selects the action to take when a serial communications fault is detected. A serial communications fault is detected when after last communicating, no communications occurs within the time set to Z3-06.

No.	Name	Setting Range	Default
Z3-05	Serial Communications Fault Select	0 to 3	1

Setting 0: Ignore

Setting 1: Alarm Only

Setting 2: Fault with EF0

An EF0 fault will be sent to the drive.

Setting 3: Fault with EF0 and Open Contactors

An EF0 fault will be sent to the drive and the bypass contactor (K3) will be opened.

C.4 BACnet Setup Parameters

Setting 4: Alarm and Run at Preset Speed Set in Z3-10.
Display AL14 alarm on operator.

C.4 BACnet Setup Parameters

■ Z3-08, Z3-09: BACnet Device Object Identifier

These parameters set the Instance Identifier of the BACnet Device Object, where Z3-08 is the least significant word and Z3-09 is the most significant word.

No.	Name	Setting Range	Default
Z3-08	BACnet Device Object Identifier 0	0 to FFFFH	1
Z3-09	BACnet Device Object Identifier 1	0 to 003FH	0

Example 1: Set Device Object Instance Identifier of “1234”.

1234 decimal is equal to 4D2H (hexadecimal).

Set Z3-08 to 4D2H and set Z3-09 to 0.

Example 2: Set Device Object Instance Identifier of “123456”.

123456 decimal is equal to 1E240H.

Set Z3-08 to D687H and set Z3-09 to 12H.

C.5 Bypass Operations by BACnet

The bypass operations that can be performed by BACnet communication depend on parameter settings. This section explains the functions that can be used and related parameter settings.

◆ Observing the Bypass Operation

A controller can perform the following actions with BACnet communications at any time regardless of parameter settings:

- Observe bypass and drive status and control terminal status from a controller
- Read and write parameters
- Set and reset faults
- Set multi-function inputs.

Note: Input settings from the input terminals S□ and from BACnet communications are both linked by a logical OR operation.

◆ Controlling the Bypass

Select an external reference and adjust the parameters in *Table C.1* accordingly to start and stop the drive or set the frequency reference using BACnet communications.

Table C.1 Setting Parameters for Drive Control from BACnet

Reference Source	Parameter	Name	Required Setting
External Reference 1	Z1-07	Frequency Reference Select	2
	Z1-08	Run Command Select	2

Refer to Z1-07: Speed Reference Select on page 163 and Refer to Z1-08: Run Command Select on page 164 for details on external reference parameter selections.

C.6 BACnet Objects Supported

C.6 BACnet Objects Supported

◆ Present Value Access

The Present Value (PV) of BACnet objects can always be read. In addition, some PVs can be written or commanded. A commandable PV is similar to writing the value, but the value is actually written into a priority array. The value occupying the highest priority in the array will be used by the bypass. The convention for showing how the PV is accessed is shown in *Table C.2* and will be noted for the PV of each object.

Table C.2 Present Value Access Values

PV Access	Name	Description
C	Commandable	Value written to a priority array. The highest priority value in the array is then written to the bypass.
R	Readable	Value is read-only
W	Writable	Value written to the bypass

◆ Supported Properties of Objects

Table C.3 Object Properties

Property	Object Type						
	Device	Analog Input	Analog Output	Analog Value	Binary Output	Binary Output	Binary Value
Object_Identifier	Yes	Yes	Yes	Yes	Yes	Yes	Yes
Object_Name	Yes	Yes	Yes	Yes	Yes	Yes	Yes
Object_Type	Yes	Yes	Yes	Yes	Yes	Yes	Yes
System_Status	Yes	–	–	–	–	–	–
Vendor_Name	Yes	–	–	–	–	–	–
Vendor_Identifier	Yes	–	–	–	–	–	–
Model_Name	Yes	–	–	–	–	–	–
Firmware_Revision	Yes	–	–	–	–	–	–
Protocol_Version	Yes	–	–	–	–	–	–
Protocol_Revision	Yes	–	–	–	–	–	–
Protocol_Services_Supported	Yes	–	–	–	–	–	–
Protocol_Object_Types_Supported	Yes	–	–	–	–	–	–
Object_List	Yes	–	–	–	–	–	–
Max_ADPU_Length_Accepted	Yes	–	–	–	–	–	–
Segmentation_Supported	Yes	–	–	–	–	–	–
Local_Time	Yes	–	–	–	–	–	–
Local_Date	Yes	–	–	–	–	–	–
ADPU_Timeout	Yes	–	–	–	–	–	–
Number_Of_ADPU_Retries	Yes	–	–	–	–	–	–
Max_Masters	Yes	–	–	–	–	–	–
Max_Info_Frames	Yes	–	–	–	–	–	–
Device_Address_Binding	Yes	–	–	–	–	–	–
Database_Revision	Yes	–	–	–	–	–	–
Present_Value	–	Yes	Yes	Yes	Yes	Yes	Yes
Status_Flags	–	Yes	Yes	Yes	Yes	Yes	Yes
Event_State	–	Yes	Yes	Yes	Yes	Yes	Yes
Reliability	–	Yes	Yes	Yes	Yes	Yes	Yes
Out_Of_Service	–	Yes	Yes	Yes	Yes	Yes	Yes
Units	–	Yes	Yes	Yes	–	–	–
Priority_Array	–	–	Yes </>	Yes </>	–	Yes	Yes
Relinquish_Default	–	–	Yes </>	Yes </>	–	Yes	Yes
Polarity	–	–	–	–	Yes	Yes	–

C.6 BACnet Objects Supported

Property	Object Type						
	Device	Analog Input	Analog Output	Analog Value	Binary Output	Binary Output	Binary Value
Inactive_Text	–	–	–	–	Yes	Yes	Yes
Active_Text	–	–	–	–	Yes	Yes	Yes

<1> For Commandable Object Instances only.

◆ Analog Input Objects

Table C.4 Analog Input Objects

Object ID	Object Name	Modbus Address	Precision	Range	Units	PV Access
AI1	Analog Input 1 Level	004EH	XXXX.X	–	%	R
AI2	Analog Input 2 Level	004FH	XXXX.X	–	%	R
AI3	Not used AI3	–	–	–	–	–
AI4	Not used AI4	–	–	–	–	–
AI5	Not used AI5	–	–	–	–	–
AI6	Display Format o1-03	0502H	XXXXXX	–	–	R
AI7	Scale Format b5-20	01E2H	XXXXXX	–	–	R
AI8	Inverter Model o2-04	0508F	XXXXXX	–	–	R
AI9	Rated Current n9-01	05D0H	XXXX.X	–	Amps	R
AI10	Motor Current UB-01	8780H	XXXX.X	–	Amps	R
AI11	Contact Voltage	8790H	XXXXXX	–	Volts	R

◆ Analog Output Objects

Table C.5 Analog Output Objects

Object ID	Object Name	Modbus Address	Precision	Range	Units	PV Access
AO1	Analog Output 1 Level	0007H	XXXX.X	0 to 100.0	%	C
AO2	Analog Output 2 Level	0008H	XXXX.X	0 to 100.0	%	C

◆ Analog Value Objects

Table C.6 Analog Value Objects

Object ID	Object Name	Modbus Address	Precision	Range	Units	PV Access
AV1	Operation Cmd	0001H	–	–	–	C
AV2	Frequency Cmd	8401H	XXX.XX Depends on o1-03	0.00 to 600.00	Hz Depends on o1-03	C
AV3	PI Setpoint Cmd	0006H	XXX.XX	–100.00 to 100.00	%	C
AV4	MF Output Cmd	0009H	–	–	–	C
AV5	Reference Select Cmd	000FH	–	–	–	C
AV6	Drive Status	0020H	–	–	–	R
AV7	Fault Details	0021H	–	–	–	R
AV8	Data Link Status	0022H	–	–	–	R
AV9	Frequency Reference	0040H	XXX.XX Depends on o1-03	–	Hz Depends on o1-03	R
AV10	Output Frequency	0041H	XXX.XX Depends on o1-03	–	Hz Depends on o1-03	R
AV11	Output Voltage	0045H	XXXX.X	–	Volts	R
AV12	Output Current	0026H	XXXX.X	–	Amps	R

C.6 BACnet Objects Supported

Object ID	Object Name	Modbus Address	Precision	Range	Units	PV Access
AV13	Output Power	0047H	XXXX.X (for drives rated above 11 kVA) XXX.XX (for drives rated 11 kVA or lower)	–	kW	R
AV14	Torque Reference	0048H	XXXX.X	–	%	R
AV15	MF Input Status	002BH	–	–	–	R
AV16	Drive Status 2	002CH	–	–	–	R
AV17	MF Output Status	002DH	–	–	–	R
AV18	DC Bus Voltage	0031H	XXXXX	–	Volts	R
AV19	PI Feedback Level	0038H	XXXX.X	–	%	R
AV20	PI Input Level	0039H	XXXX.X	–	%	R
AV21	PI Output Level	003AH	XXXX.X	–	%	R
AV22	Drive SW Num	004DH	XXXXX	–	–	R
AV23	Bypass SW Num	8791H	XXXXX	–	–	R
AV24	Comm Error Detail	003DH	–	–	–	R
AV25	KVA Setting	003EH	XXXXX	–	–	R
AV26	Control Method	0043H	XXXXX	–	–	R
AV27	Accel Time	0200H	XXXX.X	0.0 to 6000.0	Sec	W
AV28	Decel Time	0201H	XXXX.X	0.0 to 6000.0	Sec	W
AV29 <1>	Parameter Number	–	XXXXX	0 to FFFFH	–	W
AV30 <1>	Parameter Data	–	XXXXX	0 to FFFFH	–	W
AV31	Motor Current	8780H	XXXX.X	–	Amps	R
AV32	120 V to Kx Coils	8790H	XXXXX	–	Volts	R
AV33 <2>	Drive kWh	0x005C and 0x005D	XXXXXXXX.X	0.0 to 32767999.9	kWh	R

<1> Refer to *Accessing Bypass Parameters and the Enter Command* on page 325 for an explanation of how to read and write drive parameters not listed in the analog or binary objects.

<2> Available in bypass controller software versions VST800298 and later.

◆ Binary Input Objects

Table C.7 Binary Input Objects

Object ID	Object Name	Modbus Address	Active Text	Inactive Text	PV Access
BI1	Input Terminal 1	002BH:bit 0	ON	OFF	R
BI2	Input Terminal 2	002BH:bit 1	ON	OFF	R
BI3	Input Terminal 3	002BH:bit 2	ON	OFF	R
BI4	Input Terminal 4	002BH:bit 3	ON	OFF	R
BI5	Input Terminal 5	002BH:bit 4	ON	OFF	R
BI6	Input Terminal 6	002BH:bit 5	ON	OFF	R
BI7	Input Terminal 7	002BH:bit 6	ON	OFF	R
BI8	Multi-Function Out 1	0020H:bit 5	ON	OFF	R
BI9	Multi-Function Out 2	0020H:bit 6	ON	OFF	R
BI10	BYP DI-1 STAT	8781H: bit 0	ON	OFF	R
BI11	BYP DI-2 STAT	8781H: bit 1	ON	OFF	R
BI12	BYP DI-3 STAT	8781H: bit 2	ON	OFF	R
BI13	BYP DI-4 STAT	8781H: bit 3	ON	OFF	R
BI14	BYP DI-5 STAT	8781H: bit 4	ON	OFF	R
BI15	BYP DI-6 STAT	8781H: bit 5	ON	OFF	R

C.6 BACnet Objects Supported

Object ID	Object Name	Modbus Address	Active Text	Inactive Text	PV Access
BI16	BYP DI-7 STAT	8781H: bit 6	ON	OFF	R
BI17	BYP DI-8 STAT	8781H: bit 7	ON	OFF	R
BI18	BYP DO-1 STAT	8782H: bit 0	ON	OFF	R
BI19	BYP DO-2 STAT	8782H: bit 1	ON	OFF	R
BI20	BYP DO-3 STAT	8782H: bit 2	ON	OFF	R
BI21	BYP DO-4 STAT	8782H: bit 3	ON	OFF	R
BI22	BYP DO-5 STAT	8782H: bit 4	ON	OFF	R
BI23	BYP DO-6 STAT	8782H: bit 5	ON	OFF	R
BI24	BYP DO-7 STAT	8782H: bit 6	ON	OFF	R
BI25	BYP DO-8 STAT	8782H: bit 7	ON	OFF	R
BI26	BYP DO-9 STAT	8783H: bit 0	ON	OFF	R
BI27	BYP DO-10 STAT	8783H: bit 1	ON	OFF	R

◆ Binary Output Objects

Table C.8 Binary Output Objects

Object ID	Object Name	Modbus Address	Active Text	Inactive Text	PV Access
BO1	MF Output M1-M2	0009H:bit 0	ON	OFF	C
BO2	MF Output M3-M4	0009H:bit 1	ON	OFF	C
BO3	MF Output M5-M6	0009H:bit 2	ON	OFF	C
BO4	Ref Sel: PI Setpoint	000FH:bit 1	ON	OFF	C
BO5	Ref Sel: Term S5 IN	8480H:bit 8	ON	OFF	C
BO6	Ref Sel: Term S6 IN	8480H:bit 9	ON	OFF	C
BO7	Ref Sel: Term S7 IN	8480H:bit 10	ON	OFF	C
BO8	BYP DO-07 COMMAND	8403H:bit 6	ON	OFF	C
BO9	BYP DO-08 COMMAND	8403H:bit 7	ON	OFF	C
B010	BYP DO-09 COMMAND	8403H:bit 8	ON	OFF	C
B011	BYP DO-10 COMMAND	8403H:bit 9	ON	OFF	C

◆ Binary Value Objects

Table C.9 Binary Value Objects

Object ID	Object Name	Modbus Address	Active Text	Inactive Text	PV Access
BV1	Not Used BV1	–	–	–	–
BV2	Not Used BV2	–	–	–	–
BV3	Ext Fault Cmd	8480H:bit 2	FAULT	OFF	C
BV4	Fault Reset Cmd	8480H:bit 3	RESET	OFF	C
BV5	Not Used BV5	–	–	–	–
BV6	Not Used BV6	–	–	–	–
BV7	MF Input 3 Cmd	8480H:bit 6	ON	OFF	C
BV8	MF Input 4 Cmd	8480H:bit 7	ON	OFF	C
BV9	MF Input 5 Cmd	8480H:bit 8	ON	OFF	C
BV10	MF Input 6 Cmd	8480H:bit 9	ON	OFF	C
BV11	MF Input 7 Cmd	8480H:bit 10	ON	OFF	C
BV12	Set Fault Contact Cmd	0009H:bit 6	ENABLE	OFF	C
BV13	RUN-STOP	0020H:bit 0	RUN	OFF	R
BV14	REV-FWD	0020H:bit 1	REV	FWD	R
BV15	READY	0020H:bit 2	READY	OFF	R
BV16	FAULT	0020H:bit 3	FAULTED	OFF	R

C.6 BACnet Objects Supported

Object ID	Object Name	Modbus Address	Active Text	Inactive Text	PV Access
BV17	Data Set Error	0020H:bit 4	ERROR	OFF	R
BV18	Overcurrent – Gnd Flt	0021H:bit 0	OC-GF	OFF	R
BV19	Main Ckt OverVoltage	0021H:bit 1	OV	OFF	R
BV20	Drive OverLoad	0021H:bit 2	OL2	OFF	R
BV21	Drive OverHeat	0021H:bit 3	OH1-OH2	OFF	R
BV22	Fuse Blown	0021H:bit 5	PUF	OFF	R
BV23	PI Feedback Loss	0021H:bit 6	FBL	OFF	R
BV24	External Fault	0021H:bit 7	EF0-EF	OFF	R
BV25	Hardware Error	0021H:bit 8	CPF	OFF	R
BV26	Mtr Ovrld-OvrTorque	0021H:bit 9	OL1-OL3	OFF	R
BV27	OverSpeed	0021H:bit 10	OS-DEV	OFF	R
BV28	Main Ckt UnderVoltage	0021H:bit 11	UV	OFF	R
BV29	MCU Cntl Pwr Sy Err	0021H:bit 12	UV1-2-3	OFF	R
BV30	Output Phase Loss	0021H:bit 13	LF	OFF	R
BV31	Communication Error	0021H:bit 14	CE	OFF	R
BV32	Operator Disconnect	0021H:bit 15	OPR	OFF	R
BV33	Operating	002CH:bit 0	OPERATING	OFF	R
BV34	Zero Speed	002CH:bit 1	ON	OFF	R
BV35	Frequency Agree	002CH:bit 2	ON	OFF	R
BV36	Desired Freq Agree	002CH:bit 3	ON	OFF	R
BV37	Frequency Detect 1	002CH:bit 4	ON	OFF	R
BV38	Frequency Detect 2	002CH:bit 5	ON	OFF	R
BV39	Drv Startup Complete	002CH:bit 6	ON	OFF	R
BV40	Low Voltage Detect	002CH:bit 7	ON	OFF	R
BV41	Base Block	002CH:bit 8	ON	OFF	R
BV42	Frequency Ref Mode	8785H:bit 8	COM	LOCAL	R
BV43	Run Command Mode	8485H:bit 9	COM	LOCAL	R
BV44	Over Torque Detect	002CH:bit 11	ON	OFF	R
BV45	Frequency Ref Lost	002CH:bit 12	ON	OFF	R
BV46	Retry Error	002CH:bit 13	ON	OFF	R
BV47	Modbus Comms Error	002CH:bit 14	ON	OFF	R
BV48	Modbus Timeout Error	002CH:bit 15	ON	OFF	R
BV49	CRC Error	003DH:bit 0	ON	OFF	R
BV50	Invalid Data Length	003DH:bit 1	ON	OFF	R
BV51	Parity Error	003DH:bit 3	ON	OFF	R
BV52	Overrun Error	003DH:bit 4	ON	OFF	R
BV53	Framing Error	003DH:bit 5	ON	OFF	R
BV54	Timeout Error	003DH:bit 6	ON	OFF	R
BV55 <I>	Parameter Accept	0910H:bit 0	ON	OFF	W
BV56 <I>	Parameter Enter	0900H:bit 0	ON	OFF	W
BV57	Drive Comms Error	002CH:bit 15	ON	OFF	R
BV58	BYP Run Fwd CMD	8400H: bit 0	ON	OFF	C
BV59	BYP Run Rev CMD	8400H: bit 1	ON	OFF	C
BV60	Not Used BV60	–	ON	OFF	R
BV61	BYP Xfer to BYP CMD	8400H: bit 3	ON	OFF	C
BV62	BYP Smok Prg BYP CMD	8400H: bit 4	ON	OFF	C
BV63	BYP Smok Prg DRV CMD	8400H: bit 5	ON	OFF	C
BV64	BYP Mtr OR Sel CMD	8400H: bit 6	ON	OFF	C
BV65	BYP Mtr AND Sel CMD	8400H: bit 7	ON	OFF	C

C.6 BACnet Objects Supported

Object ID	Object Name	Modbus Address	Active Text	Inactive Text	PV Access
BV66	BYP Drive Select CMD	8400H: bit 9	ON	OFF	C
BV67	BYP Auto Select CMD	8400H: bit 10	ON	OFF	C
BV68	Not Used BV68	8400H: bit 11	ON	OFF	C
BV69	BYP BYPASS Sel CMD	8400H: bit 12	BYP	DRV	C
BV70	BYP Fault Reset CMD	8400H: bit 13	ON	OFF	C
BV71	BYP Ext Fault CMD	8400H: bit 14	ON	OFF	C
BV72 <2>	BYP DI-01 Command	8402H: bit 0	ON	OFF	W
BV73 <2>	BYP DI-02 Command	8402H: bit 1	ON	OFF	W
BV74 <2>	BYP DI-03 Command	8402H: bit 2	ON	OFF	W
BV75 <2>	BYP DI-04 Command	8402H: bit 3	ON	OFF	W
BV76 <2>	BYP DI-05 Command	8402H: bit 4	ON	OFF	W
BV77 <2>	BYP DI-06 Command	8402H: bit 5	ON	OFF	W
BV78 <2>	BYP DI-07 Command	8402H: bit 6	ON	OFF	W
BV79 <2>	BYP DI-08 Command	8402H: bit 7	ON	OFF	W
BV80	BYP HAND Mode Status	8784H: bit 0	ON	OFF	R
BV81	BYP OFF Mode Status	8784H: bit 1	ON	OFF	R
BV82	BYP AUTO Mode Status	8784H: bit 2	ON	OFF	R
BV83	BYP DRV Mode Status	8784H: bit 3	ON	OFF	R
BV84	BYP BYPASS Mode Stat	8784H: bit 4	ON	OFF	R
BV85	BYP Smk Prg BYP Stat	8784H: bit 5	ACTIVE	OFF	R
BV86	BYP Smk Prg DRV Stat	8784H: bit 6	ACTIVE	OFF	R
BV87	BYP Safety Status	8784H: bit 7	OPEN	CLOSED	R
BV88	BYP BAS Interlk Stat	8785H: bit 0	OPEN	CLOSED	R
BV89	BYP RUN Status	8785H: bit 1	RUN	OFF	R
BV90	BYP Fault Status	8785H: bit 2	FAULT	OFF	R
BV91	BYP Auto Xfer Status	8785H: bit 3	ACTIVE	OFF	R
BV92	BYP Remote Xfer Stat	8785H: bit 4	ACTIVE	OFF	R
BV93	BYP Energy Save Stat	8785H: bit 5	ACTIVE	OFF	R
BV94	BYP Motor 1 Sel Stat	8785H: bit 6	SELECT	OFF	R
BV95	BYP Motor 2 Sel Stat	8785H: bit 7	SELECT	OFF	R
BV96	BYP Drive Flt Status	8786H: bit 0	FAULT	OFF	R
BV97	BYP Safety Flt Stat	8786H: bit 1	FAULT	OFF	R
BV98	BYP BAS ILock Status	8786H: bit 2	FAULT	OFF	R
BV99	BYP Ext Fault Stat	8786H: bit 3	FAULT	OFF	R
BV100	Not Used BV100	8786H: bit 4	FAULT	OFF	R
BV101	BYP Motor OL Stat	8786H: bit 5	FAULT	OFF	R
BV102	BYP Motor 1 OL Stat	8786H: bit 6	FAULT	OFF	R
BV103	BYP Mtr 2 OL Stat	8786H: bit 7	FAULT	OFF	R
BV104	BYP Input Phase Loss	8787H: bit 0	FAULT	OFF	R
BV105	BYP Drive Comms	8787H: bit 2	FAULT	OFF	R
BV106	BYP Loss Of Load	8787H: bit 5	FAULT	OFF	R
BV107	BYP Option Brd Comms	8787H: bit 3	FAULT	OFF	R

<1> Refer to *Accessing Bypass Parameters and the Enter Command on page 325* for an explanation of how to read and write drive parameters not listed in the analog or binary objects.

<2> Object is disabled when Z3-12 is set to 0 in bypass controller software versions VST800298 and later.

◆ Device Object

The Device Object fully describes the BACnet device to the network. Notable is that the Device Object Instance ID and the Device Object Name are configurable.

C.6 BACnet Objects Supported

The Device Object Instance ID is a unique internetwork-wide numerical value. It is a 22-bit value that can range from 0 to 4,194,303. It is configurable by parameters Z3-08 and Z3-09. Any changes to these parameters will not take effect until the power is cycled to the bypass.

The Device Object Name is a unique internetwork-wide character string. It is a 20-character string. It is writable from the BACnet network. Any new string written will not take effect until the power is cycled to the bypass.

C.7 Accessing Bypass Parameters and the Enter Command

◆ Reading Bypass Parameters

Reading bypass parameters not listed in the analog or digital objects is accomplished using AV29 and AV30 as shown below:

1. In decimal, write the desired Modbus register to AV29.
2. In decimal, read the value at the given register from AV30.

For example, to read the Frequency Reference Upper Limit, read from parameter d2-01.

Parameter d2-01 is located at Modbus register 0289H, which is decimal 649.

Set AV29 to “649”

Read AV30 to get the value.

◆ Writing Bypass Parameters

Writing bypass parameters not listed in the analog or digital objects is accomplished using AV29, AV30, and BV55 or BV56 as shown below:

1. In decimal, write the desired Modbus register to AV29.
2. In decimal, write the value to be written into AV30.
3. At this point the value is written to the drive, but the location is pending. If necessary, write in more values this way, then the drive will accept these settings by one of two methods:

Set BV55 to “ON” to move data to active memory.

Set BV56 to “ON” to move data into active memory and save to non-volatile memory.

For example, to enable the loss of load function, write a value of “1” to parameter Z1-31.

Parameter Z1-31 is located at Modbus register 85E4H, which is decimal 34276.

Set AV29 to “34276”

Set AV30 to “1”

Set BV56 to “ON”.

◆ Enter Command

Enter Commands are only required when using AV29 and AV30 to access bypass parameters. An Enter command is not required when reading or writing to the other BACnet objects.

When writing parameters to the bypass from a controller using BACnet communications, parameter H5-11 determines if an Enter command must be issued to enable these parameters. This section describes the types and functions of the Enter commands.

■ Enter Command Types

The bypass supports two types of Enter commands as shown in *Table C.10*.

Table C.10 Enter Command Types

BACnet Object	Modbus Address	Description
BV55 (Write “ON”)	0910H (Write 0)	Writes data in the RAM only. Parameter changes are lost when the drive or bypass is shut off.
BV56 (Write “ON”)	0900H (Write 0)	Simultaneously writes data into the EEPROM (non-volatile memory) of the drive or bypass and enables the data in RAM. Parameter changes remain after cycling power.

Note: The EEPROM can only be written to 100,000 times, so it is recommended to limit the number of times writing to the EEPROM. The Enter command registers 0900H and 0910H are write-only and if these registers are read, the register address will be invalid. However, BACnet objects BV55 and BV56 can be read without error.

C.8 Communication Errors

C.8 Communication Errors

Errors that may occur when accessing drive parameters using the BACnet objects are shown in *Table C.11*.

Table C.11 MEMOBUS to BACnet Error Conversion

Error Code	Description
03d	BN_ERR_DEVICE_IS_BUSY Writing to a parameter was attempted while the drive was saving parameters to non-volatile memory.
27d	BN_ERR_READ_ACCESS_DENIED Invalid parameter register number used when reading.
37d	BN_ERR_VALUE_OUT_OF_RANGE Value written to the parameter is out of the valid range.
40d	BN_ERR_WRITE_ACCESS_DENIED An invalid parameter register number was used when writing. Writing to a parameter was attempted while the drive was in a mode that disables writing (i.e., writing while the drive was Auto-Tuning). Writing to a parameter was attempted while the DC Bus had an Undervoltage (Uv) fault

C.9 BACnet Protocol Implementation Conformance Statement

Date: 9/19/2011

Vendor Name: Yaskawa America, Inc.

Product Name: VFD Bypass

Product Model Number: UTC00046X

Application Software Version: VST80029x / Firmware Revision: 1.0 / BACnet Protocol Revision: 4

Product Description:

The Yaskawa VFD Bypass is a high performance product specifically designed for commercial building automation applications. The Yaskawa BACnet feature connects the VFD Bypass to a standard BACnet MS/TP network. These products may be fully controlled and monitored over BACnet. All Bypass and drive parameters are available for reading and writing.

BACnet Standardized Device Profile (Annex L):

- BACnet Operator Workstation (B-OWS)
- BACnet Building Controller (B-BC)
- BACnet Advanced Application Controller (B-AAC)
- BACnet Application Specific Controller (B-ASC)
- BACnet Smart Sensor (B-SS)
- BACnet Smart Actuator (B-SA)

List all BACnet Interoperability Building Blocks Supported (Annex K):

- Data Sharing-ReadProperty-B (DS-RP-B)
- Data Sharing-WriteProperty-B (DS-WP-B)
- Device Management-Dynamic Device Binding-B (DM-DDB-B)
- Device Management-Dynamic Object Binding-B (DM-DOB-B)
- Device Management-DeviceCommunicationControl-B (DM-DCC-B)
- Device Management-ReinitializeDevice-B (DM-RD-B)
- Device Management-TimeSynchronization-B (DM-TS-B)

Segmentation Capability:

- Segmented requests supported / Window Size
- Segmented responses supported / Window Size

Standard Object Types Supported:

- Device Object
- Analog Input Object
- Analog Output Object
- Analog Value Object
- Binary Input Object
- Binary Output Object
- Binary Value Object

Data Link Layer Options:

- BACnet IP, (Annex J)
- BACnet IP, (Annex J), Foreign Device
- ISO 8802-3, Ethernet (Clause 7)
- ANSI/ATA 878.1, 2.5 Mb. ARCNET (Clause 8)
- ANSI/ATA 878.1, RS-485 ARCNET (Clause 8), baud rate(s)
- MS/TP master (Clause 9), baud rate(s): 9600, 19200, 38400, 76800
- MS/TP slave (Clause 9), baud rate(s):
- Point-To-Point, EIA 232 (Clause 10), baud rate(s):
- Point-To-Point, modem, (Clause 10), baud rate(s):

C.9 BACnet Protocol Implementation Conformance Statement

LonTalk, (Clause 11), medium:

Other:

Device Address Binding:

Is static device binding supported? (This is currently necessary for two-way communication with MS/TP slaves and certain other devices.) Yes No

Networking Options:

Router, Clause 6 - List all routing configurations, e.g., ARCNET-Ethernet, Ethernet-MS/TP, etc.

Annex H, BACnet Tunneling Router over IP

BACnet/IP Broadcast Management Device (BBMD)

Does the BBMD support registrations by Foreign Devices? Yes No

Character Sets Supported:

Indicating support for multiple character sets does not imply that they can all be supported simultaneously.

ANSI X3.4

IBM/Microsoft

DBCS

ISO 8859-1

ISO 10646 (UCS-2)

ISO 10646 (UCS-4)

JIS C 6226

If this product is a communication gateway, describe the types of non-BACnet equipment/network(s) that the gateway supports:

Not supported

Appendix: D

MEMOBUS/Modbus Communications

D.1	MEMOBUS/MODBUS CONFIGURATION.....	330
D.2	COMMUNICATION SPECIFICATIONS.....	331
D.3	CONNECTING TO A NETWORK.....	332
D.4	MEMOBUS/MODBUS SETUP PARAMETERS.....	334
D.5	BYPASS OPERATIONS BY MEMOBUS/MODBUS.....	336
D.6	COMMUNICATIONS TIMING.....	337
D.7	MESSAGE FORMAT.....	338
D.8	MESSAGE EXAMPLES.....	340
D.9	MEMOBUS/MODBUS DATA TABLE.....	342
D.10	ENTER COMMAND.....	355
D.11	COMMUNICATION ERRORS.....	356

D.1 MEMOBUS/Modbus Configuration

D.1 MEMOBUS/Modbus Configuration

P1000 Bypasses can be controlled from a PLC or other master device via serial communications using the MEMOBUS/Modbus protocol.

MEMOBUS/Modbus communications can be configured using one master (PLC) and up to 31 slaves. The bypass has slave functionality only, and serial communication is normally initiated from the master and responded to by the slaves.

The master performs serial communications with only one slave at a time. The address or node for each slave must be set beforehand so that the master can communicate with the slave at that address. A slave that receives a command from the master will perform the specified function and then send a response back to the master.

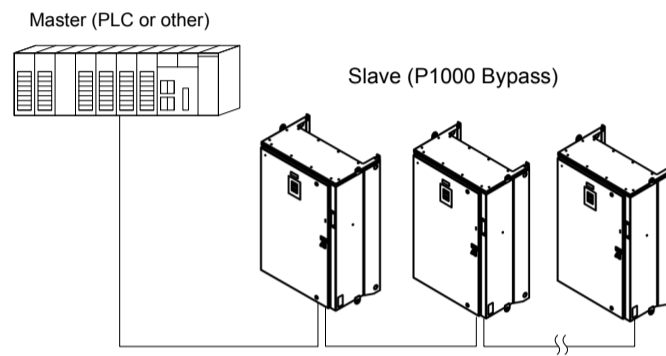

Figure D.1 Connecting Multiple P1000 Bypasses to a PLC

D.2 Communication Specifications

MEMOBUS/Modbus specifications appear in the following table:

Item	Specifications	
Interface	RS-485	
Communications Cycle	Asynchronous (Start-stop synchronization)	
Communication Parameters	Communication Speeds Available	1200, 2400, 4800, 9600, 19200, 38400, 57600, 76800, 115200 bps
	Data length	8-bit (fixed)
	Parity	Select even, odd, or none
	Stop bit	1-bit (fixed)
Protocol	MEMOBUS/Modbus (using RTU mode only)	
Max Number of Slaves	31 bypasses	

D.3 Connecting to a Network

D.3 Connecting to a Network

This section explains how to connect the drive to a MEMOBUS/Modbus network and the network termination required for a connection.

◆ Network Cable Connection

Follow the instructions below to connect the bypass to a MEMOBUS/Modbus network.

1. With the power shut off, connect the communications cable to the bypass controller board A2 and the master. Use terminal TB3 for MEMOBUS/Modbus.

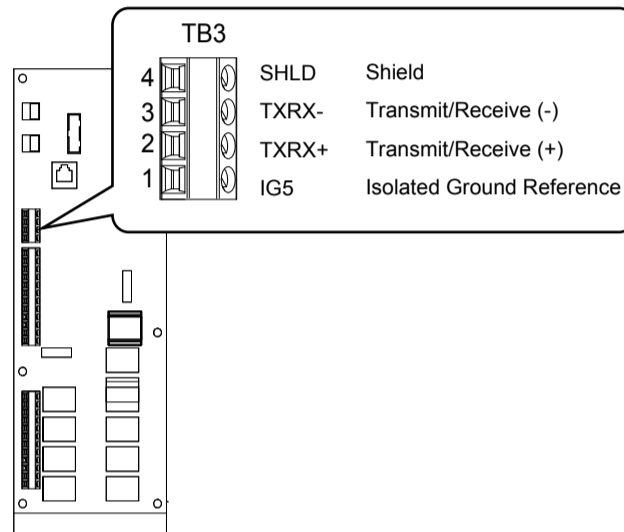

Figure D.2 Serial Communications Cable Connection Terminal (TB3)

Note: Separate the communications cables from the main circuit cables and other wiring and power cables. Use shielded cables for the communications cables, and properly shielded clamps to prevent problems caused by electrical interference.

2. Check or set the termination resistor selection at all slaves. Use the description in **Network Termination** on page 313 for slaves that are P1000 Bypasses.
3. Switch the power on.
4. Set the parameters needed for serial communications (Z3-01 through Z3-07) using the digital operator.
5. Shut the power off and wait until the display on the digital operator goes out completely.
6. Turn the power back on.
7. The bypass is now ready to begin communicating with the master.

◆ **Wiring Diagram for Multiple Connections**

Figure C.3 explains the wiring diagrams for multiple connections using MEMOBUS/Modbus communication.

■ **RS-485 Interface**

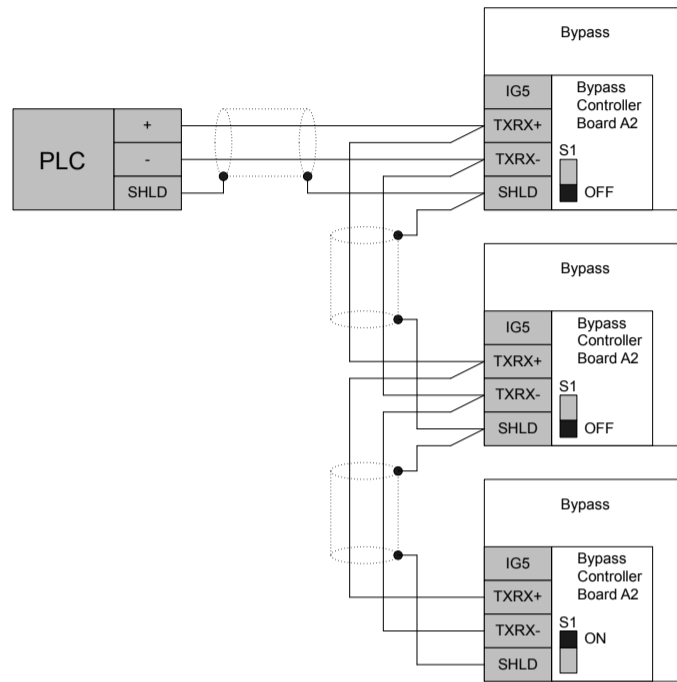

Figure D.3 Connection Diagram for Multiple Connections

Note: Turn on DIP switch S1 on the bypass controller located at the end of the network. If S1 is missing, then an external 120 ohm resistor must be placed across terminals TXRX+ and TXRX-. All other slave devices must have this DIP switch set to the OFF position (or if S1 is missing, no external resistor must be used).

◆ **Network Termination**

The two ends of the MEMOBUS/Modbus network line have to be terminated with a 120 ohm resistor between the TXRX+ and TXRX- signals. The P1000 Bypass has a built in termination resistor that can be enabled or disabled using DIP switch S1. If a bypass is located at the end of a network line, enable the termination resistor by setting DIP switch S1 to the ON position. Disable the termination resistor on all slaves that are not located at the network line end.

Note: Some bypass controllers do not have DIP switch S1. If this is the case, then an external 120 ohm resistor must be placed across the TXRX+ and TXRX- signals if the bypass controller is at the end of a network line.

D.4 MEMOBUS/Modbus Setup Parameters

D.4 MEMOBUS/Modbus Setup Parameters

◆ MEMOBUS/Modbus Serial Communication

Changes to MEMOBUS/Modbus communications settings become effective after restarting the drive.

■ Z3-01: Serial Communications Protocol Select

Selects the bypass serial communications protocol.

No.	Name	Setting Range	Default
Z3-01	Serial Communications Protocol Select	0 to 3	3

Setting 0: Modbus

Setting 1: N2

Setting 2: P1

Setting 3: BACnet

■ Z3-02: Serial Communications Node Select

Selects the bypass serial communications node address.

Note: Each slave must be assigned a unique slave address for serial communications to work properly. Slave addresses do not need to be assigned in sequential order, but no two slaves may share the same address.

No.	Name	Setting Range	Default
Z3-02	Serial Communications Node Select	0 to 127	1

■ Z3-03: Serial Communications Baud Rate Select

Selects the bypass serial communications speed.

Selecting settings 0, 1, or 2 will trigger an oPE29 error when using BACnet communication (Z3-01 = 3) in bypass controller software versions VST800400 and later.

No.	Name	Setting Range	Default
Z3-03	Serial Communications Baud Rate Select	0 to 8	3

Setting 0: 1200 bps

Setting 1: 2400 bps

Setting 2: 4800 bps

Setting 3: 9600 bps

Setting 4: 19200 bps

Setting 5: 38400 bps

Setting 6: 57600 bps

Setting 7: 76800 bps

Setting 8: 115200 bps

■ Z3-04: Serial Communications Parity Select

Selects the bypass serial communications parity. This setting is ignored when BACnet protocol is selected.

No.	Name	Setting Range	Default
Z3-04	Serial Communications Parity Select	0 to 2	0

Setting 0: No Parity

Setting 1: Even Parity

Setting 2: Odd Parity

D.4 MEMOBUS/Modbus Setup Parameters

■ Z3-05: Serial Communications Fault Select

Selects the action to take when a serial communications fault is detected. A serial communications fault is detected when after last communicating, no communications occurs within the time set to Z3-06.

No.	Name	Setting Range	Default
Z3-05	Serial Communications Fault Select	0 to 3	1

Setting 0: Ignore

Setting 1: Alarm Only

Setting 2: Fault with EF0

An EF0 fault will be sent to the drive.

Setting 3: Fault with EF0 and Open Contactors

An EF0 fault will be sent to the drive and the bypass contactor (K3) will be opened.

■ Z3-06: Serial Communications Fault Time Select

Sets the time allowed to elapse since receiving serial communications before triggering a communications fault.

A value of 0.0 means to never time out.

No.	Name	Setting Range	Default
Z3-06	Serial Communications Fault Time Select	0.0 s to 99.9 s	2.0 s

■ Z3-07: Serial Communications Receive to Transmit Wait Time

Sets the time to delay a serial communications response to a serial communications command.

No.	Name	Setting Range	Default
Z3-07	Serial Communications Receive to Transmit Wait Time	0 to 99 ms	5 ms

D.5 Bypass Operations by MEMOBUS/Modbus

D.5 Bypass Operations by MEMOBUS/Modbus

The bypass operations that can be performed by MEMOBUS/Modbus communication depend on parameter settings. This section explains the functions that can be used and related parameter settings.

◆ Observing the Bypass Operation

A controller can perform the following actions with MEMOBUS/Modbus communications at any time regardless of parameter settings:

- Observe bypass and drive status and control terminal status from a controller
- Read and write parameters
- Set and reset faults
- Set multi-function inputs.

Note: Input settings from the input terminals DI-□□ and S□ and from MEMOBUS/Modbus communications are both linked by a logical OR operation.

D.6 Communications Timing

To prevent a communications overrun in the slave bypass, the master should wait a certain time between sending messages to the same bypass. In the same way, the slave bypass must wait before sending response messages to prevent an overrun in the master. This section explains the message timing.

◆ Command Messages from Master to Bypass

The master must wait for a specified time between receiving a response and resending the same type of command to the same bypass drive to prevent overrun and data loss. The minimum wait time depends on the command as shown in *Table D.1*.

Table D.1 Minimum Wait Time for Sending Messages

Command Type	Example	Minimum Wait Time
1	<ul style="list-style-type: none"> Control command (Run, Stop) Set inputs/outputs Read monitors and parameter values 	5 ms $\langle t \rangle$
2	Write parameters	200 ms $\langle t \rangle$
3	Save changes using an Enter command	200 ms to 2 s, depending on the number of parameters that were changed $\langle t \rangle$
4	Enter with storage to drive EEPROM after initialization	5 s

$\langle t \rangle$ If the drive receives command type 1 data during the minimum wait time, it will perform the command and then respond. However, if it receives a command type 2 or 3 during that time, either a communication error will result or the command will be ignored.

Set a timer in the master to check how long it takes for the slave bypass(es) to respond to the master. If no response is received within a certain amount of time, the master should try resending the message.

◆ Response Messages from Bypass to Master

If the bypass receives a command from the master, it will process the data received and wait for the time set in Z3-07 until it responds. Increase Z3-07 if the bypass response causes overrun in the master.

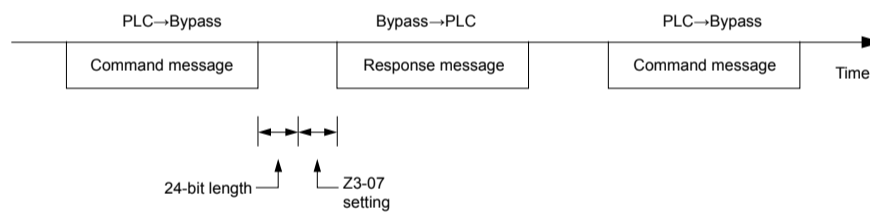

Figure D.4 Minimum Response Wait Time

D.7 Message Format

D.7 Message Format

◆ Message Content

In MEMOBUS/Modbus communications, the master sends commands to the slave, and the slave responds. The message format is configured for both sending and receiving as shown below, and the length of data packets depends on the command (function) content.

SLAVE ADDRESS
FUNCTION CODE
DATA
ERROR CHECK

◆ Slave Address

The slave address in the message defines the node the message is sent to. Use addresses between 0 and FF (hex). If a message with slave address 0 is sent (broadcast), the command from the master will be received by all slaves. The slaves do not provide a response to a broadcast type message.

◆ Function Code

The three types of function codes are shown in the table below.

Function Code	Function Name	Data Length (bytes)			
		Command Message		Response Message	
		Minimum	Maximum	Minimum	Maximum
03H	Read MEMOBUS/Modbus registers	8	8	7	37
08H	Loopback test	8	8	8	8
10H	Write to multiple MEMOBUS/Modbus registers	11	41	8	8

◆ Data

Configure consecutive data by combining the MEMOBUS/Modbus register address (test code in case of a loopback test) and the data the register contains. The data length changes depending on the command details.

A bypass MEMOBUS/Modbus register always has a data length of two bytes. Data written into drive registers must also always have a length of two bytes. Register data read out from the drive will always consist of two bytes.

◆ Error Check

The bypass uses a CRC-16 (cyclic redundancy check, checksum method) for checking data validity. Use the procedure described below when calculating the CRC-16 checksum for command data or when verifying response data.

■ Command Data

When the drive receives data, it calculates the CRC-16 checksum from the data and compares it to the CRC-16 value received within the message. Both must match before a command is processed.

An initial value of FFFFH (i.e., all 16 bits equal 1) must be used for CRC-16 calculations in the MEMOBUS/Modbus protocol.

Calculate the CRC-16 checksum using the following steps:

1. The starting value is FFFFH.
2. Perform an XOR operation of this value and the slave address.
3. Right shift the result.
4. When the overflow bit of the shift operation becomes 1, perform an XOR operation of the result from step 3 above and the fix value A001H.
5. Repeat steps 3 and 4 until eight shift operations have been performed.
6. After eight shift operations, perform an XOR operation with the result and the next data in the message (function code, register address, data). Continue with steps 3 to 5 until the last data has been processed.
7. The result of the last shift or XOR operation is the checksum.

The example in **Table D.2** shows the CRC-16 calculation of the slave address 02H and the function code 03H, yielding the result D140H.

Note: This example does not show the calculation for a complete MEMOBUS/Modbus command. Normally data would follow in the calculation.

Table D.2 CRC-16 Checksum Calculation Example

Description	Calculation	Overflow	Description	Calculation	Overflow
Initial Value (FFFFH)	1111 1111 1111 1111		Function Code 03H	0000 0000 0000 0011	
Address 02H	0000 0000 0000 0010		XOR w result	1000 0001 0011 1101	
XOR w initial value	1111 1111 1111 1101		Shift 1	0100 0000 1001 1110	1
Shift 1	0111 1111 1111 1110	1	XOR w A001H	1010 0000 0000 0001	
XOR w A001H	1010 0000 0000 0001		XOR result	1110 0000 1001 1111	
XOR result	1101 1111 1111 1111		Shift 2	0111 0000 0100 1111	1
Shift 2	0110 1111 1111 1111	1	XOR w A001H	1010 0000 0000 0001	
XOR w A001H	1010 0000 0000 0001		XOR result	1101 0000 0100 1110	
XOR result	1100 1111 1111 1110		Shift 3	0110 1000 0010 0111	0
Shift 3	0110 0111 1111 1111	0	Shift 4	0011 0100 0001 0011	1
Shift 4	0011 0011 1111 1111	1	XOR w A001H	1010 0000 0000 0001	
XOR w A001H	1010 0000 0000 0001		XOR result	1001 0100 0001 0010	
XOR result	1001 0011 1111 1110		Shift 5	0100 1010 0000 1001	0
Shift 5	0100 1001 1111 1111	0	Shift 6	0010 0101 0000 0100	1
Shift 6	0010 0100 1111 1111	1	XOR w A001H	1010 0000 0000 0001	
XOR w A001H	1010 0000 0000 0001		XOR result	1000 0101 0000 0101	
XOR result	1000 0100 1111 1110		Shift 7	0100 0010 1000 0010	1
Shift 7	0100 0010 0111 1111	0	XOR w A001H	1010 0000 0000 0001	
Shift 8	0010 0001 0011 1111	1	XOR result	1110 0010 1000 0011	
XOR w A001H	1010 0000 0000 0001		Shift 8	0111 0001 0100 0001	1
XOR result	1000 0001 0011 1110		XOR w A001H	1010 0000 0000 0001	
Perform operations with next data (function code)			XOR result	1101 0001 0100 0000	
			XOR result	1101 0001 0100 0000	
			CRC-16	D 1 4 0 (Lower) (Upper)	
			Continue from here with next data.		

Response Data

Perform a CRC-16 calculation on the response message data as described above as a validation check. The result should match the CRC-16 checksum received within the response message.

D.8 Message Examples

D.8 Message Examples

Below are some examples of command and response messages.

◆ Reading Drive MEMOBUS/Modbus Register Contents

Using the function code 03H (Read), a maximum of 16 MEMOBUS/Modbus registers can be read out at a time.

The following table shows message examples when reading status signals, error details, data link status, and frequency references from the slave 2 drive.

Command Message			Response Message (normal)			Response Message (fault)		
Slave Address		02H	Slave Address		02H	Slave Address		02H
Function Code		03H	Function Code		03H	Function Code		83H
Starting No.	Upper	00H	Data Quantity		08H	Error Code		03H
	Lower	20H	1st storage register	Upper	00H	CRC-16	Upper	F1H
Data Quantity	Upper	00H		Lower	65H		Lower	31H
		Lower	04H	Next storage register	Upper	00H		
CRC-16		Upper	45H		Lower	00H		
		Lower	F0H	Next storage register	Upper	00H		
					Lower	00H		
				Next storage register	Upper	01H		
					Lower	F4H		
				CRC-16	Upper	AFH		
					Lower	82H		

◆ Loopback Test

Function code 08H performs a loopback test that returns a response message with exactly the same content as the command message. The response message can be used to check communications between the master and slave. User-defined test code and data values can also be set.

The following table shows a message example when performing a loopback test with the slave 1 drive.

Command Message			Response Message		
Slave Address		01H	Slave Address		01H
Function Code		08H	Function Code		08H
Test Code	Upper	00H	Test Code	Upper	00H
	Lower	00H		Lower	00H
Data	Upper	A5H	Data	Upper	A5H
	Lower	37H		Lower	37H
CRC-16	Upper	DAH	CRC-16	Upper	DAH
	Lower	8DH		Lower	8DH

◆ Writing to Multiple Registers

Function code 10H allows the user to write multiple MEMOBUS/Modbus registers with one message. This process works similar to reading registers, in that the address of the first register to be written and the data quantity are set in the command message. The data to be written must be consecutive so that the register addresses are in order, starting from the specified address in the command message. The data order must be high byte then lower byte.

The following table shows an example of a message where a forward operation has been set with a frequency reference of 60.0 Hz for the slave 1 drive.

If parameter values are changed using the Write command, an Enter command is necessary to save the data. *Refer to Enter Command on page 325* for detailed descriptions.

Command Message			Response Message (normal)			Response Message (fault)		
Slave Address		01H	Slave Address		01H	Slave Address		01H
Function Code		10H	Function Code		10H	Function Code		90H
Starting No.	Upper	00H	Starting No.	Upper	00H	Error Code		02H
	Lower	01H		Lower	01H			
Data Quantity	Upper	00H	Data Quantity	Upper	00H	CRC-16	Upper	CDH
	Lower	02H		Lower	02H		Lower	C1H
Number of Bytes		04H	CRC-16	Upper	10H			
Starting Data	Upper	00H		Lower	08H			
	Next Data	Upper	02H					
CRC-16		Upper	63H					
	Lower	39H						

Note: Double the number of the data quantity for the number of bytes in the command message.

D.9 MEMOBUS/Modbus Data Table

D.9 MEMOBUS/Modbus Data Table

The tables below list all MEMOBUS/Modbus data.

The MEMOBUS register hex addresses for parameters are listed beginning on page 257.

◆ Command Data

It is possible to both read and write command data.

Note: Bits that are not used should be set to 0. Refrain from writing to reserved registers.

Register No.	Contents	
0000H	Reserved	
0001H	Operation Commands and Multi-function Inputs	
	bit 0	Reserved
	bit 1	Reserved
	bit 2	External Fault (EF0)
	bit 3	Fault Reset
	bit 4	Reserved
	bit 5	Reserved
	bit 6	Multi-Function Input 3
	bit 7	Multi-Function Input 4
	bit 8	Multi-Function Input 5
	bit 9	Multi-Function Input 6
	bit A	Multi-Function Input 7
	bit B to F	Reserved
0002H	Reserved	Reserved
0003H	V/f Gain	
0004H, 0005H	Reserved	
0006H	PI Target, 0.01% units, signed	
0007H	Analog Output Terminal FM Setting (10 V / 4000 H)	
0008H	Analog Output Terminal AM Setting (10 V / 4000 H)	
0009H	Settings for Multi-Function Digital Outputs	
	bit 0	Multi-Function Contact Output 1 (terminal M1-M2)
	bit 1	Multi-Function Contact Output 2 (terminal M3-M4)
	bit 2	Multi-Function Contact Output 3 (terminal M5-M6)
	bit 3 to 5	Reserved
	bit 6	Enables the function in bit 7
	bit 7	Fault Contact Output (terminal MA/MB-MC)
bit 8 to F	Reserved	
000AH to 000CH	Reserved	
000DH	PI2 Setpoint	
000EH	Reserved	
000FH	Control Selection Setting	
	bit 0	Reserved
	bit 1	PI Setpoint Input
	bit 2, bit 3	Reserved
	bit 4	PI2 Target Input (enables the setting from MEMOBUS/Modbus)
	bit 5 to B	Reserved
	bit C	Enable Terminal S5 Input for Broadcast Data
	bit D	Enable Terminal S6 Input for Broadcast Data
	bit E	Enable Terminal S7 Input for Broadcast Data
bit F	Reserved	

D.9 MEMOBUS/Modbus Data Table

Register No.	Contents
0010H to 001FH	Reserved

◆ Monitor Data

Monitor data can be read only.

Register No.	Contents	
0020H	Drive Status 1	
	bit 0	During Run
	bit 1	During Reverse
	bit 2	Drive Ready
	bit 3	Fault
	bit 4	Data Setting Error
	bit 5	Multi-Function Contact Output 1 (terminal M1-M2)
	bit 6	Multi-Function Contact Output 2 (terminal M3-M4)
	bit 7	Multi-Function Contact Output 3 (terminal M5-M6)
	bit 8 to D	Reserved
	bit E	ComRef status
bit F	ComCtrl status	
0021H	Fault Contents 1	
	bit 0	Overcurrent (oC), Ground fault (GF)
	bit 1	Overvoltage (ov)
	bit 2	Drive Overload (oL2)
	bit 3	Overheat 1 (oH1), Drive Overheat Warning (oH2)
	bit 4, bit 5	Reserved
	bit 6	PI Feedback Loss (FbL / FbH)
	bit 7	EF to EF7: External Fault
	bit 8	CPF□□: Hardware Fault (includes oFx)
	bit 9	Motor Overload (oL1), Overtorque Detection 1 (oL3), Undertorque Detection 1 (UL3)
	bit A	Reserved
	bit B	Main Circuit Undervoltage (Uv)
	bit C	Undervoltage (Uv1), Control Power Supply Undervoltage (Uv2), Soft Charge Circuit Fault (Uv3)
	bit D	Output Phase Loss (LF), Input Phase Loss (PF)
	bit E	MEMOBUS/Modbus Communication Error (CE), Option Communication Error (bUS)
bit F	Operator Connection Fault (oPr)	
0022H	Data Link Status	
	bit 0	Writing data or switching motors
	bit 1	Reserved
	bit 2	
	bit 3	Upper or lower limit error
	bit 4	Data conformity error
	bit 5	Writing to EEPROM
bit 6 to F	Reserved	
0023H	Frequency Reference </>	
0024H	Output Frequency </>	
0025H	Output Voltage Reference, 0.1 V units (units are determined by parameter H5-10)	
0026H	Output Current, 0.1 A units	
0027H	Output Power	
0028H	Reserved	

D.9 MEMOBUS/Modbus Data Table

Register No.	Contents	
0029H	Fault Contents 2	
	bit 0	Reserved
	bit 1	Ground Fault (GF)
	bit 2	Input Phase Loss (PF)
	bit 3	Output Phase Loss (LF)
	bit 4, bit 5	Reserved
	bit 6	Motor Overheat 2 (PTC input) (oH4)
	bit 7 to F	Reserved
002AH	Alarm Contents 1	
	bit 0, 1	Reserved
	bit 2	Run Command Input Error (EF)
	bit 3	Drive Baseblock (bb)
	bit 4	Overtorque Detection 1 (oL3)
	bit 5	Heatsink Overheat (oH)
	bit 6	Overvoltage (ov)
	bit 7	Undervoltage (Uv)
	bit 8	Cooling Fan Error (FAn)
	bit 9	MEMOBUS/Modbus Communication Error (CE)
	bit A	Option Communication Error (bUS)
	bit B	Undertorque Detection 1 (UL3)
	bit C	Motor Overheat (oH3)
	bit D	PI Feedback Loss (FbL, FbH)
	bit E	Reserved
bit F	Serial Communication Transmission Error (CALL)	
002BH	Input Terminal Status	
	bit 0	Terminal S1 Closed
	bit 1	Terminal S2 Closed
	bit 2	Terminal S3 Closed
	bit 3	Terminal S4 Closed
	bit 4	Terminal S5 Closed
	bit 5	Terminal S6 Closed
	bit 6	Terminal S7 Closed
bit 7 to F	Reserved	
002CH	Drive Status 2	
	bit 0	During Run
	bit 1	Zero Speed
	bit 2	Speed Agree
	bit 3	User Speed Agree
	bit 4	Frequency Detection 1
	bit 5	Frequency Detection 2
	bit 6	Drive Ready
	bit 7	During Undervoltage
	bit 8	During Baseblock
	bit 9	Frequency Reference from Operator Keypad
	bit A	Run Command from Operator Keypad
	bit B	Over/Undertorque 1
	bit C	Frequency Reference Loss
	bit D	During Fault Restart
bit E	Fault	
bit F	Communication Timeout	

D.9 MEMOBUS/Modbus Data Table

Register No.	Contents	
002DH	Output Terminal Status	
	bit 0	Multi-Function Contact Output 1 (terminal MD-ME-MF)
	bit 1	Multi-Function Contact Output 2 (terminal M1-M2)
	bit 2	Multi-Function Contact Output 3 (terminal M3-M4)
	bit 3 to 6	Reserved
	bit 7	Fault Contact Output (terminal MA/MB-MC)
	bit 8 to F	Reserved
002EH	Reserved	
002FH	Frequency Reference Bias (from Up/Down 2 Function), 0.1% units	
0030H	Reserved	
0031H	DC Bus Voltage, 1 Vdc units	
0032H, 0033H	Reserved	
0034H	Product Code 1 [ASCII], Product Type	
0035H	Product Code 2 [ASCII], Region Code	
0036H, 0037H	Reserved	
0038H	PI Feedback, 0.1% units, unsigned, 100% / max. output frequency	
0039H	PI Input, 0.1% units, signed, 100% / max. output frequency	
003AH	PI Output, 0.1% units, signed, 100% / max. output frequency	
003BH, 003CH	Reserved	
003DH	Communications Error Contents <2>	
	bit 0	CRC Error
	bit 1	Data Length Error
	bit 2	Reserved
	bit 3	Parity Error
	bit 4	Overflow Error
	bit 5	Framing Error
	bit 6	Timeout
bit 7 to F	Reserved	
003EH	Output Frequency	r/min <4>
003FH		0.01% units
0040H to 004AH	Used for various monitors U1-□□. Refer to U: Monitors on page 280 for parameter details.	
004BH	Drive status (U1-12)	
	bit 0	During Run
	bit 1	During Zero Speed
	bit 2	During Reverse Run
	bit 3	During Fault Reset Signal Input
	bit 4	During Speed Agree
	bit 5	Drive Ready
	bit 6	Alarm
	bit 7	Fault
	bit 8	During Operation Error (oPE□□)
	bit 9	During Momentary Power Loss
	bit A, bit B	Reserved
	bit E	ComRef status, NetRef status
bit F	ComCtrl status, NetCtrl status	
004CH to 007EH	Used for various monitors U1-□□, U4-□□, U5-□□ and U6-□□. Refer to U: Monitors on page 280 for parameter details.	
007FH	Alarm Code, Refer to Alarm Register Contents on page 354 for alarm codes.	
0080H to 0097H	Used for monitors U2-□□, U3-□□. Refer to U: Monitors on page 280 for parameter details and Refer to Fault Trace Contents on page 352 for register value descriptions.	
0098H	High Word of Accumulated Operation Time Monitor, 10 h units (U4-01)	

D.9 MEMOBUS/Modbus Data Table

Register No.	Contents	
0099H	Low Word of Accumulated Operation Time Monitor, 1 h units (U4-01)	
009AH	High Word of Cooling Fan Operation Time Monitor (U4-03)	
009BH	Low Word of Cooling Fan Operation Time Monitor (U4-03)	
009CH to 00AAH	Reserved	
00ABH	Drive Rated Current <2>	
00ACH	Motor Speed (U1-05)	r/min units <4>
00ADH	Note: Not available in P1000.	0.01% units
00AEH to 00B4H	Reserved	
00B5H	Frequency Reference After	r/min units <4>
00B6H	Soft-starter (U1-16)	0.01% units
00B7H	Frequency Reference	r/min <4>
00B8H		0.01% units
00B9H to 00BEH	Reserved	
00BFH	Lists the last two digits of operation error code oPE□□.	
00C0H	Fault Contents 3	
	bit 1	Undervoltage (Uv1)
	bit 2	Control Power Supply Undervoltage (Uv2)
	bit 3	Soft Charge Circuit Fault (Uv3)
	bit 4	Reserved
	bit 5	Ground Fault (GF)
	bit 6	Overcurrent (oC)
	bit 7	Overvoltage (ov)
	bit 8	Heatsink Overheat (oH)
	bit 9	Heatsink Overheat (oH1)
	bit A	Motor Overload (oL1)
	bit B	Drive Overload (oL2)
	bit C	Overtorque Detection 1 (oL3)
	bit D to F	Reserved
00C1H	Fault Contents 4	
	bit 0	External Fault at input terminal S3 (EF3)
	bit 1	External Fault at input terminal S4 (EF4)
	bit 2	External Fault at input terminal S5 (EF5)
	bit 3	External Fault at input terminal S6 (EF6)
	bit 4	External Fault at input terminal S7 (EF7)
	bit 5	Reserved
	bit 6	Cooling Fan Error (FAn)
	bit 7 to 9	Reserved
	bit A	Input Phase Loss (PF)
	bit B	Output Phase Loss (LF)
	bit C	Motor Overheat (PTC input) (oH3)
	bit D	Digital Operator Connection Fault (oPr)
	bit E	EEPROM Write Error (Err)
bit F	Motor Overheat Fault (PTC input) (oH4)	

D.9 MEMOBUS/Modbus Data Table

Register No.	Contents	
00C2H	Fault Contents 5	
	bit 0	MEMOBUS/Modbus Communication Error (CE)
	bit 1	Option Communication Error (bUS)
	bit 2 to 5	Reserved
	bit 6	Option External Fault (EF0)
	bit 7	PI Feedback Loss (FbL)
	bit 8	Undertorque Detection 1 (UL3)
	bit 9	Reserved
	bit A	High Slip Braking Overload (oL7)
	bit B to E	Reserved
	bit F	Hardware Fault (includes oFx)
00C3H	Fault Contents 6	
	bit 0 to 4	Reserved
	bit 5	Current Imbalance (LF2)
	bit 6	Pullout Detection (STo)
	bit 7 to 9	Reserved
	bit A	Too Many Speed Search Restarts (SEr)
bit B to F	Reserved	
00C4H	Fault Contents 7	
	bit 0	PI Feedback Loss (FbH)
	bit 1	External Fault 1, input terminal S1 (EF1)
	bit 2	External Fault 2, input terminal S2 (EF2)
	bit 3, bit 4	Reserved
	bit 5	Current Offset Fault (CoF)
	bit 6 to B	Reserved
	bit C	Output Voltage Detection Fault (voF)
bit D to F	Reserved	
00C5H	Fault Contents 8	
	bit 0	Reserved
	bit 1	Node Setup Fault (nSE)
	bit 2 to 5	Reserved
	bit 9	Motor Underload Protection (UL6)
bit A to F	Reserved	
00C6H, 00C7H	Reserved	

D.9 MEMOBUS/Modbus Data Table

Register No.	Contents	
00C8H	Alarm Contents 2	
	bit 0	Undervoltage (Uv)
	bit 1	Overvoltage (ov)
	bit 2	Heatsink Overheat (oH)
	bit 3	Drive Overheat (oH2)
	bit 4	Overtorque 1 (oL3)
	bit 5	Reserved
	bit 6	Run Commands Input Error (EF)
	bit 7	Drive Baseblock (bb)
	bit 8	External Fault 3, input terminal S3 (EF3)
	bit 9	External Fault 4, input terminal S4 (EF4)
	bit A	External Fault 5, input terminal S5 (EF5)
	bit B	External Fault 6, input terminal S6 (EF6)
	bit C	External Fault 7, input terminal S7 (EF7)
	bit D	Reserved
	bit E	Cooling Fan Error (FAn)
bit F	Reserved	
00C9H	Alarm Contents 3	
	bit 0, bit 1	Reserved
	bit 2	Digital Operator Connection Fault (oPr)
	bit 3	MEMOBUS/Modbus Communication Error (CE)
	bit 4	Option Communication Error (bUS)
	bit 5	Reserved
	bit 6	Motor Overload (oL1)
	bit 7	Drive Overload (oL2)
	bit 8	Reserved
	bit 9	Option Card External fault (EF0)
	bit A, bit B	Reserved
	bit C	Serial Communication Transmission Error (CALL)
	bit D	Undertorque Detection 1 (UL3)
	bit E	Reserved
	bit F	MEMOBUS/Modbus Test Mode Fault (SE)
	00CAH	Alarm Contents 4
bit 0		Reserved
bit 1		Motor Overheat 1 (PTC Input) (oH3)
bit 2 to 5		Reserved
bit 6		PI Feedback Loss (FbL)
bit 7		PI Feedback Loss (FbH)
bit 9		Drive Disabled (dnE)
bit A to F		Reserved
00CBH	Alarm Contents 5	
	bit 0 to 2	Reserved
	bit 3	High Current Alarm (HCA)
	bit 4	Cooling Fan Maintenance Time (LT-1)
	bit 5	Soft Charge Bypass Relay Maintenance Time (LT-2)
	bit 6, 7	Reserved
	bit 8	External Fault 1 (input terminal S1) (EF1)
	bit 9	External Fault 2 (input terminal S2) (EF2)
	bit A to F	Reserved

D.9 MEMOBUS/Modbus Data Table

Register No.	Contents	
00CCH	Alarm Contents 6	
	bit 0	Output Voltage Detection Fault (VoF)
	bit 1	Reserved
	bit 2	Capacitor Maintenance Time (LT-3)
	bit 3 to C	Reserved
	bit D	Motor Underload Protection (UL6)
	bit E	Waiting for Run (WrUn)
00CDH	Reserved	
00CEH	Alarm Contents 7	
	bit 2	Time Not Set (TIM)
	bit 3	Operator Battery Low (bAT)
	bit 4	Time Data Error (TdE)
	bit 5	External Fan Fault (Fn1)
	bit 6	Emergency Override Forward Run (EoF)
00CFH	Reserved	
00D0H	CPF Contents 1	
	bit 0, 1	Reserved
	bit 2	A/D Conversion Error (CPF02)
	bit 3	PWM Data Fault (CPF03)
	bit 4, 5	Reserved
	bit 6	EEPROM Memory Data Error (CPF06)
	bit 7	Terminal Board Connection Error (CPF07)
	bit 8	EEPROM Serial Communications Fault (CPF08)
00D1H	Reserved	
00D1H	CPF Contents 2	
	bit 0 to 3	Reserved
	bit 4	Hardware fault at power up (CPF20)
	bit 5	Hardware fault at communication start up (CPF21)
	bit 6	A/D Conversion Fault (CPF22)
	bit 7	PWM Feedback Fault (CPF23)
	bit 8	Drive Unit Signal Fault (CPF24)
00D2H	Reserved	
00D3H to 00D7H	oFA0x Contents (CN5)	
00D8H	oFA0x Contents (CN5)	
	bit 0	Option Compatibility Error (oFA00)
	bit 1	Option not properly connected (oFA01)
	bit 2 to 4	Reserved
	bit 5	A/D Conversion Error (oFA05)
	bit 6	Option Response Error (oFA06)
00D9H	Reserved	

D.9 MEMOBUS/Modbus Data Table

Register No.	Contents	
00D9H	oFA1x Contents (CN5)	
	bit 0	Option RAM Fault (oFA10)
	bit 1	Option Operation Mode Fault (SLMoD) (oFA11)
	bit 2	Drive Receive CRC Error (oFA12)
	bit 3	Drive Receive Frame Error (oFA13)
	bit 4	Drive Receive Abort Error (oFA14)
	bit 5	Option Receive CRC Error (oFA15)
	bit 6	Option Receive Frame Error (oFA16)
	bit 7	Option Receive Abort Error (oFA17)
bit 8 to F	Reserved	
00DAH	Reserved	
00DBH	oFA3x Contents (CN5)	
	bit 0	Comm. ID Error (oFA30)
	bit 1	Model Code Error (oFA31)
	bit 2	Sumcheck Error (oFA32)
	bit 3	Comm. option timeout waiting for response (oFA33)
	bit 4	MEMOBUS Timeout (oFA34)
	bit 5	Drive timeout waiting for response (oFA35)
	bit 6	CI Check Error (oFA36)
	bit 7	Drive timeout waiting for response (oFA37)
	bit 8	Control Command Selection Error (oFA38)
	bit 9	Drive timeout waiting for response (oFA39)
	bit A	Control Response Selection 1 Error (oFA40)
	bit B	Drive timeout waiting for response (oFA41)
	bit C	Control Response Selection 2 Error (oFA42)
	bit D	Control Response Selection Error (oFA43)
bit E, bit F	Reserved	
00DCH to 00E9H	Reserved	
00EAH	Fault Contents 9	
	bit 0	Time Not Set (TIM)
	bit 1	Oper Battery Low (bAT)
	bit 2	Time Data Err (TdE)
	bit 3	Time Interval Error (TIE)
	bit 4, bit 5	Reserved
	bit 6	External Fan Fault (Fn1)
bit 7 to F	Reserved	
00EBH to 00FFH	Reserved	
0100H to 2FFFH	Reserved	
3000H to 3003H	Used for Various Monitors U5-□□. <i>Refer to U: Monitors on page 280</i> for details.	
3004H to 3007H	Reserved	
3008H to 3028H	Used for Various Monitors U2-□□, U3-□□, U5-□□. <i>Refer to U: Monitors on page 280</i> for details.	
3029H to 302EH	Reserved	
302FH to 83FFH	Reserved	

D.9 MEMOBUS/Modbus Data Table

Register No.	Contents	
8400H	BYP Command	<p>Bypass Command. Logically OR'd with the physical inputs</p> <p>XXXXXXXXXXXXXXXXXXXX</p> <ul style="list-style-type: none"> X Run X Run Rev X Not Used X Transfer to Bypass X Smoke Purge Bypass X Smoke Purge Drive X Motor OR Select X Motor AND Select X Not Used X HAND Select X AUTO Select X DRIVE Select X BYPASS Select X Fault Reset X External Fault (EFB) X Not Used
8401H	BYP Freq Ref	Bypass Frequency Reference. This value is sent to the drive if selected by Bypass parameter Z1-07. The units are determined by drive parameter o1-03.
8402H <S>	BYP DI-□□ Command	<p>Bypass Digital Input Command. These bits are logically OR'd with the physical inputs</p> <p>XXXXXXXXXXXXXXXXXXXX</p> <ul style="list-style-type: none"> X DI-1 (0/1 for Off/On) X DI-2 X DI-3 X DI-4 X DI-5 X DI-6 X DI-7 X DI-8 XXXXXXXXXXXX Not Used
8403H	BYP DO-□□ Command	<p>Bypass Digital Output Command. These bits allow the digital outputs to be set over a network if the corresponding digital output function is unused.</p> <p>XXXXXXXXXXXXXXXXXXXX</p> <ul style="list-style-type: none"> X Not Used (0/1 for Off/On) X Not Used X Not Used X Not Used X Not Used X Not Used X DO-7 X DO-8 X DO-9 X DO-10 XXXXXXX Not Used
8404H	Time Set HHMM	Time Set Hours and Minutes. Format is HHMM where HH is hours from 00 to 23 and MM is minutes from 00 to 59. When new HHMM is set to RTC, the seconds will be set to a value of 0.
8405H	Date Set Year	Date Set Year. Format is YYYY where YYYY is the four digit year from 2000 to 2099.
8406H	Date Set MMDD	Date Set Month and Day. Format is MMDD where MM is month from 01 to 12 and DD is day from 01 to 31.
8407H	Set RTC	The date and time values in registers 8404H to 8406H are written to the real time clock (RTC) in the HOA operator connected to the bypass. 0: Do not write values to RTC 1: Write values to RTC
8408H to 843FH	Reserved	

D.9 MEMOBUS/Modbus Data Table

Register No.	Contents	
8440H	Time HHMM	Time Hours and Minutes. Reads current time. Format is HHMM where HH is hours from 00 to 23 and MM is minutes from 00 to 59. Reads 0x0000 when no RTC option
8441H	Date Year	Date Year. Reads current date. Format is YYYY where YYYY is the year from 0000 to 9999. Reads 0x0000 when there is no RTC option.
8442H	Date Mo Day MMDD	Date Month and Day. Reads current date. Format is MMDD where MM is month from 01 to 12 and DD is day from 01 to 31. Reads 0x0000 when there is no RTC option
8443H to 84FFH	Reserved	
8490H	Product Type Code	
8491H	Product Type Code	
8500H to 87FFH	BYP Parameters and Monitors	Z1-□□, Z2-□□, Z3-□□, Z4-□□, UB-□□. Refer to <i>Parameter List on page 255</i> for Modbus addresses.
8800H to FFFFH	Reserved	

- <1> Parameter o1-03, Digital Operator Display Selection, determines the units.
- <2> The number of decimal places in the parameter value depends on the drive model. This value has two decimal places (0.01 A) if the drive is set for a maximum applicable motor capacity up to and including 11 kW, and one decimal place (0.1 A) if the maximum applicable motor capacity is higher than 11 kW. Refer to *Power Ratings on page 244*.
- <4> Set the number of motor poles to parameter E2-04 or E5-05 depending on the motor being used.
- <5> Disabled when Z3-12 is set to 0 in bypass controller software versions VST800298 and later.

◆ Broadcast Messages

Data can be written from the master to all slave devices at the same time.

The slave address in a broadcast command message must be set to 00H. All slaves will receive the message, but will not respond.

Register No.	Contents	
0001H	Digital Input Command	
	bit 0	Forward Run (0: Stop 1: Run)
	bit 1	Direction Command (0: Forward, 1: Reverse)
	bit 2, bit 3	Reserved
	bit 4	External Fault
	bit 5	Fault Reset
	bit 6 to B	Reserved
	bit C	Multi-Function Digital Input S5
	bit D	Multi-Function Digital Input S6
	bit E	Multi-Function Digital Input S7
bit F	Reserved	
0002H	Frequency Reference	30000/100%

◆ Fault Trace Contents

The table below shows the drive fault codes that can be read out by MEMOBUS/Modbus commands from the U2-□□ monitor parameters.

Table D.3 Fault Trace / History Register Contents

Fault Code	Fault Name	Fault Code	Fault Name
0002H	Undervoltage (Uv1)	000CH	Drive Overload (oL2)
0003H	Control Power Supply Undervoltage (Uv2)	000DH	Overtorque Detection 1 (oL3)
0004H	Soft Charge Circuit Fault (Uv3)	0010H	Braking Resistor Overheat (rH)
0006H	Ground Fault (GF)	0011H	External Fault at Input Terminal S3 (EF3)
0007H	Overcurrent (oC)	0012H	External Fault at Input Terminal S4 (EF4)
0008H	Overvoltage (ov)	0013H	External Fault at Input Terminal S5 (EF5)
0009H	Heatsink Overheat (oH)	0014H	External Fault at Input Terminal S6 (EF6)
000AH	Heatsink Overheat (oH1)	0015H	External Fault at Input Terminal S7 (EF7)
000BH	Motor Overload (oL1)	001BH	Input Phase Loss (PF)

D.9 MEMOBUS/Modbus Data Table

Fault Code	Fault Name	Fault Code	Fault Name
001CH	Output Phase Loss (LF)	009EH	ASIC On-delay Error (CPF29)
001DH	Motor Overheat (PTC input) (oH3)	009FH	ASIC BBON Error (CPF30)
001EH	Digital Operator Connection (oPr)	00A0H	ASIC Code Error (CPF31)
001FH	EEPROM Write Error (Err)	00A1H	ASIC Start-up Error (CPF32)
0020H	Motor Overheat (PTC input) (oH4)	00A2H	Watch-dog Error (CPF33)
0021H	MEMOBUS/Modbus Communication Error (CE)	00A3H	ASIC Power/Clock Error (CPF34)
0022H	Option Communication Error (bUS)	00A4H	External A/D Converter Error (CPF35)
0027H	Option External Fault (EF0)	00A9H	Control Circuit Error (CPF40)
0028H	PI Feedback Loss (FbL)	00AAH	Control Circuit Error (CPF41)
0029H	Undertorque Detection 1 (UL3)	00ABH	Control Circuit Error (CPF42)
002BH	High Slip Braking Overload (oL7)	00ACH	Control Circuit Error (CPF43)
0030H	Hardware Fault (including oFx)	00ADH	Control Circuit Error (CPF44)
0036H	Output Current Imbalance (LF2)	00AEH	Control Circuit Error (CPF45)
0037H	Pullout Detection (Sto)	0101H	Option Compatibility Error (oFA00)
003BH	Too Many Speed Search Restarts (SEr)	0102H	Option Not Properly Connected (oFA01)
0041H	PI Feedback Loss (FbH)	0106H	A/D Conversion Error (oFA05)
0042H	External Fault 1, Input Terminal S1 (EF1)	0107H	Option Response Error (oFA06)
0043H	External Fault 2, Input Terminal S2 (EF2)	0111H	Option RAM Fault (oFA10)
0046H	Current Offset Fault (CoF)	0112H	Option Operation Mode Fault (SLMOD) (oFA11)
0047H	PLC Detection Error 1 (PE1)	0113H	Drive Receive CRC Error (oFA12)
0048H	PLC Detection Error 2 (PE2)	0114H	Drive Receive Frame Error (oFA13)
004DH	Output Voltage Detection Fault (voF)	0115H	Drive Receive Abort Error (oFA14)
0052H	Node Setup Fault (nSE)	0116H	Option Receive CRC Error (oFA15)
005AH	Motor Underload Protection (UL6)	0117H	Option Receive Frame Error (oFA16)
0083H	A/D Conversion Error (CPF02)	0118H	Option Receive Abort Error (oFA17)
0084H	PWM Data Fault (CPF03)	0131H	Comm. ID Error (oFA30)
0087H	EEPROM Memory Data Error (CPF06)	0132H	Model Code Error (oFA31)
0088H	Terminal Board Connection Error (CPF07)	0133H	Sumcheck Error (oFA32)
0089H	EEPROM Serial Communication Fault (CPF08)	0134H	Comm. Option Timeout Waiting for Response (oFA33)
008CH	RAM Fault (CPF11)	0135H	MEMOBUS Timeout (oFA34)
008DH	Flash Memory Circuit Exception (CPF12)	0136H	Drive Timeout Waiting for Response (oFA35)
008EH	Watchdog Circuit Exception (CPF13)	0137H	CI Check Error (oFA36)
008FH	Control Circuit Fault (CPF14)	0138H	Drive Timeout Waiting for Response (oFA37)
0091H	Clock Fault (CPF16)	0139H	Control Command Selection Error (oFA38)
0092H	Timing Fault (CPF17)	013AH	Drive Timeout Waiting for Response (oFA39)
0093H	Control Circuit Fault (CPF18)	013BH	Control Response Selection 1 Error (oFA40)
0094H	Control Circuit Fault (CPF19)	013CH	Drive Timeout Waiting for Response (oFA41)
0095H	Hardware Fault at Power Up (CPF20)	013DH	Control Response Selection 2 Error (oFA42)
0096H	Hardware Fault at Communication Start Up (CPF21)	013EH	Control Response Selection Error (oFA43)
0097H	A/D Conversion Fault (CPF22)	0401H	Time Not Set (TIM)
0098H	PWM Feedback Fault (CPF23)	0402H	Operator Battery Low (bAT)
0099H	Drive Unit Signal Fault (CPF24)	0403H	Time Data Error (TdE)
009AH	Terminal Board is Not Properly Connected. (CPF25)	0404H	Time Interval Error (TiE)
009BH	ASIC BB Circuit Error (CPF26)	0407H	External Fan Fault (Fn1)
009CH	ASIC PWM Setting Register Error (CPF27)		
009DH	ASIC PWM Pattern Error (CPF28)		

D.9 MEMOBUS/Modbus Data Table

◆ Bypass Fault Codes

Table D.4 shows the bypass fault codes that can be read out by MEMOBUS/Modbus commands from the UB-□□ monitor parameters.

Table D.4 Bypass fault Codes

Fault Code	Fault Name	Fault Code	Fault Name
0001H	Safety Open	0008H	PL Brownout
0002H	BAS InterLock Open	0009H	PL Blackout
0003H	External Fault (EFB)	000AH	No Bypass to Drive Communications
0004H	NA	000BH	Bypass Board Hardware Error
0005H	Motor Overload	000CH	Option Board Communication Fault
0006H	Ext Motor1 Overload	000DH	Loss of Load
0007H	Ext Motor2 Overload	000EH	Serial Communications Timeout

◆ Alarm Register Contents

The table below shows the alarm codes that can be read out from MEMOBUS/Modbus register 007FH.

Table D.5 Alarm Register 007FH Contents

Fault Code	Fault Name	Fault Code	Fault Name
0001H	Undervoltage (Uv)	0028H	PI Feedback Loss (FbH)
0002H	Overvoltage (ov)	002AH	Drive Disabled (dnE)
0003H	Heatsink Overheat (oH)	0031H, 0033H	Reserved
0004H	Overheat Signal from MFDI (oH2)	0034H	High Current Alarm (HCA)
0005H	Overtorque 1 (oL3)	0035H	Cooling Fan Maintenance Time (LT-1)
0007H	Run commands input error (EF)	0036H	Capacitor Maintenance Time (LT-2)
0008H	Drive Baseblock (bb)	0038H	Reserved
0009H	External Fault 3, input terminal S3 (EF3)	0039H	External Fault (input terminal S1) (EF1)
000AH	External Fault 4, input terminal S4 (EF4)	003AH	External Fault (input terminal S2) (EF2)
000BH	External Fault 5, input terminal S5 (EF5)	003FH	PLC Alarm (PA1)
000CH	External Fault 6, input terminal S6 (EF6)	0040H	PLC Alarm (PA2)
000DH	External Fault 7, input terminal S7 (EF7)	0041H	Output Voltage Detection Fault (voF)
000FH	Internal Fan Fault (FAn)	004EH	Motor Underload Protection (UL6)
0014H	MEMOBUS/Modbus Communication Error (CE)	004FH	Waiting for Run (WrUn)
0015H	Option Communication Error (bUS)	0063H	Time Not Set (TIM)
0017H	Motor Overload (oL1)	0064H	Operator Battery Low (bAT)
0018H	Drive Overload (oL2)	0065H	Time Data Error (TdE)
001AH	Option Card External Fault (EF0)	0066H	External Fan Fault (Fn1)
001DH	Serial Communication Transmission Error (CALL)	0067H	Emergency Override Forward Run (EoF)
001EH	Undertorque Detection 1 (UL3)	0068H	Emergency Override Reverse Run (Eor)
0020H	MEMOBUS/Modbus Test Mode Fault (SE)	006AH	Customer Safety (SAFE)
0022H	Motor Overheat (oH3)	006BH	Interlock Open (inTLK)
0027H	PI Feedback Loss (FbL)		

D.10 Enter Command

When writing parameters to the bypass from the PLC using MEMOBUS/Modbus communication, parameters become active immediately. If it is desired to save the parameter value to non-volatile memory, then a separate Enter command must be given. This section describes the Enter command.

The bypass supports the Enter command as shown in *Table C.10*. An Enter command is enabled by writing 0 to register number 0900H. It is only possible to write to this register; attempting to read from this register will cause an error.

Table D.6 Enter Command

Register No.	Description
0900H	Simultaneously writes data into the EEPROM (non-volatile memory) of the bypass and enables the data in RAM. Parameter changes remain after cycling power.

Note: The EEPROM can only be written to 100,000 times, so it is recommended to limit the number of times writing to the EEPROM. The Enter command register is write-only and if this register is read, the register address will be invalid (Error code: 02H). An Enter command is not required when reference or broadcast data are sent to the drive.

◆ Enter Command Behavior

An enter command is not required when writing registers 0000H to 001FH and 8400H to 83FFH. Changes to those registers cannot be saved to non-volatile memory.

Enter Conditions	Behavior
How parameter settings are enabled	As soon as the value is changed.
Upper/lower limit check	Checks only the upper/lower limits of the parameters that were changed.
Default value of related parameters	Default settings of related parameters are changed automatically.
Error handling when setting multiple parameters	Error occurs if only one setting is invalid. All data that was sent are discarded.

D.11 Communication Errors

D.11 Communication Errors

◆ MEMOBUS/Modbus Error Codes

A list of MEMOBUS/Modbus errors appears below.

When an error occurs, remove whatever caused the error and restart communications.

Error Code	Error Name
	Cause
01H	Function Code Error
	Attempted to set a function code from a PLC other than 03H, 08H, and 10H.
02H	Register Number Error
	<ul style="list-style-type: none">• A register number specified in the command message does not exist.• Attempted to send a broadcast message using other register numbers than 0001H or 0002H.
03H	Bit Count Error
	<ul style="list-style-type: none">• Read data or write data is greater than 16 bits. Invalid command message quantity.• In a write message, the “Number of Data Items” contained within the message does not equal twice the amount of data words (i.e., the total of Data 1+ Data 2, etc.).
21H	Data Setting Error
	<ul style="list-style-type: none">• Control data or parameter write data is outside the allowable setting range.• Attempted to write a contradictory parameter setting.
22H	Write Mode Error
	<ul style="list-style-type: none">• During run, the user attempted to write a parameter that cannot be written to during run.• During an EEPROM memory data error (CPF06), the master attempted to write to a parameter other than A1-00 to A1-05, E1-03, or o2-04.• Attempted to write to read-only data.
23H	Power Supply Err
	During an undervoltage situation, the master attempted to write to parameters that cannot be written to during undervoltage.
24H	Write Error During Parameter Process
	Master attempted writing to the drive while the drive was processing parameter data.
25H	Writing into EEPROM Disabled
	An attempt was made to write data into EEPROM by MEMOBUS/Modbus communications when writing EEPROM is not possible. (When this error code occurs, an error message is displayed and the drive continues operation.)

◆ Slave Not Responding

In the following situations, the slave drive will ignore the command message sent from the master, and not send a response message:

- When a communications error (overflow, framing, parity, or CRC-16) is detected in the command message.
- When the slave address in the command message and the slave address in the drive do not match (remember to set the slave address for the drive using Z3-02).
- When the gap between two blocks (8-bit) of a message exceeds 24 bits.
- When the command message data length is invalid.

Note: If the slave address specified in the command message is 00H, all slaves execute the write function, but do not return response messages to the master.

Appendix: E

Standards Compliance

This appendix explains the guidelines and criteria for maintaining CE and UL standards.

- E.1 SECTION SAFETY.....358**
- E.2 EUROPEAN STANDARDS.....360**
- E.3 UL/CUL STANDARDS.....361**

E.1 Section Safety

WARNING

Electrical Shock Hazard

Do not connect or disconnect wiring while the power is on.

Failure to comply could result in death or serious injury.

Before servicing, disconnect all power to the equipment. The internal capacitor remains charged even after the power supply is turned off. The charge indicator LED will extinguish when the DC bus voltage is below 50 Vdc. To prevent electric shock, wait for at least the time specified on the warning label; After all indicators are OFF, measure the DC bus voltage level to confirm it has reached a safe level.

Do not operate equipment with covers removed.

Failure to comply could result in death or serious injury.

The diagrams in this section may show drives without covers or safety shields to show details. Be sure to reinstall covers or shields before operating the drives and run the drives according to the instructions described in this manual.

Always ground the motor-side grounding terminal.

Improper equipment grounding could result in death or serious injury by contacting the motor case.

Do not touch any terminals before the capacitors have fully discharged.

Failure to comply could result in death or serious injury.

Before wiring terminals, disconnect all power to the equipment. The internal capacitor remains charged even after the power supply is turned off. After shutting off the power, wait for at least the amount of time specified on the drive before touching any components.

Do not allow unqualified personnel to perform work on the drive or bypass.

Failure to comply could result in death or serious injury.

Installation, maintenance, inspection, and servicing must be performed only by authorized personnel familiar with installation, adjustment and maintenance of AC drives.

Do not perform work on the drive while wearing loose clothing, jewelry or without eye protection.

Failure to comply could result in death or serious injury.

Remove all metal objects such as watches and rings, secure loose clothing, and wear eye protection before beginning work on the drive.

Do not remove covers or touch circuit boards while the power is on.

Failure to comply could result in death or serious injury.

Fire Hazard

Tighten all terminal screws to the specified tightening torque.

Loose electrical connections could result in death or serious injury by fire due to overheating of electrical connections.

Do not use an improper voltage source.

Failure to comply could result in death or serious injury by fire.

Verify that the rated voltage of the drive matches the voltage of the incoming power supply before applying power.

Do not use improper combustible materials.

Failure to comply could result in death or serious injury by fire.

Attach the drive to metal or other noncombustible material.

NOTICE

Observe proper electrostatic discharge procedures (ESD) when handling the drive and circuit boards.

Failure to comply may result in ESD damage to the drive circuitry.

Never connect or disconnect the motor from the drive while the drive is outputting voltage.

Improper equipment sequencing could result in damage to the drive.

Do not use unshielded wire for control wiring.

Failure to comply may cause electrical interference resulting in poor system performance. Use shielded twisted-pair wires and ground the shield to the ground terminal of the drive.

Do not modify the drive or bypass circuitry.

Failure to comply could result in damage to the drive or bypass and will void warranty.

Yaskawa is not responsible for modification of the product made by the user. This product must not be modified.

Check all the wiring to ensure that all connections are correct after installation.

Failure to comply could result in damage to equipment.

If a fuse is blown or a Ground Fault Circuit Interrupter (GFCI) is tripped, check the wiring and the selection of the peripheral devices.

Contact your supplier if the cause cannot be identified after checking the above.

Do not restart the drive immediately operate the peripheral devices if a fuse is blown or a GFCI is tripped.

Check the wiring and the selection of peripheral devices to identify the cause. Contact your supplier before restarting the drive or the peripheral devices if the cause cannot be identified.

E.2 European Standards



Figure E.1 CE Mark

The CE mark indicates compliance with European safety and environmental regulations. It is required for engaging in business and commerce in Europe.

European standards include the Machinery Directive for machine manufacturers, the Low Voltage Directive for electronics manufacturers, and the EMC guidelines for controlling noise.

This drive displays the CE mark based on the EMC guidelines and the Low Voltage Directive.

- **Low Voltage Directive:** 2006/95/EC
- **EMC Guidelines:** 2004/108/EC

Devices used in combination with this drive must also be CE certified and display the CE mark. When using drives displaying the CE mark in combination with other devices, it is ultimately the responsibility of the user to ensure compliance with CE standards. After setting up the device, verify that conditions meet European standards.

◆ CE Low Voltage Directive Compliance

This drive has been tested according to IEC/EN 61800-5-1, and it fully complies with the Low Voltage Directive.

To comply with the Low Voltage Directive, be sure to meet the following conditions when combining this drive with other devices:

■ Area of Use

Do not use drives in areas with pollution higher than degree 2 and overvoltage category 3 in accordance with IEC/EN 664.

■ Grounding

The drive is designed to be used in T-N (grounded neutral point) networks. If installing the drive in other types of grounded systems, contact your Yaskawa representative for instructions.

◆ EMC Guidelines Compliance

This drive is tested according to European standards IEC/EN 61800-3: 2004.

■ EMC Filter Installation

Verify the following installation conditions to ensure that other devices and machinery used with this drive comply with EMC guidelines.

1. Move the screws to the ON position to enable the internal EMC filter.
2. Use braided shield cable for the drive and motor wiring, or run the wiring through a metal conduit.
3. Keep wiring as short as possible. Ground the shield on both the drive side and the motor side.

Please consult Yaskawa for EMC filter installation.

E.3 UL/cUL Standards

◆ UL Standards Compliance

The UL/cUL mark applies to products in the United States and Canada. It indicates that UL has performed product testing and evaluation, and determined that their stringent standards for product safety have been met. For a product to receive UL certification, all components inside that product must also receive UL certification.



Figure E.2 UL/cUL Mark

The P1000 Bypass is tested in accordance with UL standard UL508A, and the drive is tested in accordance with UL standard UL508C; both comply with UL requirements. The conditions described below must be met to maintain compliance when using this drive in combination with other equipment:

■ Installation Area

Do not install the drive to an area greater than pollution degree 2 (UL standard).

E.3 UL/cUL Standards

This Page Intentionally Blank

Appendix: F

Apogee FLN Network Protocol

This manual explains the specifications and handling of the APOGEE FLN protocol for the Yaskawa model P1000 Bypass. The P1000 Bypass with the APOGEE FLN protocol connects the P1000 Bypass to an APOGEE FLN network and facilitates the exchange of data.

F.1	APOGEE FLN SET-UP.....	364
F.2	CONNECTING TO A NETWORK.....	365
F.3	SLOPE AND INTERCEPT CONVERSION.....	367
F.4	APOGEE FLN POINT LIST SUMMARY.....	369
F.5	CABLE LOSS CONFIGURATION AND BEHAVIOR.....	373
F.6	MAILBOX FUNCTION.....	375
F.7	FAULT CODES.....	376

F.1 APOGEE FLN Set-Up

F.1 APOGEE FLN Set-Up

A Yaskawa America, Inc. representative is responsible for proper configuration of the Bypass for its primary application, while a Siemens Building Technologies, Inc. representative is responsible for field panel programming to make use of the Bypass functionality in the building automation system. As such, there must be coordination between the Yaskawa America and Siemens Building Technologies representatives to ensure that the programming of the drive is consistent with the particular application requirements. After verifying that the drive installation and wiring are correct, apply power to the drive. **Table F.1** lists the parameters and their values required for proper APOGEE FLN communication and control.

◆ Bypass Parameter Settings for APOGEE FLN Communications

Table F.1 Drive Communication Parameter Settings

Parameter Number	Digital Operator Display	Settings for APOGEE FLN Communication
Z1-07	Reference Source	2: Serial Com
Z1-08	Run Source	2: Serial Com
Z3-02	Serial Comm Adr	Select the Bypass address
Z3-03	Serial Baud Rate	2: 4800 Baud
Z3-01	Protocol Select	2: P1

NOTICE: A Yaskawa representative should set the drive parameters to their appropriate values. Changes made to the parameters other than what is listed in the table above can result in damaging the drive or building equipment.

F.2 Connecting to a Network

◆ Network Cable Connection

Follow the instructions below to connect the bypass to a MEMOBUS/Modbus network.

Note: Separate the communications cables from the main circuit cables and other wiring and power cables. Use shielded cables for the communication cables and properly shielded clamps to prevent problems from electrical interference.

- With the power shut off, connect the communications cable to the bypass controller board A2 and the master. Use the terminal TB3 for MEMOBUS/Modbus.

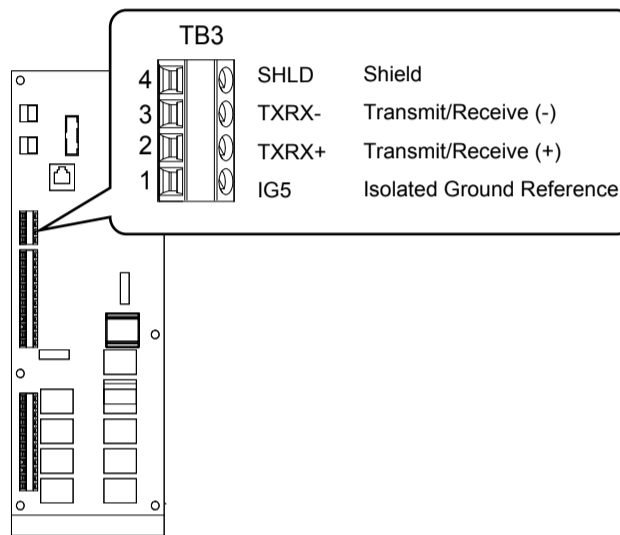

Figure F.1 Serial Communications Cable Connection Terminal (TB3)

- Check or set the termination resistor selection at all slaves. Use the description in the Network Termination section for slaves that are P1000 Bypasses.
- Switch power on.
- Set the parameters need for serial communications (Z3-01 through Z3-11) using the digital operator.
- Shut the power off and wait until the display on the digital operator goes out completely.
- Turn the power back on.
- The bypass is now ready to begin communicating with the master.

F.2 Connecting to a Network

◆ Wiring Diagram for Multiple Connections

■ RS-485 Interface

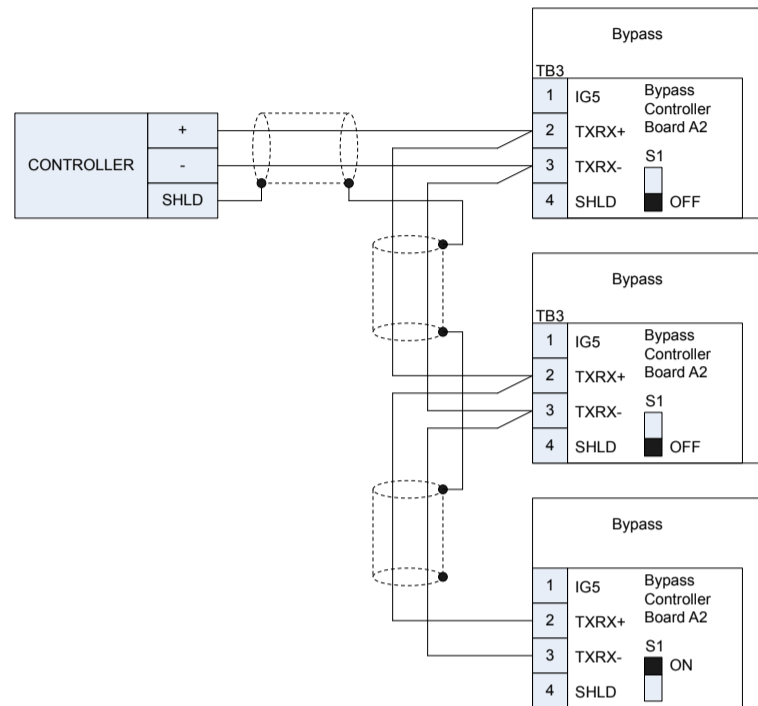

Figure F.2 Connection Diagram for Multiple Connections

Note: Turn on DIP switch S1 on the bypass controller located at the end of the network. If S1 is missing, then an external 120 ohm resistor must be placed across terminals TXRX+ and TXRX-. All other slave devices must have this DIP switch set to the OFF position (or if S1 is missing, no external resistor is used).

◆ Network Termination

The two ends of the P1 network line have to be terminated with a 120 ohm resistor between the TXRX+ and TXRX- signals. The P1000 Bypass has a built in termination resistor that can be enabled or disabled using DIP switch S1. If a bypass is located at the end of a network line, enable the termination resistor by setting DIP switch S1 to the ON position. Disable the termination resistor on all slaves that are not located on the network line end.

Note: Some bypass controllers do not have DIP switch S1. If this is the case, then an external 120 ohm resistor must be placed across the TXRX+ and TXRX- signals if the bypass controller is at the end of a network line.

◆ Recommended Cable

Table F.2 APOGEE FLN Cable Specifications

Specification	Description
Cable Configuration	Twisted Shielded Pair
Gauge	18-20 AWG (Solid or Stranded)
Wire Lay	6 twists per foot
Shields	100% foil with drain wire
NEC Type	UL Type CMP
Temperature	60°C or higher

F.3 Slope and Intercept Conversion

Several drive parameters are available for monitoring purposes. These include FREQ OUTPUT (Point 3), SPEED (Point 5), CURRENT (Point 6), TORQUE (Point 7), POWER (Point 8), DRIVE TEMP (Point 9), KWH (Point 10), and RUN TIME (Point 12). These points can be unbundled for monitoring or used in various global control strategies.

◆ Drive Controlled Feedback

The most typical application is Supervisory Control. The sensor for the control variable (e.g., water temperature) is hard-wired to the drive and the control device (fan) is modulated using the PI control loop that is built into the drive. The setpoint for the control variable (water temperature set point) is unbundled and commanded by the field panel, based on some building control strategy implemented in PPCL.

When this strategy is used, the point to unbundle and command for the set point is INPUT REF 1 (Point 60). The control variable (e.g., water temperature) can be monitored by unbundling PI FEEDBACK (Point 62). These points are provided in units of percent, where 0% and 100% correspond to the range of the sensor being used to measure the control variable. These points have default units in Hz. If other units are required, unbundle these points with appropriate slopes and intercepts. The new intercept will be equal to the lowest value of the desired range. The following formula lets you define a new slope and intercept in order to accomplish the unit conversion.

$$\text{New Slope} = \frac{(\text{Desired Range}) \times (\text{Slope of Existing Point})}{(\text{Range of Existing Point})}$$

$$\text{New Slope} = \frac{(60 - 0)\text{Hz} \times (0.01)}{(100 - 0)\%} = 0.006$$

Conversion Example

You are controlling water temperature from a cooling tower using the drive to control a fan. The temperature sensor has a range of 30°F to 250°F. To unbundle the set point (INPUT REF 1), for commanding in degrees Fahrenheit, where 0 to 60 Hz is equal to 30°F to 250°F:

New Intercept = 30 (the temperature that corresponds to 0%)

$$\text{New Slope} = \frac{(\text{Desired Range}) \times (\text{Slope of Existing Point})}{(\text{Range of Existing Point})}$$

$$\text{New Slope} = \frac{(250 - 30)^{\circ}\text{F} \times (0.1)}{(100 - 0)\%} = 0.022$$

Formula Notes:

Desired Range = Range Maximum – Range Minimum

Range of Existing Point = Existing Range Maximum – Existing Range Minimum

◆ Field Panel Controlled Feedback

In this strategy, the sensor is connected to the APOGEE FLN network at a remote location, and the control loop is executed in PPCL. The drive speed command is passed from the field panel to the drive by commanding INPUT REF 1 (Point 60).

NOTICE: *This strategy is not recommended because it means that the loop is being closed over the network. Delays due to processor scan time and network traffic can cause control to be degraded or lost. Damage to equipment may result.*

Unbundle the FEEDBACK

To unbundle the feedback (PI FEEDBACK) for monitoring in degrees Fahrenheit:

New Intercept = 30

$$\text{New Slope} = \frac{(\text{Desired Range}) \times (\text{Slope of Existing Point})}{(\text{Range of Existing Point})}$$

$$\text{New Slope} = \frac{(250 - 30)^{\circ}\text{F} \times (0.1)}{(100 - 0)\%} = 0.022$$

Formula Notes:

Desired Range = Range Maximum – Range Minimum

Range of Existing Point = Existing Range Maximum – Existing Range Minimum

F.3 Slope and Intercept Conversion

◆ Other Functionality

Each of the following functions must be enabled during start-up of the Drive:

Enable the drive to run

RUN ENABLE (Point 35) can be commanded to require the drive to have a physical input (DI-2) set before the drive can run. This works in conjunction with CMD RUN.STOP (Point 24) or the CMD REV.STOP (Point 22). If RUN ENABLE (Point 35) is commanded ON then terminal for DI-2 does not need to be on and CMD RUN.STOP (Point 24) or CMD REV.STOP (point 22) needs to be commanded ON for the drive to run. If, on the other hand, RUN ENABLE (Point 35) is commanded OFF, then to run the drive the input terminal for DI-3 needs to be on and either CMD RUN.STOP (Point 24) or CMD REV.STOP (Point 22), needs to be commanded ON.

Start and stop the drive

CMD RUN.STOP (Point 24) can be commanded to run the Bypass in the forward direction. STOP.RUN (Point 23) shows the current status of the Bypass.

Change directions

CMD REV.STOP (Point 22) can be commanded to run the drive in the reverse direction (ignored in Bypass Mode). FWD.REV (Point 21) shows the current direction of the drive rotation.

NOTICE: Improper drive direction may damage equipment if parameter b1-04, Reverse Enable, is improperly set ($b1-04 = 0$).

Digital Outputs

MULTI OUT 1 (Point 40), MULTI OUT 2 (Point 41), and MULTI OUT 3 (Point 42) are physical digital outputs on the Bypass (DO-7 through DO-9). Their purpose depends on how the Bypass has been set-up. The Bypass can be programmed so that these points can display various limits, warnings, and status conditions. Some examples include HOA state, Drive or Bypass Mode, Fault Active, and Loss of Load detected.

Loop gain

PID P GAIN (Point 63) and PID I TIME (Point 64) are the gain and integral time parameters similar to the P and I gains in the APOGEE Terminal Equipment Controllers. The P1000 Bypass PI loop is structured differently than the Siemens loop, so there is not a one-to-one correspondence between the gains.

Reading and resetting faults

OK.FAULT (Point 93) shows the current status of the Bypass. FAULT CODE (Point 17) contains the code for the most current fault. LST FLT CODE (Point 66) contains the code for the previous drive fault. See table below for descriptions of the fault codes. The drive can be reset back to OK mode by commanding RESET FAULT (Point 94) to RESET.

F.4 APOGEE FLN Point List Summary

This database is for APOGEE FLN Application 2721 and features 97 logical points: 29 Logical Analog Inputs (LAI), 35 Logical Analog Outputs (LAO), 19 Logical Digital Inputs (LDI) and 14 Logical Digital Outputs (LDO). These points configure, control or monitor the operation of the drive.

Information to consider when referencing this table:

- Points not listed are not used in this application.
- A single value in a column means that the value is the same in English units and in SI units.
- Point numbers that appear in brackets, e.g. {03}, can be unbundled at the field panel.

Table F.3 APOGEE FLN Application 2721 Point Number Summary

Point No.	Point Type	Point Name	Factory Default (SI Units)	Engr. Units (SI Units)	Slope (SI Units)	Intercept (SI Units)	On Text	Off Text	Parameter
1	LAO	CTLR ADDRESS	31	–	1	0	–	–	Z3-02
2	LAO	APPLICATI ON	–	–	1	0	–	–	–
{03}	LAI	FREQ OUTPUT	0	HZ	0.01	0	–	–	U1-02
{04}	LAI	PCT OUTPUT	0	PCT	0.01	0	–	–	–
{05}	LAI	SPEED	0	RPM	1	0	–	–	–
{06}	LAI	CURRENT	0	AMPS (A)	0.01/0.1 <2>	0	–	–	UB-01
{07}	LAI	TORQUE	0	PCT	0.1	0	–	–	–
{08}	LAI	POWER	0	KW	0.01/0.1 <2>	0	–	–	U1-08
{09}	LAI	DRIVE TEMP	0	DEG F / C	1	0	–	–	U4-08
{10}	LAI	DRIVE KWH	0	KWH	0.1	0	–	–	U4-10
{11}	LAI	MWH	0	MWH	1	0	–	–	U4-11
{12}	LAI	RUN TIME	0	HRS	1	0	–	–	U4-01
{13}	LAI	DC BUS VOLT	0	VOLTS (V)	1	0	–	–	U1-07
{14}	LAI	AC OUT VOLT	0	VOLTS (V)	0.1	0	–	–	U1-06
15	LAI	PAR N9.01	0	AMPS (A)	0.01/0.1 <2>	0	–	–	N9-01
{16}	LAI	RUN TIMEX10K	0	10K HR	1	0	–	–	U4-01
{17}	LAI	FAULT CODE	0	–	1	0	–	–	U2-01/ UB-09
{18}	LDI	MINOR FLT	NO FLT	–	1	0	FAULT	NO FLT	U1-12 (Bit 6)
{19}	LDI	MAJOR FLT	NO FLT	–	1	0	FAULT	NO FLT	UB-06 (Bit 2)
20	LAO	OVRD TIME	1	HRS	1	0	–	–	–
{21}	LDI	FWD.REV	FWD	–	1	0	REV	FWD	U1-12 (Bit 2)
{22}	LDO	CMD REV.STOP	STOP	–	1	0	REV	STOP	–
{23}	LDI	RUN.STOP	STOP	–	1	0	RUN	STOP	UB-06 (Bit 1)
{24}	LDO	CMD RUN.STOP	STOP	–	1	0	FWD	STOP	–
{25}	LDI	ZERO SPEED	OFF	–	1	0	ON	OFF	U1-12 (Bit 1)
{26}	LDI	SPEED AGREE	NO AGR	–	1	0	AGREE	NO AGR	U1-12 (Bit 4)
{27}	LDI	DRIVE READY	NOTRDY	–	1	0	READY	NOTRDY	U1-12 (Bit 5)

Apogee FLN Network Protocol

F

F.4 APOGEE FLN Point List Summary

Point No.	Point Type	Point Name	Factory Default (SI Units)	Engr. Units (SI Units)	Slope (SI Units)	Intercept (SI Units)	On Text	Off Text	Parameter
{28}	LDI	LOC.REM MON	REMOTE	–	1	0	LOCAL	REMOTE	UB-05
{29}	LDO	DAY.NGT	DAY	–	1	0	NGT	DAY	–
30	LAO	CURRENT LMT	0	AMPS (A)	0.01/0.1 <2>	0	–	–	E2-01
31	LAO	ACCEL TIME	0	SEC	0.1	0	–	–	C1-01
32	LAO	DECEL TIME	0	SEC	0.1	0	–	–	C1-02
33	LDO	LOCK PANEL	UNLOCK	–	1	0	LOCK	UNLOCK	–
35 <1>	LDO	RUN ENABLE	STOP	–	1	0	ENABLE	STOP	Bypass DI-2
36	LAO	STALL PRE RN	90	PCT	1	30	–	–	L3-06
37	LAO	STALL PRE AC	120	PCT	1	0	–	–	L3-02
38	LAO	FREQ UP LIM	100	PCT	0.1	0	–	–	d2-01
39	LAO	FREQ LOW LIM	0	PCT	0.1	0	–	–	d2-02
{40}	LDI	MULTI OUT 1	OFF	–	1	0	ON	OFF	UB-03 (Bit 6) Bypass DO-7
{41}	LDI	MULTI OUT 2	OFF	–	1	0	ON	OFF	UB-03 (Bit 7) Bypass DO-08
{42}	LDI	MULTI OUT 3	OFF	–	1	0	ON	OFF	UB-03 (Bit 8) Bypass DO-9
{43}	LDI	SAFETY ILOCK	OFF	–	1	0	ON	OFF	UB-05 (Bit 7)
{44} <3>	LDO	MF INP 1	OFF	–	1	0	ON	OFF	Bypass DI-3
{45} <3>	LDO	MF INP 2	OFF	–	1	0	ON	OFF	Bypass DI-4
{46} <3>	LDO	MF INP 3	OFF	–	1	0	ON	OFF	Bypass DI-5
{47} <3>	LDO	MF INP 4	OFF	–	1	0	ON	OFF	Bypass DI-6
{48} <3>	LDO	MF INP 5	OFF	–	1	0	ON	OFF	Bypass DI-7
49	LAO	JUMP FREQ 1	0	HZ	0.1	0	–	–	d3-01
50	LAO	JUMP FREQ 2	0	HZ	0.1	0	–	–	d3-02
51	LAO	JUMP FREQ 3	0	HZ	0.1	0	–	–	d3-03
52	LAO	JUMP FREQ BW	0	HZ	0.1	0	–	–	d3-04
53	LAO	NUM AUTOSTRT	0	–	1	0	–	–	L5-01
54	LAO	POWER LOSS RT	0.1	SEC	0.1	0	–	–	L2-02
55	LAO	RUN OP MODE	1	–	1	0	–	–	Z1-08
56	LAO	REF OP MODE	1	–	1	0	–	–	Z1-07
57	LAO	OPER DISP MD	0	–	1	0	–	–	o1-03
{58}	LDI	MF IN 1 MON	OFF	–	1	0	ON	OFF	UB-02 (Bit 2) Bypass DI-3
{59}	LDI	MF IN 2 MON	OFF	–	1	0	ON	OFF	UB-02 (Bit 3) Bypass DI-4

F.4 APOGEE FLN Point List Summary

Point No.	Point Type	Point Name	Factory Default (SI Units)	Engr. Units (SI Units)	Slope (SI Units)	Intercept (SI Units)	On Text	Off Text	Parameter
{60}	LAO	INPUT REF 1	0	HZ	0.01	0	-	-	-
61	LAO	INPUT REF 2	0	HZ	0.01	0	-	-	d1-02
{62}	LAI	PID FEEDBACK	0	PCT	0.01	0	-	-	U5-01
63	LAO	PID P GAIN	2	-	0.01	0	-	-	b5-02
64	LAO	PID I TIM	0.5	SEC	0.1	0	-	-	b5-03
65	LDO	PID MODE SEL	DISABLE	-	1	0	ENABLE	DISABLE	b5-01
{66}	LAI	LST FLT CODE	0	-	1	0	-	-	U2-02
{67}	LAI	FREF.FLT	0	HZ	0.01	0	-	-	U2-03
{68}	LAI	OUT FREQ FLT	0	HZ	0.01	0	-	-	U2-04
{69}	LAI	OUT CUR.FLT	0	AMPS (A)	0.01	0	-	-	U2-05
70	LAO	RD PARAM NUM	1	-	1	0	-	-	-
71	LAI	RD PARAM DAT	0	-	1	0	-	-	-
72	LAO	WR PARAM NUM	1	-	1	0	-	-	-
73	LAO	WR PARAM DAT	0	-	1	0	-	-	-
{74}	LDI	MF IN 3 MON	OFF	-	1	0	ON	OFF	UB-02 (Bit 4) Bypass DI-5
{75}	LAI	OUT VOLT.FLT	0	VOLTS (V)	0.1	0	-	-	U2-07
{76}	LAI	DC BUS.FLT	0	VOLTS (V)	1	0	-	-	U2-08
{77}	LAI	OUT PWR.FLT	0	KW	0.1	0	-	-	U2-09
{78}	LDI	MF IN 4 MON	OFF	-	1	0	ON	OFF	UB-02 (Bit 5) Bypass DI-6
{79}	LAI	PID DEVIATE	0	PCT	0.01	0	-	-	U5-02
80	LAO	PID I LIMIT	100	PCT	0.1	0	-	-	b5-04
81	LAO	PID UP LIMIT	100	PCT	0.1	0	-	-	b5-06
82	LAO	PID OFFS ADJ	100	PCT	0.1	-100	-	-	b5-07
83	LAO	PID PRI DYTM	0	SEC	0.1	0	-	-	b5-08
84	LAO	PID FB RMDS	0	-	1	0	-	-	b5-12
85	LAO	PID FB RMDL	0	PCT	1	0	-	-	b5-13
86	LAO	PID FB RMDT	1	SEC	0.1	0	-	-	b5-14
{87}	LAI	PID OUT CAP	0	PCT	0.01	0	-	-	U5-14
{88}	LAI	PID REF	0	PCT	0.01	0	-	-	U5-04
{89}	LAI	COMM ERR CD	0	-	1	0	-	-	U1-19
90	LDO	COMM FLT ENA	ENABLE	-	1	0	ENABLE	DISABLE	Z3-11

Apogee FLN Network Protocol

F

F.4 APOGEE FLN Point List Summary

Point No.	Point Type	Point Name	Factory Default (SI Units)	Engr. Units (SI Units)	Slope (SI Units)	Intercept (SI Units)	On Text	Off Text	Parameter
91	LAO	CBL LOSS FRQ	0	HZ	0.01	0	–	–	Z3-10
92	LAO	CBL LOSS TMR	2	SEC	0.1	0	–	–	Z3-06
{93}	LDI	OK.FAULT	OK	–	1	0	FAULT	OK	UB-06 (Bit 2)
{94}	LDO	RESET FAULT	NO	–	1	0	RESET	NO	–
{95}	LDI	DRV COMM ERR	NO FLT	–	1	0	FAULT	NO FLT	–
{96}	LDO	EXTERNAL FLT	OK	–	1	0	FAULT	OK	–
{97}	LDI	MF IN 5 MON	OFF	–	1	0	ON	OFF	UB-02 (Bit 6) Bypass DI-7
{99}	LAI	ERROR STATUS	0	–	1	0	–	–	–

<1> For point number 35 to work properly, set Z2-02=22 Run Enable (Safety)

<2> In bypass controller software versions VST800298 and later, the number of decimal places in the value depends on the bypass model. This value has two decimal places in models Z1B1D002 to Z1B1D031 and Z1B1B001 to Z1B1B014; this value has one decimal place in models Z1B1D046 to Z1B1D273 and Z1B1B021 to Z1B1B302.

<3> Disabled when Z3-12 is set to 0 in bypass controller software versions VST800298 and later.

F.5 Cable Loss Configuration and Behavior

This section describes the configurable cable loss feature of the drive. This feature offers a user maximum flexibility in determining the drive's response to a loss of communication.

◆ Drive Behavior at Loss of Communication

After some interval without receipt of a message, the drive can be configured to respond in one of the following manners:

- Continue at last speed
- Continue at last speed with Alarm
- Continue at preset speed
- Ramp to Stop with FB14 fault
- Coast to Stop with FB14 fault
- Emergency Stop with FB14 fault

◆ Apogee FLN Points

Three APOGEE FLN points are used to select the desired behavior:

- **POINT 92** – CBL LOSS TMR
- **POINT 91** – CBL LOSS FRQ
- **POINT 90** – COMM FLT ENA

Table F.4 Cable Loss Behavior Summary

Behavior	F6-03	Z3-05	CBL LOSS TMR (Point 92)	CBL LOSS FRQ (Point 91)	COMM FLT ENA (Point 90)
Decelerate to stop (stop time in C1-02) FB14 Fault. Note: In Bypass mode, bypass contactor will open and motor will coast to stop.	0	3	Timeout Interval	X	On
Coast to stop FB14 Fault. Note: In Bypass mode, bypass contactor will open and motor will coast to stop.	1	3	Timeout Interval	X	On
Fast stop (stop time in C1-09) FB14 Fault. Note: In Bypass mode, bypass contactor will open and motor will coast to stop.	2	3	Timeout Interval	X	On
Continue at last speed	3	0	0	X	X
Continue at last speed with Alarm	3	1	Timeout Interval	X	On
Continue at preset speed with Alarm	3	4	Timeout Interval	Preset Speed	On
Note: <ol style="list-style-type: none"> 1. Communication must first be established and then lost for these features to function as described. If a Bypass is powered-up without a cable connected or with the master controller offline, a communications timeout does not occur. 2. For modes which describe the Bypass running after a communications timeout, a run command must have been issued (RUN ENABLE (Point 35) = 'On' and either CMD RUN.FWD (Point 22) = 'On' or CMD RUN.REV (Point 24) = 'On') prior to loss of communications. For safety purposes, the drive will not automatically restart from a stopped condition. If a user requires the drive to restart automatically, additional external wiring is required to accomplish this (consult factory). <p>Upon expiration of the communications timeout interval, a CE (Communication Error) fault will be declared and will remain until communication is restored.</p>					

Continue at Last Speed

In this mode, CBL LOSS TMR (POINT 92) is set to 0, disabling the cable loss feature. The other two settings CBL LOSS FRQ (POINT 91) and COMM FLT ENA (POINT 90) are ignored. If communication is lost, the drive simply maintains its last commanded state. The drive will not display an alarm or fault to indicate it has lost communication. This behavior can also be achieved by setting parameter Z3-05 to "0".

F.5 Cable Loss Configuration and Behavior

Continue at Last Speed with Alarm

For this condition, COMM FLG ENA (Point 90) must be enabled and CBL LOSS TMR (Point 91) should be set to something other than 0. An AL14 Serial Communications Alarm is shown.

Continue at Preset Speed with Alarm

In this mode, CBL LOSS TMR (POINT 92) is set to the desired interval, CBL LOSS FRQ (POINT 91) is set to the desired preset speed and Z3-05 is set to 4. If the time between messages exceeds the timeout interval, the drive's speed command, INPUT REF 1, (Point 60) is set to the CBL LOSS FRQ (POINT 91) and the drive continues running at this new speed. COMM FLT ENA (POINT 90) must be set to ON.

Stop with Fault (FB14)

COMM FLT ENA (POINT 90) must be set to 'On'. In this mode, CBL LOSS TMR (POINT 92) is set to the desired interval and parameter F6-03 is set to a value of 0,1 or 2. If the time between messages exceeds the timeout interval, the drive's speed command, INPUT REF 1, (Point 60) is set to 0. The stopping method is determined by the setting of F6-03. An FB14 drive fault will be set and an EF0 will be sent to the drive. The drive behavior is determined by the setting of parameter F6-03.

- F6-03 = 0 selects Ramp to Stop. The deceleration time or the slope of the ramp is determined by the setting of drive parameter C1-02.
- F6-03 = 1 selects Coast to Stop. The drive does not attempt to control the rate of deceleration.
- F6-03 = 2 selects Fast Stop. The deceleration time is determined by the setting of drive parameter C1-09.

F.6 Mailbox Function

◆ Mailbox Function Points

■ Reading a Drive Parameter

Two points are defined for reading any drive parameter:

- #70 Specifies the parameter to be read from
- #71 Reports the value of the parameter specified in Point #70

When this point is read, it retrieves data from the parameter and sends it to the controller.

Example:

Writing a value of 387 (183 hex) to Point #70 specifies drive parameter b1-04. Reading Point #71 returns the current setting of parameter b1-04 to the controller.

■ Writing to a Drive Parameter

Two points are defined for writing to any drive parameter:

- #72 Specifies the parameter to be written to
- #73 Entry location of the value to be written to the parameter specified in Point #72

When this point is written to, it will write the value to the drive. An enter or accept command does not need to be sent for the data to be taken by the drive. The behavior of the write is the same as with the digital operator. If the drive is running, there are a limited number of drive parameters that can be written to.

Example:

Writing a value of 387 (183 hex) to Point #72 specifies drive parameter b1-04. Writing a value of 1 to Point #73 enables the drive for reverse run.

F.7 Fault Codes

F.7 Fault Codes

◆ Communications Fault

Table F.5 Drive Faults

Fault	Description	Cause	Corrective Action
FB14	FB14 Communication Error	Connection is broken or master has stopped communicating	Check all connections Verify all APOGEE FLN software configurations

◆ Bypass Faults–Apogee FLN Configuration

Table F.6 Bypass Faults

Fault Code	Fault Name	Fault Code	Fault Name
0002H	Undervoltage (Uv1)	001FH	EEPROM Write Error (Err)
0003H	Control Power Supply Undervoltage (Uv2)	00A0H	ASIC Code Error (CPF31)
0004H	Soft Charge Circuit Fault (Uv3)	00A1H	ASIC Start-up Error (CPF32)
0006H	Ground Fault (GF)	00A2H	Watch-dog Error (CPF33)
0007H	Overcurrent (oC)	00A3H	ASIC Power/Clock Error (CPF34)
0008H	Overvoltage (ov)	00A4H	External A/D Converter Error (CPF35)
0009H	Heatsink Overheat (oH)	00A9H	Control Circuit Error (CPF40)
000AH	Heatsink Overheat (oH1)	00AAH	Control Circuit Error (CPF41)
000BH	Motor Overload (oL1)	00ABH	Control Circuit Error (CPF42)
000CH	Drive Overload (oL2)	00ACH	Control Circuit Error (CPF43)
000DH	Overtorque Detection 1 (oL3)	00ADH	Control Circuit Error (CPF44)
0020H	Motor Overheat (PTC input) (oH4)	00AEH	Control Circuit Error (CPF45)
0021H	MEMOBUS/Modbus Communication Error (CE)	0101H	Option Compatibility Error (oFA00)
0022H	Option Communication Error (bUS)	0102H	Option Not Properly Connected (oFA01)
0027H	Option External Fault (EF0)	0106H	A/D Conversion Error (oFA05)
0028H	PI Feedback Loss (FbL)	0107H	Option Response Error (oFA06)
0029H	Undertorque Detection 1 (UL3)	0111H	Option RAM Fault (oFA10)
002BH	High Slip Braking Overload (oL7)	0112H	Option Operation Mode Fault (SLMOD) (oFA11)
0030H	Hardware Fault (including oFx)	0113H	Drive Receive CRC Error (oFA12)
0036H	Output Current Imbalance (LF2)	0114H	Drive Receive Frame Error (oFA13)
0037H	Pullout Detection (Sto)	0115H	Drive Receive Abort Error (oFA14)
003BH	Too Many Speed Search Restarts (SEr)	0116H	Option Receive CRC Error (oFA15)
0041H	PI Feedback Loss (FbH)	0117H	Option Receive Frame Error (oFA16)
0042H	External Fault 1, Input Terminal S1 (EF1)	0118H	Option Receive Abort Error (oFA17)
0043H	External Fault 2, Input Terminal S2 (EF2)	0131H	Comm. ID Error (oFA30)
0046H	Current Offset Fault (CoF)	0132H	Model Code Error (oFA31)
0047H	PLC Detection Error 1 (PE1)	0133H	Sumcheck Error (oFA32)
0048H	PLC Detection Error 2 (PE2)	0134H	Comm. Option Timeout Waiting for Response(oFA33)
004DH	Output Voltage Detection Fault (voF)	0135H	MEMOBUS Timeout (oFA34)
0052H	Node Setup Fault (nSE)	0136H	Drive Timeout Waiting for Response (oFA35)
005AH	Motor Underload Protection (UL6)	0137H	CI Check Error (oFA36)
0083H	A/D Conversion Error (CPF02)	0089H	EEPROM Serial Communication Fault (CPF08)
0084H	PWM Data Fault (CPF03)	008CH	RAM Fault (CPF11)
0087H	EEPROM Memory Data Error (CPF06)	008DH	Flash Memory Circuit Exception (CPF12)
0088H	Terminal Board Connection Error (CPF07)	008EH	Watchdog Circuit Exception (CPF13)
001BH	Input Phase Loss (PF)	008FH	Control Circuit Fault (CPF14)
001CH	Output Phase Loss (LF)	0091H	Clock Fault (CPF16)
001DH	Motor Overheat (PTC input) (oH3)	0092H	Timing Fault (CPF17)
001EH	Digital Operator Connection (oPr)		

F.7 Fault Codes

Fault Code	Fault Name	Fault Code	Fault Name
0093H	Control Circuit Fault (CPF18)	0407H	External Fan Fault (Fn1)
0094H	Control Circuit Fault (CPF19)	1389H	Safety Open
0095H	Hardware Fault at Power Up (CPF20)	138AH	BAS InterLock Open
0096H	Hardware Fault at Communication Start Up (CPF21)	138BH	External Fault (EFB)
0097H	A/D Conversion Fault (CPF22)	138CH	NA
0098H	PWM Feedback Fault (CPF23)	138DH	Motor Overload
0099H	Drive Unit Signal Fault (CPF24)	138EH	Ext Motor1 Overload
009AH	Terminal Board is Not Properly Connected. (CPF25)	138FH	Ext Motor2 Overload
009BH	ASIC BB Circuit Error (CPF26)	1390H	PL Brownout
009CH	ASIC PWM Setting Register Error (CPF27)	1391H	PL Blackout
009DH	ASIC PWM Pattern Error (CPF28)	1392H	No Bypass to Drive Communications
009EH	ASIC On-delay Error (CPF29)	1393H	Bypass Board Hardware Error
009FH	ASIC BBON Error (CPF30)	1394H	Option Board Communication Fault
0010H	Braking Resistor Overheat (rH)	1395H	Loss of Load
0011H	External Fault at Input Terminal S3 (EF3)	1396H	Serial Communications Timeout
0012H	External Fault at Input Terminal S4 (EF4)	2711H <1>	Safety Open
0013H	External Fault at Input Terminal S5 (EF5)	2712H <1>	BAS InterLock Open
0014H	External Fault at Input Terminal S6 (EF6)	2713H <1>	External Fault (EFB)
0015H	External Fault at Input Terminal S7 (EF7)	2715H <1>	Motor Overload
0138H	Drive Timeout Waiting for Response (oFA37)	2716H <1>	Ext Motor1 Overload
0139H	Control Command Selection Error (oFA38)	2717H <1>	Ext Motor2 Overload
013AH	Drive Timeout Waiting for Response (oFA39)	2718H <1>	PL Brownout
013BH	Control Response Selection 1 Error (oFA40)	2719H <1>	PL Blackout
013CH	Drive Timeout Waiting for Response (oFA41)	271AH <1>	No Bypass to Drive Communications
013DH	Control Response Selection 2 Error (oFA42)	271CH <1>	Option Board Communication Fault
013EH	Control Response Selection Error (oFA43)	271DH <1>	Loss of Load
0401H	Time Not Set (TIM)	2720H <1>	Input Phase Rotation
0402H	Operator Battery Low (bAT)		
0403H	Time Data Error (TdE)		
0404H	Time Interval Error (TiE)		

<1> Available in bypass controller software versions VST800298 and later. Displayed by P1 Apogee Point LAI 17.

Note: Drive fault codes are listed in the Apogee User Manual (TOEP YAICOM 09).

F.7 Fault Codes

This Page Intentionally Blank

Appendix: G

Metasys N2 Network Protocol

G.1	N2 SPECIFICATIONS AND CONFIGURATION.....	380
G.2	CONNECTING TO A NETWORK.....	381
G.3	N2 SETUP PARAMETERS.....	383
G.4	BYPASS OPERATIONS BY N2.....	385
G.5	COMMUNICATIONS TIMING.....	389
G.6	METASYS N2 POINT DATABASE.....	390
G.7	MAILBOX FUNCTION.....	393

G.1 N2 Specifications and Configuration

G.1 N2 Specifications and Configuration

The bypasses can be monitored and controlled by a controller on a Metasys N2 network (N2) using RS-485 technology. The bypass act as slaves on the N2 network.

Up to 255 bypasses can communicate on a single N2 network. If more bypasses or N2 devices are required, another N2 network is required.

The N2 node address is configurable by a parameter in the bypass. This defines the physical address of the bypass on the N2 network.

Once the addressing is set, a controller can initiate communication to the bypass. The bypass will perform the specified function and then send a response back to the controller.

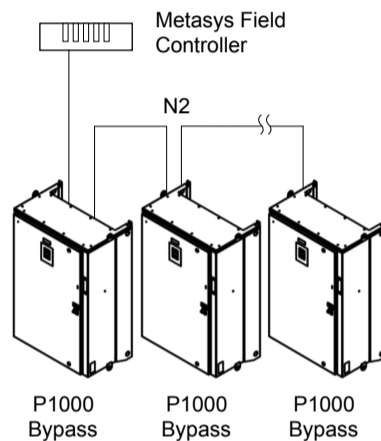

Figure G.1 Connecting Multiple Bypasses to a Metasys N2 Network

N2 specifications appear in the following table:

Item	Specifications
Interface	RS-485
Communication Parameters	Communication Speed: 9600 bps Data Length: 8-bit (fixed) Parity: None Stop Bit: 1-bit (fixed)
Protocol	Metasys N2
Max Number of Drives	255 per N2 Network Segment

G.2 Connecting to a Network

This section explains how to connect the drive to an N2 network and the network termination required for a connection.

◆ Network Cable Connection

Follow the instructions below to connect the bypass to a N2 network.

1. With the power shut off, connect the communications cable to the bypass controller board A2 and the master. Use terminal TB3 for N2.

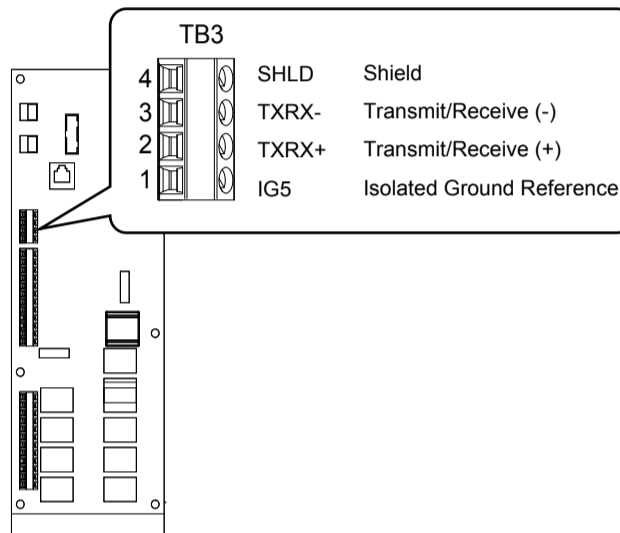

Figure G.2 Serial Communications Cable Connection Terminal (TB3)

- Note:** Separate the communications cables from the main circuit cables and other wiring and power cables. Use shielded cables for the communications cables, and properly shielded clamps to prevent problems caused by electrical interference.
2. Check or set the termination resistor selection at all slaves. Refer to the description in the **Network Termination** section for details on the termination resistor.
 3. Switch the power on.
 4. Set the parameters needed for serial communications (Z3-01 through Z3-11) using the digital operator.
 5. Shut the power off and wait until the display on the digital operator goes out completely.
 6. Turn the power back on.
 7. The bypass is now ready to begin communicating with the master.

G.2 Connecting to a Network

◆ Wiring Diagram for Multiple Connections

Figure C.3 explains the wiring diagrams for multiple connections using N2 communication.

■ RS-485 Interface

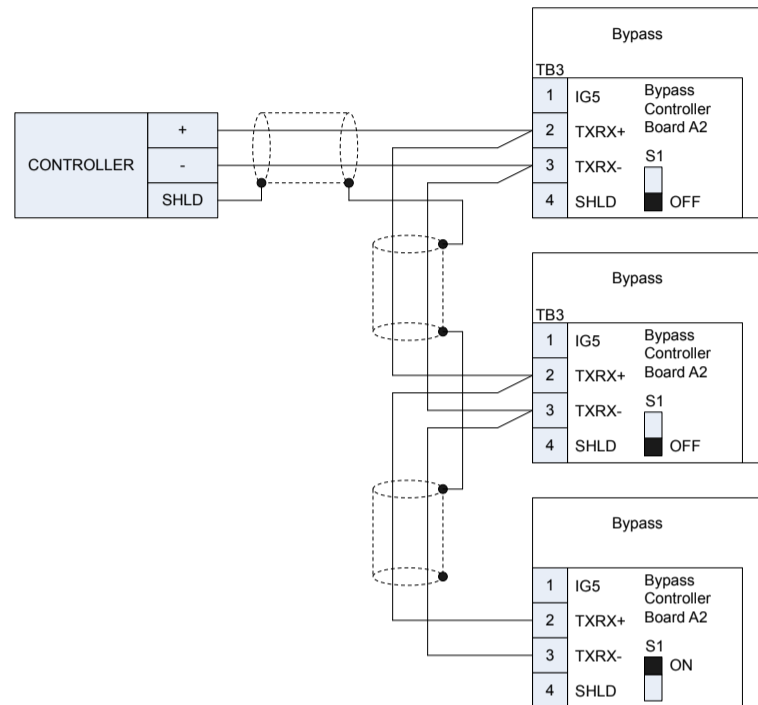

Figure G.3 Connection Diagram for Multiple Connections

Note: Turn on DIP switch S1 on the bypass that is located at the end of the network. If S1 is missing, then an external 120 ohm resistor must be placed across terminals TXRX+ and TXRX-. All other slave devices must have this DIP switch set to the OFF position (or if S1 is missing, no external resistor is used).

◆ Network Termination

The two ends of the network line must be terminated with a 120 ohm resistor between the TXRX+ and TXRX- signals. The P1000 Bypass has a built in termination resistor that can be enabled or disabled using DIP switch S1. If a bypass is located at the end of a network line, enable the termination resistor by setting DIP switch S1 to the ON position. Disable the termination resistor on all slaves that are not located at the network line end.

Note: Some bypass controllers do not have DIP switch S1. In such cases an external 120 ohm resistor must be placed across the TXRX+ and TXRX- signals if the bypass controller is at the end of a network line.

G.3 N2 Setup Parameters

◆ N2 Serial Communication

This section describes parameters necessary to set up N2 communications.

■ Z3-01: Serial Communications Protocol Select

Selects the communications protocol.

No.	Name	Setting Range	Default
Z3-01	Serial Communications Protocol Selection	0 to 3	0

Setting 0: MEMOBUS/Modbus

Setting 1: N2

Setting 2: P1

Setting 3: BACnet

■ Z3-02: Serial Communications Node Address Select

Sets the drive slave address used for communications.

Note: Cycle the power after changing this parameter to enable the new setting.

No.	Name	Setting Range	Default
Z3-02	Serial Communications Node Address Select	0 to FFH	1FH

Each slave drive must be assigned a unique slave address for serial communications to work. Slave addresses do not need to be assigned in sequential order, but no two drives may share the same address.

■ Z3-03: Serial Communications Baud Rate Select

Sets the communication speed.

Note: 1. Cycle the power after changing this parameter to enable the new setting.

No.	Name	Setting Range	Default
Z3-03	Serial Communications Baud Rate Select	0 to 8	3

Z3-03	Communication Speed Z30	Z3-03	Communication Speed
0	1200 bps	4	19200 bps
1	2400 bps	5	38400 bps
2	4800 bps	6	57600 bps
3	9600 bps	7	76800 bps
–	–	8	115200 bps

■ Z3-04: Serial Communications Parity Select

Sets the parity used for communications.

Note: Cycle the power after changing this parameter to enable the new setting.

No.	Name	Setting Range	Default
Z3-04	Serial Communications Parity Select	0 to 2	0

Setting 0: No parity

Setting 1: Even parity

Setting 2: Odd parity

■ Z3-05: Serial Communications Fault Select

Selects the action to take when a serial communications fault is detected. A serial communications fault is detected when after last communicating, no communications occurs within the time set to Z3-06.

No.	Name	Setting Range	Default
Z3-05	Serial Communications Fault Select	0 to 4	1

G.3 N2 Setup Parameters

Setting 0: Ignore

Setting 1: Alarm Only

Setting 2: Fault with EF0

An EF0 fault will be sent to the drive.

Setting 3: Fault with EF0 and Open Contactors

An EF0 fault will be sent to the drive and the bypass contactor (K3) will be opened.

Setting 4: Alarm and run at preset speed set in Z3-10

Display AL14 alarm on operator.

■ Z3-06: Serial Communications Fault Time Select

Sets the time allowed to elapse since receiving serial communications before triggering a communications fault. A value of 0.0 means to never time out.

No.	Name	Setting Range	Default
Z3-06	Serial Communications Fault Detection Time	0.0 to 99.9 s	2.0 s

■ Z3-07: Serial Communications Receive to Transmit Wait Time

Sets the time to delay a serial communications response to a serial communications command.

No.	Name	Setting Range	Default
Z3-07	Serial Communications Receive to Transmit Wait Time	0 to 99 ms	5 ms

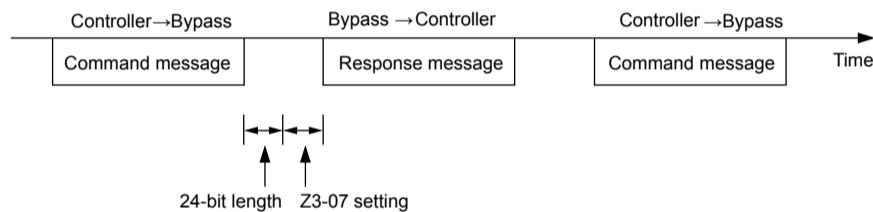

Figure G.4 Serial Communications Receive to Transmit Wait Time Setting

■ Z3-10: Cable Loss Pre-set Speed

When a serial communications fault is detected and Z3-05=4, the value here will become the frequency reference.

No.	Name	Setting Range	Default
Z3-10	Cable Loss Pre-set Speed	0.0 to 60.0 Hz	0.0 Hz

■ Z3-11: Serial Communication Fault Detection Selection

Enables or disables the serial communications fault detection.

No.	Name	Setting Range	Default
Z3-11	Serial Communication Fault Detection Selection	0 or 1	1

Setting 0: Disabled

No communication error detection. Ignore setting in Z3-05.

Setting 1: Enabled

If the bypass does not receive data from the master for longer than the time set to Z3-06, then a FB14 Serial Communications fault will be triggered and the bypass will operate as determined by parameter Z3-05.

G.4 Bypass Operations by N2

The drive operations that can be performed by N2 communication depend on drive parameter settings. This section explains the functions that can be used and related parameter settings.

◆ Observing the Bypass Operation

A controller can perform the following actions with N2 communications at any time regardless of parameter settings (except for Z3-□□ parameters):

- Observe drive status and drive control terminal status from a controller
- Read and write parameters
- Set and reset faults
- Set multi-function inputs.

Note: Input settings from the input terminals S□ and from N2 communications are both linked by a logical OR operation.

◆ Controlling the Bypass

Select an external reference and adjust the parameters in *Table C.1* accordingly to start and stop the drive or set the frequency reference using BACnet communications.

Table G.1 Setting Parameters for Drive Control from BACnet

Reference Source	Parameter	Name	Required Setting
External Reference 1	Z1-07	Frequency Reference Select	2
	Z1-08	Run Command Select	2

Refer to Z1-07: Speed Reference Select on page 163 and Refer to Z1-08: Run Command Select on page 164 for details on external reference parameter selections.

■ Bypass Functions

Each of the following functions must be enabled during start-up:

Start and Stop the Bypass

Set the Run Forward Command (BO 1) to run the in the forward direction. Set the Run Reverse Command (BO 2) to run the in the reverse direction. Run/Stop Monitor (BI 1) shows the current run status. Forward/Reverse Monitor (BI 2) shows the current direction.

NOTICE: *Damage to Equipment. Improper motor direction may damage equipment if parameter b1-04, Reverse Enable, is set to 0 (Enable).*

Lock the Bypass Panel

This function is not supported in the P1000 Bypass.

Digital Inputs

Multi-Function Input S3 (BO 5) through Multi-Function Input S7 (BO 9) are physical digital inputs on the bypass. They can be set either by external devices, such as limit or pressure switches, or by the network. Their function depends on how the bypass has been programmed. The multi-function input status can be monitored through Multi-Function Input 3 Monitor (BI 15) through Multi-Function Input 7 Monitor (BI 19). The Multi-Function Input # Monitor state is the logical OR of the serial command value (BO 5 through BO 9) and the state of the external connection.

Note: The multi-function inputs can be set by both external devices or over the network. Use caution when connecting the multi-function inputs to external devices to ensure correct system operation.

Digital Outputs

Multi-Function Output 7 (BI 10) through Multi-Function Output 9 (BI 12) are physical digital outputs on the bypass. Their function depends on how the bypass is programmed.

Loop Gain

PI Proportional Gain (AO 4) and PI Integral Time (AO 5) are the gain and integral time parameters used by the P1000. The P1000 PI loop is structured differently than the Metasys loop.

G.4 Bypass Operations by N2

Reading and Resetting Faults

The Fault Monitor (BI 4) and Drive Ready Monitor (BI 3) show the current status of the bypass. The Fault Code (AI 10) contains the code for the most current fault. The LST Fault Code (AI 19) contains the code for the previous drive fault. **Refer to Fault Trace / History Register Contents on page 387** for descriptions of the fault codes. The drive faults can be reset through the Fault Reset Command (BO 4). The Fault Reset Command is only available when the Run Forward Command and the Run Reverse Command are both OFF.

■ Cable Loss Configuration and Behavior

This section describes the configurable cable loss feature of the drive. This feature offers a user maximum flexibility in determining drive response to a loss of communication.

Drive Behavior at Loss of Communication

The drive can be configured to respond to an interval without receipt of a message in one of the following methods:

- Continue at last speed
- Continue at last speed with alarm
- Continue at preset speed
- Ramp to Stop with FB14 fault
- Coast to Stop with FB14 fault
- Emergency Stop with FB14 fault

Metasys N2 I/O

Three Metasys N2 outputs are used to select the desired behavior:

- AO 21 – Cable Loss Timeout
- AO 22 – Cable Loss Speed
- BO 11 – Communication Fault Enable

Table G.2 Cable Loss Behavior Summary

Behavior	F6-03	Z3-05	Cable Loss Timeout (AO 21)	Cable Loss Speed (AO 22)	Communication Fault Enable (BO 11)
Decelerate to stop (stop time in C1-02) FB14 Fault. Note: In Bypass mode, bypass contactor will open and motor will coast to stop.	0	3	Timeout Interval	X	On
Coast to stop FB14 fault. Note: In Bypass mode, bypass contactor will open and motor will coast to stop.	1	3	Timeout Interval	X	On
Fast stop (stop time in C1-09) FB14 fault. Note: In Bypass mode, bypass contactor will open and motor will coast to stop.	2	3	Timeout Interval	X	On
Continue at last speed	3	0	0	X	X
Continue at last speed with alarm	3	1	Timeout Interval	X	On
Continue at preset speed with alarm	3	4	Timeout Interval	Preset speed	On

- Note:**
1. Communication must first be established and then lost for these features to function as described. If a bypass is powered-up without a cable connected or with the master controller offline, a communications timeout does not occur.
 2. For modes that describe the bypass running after a communications timeout, a run command must have been issued (BO 1 = 'On' or BO 2 = 'On') prior to loss of communications. For safety purposes, the drive will not automatically restart from a stopped condition. If a user requires the drive to restart automatically, additional external wiring is required to accomplish this (consult factory).
 3. Upon expiration of the communications timeout interval, the FAULT LED lights and remains lit until communication is restored.

Continue at Last Speed

In this mode, Cable Loss Timeout (AO 21) is set to 0, disabling the cable loss feature. The other two settings Cable Loss Speed (AO 22) and Communication Fault Enable (BO 11) are ignored. If communication is lost, the drive simply maintains its last commanded state. The drive will not display an alarm or fault to indicate it has lost communication. This behavior can also be achieved by setting parameter Z3-05 to "0".

Continue at Last Speed with Alarm

For this condition, Communication Fault Enable (BO 11) must be enabled and Cable Loss Speed (AO 22) should be set to a value other than 0. An AL14 Serial Communications Alarm is shown.

Continue at Preset Speed with Alarm

In this mode, Cable Loss Timeout (AO 21) is set to the desired interval, Cable Loss Speed (AO 22) is set to the desired preset speed and Z3-05 is set to “4”. If the time between messages exceeds the timeout interval, the drive speed command (AO 1) is set to the Cable Loss Speed (AO 22) and the drive continues running at this new speed. Communication Fault Enable (BO 11) must be set to ‘On’.

Stop with Fault (FB14)

Communication Fault Enable (BO 11) must be set to ‘On’. In this mode, Cable Loss Timeout (AO 21) is set to the desired interval and parameter F6-03 is set to a value of 0,1 or 2. If the time between messages exceeds the timeout interval, the drive will declare an EF0 fault and the drive speed command (AO 1) will be set to 0. The stopping method is determined by the setting of F6-03.

- F6-03 = 0 selects Ramp to Stop. The deceleration time or the slope of the ramp is determined by the setting of drive parameter C1-02
- F6-03 = 1 selects Coast to Stop. The drive does not attempt to control the rate of deceleration.
- F6-03 = 2 selects Emergency or Fast Stop. The deceleration time is determined by the setting of drive parameter C1-09.

■ Bypass Fault Numbers

Table G.3 Fault Trace / History Register Contents

Fault Code	Fault Name	Fault Code	Fault Name
0002H	Undervoltage (Uv1)	0037H	Pullout Detection (Sto)
0003H	Control Power Supply Undervoltage (Uv2)	003BH	Too Many Speed Search Restarts (SEr)
0004H	Soft Charge Circuit Fault (Uv3)	0041H	PID Feedback Loss (FbH)
0006H	Ground Fault (GF)	0042H	External Fault 1, Input Terminal S1 (EF1)
0007H	Overcurrent (oC)	0043H	External Fault 2, Input Terminal S2 (EF2)
0008H	Overvoltage (ov)	0046H	Current Offset Fault (CoF)
0009H	Heatsink Overheat (oH)	0047H	PLC Detection Error 1 (PE1)
000AH	Heatsink Overheat (oH1)	0048H	PLC Detection Error 2 (PE2)
000BH	Motor Overload (oL1)	004DH	Output Voltage Detection Fault (voF)
000CH	Drive Overload (oL2)	0052H	Node Setup Fault (nSE)
000DH	Overtorque Detection 1 (oL3)	005AH	Motor Underload Protection (UL6)
0010H	Braking Resistor Overheat (rH)	0083H	A/D Conversion Error (CPF02)
0011H	External Fault at Input Terminal S3 (EF3)	0084H	PWM Data Fault (CPF03)
0012H	External Fault at Input Terminal S4 (EF4)	0087H	EEPROM Memory Data Error (CPF06)
0013H	External Fault at Input Terminal S5 (EF5)	0088H	Terminal Board Connection Error (CPF07)
0014H	External Fault at Input Terminal S6 (EF6)	0089H	EEPROM Serial Communication Fault (CPF08)
0015H	External Fault at Input Terminal S7 (EF7)	008CH	RAM Fault (CPF11)
001BH	Input Phase Loss (PF)	008DH	Flash Memory Circuit Exception (CPF12)
001CH	Output Phase Loss (LF)	008EH	Watchdog Circuit Exception (CPF13)
001DH	Motor Overheat (PTC input) (oH3)	008FH	Control Circuit Fault (CPF14)
001EH	Digital Operator Connection (oPr)	0091H	Clock Fault (CPF16)
001FH	EEPROM Write Error (Err)	0092H	Timing Fault (CPF17)
0020H	Motor Overheat (PTC input) (oH4)	0093H	Control Circuit Fault (CPF18)
0021H	MEMOBUS/Modbus Communication Error (CE)	0094H	Control Circuit Fault (CPF19)
0022H	Option Communication Error (bUS)	0095H	Hardware Fault at Power Up (CPF20)
0027H	Option External Fault (EF0)	0096H	Hardware Fault at Communication Start Up (CPF21)
0028H	PID Feedback Loss (FbL)	0097H	A/D Conversion Fault (CPF22)
0029H	Undertorque Detection 1 (UL3)	0098H	PWM Feedback Fault (CPF23)
002BH	High Slip Braking Overload (oL7)	0099H	Drive Unit Signal Fault (CPF24)
0030H	Hardware Fault (including oFx)	009AH	Terminal Board is Not Properly Connected. (CPF25)
0036H	Output Current Imbalance (LF2)	009BH	ASIC BB Circuit Error (CPF26)

G.4 Bypass Operations by N2

Fault Code	Fault Name	Fault Code	Fault Name
009CH	ASIC PWM Setting Register Error (CPF27)	0135H	MEMOBUS Timeout (oFA34)
009DH	ASIC PWM Pattern Error (CPF28)	0136H	Drive Timeout Waiting for Response (oFA35)
009EH	ASIC On-delay Error (CPF29)	0137H	CI Check Error (oFA36)
009FH	ASIC BBON Error (CPF30)	0138H	Drive Timeout Waiting for Response (oFA37)
00A0H	ASIC Code Error (CPF31)	0139H	Control Command Selection Error (oFA38)
00A1H	ASIC Start-up Error (CPF32)	013AH	Drive Timeout Waiting for Response (oFA39)
00A2H	Watch-dog Error (CPF33)	013BH	Control Response Selection 1 Error (oFA40)
00A3H	ASIC Power/Clock Error (CPF34)	013CH	Drive Timeout Waiting for Response (oFA41)
00A4H	External A/D Converter Error (CPF35)	013DH	Control Response Selection 2 Error (oFA42)
00A9H	Control Circuit Error (CPF40)	013EH	Control Response Selection Error (oFA43)
00AAH	Control Circuit Error (CPF41)	0401H	Time Not Set (TIM)
00ABH	Control Circuit Error (CPF42)	0402H	Operator Battery Low (bAT)
00ACH	Control Circuit Error (CPF43)	0403H	Time Data Error (TdE)
00ADH	Control Circuit Error (CPF44)	0404H	Time Interval Error (TiE)
00AEH	Control Circuit Error (CPF45)	0407H	External Fan Fault (Fn1)
0101H	Option Compatibility Error (oFA00)	1389H	Safety Open
0102H	Option Not Properly Connected (oFA01)	138AH	BAS InterLock Open
0106H	A/D Conversion Error (oFA05)	138BH	External Fault (EFB)
0107H	Option Response Error (oFA06)	138CH	Not Used
0111H	Option RAM Fault (oFA10)	138DH	Motor Overload
0112H	Option Operation Mode Fault (SLMOD) (oFA11)	138EH	Ext Motor1 Overload
0113H	Drive Receive CRC Error (oFA12)	138FH	Ext Motor2 Overload
0114H	Drive Receive Frame Error (oFA13)	1390H	PL Brownout
0115H	Drive Receive Abort Error (oFA14)	1391H	PL Blackout
0116H	Option Receive CRC Error (oFA15)	1392H	No Bypass to Drive Communications
0117H	Option Receive Frame Error (oFA16)	1393H	Bypass Board Hardware Error
0118H	Option Receive Abort Error (oFA17)	1394H	Option Board Communication Fault
0131H	Comm. ID Error (oFA30)	1395H	Loss of Load
0132H	Model Code Error (oFA31)	1396H	Serial Communications Timeout
0133H	Sumcheck Error (oFA32)		
0134H	Comm. Option Timeout Waiting for Response (oFA33)		

G.5 Communications Timing

To prevent a communications overrun in the slave drive, the master should wait a certain time between sending messages to the same drive. In the same way, the slave drive must wait before sending response messages to prevent an overrun in the master. This section explains the message timing.

◆ Command Messages from Master to Bypass

The master must wait for a specified time between receiving a response and resending the same type of command to the same slave bypass to prevent overrun and data loss. The minimum wait time depends on the command as shown in **Table G.4**.

Table G.4 Minimum Wait Time for Sending Messages

Command Type	Example	Minimum Wait Time
1	<ul style="list-style-type: none"> Control command (Run, Stop) Set inputs/outputs Read monitors and parameter values 	5 ms </>
2	Write parameters	H5-11 = 0: 50 ms H5-11 = 1: 200 ms </>
3	Save changes using an Enter command	200 ms to 2 s, depending on the number of parameters that were changed </>
4	Enter with storage to drive EEPROM after initialization	5 s

<1> If the bypass receives command type 1 data during the minimum wait time, it will perform the command and then respond. However, if it receives a command type 2 or 3 during that time, either a communication error will result or the command will be ignored.

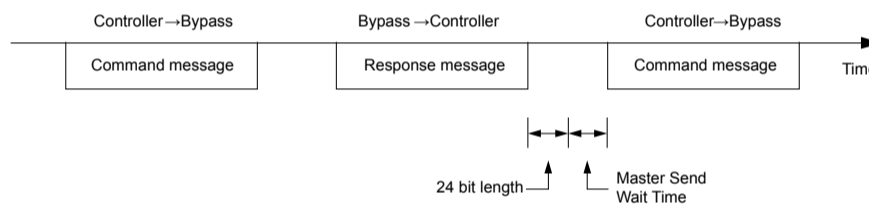

Figure G.5 Minimum Wait Time for Sending Messages

Set a timer in the master to check how long it takes for the slave bypass units to respond to the master. If no response is received within a certain amount of time, the master should try resending the message.

◆ Response Messages from Bypass to Master

If the bypass receives a command from the master, it will process the data received and wait for the time set in Z3-07 until it responds. Increase Z3-07 if the drive response causes overrun in the master.

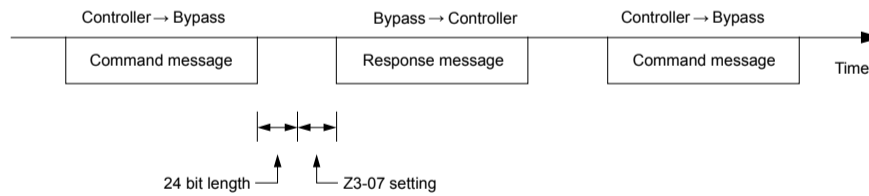

Figure G.6 Minimum Response Wait Time

G.6 Metasys N2 Point Database

G.6 Metasys N2 Point Database

This section describes the Metasys N2 point database. This database features 100 logical points: 38 Analog Inputs (AI), 32 Analog Outputs (AO), 19 Binary Inputs (BI) and 11 Binary Outputs (BO). These points configure, control, and monitor the operation of the drive.

◆ Metasys N2 Analog Input (AI) Summary

Table G.5 Metasys N2 Analog Input Summary (Bypass to Metasys N2)

Object ID	Object Name	Units	Bypass Parameter
AI 1	Speed Reference	0.01 Hz	U1-01
AI 2	Output Speed	0.01 Hz	U1-02
AI 3	Output Current	0.1 A	U1-03/UB-01 in Drive/Bypass Mode
AI 4	kWatt Hour Meter	kWh	U4-10
AI 5	Output Power	0.1 kWh	U1-08
AI 6	Drive Temperature	1 °C	U4-08 Will only report accurately when drive is running.
AI 7	PI Feedback	0.01%	U5-01
AI 8	AC Output Voltage	0.1 Vac	U1-06
AI 9	DC Bus Voltage	1 Vdc	U1-07
AI 10	Fault Code	–	U2-01/UB-09. Reads UB-09 first and if 0 returns U2-01
AI 11	Elapsed Time - Hours	1 hour	U4-01
AI 12	Elapsed Time - 10K Hours	10K hours	U4-01
AI 13	MWatt Hour meter	MWh	U4-11
AI 14	Drive Rated Current	A	n9-01
AI 15	Communication Error Code	–	Not supported. Always returns 0
AI 16	PI Deviation	0.01%	U5-02
AI 17	PI Output Capacity	0.01%	U5-03
AI 18	PI Reference	0.01%	U5-04
AI 19	Last Fault Code	–	U2-02
AI 20	Freq Ref @ Fault	0.01 Hz	U2-03
AI 21	Output Freq @ Fault	0.01 Hz	U2-04
AI 22	Output Current @ Fault	0.1 A	U2-05
AI 23	Out Volt Ref @ Fault	0.1 Vac	U2-07
AI 24	DC Bus Volts @ Fault	1 Vdc	U2-08
AI 25	Output Power @ Fault	0.1 kW	U2-09
AI 26	Input Term Status @ Fault	–	U2-11
AI 27	Output Term Status @ Fault	–	U2-12
AI 28	Operation Status @ Fault	–	U2-13
AI 29	Elapsed Operation Time @ Fault	1 hour	U2-14
AI 30	Most Recent Fault	–	U3-01
AI 31	2nd Most Recent Fault	–	U3-02
AI 32	3rd Most Recent Fault	–	U3-03
AI 33	4th Most Recent Fault	–	U3-04
AI 34	Elapsed Time @ Current Fault	1 hour	U3-11
AI 35	Elapsed Time @ 2nd Fault	1 hour	U3-12
AI 36	Elapsed Time @ 3rd Fault	1 hour	U3-13
AI 37	Elapsed Time @ 4th Fault	1 hour	U3-14
AI 38	Read Parameter Data	–	–

◆ Metasys N2 Analog Output (AO) Summary

Table G.6 Metasys N2 Analog Output Summary (Bypass to Metasys N2)

Object ID	Object Name	Units	Default Value	Bypass Parameter
AO 1	Speed Command	0.01 Hz	–	–
AO 2	Acceleration Time	seconds	30.0	C1-01
AO 3	Deceleration Time	seconds	30.0	C1-02
AO 4	PI Proportional Gain	–	2.00	b5-02
AO 5	PI Integral Time	seconds	5.0	b5-03
AO 6	Stall Prevention Level – Run	%	120	L3-06
AO 7	Stall Prevention Level – Accel	%	120	L3-02
AO 8	Frequency Reference Selection	–	0	Z1-07
AO 9	Run Command Selection	–	1	Z1-08
AO 10	PI Mode Select	–	0	b5-01
AO 11	Frequency Command Upper Limit	% of Max	100.0	d2-01
AO 12	Frequency Command Lower Limit	% of Max	0.0	d2-02
AO 13	Motor Rated Current	A	Motor model dependent	E2-01
AO 14	Jump Frequency 1	0.1 Hz	0.0	d3-01
AO 15	Jump Frequency 2	0.1 Hz	0.0	d3-02
AO 16	Jump Frequency 3	0.1 Hz	0.0	d3-03
AO 17	Jump Frequency Bandwidth	0.1 Hz	1.0	d3-04
AO 18	Number of Auto Restarts	–	0	L5-01
AO 19	Operator Display Mode	–	0	o1-03
AO 20	Power Loss Ride-Thru	seconds	Drive model dependent	L2-02
AO 21	Cable Loss Timeout	seconds	2.0	Z3-06
AO 22	Cable Loss Speed	0.01 Hz	0.00	Z3-10
AO 23	PI Integral Limit	0.1%	100.0	b5-04
AO 24	PI Upper Limit Value	0.1	100.0	b5-06
AO 25	PI Offset Adjustment	0.1	0.0	b5-07
AO 26	PI Primary Delay Time	0.01	0.00	b5-08
AO 27	PI Feedback Reference Missing Detection Select	1	0	b5-12
AO 28	PI Feedback Reference Missing Detection Level	1%	0	b5-13
AO 29	PI Feedback Reference Missing Detection Time	0.1 s	1.0	b5-14
AO 30	Read Parameter Number	–	–	–
AO 31	Write Parameter Number	–	–	–
AO 32	Write Parameter Data	–	–	–

◆ Metasys N2 Binary Input (BI) Summary

Table G.7 Metasys N2 Binary Input Summary (Bypass to Metasys N2)

Object ID	Object Name	Default	Off (0) State	On (1) State
BI 1	Run/Stop Monitor	0	Stopped	Running
BI 2	Forward/Reverse Monitor	0	Forward	Reverse
BI 3	Drive Ready Monitor	0	Not Ready	Ready
BI 4	Fault Monitor	0	Not Faulted	Faulted
BI 5	Zero Speed	0	Not Zero Speed	Zero Speed
BI 6	Speed Agree	0	Not Speed Agree	Speed Agree
BI 7	Minor Fault	0	No Minor Fault	Minor Fault
BI 8	Major Fault	0	No Major Fault	Major Fault
BI 9	Drive Communication Error Monitor	0	No Error	Error

G.6 Metasys N2 Point Database

Object ID	Object Name	Default	Off (0) State	On (1) State
BI 10	Multi-Function Output 7 (Z2-23)	0	Off	On
BI 11	Multi-Function Output 8 (Z2-24)	0	Off	On
BI 12	Multi-Function Output 9 (Z2-25)	0	Off	On
BI 13	Safety Interlock Monitor	0	Safety Clear	Safety Set
BI 14	HAND/AUTO Reference Monitor	0	AUTO or OFF	HAND
BI 15	Multi-Function Input 3 Monitor	0	Off	On
BI 16	Multi-Function Input 4 Monitor	0	Off	On
BI 17	Multi-Function Input 5 Monitor	0	Off	On
BI 18	Multi-Function Input 6 Monitor	0	Off	On
BI 19	Multi-Function Input 7 Monitor	0	Off	On

◆ Metasys N2 Binary Output (BO) Summary

Table G.8 Metasys N2 Binary Output Summary (Bypass to Metasys N2)

Object ID	Object Name	Default	Off (0) State	On (1) State
BO 1	Run Forward Command	0	Stop	Forward
BO 2	Run Reverse Command	0	Stop	Reverse
BO 3	External Fault (EFB) Command	0	No Fault	Fault (EFB)
BO 4	Fault Reset Command	0	No Reset	Reset
BO 5 <I>	Multi-Function Input 3 (Z2-03)	0	Off	On
BO 6 <I>	Multi-Function Input 4 (Z2-04)	0	Off	On
BO 7 <I>	Multi-Function Input 5 (Z2-05)	0	Off	On
BO 8 <I>	Multi-Function Input 6 (Z2-06)	0	Off	On
BO 9 <I>	Multi-Function Input 7 (Z2-07)	0	Off	On
BO10	Panel Lock Note: Not supported	0	-	-
BO 11	Communication Fault Enable	0	FB14 Not Activated if Cable Loss Occurs	FB14 Activated if Cable Loss Occurs

<I> Disabled when Z3-12 is set to 0 in bypass controller software versions VST800298 and later.

G.7 Mailbox Function

◆ Reading Drive Parameters

Two points are defined for reading drive parameters:

- AO 30 – Specifies the parameter to be read from the bypass.
- AI 38 – Reports the value of the parameter specified in AO 30.

When this point is read, it retrieves data from the parameter and sends it to the controller

Example: Writing a value of 387 (183 hex) to AO 30 specifies drive parameter b1-04. Reading AI 38 returns the current setting of parameter b1-04 to the controller.

◆ Writing Drive Parameters

Two points are defined for writing to drive parameters:

- AO 31 – Specifies the parameter to be written to
- AO 32 – Entry location of the value to be written to the parameter specified in AO 31. When this point is written to, it will write the value to the drive. An ENTER or ACCEPT command does not need to be sent for the data to be taken by the drive. The behavior of the write is the same as with the digital operator. If the drive is running, there are a limited number of drive parameters that can be written to.

Example: Writing a value of 387 (183 hex) to AO 31 specifies drive parameter b1-04. Writing a value of 1 to AO 32 sets b1-04 to 1 and disables the drive for reverse run.

G.7 Mailbox Function

This Page Intentionally Blank

Appendix: H

Quick Reference Sheet

This section provides tables to keep record of the Bypass specifications, motor specifications, and parameter settings. Fill in the table data after commissioning the application and have them ready when contacting Yaskawa for technical assistance.

H.1	P1000 BYPASS AND MOTOR SPECIFICATIONS.....	396
H.2	BASIC PARAMETER SETTINGS.....	397
H.3	USER SETTING TABLE.....	399

H.1 P1000 Bypass and Motor Specifications

H.1 P1000 Bypass and Motor Specifications

◆ P1000 Bypass Specifications

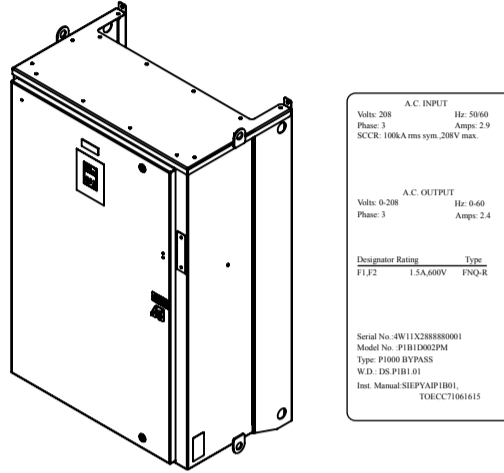

Items	Description
P1000 Bypass Model	P1B1
P1000 Bypass Serial Number	
P1000 Bypass Software Version	
Options used	
Date of Usage	

◆ Motor Specifications

■ Induction Motor

Items	Description	Items	Description
Manufacturer		Motor Rated Current (T1-04)	A
Model		Motor Base Frequency (T1-05)	Hz
Motor Rated Power (T1-02)	HP	Number of Motor Poles (T1-06)	
Motor Rated Voltage (T1-03)	V	Motor Base Speed (T1-07)	r/min

Note: These values must be entered as part of the Auto-Tuning process.

H.2 Basic Parameter Settings

Use the following tables to keep records of important parameters. Have this data available when contacting Yaskawa technical support.

◆ Quick Setting Parameters

Parameter Name	Setting Value	Memo
Application Preset	A1-06 =	
Input Voltage Setting	E1-01 =	
Maximum Voltage	E1-05 =	
Motor Rated FLA	E2-01 =	
Speed Reference Select	Z1-07 =	
Run Command Select	Z1-08 =	
HAND Mode Drive Speed Reference	Z1-09 =	
Set Time	Z1-37 =	
Serial Protocol	Z3-01 =	
Node Address	Z3-02 =	
Baud Rate	Z3-03 =	
Parity	Z3-04 =	
Fault Select	Z3-05 =	
Fault Time	Z3-06 =	
Rx to Tx Wait	Z3-07 =	
BAC Dev ID0	Z3-08 =	
BAC Dev ID1	Z3-09 =	

◆ Motor Setup

Motor Type	Item	Setting Value	Memo
Induction	Motor Rated Current	E2-01 =	
	Motor No-Load Current	E2-03 =	

◆ Multi-Function Digital Inputs

Terminal	Input Used	Setting Value and Function Name	Memo
TB2-1		Z2-01 =	
TB2-2		Z2-02 =	
TB2-3		Z2-03 =	
TB2-4		Z2-04 =	
TB2-5		Z2-05 =	
TB2-6		Z2-06 =	
TB2-7		Z2-07 =	
TB2-8		Z2-08 =	

◆ Analog Inputs

Terminal	Input Used	Setting Value and Function Name	Memo
A1		H3-02 =	
A2		H3-10 =	

H.2 Basic Parameter Settings

◆ Multi-Function Digital Outputs

Name	Terminal	Output Used	Setting Value and Function Name	Memo
DO-7	TB1-1, 2, 3		Z2-23 =	
DO-8	TB1-4, 5, 6		Z2-24 =	
DO-9	TB1-7, 8, 9		Z2-25 =	
DO-10	TB1-10, 11, 12		Z2-26 =	

◆ Monitor Outputs

Terminal	Output Used	Setting Value and Function Name	Memo
FM		H4-01 =	
AM		H4-04 =	

H.3 User Setting Table

Use the Verify Menu to see which parameters have been changed from their original default settings

RUN below the parameter number indicates that the parameter setting can be changed during run.

Parameter names in **bold face type** are included in the Quick Setting Group of parameters.

No.	Name	User Setting	No.	Name	User Setting
A1-06	Application Preset		b5-18	PI Setpoint Selection	
b1-03	Stopping Method Selection		b5-19	PI Setpoint Value	
b1-04	Reverse Operation Selection		b5-20	PI Setpoint Scaling	
b1-08	Run Command Selection while in Programming Mode		b5-34 RUN	PI Output Lower Limit	
b2-03	DC Injection Braking Time at Start		b5-35 RUN	PI Input Limit	
b2-04	DC Injection Braking Time at Stop		b5-36	PI Feedback High Detection Level	
b3-01	Speed Search Selection at Start		b5-37	PI Feedback High Detection Time	
b3-02	Speed Search Deactivation Current		b5-38	PI Setpoint User Display	
b3-03	Speed Search Deceleration Time		b5-39	PI Setpoint Display Digits	
b3-04	V/f Gain during Speed Search		b5-40	Frequency Reference Monitor Content during PI	
b3-05	Speed Search Delay Time		b5-46	PI Setpoint Monitor Unit Selection	
b3-06	Output Current 1 during Speed Search		b5-47	Reverse Operation Selection 2 by PI Output	
b3-10	Speed Search Detection Compensation Gain		C1-01 RUN	Acceleration Time 1	
b3-14	Bi-Directional Speed Search Selection		C1-02 RUN	Deceleration Time 1	
b3-17	Speed Search Restart Current Level		C1-09	Fast-Stop Time	
b3-18	Speed Search Restart Detection Time		C2-01	S-Curve Characteristic at Accel Start	
b3-19	Number of Speed Search Restarts		C2-02	S-Curve Characteristic at Accel End	
b3-24	Speed Search Method Selection		C4-01 RUN	Torque Compensation Gain	
b3-25	Speed Search Wait Time		C6-02	Carrier Frequency Selection	
b3-27	Start Speed Search Select		C6-05	Carrier Frequency Proportional Gain	
b5-01	PI Function Setting		d1-01 RUN	Frequency Reference 1	
b5-02 RUN	Proportional Gain Setting (P)		d1-02 RUN	Frequency Reference 2	
b5-03 RUN	Integral Time Setting (I)		d1-03 RUN	Frequency Reference 3	
b5-04 RUN	Integral Limit Setting		d1-04 RUN	Frequency Reference 4	
b5-06 RUN	PI Output Limit		d2-02	Frequency Reference Lower Limit	
b5-07 RUN	PI Offset Adjustment		d2-03	Master Speed Reference Lower Limit	
b5-08 RUN	PI Primary Delay Time Constant		d3-01	Jump Frequency 1	
b5-09	PI Output Level Selection		d3-02	Jump Frequency 2	
b5-10	PI Output Gain Setting		d3-03	Jump Frequency 3	
b5-11	PI Output Reverse Selection		d3-04	Jump Frequency Width	
b5-12	PI Feedback Loss Detection Selection		E1-01	Input Voltage Setting	
b5-13	PI Feedback Loss Detection Level		E1-03	V/f Pattern Selection	
b5-14	PI Feedback Loss Detection Time		E1-04	Maximum Output Frequency	
b5-15	PI Sleep Function Start Level				
b5-16	PI Sleep Delay Time				
b5-17	PI Accel/Decel Time				

H.3 User Setting Table

No.	Name	User Setting	No.	Name	User Setting
E1-05	Maximum Voltage		L2-01	Momentary Power Loss Operation Selection	
E2-01	Motor Rated Current		L2-03	Momentary Power Loss Minimum Baseblock Time	
E2-03	Motor No-Load Current		L2-05	Undervoltage Detection Level (Uv1)	
H1-03	Multi-Function Digital Input Terminal S3 Function Selection		L3-02	Stall Prevention Level during Acceleration	
H1-04	Multi-Function Digital Input Terminal S4 Function Selection		L3-03	Stall Prevention Limit during Acceleration	
H1-05	Multi-Function Digital Input Terminal S5 Function Selection		L3-04	Stall Prevention Selection during Deceleration	
H1-06	Multi-Function Digital Input Terminal S6 Function Selection		L3-06	Stall Prevention Level during Run	
H1-07	Multi-Function Digital Input Terminal S7 Function Selection		L3-11	Overvoltage Suppression Function Selection	
H2-01	Multi-Function Contact Output (Terminal M1-M2)		L3-25	Load Inertia Ratio	
H2-02	Multi-Function Contact Output 2 (Terminal M3-M4)		L5-01	Number of Auto Restart Attempts	
H2-03	Multi-Function Contact Output 3 (Terminal M5-M6)		L5-02	Auto Restart Fault Output Operation Selection	
H3-01	Terminal A1 Signal Level Selection		L5-03	Time to Continue Making Fault Restarts	
H3-02	Terminal A1 Function Selection		L5-04	Fault Reset Interval Time	
H3-03	<input type="checkbox"/> RUN Terminal A1 Gain Setting		L5-05	Fault Reset Operation Selection	
H3-04	<input type="checkbox"/> RUN Terminal A1 Bias Setting		L6-01	Torque Detection Selection 1	
H3-05	Terminal A3 Signal Level Selection		L6-02	Torque Detection Level 1	
H3-06	Terminal A3 Function Selection		L6-03	Torque Detection Time 1	
H3-07	<input type="checkbox"/> RUN Terminal A3 Gain Setting		L6-13	Motor Underload Protection Selection	
H3-08	<input type="checkbox"/> RUN Terminal A3 Bias Setting		L6-14	Motor Underload Protection Level at Minimum Frequency	
H3-09	Terminal A2 Signal Level Selection		L8-02	Overheat Alarm Level	
H3-10	Terminal A2 Function Selection		L8-05	Input Phase Loss Protection Selection	
H3-11	<input type="checkbox"/> RUN Terminal A2 Gain Setting		L8-06	Input Phase Loss Detection Level	
H3-12	<input type="checkbox"/> RUN Terminal A2 Bias Setting		L8-07	Output Phase Loss Protection	
H3-13	Analog Input Filter Time Constant		L8-09	Output Ground Fault Detection Selection	
H3-14	Analog Input Terminal Enable Selection		L8-38	Carrier Frequency Reduction Selection	
H3-16	Terminal A1 Offset		n1-01	Hunting Prevention Selection	
H3-17	Terminal A2 Offset		n1-02	Hunting Prevention Gain Setting	
H3-18	Terminal A3 Offset		n3-04	High-Slip Braking Overload Time	
H4-01	Multi-Function Analog Output Terminal FM Monitor Selection		n3-13	Overexcitation Deceleration Gain	
H4-02	<input type="checkbox"/> RUN Multi-Function Analog Output Terminal FM Gain		o1-01	Drive Mode Unit Motor Selection </>	
H4-03	<input type="checkbox"/> RUN Multi-Function Analog Output Terminal FM Bias		o1-02	User Monitor Selection after Power Up </>	
H4-04	Multi-Function Analog Output Terminal AM Monitor Selection		o1-03	Digital Operator Display Selection	
L1-01	Motor Overload Protection Selection		o1-09	Frequency Reference Display Units	
L1-02	Motor Overload Protection Time		o1-10	User-Set Display Units Maximum Value	
			o1-11	User-Set Display Units Decimal Display	
			o2-04	Drive Model Selection	
			o4-03	Cooling Fan Maintenance Operation Time Setting	
			o4-11	UB-09 to UB-16 Initialization	
			S1-01	Dynamic Audible Noise Control Selection	
			S1-02	Voltage Reduction Rate	
			S1-03	Voltage Restoration Level	
			S1-04	Voltage Restoration Complete Level	
			S1-05	Voltage Restoration Sensitivity Time Constant	
			S1-06	Voltage Restoration Time Constant at Impact	
			S2-01	<input type="checkbox"/> RUN Sequence Timer 1 Start Time	
			S2-02	<input type="checkbox"/> RUN Sequence Timer 1 Stop Time	

H.3 User Setting Table

No.	Name	User Setting	No.	Name	User Setting
S2-03 <input type="checkbox"/> RUN	Sequence Timer 1 Day Selection		Z1-07 <input type="checkbox"/> RUN	Speed Reference Select	
S2-04	Sequence Timer 1 Selection		Z1-08 <input type="checkbox"/> RUN	Run Command Select	
S2-05	Sequence Timer 1 Reference Source		Z1-09 <input type="checkbox"/> RUN	HAND Mode Drive Speed Reference	
S2-06 <input type="checkbox"/> RUN	Sequence Timer 2 Start Time		Z1-10 <input type="checkbox"/> RUN	Smoke Purge Preset Frequency Reference	
S2-07 <input type="checkbox"/> RUN	Sequence Timer 2 Day Selection		Z1-11 <input type="checkbox"/> RUN	2-Motor AND/OR Function Select	
S2-08 <input type="checkbox"/> RUN	Sequence Timer 2 Day Selection		Z1-12 <input type="checkbox"/> RUN	Run Delay Time	
S2-09	Sequence Timer 2 Selection		Z1-13 <input type="checkbox"/> RUN	Pre-Interlock Run Select	
S2-10	Sequence Timer 2 Reference Source		Z1-14 <input type="checkbox"/> RUN	Run Delay Frequency Reference	
S2-11 <input type="checkbox"/> RUN	Sequence Timer 3 Start Time		Z1-15 <input type="checkbox"/> RUN	Interlock Wait Time	
S2-12 <input type="checkbox"/> RUN	Sequence Timer 3 Stop Time		Z1-16	Energy Savings Mode Enable	
S2-13 <input type="checkbox"/> RUN	Sequence Timer 3 Day Selection		Z1-17 <input type="checkbox"/> RUN	Energy Savings Mode Frequency	
S2-14	Sequence Timer 3 Selection		Z1-18 <input type="checkbox"/> RUN	Energy Savings Mode Output Current Level	
S2-15	Sequence Timer 3 Reference Source		Z1-19 <input type="checkbox"/> RUN	Energy Savings Mode Frequency Reference Deadband	
S2-16 <input type="checkbox"/> RUN	Sequence Timer 4 Start Time		Z1-20 <input type="checkbox"/> RUN	Energy Savings Mode Output Frequency Deadband	
S2-17 <input type="checkbox"/> RUN	Sequence Timer 4 Stop Time		Z1-21 <input type="checkbox"/> RUN	Energy Savings Mode Output Current Deadband	
S2-18 <input type="checkbox"/> RUN	Sequence Timer 4 Day Selection		Z1-22 <input type="checkbox"/> RUN	Energy Savings Mode Time	
S2-19	Sequence Timer 4 Selection		Z1-23 <input type="checkbox"/> RUN	Energy Savings Mode Frequency Reference Increase	
S2-20	Sequence Timer 4 Reference Source		Z1-24 <input type="checkbox"/> RUN	Contactorm Open Delay Time	
T1-00	Motor 1/Motor 2 Selection		Z1-25 <input type="checkbox"/> RUN	Contactorm Close Delay Time	
T1-01	Auto-Tuning Mode Selection		Z1-27 <input type="checkbox"/> RUN	Phase Loss Brownout Voltage Level	
T1-02	Motor Rated Power		Z1-28 <input type="checkbox"/> RUN	Phase Loss Brownout Detection Time	
T1-03	Motor Rated Voltage		Z1-29 <input type="checkbox"/> RUN	Phase Loss Blackout Voltage Level	
T1-04	Motor Rated Current		Z1-30 <input type="checkbox"/> RUN	EF0 Fault Delay Time	
T1-05	Motor Base Frequency		Z1-31 <input type="checkbox"/> RUN	Loss of Load Detection Enable	
T1-06	Number of Motor Poles				
T1-07	Motor Base Speed				
T1-11	Motor Iron Loss				
Z1-01 <input type="checkbox"/> RUN	Initialize				
Z1-02 <input type="checkbox"/> RUN	Password				
Z1-03 <input type="checkbox"/> RUN	Password Change				
Z1-05 <input type="checkbox"/> RUN	Auto Transfer to Bypass Upon Drive Fault				
Z1-06 <input type="checkbox"/> RUN	Power-Up Mode				

Quick Reference Sheet

H.3 User Setting Table

No.	Name	User Setting	No.	Name	User Setting
Z1-32 RUN	Loss of Load Drive Frequency		Z2-11 RUN	Digital Input 3 Invert Select	
Z1-33 RUN	Loss of Load Drive Output Current		Z2-12 RUN	Digital Input 4 Invert Select	
Z1-34 RUN	Loss of Load Drive Time		Z2-13 RUN	Digital Input 5 Invert Select	
Z1-35 RUN	Loss of Load Bypass Output Current		Z2-14 RUN	Digital Input 6 Invert Select	
Z1-36 RUN	Loss of Load Bypass Time		Z2-15 RUN	Digital Input 7 Invert Select	
Z1-37 RUN	Set Time		Z2-16 RUN	Digital Input 8 Invert Select	
Z1-38 RUN	HOA Source Select		Z2-23 RUN	Digital Output 7 Function Select	
Z1-39 RUN	Drive/Bypass Source Select		Z2-24 RUN	Digital Output 8 Function Select	
Z1-41	HAND Speed Reference Selection		Z2-25 RUN	Digital Output 9 Function Select	
Z1-50	Bypass Unbalance Current Detection Level		Z2-26 RUN	Digital Output 10 Function Select	
Z1-51	Bypass Unbalance Trip Time Detection Level		Z2-31	Safety Open Message Selection	
Z1-52	Bypass Phase Rotation		Z3-01 RUN	Serial Communications Protocol Select	
Z1-53	Load Verification Fault Select <4>		Z3-02 RUN	Serial Communications Node Address Select	
Z1-54	LCD Contrast Control <4>		Z3-03 RUN	Serial Communications Baud Rate Select	
Z1-55	Welded K3 Contactor Fault Select <4>		Z3-04 RUN	Serial Communications Parity Select	
Z1-60	Black Out Selection <1>		Z3-05 RUN	Serial Communications Fault Select	
Z1-61	Restart Delay <1>		Z3-06 RUN	Serial Communications Fault Time Select	
Z2-01 RUN	Digital Input 1 Function Select		Z3-07 RUN	Serial Communications Receive to Transmit Wait Time <1>	
Z2-02 RUN	Digital Input 2 Function Select		Z3-08 RUN	BACnet Device Object Identifier 0 <2>	
Z2-03 RUN	Digital Input 3 Function Select		Z3-09 RUN	BACnet Device Object Identifier 1	
Z2-04 RUN	Digital Input 4 Function Select		Z3-12	Network Digital Input Selection	
Z2-05 RUN	Digital Input 5 Function Select		Z4-01 RUN	IP Address 1	
Z2-06 RUN	Digital Input 6 Function Select		Z4-02 RUN	IP Address 2	
Z2-07 RUN	Digital Input 7 Function Select		Z4-03 RUN	IP Address 3	
Z2-08 RUN	Digital Input 8 Function Select				
Z2-09 RUN	Digital Input 1 Invert Select				
Z2-10 RUN	Digital Input 2 Invert Select				

H.3 User Setting Table

No.	Name	User Setting	No.	Name	User Setting
Z4-04 <input type="checkbox"/> RUN	IP Address 4		Z4-14 <input type="checkbox"/> RUN	Duplex Mode Setting	
Z4-05 <input type="checkbox"/> RUN	Subnet Mask 1		Z4-15 <input type="checkbox"/> RUN	Speed Mode Setting	
Z4-06 <input type="checkbox"/> RUN	Subnet Mask 2		Z4-16 <input type="checkbox"/> RUN	Timeout	
Z4-07 <input type="checkbox"/> RUN	Subnet Mask 3		Z4-17 <input type="checkbox"/> RUN	Speed Scaling	
Z4-08 <input type="checkbox"/> RUN	Subnet Mask 4		Z4-18 <input type="checkbox"/> RUN	Current Scaling	
Z4-09 <input type="checkbox"/> RUN	Gateway Address 1		Z4-19 <input type="checkbox"/> RUN	Torque Scaling	
Z4-10 <input type="checkbox"/> RUN	Gateway Address 2		Z4-20 <input type="checkbox"/> RUN	Power Scaling	
Z4-11 <input type="checkbox"/> RUN	Gateway Address 3		Z4-21 <input type="checkbox"/> RUN	Voltage Scaling	
Z4-12 <input type="checkbox"/> RUN	Gateway Address 4		Z4-22 <input type="checkbox"/> RUN	Time Scaling	
Z4-13 <input type="checkbox"/> RUN	Address Startup Mode				

- <1> Available in bypass controller software versions VST800401 and later
- <2> This parameter will only appear when Bacnet is selected. (Z3-01= 3)
- <4> Available in bypass controller software versions VST800400 and later.

H.3 User Setting Table

This Page Intentionally Blank

Index

+	Auto-Tuning Codes.....	219
+V.....	Auto-Tuning Errors.....	193
	Auto-Tuning Fault Codes.....	77
Numerics	Auto-Tuning Fault Detection.....	219
5th Most Recent Fault.....	Auto-Tuning Fault Solutions.....	219
	Auto-Tuning for Induction Motors.....	76
A	Auto-Tuning Input Data.....	76, 77
A/D Conversion Error.....	Auto-Tuning Interruption Codes.....	77
A1.....	Auto-Tuning Mode Selection.....	79, 278
A1-04.....		
A1-05.....	B	
A2.....	BACnet Configuration.....	310
A3.....	BACnet Objects Supported.....	318
AC.....	BACnet Serial Communication.....	314
Accel/Decel Time.....	BACnet Setup Parameters.....	314
Acceleration Error.....	BACnet Specifications.....	311
Acceleration Time.....	Baseblock.....	210
Adjusted Slip Calculation Error.....	Basic Auto-Tuning Preparations.....	76
AL02.....	BAS Interlock Open.....	209
AL03.....	bAT.....	194
AL04.....	bb.....	210
AL09.....	Bi-Directional Speed Search Selection.....	89
AL13.....	Binary Input Objects.....	320
AL14.....	Binary Output Objects.....	321
AL16.....	Binary Value Objects.....	321
Alarm Causes and Solutions.....	Black Out Selection.....	176
Alarm Outputs for Maintenance Monitors.....	Braking Resistor Overheat Protection.....	248
Alarm Register 007FH Contents.....	Braking Torque.....	247
Alarms and Errors.....	Braking Transistor.....	247
ALM LED Light.....	Broadcast Messages.....	352
Altitude.....	bUS.....	194, 210
Ambient Temperature.....	Bypass Controller Active Faults Register 1.....	280
Analog Filter Time Constant.....	Bypass Controller Active Faults Register 2.....	281
Analog Input Objects.....	Bypass Controller Status Register 1.....	280
Analog Input Terminal Enable Selection.....	Bypass Controller Status Register 2.....	280
Analog Output Objects.....	Bypass Control System.....	162
Analog Value Objects.....	Bypass Device Type.....	174
Apogee FLN Cable Loss Behavior.....	Bypass Digital Input Invert Settings.....	179
APOGEE FLN Cable Specifications.....	Bypass Digital Input States.....	280
APOGEE FLN Communications.....	Bypass Digital Input Terminal Settings.....	177, 179
APOGEE FLN Point Number Summary.....	Bypass Digital Output States.....	280
AUTO Key.....	Bypass Faults with Apogee Configuration.....	376
AUTO LED and HAND LED Indications.....	Bypass Nameplate.....	29
AUTO Light.....	Bypass Operations by BACnet.....	317
Auto Restart Fault Output Operation Selection.....	Bypass Operations by MEMOBUS/Modbus.....	336
Auto Restart Operation Selection.....	Bypass Operations by N2.....	385
Auto-Tuning.....	Bypass Parameters.....	162

Index

Bypass Phase Rotation	174	CPF23	196
Bypass Unbalanced Current Detection Level	174	CPF24	196
Bypass Unbalance Trip Time Detection Level	174	CRC-16	338
C		CRC-16 Checksum Calculation Example	339
C2-01 and C2-02	190	CrST	211
C4-01	190	Cumulative Operation Time	285
C4-02	190	Cumulative Operation Time at 5th Most Recent Fault	284
C6-02	190	Cumulative Operation Time at Most Recent Fault	284
Cable Length Between Bypass and Motor	44	Cumulative Operation Time at Previous Fault	283
Cable Loss Behavior Summary	373	Current Alarm	212
Cable Loss Pre-set Speed	384	Current Detection Error	220
Cable Specifications for APOGEE FLN	366	Current Detection Speed Search	86
CALL	211	Current Fault	281, 283
Cannot Change Parameter Settings	223	Current Fault Hour Minute	281
Cannot Reset	211	Current Fault Month Day	281
Capacitor Maintenance	286	Current Fault Year	281
Capacitor Maintenance Time	213	Current Offset Fault	194
Carrier Frequency	244, 245, 246	Customer Safety	214
Carrier Frequency and Current Derating	251	Cyclic Redundancy Check	338
Carrier Frequency Proportional Gain	105	D	
Carrier Frequency Reduction	272	d3-01 through d3-04	190
Carrier Frequency Reduction Selection	147	Daily Inspection	234
Carrier Frequency Selection	44, 190	DC Bus Overvoltage	214
Carrier Frequency Setting Error	217	DC Bus Undervoltage	120, 207
CE	194, 211	DC Bus Voltage	282
CE Low Voltage Directive Compliance	360	DC Bus Voltage at Previous Fault	283
CE mark	360	DC Injection Braking Current	85
Changing Parameter Settings or Values	66	DC Injection Braking Input Timing Diagram	117
Coast to stop	83	DC Injection Braking Start Frequency	85
Coast with Timer	84	DC Injection Braking Time at Start	85
CoF	194	DC Injection Braking Time at Stop	85
Command Messages from Master to Bypass	337, 389	DC Injection Braking to Stop	83
Communication Errors	326	D Control	91
Communication Option Card Reference	287	Deceleration Time	103
Communication Parity Selection	383	Derivative Time (D)	94
Communications Error Operation Selection	114	Device Object	323
Communications Timing	337, 389	Diagnosing and Resetting Faults	221
Connecting to a BACnet Network	312	Digital Outputs	117
Connecting to an N2 Network	381	DIP Switch S2	33
Control Board Connection Error	195, 196	Down Arrow Key	59
Control Circuit Error	195, 196	Drive/kVA Selection	274
Control Mode	282	Drive Capacity Setting Fault	216
Control Mode Features	27	Drive Derating Data	38
Control Mode Selection	27	Drive Faults with Apogee Configuration	376
Control Power Supply Voltage Fault	207	Drive Mode	66
Cooling Fan Maintenance	286	Drive Model Selection	152
Cooling Fan Maintenance Setting (Operation Time)	275	Drive Mode Unit Monitor Selection	150
Cooling Fan Maintenance Time	212	Drive Nameplate	28
Cooling Fan Operation Time	286	Drive Operation Status at Previous Fault	283
Cooling Fan Operation Time Setting	152	Drive Overheat Pre-Alarm	123
CPF00 or CPF01	195	Drive Overheat Warning	213
CPF02	195	Drive Overload	204
CPF03	195	Drive Ready	120
CPF06	195	Drive Specifications	247
CPF07	195	Drive Status	282
CPF08	195	Drive Unit Signal Fault	196
CPF20	196	Drive Watt Loss Data	249
CPF21	196	During Baseblock	123
CPF22	196	During Baseblock (N.O.)	120

During Fast Stop	124	Fault Restart	139
During Reverse	123	Faults	191, 192
During Run	118	Fault Trace	161, 221
During Run 2	123	FB01	197
During Speed Search	124	FB02	197
Dynamic Audible Noise Control Function Selection	276	FB03	197
Dynamic Audible Noise Control Selection	154	FB05	197
Dynamic Noise Control Function	154	FB06	198
E		FB07	198
E1-03	226	FB08	198
E1-04	226	FB09	198
E2-03	219	FB10	199
EEPROM Memory Data Error	195	FB11	199
EEPROM Write Error	196	FB12	199
EF	211	FB13	199
EF0	196, 211	FB14	199
Electronic Bypass Control Terminal Board A2	46	FB15	200
EMC Filter Installation	360	FB16	200
EMC Guidelines	360	FbH	200, 212
EMC Guidelines Compliance	360	FbL	200, 212
End3	219	FE	47
End4	219	Ferrule Dimensions	48
End5	219	Ferrule Terminal Types and Sizes	48
End7	219	Ferrule-Type Wire Terminals	48
Enter Command	325, 355	Fine-Tuning V/f Control	190
Enter Command Types	325	Fn1	200
Enter Data from the Motor Nameplate	78	Forward/Reverse Run Command Input Error	211
ENTER Key	59	Frequency Accuracy (Temperature Fluctuation)	247
Er-01	219	Frequency Control Range	247
Er-02	219	Frequency Detection 1	119
Er-03	220	Frequency Detection 2	120
Er-04	220	Frequency Detection 3	122
Er-05	220	Frequency Detection 4	122
Er-08	220	Frequency Reference	106, 282
Er-09	220	Frequency Reference at Previous Fault	283
Er-12	220	Frequency Reference at Reference Loss	139, 271
Err	196	Frequency Reference Display Units	151, 274
European Standards	360	Frequency Reference from MEMOBUS/Modbus Comm.	286
Excessive Motor Oscillation and Erratic Rotation	227	Frequency Reference Inputs	47
Excessive PI Feedback	200, 212	Frequency Reference Loss	121
External Fault from Bypass Controller Detection Selection	114	Frequency Reference Loss Detection Selection	139, 271
External Fault from Bypass Controller Operation Selection	114	Frequency Reference Lower Limit	107
External Interlock	54	Frequency Reference Monitor Content During PID	99
EZ Minimum Speed	101	Frequency Reference Selection 1	224
EZ Sleep Level	102	Frequency Reference Setting / Decimal Display	274
EZ Sleep Unit	102	Frequency Reference Setting and User-Set Display	274
EZ Wake-up Level	102	Frequency Reference Source Selection	286
F		Frequency Reference Upper Limit	107
FAn	196	Frequency Setting Resolution	247
Fast Stop Time	103	Frequency Setting Signal	247
Fault Causes and Solutions	194	Function Code	338
Fault Detection	194	Functions for Terminals S1 to S8	115
Fault Displays	194, 209	G	
Fault History	161	GF	200
Fault Reset Command Active	121	Ground Fault	200
Fault Reset Interval Time	142, 271	Ground Terminal	33
Fault Reset Methods	191	Ground Wiring	44
Fault Reset Operation Selection	142, 271		

Index

H

H3-01	52
H3-02	226
H3-05	52
H3-09	52
H3-13	190, 227
H3 Multi-Function Analog Input Settings	268
HAND Key	59
HAND Light	59
HAND Speed Reference Selection	173
HCA	212
Heatsink Overheat	202, 213
Heatsink Temperature	286
High Slip Braking	148
High-slip Braking oL	204
High Slip Braking Overload Time	148
High-Slip Braking Overload Time	273
HOA Keypad	32
HOA Keypad Battery Voltage Low	194
HOA Keypad Connection Fault	205
HOA Keypad Display Selection	150, 274
HOA Keypad Functions	152
HOA Keypad Menu Structure	64
HOA Keypad Parameter Display	64
Humidity	38
Hunting Prevention	148
Hunting Prevention Gain	190
Hunting Prevention Gain Setting	148, 273
Hunting Prevention Selection	148, 273
Hybrid IC Failure	196

I

I/O Connections	51
IGBT Maintenance	286
IGBT Maintenance Time (50%)	213
IGBT Maintenance Time (90%)	214
Initialization	82
Input Current	244, 245, 246
Input Phase Detection Level	272
Input Phase Loss	205
Input Phase Loss Detection Level	146
Input Phase Loss Protection Selection	145, 272
Input Terminal Status	282
Input Terminal Status at Previous Fault	283
Input Voltage Setting	109
Inrush Prevention Circuit Fault	207
Inspection	234, 235
Installation Area	38
Installation Environment	38
Integral Limit Setting	94
Integral Time Setting (I)	94
Interlock Open	212
Internal Cooling Fan Alarm	124
inTLK	212

J

Jumper S1	33
Jumper S1 Settings	52
Jump Frequency	190
Jump Frequency Width	108

K

Keys and Displays on the HOA Keypad	59
kWh	286
kWh, Lower 4 Digits	286
kWh, Upper 5 Digits	286

L

L3-01 through L3-06	190
L3-02	226, 228
L3-04	227
L3-06	226
L3-11	190
LCD Contrast Control	176
LCD Display	60
LED Check	286
LF	201
LF2	201
Line-to-Line Resistance Error	220
Load Inertia Ratio	139, 271
Load Verification Fault Select	175
Loopback Test	340
Loss of Load	209
Loss of Reference Function	139
Low Voltage Directive	360
LT-1	212
LT-2	213
LT-3	213
LT-4	213

M

Main Circuit Terminal	33
Main Circuit Terminal and Motor Wiring	43
Main Circuit Wiring	43
Main Input Circuit Wiring	33
Maintenance	237
Maintenance Alarms	238
Maintenance Monitors	161
Maintenance Monitor Settings	152
Maintenance Period	123
Master Speed Reference Lower Limit	107
Maximum Applicable Motor Capacity	244, 245, 246
Maximum Output Frequency	244, 245, 246
Maximum Output Voltage	244, 245, 246
Maximum Voltage	112
MEMOBUS/Modbus Comm. Test Mode Complete	214
MEMOBUS/Modbus Communication Error	194, 211
MEMOBUS/Modbus Communications Reference	287
MEMOBUS/Modbus Data Table	342
MEMOBUS/Modbus Error Codes	356
MEMOBUS/Modbus Setup Parameters	334
MEMOBUS/Modbus Specifications	331
Message Format	338
Metasys N2 Point Database	390
Minimum Wait Time for Sending Messages	337, 389
Minor Alarms	192
Minor Fault	219
Minor Fault and Alarm Displays	193
Minor Faults	192
Minor Faults and Alarms	191, 192
Model Number and Nameplate Check	28

Modes	66	N2 Setup Parameters	383
Modified Constants	67	N2 Specifications	380
Momentary Overcurrent Protection	247	Network Digital Input Select	182
Momentary Power Loss Minimum Baseblock Time	136, 270	Network Termination	312, 333, 382
Momentary Power Loss Operation Selection	88, 270	No-Load Current Alarm	219
Momentary Power Loss Ride-Thru	135, 248	No-Load Current Error	220
Momentary Power Loss Ride-Thru Time	136, 270	Notes on Stationary Auto-Tuning	77
Monitor Parameters	131, 280	nSE	201
Most Recent Fault	284	Number of Auto Restart Attempts	140, 271
Motor 1 Parameters	113	Number of Motor Poles	80, 278
Motor Base Frequency	78, 80, 278	Number of Run Commands	285
Motor Base Speed	80, 279	Number of Speed Search Restarts	90
Motor Data Error	219	O	
Motor Does Not Rotate	224	oC	201
Motor Hunting and Oscillation Control Parameters	190	oFA00	202
Motor Iron Loss	80, 279	OFF button Input	220
Motor is Too Hot	225	OFF Key	59
Motor No-Load Current	113	oH	202, 213
Motor Overheat	213	oH1	203
Motor Overheat Alarm (PTC Input)	203	oH2	213
Motor Overheat Fault (PTC Input)	203	oH3	203, 213
Motor Overload	203	oH4	203
Motor Overload Estimate (oL1)	286	oH Pre-Alarm Time Limit	124
Motor Overload Protection Selection	134, 270	oL1	203
Motor Overload Protection Time	135, 270	oL2	204
Motor Performance Fine-Tuning	190	oL3	204, 214
Motor Poles	78	oL7	204
Motor Protection	134	oPE	216
Motor Pull Out or Step Out Detection	206	oPE01	216
Motor q-Axis Current at Previous Fault	284	oPE02	216
Motor Rated Current	78, 80, 113, 278	oPE03	216
Motor Rated Power	79, 278	oPE05	217
Motor Rated Voltage	78, 79, 278	oPE07	217
Motor Rotates in One Direction Only	225	oPE09	217
Motor Stalls during Acceleration or With Large Loads	226	oPE10	217
Motor Underload	207	oPE11	217
Motor Underload Protection Level at Minimum Frequency	145, 272	oPE28	218
Motor Underload Protection Selection	145, 272	oPE Fault Parameter	283
Motor Wiring	43	Operation Errors	191, 193
Multi-Function Analog Input Selection Error	217	Operation Status Monitors	161
Multi-Function Analog Input Terminal Settings	125	Operator Related Settings	150
Multi-Function Analog Outputs	131	oPr	205
Multi-Function Analog Output Terminal AM Bias	131	Option Card Connection Error at Option Port CN5	202
Multi-Function Analog Output Terminal AM Gain	131	Option card connector (CN5-A)	33
Multi-Function Analog Output Terminal AM Monitor Selection	131	Option card connector (CN5-B)	33
Multi-Function Analog Output Terminal AM Signal Level Selection	132	Option card connector (CN5-C)	33
Multi-Function Analog Output Terminal FM Bias	131	Option Card External Fault	196, 211
Multi-Function Analog Output Terminal FM Gain	131	Option Communication Error	194, 210
Multi-Function Analog Output Terminal FM Monitor Selection	131	Option Frequency Reference	286
Multi-Function Analog Output Terminal FM Signal Level Selection	132	Oscillation or Hunting	227
Multi-Function Digital Input Terminal Settings	115	Output Current	282
Multi-Function Digital Outputs	117	Output Current 1 during Speed Search	89
Multi-Function Input Selection Error	216	Output Current at Previous Fault	283
Multiple Connection Diagram	366, 382	Output Current Imbalance	201
Multi-Step Speed Selection	106	Output Frequency	282
N		Output Frequency after Soft Start	283
n1-02	190	Output Frequency at Previous Fault	283
N2 Configuration	380	Output Frequency is not as High as Frequency Reference	228
N2 Serial Communication	383	Output Frequency Resolution	247

Index

Output Ground Fault Detection Selection	146, 272	PID Output Reverse Selection 2	100
Output Phase Loss	201	PID Primary Delay Time Constant	94
Output Phase Loss Protection	272	PID Setpoint	287
Output Phase Loss Protection Selection	146	PID Setpoint Display Digits	99
Output Power	282	PID Setpoint Input Methods	91
Output Power at Previous Fault	283	PID Setpoint Monitor Unit Selection	100
Output Terminal Status	282	PID Setpoint Scaling	98
Output Terminal Status at Previous Fault	283	PID Setpoint Selection	98
Output Voltage at Previous Fault	283	PID Setpoint User Display	99
Output Voltage Detection Fault	208, 215	PID Setpoint Value	98
Output Voltage Reference	282	PID Sleep	97
ov	205, 214	PID Sleep Delay Time	98
Overcurrent	201	PID Sleep Function Start Level	97
Overexcitation Deceleration Gain	149, 273	PI Feedback Loss	200, 212
Overheat 1 (Heatsink Overheat)	203	Powering Up the Drive	70
Overheat Alarm Level	145, 272	Power Ratings	244
Overload Protection	247	Predefined V/f Patterns	109
Overload Tolerance	244, 245, 246	Preface	14
Overtorque 1	214	Preparing the Ends of Shielded Cables	51
Overtorque Detection 1	204	Present Value Access	318
Overtorque Detection Operation	143	Preset Reference Timing Diagram	106
Overvoltage	205	Previous Fault	281, 283
Overvoltage Protection	247	Previous Fault Hour Minute	281
Overvoltage Suppression Function Selection	138	Previous Fault Month Day	281
ov Suppression Function Selection	271	Previous Fault Year	281
P		Programmable Run Timers for Real Time Clock (RTC)	155
Parameter Range Setting Error	216	Programming Errors	216
Parameter Settings	66	Programming Mode	66
Parameter Settings for APOGEE FLN	364	Proportional Gain Setting (P)	94
Parameters to Minimize Motor Hunting and Oscillation	190	Protective cover to prevent miswiring	33
PASS	214	Q	
Peak Hold Current	286	Quick Setting Group	68
Peak Hold Output Frequency	286	Quick Setting Group Parameters	68
Performance Life	237	R	
Performance Life Monitors Maintenance Monitors	237	R/L1	43
Periodic Inspection	235	Ramp to stop	83
Periodic Maintenance	237	Rated Current Setting Alarm	219
PF	205	Rated Output Current	244, 245, 246
PID Accel/Decel Time	98	Rated Slip Error	220
PID Block Diagram	93	Rated Voltage, Rated Frequency	244, 245, 246
PID Control	90	Reading BACnet Bypass Parameters	325
PID Feedback 1	287	Reading Drive MEMOBUS/Modbus Register Contents	340
PID Feedback High Detection Level	97	Real Time Clock	155
PID Feedback High Detection Time	97	Replacement Parts	237
PID Feedback Input Methods	92	RESET Key	59
PID Feedback Loss Detection Selection	96	Resistance Tuning Error	219
PID Feedback Low Detection Level	96	Response Messages from Drive to Master	337, 389
PID Feedback Low Detection Time	96	Restart Delay	176
PID Fine Tuning	101	Restart Enabled	123
PID Input (feedback)	287	Reverse Operation Selection	84
PID Input Limit	99	Rotational Auto-Tuning for V/f Control	76
PID Monitors	161	Run Active during Restart Delay	209
PID Offset Adjustment	94	Run Command/Frequency Reference Source Selection Error	217
PID Output	287	Run Command Selection	224
PID Output Gain Setting	95	Run Command Source Selection	287
PID Output Level Selection	95	S	
PID Output Limit	94	S: Special Parameters	154, 276
PID Output Lower Limit	99	S/L2	43
PID Output Reverse Selection	95		

S1: Dynamic Noise Control Function.....	276	Speed Agree 2.....	121
S2: Sequence Timers.....	155, 276	Speed Control Range.....	247
SAFE.....	214	Speed Estimation Type Speed Search.....	87
Safety Open Message Selection.....	180	Speed Search.....	83
Safety Standard.....	248	Speed Search Deactivation Current.....	88
S-Curve Characteristics.....	103, 190	Speed Search Deceleration Time.....	89
SE.....	214	Speed Search Delay Time.....	89
Selecting the Type of Auto-Tuning.....	77	Speed Search Detection Compensation Gain.....	89
Sequence Timer 1.....	155	Speed Search Method Selection.....	90
Sequence Timer 1 Day Selection.....	276	Speed Search Restart Current Level.....	90
Sequence Timer 1 Reference Source.....	276	Speed Search Restart Detection Time.....	90
Sequence Timer 1 Selection.....	276	Speed Search Selection at Start.....	88
Sequence Timer 1 Start Time.....	276	Speed Search Wait Time.....	90
Sequence Timer 1 Stop Time.....	276	Stall Prevention.....	136, 190
Sequence Timer 2 Day Selection.....	277	Stall Prevention Level during Acceleration.....	136, 270
Sequence Timer 2 Reference Source.....	277	Stall Prevention Level during Run.....	138, 271
Sequence Timer 2 Selection.....	277	Stall Prevention Limit during Acceleration.....	137, 270
Sequence Timer 2 Start Time.....	277	Stall Prevention Selection during Deceleration.....	137, 271
Sequence Timer 2 Stop Time.....	277	Starting Torque.....	247
Sequence Timer 3 Day Selection.....	277	Stationary Auto-Tuning.....	77
Sequence Timer 3 Reference Source.....	277	Stationary Auto-Tuning for Line-to-Line Resistance.....	76
Sequence Timer 3 Selection.....	277	Status Display.....	70
Sequence Timer 3 Start Time.....	277	STo.....	206
Sequence Timer 3 Stop Time.....	277	Stopping Method after Communication Error.....	133
Sequence Timer 4 Day Selection.....	278	Stopping Method Selection.....	83
Sequence Timer 4 Reference Source.....	278	Storage Temperature.....	38
Sequence Timer 4 Selection.....	278	Supported Properties of Objects.....	318
Sequence Timer 4 Start Time.....	277	Surrounding Area.....	38
Sequence Timer 4 Stop Time.....	278	Swing PWM.....	104
Sequence Timer Error.....	218	T	
Sequence Timers 1/2/3/4 Reference Source.....	157	T/L3.....	43
Sequence Timers 1/2/3/4 Selection.....	157	T1-03.....	78
Sequence Timers 1 to 4 Day Selection.....	156	T1-04.....	78
Sequence Timers 1 to 4 Start Time.....	156	T1-05.....	78
Sequence Timers 1 to 4 Stop Time.....	156	T1-06.....	78
Sequence Timers 2 to 4.....	156	T1-07.....	78, 79
SEr.....	206	TdE.....	206
Serial Comm Fault.....	209	Terminal A1 Bias Setting.....	125
Serial Communication Fault Detection Selection.....	384	Terminal A1 Function Selection.....	125
Serial Communications Baud Rate Select.....	383	Terminal A1 Gain Setting.....	125
Serial Communications Cable Connection Terminal (TB3) ..	312, 332, 381	Terminal A1 Signal Level Selection.....	124
Serial Communications Fault Time Select.....	384	Terminal A2 Bias Setting.....	128
Serial Communications Node Address Select.....	383	Terminal A2 Function Selection.....	127
Serial Communications Protocol Select.....	383	Terminal A2 Gain Setting.....	128
Serial Communications Receive to Transmit Wait Time.....	384	Terminal A2 Signal Level Selection.....	127
Serial Communication Terminals.....	48	Terminal A3 Bias Setting.....	127
Serial Communication Transmission Error.....	211	Terminal A3 Function Selection.....	127
Setup Mode.....	68	Terminal A3 Gain Setting.....	127
Shielded Twisted-Pair Cables.....	51	Terminal A3 Signal Level Selection.....	127
Simplified Setup Using the Quick Setting Group.....	68	Terminal Board.....	33
Slave Address.....	338	Terminal Board Connection Error.....	195
Smoke Purge in Bypass.....	209	Terminal Board Connector.....	33
Smoke Purge in Drive.....	209	Test Run.....	76, 79
Soft Charge Bypass Relay Maintenance.....	286	Through Mode.....	121
Soft Charge Bypass Relay Maintenance Time.....	213	TIM.....	206
Soft Starter Speed Reference at Previous Fault.....	284	Time Data Error.....	206
Software No. (Flash).....	283	Time Not Set.....	206
Software No. (ROM).....	283	Time to Continue Making Fault Restarts.....	271
Software version.....	29	Too Many Speed Search Restarts.....	206
Speed Agree 1.....	118		

Index

Torque Compensation Gain	104, 190	Voltage Restoration Time Constant at Impact	155, 276
Torque Compensation Primary Delay Time	190	W	
Torque Detection	130	W/T3.....	43
Torque Detection 1	121	Waiting for Run	215
Torque Detection Level 1.....	144, 272	Warranty Information	24
Torque Detection Selection 1	143, 272	Watt Hour Pulse Output	124
Torque Detection Time 1	144, 272	Watt Loss Data	249
Troubleshooting without Fault Display	223	Welded K3 Contactor Fault Select	176
TrPC	214	Wiring Distance.....	105
Tuning Errors.....	191	Wiring the Control Circuit Terminal.....	50
Types of Alarms, Faults, and Errors	191	Writing BACnet Bypass Parameters	325
Types of Auto-Tuning for Induction Motors.....	76	Writing to Multiple Registers	341
U		WrUn	215
U/T1	43	Z	
U1-01	226	Z: Bypass Parameters	162
U1-07	224	Zero Speed.....	118
U2-oo, U3-oo, and UB-oo Initialization	152		
UL3	206, 215		
UL6	207, 215		
UL and CSA Standards	361		
UL Standards Compliance.....	43		
Undertorque Detection 1.....	206, 215		
Undertorque Detection 6.....	215		
Undertorque Detection Operation	143		
Undervoltage	215		
Undervoltage 3	207		
Undervoltage 3 (Soft-Charge Circuit Fault).....	207		
Undervoltage Detection Level (Uv1)	136, 270		
Undervoltage Protection	247		
Unexpected Noise from Connected Machinery.....	227		
Unit Code	152		
Up/Down Command Operation.....	116		
Up Arrow Key.....	59		
User Monitor Selection after Power Up	150		
User-Set Display Units Decimal Display.....	152		
User-Set Display Units Maximum Value.....	152		
User-Set Speed Agree 1.....	119		
User-Set Speed Agree 2.....	121		
Uv	215		
Uv1	207		
Uv2	207		
Uv3	207		
V			
V/f Characteristics	247		
V/f Control.....	27		
V/f Control Mode Tuning	190		
V/f Control Mode Tuning Parameters	190		
V/f Data Setting Error.....	217		
V/f Gain During Speed Search.....	89		
V/f Pattern Selection	226		
V/T2	43		
Verifying Parameter Changes	67		
voF	208, 215		
Voltage drop calculation formula.....	43		
Voltage Reduction Rate.....	154, 276		
Voltage Restoration Complete Level	155, 276		
Voltage Restoration Level.....	154, 276		
Voltage Restoration Sensitivity Time Constant	155, 276		

This Page Intentionally Blank

Revision History

The revision dates and the numbers of the revised manuals appear on the bottom of the back cover.

MANUAL NO. SIEP YAIP1B 01A
 Published in U.S.A. April 2014 14-1 1

└─ Revision number
 └─ Date of original publication
 └─ Date of publication

Date of Publication	Revision Number	Section	Revised Content
April 2023	<4>	All	Revision: Removed DeviceNet and Profibus options
April 2018	<3>	All	Updated documentation to support bypass controller software version VST800401.
December 2016	<2>	All	Revision: Updated documentation to support bypass controller software versions VST800298, VST800299, and VST800400
April 2014	<1>	Chapter 7	Revision: Corrected estimated performance life section
January 2014	-	-	First Edition. This manual supports bypass controller software version VST800297 and drive software version PRG: 8502

This Page Intentionally Blank

YASKAWA AC Drive P1000 Bypass

AC Drive Bypass for Industrial Fans and Pumps

Technical Manual

YASKAWA AMERICA, INC.

2121 Norman Drive South, Waukegan, IL 60085, U.S.A.
Phone: (800) YASKAWA (927-5292) or 1-847-887-7000 Fax: 1-847-887-7310
<http://www.yaskawa.com>

DRIVE CENTER (INVERTER PLANT)

2-13-1, Nishimiyaichi, Yukuhashi, Fukuoka, 824-8511, Japan
Phone: 81-930-25-3844 Fax: 81-930-25-4369
<http://www.yaskawa.co.jp>

YASKAWA ELECTRIC CORPORATION

New Pier Takeshiba South Tower, 1-16-1, Kaigan, Minatoku, Tokyo, 105-6891, Japan
Phone: 81-3-5402-4502 Fax: 81-3-5402-4580
<http://www.yaskawa.co.jp>

YASKAWA ELÉTRICO DO BRASIL LTDA.

Avenda Fagundes Filho, 620 Bairro Saude, São Paulo, SP04304-000, Brasil
Phone: 55-11-3585-1100 Fax: 55-11-5581-8795
<http://www.yaskawa.com.br>

YASKAWA EUROPE GmbH

Hauptstrasse 185, 65760 Eschborn, Germany
Phone: 49-6196-569-300 Fax: 49-6196-569-398
<http://www.yaskawa.eu.com>

YASKAWA ELECTRIC UK LTD.

1 Hunt Hill Orchardton Woods, Cumbernauld, G68 9LF, United Kingdom
Phone: 44-1236-735000 Fax: 44-1236-458182
<http://www.yaskawa.co.uk>

YASKAWA ELECTRIC KOREA CORPORATION

7F, Doore Bldg. 24, Yeoido-dong, Yeoungdungpo-gu, Seoul, 150-877, Korea
Phone: 82-2-784-7844 Fax: 82-2-784-8495
<http://www.yaskawa.co.kr>

YASKAWA ELECTRIC (SINGAPORE) PTE. LTD.

151 Lorong Chuan, #04-01, New Tech Park, 556741, Singapore
Phone: 65-6282-3003 Fax: 65-6289-3003
<http://www.yaskawa.com.sg>

YASKAWA ELECTRIC (SHANGHAI) CO., LTD.

No. 18 Xizang Zhong Road, 17F, Harbour Ring Plaza, Shanghai, 200001, China
Phone: 86-21-5385-2200 Fax: 86-21-5385-3299
<http://www.yaskawa.com.cn>

YASKAWA ELECTRIC (SHANGHAI) CO., LTD. BEIJING OFFICE

Room 1011, Tower W3 Oriental Plaza, No. 1 East Chang An Ave.,
Dong Cheng District, Beijing, 100738, China
Phone: 86-10-8518-4086 Fax: 86-10-8518-4082

YASKAWA ELECTRIC TAIWAN CORPORATION

9F, 16, Nanking E. Rd., Sec. 3, Taipei, 104, Taiwan
Phone: 886-2-2502-5003 Fax: 886-2-2505-1280

YASKAWA

YASKAWA AMERICA, INC.

In the event that the end user of this product is to be the military and said product is to be employed in any weapons systems or the manufacture thereof, the export will fall under the relevant regulations as stipulated in the Foreign Exchange and Foreign Trade Regulations. Therefore, be sure to follow all procedures and submit all relevant documentation according to any and all rules, regulations and laws that may apply.

Specifications are subject to change without notice for ongoing product modifications and improvements.

© 2014-2016 YASKAWA AMERICA, INC. All rights reserved.



MANUAL NO. SIEP YAIP1B 01D <4>

Published in U.S.A. April 2023