



欧州安全規格対応ACサーボドライブ
 Σ -miniシリーズ
取扱説明書

サーボモータ SGMM
サーボパック SGDF

製品を安全にお使い頂くために、本書を必ずお読みください。
また、本書をお手元に保管していただくとともに、最終的に本製品をご使用になるユーザー様のお手元に確実に届けられるよう、お取り計らい願います。

AC Servo Drive Conforming to EN Standard
 Σ -mini Series
INSTRUCTIONS

SGMM Servomotors
SGDF SERVOPACK

To properly use the product, read this manual thoroughly and retain for easy reference, inspection, and maintenance. Ensure the end user receives this manual.

INTRODUCTION

■ Manual Contents

This manual consists of Japanese Version and English Version.

- Japanese Version: Described on pages J - 1 to J - 20.
- English Version: Described on pages E - 1 to E - 21.

Use the Japanese Version or English Version as needed.

■ User Instructions

Use these instructions for the following jobs:

- Checking Σ -Series Servo drive on delivery
- Installing Σ -Series Servo drive
- Wiring Σ -Series Servo drive
- Operating Σ -Series Servo drive
- Inspecting and maintenance of Σ -Series Servo drive

CONTENTS

Σ SERIES AC SERVODRIVE INSTRUCTIONS	E - 1
NOTES FOR SAFE OPERATION	E - 3
1 CHECKING ON DELIVERY	E - 5
2 LIST OF STANDARD COMBINATION	E - 7
3 CABLE SPECIFICATIONS	E - 7
4 INSTALLATION	E - 8
4.1 Transportation	E - 8
4.2 Installing the Servomotor	E - 8
4.3 Installing the SERVOPACK	E - 9
5 WIRING	E - 10
5.1 Typical Configuration	E - 10
5.2 Flowchart for Peripheral Device Selection	E - 12
5.3 Wiring Precautions	E - 15
6 OPERATION	E - 16
7 INSPECTION AND MAINTENANCE	E - 17
7.1 Servomotor	E - 17
7.2 SERVOPACK	E - 17
8 MEASURES TO SATISFY THE EMC DIRECTIVE	E - 19
8.1 Applicable Servomotors	E - 19
8.2 Applicable Noise Filter	E - 19
8.3 Applicable Power Supply	E - 19
8.4 Motor Cables	E - 19
8.5 Encoder Cables	E - 20
8.6 Control I/O	E - 20

8.7	Digital Operator and Monitoring by Personal Computer	E - 20
8.8	Cable Core	E - 20
8.9	Wiring Examples	E - 21

INSTRUCTIONS

Σ SERIES AC SERVODRIVE

CONTENTS

Σ SERIES AC SERVODRIVE INSTRUCTIONS	E - 1
NOTES FOR SAFE OPERATION	E - 3
1 CHECKING ON DELIVERY	E - 5
2 LIST OF STANDARD COMBINATION	E - 7
3 CABLE SPECIFICATIONS	E - 7
4 INSTALLATION	E - 8
4.1 Transportation	E - 8
4.2 Installing the Servomotor	E - 8
4.3 Installing the SERVOPACK	E - 9
5 WIRING	E - 10
5.1 Typical Configuration	E - 10
5.2 Flowchart for Peripheral Device Selection	E - 12
5.3 Wiring Precautions	E - 15
6 OPERATION	E - 16
7 INSPECTION AND MAINTENANCE	E - 17
7.1 Servomotor	E - 17
7.2 SERVOPACK	E - 17
8 MEASURES TO SATISFY THE EMC	
DIRECTIVE	E - 19
8.1 Applicable Servomotors	E - 19
8.2 Applicable Noise Filter	E - 19
8.3 Applicable Power Supply	E - 19
8.4 Motor Cables	E - 19
8.5 Encoder Cables	E - 20
8.6 Control I/O	E - 20
8.7 Digital Operator and Monitoring by Personal Computer	E - 20
8.8 Cable Core	E - 20
8.9 Wiring Examples	E - 21

This instruction manual covers AC servo drive Σ series SERVOPACK.

The AC Servo Drives consist primarily of AC Servomotors and their controllers, SERVOPACKS.

To properly use the AC servo drive Σ series, read this manual thoroughly and retain for easy reference for inspections and maintenance etc.

Reference materials are listed below:

Manual Titles	Manual No.
Σ Series SGMM/SGDF USER'S MANUAL	SIE-S800-27
Digital Operator Type JUSP-OP02A-3 OPERATION MANUAL	TOE-S800-15.3
Software for Personal Computer Monitoring OPERATION MANUAL	SIE-S800-15.5
AC Servomotor INSTRUCTIONS	TOE-C231-2

General Precautions

- Some drawings in this manual are shown with the protective cover or shields removed, in order to describe the detail with more clarity. Make sure all covers and shields are replaced before operating this product.
- Some drawings in this manual are shown as typical example and may differ from the shipped product.
- This manual may be modified when necessary because of improvement of the product, modification or changes in specifications.
Such modification is made as a revision by renewing the manual No.
- To order a copy of this manual, if your copy has been damaged or lost, contact your YASKAWA representative listed on the last page stating the manual No. on the front cover.
- YASKAWA is not responsible for accidents or damages due to any modification of the product made by the user since that will void our guarantee.

NOTES FOR SAFE OPERATION

Read this manual thoroughly before installation, operation, maintenance or inspection of the AC Servo Drives. In this manual, the NOTES FOR SAFE OPERATION are classified as “WARNING” or “CAUTION”.

WARNING

Indicates a potentially hazardous situation which, if not avoided, could result in death or serious personal injury.

CAUTION

Indicates a potentially hazardous situation which, if not avoided, may result in minor or moderate personal injury and/or damage to the equipment.

In some instances, items described in  **CAUTION** may also result in a serious accident. In either case, follow these important items.

 WARNING
<p>(WIRING)</p> <ul style="list-style-type: none">● Grounding must be in accordance with the national code and consistent with sound local practices. <p>Failure to observe this warning may lead to electric shock or fire.</p> <p>(OPERATION)</p> <ul style="list-style-type: none">● Never touch any rotating motor parts during operation. <p>Failure to observe this warning may result in personal injury.</p> <p>(INSPECTION AND MAINTENANCE)</p> <ul style="list-style-type: none">● Do not touch areas inside the SERVOPACK. <p>Electrical shock may result.</p> <ul style="list-style-type: none">● After turning OFF power, wait at least five minutes before servicing the product. <p>Otherwise, residual electric charges may result in electric shock.</p>



CAUTION

(RECEIVING)

- Use the specified combination of Servomotor and SERVOPACK.

Failure to observe this caution may lead to fire or failure.

(STORAGE AND TRANSPORTATION)

- If disinfectants or insecticides must be used to treat packing materials such as wooden frames, pallets, or plywood, the packing materials must be treated before the product is packaged, and methods other than fumigation must be used.

Example: Heat treatment, where materials are kiln-dried to a core temperature of 56°C for 30 minutes or more.

If the electronic products, which include stand-alone products and products installed in machines, are packed with fumigated wooden materials, the electrical components may be greatly damaged by the gases or fumes resulting from the fumigation process. In particular, disinfectants containing halogen, which includes chlorine, fluorine, bromine, or iodine can contribute to the erosion of the capacitors.

(INSTALLATION)

- Never use the equipment where it may be exposed to splashes of water, corrosive or flammable gases, or near flammable materials.

Failure to observe this caution may lead to electric shock or fire.

(WIRING)

- Do not connect three-phase power supply to output terminals (U, V) and (W).

Failure to observe this caution may lead to personal injury or fire.

- Make sure that screws on the power supply and motor output terminals are securely tightened.

Failure to observe this caution can result in a fire.

(OPERATION)

- To avoid inadvertent accidents, run the Servomotor only in test run (without load).

Failure to observe this caution may result in personal injury.

- Before starting operation with a load connected, set up user constants suitable for the machine.

Starting operation without setting up user constants may lead to overrun failure.

- Before starting operation with a load connected, make sure emergency-stop procedures are in place.

Failure to observe this caution may result in personal injury.

- During operation, do not touch the heat sink.

Failure to observe this caution may result in burns.

(INSPECTION AND MAINTENANCE)

- Do not disassemble the Servomotor or the SERVOPACK.

Failure to observe this caution may result in electric shock or personal injury.

- Never change wiring while power is ON.

Failure to observe this caution may result in electric shock or personal injury.

1 CHECKING ON DELIVERY

When Σ -Series products are delivered, check the following items:

Check Items	Remarks
Check if the delivered products are the ones you ordered.	Check the types marked on the nameplates of Servomotor and SERVOPACK (see the table on the next page).
Check if the motor shaft rotates smoothly.	If the motor shaft is smoothly turned by hand, it is normal. However, if the motor has brakes, it cannot be turned manually.
Check for damage.	Check the overall appearance, and check for damage or scratches resulting from transportation.
Check screws for looseness.	Check for looseness by using a screwdriver as necessary.

If any of the above items are faulty or incorrect, contact the dealer from which you purchased the products or your nearest local sales representative.

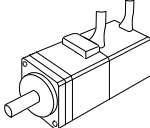
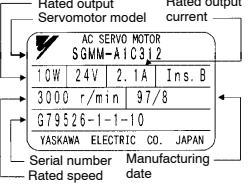
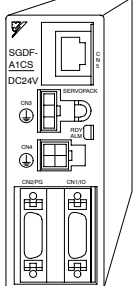
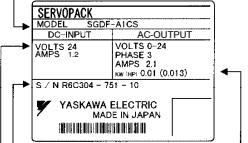
	Appearance	Nameplate	Type
<p>Servo-motors</p>	 <p>Σ-Series SGMM Servomotor</p>	 <p>Rated output Servomotor model</p> <p>Rated output current</p> <p>Serial number</p> <p>Rated speed</p> <p>Manufacturing date</p>	<p>Standard Servomotors</p> <p>SGMM-A1 C 3 1 2 <input type="checkbox"/></p> <p>Σ Series SGMM Servomotor</p> <p>Rated output A1: 10 W B3: 3 W A2: 20 W B5: 5 W A3: 30 W B9: 10 W</p> <p>Power supply C: 24 VDC S: EN safety standards, 24 VDC</p> <p>Encoder specifications 3: 2048P/R incremental encoder F: 1024 P/R incremental encoder</p> <p>Design revision order</p> <p>Shaft specifications 2: Straight without key 3: Straight with flat seat</p> <p>Option C: With brake (24V)</p> <hr/> <p>Servomotors with Reduction Gears</p> <p>SGMM-A1 C 3 J 1 2 <input type="checkbox"/></p> <p>Σ Series SGMM Servomotor</p> <p>Rated output A1: 10 W A2: 20 W A3: 30 W</p> <p>Power supply C: 24 VDC S: EN safety standards, 24 VDC</p> <p>Encoder specifications 3: 2048P/R incremental encoder</p> <p>With reduction gear</p> <p>Deceleration rate A: 1/5 B: 1/16 C: 1/25</p> <p>Shaft specifications 2: Straight without key 3: Straight with flat seat</p> <p>Option C: With brake (24V)</p>
<p>SERVO-PACKS</p>	 <p>Σ-Series SGDF SERVOPACK</p>	 <p>SERVOPACK model</p> <p>Serial number</p> <p>Applicable power supply</p> <p>Applicable motor capacity</p>	<p>SGDF - A1 C S</p> <p>Σ Series SGDF SERVOPACK</p> <p>Rated output A1: 10 W B3: 3 W A2: 20 W B5: 5 W A3: 30 W B9: 10 W</p> <p>Power supply C: 24 VDC</p> <p>Type S: Speed/torque control P: Position control</p>

2 LIST OF STANDARD COMBINATION

Combination of SERVOPACK, Servomotor and Accessories

SERVOPACK Type SGDF-		Applicable Servomotor	Power Supply Capacity per SERVOPACK*1 W	MCCB or Fuse Capacity *2 A	Recommended Noise Filter*3		Magnetic Contactor	Power Supply Capacity to SERVOPACK *4 W
					Type	Spec.		
10 W	A1C□	SGMM-A1□□	28	5	LF-205A	Single-phase 200V, 5A	HI-11J (20A) or equivalent	220
20 W	A2C□	SGMM-A2□□	42					300
30 W	A3C□	SGMM-A3□□	60					130
3W	B3C□	SGMM-A3□□	22					
5W	B3C□	SGMM-A3□□	24					
10W	B3C□	SGMM-A3□□	30					140

* 1 Values at rated load.

* 2 Braking characteristics at 25°C : 200% for 2s or above, 700% for 0.01s or above.

* 3 Yaskawa recommends noise filter manufactured by Tokin Corp. Contact Yaskawa sales representative.

* 4 Power supply capacity required for maximum load.

3 CABLE SPECIFICATIONS

The rated current and cable size of the SERVOPACK external terminals are shown in below. Select cable specifications and size according to the operating environment and current capacity.

SERVOPACK Type SGDF-	Main Circuit Power Input Terminal*1 24VDC, GND, ⊕		Motor Connection Terminals*1 U, V, W, ⊕	
	Rated Current (Arms)	Cable Spec. (mm ²)	Rated Current (Arms)	Cable Spec. (mm ²)
A1C□	1.2	0.5 min.	2.1	*2
A2C□	1.7		2.0	
A3C□	2.3		2.9	
B3C□	0.9		1.3	
B5C□	1.0		1.3	
B9C□	1.2		1.9	

* 1 The cable specifications are selected under conditions of three cables per bundle at 40°C ambient temperature, with the rated current flowing.

* 2 Be sure to use Yaskawa cables. For details, refer to 5.2 "Flowchart for Peripheral Device Selection".

4 INSTALLATION

4.1 Transportation

- Do not lift or carry the Servomotor by the (encoder and/or motor) cables. It may break the wire.
- Gently place the Servomotor when installing.

4.2 Installing the Servomotor

■ Installation direction

AC Servomotor can be installed either horizontally or vertically.

■ Precautions for installation

This is a precision equipment, therefore, avoid impacts on motor or output shaft.

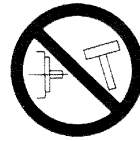

■ Installation sites:

The Servomotor is designed for indoor use. Install Servomotor in an environment which meets the following conditions:

- Free from corrosive and explosive gases
- Well-ventilated and free from dust and moisture
- Ambient temperature of 0 to 40°C
- Relative humidity of 20% to 80% (non-condensing)
- Inspection and cleaning can be performed easily

4.3 Installing the SERVOPACK

■ Installation direction

- Mount the unit vertically on wall using the mounting holes on the baseplate, with main terminals at the bottom.
- Since SERVOPACK is a self-cooling unit, supply enough space for cooling.
- If SERVOPACKS are mounted side by side, temperature may rise because of the uneven temperature inside the panel. Therefore, provide a fan/fans above the SERVOPACK blowing down on the units.

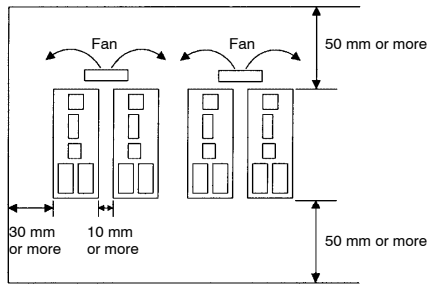

■ Installation sites:

Situation	Notes on Installation
When installed in a control panel	Design the control panel size, unit layout, and cooling method so that the temperature around the periphery of the SERVOPACK does not exceed 50°C.
When installed near a heating unit	Suppress radiation heat from the heating unit and a temperature rise caused by convection so that the temperature around the periphery of the SERVOPACK does not exceed 50°C.
When installed near a source of vibration	Install a vibration isolator underneath the SERVOPACK to prevent it from receiving vibration.
When installed in a place receiving corrosive gases	Corrosive gases do not immediately affect the SERVOPACK but will eventually cause contactor-related devices to malfunction. Take appropriate action to prevent corrosive gases.
Others	Avoid installation in a hot and humid place or where excessive dust or iron powder is present in the air.

40°C or below is preferable to maintain the reliability over a long period.

5 WIRING

5.1 Typical Configuration

Before wiring, turn OFF the power ON/OFF switch and post a notice of “No Conduction.” Only an electrical expert can perform the wiring.

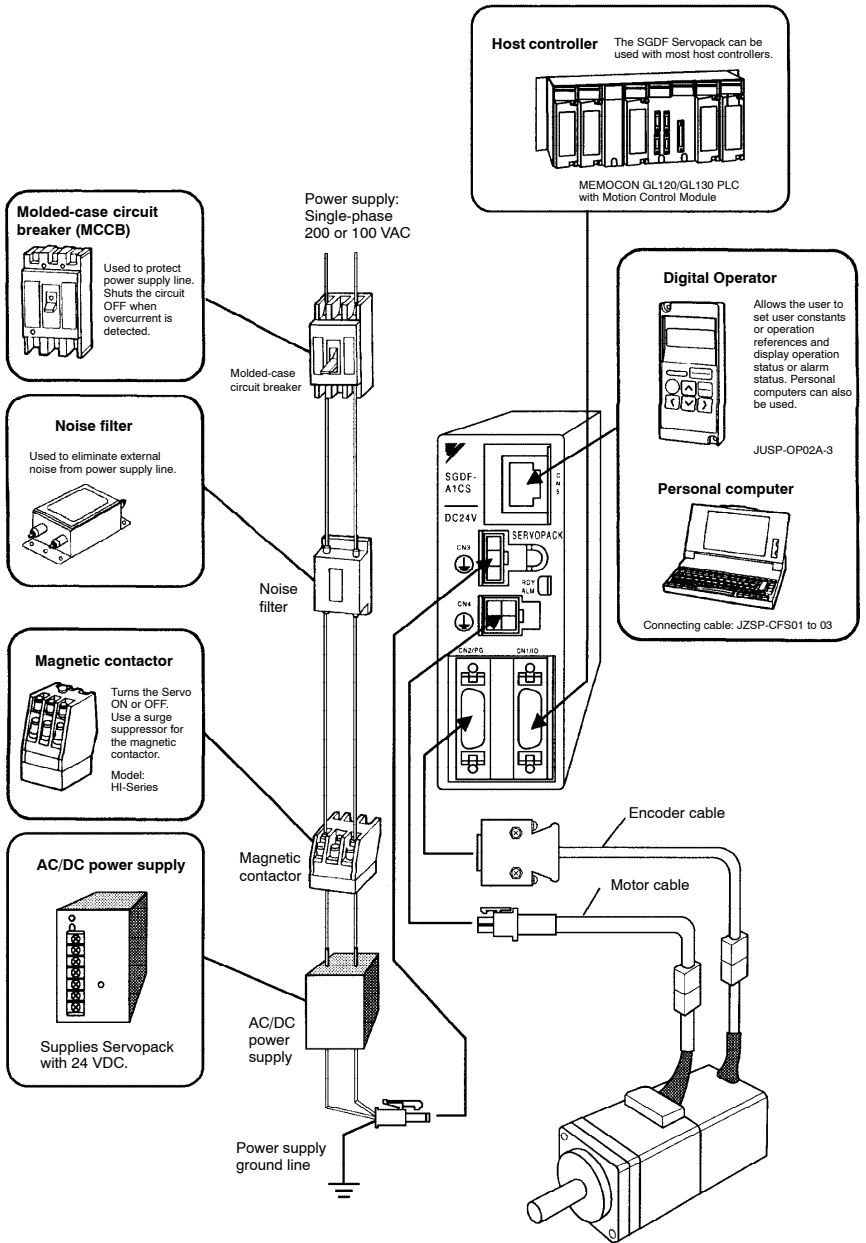

5.2 Flowchart for Peripheral Device Selection

Peripheral Device Selection Flowchart

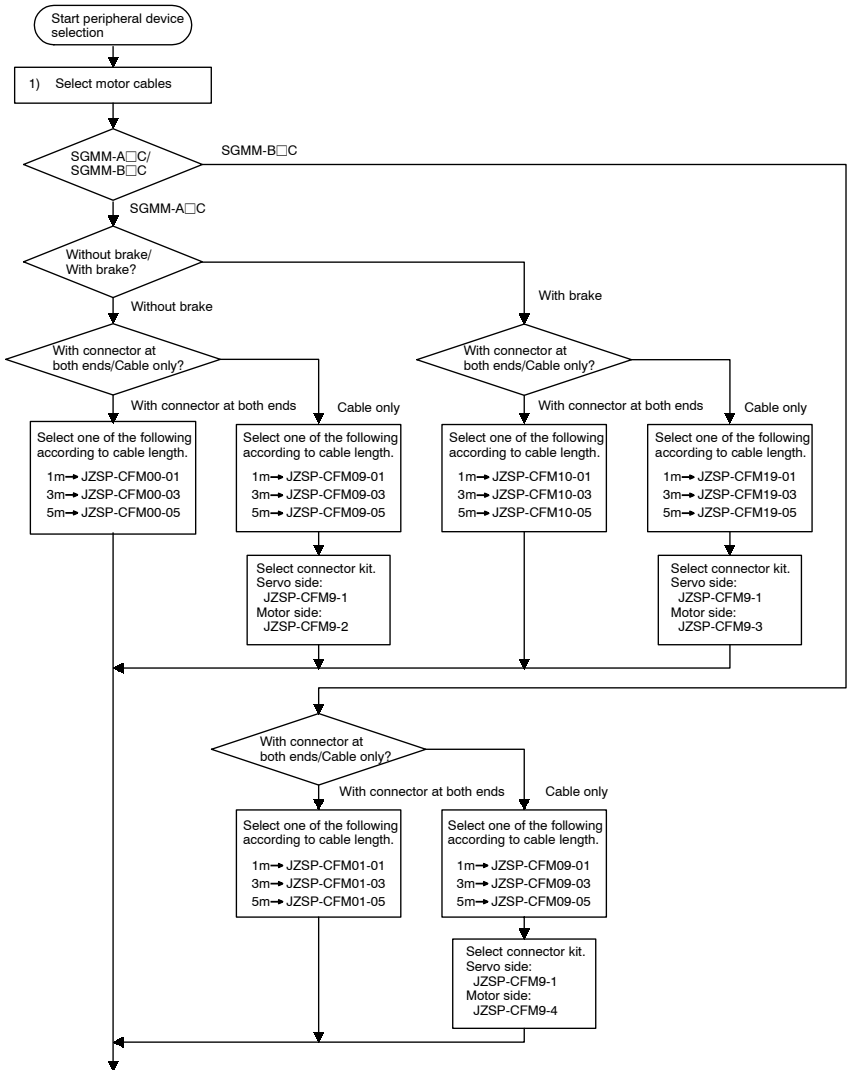

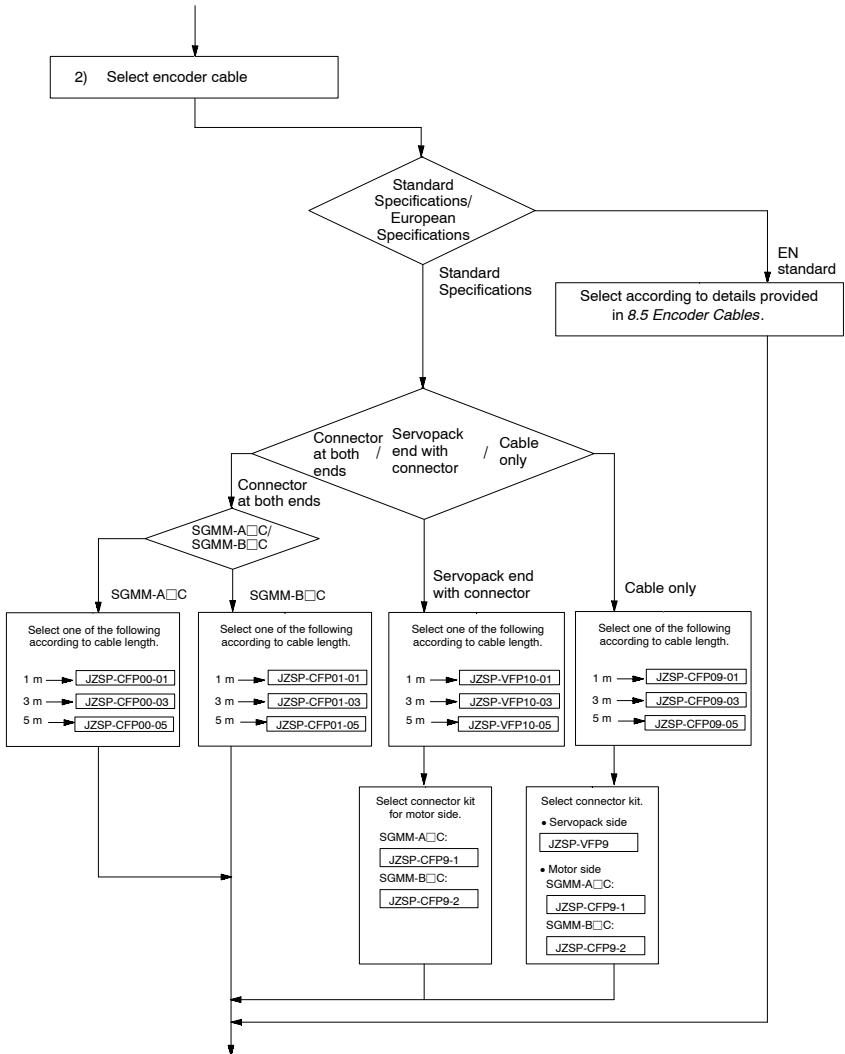

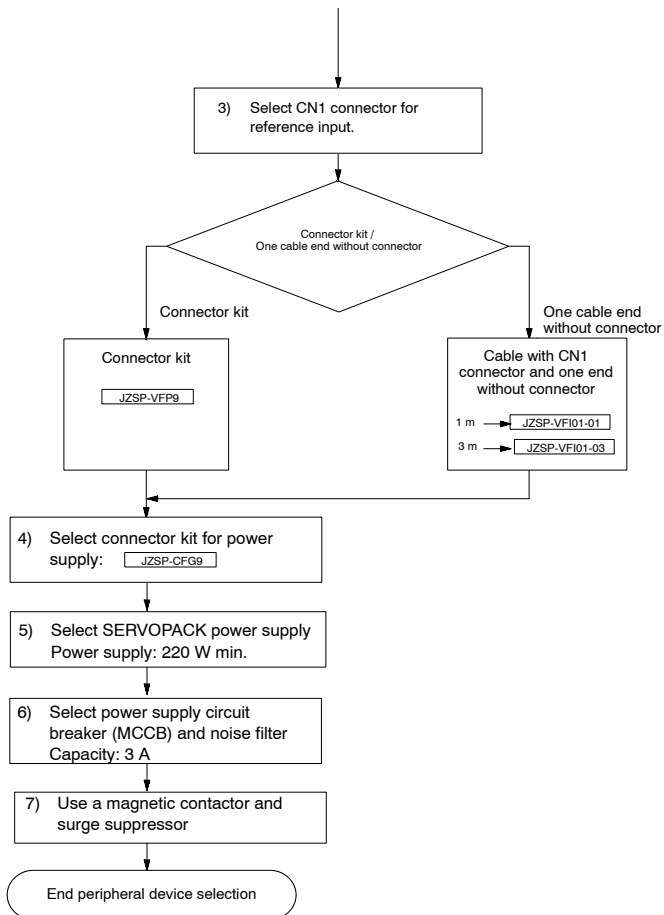

5.3 Wiring Precautions

■ Grounding wire

- In conformance with local electrical codes, ground the SERVOPACK's grounding terminal \oplus .
- Be sure to connect the grounding wire of the Servomotor to \oplus of the SERVOPACK.
- Never share the grounding cable or grounding rod with welders, power equipment, or other high-voltage devices. Separate the grounding cable from wiring of high-voltage equipments.
- Make the grounding wire as short as possible. As for cable size, see Par. 3.
- If two or more SERVOPACKS are used, ground them as shown in (a) below. Avoid methods (b) and (c).



GOOD
(a)



POOR
(b)



POOR
(c)

■ Power supply

- Supply 24VDC for power supply.
- Do not connect three-phase power to output terminals U V W. Failure to observe this caution may damage the SERVOPACK.
- Take care to prevent power line wiring or output wiring from touching or being enclosed inside the case.

■ Noise control

- If the speed signal line is affected by noise, malfunction may result.
 - Separate power cables from control cables.
 - Make the speed signal line as short as possible and use twisted-pair wires.
- Never use a noise filter (for power input) for motor circuit. If peripheral devices malfunction due to the noise from SERVOPACK, insert a noise filter (for output, type LF-310KA, made by Tokin Corp.) between motor and SERVOPACK.

6 OPERATION

■ Conducting test run for Servomotor without load

When Servomotor is operated without load, set the speed loop gain (user constant Cn-04) to 40 or less. (Factory setting is 80)

Speed loop gain(user constant Cn-04) is determined by the following conditions:

$$\text{Load inertia} \geq \text{motor inertia} \times 3$$

Therefore, when motor is rotated without load (without load inertia) or load inertia is small, if the value has been kept at the factory setting, the motor may oscillate.

To avoid this, make sure to set the value of Cn-04 (speed loop gain) to 40 or less and then servo ON.

■ Conducting test run with Servomotor connected to machine

SERVOPACK initial user constants setting is performed supposing the normal operation conditions.

Before test run, set up user constants suitable for the machine.

Failure to set up the user constants initial setting may result in machine overrun or breakdown.

As for the setting procedures and methods, refer to "Digital Operator Operation Manual."

■ Check items during test run

The following items should be checked during the test run.

- Unusual vibration
- Abnormal noise
- Excessive temperature rise

7 INSPECTION AND MAINTENANCE

7.1 Servomotor

For inspection and maintenance of Servomotors, follow the simple, daily inspection procedures in the table below.

The AC Servomotors are brushless. Simple, daily inspection is sufficient. The inspection and maintenance frequencies in the table are only guidelines. Increase or decrease the frequency to suit the operating conditions and environment.

Item	Frequency	Procedure	Comments
Vibration and noise	Daily	Touch and listen.	Levels higher than normal?
Appearance	According to degree of contamination	Clean with cloth or compressed air.	
Insulation resistance measurement	At least once a year	Disconnect SERVOPACK and test insulation resistance at 500 V. Must exceed 10 M Ω .*	Contact your YASKAWA representative if the insulation resistance is below 10 M Ω .
Replace oil seal	At least once every 5,000 hours	Remove servomotor from machine and replace oil seal.	Applies only to motors with oil seal.
Overhaul	At least once every 20,000 hours or 5 years	Contact your YASKAWA representative.	The customer should not disassemble and clean the Servomotor.

* Measure across the Servomotor FG (Green/Yellow) and the U-phase (Red), V-phase (White), or W-phase (Blue) power lead.

7.2 SERVOPACK

The SERVOPACK contains highly reliable parts and daily inspection is not required. Carry out the inspections and maintenance in the table below once every year.

Item	Frequency	Procedure	Remedy
Clean unit interior and circuit boards	At least once a year	Check for dust, dirt, and oil on the surfaces.	Clean with compressed air.
Loose screws	At least once a year	Check for loose terminal block and connector screws.	Tighten any loose screws.
Defective parts in unit or on circuit boards.	At least once a year	Check for discoloration, damage or discontinuities due to heating.	Contact your YASKAWA representative.

■ Part replacement schedule

The following parts are subject to mechanical wear or deterioration over time. To avoid failure, replace these parts at the frequency indicated.

Part	Standard Replacement Period	Replacement Method
Smoothing Capacitor	7 to 8 years	Test. Replace with new part if necessary.
Relays	---	Test. Replace if necessary.
Fuse	10 years	Replace with new part.
Electrolytic Capacitor on Circuit Board	5 years	Test. Replace with new part if necessary.

Note: Operating Conditions:
Ambient Temperature: annual average 30°C
Load Factor: 80% max.
Operation Rate: 20 hours/day max.

8 MEASURES TO SATISFY THE EMC DIRECTIVE

This section describes the measures required for SERVOPACKS to conform to EMC Directive (EN55011, EN50082-2).

8.1 Applicable Servomotors

Use a Yaskawa Servomotor conforming to EN standards.

- Servomotor Models: SGMM-A1S312 (10 W)
SGMM-A2S312 (20 W)
SGMM-A3S312 (30 W)

8.2 Applicable Noise Filter

Use the following noise filter.

Make sure to ground the noise filter properly.

Model	MYB-1206-33
Manufacturer	NEMIC-LAMBDA K.K

8.3 Applicable Power Supply

Use a power supply conforming to EN standards.

Make sure to ground the power supply properly.

Recommended power supply is as follows:

Model	PLEY24HSZ-PU
Manufacturer	ETA ELECTRIC IND. Co., Ltd

8.4 Motor Cables

The maximum cable length is 5 m (16.7 feet).

8.5 Encoder Cables

Use an encoder cable with connector at both ends.

The maximum cable length is 5 m (16.7 feet). Select one of the following according to cable length.

1 m: JZSP-VFP00-01

3 m: JZSP-VFP00-03

5 m: JZSP-VFP00-05

8.6 Control I/O

Use cables with CN1 connectors for control I/O. When using connector kits, use shielded cable for the CN1 cable and make sure to ground between the cable shield and connector case. Connect the shield at the host controller properly.

8.7 Digital Operator and Monitoring by Personal Computer

Use the Digital Operator or personal computer (for monitoring) for trial operation only. Disconnect them during normal operation.

8.8 Cable Core

Model	ESD-SR-25
Manufacturer	Token Corp.

The cable line and line position where the core is attached is as follows:

Cable Line	Encoder Line	Motor Line
Line Position	Servopack end Motor end	Servopack end

8.9 Wiring Examples

The following diagram shows the wiring conditions conforming to EMC Directive. The noise filter and the core are shown in the diagram.

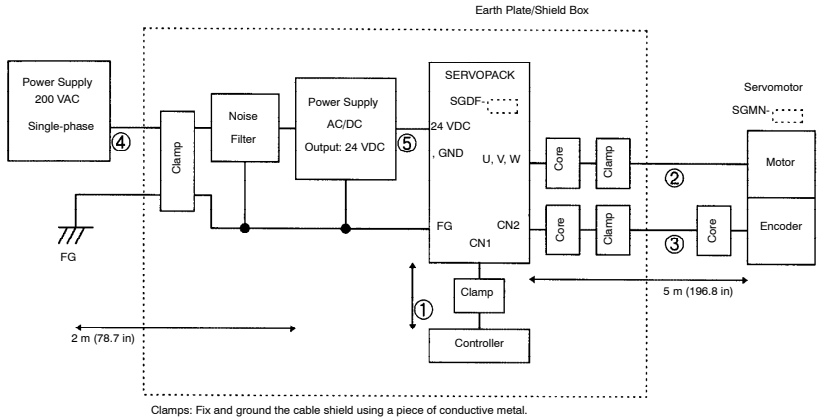

Symbol	Name	Specification
①	Controller cable	Shield cable (0.5 m) (19.6 in)
②	Motor cable	Shield cable (5 m) (196.8 in)
③	Encoder cable	Shield cable (5 m) (196.8 in)
④	AC Line cable	Shield cable (2 m) (78.7 in)
⑤	DC Line cable	Shield cable (0.5 m) (19.6 in)

AC Servo Drive Conforming to EN Standard

Σ -mini Series

INSTRUCTIONS

IRUMA BUSINESS CENTER (SOLUTION CENTER)

480, Kamifujisawa, Inuma, Saitama 358-8555, Japan
Phone 81-4-2962-5151 Fax 81-4-2962-6138
<http://www.yaskawa.co.jp>

YASKAWA AMERICA, INC.

2121 Norman Drive South, Waukegan, IL 60085, U.S.A.
Phone 1-800-YASKAWA (927-5292) or 1-847-887-7000 Fax 1-847-887-7310
<http://www.yaskawa.com>

YASKAWA ELÉTRICO DO BRASIL LTDA.

Avenida Piraporinha 777, Diadema, São Paulo, 09950-000, Brasil
Phone 55-11-3585-1100 Fax 55-11-3585-1187
<http://www.yaskawa.com.br>

YASKAWA EUROPE GmbH

Hauptstraße 185, Eschborn 65760, Germany
Phone 49-6196-569-300 Fax 49-6196-569-398
<http://www.yaskawa.eu.com>

YASKAWA ELECTRIC KOREA CORPORATION

9F, Kyobo Securities Bldg, 26-4, Yeouido-dong, Yeongdeungpo-gu, Seoul, 150-737, Korea
Phone 82-2-784-7844 Fax 82-2-784-8495
<http://www.yaskawa.co.kr>

YASKAWA ELECTRIC (SINGAPORE) PTE. LTD.

151 Lorong Chuan, #04-02A, New Tech Park 556741, Singapore
Phone 65-6282-3003 Fax 65-6289-3003
<http://www.yaskawa.com.sg>

YASKAWA ELECTRIC (CHINA) CO., LTD.

12F, Carlton Bld., No.21 HuangHe Road, HuangPu District, Shanghai 200003, China
Phone 86-21-5385-2200 Fax 86-21-5385-3299
<http://www.yaskawa.com.cn>

YASKAWA ELECTRIC (CHINA) CO., LTD. BEIJING OFFICE

Room 1011, Tower W3 Oriental Plaza, No.1 East Chang An Ave.,
Dong Cheng District, Beijing 100738, China
Phone 86-10-8518-4086 Fax 86-10-8518-4082

YASKAWA ELECTRIC TAIWAN CORPORATION

9F, 16, Nanking E. Rd., Sec. 3, Taipei 104, Taiwan
Phone 886-2-2502-5003 Fax 886-2-2505-1280



YASKAWA ELECTRIC CORPORATION

In the event that the end user of this product is to be the military and said product is to be employed in any weapons systems or the manufacture thereof, the export will fall under the relevant regulations as stipulated in the Foreign Exchange and Foreign Trade Regulations. Therefore, be sure to follow all procedures and submit all relevant documentation according to any and all rules, regulations and laws that may apply.

Specifications are subject to change without notice for ongoing product modifications and improvements.

© 1999-2014 YASKAWA ELECTRIC CORPORATION. All rights reserved.

MANUAL NO. TOB-S800-27B

Published in Japan February 2014 99-2 -0
13-6-9