

# YASKAWA

# FP605 DRIVE

## INSTALLATION & PRIMARY OPERATION

AC DRIVE WITH MAIN SWITCH FOR  
INDUSTRIAL FAN AND PUMP APPLICATIONS

### CATALOG CODE:

FP65UxxxxTx

### CAPACITIES:

208 V class: 2.2 to 30 kW (3 to 40 HP)

480 V class: 2.2 to 56 kW (3 to 75 HP)

PDF

[yaskawa.com/TOEPC7106171G](http://yaskawa.com/TOEPC7106171G)

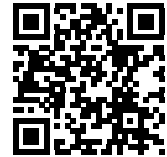

Simplify Drive Installation  
Get DriveWizard® Mobile



<https://www.yaskawa.com/dwm>

DOCUMENT NUMBER: TOEPC7106171G

---

**This Page Intentionally Blank**

# Table of Contents

---

1. General Information . . . . .	6
Glossary . . . . .	6
2. Safety . . . . .	6
Explanation of Signal Words . . . . .	6
General Safety Instructions . . . . .	6
Exclusion of Liability . . . . .	9
3. Cybersecurity . . . . .	9
4. Receiving . . . . .	9
How to Read Catalog Codes . . . . .	10
Rated Output Current . . . . .	11
5. Common Drive Specifications . . . . .	12
Area of Use . . . . .	14
6. Mechanical Installation . . . . .	14
Moving the Drive . . . . .	14
Using the Hanging Brackets to Move the Drive . . . . .	14
Installation Position and Distance . . . . .	14
Single Drive Installation . . . . .	15
Installing More than One Drive Adjacent to Each Other without Derating . . . . .	15
Removing/Reattaching Covers . . . . .	16
Remove the Front Cover . . . . .	16
Reattach the Front Cover . . . . .	18
Remove the Main Switch Cover . . . . .	19
Reattach the Main Switch Cover . . . . .	20
7. Electrical Installation . . . . .	20
Standard Connection Diagram . . . . .	20
Standard Drive Connection Diagram . . . . .	22
Main Circuit Terminal Functions . . . . .	23
Motor and Main Circuit Connections . . . . .	24
Wiring the Main Circuit and Motor . . . . .	24
Main Circuit Terminal Block Wiring . . . . .	26
Wire Selection . . . . .	26
Main Circuit Terminal Block Wiring Procedure . . . . .	30

Notes on Wiring the Main Circuit Terminal Block of Models 2011 to 2059 and 4005 to 4065	31
Notes on Wiring the Main Circuit Terminal Block of Models 2075 to 2114 and 4077 to 4096	33
Wiring the Main Circuit Terminal Block Using Procedure A	33
Wiring the Main Circuit Terminal Block Using Procedure B	33
<b>8. Drive Main Switch</b>	<b>36</b>
Use and Lock the Main Switch	36
<b>9. Keypad: Names and Functions</b>	<b>38</b>
Keypad Mode and Menu Displays	40
<b>10. LED Status Ring</b>	<b>41</b>
<b>11. Drive Start-Up Procedure</b>	<b>42</b>
Change Parameter Setting Values	43
Disable the Initial Setup Screen	44
Control Circuit Terminal Block Functions	45
Input Terminals	45
Output Terminals	47
External Power Supply Input Terminals	47
Serial Communication Terminals	47
Control Circuit Terminal Configuration	48
Control Circuit Wire Gauges and Tightening Torques	49
Wiring the Control Circuit Terminal	50
Switches and Jumpers on the Terminal Board	52
Control I/O Connections	53
Set Sinking Mode/Sourcing Mode	53
Set Input Signals for MFAI Terminals A1 to A3	54
Set Output Signals for MFAO Terminals FM, AM	55
Switch ON Termination Resistor for MEMOBUS/Modbus Communications	55
<b>12. Drive Control and Programming</b>	<b>56</b>
Selecting the Control Method	56
Auto-Tuning	56
Drive Parameters	57
<b>13. UL Standards</b>	<b>61</b>
Area of Use	61
Main Circuit Wire Gauges and Tightening Torques	61
Ferrules and Closed-Loop Crimp Terminals	61
Short Circuit Protection Requirements for UL Listing	64
UL Compliance	64
Low Voltage Wiring for Control Circuit Terminals	67
Drive Motor Overload and Overheat Protection	67
E2-01: Motor Rated Current (FLA)	67
E5-03: PM Motor Rated Current (FLA)	67
E9-06: Motor Rated Current (FLA)	68
L1-01: Motor Overload (oL1) Protection	68

L1-02: Motor Overload Protection Time .....	71
L1-03: Motor Thermistor oH Alarm Select .....	72
L1-04: Motor Thermistor oH Fault Select .....	72
<b>14. European Standards .....</b>	<b>72</b>
EU Declaration of Conformity .....	73
CE Low Voltage Directive Compliance .....	73
Area of Use .....	73
Electrical Installation .....	73
Main Circuit Wire Gauges and Tightening Torques .....	75
Connect a Fuse and a GFCI to the Input Side (Primary Side) .....	75
EMC Directive .....	76
Install a Drive to Conform to the EMC Directive .....	76
<b>15. China RoHS Compliance .....</b>	<b>83</b>
Information on Hazardous Substances in This Product .....	83
<b>16. 对应中国RoHS指令 .....</b>	<b>83</b>
本产品中含有有害物质的信息 .....	84
<b>17. Safe Disable Input .....</b>	<b>84</b>
Safe Disable Specifications .....	85
Notes .....	85
Using the Safe Disable Function .....	86
Safe Disable Circuit .....	86
Enabling and Disabling the Drive Output (“Safe Torque Off”) .....	86
Safe Disable Monitor Output Function and Keypad Display .....	87
Validating the Safe Disable Function .....	88
<b>18. Seismic Standards .....</b>	<b>88</b>
<b>19. Disposal Instructions .....</b>	<b>89</b>
WEEE Directive .....	89
<b>20. Maintenance .....</b>	<b>89</b>
<b>21. Troubleshooting .....</b>	<b>90</b>
Fault .....	90
Minor Faults/Alarms .....	98
Parameter Setting Errors .....	103
Auto-Tuning Errors .....	104
Backup Function Operating Mode Display and Errors .....	106
<b>Revision History .....</b>	<b>108</b>

# 1 General Information

The products and specifications given in this manual and the manual contents can change without notice to make the product and manual better.

Be sure to always use the latest version of this manual. Use this manual to correctly install, wire, set, and operate this product.

Users can download additional manuals for this product from the Yaskawa documentation website printed on the back cover.

## ◆ Glossary

Phrase	Definition
Drive	YASKAWA AC Drive FP605
EDM	External Device Monitor
EZOLV	EZ Open Loop Vector Control
IPM motor	Interior Permanent Magnet motors
MFAI	Multi-Function Analog Input
MFAO	Multi-Function Analog Output
MFDI	Multi-Function Digital Input
MFDO	Multi-Function Digital Output
OLV/PM	Open Loop Vector Control for Permanent Magnet Motors
PM motor	Permanent Magnet Synchronous motor (generic name for IPM motors and SPM motors)
SIL	Safety Integrity Level
SPM motor	Surface Permanent Magnet motors
V/f	V/f Control

## 2 Safety

Read the safety instructions carefully before you install, wire, or operate this product.

### ◆ Explanation of Signal Words

- ⚠ DANGER** *This signal word identifies a hazard that will cause serious injury or death if you do not prevent it.*
- ⚠ WARNING** *This signal word identifies a hazard that can cause death or serious injuries if you do not prevent it.*
- ⚠ CAUTION** *This signal word identifies a hazardous situation, which, if not avoided, can cause minor or moderate injury.*
- NOTICE** *This signal word identifies a property damage message that is not related to personal injury.*

### ◆ General Safety Instructions

Yaskawa Electric manufactures and supplies electronic components for a variety of industrial applications. The selection and application of Yaskawa products is the responsibility of the designer of the equipment or the customer who assembles the final product. Yaskawa is not responsible for how our products are incorporated into the final system design. In all cases, Yaskawa products should not be incorporated into a product or design as the exclusive or sole safety control function. All control functions are designed to dynamically detect failures and operate safely without exception. All products that are designed to incorporate parts manufactured by Yaskawa must be provided to the end user and include proper warnings and instructions regarding their safe use and operation. All warnings from Yaskawa must be promptly issued to the end user. Yaskawa offers warranties only for the quality of our products, in compliance with standards and specifications that are described in the manual. Yaskawa does not offer other warranties, either explicit or implied. Injuries, property damage, and lost business opportunities caused by improper

storage or handling and negligence oversight on the part of your company or your customers will void Yaskawa's warranty for the product.

**Note:**

If you do not obey the safety messages in the manual, you are at risk for serious injury or death. Yaskawa is not responsible for injuries or damage to equipment if you ignore the safety messages.

- Read this manual carefully when you install, operate, or repair AC drives.
- Obey all warnings, cautions, and notices.
- Approved personnel must do all work.
- Install the drive as specified by this manual and local codes.

**⚠ DANGER** *Electrical Shock Hazard. Do not examine, connect, or disconnect wiring on an energized drive. Before servicing, disconnect all power to the equipment and wait for the time specified on the warning label at a minimum. The internal capacitor stays charged after the drive is de-energized. The charge indicator LED extinguishes when the DC bus voltage decreases below 50 Vdc. When all indicators are OFF, remove the covers before measuring for dangerous voltages to make sure that the drive is safe. If you do work on the drive when it is energized, it will cause serious injury or death from electrical shock.*

**⚠ WARNING** *Fire Hazard. Do not connect main power supply wiring to drive motor terminals U/T1, V/T2, and W/T3. Connect main power supply wiring to main circuit input terminals R/L1, S/L2, and T/L3. Incorrect wiring can cause serious injury or death from fire.*

**⚠ WARNING** *Electrical Shock Hazard. Do not modify the drive body or drive circuitry. Modifications to drive body and circuitry can cause serious injury or death, will cause damage to the drive, and will void the warranty. Yaskawa is not responsible for modifications of the product made by the user.*

**⚠ WARNING** *Crush Hazard. Only approved personnel can operate a crane or hoist to move the drive. If unapproved personnel operate a crane or hoist, it can cause serious injury or death from falling equipment.*

**⚠ WARNING** *Electrical Shock Hazard. Only let approved personnel install, wire, maintain, examine, replace parts, and repair the drive. If personnel are not approved, it can cause serious injury or death.*

**⚠ WARNING** *Electrical Shock Hazard. Always ground the motor-side grounding terminal. If you do not ground the equipment correctly, it can cause serious injury or death if you touch the motor case.*

**⚠ WARNING** *Electrical Shock Hazard. Do not wear loose clothing or jewelry when you do work on the drive. Tighten loose clothing and remove all metal objects, for example watches or rings. Loose clothing can catch on the drive and jewelry can conduct electricity and cause serious injury or death.*

**⚠ WARNING** *Electrical Shock Hazard. Make sure that the protective ground wire complies with technical standards and local safety regulations. The IEC/EN 61800-5-1:2007 standard specifies that you must wire the power supply to automatically de-energize when the protective ground wire disconnects. You can also connect a protective ground wire that has a minimum cross-sectional area of 10mm<sup>2</sup> (copper wire) or 16 mm<sup>2</sup> (aluminum wire). For drive models on which you cannot use a protective ground wire of 10 mm<sup>2</sup> or more, install two protective ground wires that have the same cross-sectional area. If you do not obey the standards and regulations, it can cause serious injury or death. The leakage current of the drive will be more than 3.5 mA.*

**⚠ WARNING** *Electrical Shock Hazard. Disconnect all power to the drive and remove all wires to do maintenance on the drive. If you only turn OFF the built-in Main Switch before you do maintenance, there can be high voltage on input terminals R/L1, S/L2, and T/L3 of the Main Switch and touching energized terminals will cause serious injury or death.*

**⚠ WARNING** *Sudden Movement Hazard. Before you do Auto-Tuning, remove all personnel and objects from the area around the drive, motor, and load. The drive and motor can start suddenly during Auto-Tuning and cause serious injury or death.*

**⚠ WARNING** *Sudden Movement Hazard. Remove all personnel and objects from the area around the drive, motor, and machine and attach covers, couplings, shaft keys, and machine loads before you energize the drive. If personnel are too close or if there are missing parts, it can cause serious injury or death.*

**⚠ WARNING** *Damage to Equipment. Do not apply incorrect voltage to the main circuit of the drive. Operate the drive in the specified range of the input voltage on the drive nameplate. Voltages that are higher than the permitted nameplate tolerance can cause damage to the drive.*

**⚠ WARNING** *Fire Hazard. Do not put flammable or combustible materials on top of the drive and do not install the drive near flammable or combustible materials. Attach the drive to metal or other noncombustible material. Flammable and combustible materials can start a fire and cause serious injury or death.*

**⚠ WARNING** *Fire Hazard. Tighten all terminal screws to the correct tightening torque. Connections that are too loose or too tight can cause incorrect operation and damage to the drive. Incorrect connections can also cause death or serious injury from fire.*

**⚠ WARNING** *Fire Hazard. Tighten screws at an angle in the specified range shown in this manual. If you tighten the screws at an angle not in the specified range, you can have loose connections that can cause damage to the terminal block or start a fire and cause serious injury or death.*

**⚠ WARNING** *Crush Hazard. Use a crane or hoist to move large drives when necessary. If you try to move a large drive without a crane or hoist, it can cause serious injury or death.*

**⚠ WARNING** *Electrical Shock Hazard. Do not cause a short circuit on the drive output circuit. A short circuit on the output can cause serious injury or death.*

**⚠ WARNING** *Electrical Shock Hazard. Correctly do inspection and maintenance. If you do not do inspection or maintenance, the deteriorated internal components of the drive can cause serious injury or death.*

**⚠ WARNING** *Electrical Shock Hazard. When there is a DC component in the protective earthing conductor, the drive can cause a residual current. When a residual current operated protective or monitoring device prevents direct or indirect contact, always use a type B Ground Fault Circuit Interrupter (GFCI) as specified by IEC/EN 60755. If you do not use the correct GFCI, it can cause serious injury or death.*

**⚠ WARNING** *Electrical Shock Hazard. Ground the neutral point on the power supply of the drives to comply with the EMC Directive before you turn on the EMC filter. If you turn ON the EMC filter, but you do not ground the neutral point, it can cause serious injury or death.*

**⚠ WARNING** *Crush Hazard. Test the system to make sure that the drive operates safely after you wire the drive and set parameters. If you do not test the system, it can cause damage to equipment or serious injury or death.*

**⚠ WARNING** *Electrical Shock Hazard. After the drive blows a fuse or trips a GFCI, do not immediately energize the drive or operate peripheral devices. Wait for the time specified on the warning label at a minimum and make sure that all indicators are OFF. Then check the wiring and peripheral device ratings to find the cause of the problem. If you do not know the cause of the problem, contact Yaskawa before you energize the drive or peripheral devices. If you do not fix the problem before you operate the drive or peripheral devices, it can cause serious injury or death.*

**⚠ WARNING** *Crush Hazard. Prevent the drive from too much vibration or impact. Too much vibration or impact can cause serious injury from the damaged equipments.*

**⚠ WARNING** *Arc Flash Hazard. Obey local codes and Arc Flash safety requirements contained in the Standard for Electrical Safety in the Workplace NFPA 70E (2009 Edition or later) and the Workplace Electrical Safety, Canadian Standards Association (CSA) Z462-12. Obey safe work procedures and use applicable personal protective equipment (PPE). If you do not obey these requirements and procedures, it can cause serious injury or death.*

**⚠ WARNING** *Fire Hazard. Install sufficient branch circuit short circuit protection as specified by applicable codes and this manual. The drive is suitable for circuits that supply not more than 100,000 RMS symmetrical amperes, 240 Vac maximum (208 V Class), 480 Vac maximum (480 V Class). Incorrect branch circuit short circuit protection can cause serious injury or death.*

**⚠ CAUTION** *Crush Hazard. Tighten terminal cover screws and hold the case safely when you move the drive. If the drive or covers fall, it can cause moderate injury.*

**⚠ CAUTION** *Burn Hazard. Do not touch a hot drive heatsink. De-energize the drive, wait for a minimum of 15 minutes, then make sure that the heatsink is cool before you replace the cooling fans. If you touch a hot drive heatsink, it can burn you.*

**NOTICE** *Damage to Equipment. When you touch the drive and circuit boards, make sure that you observe correct electrostatic discharge (ESD) procedures. If you do not follow procedures, it can cause ESD damage to the drive circuitry.*

**NOTICE** *Do not break the electrical connection between the drive and the motor when the drive is outputting voltage. Incorrect equipment sequencing can cause damage to the drive.*

**NOTICE** *Damage to Equipment. Do not do a withstand voltage test or use a megohmmeter or megger insulation tester on the drive. These tests can cause damage to the drive.*

**NOTICE** *Do not operate a drive or connected equipment that has damaged or missing parts. You can cause damage to the drive and connected equipment.*

**NOTICE** *Install branch circuit protection, for example fuses or ground fault circuit interrupters (GFCIs) as specified in the drive instructions. If you do not install these components, it can cause damage to the drive and connected equipment.*

**NOTICE** *Do not use unshielded wire for control wiring. Use shielded, twisted-pair wires and ground the shield to the ground terminal of the drive. Unshielded wire can cause electrical interference and unsatisfactory system performance.*

**NOTICE** *Make sure that all connections are correct after you install the drive and connect peripheral devices. Incorrect connections can cause damage to the drive.*

**NOTICE** *Do not connect phase-advancing capacitors, LC/RC noise filters, or leakage breakers (GFCI) to the motor circuit. If you connect these devices to the output circuits, it can cause damage to the drive and connected equipment.*

**NOTICE** *Use an inverter-duty motor or vector-duty motor with reinforced insulation and windings applicable for use with an AC drive. If the motor does not have the correct insulation, it can cause a short circuit or ground fault from insulation deterioration.*

**NOTICE** *Damage to Equipment. Do not energize and de-energize the drive more frequently than one time each 30 minutes. If you frequently energize and de-energize the drive, it can cause drive failure.*



**NOTICE** *Damage to Equipment. Do not cycle the Main Switch more than 6000 times. If you cycle the Main Switch more times than the limit, it will cause the contact failure, or you cannot open or close the Main Switch.*

**NOTICE** *Damage to Equipment. Make sure that you stop the motor before you turn ON/OFF the Main Switch. If you turn ON/OFF the Main Switch during run, it can cause Main Switch failure.*

**Note:**

Do not use unshielded wire for control wiring. Use shielded, twisted-pair wires and ground the shield to the ground terminal of the drive. Unshielded wire can cause electrical interference and unsatisfactory system performance.

## ◆ Exclusion of Liability

- This product is not designed and manufactured for use in life-support machines or systems.
- Contact a Yaskawa representative or your Yaskawa sales representative if you are considering the application of this product for special purposes, such as machines or systems used for passenger cars, medicine, airplanes and aerospace, nuclear power, electric power, or undersea relaying.

**▲ WARNING** *Injury to Personnel. When you use this product in applications where its failure could cause the loss of human life, a serious accident, or physical injury, you must install applicable safety devices. If you do not correctly install safety devices, it can cause serious injury or death.*

## 3 Cybersecurity

This product is designed to connect and communicate information and data through a network interface. It is the sole responsibility of the customer to provide and continuously guarantee a secure connection between the product and the customer's network or if applicable, any other network. The customer must establish and maintain the appropriate measures (such as, but not limited to, the installation of firewalls, the application of authentication measures, the encryption of data, the installation of antivirus programs, etc.) to protect the product, the network, its system and the interface against all types of security breaches, unauthorized access, interference, intrusion, leakage and/or theft of data or information. Yaskawa and its affiliates are not responsible for damages and/or losses related to such security breaches, any unauthorized access, interference, intrusion, leakage and/or theft of data or information.

## 4 Receiving

1. Examine the product for damage and missing parts. Immediately contact the shipping company if the drive is damaged. The Yaskawa warranty does not cover damage from shipping.
2. Verify the catalog code in the "C/C" section of the drive nameplate to make sure that you received the correct model.
3. If you did not receive the correct drive or if your drive does not operate correctly, contact your supplier.
4. Examine each drive and each motor for systems that use more than one drive.

**NOTICE** *Damage to Equipment. Do not install or use damaged parts or damaged motors into the drive system.*

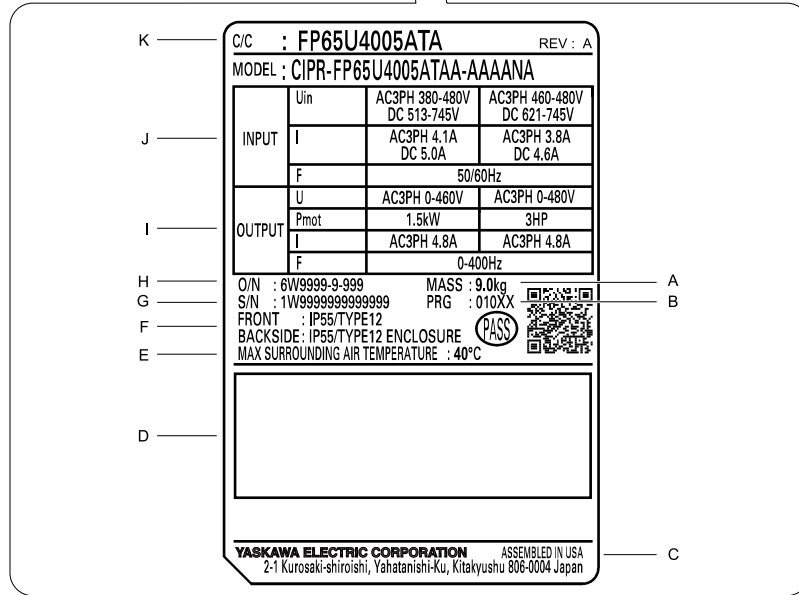
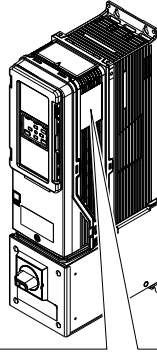

- A - Weight
- B - Drive software version
- C - The address of the head office of Yaskawa Electric Corporation
- D - Accreditation standards
- E - Surrounding air temperature
- F - Protection design
- G - Serial number
- H - Lot number
- I - Output specifications
- J - Input specifications
- K - Catalog code

Figure 4.1 Nameplate Example

### ◆ How to Read Catalog Codes

Use the information in Figure 4.2 and Table 4.1 to read the drive catalog codes.

**FP65 U 4 005 A T A**  
 1    2    3    4    5    6    7

Figure 4.2 Drive Catalog Code

Table 4.1 Catalog Code Details

No.	Description
1	Product series
2	Region code U: the Americas
3	Input power supply voltage • 2: Three-Phase 200 Vac to 240 Vac • 4: Three-Phase 380 Vac to 480 Vac

No.	Description
4	Rated output current <b>Note:</b> Refer to the rated output current list for more information.
5	EMC filter A: No built-in EMC filter
6	Protection design T: IP55/UL Type 12 with Main Switch <i>*1</i>
7	Environmental specification A: Standard

\*1 IP55/UL Type 12 drives with Main Switch are certified as IP55 Category 2 as specified by IEC60529.

## ■ Rated Output Current

Table 4.2 and Table 4.3 give the rated output current values.

### Note:

- These output current values are applicable for drives that operate at standard specifications.
- Derate the current in applications that:
  - Increase the carrier frequency
  - Have high ambient temperature
  - Use side-by-side installation.

**Table 4.2 Output Current for Three-Phase AC 208 V Class Models (NEMA Rating)**

Model	Maximum Applicable Motor Output kW (HP)	Rated Output Current A
2011	2.2 (3)	10.6
2017	3.7 (5)	16.7
2024	5.5 (7.5)	24.2
2031	7.5 (10)	30.8
2046	11 (15)	46.2
2059	15 (20)	59.4
2075	18.5 (25)	74.8
2088	22 (30)	88
2114	30 (40)	114

**Table 4.3 Output Current for Three-Phase AC 480 V Class Models (NEMA Rating)**

Model	Maximum Applicable Motor Output kW (HP)	Rated Output Current A
4005	2.2 (3)	4.8
4008	3.7 (5)	7.6
4011	5.6 (7.5)	11
4014	7.5 (10)	14
4021	11.2 (15)	21
4027	15 (20)	27
4034	18.6 (25)	34
4040	22 (30)	40
4052	30 (40)	52
4065	37 (50)	65
4077	45 (60)	77
4096	56 (75)	96

## 5 Common Drive Specifications

### Note:

To get the longest product life, install the drive in an environment that meets the necessary specifications.

**Table 5.1 Control Characteristics**

Item	Specification
Control Methods	<ul style="list-style-type: none"> <li>V/f Control (V/f)</li> <li>PM Open Loop Vector Control (OLV/PM)</li> <li>EZ Open Loop Vector Control (EZOLV)</li> </ul>
Frequency Control Range	<ul style="list-style-type: none"> <li>EZOLV: 0.01 Hz to 120 Hz</li> <li>V/f and OLV/PM: 0.01 Hz to 400 Hz</li> </ul>
Frequency Accuracy (Temperature Fluctuation)	Digital inputs: Within $\pm 0.01\%$ of the maximum output frequency ( $-10\text{ }^{\circ}\text{C}$ to $+40\text{ }^{\circ}\text{C}$ ( $14\text{ }^{\circ}\text{F}$ to $104\text{ }^{\circ}\text{F}$ )) Analog inputs: Within $\pm 0.1\%$ of the maximum output frequency ( $25\text{ }^{\circ}\text{C} \pm 10\text{ }^{\circ}\text{C}$ ( $77\text{ }^{\circ}\text{F} \pm 18\text{ }^{\circ}\text{F}$ ))
Frequency Setting Resolution	Digital inputs: 0.01 Hz Analog inputs: 1/2048 of the maximum output frequency (11-bit)
Output Frequency Resolution	0.001 Hz
Frequency Setting Signal	Main speed frequency reference: 0 Vdc to 10 Vdc (20 k $\Omega$ ), 4 mA to 20 mA (250 $\Omega$ ), 0 mA to 20 mA (250 $\Omega$ ) Main speed reference: Pulse train input (maximum 32 kHz)
Starting Torque	<ul style="list-style-type: none"> <li>V/f: 140%/3 Hz</li> <li>OLV/PM: 100%/10% speed</li> <li>EZOLV: 100%/10% speed</li> </ul>
Speed Control Range	<ul style="list-style-type: none"> <li>For Induction Motors: <ul style="list-style-type: none"> <li>V/f: 1:40</li> <li>EZOLV: 1:10</li> </ul> </li> <li>For Permanent Magnet Motors and Synchronous Reluctance Motors: <ul style="list-style-type: none"> <li>OLV/PM: 1:20</li> <li>EZOLV: 1:10</li> </ul> </li> </ul>
Torque Limits	Parameter settings allow different limits in four quadrants in EZOLV control method.
Accel/Decel Time	0.0 s to 6000.0 s The drive can set two pairs of different acceleration and deceleration times.
V/f Characteristics	Select from 15 pre-defined V/f patterns, or a user-set V/f pattern.
Main Control Functions	Restart After Momentary Power Loss, Speed Search, Overtorque/Undertorque Detection, Torque Limit, 17 Step Speed (max.), Accel/Decel Switch, S-curve Acceleration/Deceleration, 3-wire Sequence, Auto-Tuning (Rotational and Stationary), Dwell Function, Cooling Fan ON/OFF Switch, Slip Compensation, Torque Compensation, Jump Frequency, Upper/Lower Limits for Frequency Reference, DC Injection Braking at Start and Stop, Overexcitation Braking, High Slip Braking, PID Control (with Sleep Function), Energy Saving Control, MEMOBUS/Modbus Communication (RS-485 max. 115.2 kbps), Auto Restart, Application Presets, KEB, Overexcitation Deceleration, Overvoltage Suppression

**Table 5.2 Protection Functions**

Item	Specification
Motor Protection	Electronic thermal overload protection
Momentary Overcurrent Protection	Drive stops when the output current is more than 175% of the drive rated output current.
Overload Protection	Drive stops when the output current is more than these overload tolerances: <ul style="list-style-type: none"> <li>110% of the rated output current for 60 seconds</li> <li>140% of the rated output current for 2.5 seconds when the drive output frequency is 3 Hz</li> </ul> The permitted frequency of overload is one time each 10 minutes. <b>Note:</b> If output frequency < 6 Hz, the drive can trigger the overload protection function when the output current is in the overload tolerance range.
Overvoltage Protection	208 V class: Stops when the DC bus voltage is more than approximately 410 V 480 V class: Stops when the DC bus voltage is more than approximately 820 V

Item	Specification
Undervoltage Protection	<p>208 V class: Stops when the DC bus voltage decreases to less than approximately 190 V</p> <p>480 V class:</p> <ul style="list-style-type: none"> <li>• Stops when the DC bus voltage decreases to less than approximately 350 V when you use an input voltage less than 400 V</li> <li>• Stops when the DC bus voltage decreases to less than approximately 380 V when you use an input voltage less than 460 V</li> <li>• Stops when the DC bus voltage decreases to less than approximately 440 V when you use an input voltage of 460 V or more</li> </ul> <p>208 V class: Stops when the DC bus voltage decreases to less than approximately 190 V</p> <p>480 V class:</p> <ul style="list-style-type: none"> <li>• Stops when the DC bus voltage decreases to less than approximately 350 V when you use an input voltage less than 400 V</li> <li>• Stops when the DC bus voltage decreases to less than approximately 380 V when you use an input voltage less than 460 V</li> <li>• Stops when the DC bus voltage decreases to less than approximately 440 V when you use an input voltage of 460 V or more</li> </ul>
Momentary Power Loss Ride-thru	<p>Immediately stops when power loss is 15 ms or longer.</p> <p>Continues operation if power loss is shorter than 2 s (depending on parameter settings).</p> <p><b>Note:</b></p> <p>Stop time may be shortened depending on the load and motor speed.</p>
Heatsink Overheat Protection	The drive stops when the thermistor detects an IGBT temperature more than approximately 100 °C (212 °F). The trip temperature level is different for different drive models.
Stall Prevention	Stall prevention is available during acceleration, deceleration, and during run.
Ground Fault Protection	<p>Electronic circuit protection</p> <p><b>Note:</b></p> <p>This protection detects ground faults during run. The drive will not provide protection when:</p> <ul style="list-style-type: none"> <li>• There is a low-resistance ground fault for the motor cable or terminal block</li> <li>• Energizing the drive when there is a ground fault.</li> </ul>
DC Bus Charge LED	Charge LED illuminates when DC bus voltage is more than 50 V.

Table 5.3 Environment

Item	Specification
Area of Use	Indoors
Power Supply	Overvoltage Category III
Ambient Temperature Setting	<p>IP55/UL Type 12: -10 °C to +40 °C (14 °F to 104 °F)</p> <ul style="list-style-type: none"> <li>• When you install the drive in an enclosure, use a cooling fan or air conditioner to keep the internal air temperature in the permitted range.</li> <li>• Do not let the drive freeze.</li> <li>• You can use IP55/UL Type 12 drives at a maximum of 50 °C (122 °F) when you derate the output current.</li> </ul>
Humidity	<p>95% RH or less</p> <p>Do not let condensation form on the drive.</p>
Storage Temperature	-20 °C to +70 °C (-4 °F to +158 °F) (short-term temperature during transportation)
Surrounding Area	<p>Pollution degree 2 or less</p> <p>Install the drive in an area without:</p> <ul style="list-style-type: none"> <li>• Oil mist, corrosive or flammable gas, or dust</li> <li>• Metal powder, oil, water, or other unwanted materials</li> <li>• Radioactive materials or flammable materials, including wood</li> <li>• Harmful gas or fluids</li> <li>• Salt</li> <li>• Direct sunlight</li> </ul>
Altitude	<p>1000 m (3281 ft) maximum</p> <p><b>Note:</b></p> <p>Derate the output current by 1% for each 100 m (328 ft) to install the drive in altitudes between 1000 m to 4000 m (3281 ft to 13123 ft).</p> <p>It is not necessary to derate the rated voltage in these conditions:</p> <ul style="list-style-type: none"> <li>• When you install the drive at 2000 m (6562 ft) or lower</li> <li>• When you install the drive between 2000 m to 4000 m (6562 ft to 13123 ft) and ground the neutral point on the power supply.</li> </ul>
Vibration	<ul style="list-style-type: none"> <li>• 10 Hz to 20 Hz: 1 G (9.8 m/s<sup>2</sup>, 32.15 ft/s<sup>2</sup>)</li> <li>• 20 Hz to 55 Hz: 0.2 G (1.96 m/s<sup>2</sup>, 6.43 ft/s<sup>2</sup>)</li> </ul>
Installation Orientation	Install the drive vertically for sufficient airflow to cool the drive.

Table 5.4 Standard

Item	Specification
Harmonized Standard	<ul style="list-style-type: none"> <li>• UL 508C</li> <li>• EN 61800-3</li> <li>• IEC/EN 61800-5-1</li> <li>• Two Safe Disable inputs and one EDM output according to EN ISO 13849-1:2015 (PL e (Cat.III)), IEC/EN 61508 SIL3</li> </ul>

Table 5.5 Enclosure Ratings

Item	Specification
Protection Design	IP55/UL Type 12 with Main Switch

### ◆ Area of Use

Install this product in a location with Overvoltage Category III and pollution degree 2 or less.

### ■ Ambient Temperature Setting

Maintain an ambient temperature between -10 °C to +40 °C (14 °F to 104 °F) for IP55/UL Type 12 drives.

## 6 Mechanical Installation

This section gives information about the standard environment for correct installation.

### ◆ Moving the Drive

Obey local laws and regulations when moving and installing this product.

**▲ CAUTION** *Crush Hazard. Tighten terminal cover screws and hold the case safely when you move the drive. If the drive or covers fall, it can cause moderate injury.*

Drive Weight	Persons Necessary to Move the Drive
< 15 kg (33 lbs.)	1
≥ 15 kg (33 lbs.)	2 + using appropriate lifting equipment

Refer to the Technical Reference for information about how to use suspension systems, wires, or hanging metal brackets to move the drive.

### ◆ Using the Hanging Brackets to Move the Drive

Use the hanging brackets attached to the drive to temporarily lift the drive when you install the drive to a control panel or wall or when you replace the drive. Do not let the drive stay vertically or horizontally suspended or move the drive over a long distance while it is suspended.

Before you install the drive, make sure that you read these precautions:

**▲ WARNING** *Crush Hazard. Before you hang the drive vertically, use screws to correctly attach the drive front cover and other drive components. If you do not secure the front cover, it can fall and cause minor injury.*

**▲ WARNING** *Crush Hazard. When you use a crane or hoist to lift the drive during installation or removal, prevent more than 1.96 m/s<sup>2</sup> (0.2 G) vibration or impact. Too much vibration or impact can cause serious injury or death from falling equipment.*

**▲ WARNING** *Crush Hazard. When you lift the drive during installation or removal, do not try to turn the drive over and do not ignore the hanging drive. If you move a hanging drive too much or if you ignore it, the drive can fall and cause serious injury or death.*

**▲ WARNING** *Crush Hazard. When you install the drive, do not hold the front cover. Install the drive with holding the heatsink. If you hold the front cover, the cover will come off and the drive will fall, then it can cause injury.*

### ◆ Installation Position and Distance

Install the drive vertically for sufficient airflow to cool the drive.

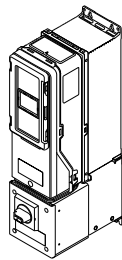

A

A - Vertical installation

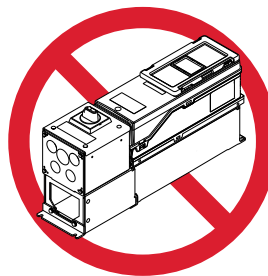

B

B - Horizontal installation

Figure 6.1 Installation Position

### ■ Single Drive Installation

Use the clearances specified in Figure 6.2 to install the drive. Make sure that there is sufficient space for wiring and airflow.

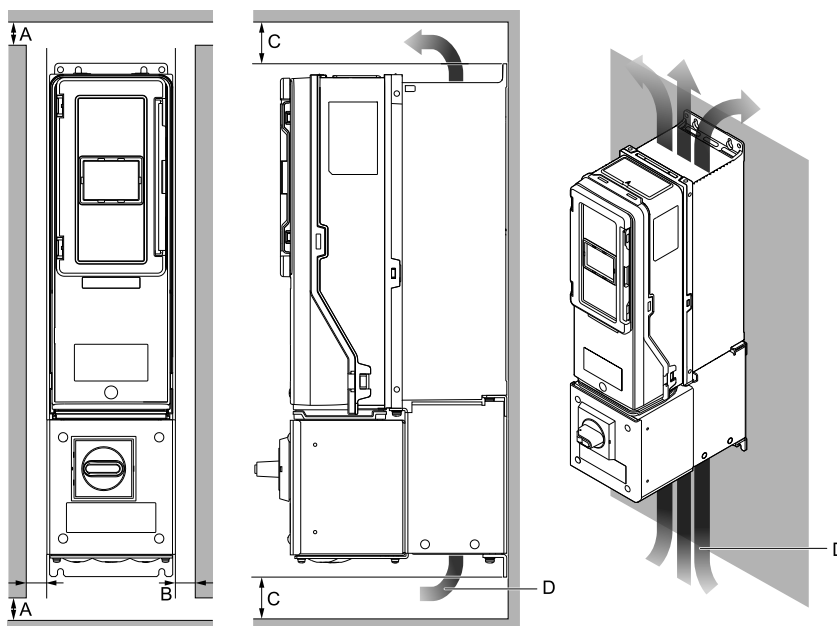

A - 50 mm (2 in) minimum  
B - 30 mm (1.2 in) minimum \*1

C - 120 mm (4.7 in) minimum \*2  
D - Airflow direction

Figure 6.2 Single Drive Installation Distances

- \*1 50 mm (2 in) minimum is necessary to remove the front cover.
- \*2 This is the distance from a drive component or mounting bracket that has the maximum height. The highest component of the drive is different for different models.

### ■ Installing More than One Drive Adjacent to Each Other without Derating

Use the clearances specified in Figure 6.3. Make sure that there is sufficient space.

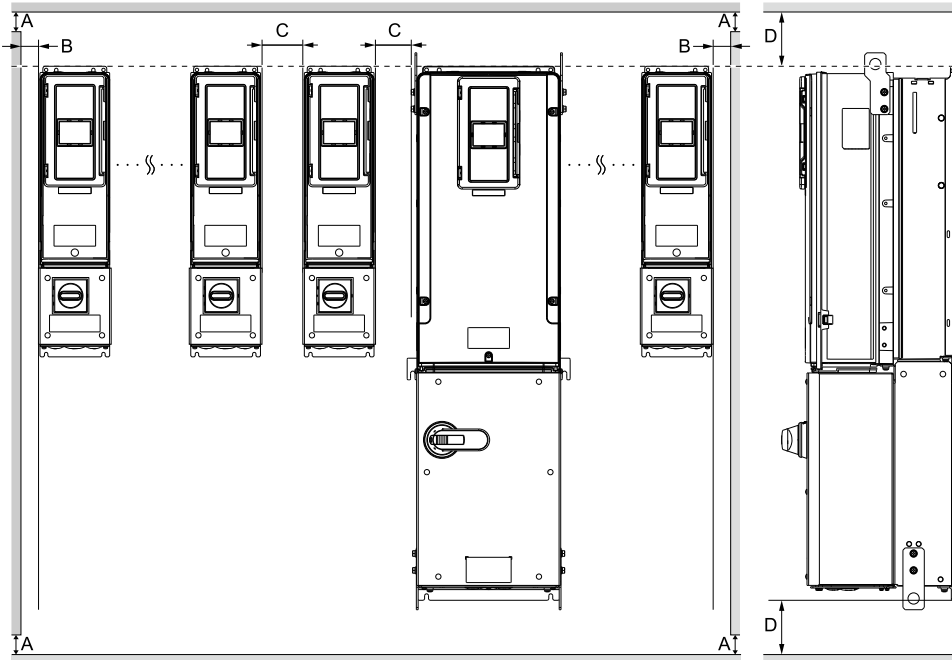

A - 50 mm (2 in) minimum  
B - 30 mm (1.2 in) minimum

C - 60 mm (2.4 in) minimum  
D - 120 mm (4.7 in) minimum

**Figure 6.3 Installation Distances for More than One Drive without Derating**

**Note:**

Align the tops of drives that have different dimensions to help when you replace cooling fans.

## ◆ Removing/Reattaching Covers

This section gives information about how to remove and reattach the front cover and terminal cover for wiring and inspection.

**⚠ DANGER** *Electrical Shock Hazard. Do not examine, connect, or disconnect wiring on an energized drive. Before servicing, disconnect all power to the equipment and wait for the time specified on the warning label at a minimum. The internal capacitor stays charged after the drive is de-energized. The charge indicator LED extinguishes when the DC bus voltage decreases below 50 Vdc. When all indicators are OFF, remove the covers before measuring for dangerous voltages to make sure that the drive is safe. If you do work on the drive when it is energized, it will cause serious injury or death from electrical shock.*

### ■ Remove the Front Cover

1. Make sure that the drive main power supply is completely shut off.
2. Push in the two tabs on the right side of the IP55/UL Type 12 keypad cover door and pull the door to the left to open.

**NOTICE** *Damage to Equipment. Do not open the IP55/UL Type 12 keypad cover door too far. If you open the door too far, it will fall off.*

**NOTICE** *Damage to Equipment. When the IP55/UL Type 12 keypad cover door is open, do not push the keypad key cover. If you push the keypad key cover, it will fall off.*



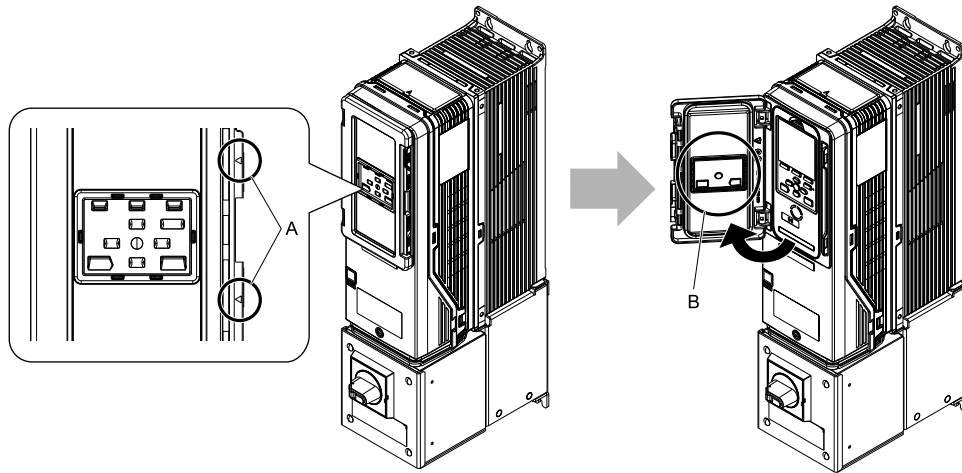

A - Tabs

B - Keypad key cover

**Figure 6.4 Open the IP55/UL Type 12 Keypad Cover Door**

3. Remove the keypad from the drive.

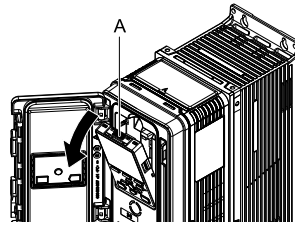

A - Keypad

**Figure 6.5 Remove the Keypad**

4. Loosen the front cover screw.

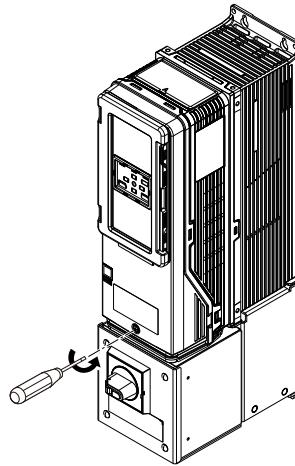

**Figure 6.6 Loosen the Front Cover Screw**

5. Push in the tabs on the sides of the front cover and pull the front cover forward to remove it from the drive.

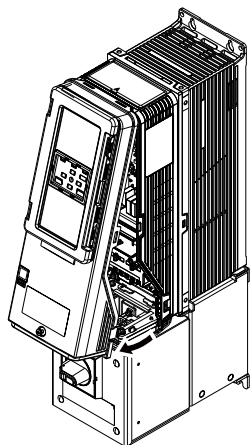

Figure 6.7 Remove the Front Cover

### ■ Reattach the Front Cover

1. Wire the drive and other peripheral devices.
2. Reverse the steps to reattach the cover. Reattach the cover carefully and make sure that the gasket on the conduit bracket does not twist.

**Note:**

- Make sure that you did not pinch wires or signal lines between the front cover and the drive before you reattach the cover.
- Make sure that the tabs on the sides of the front cover correctly click into the hook.
- Tighten the screws to a tightening torque of 0.98 N·m (8.67 lbf·in) to 1.33 N·m (11.77 lbf·in).

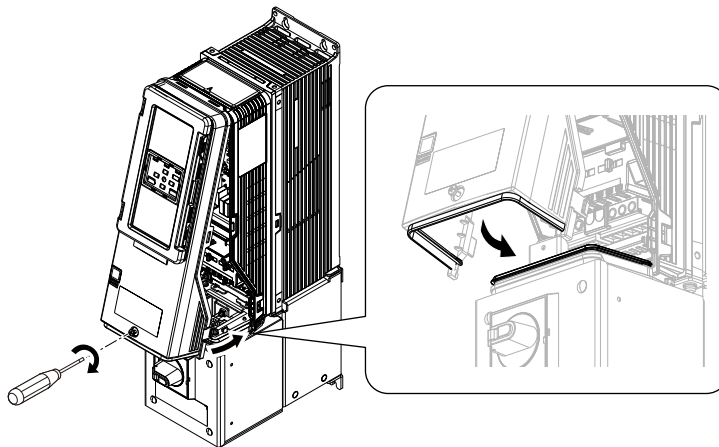

Figure 6.8 Reattach the Front Cover

3. Open the IP55/UL Type 12 keypad cover door and reattach the keypad to its initial position, then close the door until the two tabs click into position.

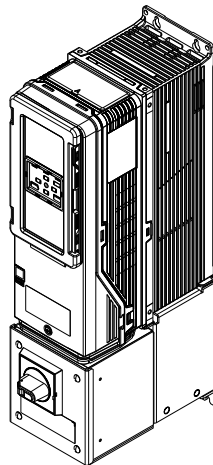
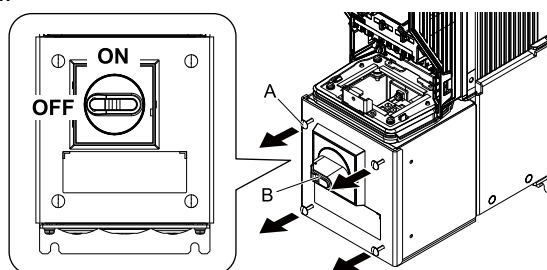

Figure 6.9 Reattach the Keypad and Close the Keypad Cover Door

### ■ Remove the Main Switch Cover

1. Make sure that the Main Switch Disconnect Handle is in the OFF position, then loosen the captive front cover screws on the Main Switch.



A - Screws

B - Main Switch Disconnect Handle

Figure 6.10 Loosen the Screws on the Main Switch Cover

2. Pull the cover forward to remove it from the drive.

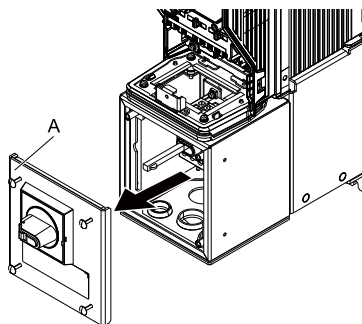

A - Main Switch cover

Figure 6.11 Remove the Main Switch Cover

## ■ Reattach the Main Switch Cover

1. Make sure that the Main Switch Disconnect Handle is in the OFF position, then reverse the steps to reattach the cover.

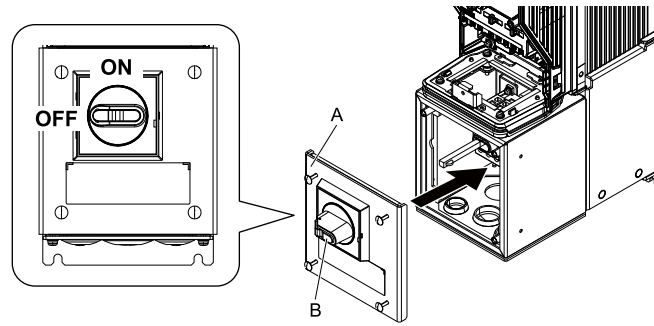

A - Main Switch cover

B - Main Switch Disconnect Handle

Figure 6.12 Reattach the Main Switch Cover

2. Tighten the screws on the Main Switch cover.

### Note:

Tighten the screws to a tightening torque of 0.98 N·m to 1.33 N·m (8.67 lbf·in to 11.77 lbf·in).

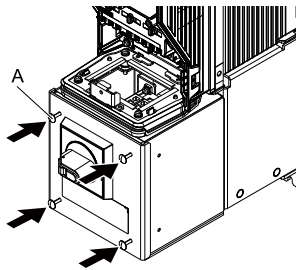

A - Screws

Figure 6.13 Tighten the Screws on the Main Switch Cover

## 7 Electrical Installation

**⚠ DANGER** *Electrical Shock Hazard. Do not examine, connect, or disconnect wiring on an energized drive. Before servicing, disconnect all power to the equipment and wait for the time specified on the warning label at a minimum. The internal capacitor stays charged after the drive is de-energized. The charge indicator LED extinguishes when the DC bus voltage decreases below 50 Vdc. When all indicators are OFF, remove the covers before measuring for dangerous voltages to make sure that the drive is safe. If you do work on the drive when it is energized, it will cause serious injury or death from electrical shock.*

**⚠ WARNING** *Electrical Shock Hazard. De-energize the drive and wait 5 minutes minimum until the Charge LED turns off. Remove the front cover and terminal cover to do work on wiring, circuit boards, and other parts. Use terminals for their correct function only. Incorrect wiring, incorrect ground connections, and incorrect repair of protective covers can cause death or serious injury.*

**⚠ WARNING** *Electrical Shock Hazard. Correctly ground the drive before you turn on the EMC filter switch. If you touch electrical equipment that is not grounded, it can cause serious injury or death.*

**⚠ WARNING** *Electrical Shock Hazard. Use the terminals for the drive only for their intended purpose. Refer to the technical manual for more information about the I/O terminals. Wiring and grounding incorrectly or modifying the cover may damage the equipment or cause injury.*

### ◆ Standard Connection Diagram

**⚠ WARNING** *Sudden Movement Hazard. Set the MFDI parameters before you close control circuit switches. Incorrect Run/Stop circuit sequence settings can cause serious injury or death from moving equipment.*

**⚠ WARNING** *Sudden Movement Hazard. Correctly wire the start/stop and safety circuits before you energize the drive. If you momentarily close a digital input terminal, it can start a drive that is programmed for 3-Wire control and cause serious injury or death from moving equipment.*

**⚠ WARNING** *Sudden Movement Hazard. When you use a 3-Wire sequence, set A1-03 = 3330 [Initialize Parameters = 3-Wire Initialization] and make sure that b1-17 = 0 [Run Command at Power Up = Disregard Existing RUN Command]. If you do not correctly set the drive parameters for 3-Wire operation before you energize the drive, the motor can suddenly rotate in reverse when you energize the drive.*

**⚠ WARNING** *Sudden Movement Hazard. Check the I/O signals and the external sequences for the drive before you set the Application Preset function. When you set the Application Preset function (A1-06 ≠ 0), it changes the I/O terminal functions for the drive and it can cause equipment to operate unusually. This can cause serious injury or death.*

**⚠ WARNING** *Fire Hazard. Install sufficient branch circuit short circuit protection as specified by applicable codes and this manual. The drive is suitable for circuits that supply not more than 100,000 RMS symmetrical amperes, 240 Vac maximum (208 V Class), 480 Vac maximum (480 V Class). Incorrect branch circuit short circuit protection can cause serious injury or death.*

**NOTICE** *When the input voltage is 440 V or higher or the wiring distance is longer than 100 m (328 ft), make sure that the motor insulation voltage is sufficient or use an inverter-duty motor or vector-duty motor with reinforced insulation. Motor winding and insulation failure can occur.*

**Note:**

Do not connect the AC control circuit ground to the drive enclosure. Incorrect ground wiring can cause the control circuit to operate incorrectly.

■ Standard Drive Connection Diagram

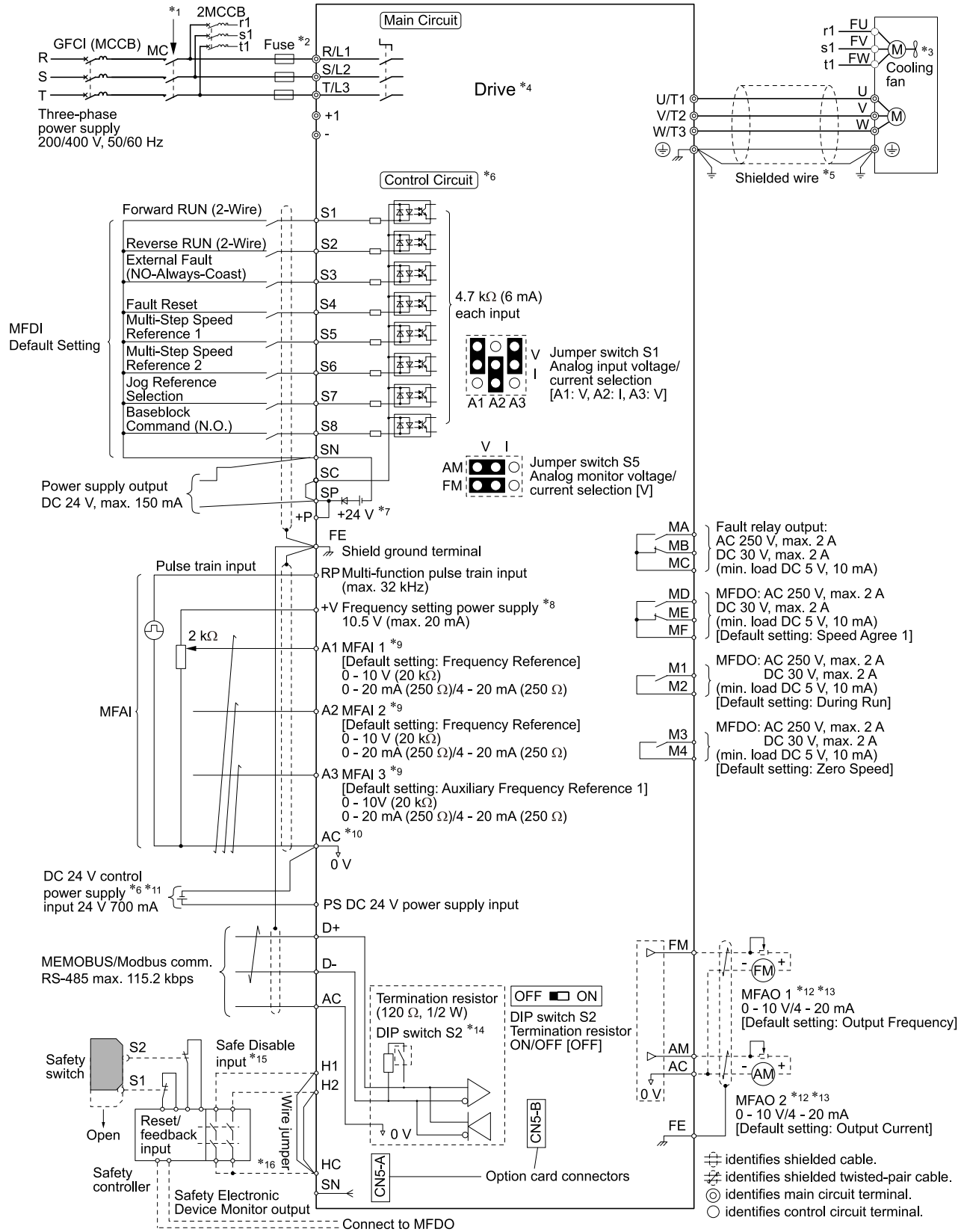

Figure 7.1 Standard Drive Connection Diagram

- \*1 Set the wiring sequence to de-energize the drive with the fault relay output. If the drive outputs a fault during fault restart when you use the fault restart function, set  $L5-02 = 1$  [*Fault Contact at Restart Select = Always Active*] to de-energize the drive. Be careful when you use a cut-off sequence. The default setting for  $L5-02$  is  $0$  [*Active Only when Not Restarting*].
- \*2 Use branch circuit protection devices as recommended in this manual.
- \*3 Cooling fan wiring is not necessary for self-cooling motors.
- \*4 Refer to [Main Circuit Terminal Block Wiring on page 26](#) and [Wiring the Control Circuit Terminal on page 50](#) for wiring.
- \*5 Use braided shield cable for the drive and motor wiring, or run the wiring through a metal conduit.
- \*6 Connect a 24 V power supply to terminals PS-AC to operate the control circuit while the main circuit power supply is OFF.
- \*7 To set the MFDI power supply (Sinking/Sourcing Mode or internal/external power supply), install or remove a jumper between terminals SC-SP or SC-SN depending on the application.

**NOTICE** *Damage to Equipment. Do not close the circuit between terminals SP-SN. If you close the circuits between terminals SC-SP and terminals SC-SN at the same time, it will cause damage to the drive.*

- Sinking Mode, Internal power supply: Install the jumper to close the circuit between terminals SC-SP.

**NOTICE** *Damage to Equipment. Do not close the circuit between terminals SC-SN. If you close the circuits between terminals SC-SP and terminals SC-SN at the same time, it will cause damage to the drive.*

- Sourcing Mode, Internal power supply: Install the jumper to close the circuit between terminals SC-SN.

**NOTICE** *Damage to Equipment. Do not close the circuit between terminals SC-SP. If you close the circuits between terminals SC-SP and terminals SC-SN at the same time, it will cause damage to the drive.*

- External power supply: Remove the jumper from the MFDI terminals. It is not necessary to close the circuit between terminals SC-SP and terminals SC-SN.

- \*8 The maximum output current capacity for terminal +V on the control circuit is 20 mA.

**NOTICE** *Damage to Equipment. Do not install a jumper between terminals +V and AC. A closed circuit between these terminals will cause damage to the drive.*

- \*9 Jumper switch S1 sets terminals A1, A2, and A3 for voltage or current input signal. The default setting for S1 is voltage input (“V” side) for A1 and A3 and current input (“I” side) for A2.

- \*10 **NOTICE** *Do not ground the AC control circuit terminals and only connect the AC terminals according to the product instructions. If you connect the AC terminals incorrectly, it can cause damage to the drive.*

- \*11 Connect the positive lead from an external 24 Vdc power supply to terminal PS and the negative lead to terminal AC.

**NOTICE** *Connect terminals PS and AC correctly for the 24 V power supply. If you connect the wires to the incorrect terminals, it will cause damage to the drive.*

- \*12 Use multi-function analog monitor outputs with analog frequency meters, ammeters, voltmeters, and wattmeters. Do not use monitor outputs with feedback-type signal devices.
- \*13 Jumper switch S5 sets terminal FM and AM for voltage or current output. The default setting for S5 is voltage output (“V” side).
- \*14 Set DIP switch S2 to “ON” to enable the termination resistor in the last drive in a MEMOBUS/Modbus network.
- \*15 Use only Sourcing Mode for Safe Disable input.
- \*16 Disconnect the jumpers between H1 and HC and H2 and HC to use the Safe Disable input.

## ◆ Main Circuit Terminal Functions

Refer to [Table 7.1](#) for the functions of drive main circuit terminals.

**Table 7.1 Main Circuit Terminal Functions**

Terminal	Function
R/L1	Line side
S/L2	
T/L3	
U/T1	Load side
V/T2	
W/T3	
-	N/A
+1	
	Ground terminal

## ◆ Motor and Main Circuit Connections

**⚠ WARNING** *Electrical Shock Hazard. Do not connect terminals R/L1, S/L2, T/L3, U/T1, V/T2, W/T3, -, or +1 to the ground terminal. If you connect these terminals to earth ground, it can cause damage to the drive or serious injury or death.*

### ■ Wiring the Main Circuit and Motor

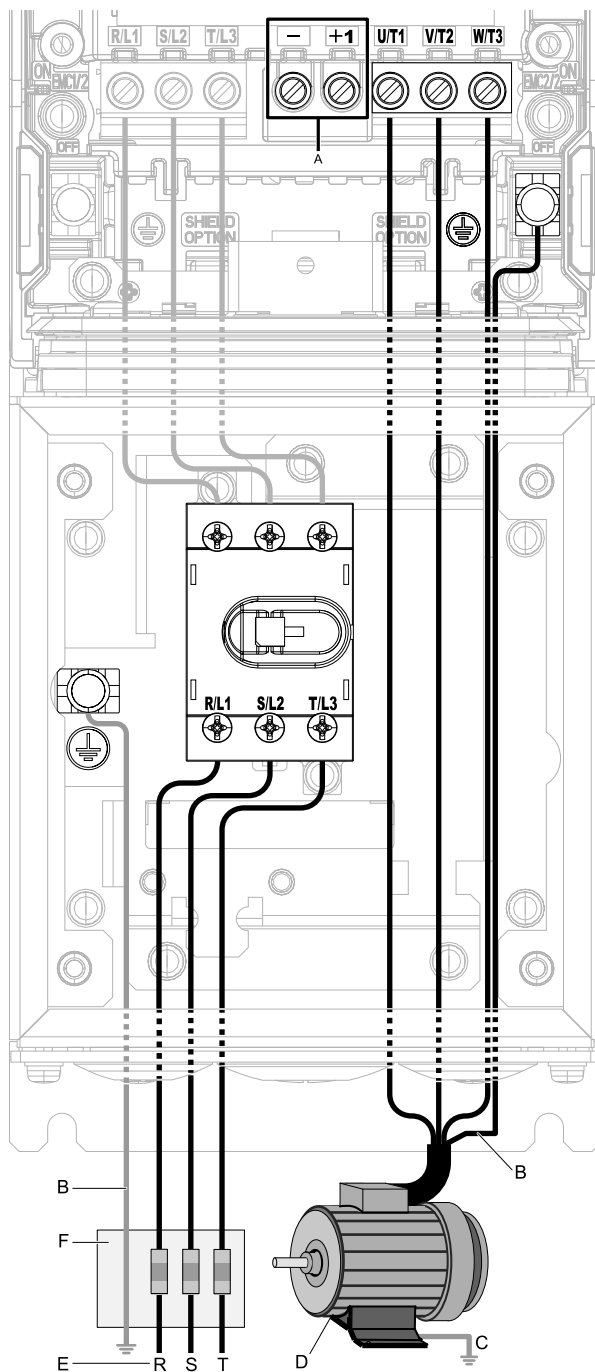

#### Note:

The location of terminals are different for different drive models.

**A** - DC bus terminal <sup>\*/</sup>

**B** - Connect to the drive ground terminal.

**C** - Ground the motor case.

**D** - Three-Phase Motor

**E** - Use R, S, T for input power supply.

**F** - Input Protection (Fuses or Circuit Breakers)

Figure 7.2 Wiring the Main Circuit and Motor



\*1 You cannot use terminals - and +1 on IP55/UL Type 12 drives with Main Switch.

For 2011 to 2059 and 4005 to 4065, the tightening torques for the R/L1, S/L2, and T/L3 terminal screws are on a sticker next to the Main Switch terminal block.

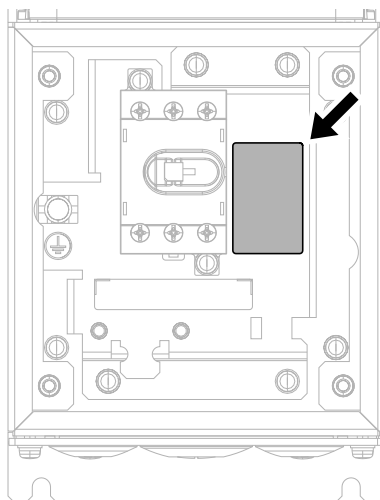

**Figure 7.3 Tightening Torque Display Location (Inside of Main Switch Cover)**

For models 2075 to 2114 and 4077 to 4096, the torques for the R/L1, S/L2, and T/L3 terminal screws are on a sticker on the metallic plate of the Main Switch terminal block.

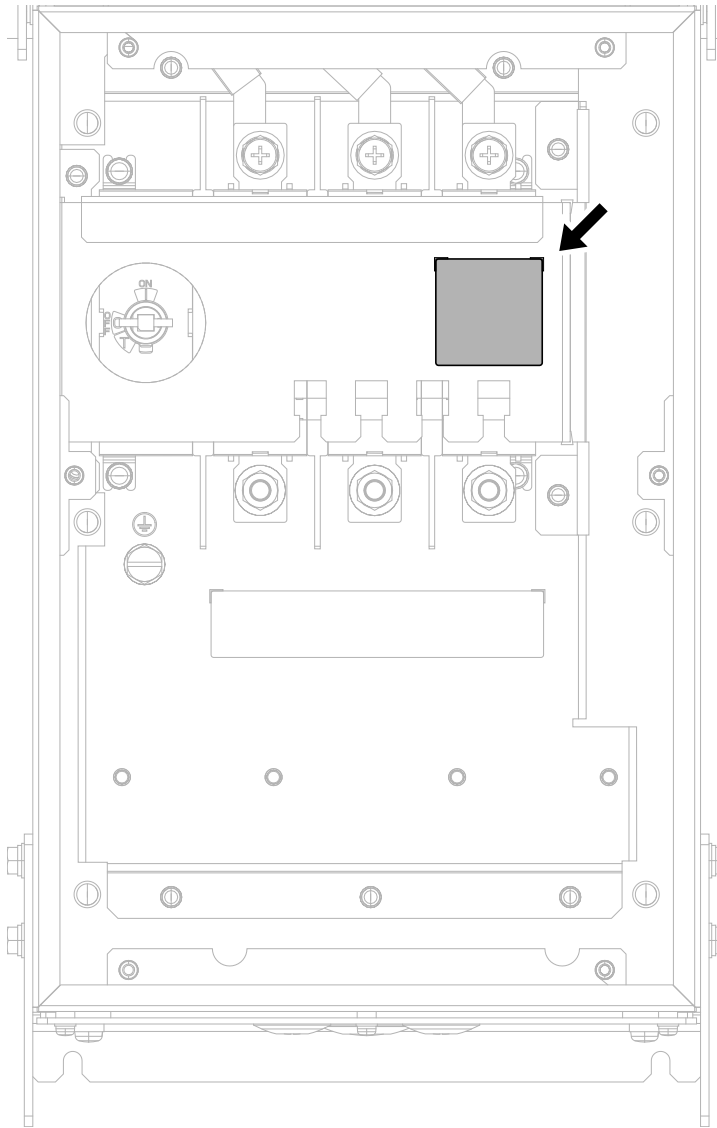

Figure 7.4 Tightening Torque Display Location (Inside of Main Switch Cover)

## ◆ Main Circuit Terminal Block Wiring

### ■ Wire Selection

Select the correct wires for main circuit wiring.

Refer to [Main Circuit Wire Gauges and Tightening Torques on page 75](#) for wire gauges and tightening torques as specified by European standards.

Refer to [Wire Gauge and Torque Specifications for UL Listing on page 27](#) for wire gauges and tightening torques as specified by UL standards.

### Wire Selection Precautions

**⚠ WARNING** *Electrical Shock Hazard. Make sure that the protective ground wire complies with technical standards and local safety regulations. The IEC/EN 61800-5-1:2007 standard specifies that you must wire the power supply to automatically de-energize when the protective ground wire disconnects. You can also connect a protective ground wire that has a minimum cross-sectional area of 10mm<sup>2</sup> (copper wire) or 16 mm<sup>2</sup> (aluminum wire). For drive models on which you cannot use a protective ground wire of 10 mm<sup>2</sup> or more, install two protective ground wires that have the same cross-sectional area. If you do not obey the standards and regulations, it can cause serious injury or death. The leakage current of the drive will be more than 3.5 mA.*

Think about line voltage drop before you select wire gauges. Select wire gauges that drop the voltage by 2% or less of the rated voltage. Increase the wire gauge and the cable length when the risk of voltage drop increases. Calculate line voltage drop with this formula:

$$\text{Line voltage drop (V)} = \sqrt{3} \times \text{wire resistance } (\Omega/\text{km}) \times \text{wiring distance (m)} \times \text{motor rated current (A)} \times 10^{-3}$$

### Wire Gauge and Torque Specifications for UL Listing

**⚠ WARNING** *Electrical Shock Hazard. Make sure that the protective ground wire complies with technical standards and local safety regulations. The IEC/EN 61800-5-1:2007 standard specifies that you must wire the power supply to automatically de-energize when the protective ground wire disconnects. You can also connect a protective ground wire that has a minimum cross-sectional area of 10mm<sup>2</sup> (copper wire) or 16 mm<sup>2</sup> (aluminum wire). For drive models on which you cannot use a protective ground wire of 10 mm<sup>2</sup> or more, install two protective ground wires that have the same cross-sectional area. If you do not obey the standards and regulations, it can cause serious injury or death. The leakage current of the drive will be more than 3.5 mA.*

Refer to [Three-Phase 208 V Class Wire Gauges and Torques on page 27](#) and [Three-Phase 480 V Class Wire Gauges and Torques on page 29](#) for the recommended wire gauges and tightening torques of the main circuit terminals.









#### Note:

The recommended wire gauges are based on drive continuous current ratings with 75 °C (167 °F) 600 V class copper wire. Assume these conditions:













- Ambient temperature: 40 °C (104 °F) or lower
- Wiring distance: 100 m (3281 ft) or shorter
- Normal Duty Rated current value

### Screw Shapes

























Table 7.2 Icons to Identify Screw Shapes

Icon	Screw Shape	Icon	Screw Shape
	Phillips/slot combo (+/-)		Hex bolt (slotted)
	Slotted (-)		Hex self-locking nut
	Pozidriv #2		Hex socket cap (WAF: 4 mm)
	Hex bolt (cross-slotted)		Hex bolt and hex self-locking nut

### Three-Phase 208 V Class Wire Gauges and Torques

Model	Terminals *1	Recommended Gauge AWG, kcmil	Applicable Gauge AWG, kcmil (mm <sup>2</sup> ) *2	Wire Stripping Length *3 mm	Terminal Screw Size and Shape	Tightening Torque N·m (lbf·in)
2011	R/L1, S/L2, T/L3	14	14 - 8 (2.5 - 10)	9 - 10	M3.5 	0.8 (7.0)
	U/T1, V/T2, W/T3	14	14 - 8 (2.5 - 10)	10	M4 	1.5 - 1.7 (13.5 - 15)
		12	14 - 8 (2.5 - 10)	-	M5 	2.0 - 2.5 (17.7 - 22.1)
2017	R/L1, S/L2, T/L3	12	14 - 8 (2.5 - 10)	9 - 10	M3.5 	0.8 (7.0)
	U/T1, V/T2, W/T3	10	14 - 8 (2.5 - 10)	10	M4 	1.5 - 1.7 (13.5 - 15)
		10	14 - 8 (2.5 - 10)	-	M5 	2.0 - 2.5 (17.7 - 22.1)
2024	R/L1, S/L2, T/L3	10	14 - 4 (2.5 - 25)	AWG 14 - AWG 10: 13 - 14.5 AWG 8 - AWG 4: 10 - 12 *4	M5 	2.0 (18.0)
	U/T1, V/T2, W/T3	8	14 - 8 (2.5 - 10)	10	M4 	1.5 - 1.7 (13.5 - 15)
		10	14 - 8 (2.5 - 10)	-	M5 	2.0 - 2.5 (17.7 - 22.1)

## 7 Electrical Installation

Model	Terminals *1	Recommended Gauge AWG, kcmil	Applicable Gauge AWG, kcmil (mm <sup>2</sup> ) *2	Wire Stripping Length *3 mm	Terminal Screw Size and Shape	Tightening Torque N·m (lbf·in)
2031	R/L1, S/L2, T/L3	8	14 - 4 (2.5 - 25)	AWG 14 - AWG 10: 13 - 14.5 AWG 8 - AWG 4: 10 - 12 *4	M5 	2.0 (18.0)
	U/T1, V/T2, W/T3	8	14 - 8 (2.5 - 10)	10	M4 	1.5 - 1.7 (13.5 - 15)
		10	14 - 8 (2.5 - 10)	-	M5 	2.0 - 2.5 (17.7 - 22.1)
2046	R/L1, S/L2, T/L3	8	8 - 1/0 (10 - 50)	18 - 21	M8 	6.2 (55.0)
	U/T1, V/T2, W/T3	6	14 - 4 (2.5 - 25)	18	M5 	4.1 - 4.5 (36 - 40)
		8	14 - 4 (2.5 - 25)	-	M6 	4.0 - 5.0 (35.4 - 44.3)
2059	R/L1, S/L2, T/L3	4	8 - 1/0 (10 - 50)	18 - 21	M8 	6.2 (55.0)
	U/T1, V/T2, W/T3	4	14 - 4 (2.5 - 25)	18	M5 	4.1 - 4.5 (36 - 40)
		6	14 - 4 (2.5 - 25)	-	M6 	4.0 - 5.0 (35.4 - 44.3)
2075	R/L1, S/L2, T/L3	4	8 - 2/0 (10 - 70)	-	M8 	15 - 22 (132.8 - 194.7)
	U/T1, V/T2, W/T3	3 or 2	8 - 2/0 (10 - 70)	-	M8 	5.4 - 6.0 (47.8 - 53.1)
		6	8 - 2/0 (10 - 70)	-	M8 	9.0 - 11 (79.7 - 97.4)
2088	R/L1, S/L2, T/L3	3 or 2	8 - 2/0 (10 - 70)	-	M8 	15 - 22 (132.8 - 194.7)
	U/T1, V/T2, W/T3	2	8 - 2/0 (10 - 70)	-	M8 	5.4 - 6.0 (47.8 - 53.1)
		6	8 - 2/0 (10 - 70)	-	M8 	9.0 - 11 (79.7 - 97.4)
2114	R/L1, S/L2, T/L3	1/0	8 - 2/0 (10 - 70)	-	M8 	15 - 22 (132.8 - 194.7)
	U/T1, V/T2, W/T3	1/0	8 - 2/0 (10 - 70)	-	M8 	5.4 - 6.0 (47.8 - 53.1)
		6	8 - 2/0 (10 - 70)	-	M8 	9.0 - 11 (79.7 - 97.4)





























\*1 You cannot use terminals - and +1 on IP55/UL Type 12 drives with Main Switch.

\*2 The metric wire gauge values are provided as reference information from equivalent AWG sizes and not exactly the same sizes as the AWG/kcmil values. Obey local safety regulations for wire sizes and make sure that the ferrule or crimp terminals are correct for your size.

\*3 Remove insulation from the ends of wires to expose the length of wire shown.

\*4 The wire stripping length is different for different wire gauges.

## Three-Phase 480 V Class Wire Gauges and Torques

Model	Terminal *1	Recommended Gauge AWG, kcmil	Applicable Gauge AWG, kcmil (mm <sup>2</sup> ) *2	Wire Stripping Length *3 mm	Terminal Screw Size and Shape	Tightening Torque N·m (lbf·in)
4005	R/L1, S/L2, T/L3	14	14 - 8 (2.5 - 10)	9 - 10	M3.5 	0.8 (7.0)
	U/T1, V/T2, W/T3	14	14 - 8 (2.5 - 10)	10	M4 	1.5 - 1.7 (13.5 - 15)
		14	14 - 8 (2.5 - 10)	-	M5 	2.0 - 2.5 (17.7 - 22.1)
4008	R/L1, S/L2, T/L3	14	14 - 8 (2.5 - 10)	9 - 10	M3.5 	0.8 (7.0)
	U/T1, V/T2, W/T3	14	14 - 8 (2.5 - 10)	10	M4 	1.5 - 1.7 (13.5 - 15)
		14	14 - 8 (2.5 - 10)	-	M5 	2.0 - 2.5 (17.7 - 22.1)
4011	R/L1, S/L2, T/L3	14	14 - 8 (2.5 - 10)	9 - 10	M3.5 	0.8 (7.0)
	U/T1, V/T2, W/T3	14	14 - 8 (2.5 - 10)	10	M4 	1.5 - 1.7 (13.5 - 15)
		12	14 - 8 (2.5 - 10)	-	M5 	2.0 - 2.5 (17.7 - 22.1)
4014	R/L1, S/L2, T/L3	14	14 - 8 (2.5 - 10)	9 - 10	M3.5 	0.8 (7.0)
	U/T1, V/T2, W/T3	12	14 - 8 (2.5 - 10)	10	M4 	1.5 - 1.7 (13.5 - 15)
		10	14 - 8 (2.5 - 10)	-	M5 	2.0 - 2.5 (17.7 - 22.1)
4021	R/L1, S/L2, T/L3	10	14 - 4 (2.5 - 25)	AWG 14 - AWG 10: 13 - 14.5 AWG 8 - AWG 4: 10 - 12 *4	M5 	2.0 (18.0)
	U/T1, V/T2, W/T3	10	14 - 8 (2.5 - 10)	10	M4 	1.5 - 1.7 (13.5 - 15)
		10	14 - 8 (2.5 - 10)	-	M5 	2.0 - 2.5 (17.7 - 22.1)
4027	R/L1, S/L2, T/L3	10	14 - 4 (2.5 - 25)	AWG 14 - AWG 10: 13 - 14.5 AWG 8 - AWG 4: 10 - 12 *4	M5 	2.0 (18.0)
	U/T1, V/T2, W/T3	8	14 - 8 (2.5 - 10)	10	M4 	1.5 - 1.7 (13.5 - 15)
		10	14 - 8 (2.5 - 10)	-	M5 	2.0 - 2.5 (17.7 - 22.1)
4034	R/L1, S/L2, T/L3	8	14 - 4 (2.5 - 25)	AWG 14 - AWG 10: 13 - 14.5 AWG 8 - AWG 4: 10 - 12 *4	M5 	2.0 (18.0)
	U/T1, V/T2, W/T3	8	14 - 8 (2.5 - 10)	10	M4 	1.5 - 1.7 (13.5 - 15)
		10	14 - 8 (2.5 - 10)	-	M5 	2.0 - 2.5 (17.7 - 22.1)

Model	Terminal *1	Recommended Gauge AWG, kcmil	Applicable Gauge AWG, kcmil (mm <sup>2</sup> ) *2	Wire Stripping Length *3 mm	Terminal Screw Size and Shape	Tightening Torque N·m (lbf·in)
4040	R/L1, S/L2, T/L3	8	8 - 1/0 (10 - 50)	18 - 21	M8	6.2 (55.0)
	U/T1, V/T2, W/T3	8	14 - 4 (2.5 - 25)	18	M5	4.1 - 4.5 (36 - 40)
		8	14 - 4 (2.5 - 25)	-	M6	4.0 - 5.0 (35.4 - 44.3)
4052	R/L1, S/L2, T/L3	6	8 - 1/0 (10 - 50)	18 - 21	M8	6.2 (55.0)
	U/T1, V/T2, W/T3	6	14 - 4 (2.5 - 25)	18	M5	4.1 - 4.5 (36 - 40)
		8	14 - 4 (2.5 - 25)	-	M6	4.0 - 5.0 (35.4 - 44.3)
4065	R/L1, S/L2, T/L3	4	8 - 1/0 (10 - 50)	18 - 21	M8	6.2 (55.0)
	U/T1, V/T2, W/T3	4	14 - 4 (2.5 - 25)	18	M5	4.1 - 4.5 (36 - 40)
		6	14 - 4 (2.5 - 25)	-	M6	4.0 - 5.0 (35.4 - 44.3)
4077	R/L1, S/L2, T/L3	4	8 - 2/0 (10 - 70)	-	M8	15 - 22 (132.8 - 194.7)
	U/T1, V/T2, W/T3	3 or 2	8 - 2/0 (10 - 70)	-	M8	5.4 - 6.0 (47.8 - 53.1)
		6	8 - 2/0 (10 - 70)	-	M8	9.0 - 11 (79.7 - 97.4)
4096	R/L1, S/L2, T/L3	2	8 - 2/0 (10 - 70)	-	M8	15 - 22 (132.8 - 194.7)
	U/T1, V/T2, W/T3	1	8 - 2/0 (10 - 70)	-	M8	5.4 - 6.0 (47.8 - 53.1)
		6	8 - 2/0 (10 - 70)	-	M8	9.0 - 11 (79.7 - 97.4)

- \*1 You cannot use terminals - and +1 on IP55/UL Type 12 drives with Main Switch.
- \*2 The metric wire gauge values are provided as reference information from equivalent AWG sizes and not exactly the same sizes as the AWG/kcmil values. Obey local safety regulations for wire sizes and make sure that the ferrule or crimp terminals are correct for your size.
- \*3 Remove insulation from the ends of wires to expose the length of wire shown.
- \*4 The wire stripping length is different for different wire gauges.

## ◆ Main Circuit Terminal Block Wiring Procedure

**⚠ DANGER** *Electrical Shock Hazard. Do not examine, connect, or disconnect wiring on an energized drive. Before servicing, disconnect all power to the equipment and wait for the time specified on the warning label at a minimum. The internal capacitor stays charged after the drive is de-energized. The charge indicator LED extinguishes when the DC bus voltage decreases below 50 Vdc. When all indicators are OFF, remove the covers before measuring for dangerous voltages to make sure that the drive is safe. If you do work on the drive when it is energized, it will cause serious injury or death from electrical shock.*

The procedures to wire the main circuit terminal block are different for different drive models. Refer to [Table 7.3](#) for procedures by drive model.

**Table 7.3 Types of Wiring Procedure for the Main Circuit Terminal Block**

Model	Procedure	Reference
2011 - 2059 4005 - 4065	Procedure A	<a href="#">33</a>
2075 - 2114 4077 - 4096	Procedure B	<a href="#">33</a>

## ■ Notes on Wiring the Main Circuit Terminal Block of Models 2011 to 2059 and 4005 to 4065

Read these safety messages and notes before you wire the main circuit terminal block.

**⚠ WARNING** *Fire Hazard. Do not use bent or crushed wires. Remove the damaged end of the wire before you use it. Incorrect connections can cause death or serious injury from fire.*

**⚠ WARNING** *Fire Hazard. If you use stranded wire, make sure that all of the wire strands are in the connection. Also, do not twist the stranded wire too much. Incorrect connections can cause death or serious injury from fire.*

**NOTICE** *Do not solder stranded wire. Soldered wire connections can become loose over time and cause unsatisfactory drive performance.*

**NOTICE** *If you use power tools to tighten the terminal screws, use a low speed setting ( $300 \text{ min}^{-1}$  (r/min) to  $400 \text{ min}^{-1}$  (r/min)). High speeds can cause damage to the terminal screws.*

**NOTICE** *Do not tighten the terminal screws at an angle of 5 degrees or more. Incorrect positioning can cause damage to the terminal screws.*

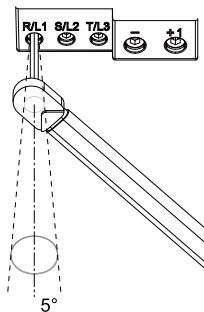
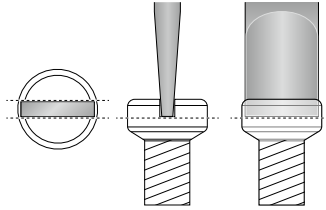

Figure 7.5 Permitted Angle

**Note:**

- Use UL Listed vinyl-coated insulated copper wires for operation with a continuous maximum permitted temperature of 75 °C at 600 V.
- Remove all unwanted objects that are near the terminal block connections.
- Remove the insulation from the connection wires to the wire stripping lengths shown in the manual.
- Put the wire all the way into the terminal block. Remove the insulation from the wire to the recommended wire stripping length to fit the wire with insulation in the plastic housing.
- Use a torque driver, torque ratchet, or torque wrench for the screws. A slotted driver or a hex tool will be necessary to wire the screw clamp terminal. Use applicable tools as specified by the recommended conditions in the product manual.
- Users can purchase wiring tools from Yaskawa. Contact Yaskawa or your nearest sales representative for more information.
- Wire gauges on existing drive models to be replaced may not match wire gauge ranges on new drives. Contact Yaskawa or your nearest sales representative for more information about the connection procedures.
- Put the bit all the way into the hex socket to tighten the hex socket cap screw.
- When tightening slotted screws, hold the straight-edge screwdriver perpendicularly to the screw. Take care to ensure that the tip of the straight-edge screwdriver is aligned with the screw groove.



**Figure 7.6 Tightening Slotted Screws**

- After connecting the wires to the terminal block, lightly pull on the wires to make sure that they do not come out of the terminals.
- Remove the correct section of the wiring cover to make wiring easier.
- Do not let strain on the wiring cause damage. Use a strain relief near the wiring to release the tension. Refer to [Figure 7.7](#) for examples.

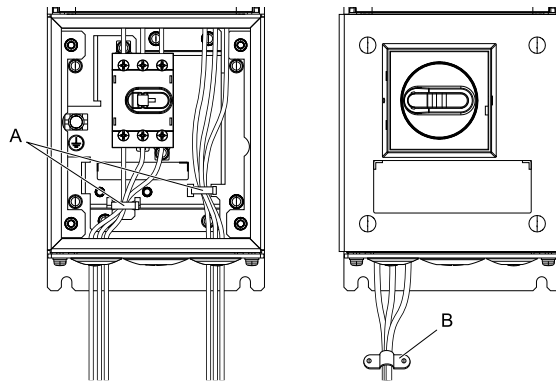





**A - Cable ties**

**B - Cable clamp**

**Figure 7.7 Strain Relief Example**

**Table 7.4 Recommended Wiring Tools**

Screw Size and Shape	Adapter	Bit Model Manufacturer: PHOENIX CONTACT	Torque Driver Model (Adjustable Tightening Torque)
M3.5 	Pozidriv screw driver #2	-	-
M4 	Bit	SF-BIT-SL 1,0X4,0-70	TSD-M 3NM (0.2 - 3 N·m (1.8 - 26.6 lbf·in))
M5 <sup>*1</sup> 	Bit	SF-BIT-SL 1,2X6,5-70	TSD-M 3NM (0.2 - 3 N·m (1.8 - 26.6 lbf·in))
M5 	Pozidriv screw driver #2	-	-

\*1 For M5 screw size and the tightening torque is more than 3 N·m, use a torque wrench with the recommended bit.



## ■ Notes on Wiring the Main Circuit Terminal Block of Models 2075 to 2114 and 4077 to 4096

### Note:

- After the wiring, do not twist or shake the electrical wires too much.
- Be sure to use only wires with the correct size, stripped wire length, and tightening torque as specified by Yaskawa.
- Use tools that fit the shape of the screw head to tighten and loosen the terminal block screws.
- Make sure that there are no loose stranded wires or frayed wires after wiring is complete.

## ■ Wiring the Main Circuit Terminal Block Using Procedure A

### Main Circuit Terminal Block Wiring Procedure

1. Remove the keypad and front cover of the Main Switch.
2. Put the ends of prepared wires through the knock-out holes on the conduit bracket and into the Main Switch terminal, then tighten the Main Switch terminal screws to the specified torque.

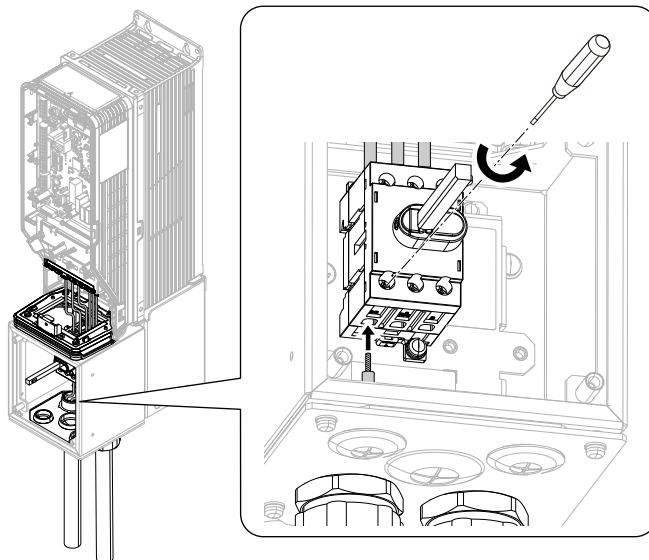
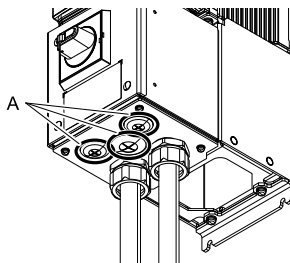

Figure 7.8 Install the Electrical Wire

3. Install the front cover of the Main Switch and the keypad to their initial positions.

### Note:

- For knock-out holes that you do not use for control circuit wiring, install the included rubber waterproofing grommets. For knock-out holes that you do use for control circuit wiring, install the correct conduit to keep the protection level.
- The knock-out holes for main circuit wiring do not have rubber grommets. Install the correct conduit to keep the IP55/UL Type 12 protection level.



A - Rubber grommets

## ■ Wiring the Main Circuit Terminal Block Using Procedure B

### Main Circuit Terminal Block Wiring Procedure

Prepare these recommended tools to remove and install the closed-loop crimp terminals:

- A deep socket wrench on the nut side
- A straight box wrench with these specifications on the bolt side
  - Size: 13 mm (0.51 in)

– Length: Less than 180 mm (7.09 in)

1. Remove the keypad and the Main Switch front cover.
2. Hold the terminal block bolts with the box wrench and remove the terminal block nuts.

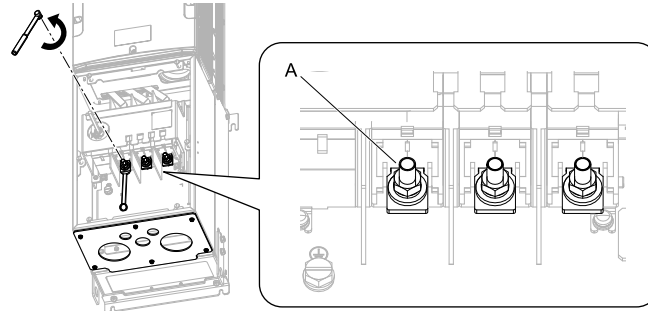

**A - Nut and bolt**

**Figure 7.9 Remove the Terminal Block Nuts**

**Note:**

The terminal block bolts are not easy to see. Make sure that you put the box wrench on the terminal block bolts correctly.

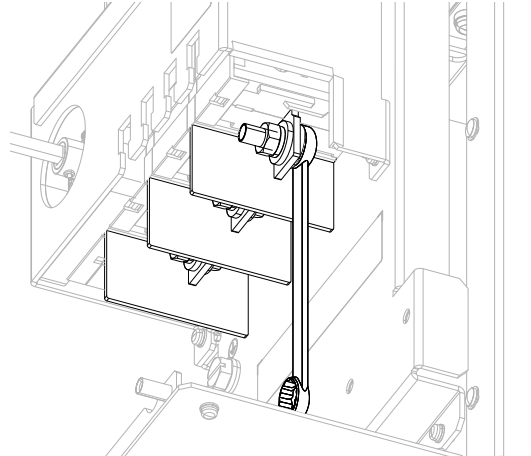

3. Put the ends of wires with closed-loop crimp terminals through the knock-out holes on the conduit bracket.
4. Put the terminal block bolts through the openings in the closed-loop crimp terminals.

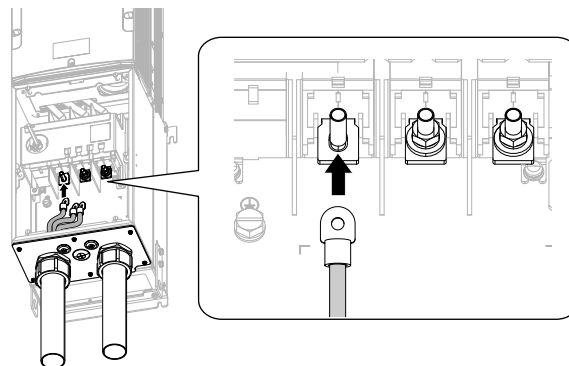

**Figure 7.10 Install the Electrical Wires**

5. Hold the terminal block bolts with the box wrench and tighten the terminal block nuts to a correct torque.

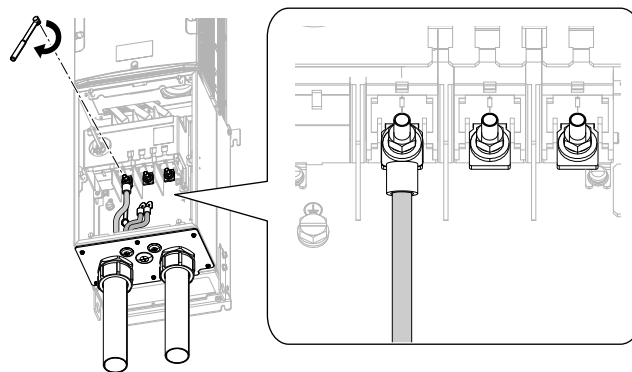
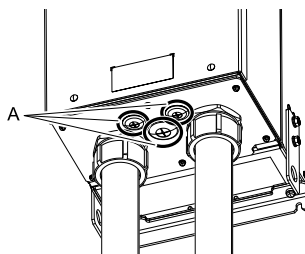

**Figure 7.11 Tighten the Main Switch Terminal Block Nuts**

6. Install the Main Switch front cover and the keypad to their initial positions.

**Note:**

- For knock-out holes that you do not use for control circuit wiring, install the included rubber waterproofing grommets. For knock-out holes that you do use for control circuit wiring, install the correct conduit to keep the protection level.
- The knock-out holes for main circuit wiring do not have rubber grommets. Install the correct conduit to keep the IP55/UL Type 12 protection level.



**A - Rubber grommets**

## 8 Drive Main Switch

Table 8.1 Main Switch and Drive Status

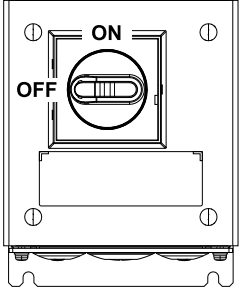
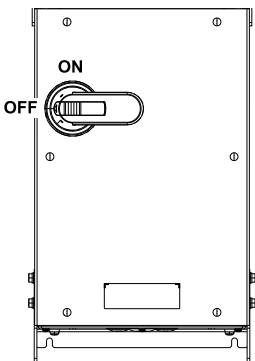
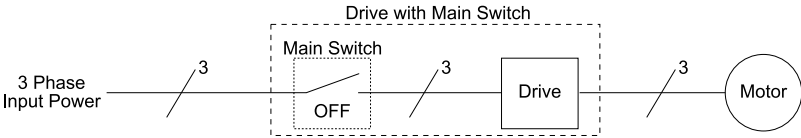
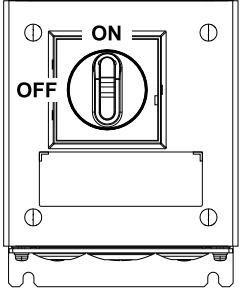
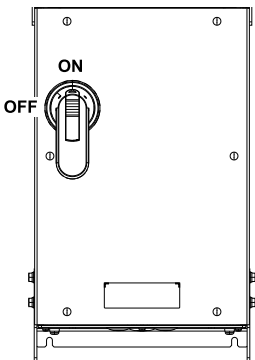
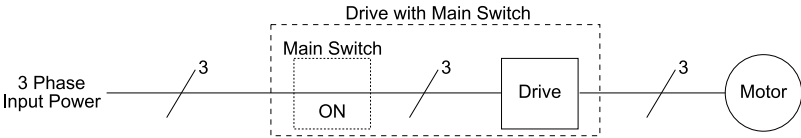
Main Switch Status		Drive Status
2011 - 2031 4005 - 4034	2046 - 2114 4040 - 4096	
		 <p>3 Phase Input Power — 3 — [Main Switch OFF] — 3 — Drive — 3 — Motor</p>
		 <p>3 Phase Input Power — 3 — [Main Switch ON] — 3 — Drive — 3 — Motor</p>

### ◆ Use and Lock the Main Switch

When you must touch the motors or machines, for example in maintenance, use the Main Switch to de-energize the drive and lock the Main Switch Disconnect Handle in the OFF position as specified by this procedure.

#### Note:

Yaskawa recommends that you de-energize the drive before you turn the Main Switch from ON to OFF.

**⚠ WARNING** *Electrical Shock Hazard. Disconnect all power to the drive and remove all wires to do maintenance on the drive. If you only turn OFF the built-in Main Switch before you do maintenance, there can be high voltage on input terminals R/L1, S/L2, and T/L3 of the Main Switch and touching energized terminals will cause serious injury or death.*

**NOTICE** *Damage to Equipment. Do not energize and de-energize the drive more frequently than one time each 30 minutes. If you frequently energize and de-energize the drive, it can cause drive failure.*

**NOTICE** *Damage to Equipment. Do not cycle the Main Switch more than 6000 times. If you cycle the Main Switch more times than the limit, it will cause the contact failure, or you cannot open or close the Main Switch.*

**NOTICE** *Damage to Equipment. Make sure that you stop the motor before you turn ON/OFF the Main Switch. If you turn ON/OFF the Main Switch during run, it can cause Main Switch failure.*

1. Stop the drive and make sure that the motor is completely stopped.

2. Turn the Main Switch from ON to OFF.

**Table 8.2 Turn OFF the Main Switch**

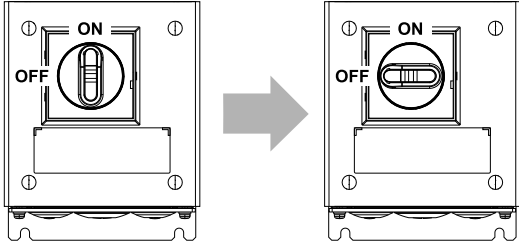
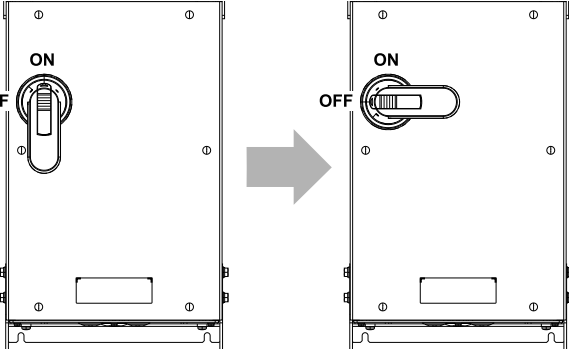
Model	Main Switch Status
2011 - 2031 4005 - 4034	
2046 - 2114 4040 - 4096	

3. Put a lock through the hole of the Main Switch.

**Note:**

The lock is not included with the drive.

**Table 8.3 Lock the Main Switch**

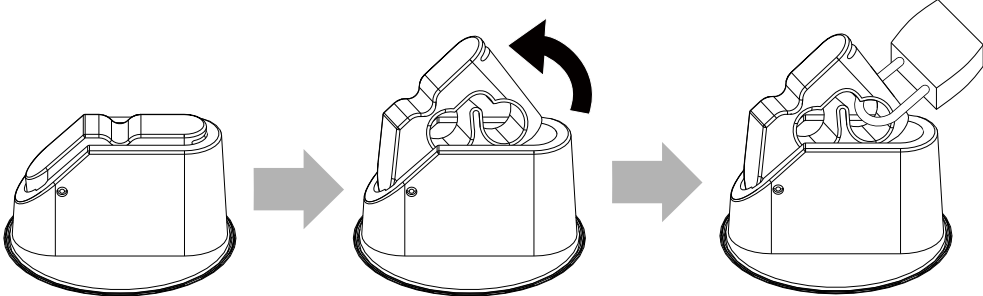
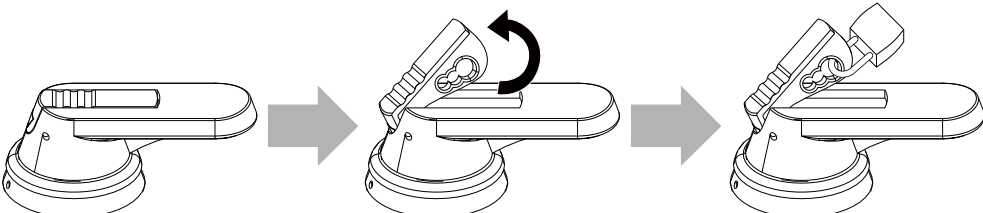
Model	Main Switch Status
2011 - 2031 4005 - 4034	
2046 - 2114 4040 - 4096	

## 9 Keypad: Names and Functions

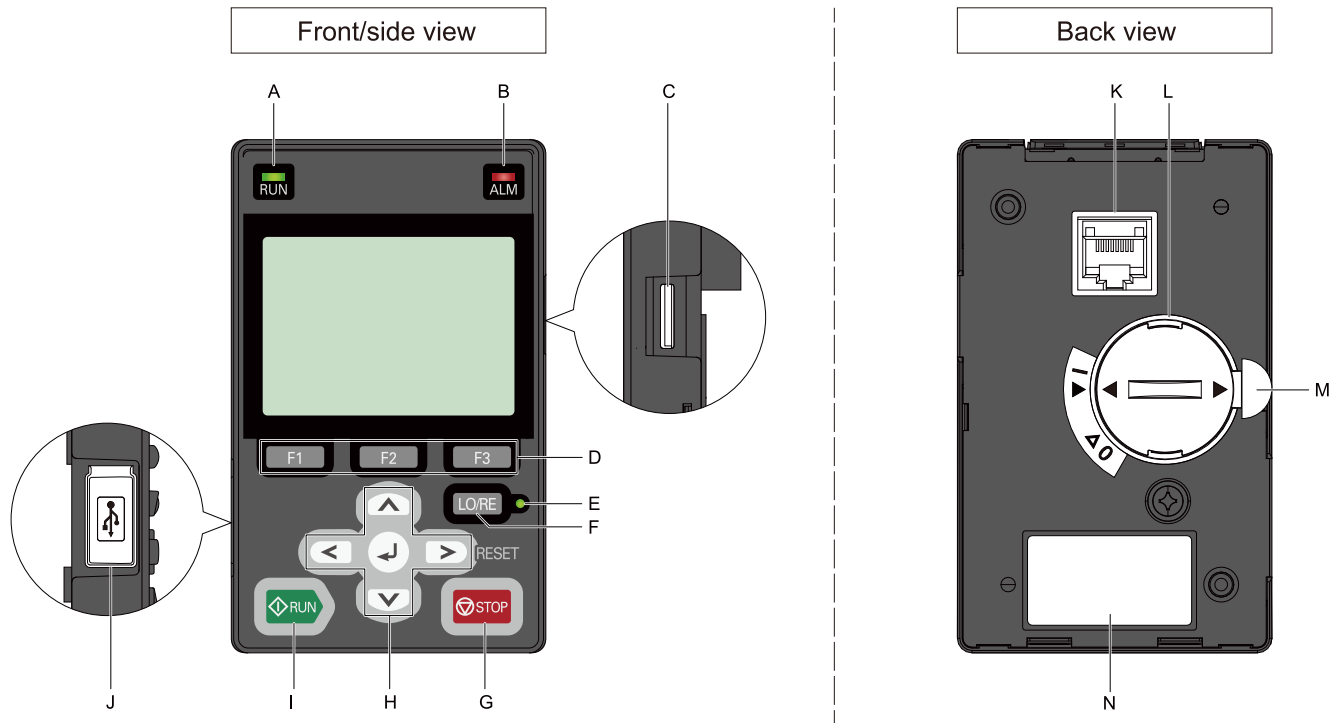

















Figure 9.1 Keypad

Table 9.1 Keypad Components and Functions

Symbol	Name	Function
A	RUN LED 	<p>Illuminates to show that the drive is operating the motor. The LED turns OFF when the drive stops. Flashes to show that:</p> <ul style="list-style-type: none"> <li>The drive is decelerating to stop.</li> <li>The drive received a Run command with a frequency reference of 0 Hz, but the drive is not set for zero speed control.</li> </ul> <p>Flashes quickly to show that:</p> <ul style="list-style-type: none"> <li>The drive received a Run command from the MFDI terminals and is switching to REMOTE Mode while the drive is in LOCAL Mode.</li> <li>The drive received a Run command from the MFDI terminals when the drive is not in Drive Mode.</li> <li>The drive received a Fast Stop command.</li> <li>The safety function shut off the drive output.</li> </ul> <ul style="list-style-type: none"> <li>You pushed  on the keypad while the drive is operating in REMOTE Mode.</li> <li>The drive is energized with an active Run command and <math>b1-17 = 0</math> [Run Command at Power Up = Disregard Existing RUN Command].</li> </ul>
B	ALM LED 	<p>Illuminates when the drive detects a fault. Flashes when the drive detects:</p> <ul style="list-style-type: none"> <li>Alarm</li> <li>Operation Errors</li> <li>A fault or alarm during Auto-Tuning</li> </ul> <p>The light turns off during regular drive operation. There are no alarms or faults.</p>
C	microSD Card Slot	The insertion point for a microSD card.
D	Function Keys F1, F2, F3 	<p>The menu shown on the keypad sets the functions for function keys. The name of each function is in the lower half of the display window.</p>
E	LO/RE LED 	<p>Illuminated: The keypad controls the Run command (LOCAL Mode). OFF: The control circuit terminal or serial transmission device controls the Run command (REMOTE Mode).</p> <p><b>Note:</b></p> <ul style="list-style-type: none"> <li><b>LOCAL:</b> Use the keypad to operate the drive. Use the keypad to enter Run/Stop commands and the frequency reference command.</li> <li><b>REMOTE:</b> Use the control circuit terminals or serial transmission to operate the drive. Use the frequency reference source entered in <math>b1-01</math> and the Run command source selected in <math>b1-02</math>.</li> </ul>

Symbol	Name	Function
F	LO/RE Selection Key 	Switches drive control for the Run command and frequency reference between the keypad (LOCAL) and an external source (REMOTE). <b>Note:</b> • The LOCAL/REMOTE Selection Key continuously stays enabled after the drive stops in Drive Mode. If the application must not switch from REMOTE to LOCAL because it will have a negative effect on system performance, set $o2-01 = 0$ [LO/RE Key Function Selection = Disabled] to disable  • The drive will not switch between LOCAL and REMOTE when it is receiving a Run command from an external source.
G	STOP Key 	Stops drive operation. <b>Note:</b> Push  to stop the motor. This will also apply when a Run command (REMOTE Mode) is active at an external Run command source. To disable  priority, set $o2-02 = 0$ [STOP Key Function Selection = Disabled].
H	Left Arrow Key 	<ul style="list-style-type: none"> <li>Moves the cursor to the left.</li> <li>Goes back to the previous screen.</li> </ul>
	Up Arrow Key/Down Arrow Key 	<ul style="list-style-type: none"> <li>Scrolls up or down to show the next item or the previous item.</li> <li>Selects parameter numbers, and increments or decrements setting values.</li> </ul>
	Right Arrow Key (RESET) 	<ul style="list-style-type: none"> <li>Moves the cursor to the right.</li> <li>Continues to the next screen.</li> <li>Resets the drive to clear a fault.</li> </ul>
	ENTER Key 	<ul style="list-style-type: none"> <li>Enters parameter values and settings.</li> <li>Selects menu items to move between keypad displays.</li> <li>Selects each mode, parameter, and set value.</li> </ul>
I	RUN Key 	Starts the drive in LOCAL Mode. Starts the operation in Auto-Tuning Mode. <b>Note:</b> Before you use the keypad to operate the motor, push  on the keypad to set the drive to LOCAL Mode.
J	USB Terminal	For factory adjustment
K	RJ-45 Connector	Connects to the drive using an RJ-45 8-pin straight through UTP CAT5e extension cable or keypad connector.
L	Clock Battery Cover	Remove this cover to install or replace the clock battery. <b>Note:</b> • The battery included with the keypad is for operation check. It may be exhausted earlier than the expected battery life described in the manual. • Refer to "Maintenance & Troubleshooting Manual (TOEPAIGA8001)" for details on replacement procedure. To replace the battery, use a Hitachi Maxell "CR2016 Lithium Manganese Dioxide Lithium Battery" or an equivalent battery with these properties: • Nominal voltage: 3 V • Operating temperature range: -20 °C to +85 °C (-4 °F to +185 °F)
M	Insulation Sheet	An insulating sheet is attached to the keypad battery to prevent battery drain. Remove the insulation sheet before you use the keypad for the first time.
N	Nameplate	Shows the model number of the keypad and other information <b>Note:</b> • "REV" identifies the hardware and software version of the keypad. • "FLASH" identifies the version of the flash memory.

**⚠ WARNING** Sudden Movement Hazard. If you change the control source when  $b1-07 = 1$  [LOCAL/REMOTE Run Selection = Accept Existing RUN Command], the drive can start suddenly. Before you change the control source, remove all personnel from the area around the drive, motor, and load. Sudden starts can cause serious injury or death.

### ◆ Keypad Mode and Menu Displays

10:00 am	FWD	Rdy	Home
Freq Reference (AI)			
U1-01	Hz		0.00
Output Frequency			
U1-02	Hz		0.00
Output Current			
U1-03	A		0.00
Menu			

HOME

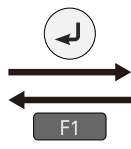
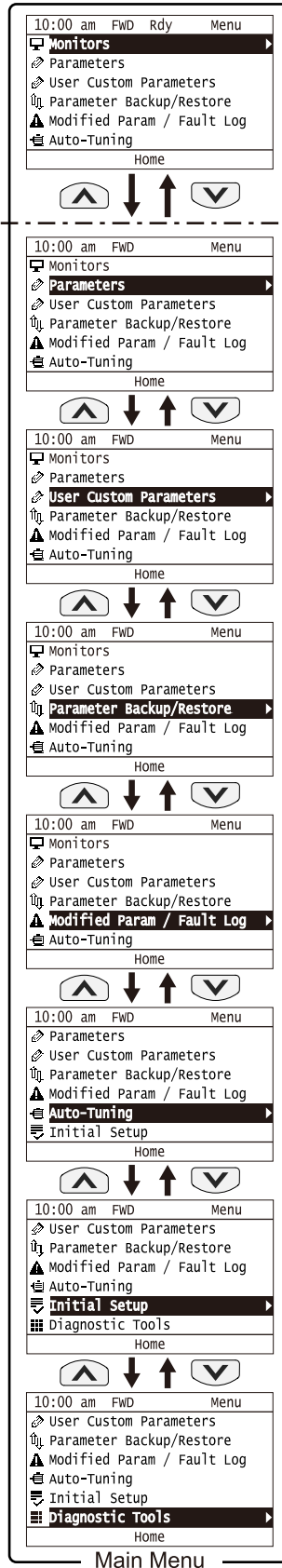
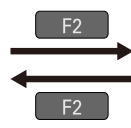

10:00 am	FWD	Rdy	Monitor
Standard Monitor			
Custom Monitor			
Bar Graph			
Analog Gauge			
Trend Plot			
Back		Home	

Monitors

Drive Mode

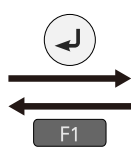

10:00 am	FWD		Parameters
Initialization Parameters			
Application			
Tuning			
References			
Motor Parameters			
Options			
Back		Home	

Parameters

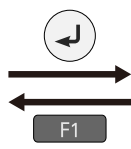

10:00 am	FWD		Parameters
Application Preset			
A1-06	0	(0)	
Control Method Selection			
A1-02	0	(0)	
Frequency Reference Selection 1			
b1-01	1	(1)	
Back		Home	

User Custom Parameters

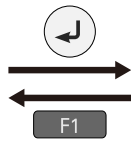

10:00 am	FWD		Backup
Select Items to Backup/Restore			
Standard Parameters			
Back		Home	

Parameter Backup/Restore

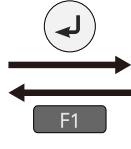

10:00 am	FWD		History
Modified Parameters			
Fault Log			
Back		Home	

Modified Parameters/Fault Log

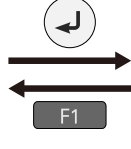

10:00 am	FWD		Auto Tuning
Select Auto-Tuning mode			
Motor Parameter Tuning			
Back		Home	

Auto-Tuning

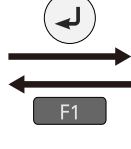

10:00 am	FWD		Init Setup
Language Selection			
Set Date/Time			
Show Initial Setup Screen			
Back		Home	

Initial Setup

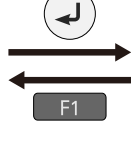

10:00 am	FWD		Tools
Data Logger			
Backlight			
Drive Information			
Back		Home Setup	



Diagnostic Tools

Programming Mode

Figure 9.2 Keypad Functions and Display Levels



**Note:**

- Energize the drive with factory defaults to show the Initial Setup screen. Push **F2** [Home] to show the HOME screen.
  - Select [No] from the [Show Initial Setup Screen] setting to not display the Initial Setup screen.
- Push  from the Home screen to show drive monitors.
- Push  to set *d1-01 [Reference 1]* when the Home screen shows *U1-01 [Frequency Reference]* in LOCAL Mode.
- The keypad will show [Rdy] when the drive is in Drive Mode. The drive is prepared to accept a Run command.
- Set *b1-08 [Run Command Select in PRG Mode]* to accept or reject a Run command from an external source while in Programming Mode.
  - Set *b1-08 = 0 [Disregard RUN while Programming]* to reject the Run command from an external source while in Programming Mode (default).
  - Set *b1-08 = 1 [Accept RUN while Programming]* to accept the Run command from an external source while in Programming Mode.
  - Set *b1-08 = 2 [Allow Programming Only at Stop]* to prevent changes from Drive Mode to Programming Mode while the drive is operating.

**Table 9.2 Drive Mode Screens and Functions**

Mode	Keypad Screen	Function
Drive Mode	Monitors	Sets monitor items to display.
Programming Mode	Parameters	Changes parameter settings.
	User Custom Parameters	Shows the User Parameters.
	Parameter Backup/Restore	Saves parameters to the keypad as backup.
	Modified Parameters/Fault Log	Shows modified parameters and fault history.
	Auto-Tuning	Auto-Tunes the drive.
	Initial Setup Screen	Changes initial settings.
	Diagnostic Tools	Sets data logs and backlight.

## 10 LED Status Ring

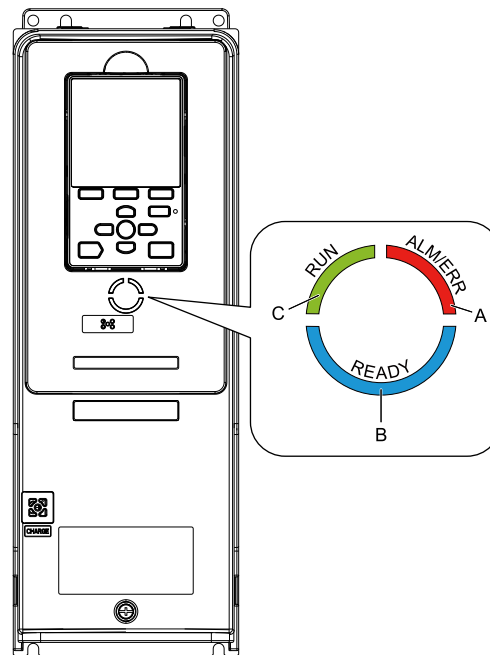

The LED Status Ring on the drive cover shows the drive operating status.



**A - ALM/ERR**  
**B - Ready**

**C - RUN**

## 11 Drive Start-Up Procedure

LED	Status	Description	
A	ALM/ERR	Illuminated	The drive detects a fault.
		Flashing <i>*1</i>	The drive detects: <ul style="list-style-type: none"> <li>An alarm</li> <li>An oPE parameter setting error</li> <li>An Auto-Tuning error</li> </ul> <b>Note:</b> If the drive detects a fault and an alarm at the same time, the LED will illuminate to identify a fault.
		OFF	There are no drive faults or alarms.
B	Ready	Illuminated	The drive is operating or is prepared for operation.
		Flashing <i>*1</i>	The drive is in <i>STo</i> [ <i>Safe Torque OFF</i> ] condition.
		Flashing Quickly <i>*1</i>	The voltage of the main circuit power supply dropped, and only the external 24 V power supply is providing the power to the drive.
		OFF	<ul style="list-style-type: none"> <li>The drive detects a fault.</li> <li>There is no fault and the drive received a Run command, but the drive cannot operate. For example, in Programming Mode or when  is flashing.</li> </ul>
C	RUN	Illuminated	The drive is in regular operation.
		Flashing <i>*1</i>	<ul style="list-style-type: none"> <li>The drive is decelerating to stop.</li> <li>The drive received a Run command with a frequency reference of 0 Hz.</li> <li>The drive received a DC Injection Braking command.</li> </ul>
		Flashing Quickly <i>*1</i>	<ul style="list-style-type: none"> <li>The drive received a Run command from the MFDI terminals and is switching to REMOTE Mode while the drive is in LOCAL Mode.</li> <li>The drive received a Run command from the MFDI terminals when the drive is not in Drive Mode.</li> <li>The drive received a Fast Stop command.</li> <li>The safety function shuts off the drive output.</li> <li>The user pushed  on the keypad when the drive is operated from a REMOTE source.</li> <li>The drive is energized with an active Run command and <math>b1-17 = 0</math> [<i>Run Command at Power Up = Disregard Existing RUN Command</i>].</li> <li>The drive is set to coast-to-stop with timer (<math>b1-03 = 3</math> [<i>Stopping Method Selection = Coast to Stop with Timer</i>]), and the Run command is disabled then enabled during the Run wait time.</li> </ul>
		OFF	The motor is stopped.
		OFF	The motor is stopped.

\*1 Refer to [Figure 10.1](#) for the difference between “flashing” and “flashing quickly”.

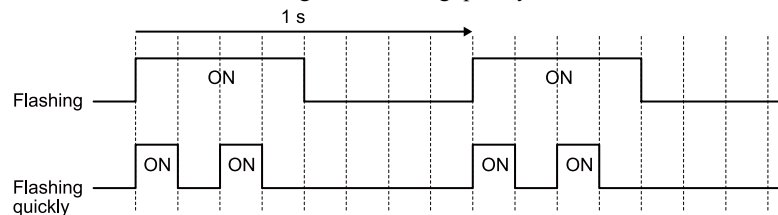

Figure 10.1 LED Flashing Statuses

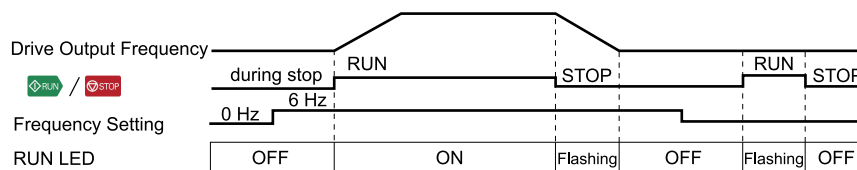

Figure 10.2 Relation between RUN LED and Drive Operation

## 11 Drive Start-Up Procedure

1. Confirm the drive and motor specifications.
2. Confirm the correct drive installation environment.
3. Mount the drive vertically.
4. Select the motor and power wires, wire strip length, crimp terminals, and branch circuit protection.

5. Remove the keypad, front cover, and Main Switch cover.
6. Install the motor wiring and power wiring.
7. Install the Main Switch cover, front cover, and keypad.
8. Energize the drive and confirm it is ready.
9. Set the motor rated current (FLA) from the motor nameplate in *E2-01*.
10. Set the drive for LOCAL control and check the motor rotation direction.

The drive is prepared to run the operation.

## ◆ Change Parameter Setting Values

This example shows how to change the setting value for *C1-01 [Acceleration Time 1]*. Do the steps in this procedure to set parameters for the application.

1. Push **F2** (Home) to show the HOME screen.

### Note:

- When the drive is in HOME Mode, the screen shows [Home] in the upper right-hand corner of the screen.
- If [Home] is not shown above the **F2**, push **F1** (Back).

2. Push **F2** (Menu).

10:00 am	FWD	Rdy	Home
Freq Reference (AI)			0.00
U1-01	Hz		0.00
Output Frequency			0.00
U1-02	Hz		0.00
Output Current			0.00
U1-03	A		0.00
Menu			

3. Push  or  to select [Parameters], then push .

10:00 am	FWD	Menu
Monitors		
<b>Parameters</b>		
User Custom Parameters		
Parameter Backup/Restore		
Modified Param / Fault Log		
Auto-Tuning		
Home		

4. Push  or  to select [C Tuning], then push .

10:00 am	FWD	Parameters
A Initialization Parameters		
b Application		
<b>C Tuning</b>		
d References		
E Motor Parameters		
F Options		
Back		Home

5. Push  or  to select [C1 Accel & Decel Time], then push .

10:00 am	FWD	Parameters
<b>C1 Accel &amp; Decel Time</b>		
C2 S-Curve Characteristics		
C3 Slip Compensation		
C4 Torque Compensation		
C6 Carrier Frequency		
Back		Home

6. Push or to select C1-01, then push .

10:00 am	FWD	Parameters
Acceleration Time 1		
C1-01	10.0	(10.0)sec
Deceleration Time 1		
C1-02	10.0	(10.0)sec
Acceleration Time 2		
C1-03	10.0	(10.0)sec
Back	Home	

7. Push or to select the specified digit, then push or to select the correct number.

10:00 am	FWD	Parameters
Acceleration Time 1		
C1-01	0010.0sec	
Default : 10.0sec		
Range : 0.0~6000.0		
Back	Default	Min/Max

- Push [Default] to set the parameter to factory default.
- Push [Min/Max] to show the minimum value or the maximum value on the display.

8. Push to keep the changes.

10:00 am	FWD	Parameters
Acceleration Time 1		
C1-01	0020.0 sec	
Default : 10.0 sec		
Range : 0.0~6000.0		
Back	Default	Min/Max

9. Continue to change parameters, then push [Back], [Home] to go back to the home screen after you change all the applicable parameters.

## ◆ Disable the Initial Setup Screen

Do the steps in this procedure to not show the initial start-up screen when the drive is energized.

1. Push (Home) to show the HOME screen.

**Note:**

- When the drive is in HOME Mode, the screen shows [Home] in the upper right-hand corner of the screen.
- If the screen does not show [Home] for , push (Back), and then push to show [Home].

2. Push (Menu).



10:00 am	FWD	Rdy	Home
Freq Reference (AI)			
U1-01	Hz		0.00
Output Frequency			
U1-02	Hz		0.00
Output Current			
U1-03	A		0.00
Menu			

3. Push / to select [Initial Setup], then push .

10:00 am	FWD	Menu
	User Custom Parameters	
	Parameter Backup/Restore	
	Modified Param / Fault Log	
	Auto-Tuning	
	<b>Initial Setup</b>	
	Diagnostic Tools	
Home		

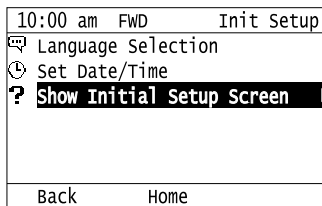
4. Push  /  to select [Show Initial Setup Screen], then push .



5. Push  /  to select [No], then push .

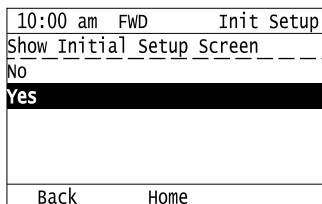

- [No]: The keypad will not show the Initial Setup Screen when the drive is energized.
- [Yes]: The keypad will show the Initial Setup Screen when the drive is energized.

## ◆ Control Circuit Terminal Block Functions

*Hx-xx parameters* set functions for the multi-function input and output terminals.

**⚠ WARNING** Sudden Movement Hazard. Correctly wire and test all control circuits to make sure that the control circuits operate correctly. If you use a drive that has incorrect control circuit wiring or operation, it can cause death or serious injury.

**⚠ WARNING** Sudden Movement Hazard. Check the I/O signals and the external sequences for the drive before you set the Application Preset function. When you set the Application Preset function ( $A1-06 \neq 0$ ), it changes the I/O terminal functions for the drive and it can cause equipment to operate unusually. This can cause serious injury or death.

**NOTICE** Damage to Equipment. Do not energize and de-energize the drive more frequently than one time each 30 minutes. If you frequently energize and de-energize the drive, it can cause drive failure.

**NOTICE** Damage to Equipment. Do not cycle the Main Switch more than 6000 times. If you cycle the Main Switch more times than the limit, it will cause the contact failure, or you cannot open or close the Main Switch.

**NOTICE** Damage to Equipment. Make sure that you stop the motor before you turn ON/OFF the Main Switch. If you turn ON/OFF the Main Switch during run, it can cause Main Switch failure.

## ■ Input Terminals

Refer to [Table 11.1](#) for a list of input terminals and functions.

**Table 11.1 Multi-function Input Terminals**

Type	Terminal	Name (Default)	Function (Signal Level)	
MFDI	S1	MFDI selection 1 (ON: Forward RUN (2-Wire) OFF: Stop)	Multi-Function Digital Input <ul style="list-style-type: none"> <li>• Photocoupler</li> <li>• 24 V, 6 mA</li> </ul> <b>Note:</b> Install the wire jumpers between terminals SC-SP and SC-SN to set the MFDI power supply (sinking/sourcing mode or internal/external power supply). <ul style="list-style-type: none"> <li>• Sinking Mode: Install a jumper between terminals SC and SP.</li> </ul> <div style="background-color: #0070C0; color: white; padding: 2px;"><b>NOTICE</b></div> <i>Damage to Equipment. Do not close the circuit between terminals SC-SN. If you close the circuits between terminals SC-SP and terminals SC-SN at the same time, it will cause damage to the drive.</i> <ul style="list-style-type: none"> <li>• Sourcing Mode: Install a jumper between terminals SC and SN.</li> </ul> <div style="background-color: #0070C0; color: white; padding: 2px;"><b>NOTICE</b></div> <i>Damage to Equipment. Do not close the circuit between terminals SC-SP. If you close the circuits between terminals SC-SP and terminals SC-SN at the same time, it will cause damage to the drive.</i> <ul style="list-style-type: none"> <li>• External power supply: No jumper necessary between terminals SC-SN and terminals SC-SP.</li> </ul>	
	S2	MFDI selection 2 (ON: Reverse RUN (2-Wire) OFF: Stop)		
	S3	MFDI selection 3 (External Fault (NO-Always-Coast))		
	S4	MFDI selection 4 (Fault Reset)		
	S5	MFDI selection 5 (Multi-Step Speed Reference 1)		
	S6	MFDI selection 6 (Multi-Step Speed Reference 2)		
	S7	MFDI selection 7 (Jog Reference Selection)		
	S8	MFDI selection 8 (Baseblock Command (N.O.))		
	SN	MFDI power supply 0 V		MFDI power supply, 24 V (maximum 150 mA)
	SC	MFDI selection common		<div style="background-color: #0070C0; color: white; padding: 2px;"><b>NOTICE</b></div> <i>Damage to Equipment. Do not close the circuit between terminals SP-SN. If you close the circuits between terminals SC-SP and terminals SC-SN at the same time, it will cause damage to the drive.</i>
SP	MFDI power supply +24 Vdc			
Safe Disable Input	H1	Safe Disable input 1	Safe Disable Input Remove the jumper between terminals H1-HC and H2-HC to use the Safe Disable input. <ul style="list-style-type: none"> <li>• 24 V, 6 mA</li> <li>• ON: Normal operation</li> <li>• OFF: Coasting motor</li> <li>• Internal impedance 4.7 kΩ</li> <li>• OFF Minimum OFF time of 2 ms.</li> </ul>	
	H2	Safe Disable input 2		
	HC	Safe Disable function common		<div style="background-color: #0070C0; color: white; padding: 2px;"><b>NOTICE</b></div> <i>Do not close the circuit between terminals HC and SN. A closed circuit between these terminals will cause damage to the drive.</i>
Master Frequency Reference	RP	Multi-function pulse train input (Frequency Reference)	<ul style="list-style-type: none"> <li>• Response frequency: 0 Hz to 32 Hz</li> <li>• H level duty: 30% to 70%</li> <li>• H level voltage: 3.5 V to 13.2 V</li> <li>• L level voltage: 0.0 V to 0.8 V</li> <li>• Input impedance: 3 kΩ</li> </ul>	
	+V	Power supply for frequency setting	Power Supply for Multi-Function Analog Input <ul style="list-style-type: none"> <li>• 10.5 V (allowable current 20 mA maximum)</li> </ul>	
	A1	MFAI 1 (Frequency Reference)	Voltage input or current input Select terminal A1 with Jumper switch S1 and H3-01 [Terminal A1 Signal Level Select]. <ul style="list-style-type: none"> <li>• 0 V to 10 V/100% (input impedance: 20 kΩ)</li> <li>• 4 mA to 20 mA/100%, 0 mA to 20 mA/100% (input impedance: 250 Ω)</li> </ul>	
	A2	MFAI 2 (Combined to terminal A1)	Voltage input or current input Select terminal A2 with Jumper switch S1 and H3-09 [Terminal A2 Signal Level Select] <ul style="list-style-type: none"> <li>• 0 V to 10 V/100% (input impedance: 20 kΩ)</li> <li>• 4 mA to 20 mA/100%, 0 mA to 20 mA/100% (input impedance: 250 Ω)</li> </ul>	
	A3	MFAI 3 (Auxiliary Frequency Reference 1)	Voltage input or current input Select terminal A3 with Jumper switch S1 and H3-05 [Terminal A3 Signal Level Select] <ul style="list-style-type: none"> <li>• 0 V to 10 V/100% (input impedance: 20 kΩ)</li> <li>• 4 mA to 20 mA/100%, 0 mA to 20 mA/100% (input impedance: 250 Ω)</li> </ul>	
	AC	Frequency reference common	Signal Ground for Multi-Function Analog Input <ul style="list-style-type: none"> <li>• 0 V</li> </ul>	
	FE	Connecting shielded cable	Frame Earth	

## ■ Output Terminals

Refer to [Table 11.2](#) and [Table 11.3](#) for a list of output terminals and functions.

**Table 11.2 Control Circuit Output Terminals**

Type	Terminal	Name (Default)	Function (Signal Level)
Fault Relay Output	MA	N.O. output (Fault)	Drive Fault Signal Output <ul style="list-style-type: none"> <li>Relay output</li> <li>30 Vdc, 10 mA to 2 A</li> <li>250 Vac, 10 mA to 2 A</li> <li>Minimum load: 5 V, 10 mA (Reference value)</li> </ul>
	MB	N.C. output (Fault)	
	MC	Digital output common	
MFDO	M1	MFDO (During Run)	Multi Function Digital Output <ul style="list-style-type: none"> <li>Relay output</li> <li>30 Vdc, 10 mA to 2 A</li> <li>250 Vac, 10 mA to 2 A</li> <li>Minimum load: 5 V, 10 mA (Reference value)</li> </ul> <b>Note:</b> Do not set functions that frequently switch ON/OFF to MFDO (M1 to M4) because this will decrease the performance life of the relay contacts. Yaskawa estimates switching life at 200,000 times (assumes 1 A, resistive load).
	M2		
	M3		
	M4	MFDO (Zero Speed)	
	MD	N.O. output (Speed Agree 1)	
	ME	N.C. output (Speed Agree 1)	
	MF	Digital output common	

**Table 11.3 Control Circuit Monitor Output Terminals**

Type	Terminal	Name (Default)	Function (Signal Level)
Monitor Output	FM	MFAO 1 (Output frequency)	Multi Function Analog Output Select voltage or current output. <ul style="list-style-type: none"> <li>0 V to 10 V/0% to 100%</li> <li>4 mA to 20 mA (receiver recommended impedance: 250 Ω)</li> </ul> <b>Note:</b> Select with jumper switch S5 and H4-07 [Terminal FM Signal Level Select] or H4-08 [Terminal AM Signal Level Select].
	AM	MFAO 2 (Output current)	
	AC	Monitor common	
External Power Supply Output	+P	External power supply	0 V Power supply for external devices. <ul style="list-style-type: none"> <li>24 V (150 mA maximum)</li> </ul>

## ■ External Power Supply Input Terminals

Refer to [Table 11.4](#) for a list of the functions of the external power supply input terminals.

**Table 11.4 External Power Supply Input Terminals**

Type	Terminal	Name (Default)	Function
External Power Supply Input Terminals	PS	External 24 V power supply input	Supplies backup power to the drive control circuit, keypad, and option board. 21.6 VDC to 26.4 VDC, 700 mA
	AC	External 24 V power supply ground	0 V

## ■ Serial Communication Terminals

Refer to [Table 11.5](#) for a list of serial communication terminals and functions.

**Table 11.5 Serial Communication Terminals**

Type	Terminal	Terminal Name	Function (Signal Level)	
Serial Communication	D+	Communication input/output (+)	MEMOBUS/Modbus communications Use an RS-485 cable to connect the drive.  <b>Note:</b> Set DIP switch S2 to ON to enable the termination resistor in the last drive in a MEMOBUS/Modbus network.	<ul style="list-style-type: none"> <li>• RS-485</li> <li>• MEMOBUS/Modbus communications: Maximum 115.2 kbps</li> </ul>
	D-	Communication output (-)		
	AC	Signal ground	0 V	
	FE	Option card ground	-	

◆ **Control Circuit Terminal Configuration**

The control circuit terminals are in the positions shown in [Figure 11.1](#).

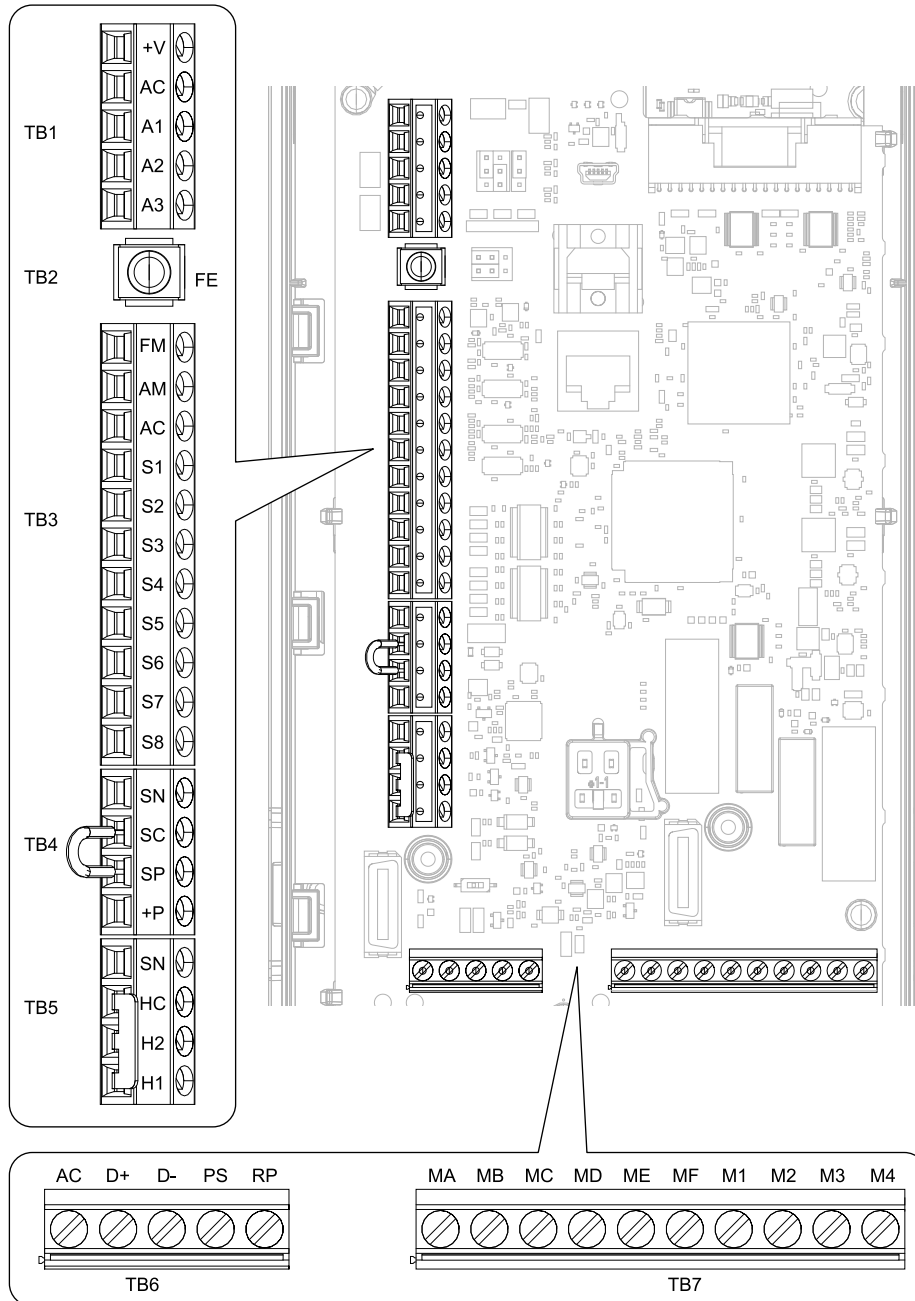

**Figure 11.1 Control Circuit Terminal Arrangement**



The tightening torque for the terminal screws is shown on the reverse side or the lower front side of the front cover.

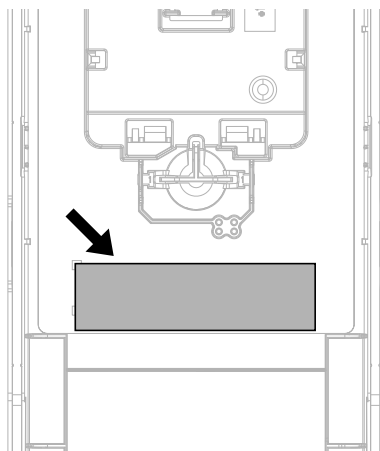

Figure 11.2 Tightening Torque Display Location (Reverse Side of Front Cover)

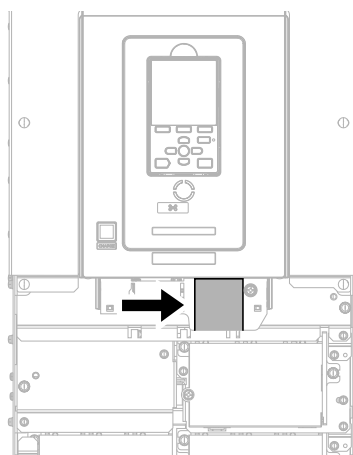

Figure 11.3 Tightening Torque Display Location (Lower Front Side of Front Cover)

### ■ Control Circuit Wire Gauges and Tightening Torques

Use the tables in this section to select the correct wires. Use shielded wire to wire the control circuit terminal block. Use crimp ferrules on the wire ends to make the wiring procedure easier and more reliable.

Table 11.6 Control Circuit Wire Gauges and Tightening Torques

Terminal Block	Terminal	Screw Size	Tightening Torque N·m (lbf·in)	Bare Wire		Crimp Ferrule	
				Recommended Gauge mm <sup>2</sup> (AWG)	Applicable Gauge mm <sup>2</sup> (AWG)	Recommended Gauge mm <sup>2</sup> (AWG)	Applicable Gauge mm <sup>2</sup> (AWG)
TB1	+V, AC, A1, A2, A3	M3	0.5 - 0.6 (4.4 - 5.3)	0.75 (18)	Stranded wire: 0.25 - 1.5 (24 - 16) Solid wire: 0.25 - 1.5 (24 - 16)	0.75 (18)	0.25 - 1.5 (24 - 16)
TB3	FM, AM, AC, S1 - S8						
TB4	SN, SC, SP, +P						
TB5	SN, HC, H1, H2						
TB6	AC, D+, D-, PS, RP						
TB7	MA, MB, MC, MD, ME, MF, M1 - M4						
TB2	FE		1.0 - 1.2 (8.85 - 10.62)	0.75 (18)	Stranded wire: 0.12 - 0.75 (26 - 18) Solid wire: 0.2 - 1.5 (26 - 16)	0.75 (18)	0.25 - 1.5 (24 - 16)

## Crimp Ferrules

Attach an insulated sleeve when you use crimp ferrules. Refer to [Table 11.7](#) for the recommended external dimensions and model numbers of the crimp ferrules.

Use the CRIMPFOX 6, a crimping tool made by PHOENIX CONTACT.

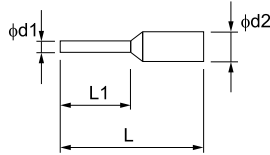

**Figure 11.4 External Dimensions of Crimp Ferrules**

**Table 11.7 Crimp Ferrule Models and Sizes**

Wire Gauge mm <sup>2</sup> (AWG)	Model	L (mm)	L1 (mm)	φd1 (mm)	φd2 (mm)
0.25 (24)	AI 0.25-8YE	12.5	8	0.8	2.0
0.34 (22)	AI 0.34-8TQ	12.5	8	0.8	2.0
0.5 (20)	AI 0.5-8WH AI 0.5-8OG	14	8	1.1	2.5
0.75 (18)	AI 0.75-8 GY	14	8	1.3	2.8

## ◆ Wiring the Control Circuit Terminal

**⚠ WARNING** *Electrical Shock Hazard. Do not remove covers or touch circuit boards while the drive is energized. If you touch the internal components of an energized drive, it can cause serious injury or death.*

**NOTICE** *Do not let wire shields touch other signal lines or equipment. Insulate the wire shields with electrical tape or shrink tubing. If you do not insulate the wire shields, it can cause a short circuit and damage the drive.*

**Note:**

- Isolate control circuit wiring from main circuit wiring (terminals R/L1, S/L2, T/L3, U/T1, V/T2, W/T3, -, +1) and other high-power wiring. If the control circuit wires are adjacent to the main circuit wires, electrical interference can cause the drive or the devices around the drive to malfunction.
- Isolate contact output terminals MA, MB, MC and M1-M4, MD, ME, MF from other control circuit wiring. If the output terminal wires are adjacent to other control circuit wires, electrical interference can cause the drive or devices around the drive to malfunction.
- Use a UL Listed Class 2 Power Supply to connect external power to the control terminals. If the power supply for peripheral devices is incorrect, it can cause a decrease in drive performance.
- Connect the shield of shielded cable to the applicable ground terminal. If the grounding is not correct, electrical interference can cause the drive or devices around the drive to malfunction.

Correctly ground the drive terminals and complete main circuit wiring before you wire the control circuit. Remove the keypad and front cover.

1. Refer to [Figure 11.5](#) and wire the control circuit.

**⚠ WARNING** *Fire Hazard. Tighten all terminal screws to the correct tightening torque. Connections that are too loose or too tight can cause incorrect operation and damage to the drive. Incorrect connections can also cause death or serious injury from fire.*

**Note:**

- Use shielded wires and shielded twisted-pair wires for the control circuit terminal wiring. If the grounding is not correct, electrical interference can cause the drive or devices around it to malfunction.
- Do not use control circuit wiring that is longer than 50 m (164 ft) to supply the frequency reference with an analog signal from a remote source. Wiring that is too long can cause unsatisfactory system performance.

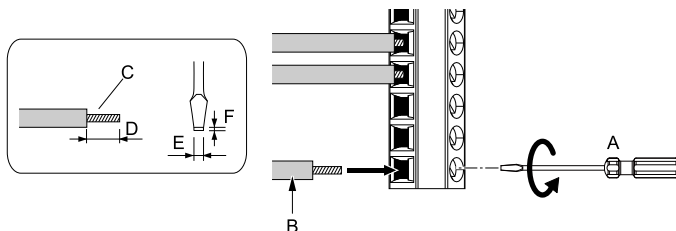

- A - Loosen the screws and put the wire into the opening on the terminal block.
- B - Wire with a crimp ferrule attached, or use wire that is not soldered with the core wires lightly twisted.
- C - Pull back the shielding and lightly twist the end with your fingers to keep the ends from fraying.
- D - If you do not use crimp ferrules, remove approximately 5.5 mm (0.21 in) of the covering at the end of the wire.
- E - Blade width of 2.5 mm (0.1 in) or less
- F - Blade depth of 0.4 mm (0.01 in) or less

Figure 11.5 Wiring Procedure for the Control Circuit

**⚠ WARNING** *Fire Hazard. Tighten all terminal screws to the correct tightening torque. Connections that are too loose or too tight can cause incorrect operation and damage to the drive. Incorrect connections can also cause death or serious injury from fire.*

**NOTICE** *Do not solder the core wire. Soldered wire connections can become loose over time and cause unsatisfactory drive performance.*

**Note:**

- Refer to [Figure 11.6](#) for information to prepare terminal ends of the shielded wire.
- Connect the shield to terminal FE of the drive.

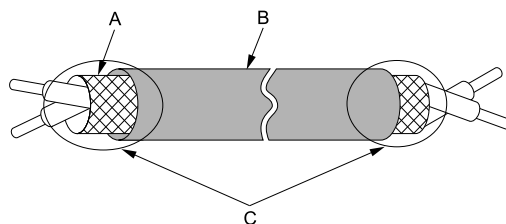

- A - Connect the shield to terminal FE of the drive.
- B - Sheath
- C - Insulate with electrical tape or shrink tubing.

Figure 11.6 Prepare the Ends of Shielded Wire

**Note:**

If you use multi-conductor shielded cable that is too thick to put through the hook on the drive, you can remove the cable sheath.

**NOTICE** *Damage to Equipment. When you remove the cable sheath, also remove the shield. If you keep the shield on the wire, it can cause a short circuit and damage to the drive.*

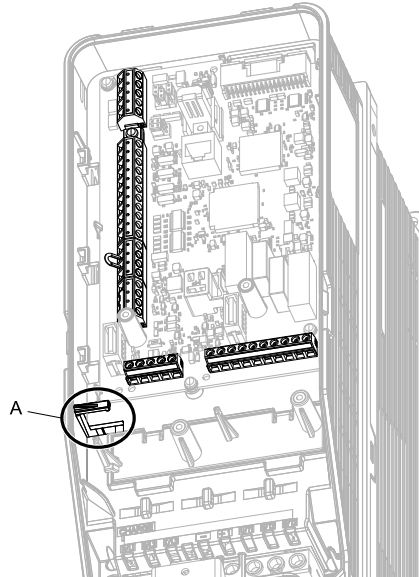

**A - Hook**

- Put the cables through the clearance of the drive, opening, and knock-out holes.

**Table 11.8 Control Circuit Wiring**

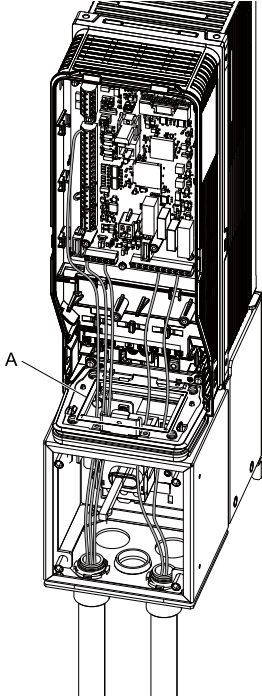
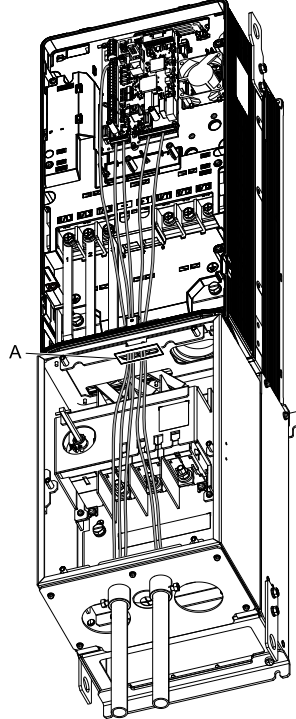
2011 - 2059 4005 - 4065	2075 - 2114 4077 - 4096
 <p><b>A - Opening</b></p>	 <p><b>A - Opening</b></p>

- Install the front cover and the keypad to their initial positions.

### ◆ Switches and Jumpers on the Terminal Board

The terminal board has switches to adapt the drive I/Os to the external control signals as shown in [Figure 11.7](#). Set the switches to select the functions for each terminal.

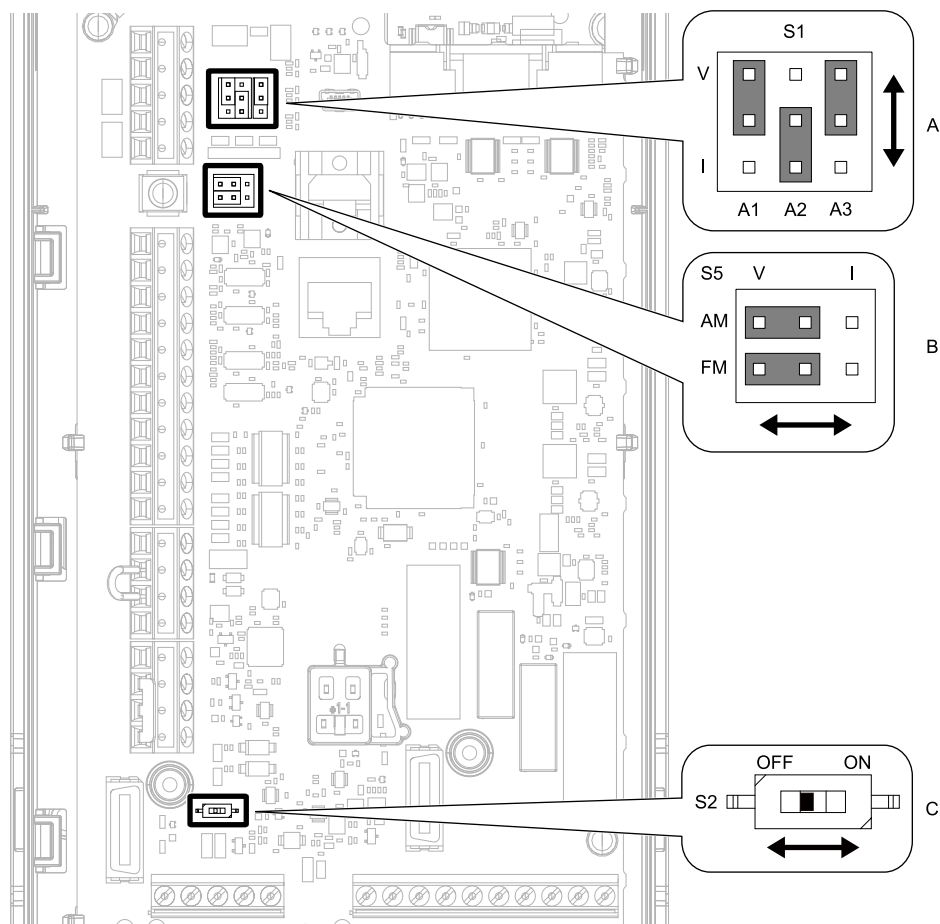

Figure 11.7 Locations of Switches

Table 11.9 I/O Terminals and Switches Functions

Position	Switch	Terminal	Function	Default Setting
A	Jumper switch S1	A1, A2, A3	Sets terminals A1 to A3 to voltage or current output.	A1: V (voltage input) A2: I (current input) A3: V (voltage input)
B	Jumper switch S5	FM, AM	Sets terminals FM and AM to voltage or current output.	FM: V (voltage output) AM: V (voltage output)
C	DIP switch S2	-	Enables and disables the termination resistor of MEMOBUS/Modbus communications.	OFF

## ◆ Control I/O Connections

This section gives information about the settings for the listed control circuit I/O signals.

- MFDI (terminals S1 to S8)
- MFDO (terminals M1 to M4 and MD to MF)
- MFAI (terminals A1 to A3)
- MFAO (terminals FM, AM)
- MEMOBUS/Modbus communications (terminals D+, D-, AC)

## ■ Set Sinking Mode/Sourcing Mode

Close the circuit between terminals SC-SP and SC-SN to set the sinking mode/sourcing mode and the internal/external power supply for the MFDI terminals. The default setting for the drive is internal power supply sinking mode.

**NOTICE** *Damage to Equipment. Do not close the circuit between terminals SP-SN. If you close the circuits between terminals SC-SP and terminals SC-SN at the same time, it will cause damage to the drive.*

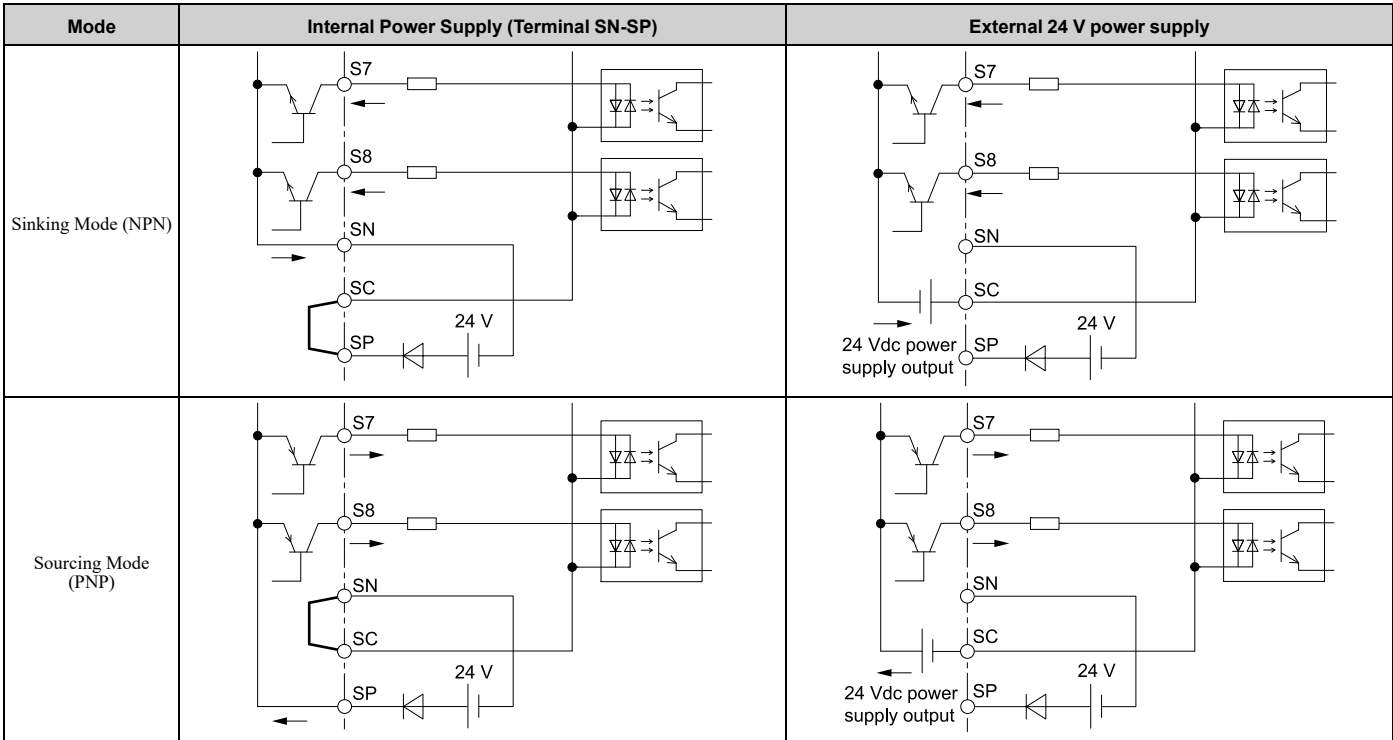

■ **Set Input Signals for MFAI Terminals A1 to A3**

Use terminals A1 to A3 to input a voltage or a current signal. Set the signal type as shown in [Table 11.10](#).

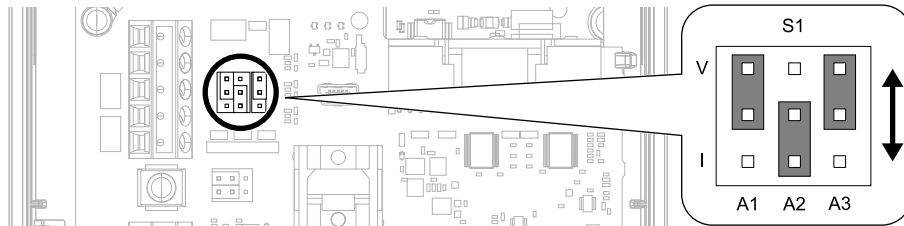

**Figure 11.8 Location of Jumper Switch S1**

**Table 11.10 MFAI Terminals A1 to A3 Signal Settings**

Terminal	Types of Input Signals	Parameter	
		No.	Signal Level
A1	Voltage input (Default)	H3-01	0: 0 V to 10 V/0% to 100% (input impedance: 20 kΩ)
	Current input		2: 4 mA to 20 mA/0% to 100% (input impedance: 250 Ω) 3: 0 mA to 20 mA/0% to 100% (input impedance: 250 Ω)
A2	Voltage input	H3-09	0: 0 V to 10 V/0% to 100% (input impedance: 20 kΩ)
	Current input (Default)		2: 4 mA to 20 mA/0% to 100% (input impedance: 250 Ω) 3: 0 mA to 20 mA/0% to 100% (input impedance: 250 Ω)
A3	Voltage input (Default)	H3-05	0: 0 V to 10 V/0% to 100% (input impedance: 20 kΩ)
	Current input		2: 4 mA to 20 mA/0% to 100% (input impedance: 250 Ω) 3: 0 mA to 20 mA/0% to 100% (input impedance: 250 Ω)

**Note:**

Set H3-02, H3-10, H3-05 = 0 [Terminal A1 Function Selection, Terminal A2 Function Selection, Terminal A3 Function Selection = Frequency Reference] to set A1 to A3 to frequency reference. The drive will add the analog input values together to make the frequency reference.

**■ Set Output Signals for MFAO Terminals FM, AM**

Set the signal type for terminals AM and FM to voltage or current output. Use jumper switch S5 and H4-07, H4-08 [Terminal FM Signal Level Select, Terminal AM Signal Level Select] to set the signal type.

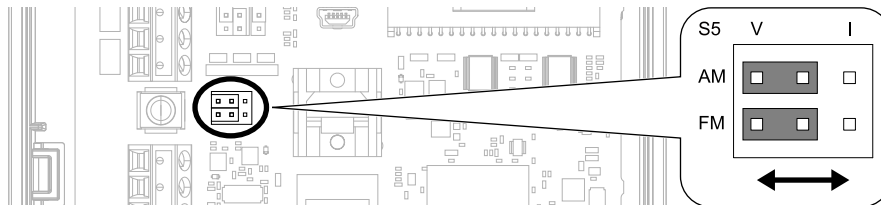

Figure 11.9 Location of Jumper Switch S5

Terminal	Types of Output Signals	Jumper Switch S5	Parameter	
			No.	Signal Level
FM	Voltage output (Default)		H4-07	0: 0 V to 10 V
	Current output			2: 4 mA to 20 mA
AM	Voltage output (Default)		H4-08	0: 0 V to 10 V
	Current output			2: 4 mA to 20 mA

**■ Switch ON Termination Resistor for MEMOBUS/Modbus Communications**

When the drive is the last slave in a MEMOBUS/Modbus communications, set DIP switch S2 to the ON position. This drive has a built-in termination resistor for the RS-485 interface.

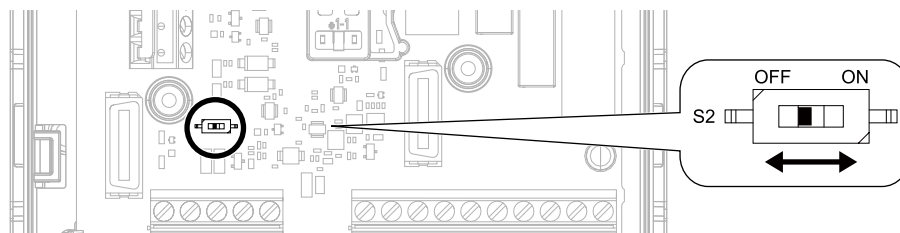

Figure 11.10 Location of DIP Switch S2

Table 11.11 RS-485 Communications Termination Resistor Setting

DIP Switch S2	Description
ON	The built-in termination resistor is ON.
OFF (Default)	The built-in termination resistor is OFF.

## 12 Drive Control and Programming

### ◆ Selecting the Control Method

This section gives information about these basic control methods:

- V/f Control
- EZ Open Loop Vector Control (EZOLV) for induction motors only

Refer to the Technical Reference for information about speed feedback and Permanent Magnet/Synchronous Reluctance motor control methods.

Use *A1-02 [Control Method Selection]* to select the most applicable control method for your application.

Control Method	A1-02 Setting	Main Applications
V/f	0	<ul style="list-style-type: none"> <li>• General variable-speed. Best method to operate more than one motor from one drive.</li> <li>• When motor parameters are not available.</li> </ul>
EZOLV	8	<ul style="list-style-type: none"> <li>• General variable-speed</li> <li>• No high precision, no high speed response, and no speed feedback</li> </ul>

### ◆ Auto-Tuning

**⚠ WARNING** *Injury to Personnel. Rotational Auto-Tuning rotates the motor at 50% or more of the motor rated frequency. Make sure that there are no issues related to safety in the area around the drive and motor. Increased motor frequency can cause serious injury or death.*

**⚠ WARNING** *Sudden Movement Hazard. Before you do Rotational Auto-Tuning, disconnect the load from the motor. The load can move suddenly and cause serious injury or death.*

Auto-Tuning automatically sets parameters on the drive connected to the motor. You must input some parameters individually during Auto-Tuning.

1. Select [Auto-Tuning] from the main menu to select the Auto-Tuning Mode.
2. Use the information in [Table 12.1](#) and [Table 12.2](#) to set *T1-01 [Auto-Tuning Mode Selection]* and *T4-01 [EZ Tuning Mode Selection]*.
3. Push  to start Auto-Tuning.  
Refer to the Technical Reference for more information about Auto-Tuning.

**Table 12.1 Auto-Tuning Mode Selection**



Type	T1-01	Application Conditions and Benefits	A1-02 = 0 [Control Method Selection = V/f]
Rotational Auto-Tuning	0	Recommended tuning mode for the most accurate results. Select this tuning mode when: <ul style="list-style-type: none"> <li>• You can decouple the motor from the load.</li> <li>• You cannot decouple the motor from the load, but the motor load is less than 30%.</li> </ul>	Yes
Stationary Line-Line Resistance	2	Select this tuning mode when: <ul style="list-style-type: none"> <li>• The drive and motor capacities are different.</li> <li>• The drive is in V/f Control.</li> <li>• You have replaced the drive and motor.</li> </ul>	Yes

**Table 12.2 EZ Tuning Mode Selection**

Type	T4-01	Application Conditions and Benefits	A1-02 = 8 [EZOLV]
Motor Parameter Setting	0	Set the motor parameters.	Yes
Line-to-Line Resistance	1	Select this tuning mode after you replace the drive, motor, and motor cables.	Yes

















## ◆ Drive Parameters

Icon	Description
	The parameter is available when operating the drive with V/f Control.
	The parameter is available when operating the drive with Open Loop Vector Control for PM.
	The parameter is available when operating the drive with EZ Open Loop Vector Control.
RUN	The parameter can be changed settings during run.

### Note:

Gray icons identify parameters that are not available in the specified control method.

Refer to the following table when setting the most important parameters.

No. (Hex.)	Name	Description
A1-00 (0100) RUN	Language Selection	   Sets the language for the LCD keypad. 0 : English 1 : Japanese 2 : German 3 : French 4 : Italian 5 : Spanish 6 : Portuguese 7 : Chinese 8 : Czech 9 : Russian 10 : Turkish 11 : Polish 12 : Greek
A1-02 (0102)	Control Method Selection	   Sets the control method for the drive application and the motor. 0 : V/f Control 5 : PM Open Loop Vector 8 : EZ Vector Control
A1-03 (0103)	Initialize Parameters	   Sets parameters to default values. 0 : No Initialization 1110 : User Initialization 2220 : 2-Wire Initialization 3330 : 3-Wire Initialization 8008 : Pump 8009 : Pump w/ PID 8010 : Fan 8011 : Fan w/ PID
b1-01 (0180)	Frequency Reference Selection 1	   Sets the input method for the frequency reference. 0 : Keypad 1 : Analog Input 2 : Memobus/Modbus Communications 3 : Option PCB 4 : Pulse Train Input
b1-02 (0181)	Run Command Selection 1	   Sets the input method for the Run command. 0 : Keypad 1 : Digital Input 2 : Memobus/Modbus Communications 3 : Option PCB

## 12 Drive Control and Programming

No. (Hex.)	Name	Description
b1-03 (0182)	Stopping Method Selection	<p><b>V/f OLV/PM EZOLV</b></p> <p>Sets the method to stop the motor after removing a Run command or entering a Stop command.</p> <p>0 : Ramp to Stop 1 : Coast to Stop 2 : DC Injection Braking to Stop 3 : Coast to Stop with Timer</p>
b1-04 (0183)	Reverse Operation Selection	<p><b>V/f OLV/PM EZOLV</b></p> <p>Sets the reverse operation function. Disable reverse operation in fan or pump applications where reverse rotation is dangerous.</p> <p>0 : Reverse Enabled 1 : Reverse Disabled</p>
C1-01 (0200) RUN	Acceleration Time 1	<p><b>V/f OLV/PM EZOLV</b></p> <p>Sets the length of time to accelerate from zero to maximum output frequency.</p>
C1-02 (0201) RUN	Deceleration Time 1	<p><b>V/f OLV/PM EZOLV</b></p> <p>Sets the length of time to decelerate from maximum output frequency to zero.</p>
C2-01 (020B)	S-Curve Time @ Start of Accel	<p><b>V/f OLV/PM EZOLV</b></p> <p>Sets the S-curve acceleration time at start.</p>
C2-02 (020C)	S-Curve Time @ End of Accel	<p><b>V/f OLV/PM EZOLV</b></p> <p>Sets the S-curve acceleration time at completion.</p>
C2-03 (020D)	S-Curve Time @ Start of Decel	<p><b>V/f OLV/PM EZOLV</b></p> <p>Sets the S-curve deceleration time at start.</p>
C2-04 (020E)	S-Curve Time @ End of Decel	<p><b>V/f OLV/PM EZOLV</b></p> <p>Sets the S-curve deceleration time at completion.</p>
C6-02 (0224)	Carrier Frequency Selection	<p><b>V/f OLV/PM EZOLV</b></p> <p>Sets the carrier frequency for the transistors in the drive.</p> <p>1 : 2.0 kHz 2 : 5.0 kHz 3 : 8.0 kHz 4 : 10.0 kHz 5 : 12.5 kHz 7 : Swing PWM1 (Audible Sound 1) 8 : Swing PWM2 (Audible Sound 2) 9 : Swing PWM3 (Audible Sound 3) A : Swing PWM4 (Audible Sound 4) B : Leakage Current Rejection PWM F : User Defined (C6-03 to C6-05)</p>
d1-01 to d1-16 (0280 - 0291) RUN	Reference 1 to 16	<p><b>V/f OLV/PM EZOLV</b></p> <p>Sets the frequency reference in the units from 01-03 [Frequency Display Unit Selection].</p>
d1-17 (0292) RUN	Jog Reference	<p><b>V/f OLV/PM EZOLV</b></p> <p>Sets the Jog frequency reference in the units from 01-03 [Frequency Display Unit Selection]. Set H1-xx = 6 [MFDI Function Selection = Jog Reference Selection] to use the Jog frequency reference.</p>
d2-01 (0289)	Frequency Reference Upper Limit	<p><b>V/f OLV/PM EZOLV</b></p> <p>Sets maximum limit for all frequency references. The maximum output frequency is 100%.</p>
d2-02 (028A)	Frequency Reference Lower Limit	<p><b>V/f OLV/PM EZOLV</b></p> <p>Sets minimum limit for all frequency references. The maximum output frequency is 100%.</p>
E1-01 (0300)	Input AC Supply Voltage	<p><b>V/f OLV/PM EZOLV</b></p> <p>Sets the drive input voltage.</p>
E1-04 (0303)	Maximum Output Frequency	<p><b>V/f OLV/PM EZOLV</b></p> <p>Sets the maximum output frequency for the V/f pattern.</p>
E1-05 (0304)	Maximum Output Voltage	<p><b>V/f OLV/PM EZOLV</b></p> <p>Sets the maximum output voltage for the V/f pattern.</p>
E1-06 (0305)	Base Frequency	<p><b>V/f OLV/PM EZOLV</b></p> <p>Sets the base frequency for the V/f pattern.</p>
E1-09 (0308)	Minimum Output Frequency	<p><b>V/f OLV/PM EZOLV</b></p> <p>Sets the minimum output frequency for the V/f pattern.</p>

No. (Hex.)	Name	Description
E2-01 (030E)	Motor Rated Current (FLA)	 Sets the motor rated current in amps.
E2-11 (0318)	Motor Rated Power	 Sets the motor rated output in the units from 01-58 [Motor Power Unit Selection].
H1-01 - H1-08 (0438, 0439, 0400 - 0405)	Term S1 to S8 Function Selection	 Sets the functions for MFDI terminals S1 to S8.
H2-01 (040B)	Term M1-M2 Function Selection	 Sets the function for MFDO terminal M1-M2.
H2-02 (040C)	Term M3-M4 Function Selection	 Sets the function for MFDO terminal M3-M4.
H2-03 (040D)	Term MD-ME-MF Function Selection	 Sets the function for MFDO terminal MD-ME-MF.
H3-01 (0410)	Terminal A1 Signal Level Select	 Sets the input signal level for MFAI terminal A1. 0 : 0 to 10V (Lower Limit at 0) 2 : 4 to 20 mA 3 : 0 to 20 mA
H3-02 (0434)	Terminal A1 Function Selection	 Sets a function for MFAI terminal A1.
H3-03 (0411) RUN	Terminal A1 Gain Setting	 Sets the gain of the analog signal input to MFAI terminal A1.
H3-04 (0412) RUN	Terminal A1 Bias Setting	 Sets the bias of the analog signal input to MFAI terminal A1.
H3-05 (0413)	Terminal A3 Signal Level Select	 Sets the input signal level for MFAI terminal A3. 0 : 0-10V (Lower Limit at 0) 2 : 4 to 20 mA 3 : 0 to 20 mA
H3-06 (0414)	Terminal A3 Function Selection	 Sets the function for MFAI terminal A3.
H3-07 (0415) RUN	Terminal A3 Gain Setting	 Sets the gain of the analog signal input to MFAI terminal A3.
H3-08 (0416) RUN	Terminal A3 Bias Setting	 Sets the bias of the analog signal input to MFAI terminal A3.
H3-09 (0417)	Terminal A2 Signal Level Select	 Sets the input signal level for MFAI terminal A2. 0 : 0-10V (LowLim=0) 2 : 4 to 20 mA 3 : 0 to 20 mA
H3-10 (0418)	Terminal A2 Function Selection	 Sets the function for MFAI terminal A2.
H3-11 (0419) RUN	Terminal A2 Gain Setting	 Sets the gain of the analog signal input to MFAI terminal A2.
H3-12 (041A) RUN	Terminal A2 Bias Setting	 Sets the bias of the analog signal input to MFAI terminal A2.
H3-13 (041B)	Analog Input FilterTime Constant	 Sets the time constant for primary delay filters on MFAI terminals.

## 12 Drive Control and Programming

No. (Hex.)	Name	Description
H3-14 (041C)	Analog Input Terminal Enable Sel	<b>V/f</b> <b>OLV/PM</b> <b>EZOLV</b> Sets the enabled terminal or terminals when $H1-xx = C$ [ <i>MFDI Function Select = Analog Terminal Enable Selection</i> ] is ON. 1 : Terminal A1 only 2 : Terminal A2 only 3 : Terminals A1 and A2 4 : Terminal A3 only 5 : Terminals A1 and A3 6 : Terminals A2 and A3 7 : Terminals A1, A2, and A3
H4-01 (041D)	Terminal FM Analog Output Select	<b>V/f</b> <b>OLV/PM</b> <b>EZOLV</b> Sets the monitor number to send from MFAO terminal FM.
H4-02 (041E) RUN	Terminal FM Analog Output Gain	<b>V/f</b> <b>OLV/PM</b> <b>EZOLV</b> Sets the gain of the monitor signal that is sent from MFAO terminal FM.
H4-03 (041F) RUN	Terminal FM Analog Output Bias	<b>V/f</b> <b>OLV/PM</b> <b>EZOLV</b> Sets the bias of the monitor signal that is sent from MFAO terminal FM.
H4-04 (0420)	Terminal AM Analog Output Select	<b>V/f</b> <b>OLV/PM</b> <b>EZOLV</b> Sets the monitoring number to be output from the MFAO terminal AM.
H4-05 (0421) RUN	Terminal AM Analog Output Gain	<b>V/f</b> <b>OLV/PM</b> <b>EZOLV</b> Sets the gain of the monitor signal that is sent from MFAO terminal AM.
H4-06 (0422) RUN	Terminal AM Analog Output Bias	<b>V/f</b> <b>OLV/PM</b> <b>EZOLV</b> Sets the bias of the monitor signal that is sent from MFAO terminal AM.
H4-07 (0423)	Terminal FM Signal Level Select	<b>V/f</b> <b>OLV/PM</b> <b>EZOLV</b> Sets the MFAO terminal FM output signal level. 0 : 0 to 10 Vdc 2 : 4 to 20 mA
H4-08 (0424)	Terminal AM Signal Level Select	<b>V/f</b> <b>OLV/PM</b> <b>EZOLV</b> Sets the MFAO terminal AM output signal level. 0 : 0 to 10 Vdc 2 : 4 to 20 mA
L1-01 (0480)	Motor Overload (oL1) Protection	<b>V/f</b> <b>OLV/PM</b> <b>EZOLV</b> Sets the motor overload protection with electronic thermal protectors. 0 : Disable 1 : Variable Torque 2 : Constant Torque 10:1 Speed Range 3 : Constant Torque 100:1 SpeedRange 4 : PM Variable Torque 5 : PM Constant Torque 6 : Variable Torque (50Hz)
L1-02 (0481)	Motor Overload Protection Time	<b>V/f</b> <b>OLV/PM</b> <b>EZOLV</b> Sets the operation time for the electronic thermal protector of the drive to prevent damage to the motor. Usually it is not necessary to change this setting.
L3-04 (0492)	Stall Prevention during Decel	<b>V/f</b> <b>OLV/PM</b> <b>EZOLV</b> Sets the method that the drive will use to prevent overvoltage faults when decelerating. 0 : Disabled 1 : General Purpose 2 : Intelligent (Ignore Decel Ramp) 4 : Overexcitation/High Flux 5 : Overexcitation/High Flux 2
o1-58 (3125)	Motor Power Unit Selection	<b>V/f</b> <b>OLV/PM</b> <b>EZOLV</b> Sets the setting unit for parameters that set the motor rated power. 0 : kW 1 : HP

## 13 UL Standards



Figure 13.1 UL/cUL Mark

The UL/cUL Mark identifies that this product conforms to rigid safety standards. This mark appears on products in the United States and Canada. It shows UL approval, which identifies that the product complies with safety standards after careful inspection and assessment. You must use UL Listed or UL Recognized parts for all primary components that are built into electrical equipment that has UL approval.

This product has been tested in accordance with UL standard UL508C, and has been verified to be in compliance with UL standards.

Machines and devices integrated with this product must satisfy the following conditions for compliance with UL standards.

### ◆ Area of Use

Install this product in a location with Overvoltage Category III and pollution degree 2 or less.

### ■ Ambient Temperature Setting

Maintain an ambient temperature between  $-10\text{ }^{\circ}\text{C}$  to  $+40\text{ }^{\circ}\text{C}$  ( $14\text{ }^{\circ}\text{F}$  to  $104\text{ }^{\circ}\text{F}$ ) for IP55/UL Type 12 drives.

### ◆ Main Circuit Wire Gauges and Tightening Torques

Refer to *Three-Phase 208 V Class Wire Gauges and Torques on page 27* and *Three-Phase 480 V Class Wire Gauges and Torques on page 29* for the recommended wire gauges and tightening torques of the main circuit terminals.

Comply with local standards for correct wire gauges in the region where the drive is used.

#### Note:

- The recommended wire gauges are based on drive continuous current ratings with  $75\text{ }^{\circ}\text{C}$  ( $167\text{ }^{\circ}\text{F}$ ) 600 V class cooper wire. Assume these conditions:
  - Ambient temperature:  $40\text{ }^{\circ}\text{C}$  ( $104\text{ }^{\circ}\text{F}$ ) or lower
  - Wiring distance: 100 m (3281 ft) or shorter
  - Normal Duty Rated current value
- For drive models 2075 to 2114 and 4077 to 4096, use UL Listed closed-loop crimp terminals on the drive main circuit terminals. Use the tools recommend by the terminal manufacturer and make sure that the terminals are correctly connected.

### ◆ Ferrules and Closed-Loop Crimp Terminals

To comply with UL standards on drive models 2075 to 2114 and 4077 to 4096, use UL Listed closed-loop crimp terminals. Use the tools recommend by the terminal manufacturer to crimp the closed-loop crimp terminal. Yaskawa recommends closed-loop crimp terminals from PANDUIT Corp.

Install UL Recognized heat-shrinkable tubes to the closed-loop crimp terminals. If you do not use the tubes with the closed-loop crimp terminals, the insulating distance will be too short and it can cause short circuits.

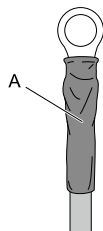

#### A - UL Recognized heat-shrinkable tube

Comply with local standards for correct wire gauges in the region where the drive is used.

Refer to [Table 13.1](#) to select ferrules and crimp terminals as specified by drive model and wire gauge.

**Note:**

To comply with UL standards, use UL Listed vinylcoated insulated copper wires for operation with a continuous maximum permitted temperature of 75 °C at 600 V.

**Table 13.1 Ferrules and Closed-Loop Crimp Terminals**

Model	Terminals *1	Recommended Gauge AWG, kcmil	Ferrule *2	Crimp Terminal Part Number Manufacturer: PANDUIT Corp.		
				Type LCA	Type P	Type S
2011	R/L1, S/L2, T/L3	14	F80-10	N/A	N/A	N/A
	U/T1, V/T2, W/T3	14	F80-10	N/A	N/A	N/A
	⊕	12	N/A	LCA10-14-L	P10-14R-L	N/A
2017	R/L1, S/L2, T/L3	12	F81-10	N/A	N/A	N/A
	U/T1, V/T2, W/T3	10	F82-10	N/A	N/A	N/A
	⊕	10	N/A	LCA10-14-L	P10-14R-L	N/A
2024	R/L1, S/L2, T/L3	10	F82-15	N/A	N/A	N/A
	U/T1, V/T2, W/T3	8	F83-12	N/A	N/A	N/A
	⊕	10	N/A	LCA10-14-L	P10-14R-L	N/A
2031	R/L1, S/L2, T/L3	8	F83-15	N/A	N/A	N/A
	U/T1, V/T2, W/T3	8	F83-12	N/A	N/A	N/A
	⊕	10	N/A	LCA10-14-L	P10-14R-L	N/A
2046	R/L1, S/L2, T/L3	8	F83-18	N/A	N/A	N/A
	U/T1, V/T2, W/T3	6	F84-18	N/A	N/A	N/A
	⊕	8	N/A	LCA8-14-L	P8-14R-Q	S8-14R-Q
2059	R/L1, S/L2, T/L3	4	F85-18	N/A	N/A	N/A
	U/T1, V/T2, W/T3	4	F85-18	N/A	N/A	N/A
	⊕	6	N/A	LCA6-14-L	P6-14R-E	S6-14R-E
2075	R/L1, S/L2, T/L3	4	N/A	LCA4-56-L	P4-56R-E	S4-56R-E
	U/T1, V/T2, W/T3	3 or 2	N/A	LCA4-56-L or LCA2-56-Q	P2-56R-X *3	S2-56R-X *3
	⊕	6	N/A	LCA6-56-L	P6-56R-E	S6-56R-E
2088	R/L1, S/L2, T/L3	3 or 2	N/A	LCA4-56-L or LCA2-56-Q	P2-56R-X *3	S2-56R-X *3
	U/T1, V/T2, W/T3	2	N/A	LCA2-56-Q	P2-56R-X	S2-56R-X
	⊕	6	N/A	LCA6-56-L	P6-56R-E	S6-56R-E
2114	R/L1, S/L2, T/L3	1/0	N/A	LCA1/0-56-X	N/A	S1/0-56R-X
	U/T1, V/T2, W/T3	1/0	N/A	LCA1/0-56-X	N/A	S1/0-56R-X
	⊕	6	N/A	LCA6-56-L	P6-56R-E	S6-56R-E
4005	R/L1, S/L2, T/L3	14	F80-10	N/A	N/A	N/A
	U/T1, V/T2, W/T3	14	F80-10	N/A	N/A	N/A
	⊕	14	N/A	LCA10-14-L	P10-14R-L	N/A

Model	Terminals *1	Recommended Gauge AWG, kcmil	Ferrule *2	Crimp Terminal Part Number Manufacturer: PANDUIT Corp.		
				Type LCA	Type P	Type S
4008	R/L1, S/L2, T/L3	14	F80-10	N/A	N/A	N/A
	U/T1, V/T2, W/T3	14	F80-10	N/A	N/A	N/A
	⊕	14	N/A	LCA10-14-L	P10-14R-L	N/A
4011	R/L1, S/L2, T/L3	14	F80-10	N/A	N/A	N/A
	U/T1, V/T2, W/T3	14	F80-10	N/A	N/A	N/A
	⊕	12	N/A	LCA10-14-L	P10-14R-L	N/A
4014	R/L1, S/L2, T/L3	14	F80-10	N/A	N/A	N/A
	U/T1, V/T2, W/T3	12	F81-10	N/A	N/A	N/A
	⊕	10	N/A	LCA10-14-L	P10-14R-L	N/A
4021	R/L1, S/L2, T/L3	10	F82-15	N/A	N/A	N/A
	U/T1, V/T2, W/T3	10	F82-10	N/A	N/A	N/A
	⊕	10	N/A	LCA10-14-L	P10-14R-L	N/A
4027	R/L1, S/L2, T/L3	10	F82-15	N/A	N/A	N/A
	U/T1, V/T2, W/T3	8	F83-12	N/A	N/A	N/A
	⊕	10	N/A	LCA10-14-L	P10-14R-L	N/A
4034	R/L1, S/L2, T/L3	8	F83-15	N/A	N/A	N/A
	U/T1, V/T2, W/T3	8	F83-12	N/A	N/A	N/A
	⊕	10	N/A	LCA10-14-L	P10-14R-L	N/A
4040	R/L1, S/L2, T/L3	8	F83-18	N/A	N/A	N/A
	U/T1, V/T2, W/T3	8	F83-18	N/A	N/A	N/A
	⊕	8	N/A	LCA8-14-L	P8-14R-Q	S8-14R-Q
4052	R/L1, S/L2, T/L3	6	F84-18	N/A	N/A	N/A
	U/T1, V/T2, W/T3	6	F84-18	N/A	N/A	N/A
	⊕	8	N/A	LCA8-14-L	P8-14R-Q	S8-14R-Q
4065	R/L1, S/L2, T/L3	4	F85-18	N/A	N/A	N/A
	U/T1, V/T2, W/T3	4	F85-18	N/A	N/A	N/A
	⊕	6	N/A	LCA6-14-L	P6-14R-E	S6-14R-E
4077	R/L1, S/L2, T/L3	4	N/A	LCA4-56-L	P4-56R-E	S4-56R-E
	U/T1, V/T2, W/T3	3 or 2	N/A	LCA4-56-L or LCA2-56-Q	P2-56R-X *3	S2-56R-X *3
	⊕	6	N/A	LCA6-56-L	P6-56R-E	S6-56R-E
4096	R/L1, S/L2, T/L3	2	N/A	LCA2-56-Q	P2-56R-X	S2-56R-X
	U/T1, V/T2, W/T3	1	N/A	LCA1-56-E	N/A	S2-56R-X
	⊕	6	N/A	LCA6-56-L	P6-56R-E	S6-56R-E

\*1 You cannot use terminals - and +1 on IP55/UL Type 12 drives with Main Switch.

\*2 Use recommended ferrule or bare wire.

\*3 The recommended wire gauge for this part is AWG 2.

## ◆ Short Circuit Protection Requirements for UL Listing

**⚠ WARNING** *Electrical Shock Hazard. After the input protective device trips, do not immediately energize the drive or operate peripheral devices. Wait for the time specified on the warning label at a minimum and make sure that all indicators are OFF. Then check the wiring and peripheral device ratings to find the cause of the problem. If you do not know the cause of the problem, contact Yaskawa before you energize the drive or peripheral devices. If you do not fix the problem before you operate the drive or peripheral devices, it can cause serious injury or death.*

### ■ UL Compliance

Install one of the types of short circuit protection devices in [Table 13.2](#) or [Table 13.3](#) to comply with UL 508C.

Semiconductor protective type fuses are recommended, but the tables also show alternative short circuit protection devices. Make sure that you install this product in a location with Overvoltage Category III and pollution degree 2 or less.

#### Molded Case Circuit Breaker (MCCB) Ratings

- Maximum MCCB rating is 250% of the drive full load output amp (FLA) rating for models 2011 to 2273 and 4005 to 4302.
- Maximum MCCB rating is 200% of the drive full load output amp (FLA) rating for models 2343, 2396, and 4361 to 4720.
- When you use MCCBs you must mount the drive in a ventilated enclosure according to the minimum enclosure volume specified in this document.

##### Note:

When you use MCCBs, current limiting type are recommended, but not required.

#### Semiconductor Fuses and Motor Circuit Protectors (MCPs)

When you use semiconductor fuses or Motor Circuit Protectors (MCPs) for drive protection, you must mount them in the same enclosure with the drive.

#### Non-Semiconductor Fuse Ratings

- Maximum CC, J, or T fuse rating is 175% of the drive full load output amp (FLA) rating for models 2011 to 2396 and 4005 to 4302.
- Maximum J or T fuse rating is 175% of the drive full load output amp (FLA) rating and enclosed into a ventilated enclosure with a minimum enclosure volume as described in this document for models 4361 to 4720.

#### Short Circuit Current Rating (SCCR)

The maximum SCCR provided by the drive with approved protection device listed in this document is 100,000 RMS symmetrical amps.

#### Electric Code Compliance

The user must provide short circuit protection to protect input branch circuits as specified by the National Electric Code (NEC), the Canadian Electric Code, Part 1 (CEC), and local codes.



## Required Short Circuit Protection

Table 13.2 Required Short Circuit Protection for FP605 AC Drives (240 V Class)

Drive Catalog Code FP65U	Drive Mounted without Supplemental Enclosure (Using Type 1 Kit)		Drive Mounted in Supplemental Enclosure						
	Semiconductor Fuse <sup>*1</sup> Part Number (Permitted Only in Type 1 Kit) <i>Manufacturer: Eaton/Bussmann</i>	Class CC, J, or T Fuse <sup>*2</sup> Maximum Amps	Any Size Protected Enclosure (Ventilated or Non-Ventilated)		Restricted Size Protected Enclosure (Ventilated Only)				
			Semiconductor Fuse <sup>*1</sup> Part Number <i>Manufacturer: Eaton/Bussmann</i>	Class CC, J, or T Fuse <sup>*2 *3</sup> Maximum Amps	Class CC, J, or T Fuse <sup>*2 *3</sup> Maximum Amps	MCCB <sup>*3</sup> Maximum Amps	MCP <sup>*1</sup> Part Number <i>Manufacturer: Schneider</i>	Enclosure Volume Minimum (in <sup>3</sup> )	
						External Heatsink	Internal Heatsink		
2011	Not allowed. Does not support internal fuses for these drive models.	17.5	FWH-40B	17.5	Enclosure volume not restricted. Refer to the values in the column to the left for fuses.	25	HLL36030M71	3056	3056
2017		25	FWH-45B	25		40	HLL36030M71	3056	3056
2024		40	FWH-80B	40		60	HLL36050M72	3056	3056
2031		50	FWH-125B	50		75	HLL36050M72	3056	3056
2046		80	FWH-125B	80		110	HLL36100M73	5520	5520
2059		100	FWH-175B	100		125	HLL36100M73	5520	5520
2075		125	FWH-200B	125		175	HLL36150M74	5520	5520
2088		150	FWH-225A	150		200	HLL36150M74	5520	5520
2114		200	FWH-225A	200		250	HLL36150M74	5520	5520
2143		250	FWH-250A	250		350	JLL36250M75	21582	14657
2169		250	FWH-275A	250		400	JLL36250M75	21582	14657
2211		350	FWH-600A	350		500	LAL3640036M or LLL36400M37X	52800	14657
2273		450	FWH-800A	450		600	LAL3640036M or LLL36400M37X	52800	14657
2343		600	FWH-1000A or FWH-1000B	600		700	PLL34060M68	52800	52800
2396	700	FWH-1000A or FWH-1000B	700	800	PLL34060M68	52800	52800		

\*1 Protection device must be in same enclosure with drive.

\*2 Class T fuses are fast-acting (non-time-delay) only. Class CC and J can be either time-delay or non-time-delay.

\*3 Protection device and drive permitted in same or separate enclosure.

**Table 13.3 Required Short Circuit Protection for FP605 AC Drives (480 V Class)**

Drive Catalog Code FP65U	Drive Mounted without Supplemental Enclosure (Using Type 1 Kit)		Drive Mounted in Supplemental Enclosure						
			Any Size Protected Enclosure (Ventilated or Non-Ventilated)		Restricted Size Protected Enclosure (Ventilated Only)				
	Semiconductor Fuse <sup>*1</sup> Part Number (Permitted Only in Type 1 Kit) Manufacturer: Eaton/Bussmann	Class CC, J, or T Fuse <sup>*2</sup> Maximum Amps	Semiconductor Fuse <sup>*1</sup> Part Number Manufacturer: Eaton/Bussmann	Class CC, J, or T Fuse <sup>*2 *3</sup> Maximum Amps	Class CC, J, or T Fuse <sup>*2 *3</sup> Maximum Amps	MCCB <sup>*3</sup> Maximum Amps	MCP <sup>*1</sup> Part Number Manufacturer: Schneider	Enclosure Volume Minimum (in <sup>3</sup> )	
							External Heatsink	Internal Heatsink	
4005	Not allowed. Does not support internal fuses for these drive models.	8	FWH-25A14F	8	Enclosure volume not restricted. Refer to the values in the column to the left for fuses.	15	HLL36030M71	3056	3056
4006		9	FWH-30A14F	9		15	HLL36030M71	3056	3056
4008		12	FWH-30A14F	12		15	HLL36030M71	3056	3056
4011		17.5	FWH-40B	17.5		25	HLL36030M71	3056	3056
4014		20	FWH-45B	20		35	HLL36030M71	3056	3056
4021		35	FWH-60B	35		50	HLL36030M71	3056	3056
4027		45	FWH-80B	45		60	HLL36050M72	3056	3056
4034		60	FWH-100B	60		80	HLL36050M72	3056	3056
4040		70	FWH-125B	70		100	HLL36100M73	5520	5520
4052		90	FWH-150B	90		125	HLL36100M73	5520	5520
4065		110	FWH-200B	110		150	HLL36100M73	5520	5520
4077		125	FWH-225A	125		175	HLL36100M73	5520	5520
4096		150	FWH-225A	150		225	HLL36150M74	5520	5520
4124		200	FWH-225A	200		300	JLL36250M75	5520	5520
4156		250	FWH-325A	250		350	JLL36250M75	21582	14657
4180		300	FWH-500A	300		450	JLL36250M75	52800 <sup>*4</sup>	14657
4240		400	FWH-600A	400		600	LAL3640036M or LLL36400M37X	52800 <sup>*4</sup>	14657
4302		500	FWH-700A	500		700	LAL3640036M or LLL36400M37X	52800 <sup>*4</sup>	14657
4361	FWH-800A	Not allowed. Must use semiconductor fuses.	FWH-800A	Not allowed. Must use minimum enclosure volume requirements.	600	700	PLL34060M68	52800 <sup>*4</sup>	52800
4414	FWH-1000A or FWH-1000B		FWH-1000A or FWH-1000B		700	800	PLL34060M68	52800 <sup>*4</sup>	52800
4477	FWH-1200A or FWH-1200B		FWH-1200A or FWH-1200B		800	900	PLL34080M68	52800 <sup>*4</sup>	52800
4515	FWH-1200A or FWH-1200B		FWH-1200A or FWH-1200B		900	1000	PLL34080M68	52800 <sup>*4</sup>	52800
4590	FWH-1400A		FWH-1400A		1000	1200	PLL34080M68	52800 <sup>*4</sup>	52800
4720	FWH-1400A		FWH-1400A		1200	1400	PLL34100M69	52800 <sup>*4</sup>	52800

\*1 Protection device must be in same enclosure with drive.  
 \*2 Class T fuses are fast-acting (non-time-delay) only. Class CC and J can be either time-delay or non-time-delay.  
 \*3 Protection device and drive permitted in same or separate enclosure.  
 \*4 External heatsink installation on these models requires a heatsink shroud and filter.

## ◆ Low Voltage Wiring for Control Circuit Terminals

You must provide low voltage wiring as specified by the National Electric Code (NEC), the Canadian Electric Code, Part I (CEC), and local codes. Yaskawa recommends the NEC class 1 circuit conductor. Use the UL Listed class 2 power supply for external power supply.

**Table 13.4 Control Circuit Terminal Power Supplies**

Input/Output	Terminals	Power Supply Specifications
Digital input	S1 to S8, SN, SC, SP	Uses the LVLC power supply in the drive. Use the UL Listed class 2 power supply for external power supply.
Analog input	A1 to A3, AC, +V	Uses the LVLC power supply in the drive. Use the UL Listed class 2 power supply for external power supply.
Analog output	FM, AM, AC	Uses the LVLC power supply in the drive.
Pulse train input	RP, AC	Uses the LVLC power supply in the drive. Use the UL Listed class 2 power supply for external power supply.
Safe disable input	H1, H2, HC	Uses the LVLC power supply in the drive. Use the UL Listed class 2 power supply for external power supply.
Serial communication input/output	D+, D-, AC	Uses the LVLC power supply in the drive. Use the UL Listed class 2 power supply for external power supply.
24 V external power supply input/output	PS, AC, +P	Use the UL Listed class 2 power supply.

## ◆ Drive Motor Overload and Overheat Protection

The drive motor overload and overheat protection function complies with the National Electric Code (NEC) and the Canadian Electric Code, Part I (CEC).

Set the Motor Rated Current and *L1-01 through L1-04 [Motor Overload Protection Select]* correctly to enable motor overload and overheat protection.

Refer to the control method and set the motor rated current with *E2-01 [Motor Rated Current (FLA)]*, *E5-03 [PM Motor Rated Current (FLA)]*, or *E9-06 [Motor Rated Current (FLA)]*.

### ■ E2-01: Motor Rated Current (FLA)

No. (Hex.)	Name	Description	Default (Range)
E2-01 (030E)	Motor Rated Current (FLA)	<input type="checkbox"/> V/f <input type="checkbox"/> OLV/PM <input type="checkbox"/> EZOLV Sets the motor rated current in amps.	Determined by o2-04 (10% to 200% of the drive rated current)

**Note:**

- If *E2-01 < E2-03 [Motor No-Load Current]* the drive will detect *oPE02 [Parameter Range Setting Error]*.
- The default settings and setting ranges are in these units:  
 –0.01 A: 2011 to 2046, 4005 to 4014  
 –0.1 A: 2059 to 2114, 4021 to 4096

The value set for *E2-01* becomes the reference value for motor protection and the torque limit. Enter the motor rated current as written on the motor nameplate. The value of *E2-01* is automatically set to the value input for “Motor Rated Current” by the Auto-Tuning process.

### ■ E5-03: PM Motor Rated Current (FLA)

No. (Hex.)	Name	Description	Default (Range)
E5-03 (032B)	PM Motor Rated Current (FLA)	<input type="checkbox"/> V/f <input checked="" type="checkbox"/> OLV/PM <input type="checkbox"/> EZOLV Sets the PM motor rated current (FLA).	Determined by o2-04 (10% to 200% of the drive rated current)

**Note:**

When the drive model changes, the display units for this parameter also change.

- 0.01 A: 2011 to 2046, 4005 to 4014
- 0.1 A: 2059 to 2114, 4021 to 4096

The drive automatically sets *E5-03* to the value input for “PM Motor Rated Current” after you do these types of Auto-Tuning:

- PM Motor Parameter Settings
- PM Stationary Auto-Tuning
- PM StaTun for Stator Resistance
- PM Rotational Auto-Tuning

■ **E9-06: Motor Rated Current (FLA)**

No. (Hex.)	Name	Description	Default (Range)
E9-06 (11E9)	Motor Rated Current (FLA)	<input type="checkbox"/> V/f <input type="checkbox"/> OLV/PM <input checked="" type="checkbox"/> EZOLV Sets the motor rated current in amps.	Determined by E9-01 and o2-04 (10% to 200% of the drive rated current)

**Note:**

When the drive model changes, the display units for this parameter also change.

- 0.01 A: 2011 to 2046, 4005 to 4014
- 0.1 A: 2059 to 2114, 4021 to 4096

The setting value of *E9-06* is the reference value for motor protection. Enter the motor rated current shown on the motor nameplate. Auto-Tuning the drive will automatically set *E9-06* to the value input for “Motor Rated Current”.

■ **L1-01: Motor Overload (oL1) Protection**

No. (Hex.)	Name	Description	Default (Range)
L1-01 (0480)	Motor Overload (oL1) Protection	<input type="checkbox"/> V/f <input type="checkbox"/> OLV/PM <input checked="" type="checkbox"/> EZOLV Sets the motor overload protection with electronic thermal protectors.	Determined by A1-02 (0 - 6)

This parameter enables and disables the motor overload protection with electronic thermal protectors.

The cooling capability of the motor changes when the speed control range of the motor changes. Use an electronic thermal protector that aligns with the permitted load characteristics of the motor to select motor protection.

The electronic thermal protector of the drive uses these items to calculate motor overload tolerance and supply overload protection for the motor:

- Output current
- Output frequency
- Motor thermal characteristics
- Time characteristics

If the drive detects motor overload, the drive will trigger an *oL1* [*Motor Overload*] and stop the drive output.

Set *H2-01 = 1F* [*Term M1-M2 Function Selection = Motor Overload Alarm (oL1)*] to set a motor overload alarm. If the motor overload level is more than 90% of the *oL1* detection level, the output terminal activates and triggers an overload alarm.

**0 : Disable**

Disable motor protection when motor overload protection is not necessary or when the drive is operating more than one motor.

Refer to [Figure 13.2](#) for an example of the circuit configuration to connect more than one motor to one drive.

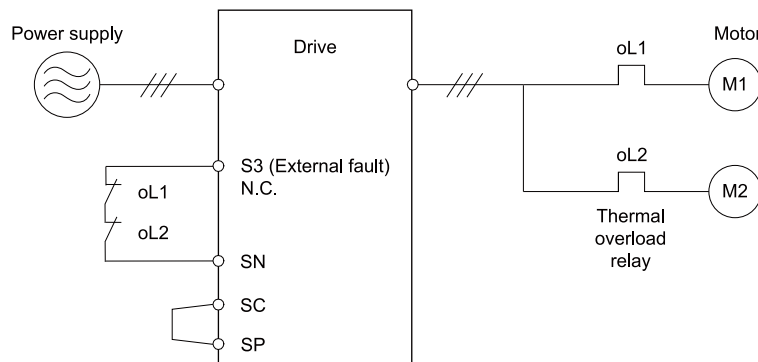

**Figure 13.2 Protection Circuit Configuration to Connect More than One Motor to One Drive**

**NOTICE** When you connect more than one motor to one drive or when the motor amp rating is higher than the drive amp rating, set L1-01 = 0 [Motor Overload (oL1) Protection = Disabled] and install thermal overload relays for each motor. The electronic thermal protection of the drive will not function and it can cause damage to the motor.

**1 : Variable Torque**

Use this setting for general-purpose motors with a 60 Hz base frequency.

The overload tolerance decreases as motor speed decreases because the cooling fan speed decreases and the ability of the motor to cool decreases in the low speed range.

The overload tolerance characteristics of the motor change the trigger point for the electronic thermal protector. This provides motor overheat protection from low speed to high speed across the full speed range.

Load Tolerance	Cooling Capability	Overload Characteristics (at 100% motor load)
	<p>This motor is designed to operate with commercial line power. Operate at a 60 Hz base frequency to maximize the motor cooling ability.</p>	<p>If the motor operates at frequencies less than 60 Hz, the drive will detect oL1. The drive triggers a fault relay output and the motor coasts to stop.</p>

**2 : Constant Torque 10:1 Speed Range**

Use this setting for drive-dedicated motors with a speed range for constant torque of 1:10.

The speed control for this motor is 10% to 100% when at 100% load. Operating slower than 10% speed at 100% load will cause motor overload.

Load Tolerance	Cooling Capability	Overload Characteristics (at 100% motor load)
	<p>This motor is designed to withstand increased temperatures during continuous operation in the low speed range (10% base frequency).</p>	<p>The motor operates continuously at 10% to 100% base frequency. Operating slower than 10% speed at 100% load will cause motor overload.</p>

### 3 : Constant Torque 100:1 SpeedRange

Use this setting for vector motors with a speed range for constant torque of 1:100.

The speed control for this motor is 1% to 100% when at 100% load. Operating slower than 1% speed at 100% load will cause motor overload.

Load Tolerance	Cooling Capability	Overload Characteristics (at 100% motor load)
	<p>This motor is designed to withstand increased temperatures during continuous operation in the low speed range (1% base frequency).</p>	<p>The motor operates continuously at 1% to 100% base frequency. Operating slower than 1% speed at 100% load will cause motor overload.</p>

### 4 : PM Variable Torque

Use this setting for PM motors with derated torque characteristics.

The overload tolerance decreases as motor speed decreases because the cooling fan speed decreases and the ability of the motor to cool decreases in the low speed range.

The overload tolerance characteristics of the motor change the trigger point for the electronic thermal protector. This provides motor overheat protection from low speed to high speed across the full speed range.

Load Tolerance	Cooling Capability	Overload Characteristics (at 100% motor load)
	<p>This motor is designed to withstand increased temperatures during continuous operation at rated speed and rated torque.</p>	<p>If the motor operates continuously at lower speed than rated rotation speed at more than 100% torque, the drive will detect <i>o.l.l.</i> The drive triggers a fault relay output and the motor coasts to stop.</p>

### 5 : PM Constant Torque

Use this setting with a PM motor for constant torque that has a speed range for constant torque of 1:500.

The speed control for this motor is 0.2% to 100% when at 100% load. Operating slower than 0.2% speed at 100% load will cause motor overload.

Load Tolerance	Cooling Capability	Overload Characteristics (at 100% motor load)
	<p>This motor is designed to withstand increased temperatures during continuous operation in the low speed range (0.2% base frequency).</p>	<p>The motor operates continuously at 0.2% to 100% rated speed. Operating slower than 0.2% speed at 100% load will cause motor overload.</p>

### 6 : Variable Torque (50Hz)

Use this setting for general-purpose motors with a 50 Hz base frequency.

The overload tolerance decreases as motor speed decreases because the cooling fan speed decreases and the ability of the motor to cool decreases in the low speed range.

The overload tolerance characteristics of the motor change the trigger point for the electronic thermal protector. This provides motor overheat protection from low speed to high speed across the full speed range.

Load Tolerance	Cooling Capability	Overload Characteristics (at 100% motor load)
	<p>This motor is designed to operate with commercial line power. Operate at a 50 Hz base frequency to maximize the motor cooling ability.</p>	<p>If the motor operates at frequencies less than commercial line power, the drive will detect <i>oLI</i>. The drive triggers a fault relay output and the motor coasts to stop.</p>

### ■ L1-02: Motor Overload Protection Time

No. (Hex.)	Name	Description	Default (Range)
L1-02 (0481)	Motor Overload Protection Time	<p><b>V/f</b> <b>OLVPM</b> <b>EZOLV</b></p> <p>Sets the operation time for the electronic thermal protector of the drive to prevent damage to the motor. Usually it is not necessary to change this setting.</p>	1.0 min (0.1 - 5.0 min)

Set the overload tolerance time to the length of time that the motor can operate at 150% load from continuous operation at 100% load.

When the motor operates at 150% load continuously for 1 minute after continuous operation at 100% load (hot start), the default setting triggers the electronic thermal protector.

Figure 13.3 shows an example of the electronic thermal protector operation time. Motor overload protection operates in the range between a cold start and a hot start.

This example shows a general-purpose motor operating at the base frequency with *L1-02* set to 1.0 min.

- Cold start  
Shows the motor protection operation time characteristics when the overload occurs immediately after starting operation from a complete stop.
- Hot start  
Shows the motor protection operation time characteristics when overload occurs from continuous operation below the motor rated current.

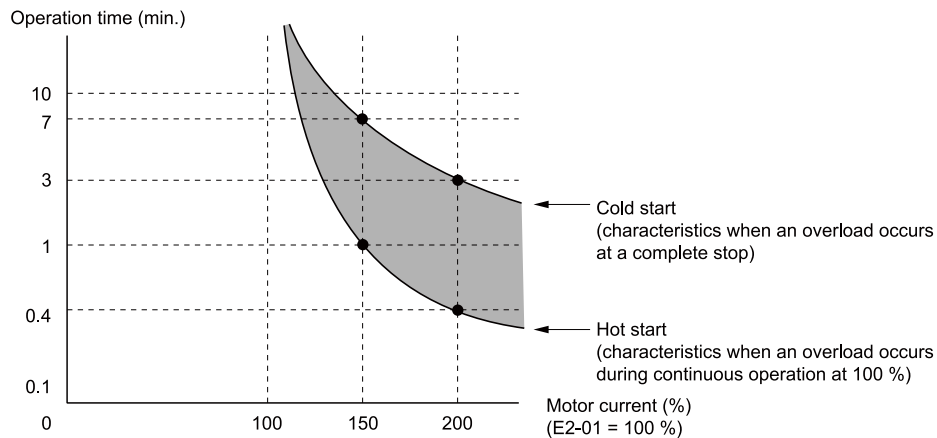

Figure 13.3 Protection Operation Time for a General-purpose Motor at Rated Output Frequency

■ **L1-03: Motor Thermistor oH Alarm Select**

No. (Hex.)	Name	Description	Default (Range)
L1-03 (0482)	Motor Thermistor oH Alarm Select	<div style="display: flex; gap: 5px;"> <span style="border: 1px solid black; padding: 2px;">V/f</span> <span style="border: 1px solid black; padding: 2px;">OLV/PM</span> <span style="border: 1px solid black; padding: 2px;">EZOLV</span> </div> <p>Sets drive operation when the PTC input signal entered into the drive is at the <i>oH3 [Motor Overheat (PTC Input)]</i> detection level.</p>	3 (0 - 3)

**0 : Ramp to Stop**

The drive ramps the motor to stop in the deceleration time. Fault relay output terminal MA-MC turns ON and MB-MC turns OFF.

**1 : Coast to Stop**

The output turns OFF and the motor coasts to stop. Fault relay output terminal MA-MC turns ON, and MB-MC turns OFF.

**2 : Fast Stop (Use C1-09)**

The drive stops the motor in the deceleration time set in *C1-09 [Fast Stop Time]*. Fault relay output terminal MA-MC turns ON, and MB-MC turns OFF.

**3 : Alarm Only**

The keypad shows *oH3*, and operation continues. The output terminal set for *Alarm [H2-01 to H2-03 = 10]* turns ON.

■ **L1-04: Motor Thermistor oH Fault Select**

No. (Hex.)	Name	Description	Default (Range)
L1-04 (0483)	Motor Thermistor oH Fault Select	<div style="display: flex; gap: 5px;"> <span style="border: 1px solid black; padding: 2px;">V/f</span> <span style="border: 1px solid black; padding: 2px;">OLV/PM</span> <span style="border: 1px solid black; padding: 2px;">EZOLV</span> </div> <p>Sets the drive operation when the PTC input signal to the drive is at the <i>oH4 [Motor Overheat Fault (PTC Input)]</i> detection level.</p>	1 (0 - 2)

**0 : Ramp to Stop**

The drive ramps the motor to stop in the deceleration time. Fault relay output terminal MA-MC turns ON, and MB-MC turns OFF.

**1 : Coast to Stop**

The output turns OFF and the motor coasts to stop. Fault relay output terminal MA-MC turns ON, and MB-MC turns OFF.

**2 : Fast Stop (Use C1-09)**

The drive stops the motor in the deceleration time set in *C1-09 [Fast Stop Time]*. Fault relay output terminal MA-MC turns ON, and MB-MC turns OFF.

**14 European Standards**



Figure 14.1 CE Mark

The CE Mark identifies that the product meets environmental and safety standards in the European Union. Products manufactured, sold, or imported in the European Union must display the CE Mark.

European Union standards include standards for electrical appliances (Low Voltage Directive), standards for electrical noise (EMC Directive), and standards for machinery (Machinery Directive).

This product displays the CE Mark in accordance with the Low Voltage Directive, the EMC Directive, and the Machinery Directive.



Table 14.1 Harmonized Standard

European Directive	Harmonized Standard <sup>*1</sup>
Low Voltage Directive 2014/35/EU	EN 61800-5-1:2007
EMC Directive 2014/30/EU	EN 61800-3:2004/A1:2012 First environment restricted distribution
Machinery Directive 2006/42/EC	<ul style="list-style-type: none"> <li>• EN ISO 13849-1:2015 (Cat. 3, PL e)</li> <li>• EN 62061:2005/A2:2015 (SIL CL3)</li> <li>• EN 61800-5-2:2007 (SIL3)</li> <li>• EN IEC 63000:2018</li> </ul>

\*1 Refer to EU Declaration of Conformity for the latest information about the harmonized standard.

The customer must display the CE Mark on the final device containing this product. Customers must verify that the final device complies with EU standards.

## ◆ EU Declaration of Conformity

Go to [www.yaskawa.com](http://www.yaskawa.com) and search for “EU Declaration of Conformity” to get an original copy of the EU Declaration of Conformity.

Yaskawa declares that this product complies with the following directives and standards at our sole responsibility.

## ◆ CE Low Voltage Directive Compliance

It has been confirmed that this product complies with the CE Low Voltage Directive by conducting a test according to IEC/EN 61800-5-1.

The following conditions must be satisfied for machines and devices incorporating this product to comply with the CE Low Voltage Directive.

### ■ Area of Use

Install this product in a location with Overvoltage Category III and pollution degree 2 or less.

### ■ Electrical Installation

Refer to [Figure 14.2](#) for an example of a drive that is wired to comply with the CE Low Voltage Directive.

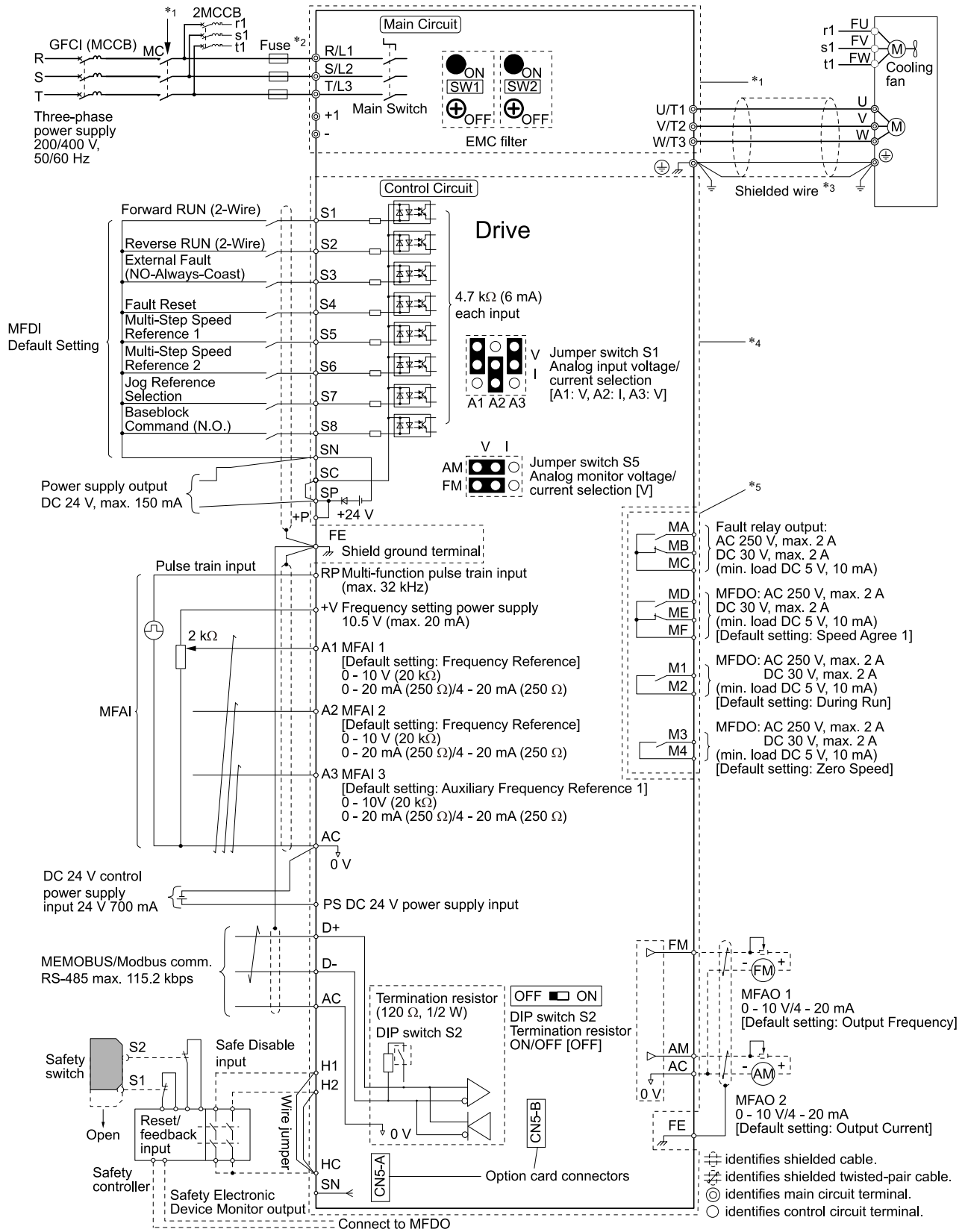

**Figure 14.2 Wiring Diagram for CE Low Voltage Directive Compliance**

- \*1 For circuit protection, the main circuit is separated from the surface case that can touch the main circuit.
- \*2 To comply with LVD standard requirement, set L8-05 = 1 [Input Phase Loss Protection Sel = Enabled] to protect the drive from the high current caused by Input Phase Loss condition.
- \*3 Use braided shield cable for the drive and motor wiring, or run the wiring through a metal conduit.

- \*4 The control circuit is a Safety Extra-Low Voltage circuit. Separate this circuit from other circuits with reinforced insulation. Make sure to connect the Safety Extra-Low Voltage circuit as specified.
- \*5 Reinforced insulation separates the output terminals from other circuits. When the drive output is 250 Vac 1 A maximum or 30 Vdc 1 A maximum, you can also connect circuits that are not Safety Extra-Low Voltage circuits.

## ■ Main Circuit Wire Gauges and Tightening Torques

Refer to *Three-Phase 208 V Class Wire Gauges and Torques on page 27* and *Three-Phase 480 V Class Wire Gauges and Torques on page 29* for the recommended wire gauges and tightening torques of the main circuit terminals.

### Note:

The recommended wire gauges are based on drive continuous current ratings with 75 °C (167 °F) 600 V class copper wire. Assume these conditions:

- Ambient temperature: 40 °C (104 °F) or lower
- Wiring distance: 100 m (3281 ft) or shorter
- Normal Duty Rated current value

## ■ Connect a Fuse and a GFCI to the Input Side (Primary Side)

The drive circuit protection must comply with IEC/EN 61800-5-1 for protection against a short circuit in the internal circuitry. Yaskawa recommends connecting a semiconductor protection fuse and a Ground Fault Circuit Interrupter (GFCI) on the input side for branch circuit protection.

**⚠ WARNING** *Electrical Shock Hazard. After the drive blows a fuse or trips a GFCI, do not immediately energize the drive or operate peripheral devices. Wait for the time specified on the warning label at a minimum and make sure that all indicators are OFF. Then check the wiring and peripheral device ratings to find the cause of the problem. If you do not know the cause of the problem, contact Yaskawa before you energize the drive or peripheral devices. If you do not fix the problem before you operate the drive or peripheral devices, it can cause serious injury or death.*

**Table 14.2 Factory-Recommended Semiconductor Protection Fuses (208 V Class)**

Drive Model	Semiconductor Protection Fuse Model Manufacturer: EATON/Bussmann	Drive Model	Semiconductor Protection Fuse Model Manufacturer: EATON/Bussmann
2011	FWH-40B	2059	FWH-175B
2017	FWH-45B	2075	FWH-200B
2024	FWH-80B	2088	FWH-225A
2031	FWH-125B	2114	FWH-225A
2046	FWH-125B		

**Table 14.3 Factory-Recommended Semiconductor Protection Fuses (480 V Class)**

Drive Model	Semiconductor Protection Fuse Model Manufacturer: EATON/Bussmann	Drive Model	Semiconductor Protection Fuse Model Manufacturer: EATON/Bussmann
4005	FWH-25A14F	4034	FWH-100B
4008	FWH-30A14F	4040	FWH-125B
4011	FWH-40B	4052	FWH-150B
4014	FWH-45B	4065	FWH-200B
4021	FWH-60B	4077	FWH-225A
4027	FWH-80B	4096	FWH-225A

**Table 14.4 Factory-Recommended GFCI (208 V Class)**

Drive Model	GFCI Model Manufacturer: Mitsubishi Electric	Rated Current A	Rated Leakage Current mA
2011	NV32-SV	20	500
2017	NV32-SV	32	500
2024	NV63-SV	50	500
2031	NV63-SV	60	500
2046	NV125-SV	100	500

Drive Model	GFCI Model Manufacturer: Mitsubishi Electric	Rated Current A	Rated Leakage Current mA
2059	NV125-SV	125	500
2075	NV250-SV	150	500
2088	NV250-SV	175	500
2114	NV250-SV	225	500

**Table 14.5 Factory-Recommended GFCI (480 V Class)**

Drive Model	GFCI Model Manufacturer: Mitsubishi Electric	Rated Current A	Rated Leakage Current mA
4005	NV32-SV	15	500
4008	NV32-SV	15	500
4011	NV32-SV	20	500
4014	NV32-SV	30	500
4021	NV63-SV	50	500
4027	NV63-SV	63	500
4034	NV63-SV	63	500
4040	NV125-SV	100	500
4052	NV125-SV	125	500
4065	NV125-SV	125	500
4077	NV250-SV	150	500
4096	NV250-SV	200	500

## ◆ EMC Directive

Drives with built-in EMC filters were tested in accordance with European standard IEC/EN 61800-3, and comply with the EMC Directive.

### ■ Install a Drive to Conform to the EMC Directive

Use this procedure to install drives that comply with the EMC Directive when the drive is a single unit or installed in a larger device.

1. Install the drive on a grounded metal plate.
2. Wire the drive and motor.
3. Ground the wire shielding on the drive side and motor side.

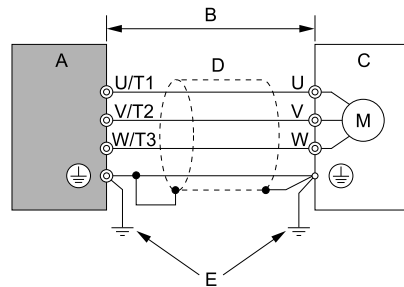

A - Drive

B - 100 m (328 ft) maximum

C - Motor

D - Metal conduit

E - Grounding wire

**Figure 14.3 Wiring the Drive and Motor**

**Note:**

- Use a braided shield cable for the drive and motor wiring or put the wires through a metal conduit.
- The maximum wiring length between the drive and motor is 100 m (328 ft). Keep the wire as short as possible.
- Keep the grounding wire as short as possible.

4. Use a cable clamp to ground the motor cable to the metal plate.

**Note:**

Make sure that the protective ground wire complies with technical specifications and local safety standards.

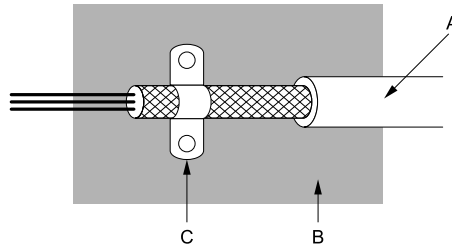

**A - Braided shield cable**

**B - Metal plate**

**C - Cable clamp (conductive)**

**Figure 14.4 Ground the shield**

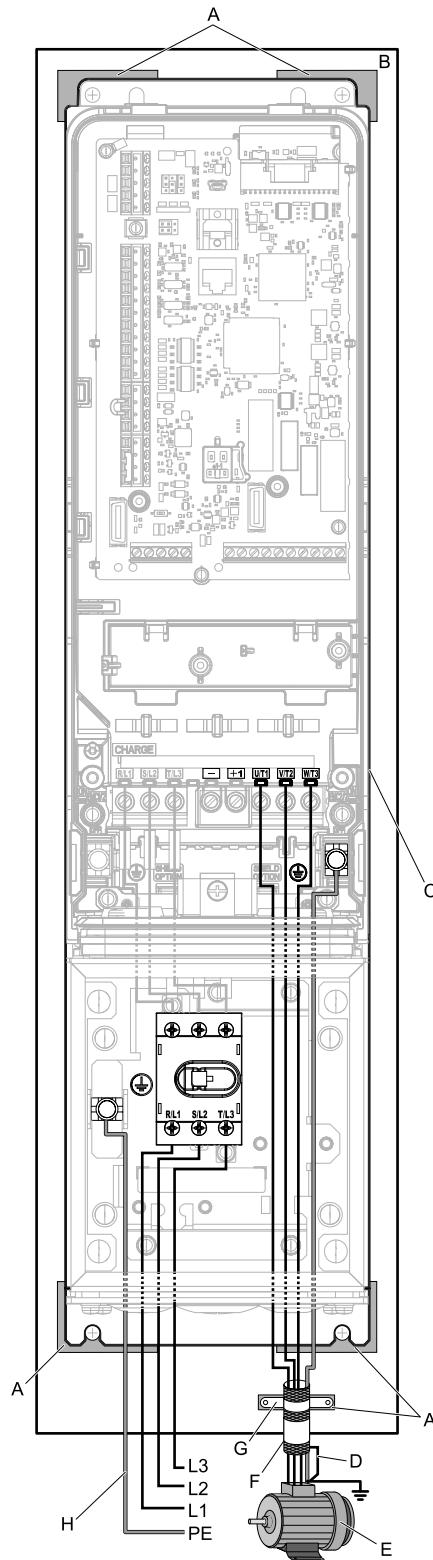

- A - Grounding surface (Remove any paint or sealant.)
- B - Metal plate
- C - Drive
- D - Shielded wire
- E - Motor
- F - Motor cable (Braided shield cable: 10 m (32.8 ft) maximum)
- G - Cable clamp
- H - Grounding wire

Figure 14.5 Install a Drive with a Built-in EMC Filter

## Ground Wiring

**⚠ WARNING** *Electrical Shock Hazard. Do not remove covers or touch circuit boards while the drive is energized. If you touch the internal components of an energized drive, it can cause serious injury or death.*

**⚠ WARNING** *Electrical Shock Hazard. Ground the neutral point on the power supply of the drives to comply with the EMC Directive before you turn on the EMC filter. If you turn ON the EMC filter, but you do not ground the neutral point, it can cause serious injury or death.*

### Enable the Internal EMC Filter

Move the screws to turn ON and OFF (enable and disable) the EMC filter.

Make sure that you apply a symmetric grounding network and install the screws in the ON position to enable the built-in EMC filter in compliance with the EMC Directive. The default position of the EMC filter switch screws is the OFF position. Refer to [Table 14.7](#) and the Switch Location Diagrams for more information about the available EMC filter switch screws for each drive model.

**⚠ WARNING** *Electrical Shock Hazard. Disconnect all power to the drive, wait for the time specified on the warning label, and check the drive for dangerous voltages before you remove covers or touch EMC filter screws. If you touch the screws when there are dangerous voltages, it will cause serious injury or death.*

**⚠ WARNING** *Electrical Shock Hazard. Do not remove covers or touch circuit boards while the drive is energized. If you touch the internal components of an energized drive, it can cause serious injury or death.*

**⚠ WARNING** *Electrical Shock Hazard. Ground the neutral point on the power supply of the drives to comply with the EMC Directive before you turn on the EMC filter. If you turn ON the EMC filter, but you do not ground the neutral point, it can cause serious injury or death.*

**⚠ WARNING** *Electrical Shock Hazard. Connect the ground cable correctly. If you touch electrical equipment that is not grounded, it can cause serious injury or death.*

**NOTICE** *To disable the internal EMC filter, move the screws from ON to OFF and then tighten to the specified torque. If you fully remove the screws or tighten the screws to an incorrect torque, it can cause drive failure.*

**NOTICE** *Move the EMC switch screw or screws to the OFF position for networks that are not symmetrically grounded. If the screws are not in the correct position, it can cause damage to the drive.*

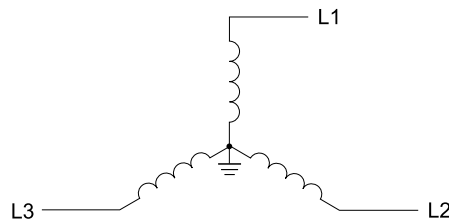

Figure 14.6 Symmetric Grounding

**NOTICE** *Damage to Equipment. When you use the drive with a non-grounding, high-resistance grounding, or asymmetric-grounding network, put the EMC Filter screw or screws in the OFF position to disable the built-in EMC filter. If you do not disable the built-in EMC filter, it will cause damage to the drive.*

[Table 14.6](#) shows asymmetric grounding networks.

Table 14.6 Asymmetric Grounding

Type of Grounding	Diagram
Grounded at the corner of the delta connection	
Grounded at the middle of the side	

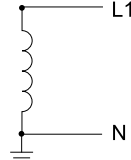
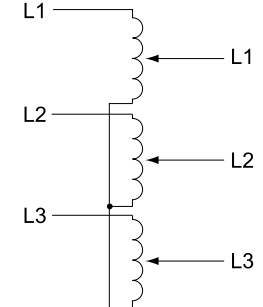
Type of Grounding	Diagram
Single-phase, grounded at the end point	
Three-phase variable transformer without solidly grounded neutral	

**Table 14.7 EMC Filter Switch Location**

Model	Switch Location Diagram
2011, 2017, 4005 - 4014	<a href="#">Figure 14.7</a>
2024, 2031, 4021 - 4034	<a href="#">Figure 14.8</a>
2046, 2059, 4040 - 4065	<a href="#">Figure 14.9</a>
2075 - 2114, 4077 - 4096	<a href="#">Figure 14.10</a>

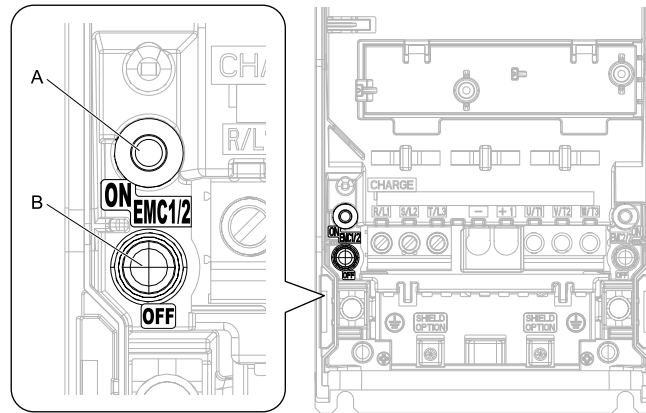

**A - SW (ON)**

**B - Screw (OFF)**

**Figure 14.7 EMC Filter Switch Location 1**



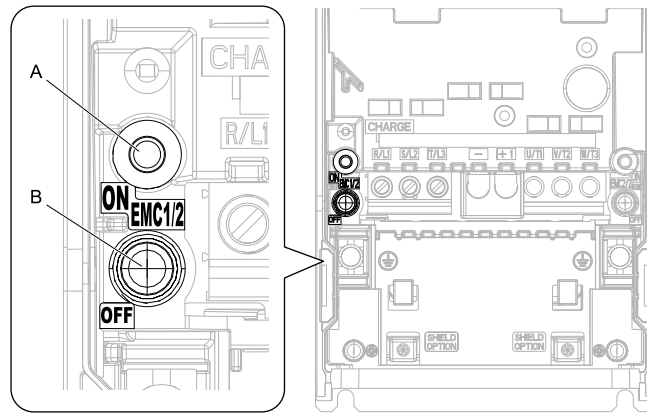

A - SW (ON)

B - Screw (OFF)

Figure 14.8 EMC Filter Switch Location 2

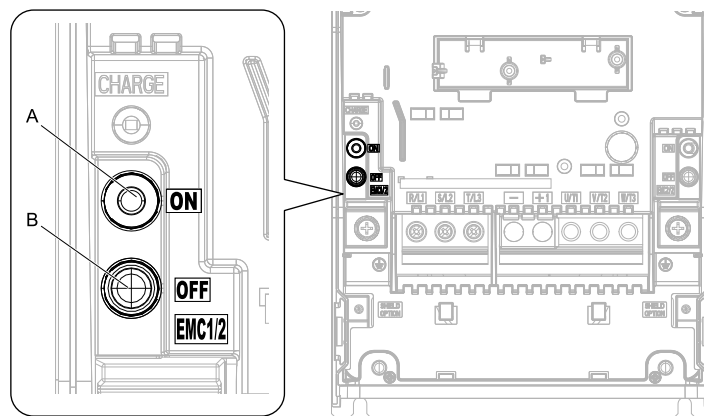

A - SW (ON)

B - Screw (OFF)

Figure 14.9 EMC Filter Switch Location 3

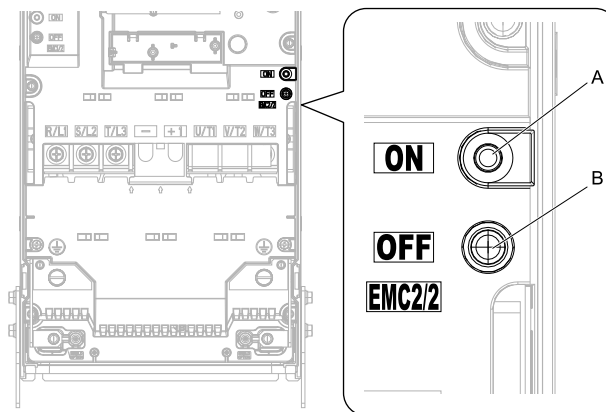

A - SW (ON)

B - Screw (OFF)

Figure 14.10 EMC Filter Switch Location 4

If you lose an EMC filter switch screw, use [Table 14.8](#) to find the correct replacement screw and install the new screws with the correct tightening torque.

**NOTICE** Only use the screws specified in this manual. If you use screws that are not approved, it can cause damage to the drive.

**Table 14.8 Screw Sizes and Tightening Torques**

<b>Model</b>	<b>Screw Size</b>	<b>Tightening Torque N·m</b>
2011 - 2059, 4005 - 4065	M4 × 20	1.0 - 1.3
2075 - 2114, 4077 - 4096	M4 × 30	1.0 - 1.3

## 15 China RoHS Compliance



Figure 15.1 China RoHS Mark

The China RoHS mark is displayed on products containing six specified hazardous substances that are in excess of regulatory limits, based on the “Administrative Measures for the Restriction of the Use of Hazardous Substances in Electrical and Electronic Products” and “Marking for the Restricted Use of Hazardous Substances in Electronic and Electrical Products” (SJ/T 11364-2014), which were promulgated on January 26, 2016. The number displayed in the center of the mark indicates the environment-friendly use period (number of years) in which electrical and electronic products that are being produced, sold, or imported to China can be used. The date of manufacture of the electrical and electronic product is the starting date of the environment-friendly use period for the product. The six specified hazardous substances contained in the product will not leak outside of the product during normal use within this period and will have no serious impact on the environment, the human body, or property.

The environment-friendly use period for this product is 15 years. This period is not the product warranty period.

### ◆ Information on Hazardous Substances in This Product

Table 15.1 shows the details on hazardous substances contained in this product.

Table 15.1 Contents of Hazardous Substances in This Product

Parts Name	Hazardous Substances					
	Lead (Pb)	Mercury (Hg)	Cadmium (Cd)	Hexavalent Chromium (Cr(VI))	Polybrominated Biphenyls (PBB)	Polybrominated Diphenyl Ethers (PBDE)
Circuit Board	×	○	○	○	○	○
Electronic Parts	×	○	○	○	○	○
Brass Screw	×	○	○	○	○	○
Aluminum Die Casting	×	○	○	○	○	○

This table has been prepared in accordance with the provisions outlined in SJ/T 11364.  
 ○: Indicates that said hazardous substance contained in all of the homogeneous materials for this part is below or equal to the limit requirement of GB/T 26572.  
 ×: Indicates that said hazardous substance contained in at least one of the homogeneous materials used for this part is above the limit requirement of GB/T 26572.

**Note:**  
 This product complies with EU RoHS directives. In this table, "×" indicates that hazardous substances that are exempt from EU RoHS directives are contained.

## 16 对应中国RoHS指令



图 16.1 中国RoHS标志

中国RoHS标志依据2016年1月26日公布的《电器电子产品有害物质限制使用管理办法》，以及《电子电气产品有害物质限制使用标识要求》（SJ/T 11364-2014）作成。电子电气产品中特定6种有害物质的含量超过规定值时，应标识此标志。中间的数字为在中国生产销售以及进口的电子电气产品的环保使用期限（年限）。电子电气产品的环保使用期限从生产日期算起。在期限内，正常使用产品的过程中，不会有特定的6种有害物质外泄进而对环境、人和财产造成深刻影响。

本产品的环保使用期限为15年。但需要注意的是环保使用期限并非产品的质量保证期限。

## ◆ 本产品中含有有害物质的信息

本产品中所含有害物质的详细信息如表 16.1 所示。

表 16.1 本产品中有害物质的名称及含量

部件名称	有害物质					
	铅 (Pb)	汞 (Hg)	镉 (Cd)	六价铬 (Cr(VI))	多溴联苯 (PBB)	多溴二苯醚 (PBDE)
实装基板	×	○	○	○	○	○
电子元件	×	○	○	○	○	○
黄铜螺钉	×	○	○	○	○	○
铝压铸	×	○	○	○	○	○

本表格依据SJ/T 11364的规定编制。  
 ○:表示该有害物质在该部件所有均质材料中的含量均在GB/T 26572规定的限量要求以下。  
 ×:表示该有害物质至少在该部件的某一均质材料中的含量超出GB/T 26572规定的限量要求。  
 (注) 本产品符合欧盟RoHS指令。上表中的“×”表示含有欧盟RoHS指令豁免的有害物质。

## 17 Safe Disable Input



Figure 17.1 TUV Mark

The TUV mark identifies that the product complies with the safety standards.

This section gives precautions to support the Safe Disable input. Contact Yaskawa for more information.

The safety function complies with the standards shown in Table 17.1.

Table 17.1 Applied Safety Standards and Unified Standards

Safety Standards	Unified Standards
Functional Safety	<ul style="list-style-type: none"> <li>IEC 61800-5-2:2016</li> <li>EN 61800-5-2:2017</li> <li>IEC 61508-1:2010 (SIL3)</li> <li>IEC 61508-2:2010 (SIL3)</li> <li>EN 61508-1:2010 (SIL3)</li> <li>EN 61508-2:2010 (SIL3)</li> <li>EN 62061:2005/A2:2015 (SIL CL3)</li> <li>IEC 62061:2005</li> <li>IEC 62061:2005/AMD1:2012</li> <li>IEC 62061:2005/AMD2:2015</li> </ul>
Machine Safety	<ul style="list-style-type: none"> <li>ISO 13849-1:2015</li> <li>EN ISO 13849-1:2015 (Cat. 3, PL e)</li> </ul>
EMC	<ul style="list-style-type: none"> <li>IEC 61326-3-1:2017</li> <li>EN 61326-3-1:2017</li> <li>IEC 61000-6-7:2014</li> <li>EN 61000-6-7:2015</li> </ul>
LVD	<ul style="list-style-type: none"> <li>IEC 61800-5-1:2007</li> <li>IEC 61800-5-1:2007/AMD1:2016</li> <li>EN 61800-5-1:2007/A1:2017</li> </ul>

**Note:**

SIL = Safety Integrity Level.

## ◆ Safe Disable Specifications

The Safe Disable input provides the stop function that complies with “Safe Torque Off” as specified by IEC/EN 61800-5-2. The Safe Disable input meets the requirements of EN ISO 13849-1 and IEC/EN 61508. It also has a safety status monitor to detect safety circuit errors.

When you install the drive as a component in a system, you must make sure that the system complies with the applicable safety standards.

Refer to [Table 17.2](#) for safety function specifications.

**Table 17.2 Safe Disable Specifications**

Item	Description
Input/Output	<ul style="list-style-type: none"> <li>Input: 2 Safe Disable input (H1, H2) Signal ON level: 18 Vdc to 28 Vdc Signal OFF level: -4 Vdc to +4 Vdc</li> <li>Output: 1 MFDO safety monitor output for external device monitor (EDM)</li> </ul>
Response time from when the input opens to when the drive output stops	3 ms or less
Response time from when the H1 and H2 terminal inputs open to when the EDM signal operates	20 ms or less
Failure probability	Less frequent operation request mode
	Frequent operation request mode or continuous mode
Performance level	The Safe Disable input complies with the performance level requirements of EN ISO 13849-1.
HFT (hardware fault tolerance)	N = 1
Type of subsystem	Type B

**Note:**

EDM = External Device Monitoring

PFH = Probability of Failure on Demand

PFH = Probability of Dangerous Failure per Hour

## ◆ Notes

**⚠ DANGER** *Sudden Movement Hazard. When you use the Safe Disable function in the safety system of a machine, do a full risk assessment for the system to make sure that all parts of the system comply with applicable safety standards. Incorrect application of the Safe Disable function can cause serious injury or death.*

**⚠ DANGER** *Sudden Movement Hazard. If the output circuit of the drive is damaged and the Safe Disable function turns OFF the drive output to a permanent magnet (PM) motor, the motor can rotate 180 electrical degrees. Prevent damage to equipment and injury to personnel during this condition. Sudden motor movement can cause serious injury or death. It is possible for current to flow through the motor winding in these conditions.*

**⚠ DANGER** *Electrical Shock Hazard. You cannot depend on the Safe Disable function to prevent electrical shock. Disconnect all power to the drive and wait for the time specified on the warning label before you remove covers. Check the drive for dangerous voltages before servicing or repair work. If you do work on the drive when it is energized and there is no cover over the electronic circuits, it can cause serious injury or death.*

**⚠ WARNING** *Sudden Movement Hazard. Although the Safe Disable function is in operation, gravity or other external forces in the vertical axis can move the motor. Incorrect application of the Safe Disable function can cause serious injury or death.*

**⚠ WARNING** *Sudden Movement Hazard. Do not use the drive output signals to control external holding brakes or dynamic brakes for functional safety. Use a system that conforms to the functional safety requirements. Incorrect application of the Safe Disable function can cause serious injury or death. Systems that use drive output signals (including EDM) for safety are not safe because drive output signals are not safety components.*

**⚠ WARNING** *Sudden Movement Hazard. Connect the Safe Disable inputs to the devices as specified by the safety requirements. If you connect the Safe Disable inputs incorrectly, it can cause serious injury or death.*

**⚠ WARNING** *Sudden Movement Hazard. To use the Safe Disable inputs, remove the jumpers between terminals H1-HC and H2-HC. If the Safe Disable circuit does not work correctly, it can cause serious injury or death.*

**⚠ WARNING** Sudden Movement Hazard. When you clear the Safe Disable input, make sure that the Safe Disable Monitor output operates correctly as the specification for Safe Disable function. If the Safe Disable circuit does not operate correctly, it can cause serious injury or death.

**⚠ WARNING** Sudden Movement Hazard. Regularly examine the Safe Disable input and all other safety features. A system that does not operate correctly can cause serious injury or death.

**⚠ WARNING** Sudden Movement Hazard. Only let approved personnel who know about the drive, instruction manual, and safety standards wire, examine, and maintain the Safe Disable input. If personnel are not approved, it can cause serious injury or death.

**⚠ WARNING** Sudden Movement Hazard. Only use the Safe Disable Monitor (multi-function output terminal set to the EDM function) to monitor the Safe Disable status or to find a malfunction in the Safe Disable inputs. The monitor output is not a safety output. If you use the Safe Disable Monitor incorrectly, it can cause death or serious injury.

**Note:**

- Drives that have a built-in safety function must be replaced 10 years after first use.
- A maximum of 3 ms will elapse from when terminals H1 or H2 shut off until the drive switches to the “Safe Torque Off” status. Set the OFF status for terminals H1 and H2 to hold for at least 3 ms. The drive may not be able to switch to the “Safe Torque Off” status if terminals H1 and H2 are only open for less than 2 ms.

## ◆ Using the Safe Disable Function

### ■ Safe Disable Circuit

The Safe Disable circuit has two isolated channels (terminals H1 and H2) that stop the output transistors. The input can use the internal power supply of the drive.

Set the EDM function to one of the MFDO terminals [ $H2-xx = 21$  or  $121$ ] to monitor the status of the Safe Disable function. This is the “Safe Disable monitor output function”.

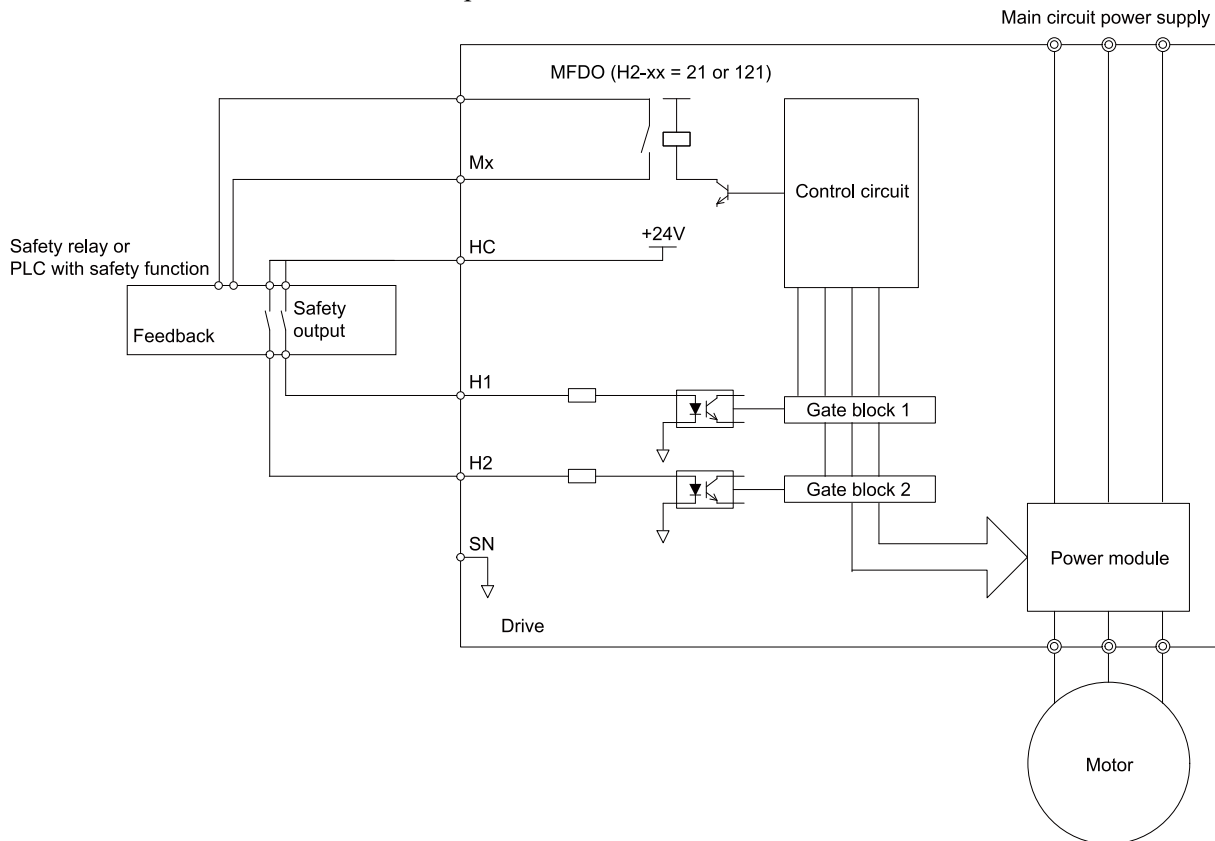

Figure 17.2 Safe Disable Function Wiring Example

### ■ Enabling and Disabling the Drive Output (“Safe Torque Off”)

Refer to [Figure 17.3](#) for an example of drive operation when the drive changes from “Safe Torque Off” status to usual operation.

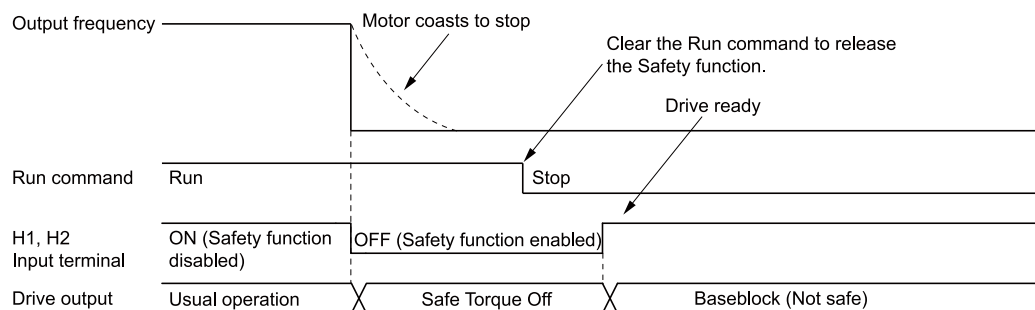

Figure 17.3 Safe Disable Operation

### Switching from Usual Operation to “Safe Torque Off”

Turn OFF (open) safety input terminal H1 or H2 to enable the Safe Disable function. When the Safe Disable function is enabled while the motor is operating, the drive output and motor torque turn off and the motor always coasts to stop. The *b1-03 [Stopping Method Selection]* setting does not have an effect on the stopping method.

The “Safe Torque Off” status is only possible with the Safe Disable function. Clear the Run command to stop the drive. Turning off drive output (a baseblock condition) ≠ “Safe Torque Off”.

**Note:**

- When it is necessary to ramp to stop the motor, do not turn off terminals H1 and H2 until the motor fully stops. This will prevent the motor from coasting to stop during usual operation.
- A maximum of 3 ms will elapse from when terminals H1 or H2 shut off until the drive switches to the “Safe Torque Off” status. Set the OFF status for terminals H1 and H2 to hold for at least 2 ms. The drive may not be able to switch to the “Safe Torque Off” status if terminals H1 and H2 are only open for less than 2 ms.

### Going from “Safe Torque Off” to Usual Operation

The safety input will only release when there is no Run command.

- **During Stop**  
When the Safe Disable function is triggered during stop, close the circuit between terminals H1-HC and H2-HC to disable “Safe Torque Off”. Enter the Run command after the drive stops correctly.
- **During Run**  
When the Safe Disable function is triggered during run, close the circuit between terminals H1-HC and H2-HC to disable “Safe Torque Off” after clearing the Run command. Enter the Stop command, then enter the Run command when terminals H1 and H2 are ON or OFF.

## ■ Safe Disable Monitor Output Function and Keypad Display

Refer to [Table 17.3](#) for information about the relation between the input channel status, Safety monitor output status, and drive output status.

Table 17.3 Safe Disable Input and External Device Monitor (EDM) Terminal Status

Input Channel Status	Input 1 (H1-HC)	ON (Close the circuit)	OFF (Open)	ON (Close the circuit)	OFF (Open)
	Input 2 (H2-HC)	ON (Close the circuit)	ON (Close the circuit)	OFF (Open)	OFF (Open)
MFDO Terminal (H2-xx = 21)	MFDO Terminal (H2-xx = 21)	OFF	OFF	OFF	ON
	MFDO Terminal (H2-xx = 121)	ON	ON	ON	OFF
Drive Output Status		Baseblock (Drive ready)	Safety status (STo)	Safety status (STo)	Safety status (STo)
Keypad Display		Normally displayed	SToF (Flashing)	SToF (Flashing)	STo (Flashing)
LED Status Ring		Ready: Illuminated	ALM/ERR: Flashing	ALM/ERR: Flashing	Ready: Flashing
MEMOBUS Register 0020 (Hex.)		bit C: 0 bit D: 0	bit C: 1 bit D: 0	bit C: 1 bit D: 0	bit C: 0 bit D: 1

### Safety Function Status Monitor

The drive Safety monitor output sends a feedback signal about the status of the Safety function. The Safety monitor output is one of the possible settings available for the MFDO terminals. If there is damage to the Safe Disable circuit, a controller (PLC or safety relay) must read this signal as an input signal to hold the “Safe Torque Off” status. This

will help verify the condition of the safety circuit. Refer to the manual for the safety device for more information about the Safety function.

You can use the MFDO function settings to switch the polarity of the Safety monitor output signal. Refer to [Table 17.3](#) for setting instructions.

**Keypad Display**

If the two input channels are OFF (Open), the keypad will flash *STo* [Safe Torque OFF].

If there is damage to the Safe disable circuit or the drive, the keypad will flash *SToF* [Safe Torque OFF Hardware] when one input channel is OFF (Open) and the other is ON (Close the circuit). When you use the Safe disable circuit correctly, the keypad will not show *SToF*.

If there is damage to the drive, the keypad will show *SCF* [Safety Circuit Fault] when the drive detects a fault in the Safe disable circuit. Refer to the chapter on Troubleshooting for more information.

■ **Validating the Safe Disable Function**

After you replace parts or do maintenance on the drive, first complete all necessary wiring to start the drive, then test the Safe Disable input with these steps. Keep a record of the test results.

1. When the two input channels are OFF (Open), make sure that the keypad flashes *STo* [Safe Torque OFF], and make sure that the motor is not running.
2. Monitor the ON/OFF status of the input channels and make sure that MFDO set to the EDM function operates as shown in [Table 17.3](#).

If one or more of these items are true, the ON/OFF status of the MFDO may not display correctly on the keypad:

- Incorrect parameter settings.
- A problem with an external device.
- The external wiring has a short circuit or is disconnected.
- There is damage to the device.

Find the cause and repair the problem to correctly display the status.

3. Make sure that the EDM signal operates during usual operation as shown in [Table 17.3](#).

**18 Seismic Standards**

The Yaskawa drives in this manual are capable of structurally and operationally withstanding the seismic response criteria as defined in the International Building Code (IBC), ASCE7, and California Department of Health Care Access and Information (HCAI).

The models in this manual were tested in compliance with AC-156 to meet the IBC seismic certification as shown on the certification labels.

Refer to the Technical Reference (SIEPC7106171F) for seismic installation instructions.



Figure 18.1 Seismic Certification Label Example for Drives



## 19 Disposal Instructions

Correctly discard the drive, packing material, battery, and microSD card as specified by regional, local, and municipal laws and regulations for this product.

**Note:**

- Remove the battery and microSD card from the keypad before you discard the drive.
- You cannot recycle the battery. Discard used batteries as specified by the battery manufacturer.
- Customers are responsible for microSD card data protection.  
PC functions that format and delete the data may not be sufficient to fully erase the microSD card data. Yaskawa recommends that customers physically destroy the microSD card in a shredder or use data wipe software to fully erase the card.

### ◆ WEEE Directive

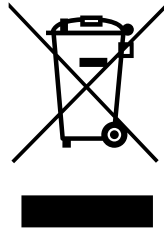

The wheeled bin symbol on this product, its manual, or its packaging identifies that you must recycle it at the end of its product life.

You must discard the product at an applicable collection point for electrical and electronic equipment (EEE). Do not discard the product with usual waste.

## 20 Maintenance

Refer to the Maintenance & Troubleshooting Manual (TOEPYAIFP601) for more information.

Only let authorized persons do maintenance, examine, or replace components on the drive.

Read this manual carefully and know all the precautions and safety information before installing, wiring, repairing, or examining the drive or replacing components.

Examine and maintain the drive and peripheral devices regularly to extend the life of the drive and decrease performance deterioration, decrease early wear, and decrease drive failures.

Regular examinations and maintenance will also decrease system downtime.

Refer to the Technical Reference (SIEPC7106171F) for more information about maintenance and examinations.

Examine the drive one time each year at a minimum.

The operating conditions, environmental conditions, and use conditions will have an effect on the examination frequency for connected equipment.

Examine the drive more frequently if you use the drive in bad conditions or in these conditions:

- High ambient temperatures
- Frequent starting and stopping
- Changes in the AC power supply or load
- Too much vibration or shock loading
- Dust, metal dust, salt, sulfuric acid, or chlorine atmospheres
- Unsatisfactory storage conditions.

The drive has Maintenance Monitors that monitor component wear and give warnings when the performance life estimate is approaching. When you use the maintenance monitors, you remove the need to shut down all system components when you have problems. Refer to these monitors:

- U4-04 [Cool Fan Maintenance]
- U4-05 [Capacitor Maintenance]
- U4-07 [IGBT Maintenance]



You can set alarm notifications to inform you about the maintenance periods for specific drive components. Refer to these Maintenance setting parameters:

- o4-04 [Fan Maintenance Time]
- o4-05 [Capacitor Maintenance Setting]
- o4-07 [Softcharge Relay Maintenance Set]
- o4-09 [IGBT Maintenance Setting]
- o4-10 [IGBT Maintenance Time]

## 21 Troubleshooting

Refer to the Maintenance & Troubleshooting Manual (TOEPYAIFP601) for more information.



If the drive or motor do not operate correctly, look at the drive keypad for fault and alarm information.

- For drive faults:
  - The keypad shows the fault code.
  - When o2-24 = 0 or 1 [LED Light Function Selection = Enable Status Ring & Keypad LED or LED Status Ring Disable],  and ALM/ERR on the LED Status Ring illuminate continuously.
  - The drive shuts off output and the fault relay output activates. The motor coasts to stop.
- For drive alarms:
  - The keypad shows the alarm code.
  - When o2-24 = 0 or 1,  and ALM/ERR on the LED Status Ring flash.
  - Usually, the drive will continue to operate the motor. Some alarms let you select a motor stopping method.

**Note:**

If there is no information on the display when you energize the keypad, there can be a connection error. Remove the keypad and connect it again to make sure that you correctly connected the connection cable between the drive and the keypad.

### ◆ Fault Reset

1. Remove the cause of the fault or alarm.
2. While the keypad is showing the fault or alarm code, push  (RESET) or  on the keypad.

### ◆ Fault

This section gives information about some of the causes and possible solutions of faults. You must use the Fault Reset operation to remove the fault before you can operate the drive. Use the information in this table to remove the cause of the fault.

Code	Name	Causes	Possible Solutions
AUXFB	PI Aux Feedback Level Loss	The analog input from the terminal set for <i>PI Auxiliary Control Feedback Level</i> [H3-xx = 27] is more than 21 mA or less than 3 mA for longer than 1 s.	Repair transducer or wiring.
bAT	Keypad Battery Low Voltage	The keypad battery voltage is low.	Replace the keypad battery.
bCE	Bluetooth Communication Fault	The smartphone or tablet with DriveWizard Mobile installed is too far from the keypad.	Use the smartphone or tablet 10 m (32.8 ft) or nearer to the keypad. <b>Note:</b> <i>bCE</i> can occur when the smartphone or tablet is 10 m (32.8 ft) or nearer to the keypad depending on the specifications of the smartphone or tablet.
		Radio waves from a different device are causing interference with communications between the smartphone or tablet and keypad.	Make sure that no device around the keypad uses the same radio bandwidth (2400 MHz to 2480 MHz), and prevent radio interference.
bUS	Option Communication Error	The drive did not receive a signal from the controller.	Correct wiring errors.
CE	Modbus Communication Error	The communications cable wiring is incorrect.	Correct wiring errors.

Code	Name	Causes	Possible Solutions
CoF	Current Offset Fault	The drive starts operation while the induced voltage stays in the motor (during coasting to a stop or after fast deceleration).	<ul style="list-style-type: none"> <li>Make a sequence that does not restart operation when induced voltage stays in the motor.</li> <li>Set <math>b3-01 = 1</math> [<i>Speed Search at Start Selection = Enabled</i>].</li> <li>Use <i>Speed Search from Fmax or Fref</i> [<math>H1-xx = 61, 62</math>] to do a speed search through one of the external terminals.</li> </ul> <p><b>Note:</b> When controlling the PM motor, External Speed Search commands 1 and 2 operate the same.</p>
CPF00 to CPF03, CPF07 to CPF08, CPF11 to CPF14, CPF16 to CPF24, and CPF26 to CPF39	Control Circuit Error	A drive hardware problem occurred.	<ul style="list-style-type: none"> <li>Re-energize the drive.</li> <li>If the fault stays, replace the control board or the drive. For information about replacing the control board, contact Yaskawa or your nearest sales representative.</li> </ul>
CPF06	Control Circuit Error (EEPROM memory Data Error)	The drive power supply was de-energized while a communication option entered a parameter Write command.	Set $A1-03 = 2220, 3330$ [ <i>Initialize Parameters = 2-Wire Initialization, 3-Wire Initialization</i> ] and initialize the drive.
dEv	Speed Deviation	The load is too heavy.	Decrease the load.
DIFF	Differential Feedback Exceeded	The difference between the PID Feedback and <i>Differential Level Source</i> [ $H3-xx = 2D$ ] is more than the level set in $Y4-18$ [ <i>Differential Level</i> ] for the time set in $Y4-19$ [ <i>Differential Lvl Detection Time</i> ].	<ul style="list-style-type: none"> <li>Replace the feedback transducer or transducers.</li> <li>Make sure that the settings of <math>Y4-18</math> [<i>Differential Level</i>] to <math>Y4-20</math> [<i>Differential Level Detection Sel</i>] are correct.</li> </ul>
dv7	Polarity Judge Timeout	There is a disconnection in the motor coil winding.	Measure the motor line-to-line resistance and replace the motor if a coil is disconnected.
EF0	Option Card External Fault	The communication option received an external fault from the controller.	<ol style="list-style-type: none"> <li>Find the device that caused the external fault and remove the cause.</li> <li>Clear the external fault input from the controller.</li> </ol>
EF1 to EF8	External Fault (Terminal Sx)	MFDI terminal Sx caused an external fault through an external device.	<ol style="list-style-type: none"> <li>Find the device that caused the external fault and remove the cause.</li> <li>Clear the external fault input in the MFDI.</li> </ol>
		The wiring is incorrect.	Correctly connect the signal line to MFDI terminal Sx.
		<i>External Fault</i> [ $H1-01 = 20$ to $2B$ ] is set to MFDI terminal Sx, but the terminal is not in use.	Correctly set the MFDI.
Err	EEPROM Write Error	There was a problem with the EEPROM hardware.	<ul style="list-style-type: none"> <li>Re-energize the drive.</li> <li>If the fault stays, replace the control board or the drive. Contact Yaskawa or your nearest sales representative to replace the board.</li> </ul>
FAn1	Drive Cooling Fan Fault	The cooling fan stopped operating correctly.	<ul style="list-style-type: none"> <li>Examine cooling fan operation.</li> <li>Re-energize the drive.</li> <li>Examine <math>U4-03</math> [<i>Cooling Fan Ope Time</i>] and <math>U4-04</math> [<i>Cool Fan Maintenance</i>]. If the performance life of the cooling fan is expired or if there is damage to the fan, replace the fan.</li> </ul>
FDBKL	WIRE Break	<p>The analog input from the terminal set for <i>PID Feedback</i> [<math>H3-xx = B</math>] is more than 21mA or less than 3mA for longer than 1 s in these conditions:</p> <ul style="list-style-type: none"> <li><math>b5-82 = 2</math> [<i>Feedback Loss 4 ~ 20mA Detect Sel = Fault</i>]</li> <li><math>b5-01 \neq 0</math> [<i>PID Mode Setting <math>\neq</math> Disabled</i>]</li> <li><math>H3-01, H3-09, \text{ or } H3-05 = 2</math> [<i>Terminal A1/A2/A3 Signal Level Selection = 4 to 20 mA</i>]</li> </ul>	Make sure that you install the PID feedback source and it operates correctly.
GF	Ground Fault	Overheating caused damage to the motor or the motor insulation is not satisfactory.	Measure the motor insulation resistance, and replace the motor if there is electrical conduction or unserviceable insulation.
		The motor main circuit cable is contacting ground to make a short circuit.	<ul style="list-style-type: none"> <li>Examine the motor main circuit cable for damage, and repair short circuits.</li> <li>Measure the resistance between the motor main circuit cable and the ground terminal. If there is electrical conduction, replace the cable.</li> </ul>
		An increase in the stray capacitance of the cable and the ground terminal caused an increase in the leakage current.	<ul style="list-style-type: none"> <li>If the wiring length of the cable is more than 100 m, decrease the carrier frequency.</li> <li>Decrease the stray capacitance.</li> </ul>
		There was a problem with the drive hardware.	Replace the control board or the drive. For information about replacing the control board, contact Yaskawa or your nearest sales representative.
HFB	High Feedback Sensed	The feedback level is more than the level set in $Y1-11$ [ <i>High Feedback Level</i> ] for the time set in $Y1-12$ [ <i>High Feedback Lvl Fault Dly Time</i> ].	<ul style="list-style-type: none"> <li>Decrease the feedback level less than <math>Y1-11</math>.</li> <li>Set <math>Y1-11</math> and <math>Y1-12</math> correctly.</li> </ul>

Code	Name	Causes	Possible Solutions
HIAUX	High PI Aux Feedback Level	PI Auxiliary Feedback is more than the level set in <i>YF-12 [PI Aux Control High Level Detect]</i> for the time set in <i>YF-13 [PI Aux High Level Detection Time]</i> in these conditions: <ul style="list-style-type: none"> <li>The drive is running.</li> <li>The output frequency &gt; 0.</li> </ul>	<ul style="list-style-type: none"> <li>Decrease the PI Auxiliary Feedback level less than <i>YF-12</i>.</li> <li>Set <i>YF-12</i> and <i>YF-13</i> correctly.</li> </ul>
HLCE	High Level Communication Errors	Communication data error occurred between the option and the master drive when you use Gateway function. The master drive detects <i>oF:xxx</i> and the slave drive detects <i>HLCE</i> .	Examine the wiring between the option and the master drive and remove the cause of the fault.
HWL	High Water Level	<ul style="list-style-type: none"> <li>The digital input terminal set to <i>H1-xx = BC [MFDI Function Selection = High Water Level]</i> activated or is defective.</li> <li>The digital input terminal set to <i>H1-xx = IBC [High Water Level]</i> deactivated or is defective.</li> </ul>	<ul style="list-style-type: none"> <li>Decrease the water level.</li> <li>Adjust the terminal set to <i>H1-xx = BC</i> or <i>IBC</i>.</li> </ul>
LF	Output Phase Loss	The motor main circuit cable is disconnected.	Connect motor main circuit cable wiring. Correct wiring errors in the main circuit drive input power.
LF2	Output Current Imbalance	Phase loss occurred in the wiring on the output side of the drive.	Examine for wiring errors or disconnected wires on the output side of the drive, and repair problems.
LFB	Low Feedback Sensed	The feedback level is less than the level set in <i>Y1-08 [Low Feedback Level]</i> for the time set in <i>Y1-09 [Low Feedback Lvl Fault Dly Time]</i> .	<ul style="list-style-type: none"> <li>Increase the feedback level to more than <i>Y1-08</i>.</li> <li>Set <i>Y1-08</i> and <i>Y1-09</i> correctly.</li> </ul>
LOAUX	Low PI Aux Feedback Level	When the drive is running, PI Auxiliary Feedback is less than the level set in <i>YF-09 [PI Aux Control Low Lvl Detection]</i> for the time set in <i>YF-10 [PI Aux Control Low Lvl Det Time]</i> .	<ul style="list-style-type: none"> <li>Increase the PI Auxiliary Feedback level to be more than <i>YF-09</i>.</li> <li>Set <i>YF-09</i> and <i>YF-10</i> correctly.</li> </ul>
LOP	Loss of Prime	The drive used the <i>Y1-18 [Prime Loss Detection Method]</i> setting and measured a pump load that is less than the level set in <i>Y1-19 [Prime Loss Level]</i> for the time set in <i>Y1-20 [Prime Loss Time]</i> , and the output frequency is <i>Y1-21 [Prime Loss Activation Freq]</i> or more.	<ul style="list-style-type: none"> <li>Examine for a dry well, air in the system, or no water in the system. Use preferred priming method suggested by the pump manufacturer to restart the pump.</li> <li>When there is resistance in the pump, let the system pump water again.</li> <li>Set <i>Y1-18</i> to <i>Y1-21</i> correctly.</li> </ul>
LWL	Low Water Level	<ul style="list-style-type: none"> <li>The digital input terminal set to <i>H1-xx = BB [MFDI Function Selection = Low Water Level]</i> activated or is defective.</li> <li>The digital input terminal set to <i>H1-xx = IBB [Low Water Level]</i> deactivated or is defective.</li> </ul>	<ul style="list-style-type: none"> <li>Increase the water level.</li> <li>Adjust the terminal set to <i>H1-xx = BB</i> or <i>IBB</i>.</li> </ul>
NMS	Setpoint Not Met	The feedback deviates from the setpoint at a level more than <i>Y1-15 [Maximum Setpoint Difference]</i> for the time set in <i>Y1-16 [Not Maintaining Setpoint Time]</i> .	<ul style="list-style-type: none"> <li>Examine for a blocked impeller, over cycling, or broken pipe.</li> <li>Set <i>Y1-15</i> and <i>Y1-16</i> correctly.</li> </ul>
nSE	Node Setup Error	The drive received a Run command while the Node Setup function was active.	Stop the drive when the Node Setup function is in use.
oC	Overcurrent	The load is too large.	<ul style="list-style-type: none"> <li>Measure the current flowing into the motor.</li> <li>Replace the drive with a larger capacity model if the current value is more than the drive rated current.</li> <li>Decrease the load or replace with a larger drive to prevent sudden changes in the current level.</li> </ul>
		Overheating caused damage to the motor or the motor insulation is not satisfactory.	Measure the motor insulation resistance, and replace the motor if there is electrical conduction or unserviceable insulation.
		The motor main circuit cable is contacting ground to make a short circuit.	<ul style="list-style-type: none"> <li>Examine the motor main circuit cable for damage, and repair short circuits.</li> <li>Measure the resistance between the motor main circuit cable and the ground terminal. If there is electrical conduction, replace the cable.</li> </ul>
		A short circuit or ground fault on the drive output side caused damage to the output transistor of the drive.	<ul style="list-style-type: none"> <li>Make sure that there is not a short circuit in terminals - and terminals U/T1, V/T2, and W/T3.</li> <li>If there is a short circuit, contact Yaskawa or your nearest sales representative.</li> </ul>
		The acceleration time is too short.	<ul style="list-style-type: none"> <li>Calculate the torque necessary during acceleration related to the load inertia and the specified acceleration time.</li> <li>Increase the values set in <i>C1-01</i> or <i>C1-03 [Acceleration Times]</i> to get the necessary torque.</li> <li>Increase the values set in <i>C2-01</i> to <i>C2-04 [S-Curve Characteristics]</i> to get the necessary torque.</li> <li>Replace the drive with a larger capacity model.</li> </ul>
		The drive is trying to operate a specialized motor or a motor that is larger than the maximum applicable motor output of the drive.	<ul style="list-style-type: none"> <li>Examine the motor nameplate, the motor, and the drive to make sure that the drive rated current is larger than the motor rated current.</li> <li>Replace the drive with a larger capacity model.</li> </ul>

Code	Name	Causes	Possible Solutions
		A magnetic contactor was switched at the output.	Set the operation sequence to not turn ON or OFF the magnetic contactor while the drive is outputting voltage.
		The V/f pattern settings are incorrect.	<ul style="list-style-type: none"> <li>Examine the ratios between the V/f pattern frequency and voltage. Decrease the voltage if it is too high compared to the frequency.</li> <li>Adjust <i>E1-04 to E1-10 [V/f Pattern Parameters]</i>. For motor 2, adjust <i>E3-04 to E3-10</i>.</li> </ul>
		The torque compensation gain is too large.	Decrease the value set in <i>C4-01 [Torque Compensation Gain]</i> to make sure that the motor does not stall.
		Electrical interference caused a problem.	Examine the control circuit lines, main circuit lines, and ground wiring, and decrease the effects of electrical interference.
		The gain during overexcitation operation is too large.	<ul style="list-style-type: none"> <li>Find the time when the fault occurs.</li> <li>If the fault occurs at the same time as overexcitation operation, decrease the value set in <i>n3-13 [OverexcitationBraking (OEB) Gain]</i> and consider the motor flux saturation.</li> </ul>
		The drive received a Run command while the motor was coasting.	<ul style="list-style-type: none"> <li>Examine the sequence and input the Run command after the motor fully stops.</li> <li>Set <i>b3-01 = 1 [Speed Search at Start Selection = Enabled]</i> or set <i>H1-xx = 61, 62 [Speed Search from Fmax or Fref]</i> to input speed search commands from the MFDI terminals.</li> </ul>
		The motor code setting is incorrect for PM Control Methods.	<ul style="list-style-type: none"> <li>Enter the correct motor code to <i>E5-01 [PM Motor Code Selection]</i> as specified by the PM motor.</li> <li>For specialized motors, refer to the motor test report and set <i>E5-xx [PM Motor Settings]</i> correctly.</li> </ul>
		The current flowing in the motor is more than the value set in <i>L8-27 [Overcurrent Detection Gain]</i> for PM Control Methods.	Correct the value set in <i>L8-27</i> .
		The control method is set incorrectly for the motor.	Set <i>A1-02 [Control Method Selection]</i> correctly.
		The motor main circuit cable is too long.	Replace the drive with a larger capacity model.
		Speed search does not complete at start when <i>A1-02 = 8 [EZ Vector Control]</i> and you use an induction motor.	When <i>E9-01 = 0 [Motor Type Selection = Induction (IM)]</i> , set <i>b3-24 = 2 [Speed Search Method Selection = Current Detection Speed Search]</i> .
		The relay or contactor on the soft-charge bypass relay is damaged.	<ul style="list-style-type: none"> <li>Re-energize the drive.</li> <li>If the fault stays, replace the control board or the drive.</li> </ul>
		An overcurrent condition occurred during overexcitation deceleration.	<ul style="list-style-type: none"> <li>Decrease the value set in <i>n3-13 [OverexcitationBraking (OEB) Gain]</i>.</li> <li>Decrease the value set in <i>n3-21 [HSB Current Suppression Level]</i>.</li> </ul>
		You are using a premium efficiency motor.	Set these parameters: <ul style="list-style-type: none"> <li><i>b3-03 [Speed Search Deceleration Time]</i> = default value × 2</li> <li><i>L2-03 [Minimum Baseblock Time]</i> = default value × 2</li> <li><i>L2-04 [Powerloss V/f Recovery Ramp Time]</i> = default value × 2</li> </ul>
OD	Output Disconnect	The output circuit between the drive and the motor is open, and the drive output current is less than 5% of <i>E2-01 [Motor Rated Current (FLA)]</i> .	Close the disconnected output circuit between the drive and the motor.
oFA00	Option Not Compatible with Port	The option connected to connector CN5-A is not compatible.	Connect the option to the correct connector.
		<ul style="list-style-type: none"> <li>The DIP switches on the JOHB-SMP3 Multi-Protocol Ethernet Card are at factory default settings.</li> <li>The DIP switches on the JOHB-SMP3 are not set to a valid protocol.</li> <li>The DIP switches on the JOHB-SMP3 are set to a valid protocol that is not supported by the drive.</li> </ul>	Remove power from the drive, wait for the charge light to go out, then set the DIP switches on the JOHB-SMP3 to the desired protocol. <b>Note:</b> If you connect a JOHB-SMP3 to drives with software versions PRG: 01011 and earlier, the drives detect oFA00 [Option Not Compatible with Port]. The "PRG" column on the nameplate on the right side of the drive identifies the software version. You can also use <i>U1-25 [SoftwareNumber FLASH]</i> to identify the software version.
		The option failed. Check the LED flash pattern on the option as specified by the option manual.	Replace the option.
oFA01	Option Fault/Connection Error	The option card connected to connector CN5-A is not compatible.	<ol style="list-style-type: none"> <li>De-energize the drive.</li> <li>Refer to the option card manual and correctly connect the option card to the connector on the drive.</li> </ol>
oFA02	Duplicate Options	The same option cards or the same type of option cards are connected to connectors CN5-A and B.	Connect the option card to the correct connector.

Code	Name	Causes	Possible Solutions
oFA03 to oFA06	Option Card Error Occurred at Option Port CN5-A	A fault occurred in the option card.	<ol style="list-style-type: none"> <li>De-energize the drive.</li> <li>Make sure that the option card is correctly connected to the connector.</li> <li>If the problem continues, replace the option card.</li> </ol>
oFA10, oFA11	Option Card Error Occurred at Option Port CN5-A	A fault occurred in the option card.	<ol style="list-style-type: none"> <li>De-energize the drive.</li> <li>Make sure that the option card is correctly connected to the connector.</li> <li>If the problem continues, replace the option card.</li> </ol>
oFA12 to oFA17	Option Card Connection Error (CN5-A)	A fault occurred in the option card.	<ol style="list-style-type: none"> <li>De-energize the drive.</li> <li>Make sure that the option card is correctly connected to the connector.</li> <li>If the problem continues, replace the option card.</li> </ol>
oFA30 to oFA43	Communication Option Card Connection Error (CN5-A)	A fault occurred in the option card.	<ol style="list-style-type: none"> <li>De-energize the drive.</li> <li>Make sure that the option card is correctly connected to the connector.</li> <li>If the problem continues, replace the option card.</li> </ol>
oFb00	Option Not Compatible with Port	The option connected to connector CN5-B is not compatible.	<p>Connect the option to the correct connector.</p> <p><b>Note:</b> The communication options cannot connect to connector CN5-B.</p>
oFb01	Option Fault/Connection Error	The option card connected to connector CN5-B was changed during operation.	<ol style="list-style-type: none"> <li>De-energize the drive.</li> <li>Refer to the option card manual and correctly connect the option card to the connector on the drive.</li> </ol>
oFb02	Duplicate Options	The same option cards or the same type of option cards are connected to connectors CN5-A and B.	Connect the option card to the correct connector.
oFb03 to oFb11	Option Card Error Occurred at Option Port CN5-B	A fault occurred in the option card.	<ol style="list-style-type: none"> <li>De-energize the drive.</li> <li>Make sure that the option card is correctly connected to the connector.</li> <li>If the problem continues, replace the option card.</li> </ol>
oFb12 to oFb17	Option Card Error Occurred at Option Port CN5-B	A fault occurred in the option card.	<ol style="list-style-type: none"> <li>De-energize the drive.</li> <li>Make sure that the option card is correctly connected to the connector.</li> <li>If the problem continues, replace the option card.</li> </ol>
oH	Heatsink Overheat	The ambient temperature is high and the heatsink temperature of the drive is more than the value set in L8-02 [Overheat Alarm Level].	<ul style="list-style-type: none"> <li>Measure the ambient temperature.</li> <li>Increase the airflow in the control panel.</li> <li>Install a cooling device (cooling fan or air conditioner) to lower the ambient temperature.</li> <li>Remove objects near the drive that are producing too much heat.</li> </ul>
oH1	Heatsink Overheat	The ambient temperature is high and the heatsink temperature of the drive is more than the oH1 detection level.	<ul style="list-style-type: none"> <li>Measure the ambient temperature.</li> <li>Increase the airflow in the control panel.</li> <li>Install a cooling device (cooling fan or air conditioner) to lower the ambient temperature.</li> <li>Remove objects near the drive that are producing too much heat.</li> </ul>
oH3	Motor Overheat (PTC Input)	The thermistor wiring that detects motor temperature is defective.	Correct wiring errors.
oH4	Motor Overheat Fault (PTC Input)	The motor has overheated.	<ul style="list-style-type: none"> <li>Check the load level, acceleration/deceleration time, and motor start/stop frequency (cycle time).</li> <li>Decrease the load.</li> <li>Increase the values set in C1-01 to C1-04 [Acceleration/Deceleration Times].</li> <li>Set E2-01 [Motor Rated Current (FLA)] correctly to the value specified by the motor nameplate.</li> <li>Make sure that the motor cooling system is operating correctly, and repair or replace it if it is damaged.</li> <li>Adjust E1-04 to E1-10 [V/f Pattern Parameters]. For motor 2, adjust E3-04 to E3-10. Decrease the values set in E1-08 [Mid Point A Voltage] and E1-10 [Minimum Output Voltage].</li> </ul> <p><b>Note:</b> If E1-08 and E1-10 are set too low, the overload tolerance will decrease at low speeds.</p>
oL1	Motor Overload	The load is too heavy.	<p>Decrease the load.</p> <p><b>Note:</b> Reset oL1 when U4-16 [Motor oL1 Level] &lt; 100.</p>

Code	Name	Causes	Possible Solutions
		The acceleration/deceleration times or cycle times are too short.	<ul style="list-style-type: none"> <li>Examine the acceleration/deceleration times and the motor start/stop frequencies (cycle times).</li> <li>Increase the values set in <i>C1-01 to C1-04 [Acceleration/Deceleration Times]</i>.</li> </ul>
		Overload occurred while running at low speed.	<ul style="list-style-type: none"> <li>Decrease the load when running at low speed.</li> <li>Increase the motor speed.</li> <li>If the motor is run frequently at low speeds, replace the motor with a larger motor or use a drive-dedicated motor.</li> </ul> <p><b>Note:</b> For general-purpose motors, overload can occur while running at low speed when operating at below the rated current.</p>
		<i>L1-01 [Motor Overload (oL1) Protection]</i> is set incorrectly.	Set <i>L1-01</i> in as specified by the motor qualities for a drive-dedicated motor.
		The V/f pattern does not fit the motor qualities.	<ul style="list-style-type: none"> <li>Examine the ratios between the V/f pattern frequency and voltage. Decrease the voltage if it is too high compared to the frequency.</li> <li>Adjust <i>E1-04 to E1-10 [V/f Pattern Parameters]</i>. For motor 2, adjust <i>E3-04 to E3-10</i>. Decrease the values set in <i>E1-08 [Mid Point A Voltage]</i> and <i>E1-10 [Minimum Output Voltage]</i>.</li> </ul> <p><b>Note:</b> If the values set in <i>E1-08</i> and <i>E1-10</i> are too low, the overload tolerance will decrease at low speeds.</p>
		<i>E1-06 [Base Frequency]</i> is set incorrectly.	Set <i>E1-06</i> to the rated frequency shown on the motor nameplate.
		One drive is operating more than one motor.	Set <i>L1-01 = 0 [Motor Overload (oL1) Protection = Disabled]</i> , connect thermal overload relay to each motor to prevent damage to the motor.
		The electronic thermal protector qualities and the motor overload properties do not align.	<ul style="list-style-type: none"> <li>Examine the motor qualities and set <i>L1-01 [Motor Overload (oL1) Protection]</i> correctly.</li> <li>Connect a thermal overload relay to the motor.</li> </ul>
		The electronic thermal protector is operating at an incorrect level.	Set <i>E2-01 [Motor Rated Current (FLA)]</i> correctly to the value specified by the motor nameplate.
		There is increased motor loss from overexcitation operation.	<ul style="list-style-type: none"> <li>Lower the value set in <i>n3-13 [OverexcitationBraking (OEB) Gain]</i>.</li> <li>Set <i>L3-04 ≠ 4 [Stall Prevention during Decel ≠ Overexcitation/High Flux]</i>.</li> <li>Set <i>n3-23 = 0 [Overexcitation Braking Operation = Disabled]</i>.</li> </ul>
		The speed search-related parameters are set incorrectly.	<ul style="list-style-type: none"> <li>Examine the settings for all speed search related parameters.</li> <li>Adjust <i>b3-03 [Speed Search Deceleration Time]</i>.</li> <li>Set <i>b3-24 = 1 [Speed Search Method Selection = Speed Estimation]</i> after Auto-Tuning.</li> </ul>
		Phase loss in the input power supply is causing the output current to change.	Make sure that there is no phase loss, and repair problems.
		Overload occurred during overexcitation deceleration.	<ul style="list-style-type: none"> <li>Decrease the value set in <i>n3-13 [OverexcitationBraking (OEB) Gain]</i>.</li> <li>Decrease the value set in <i>n3-21 [HSB Current Suppression Level]</i>.</li> </ul>
oL2	Drive Overload	The load is too large.	Decrease the load.
		The acceleration/deceleration times or cycle times are too short.	<ul style="list-style-type: none"> <li>Examine the acceleration/deceleration times and the motor start/stop frequencies (cycle times).</li> <li>Increase the values set in <i>C1-01 to C1-04 [Acceleration/Deceleration Times]</i>.</li> </ul>
		The V/f pattern does not fit the motor qualities.	<ul style="list-style-type: none"> <li>Examine the ratios between the V/f pattern frequency and voltage. Decrease the voltage if it is too high compared to the frequency.</li> <li>Adjust <i>E1-04 to E1-10 [V/f Pattern Parameters]</i>. Decrease the values set in <i>E1-08 [Mid Point A Voltage]</i> and <i>E1-10 [Minimum Output Voltage]</i>. For motor 2, adjust <i>E3-04 to E3-10</i>.</li> </ul> <p><b>Note:</b> If the values set in <i>E1-08</i> and <i>E1-10</i> are too low, the overload tolerance will decrease at low speeds.</p>
		The drive capacity is too small.	Replace the drive with a larger capacity model.
		Overload occurred while running at low speed.	<ul style="list-style-type: none"> <li>Decrease the load when running at low speed.</li> <li>Replace the drive with a larger capacity model.</li> <li>Decrease the value set in <i>C6-02 [Carrier Frequency Selection]</i>.</li> </ul>
		The torque compensation gain is too large.	Decrease the value set in <i>C4-01 [Torque Compensation Gain]</i> to make sure that the motor does not stall.

Code	Name	Causes	Possible Solutions
		The speed search-related parameters are set incorrectly.	<ul style="list-style-type: none"> <li>Examine the settings for all speed search-related parameters.</li> <li>Adjust <i>b3-03 [Speed Search Deceleration Time]</i>.</li> <li>Set <i>b3-24 = 1 [Speed Search Method Selection = Speed Estimation]</i> after Auto-Tuning.</li> </ul>
		Phase loss in the input power supply is causing the output current to change.	<ul style="list-style-type: none"> <li>Correct errors with the wiring for main circuit drive input power.</li> <li>Make sure that there is no phase loss, and repair problems.</li> </ul>
		Overload occurred during overexcitation deceleration.	<ul style="list-style-type: none"> <li>Decrease the value set in <i>n3-13 [OverexcitationBraking (OEB) Gain]</i>.</li> <li>Decrease the value set in <i>n3-21 [HSB Current Suppression Level]</i>.</li> </ul>
oL3	Overtorque Detection 1	A fault occurred on the machine. Example: The machine is locked.	Examine the machine and remove the cause of the fault.
oL4	Overtorque Detection 2	A fault occurred on the machine. Example: The machine is locked.	Examine the machine and remove the cause of the fault.
oL7	High Slip Braking Overload	The load inertia is too large.	Decrease deceleration times in <i>C1-02 and C1-04 [Deceleration Times]</i> for applications that do not use High Slip Braking.
		An external force on the load side rotated the motor.	
		Something is preventing deceleration on the load side.	
		The value set in <i>n3-04 [HSB Overload Time]</i> is too small.	<ul style="list-style-type: none"> <li>Increase the value set in <i>n3-04</i>.</li> <li>Connect a thermal overload relay to the motor, and set <i>n3-04 = 1200 s (maximum value)</i>.</li> </ul>
oPr	Keypad Connection Fault	The keypad is not securely connected to the connector on the drive.	Examine the connection between the keypad and the drive.
		The connection cable between the drive and the keypad is disconnected.	<ul style="list-style-type: none"> <li>Remove the keypad and connect it again.</li> <li>If the cable is damaged, replace it.</li> </ul>
oS	Overspeed	There is overshoot.	Decrease <i>C5-01 [ASR Proportional Gain 1]</i> and increase <i>C5-02 [ASR Integral Time 1]</i> .
ov	Overvoltage	Deceleration time is too short and regenerative energy is flowing from the motor into the drive.	<ul style="list-style-type: none"> <li>Set <i>L3-04 = 1 [Stall Prevention during Decel = General Purpose]</i>.</li> <li>Increase the values set in <i>C1-02 or C1-04 [Deceleration Times]</i>.</li> <li>Perform Deceleration Rate Auto-Tuning.</li> </ul>
		The acceleration time is too short.	<ul style="list-style-type: none"> <li>Make sure that sudden drive acceleration does not cause the fault.</li> <li>Increase the values set in <i>C1-01 or C1-03 [Acceleration Times]</i>.</li> <li>Increase the value set in <i>C2-02 [S-Curve Time @ End of Accel]</i>.</li> <li>Set <i>L3-11 = 1 [Overvoltage Suppression Select = Enabled]</i>.</li> </ul>
		The drive output cable or motor is shorted to ground (the current short to ground is charging the main circuit capacitor of the drive through the power supply).	<ol style="list-style-type: none"> <li>Examine the motor main circuit cable, terminals, and motor terminal box, and then remove ground faults.</li> <li>Re-energize the drive.</li> </ol>
		If the drive detects <i>ov</i> in these conditions, the speed search-related parameters are incorrect: <ul style="list-style-type: none"> <li>During speed search</li> <li>During momentary power loss recovery</li> <li>When the drive starts again automatically</li> <li>When you set <i>A1-02 = 0 [Control Method Selection = V/f Control]</i> and do rotational Auto-Tuning</li> <li>You are using a premium efficiency motor</li> </ul>	<ul style="list-style-type: none"> <li>Examine the settings for all speed search related parameters.</li> <li>Set <i>b3-19 ≠ 0 [Speed Search Restart Attempts ≠ 0 times]</i>.</li> <li>Adjust <i>b3-03 [Speed Search Deceleration Time]</i> setting.</li> <li>Do Stationary Auto-Tuning for Line-to-Line Resistance and then set <i>b3-24 = 1 [Speed Search Method Selection = Speed Estimation]</i>.</li> <li>Increase the value set in <i>L2-04 [Powerloss V/f Recovery Ramp Time]</i>.</li> <li>Set these parameters: <ul style="list-style-type: none"> <li><i>b3-03 [Speed Search Deceleration Time]</i> = default value × 2</li> <li><i>L2-03 [Minimum Baseblock Time]</i> = default value × 2</li> <li><i>L2-04 [Powerloss V/f Recovery Ramp Time]</i> = default value × 2</li> </ul> </li> </ul>
		The power supply voltage is too high.	Decrease the power supply voltage to align with the drive rated voltage.
		Electrical interference caused a drive malfunction.	<ul style="list-style-type: none"> <li>Examine the control circuit lines, main circuit lines, and ground wiring, and decrease the effects of electrical interference.</li> <li>Make sure that a magnetic contactor is not the source of the electrical interference, then use a Surge Protective Device if necessary.</li> </ul>
		The load inertia is set incorrectly.	<ul style="list-style-type: none"> <li>Examine the load inertia settings with KEB, overvoltage suppression, or stall prevention during deceleration.</li> <li>Adjust <i>L3-25 [Load Inertia Ratio]</i> to align with the qualities of the machine.</li> </ul>



Code	Name	Causes	Possible Solutions
		There is motor hunting.	<ul style="list-style-type: none"> <li>Adjust <i>n1-02</i> [<i>Hunting Prevention Gain Setting</i>] settings.</li> <li>Adjust <i>n8-45</i> [<i>Speed Feedback Detection Gain</i>] and <i>n8-47</i> [<i>Pull-in Current Comp Filter Time</i>] settings.</li> </ul>
		Speed search does not complete at start when you use an induction motor in EZOLV control.	When <i>E9-01</i> = 0 [ <i>Motor Type Selection = Induction (IM)</i> ], set <i>b3-24</i> = 2 [ <i>Speed Search Method Selection = Current Detection 2</i> ].
ov2	DC Bus Overvoltage 2	The wiring is too long and DC bus voltage is too large.	<ul style="list-style-type: none"> <li>Shorten the shielded motor cable.</li> <li>Decrease the carrier frequency.</li> <li>If the power supply has a neutral ground, switch on the internal EMC filter.</li> </ul>
PE1, PE2	PLC Faults	The communication option detected a fault.	Refer to the manual for the communication option card.
PF	Input Phase Loss	There is a phase loss in the drive input power.	Correct errors with the wiring for main circuit drive input power.
		There is loose wiring in the drive input power terminals.	Tighten the terminal screws to the correct tightening torque.
		The drive input power voltage is changing too much.	<ul style="list-style-type: none"> <li>Examine the input power for problems.</li> <li>Make the drive input power stable.</li> <li>If the input power supply is good, examine the magnetic contactor on the main circuit side for problems.</li> </ul>
		There is unsatisfactory balance between voltage phases.	<ul style="list-style-type: none"> <li>Examine the input power for problems.</li> <li>Make the drive input power stable.</li> <li>Set <i>L8-05</i> = 0 [<i>Input Phase Loss Protection Sel = Disabled</i>].</li> </ul>
		The main circuit capacitors have become unserviceable.	<ul style="list-style-type: none"> <li>Examine the capacitor maintenance time in monitor <i>U4-05</i> [<i>Capacitor Maintenance</i>]. If <i>U4-05</i> is more than 90%, replace the control board or the drive. For information about replacing the control board, contact Yaskawa or your nearest sales representative.</li> <li>If drive input power is correct and the fault stays, replace the control board or the drive. For information about replacing the control board, contact Yaskawa or your nearest sales representative.</li> </ul>
PSE	JOHB-SMP3 Protocol Set Error	<ul style="list-style-type: none"> <li>The DIP switches on the JOHB-SMP3 Multi-Protocol Ethernet Card are at factory default settings.</li> <li>The DIP switches on the JOHB-SMP3 are not set to a valid protocol.</li> </ul>	<p>Remove power from the drive, wait for the charge light to go out, then set the DIP switches on the JOHB-SMP3 to the desired protocol.</p> <p><b>Note:</b></p> <ul style="list-style-type: none"> <li>Refer to the instructions packaged with the JOHB-SMP3 for more information about DIP switch settings.</li> <li>"PSE" error occurs only for PRG: 01012 and later, and only when DIP switches are at their factory default setting. The "PRG" column on the nameplate on the right side of the drive identifies the software version. You can also use <i>U1-25</i> [<i>SoftwareNumber FLASH</i>] to identify the software version.</li> </ul>
SC	Short Circuit/IGBT Failure	Overheating caused damage to the motor or the motor insulation is not satisfactory.	Measure the motor insulation resistance, and replace the motor if there is electrical conduction or unserviceable insulation.
SCF	Safety Circuit Fault	The safety circuit is broken.	<ul style="list-style-type: none"> <li>Make sure that you ground the drive correctly and re-energize the drive.</li> <li>If the fault stays, replace the control board or the drive. For information about replacing the control board, contact Yaskawa or your nearest sales representative.</li> </ul>
SEr	Speed Search Retries Exceeded	The speed search-related parameters are set incorrectly.	<ul style="list-style-type: none"> <li>Decrease <i>b3-10</i> [<i>Speed Estimation Detection Gain</i>].</li> <li>Increase <i>b3-17</i> [<i>Speed Est Retry Current Level</i>].</li> <li>Increase <i>b3-18</i> [<i>Speed Est Retry Detection Time</i>].</li> <li>Do Auto-Tuning again.</li> </ul>
SPCNR	Single Phase Converter Not Ready	When <i>YC-14</i> = 0 [ <i>Behavior when SPC is Not Ready = Coast to Stop - Fault</i> ], the digital input set to <i>H1-xx</i> = <i>BE</i> [ <i>MFDI Function Selection = Single Phase Converter Ready NC</i> ] deactivated to show the attached converter is faulted or not ready.	<ul style="list-style-type: none"> <li>Examine the wiring between the drive and converter.</li> <li>Examine the error code on converter.</li> </ul>
STPo	Motor Step-Out Detected	The motor code is set incorrectly for PM Control Methods.	<ul style="list-style-type: none"> <li>Set <i>E5-01</i> [<i>PM Motor Code Selection</i>] correctly as specified by the motor.</li> <li>For specialized motors, refer to the motor test report and set <i>E5-xx</i> correctly.</li> </ul>
TiM	Keypad Time Not Set	There is a battery in the keypad, but the date and time are not set.	Use the keypad to set the date and time.
UL3	Undertorque Detection 1	A fault occurred on the machine. Example: There is a broken pulley belt.	Examine the machine and remove the cause of the fault.
UL4	Undertorque Detection 2	A fault occurred on the machine. Example: There is a broken pulley belt.	Examine the machine and remove the cause of the fault.

Code	Name	Causes	Possible Solutions
UL6	Underload or Belt Break Detected	The output current decreased less than the motor underload curve set in L6-14 [Motor Underload Level @ Min Freq] for longer than the time set in L6-03 [Torque Detection Time 1].	Adjust the L6-14 setting to set the output current to stay the level more than the motor underload curve during usual operations.
Uv1	DC Bus Undervoltage	There is a phase loss in the drive input power.	Correct errors with the wiring for main circuit drive input power.
		There is loose wiring in the drive input power terminals.	Tighten the terminal screws to the correct tightening torque.
		The drive input power voltage is changing too much.	<ul style="list-style-type: none"> <li>Examine the input power for problems.</li> <li>Make the drive input power stable.</li> <li>If the input power supply is good, examine the magnetic contactor on the main circuit side for problems.</li> </ul>
		There was a loss of power.	Use a better power supply.
		The main circuit capacitors have become unserviceable.	Examine the capacitor maintenance time in monitor U4-05 [Capacitor:Maintenance]. If U4-05 is more than 90%, replace the control board or the drive. For information about replacing the control board, contact Yaskawa or your nearest sales representative.
		The relay or contactor on the soft-charge bypass relay is damaged.	U4-06 [PreChargeRelayMainte] shows the performance life of the soft-charge bypass relay. If U4-06 is more than 90%, replace the board or the drive. For information about replacing the board, contact Yaskawa or your nearest sales representative.
Uv2	Control Power Undervoltage	The value set in L2-02 [Power Loss Ride Through Time] increased and the momentary power loss recovery unit is not connected to the drive.	Connect the momentary power loss recovery unit to the drive.
Uv3	Soft Charge Answerback Fault	The relay or contactor on the soft-charge bypass relay is damaged.	<ul style="list-style-type: none"> <li>Re-energize the drive.</li> <li>If the fault stays, replace the control board or the drive.</li> <li>Check monitor U4-06 [PreChargeRelayMainte], which shows the performance life of the soft-charge bypass relay. If U4-06 is more than 90%, replace the board or the drive. For information about replacing the board, contact Yaskawa or your nearest sales representative.</li> </ul>
		Air inside the drive is too hot.	Check the ambient temperature of the drive.
VLTS	Thermostat Fault	The digital input from the terminal set for Thermostat Fault [H1-xx = 88] is active.	Examine the wiring or wait for the motor to cool.

### ◆ Minor Faults/Alarms

This section gives information about the causes and possible solutions when a minor fault or alarm occurs. Use the information in this table to remove the cause of the minor fault or alarm.

Code	Name	Causes	Possible Solutions
AER	Station Address Setting Error	The node address for the communication option is not in the permitted setting range.	For CANopen communication, set F6-35 [CANopen Node ID Selection] correctly.
AUXFB	PI Aux Feedback Level Loss	The analog input from the terminal set to H3-xx = 27 [MFAI Function Selection = PI Auxiliary Control Feedback Level] is more than 21 mA or less than 3 mA for longer than 1 s.	Repair transducer or wiring.
bAT	Keypad Battery Low Voltage	The keypad battery voltage is low.	Replace the keypad battery.
bb	Baseblock	An external baseblock command was entered through one of the MFDI terminals Sx, and the drive output stopped as shown by an external baseblock command.	Examine the external sequence and timing of the baseblock command input.
bCE	Bluetooth Communication Error	The smartphone or tablet with DriveWizard Mobile is too far from the keypad.	Move to 10 m (32.8 ft) or less from the keypad. <b>Note:</b> bCE can occur when the smartphone or tablet is 10 m (32.8 ft) or nearer to the keypad for different smartphone and tablet specifications.
		Radio waves from a different device are causing interference with communications between the smartphone or tablet and keypad.	Make sure that no device around the keypad uses the same radio bandwidth (2400 MHz to 2480 MHz), and prevent radio interference.
BuDif	Main Fdbk Lost, Using Diff Fdbk	Parameter Y4-41 = 1 [Diff Lvl Src Fdbk Backup Select = Enabled] and the drive detected a wire-break on the analog input terminal set for PID Feedback [H3-xx = B].	Examine the connection of the Main PID Feedback Transducer.
		Main PID Feedback Transducer is broken.	Replace Main PID Feedback Transducer.
Bu-Fb	Main Fdbk Lost Using Backup Fdbk	The drive detected wire-break on the analog input terminal set to H3-xx = B [MFAI Function Selection = PID Feedback].	Examine the connection of the Main PID Feedback Transducer.

Code	Name	Causes	Possible Solutions
		Main PID Feedback Transducer is broken.	Replace Main PID Feedback Transducer.
BuFbl	Backup Fdbk Lost Chk/Repl Xducer	The drive detected wire-break on the analog input terminal set for <i>PID Feedback Backup</i> [H3-xx = 24].	Examine the connection of the Differential PID Feedback transducer.
		Backup PID Feedback Transducer is broken.	Replace Backup PID Feedback Transducer.
		Parameter <i>Y4-41 = 1</i> [ <i>Diff Lvl Src Fdbk Backup Select = Enabled</i> ] and the drive detected a wire-break on the analog input terminal set for <i>Differential Level Source</i> [H3-xx = 2D].	Examine the connection of the Differential PID Feedback transducer.
		Parameter <i>Y4-41 = 1</i> and the Differential PID Feedback Transducer is broken.	<ul style="list-style-type: none"> <li>Replace the Differential PID Feedback Transducer.</li> <li>Set <i>Y4-41 = 0</i> [<i>Disabled</i>].</li> </ul>
bUS	Option Communication Error	The communications cable wiring is incorrect.	Correct wiring errors.
bUSy	Busy	You set the drive to use MEMOBUS/Modbus communications to change parameters, but you used the keypad to change parameters.	Use MEMOBUS/Modbus communications to enter the enter command, then use the keypad to change the parameter.
		You tried to change a parameter while the drive was changing setting.	Wait until the process is complete.
CALL	Serial Comm Transmission Error	The communications cable wiring is incorrect.	Correct wiring errors.
CE	Modbus Communication Error	The communications cable wiring is incorrect.	Correct wiring errors.
		There is a short circuit in the communications cable or the communications cable is not connected.	<ul style="list-style-type: none"> <li>Repair short circuits and connect cables.</li> <li>Replace the defective communications cable.</li> </ul>
		Electrical interference caused a communication data error.	<ul style="list-style-type: none"> <li>Examine the control circuit lines, main circuit lines, and ground wiring, and decrease the effects of electrical interference.</li> <li>Make sure that a magnetic contactor is not the source of the electrical interference, then use a Surge Protective Device if necessary.</li> <li>Use only the recommended cables or other shielded line. Ground the shield on the controller side or the drive input power side.</li> <li>Separate the communication wiring from drive power lines, and install a noise filter to the input side of the power supply for communication.</li> <li>Decrease the effects of electrical interference from the controller.</li> </ul>
		The communication protocol is not compatible.	<ul style="list-style-type: none"> <li>Examine the values set in <i>H5-xx</i>.</li> <li>Examine the settings on the controller side and correct the difference in communication conditions.</li> </ul>
		The value set in <i>H5-09</i> [ <i>CE Detection Time</i> ] is too small for the communications cycle.	<ul style="list-style-type: none"> <li>Change the controller software settings.</li> <li>Increase the value set in <i>H5-09</i>.</li> </ul>
		The controller software or hardware is causing a communication problem.	Examine the controller and remove the cause of the problem.
CE	Run at H5-34 (CE Go-To-Freq)	The communications cable wiring is incorrect.	Correct wiring errors.
		There is a short circuit in the communications cable or the communications cable is not connected.	<ul style="list-style-type: none"> <li>Repair short circuits and connect cables.</li> <li>Replace the defective communications cable.</li> </ul>
		Electrical interference caused a communication data error.	<ul style="list-style-type: none"> <li>Examine the control circuit lines, main circuit lines, and ground wiring, and decrease the effects of electrical interference.</li> <li>Make sure that a magnetic contactor is not the source of the electrical interference, then use a Surge Protective Device if necessary.</li> <li>Use only recommended shielded line. Ground the shield on the controller side or on the drive input power side.</li> <li>Separate the communication wiring from drive power lines, and install a noise filter to the input side of the power supply for communication.</li> <li>Decrease the effects of electrical interference from the controller.</li> </ul>
		The communication protocol is not compatible.	<ul style="list-style-type: none"> <li>Examine the values set in <i>H5-xx</i>.</li> <li>Examine the settings on the controller side and correct the difference in communication conditions.</li> </ul>
		The value set in <i>H5-09</i> [ <i>CE Detection Time</i> ] is too small for the communications cycle.	<ul style="list-style-type: none"> <li>Make sure that the settings are compatible.</li> <li>Change the software settings in the PLC.</li> <li>Increase the value set in <i>H5-09</i>.</li> </ul>
		The controller software or hardware is causing a communication problem.	Examine the controller and remove the cause of the problem.
CrST	Cannot Reset	The drive received a fault reset command when a Run command was active.	Turn off the Run command then de-energize and re-energize the drive.

## 21 Troubleshooting

Code	Name	Causes	Possible Solutions
CyPo	Cycle Power to Accept Changes	Although $F6-15 = 1$ [Comm. Option Parameters Reload = Reload Now], the drive does not update the communication option parameters.	Re-energize the drive to update the communication option parameters.
dEv	Speed Deviation	The load is too heavy	Decrease the load.
DIFF	Differential Feedback Exceeded	The difference between the PID Feedback and Differential Level Source [H3-xx = 2D] is more than the level set in Y4-18 [Pre-Charge Loss of Prime Level 2] for the time set in Y4-19 [Differential Lvl Detection Time].	<ul style="list-style-type: none"> <li>Replace the feedback transducer or transducers.</li> <li>Set Y4-18 and Y4-19 correctly.</li> </ul>
dnE	Drive Disabled	A terminal set for H1-xx = 6A [MFDI Function Selection = Drive Enable] deactivated.	Examine the operation sequence.
DS	De-Scale/De-Rag Active	The terminal is set to H2-xx = C5 or 1C5 [MFDO Function Selection De-Scale or !De-Scale] and the set length of run time elapsed.	<ul style="list-style-type: none"> <li>If you do not want to do De-Scale/De-Rag, set Y8-01 = 0 [De-Scale Operation Selection = Disabled].</li> <li>Adjust the Y8-08 [Run Time before De-Scale] setting.</li> </ul>
EF	FWD/REV Run Command Input Error	The drive received a forward command and a reverse command at the same time for longer than 0.5 s.	Examine the forward and reverse command sequence and correct the problem.
EF0	Option Card External Fault	The communication option card received an external fault from the controller.	<ol style="list-style-type: none"> <li>Find the device that caused the external fault and remove the cause.</li> <li>Clear the external fault input from the controller.</li> </ol>
EF1 to EF8	External Fault (Terminal Sx)	MFDI terminal Sx caused an external fault through an external device.	<ol style="list-style-type: none"> <li>Find the device that caused the external fault and remove the cause.</li> <li>Clear the external fault input in the MFDI.</li> </ol>
		The wiring is incorrect.	Correctly connect the signal line to MFDI terminal Sx.
		External Fault [H1-01 = 2C to 2F] is set to MFDI terminal Sx, but the terminal is not in use.	Correctly set the MFDI.
EOF	Emergency Override FWD	The digital input terminal set to H1-xx = AF [MFDI Function Selection = Emergency Override FWD] activated.	When the emergency condition is gone, deactivate the digital input set to Emergency Override FWD.
EOR	Emergency Override REV	The digital input terminal set to H1-xx = B0 [MFDI Function Selection = Emergency Override REV] activated.	When the emergency condition is gone, deactivate the digital input set to Emergency Override REV.
EP24v	External Power 24V Supply	The voltage of the main circuit power supply decreased, and the 24 V power supply is supplying power to the drive.	<ul style="list-style-type: none"> <li>Examine the main circuit power supply.</li> <li>Turn ON the main circuit power supply to run the drive.</li> </ul>
FDBKL	Feedback Loss Wire Break	The analog input from the terminal set to H3-xx = B [MFAI Function Selection = PID Feedback] is more than 21 mA or less than 3 mA for longer than 1 s in these conditions: <ul style="list-style-type: none"> <li>b5-82 = 1 [Feedback Loss 4 ~ 20mA Detect Sel = Alarm Only]</li> <li>b5-01 ≠ 0 [PID Mode Setting ≠ Disabled]</li> <li>H3-01, H3-09, or H3-05 = 2 [Terminal A1/A2/A3 Signal Level Selection = 4 to 20 mA]</li> </ul>	Make sure that you install the PID feedback source and it operates correctly.
FLGT	Feedback Loss, Go To Freq b5-83	The analog input from the terminal set to H3-xx = B [MFAI Function Selection = PID Feedback] is more than 21 mA or less than 3 mA for longer than 1 s in these conditions: <ul style="list-style-type: none"> <li>b5-82 = 3 [Feedback Loss 4 ~ 20mA Detect Sel = Run At b5-83]</li> <li>b5-01 ≠ 0 [PID Mode Setting ≠ Disabled]</li> <li>H3-01 or H3-09 = 2 [Terminal A1/A2 Signal Level Selection = 4 to 20 mA]</li> </ul>	Make sure that you install the PID feedback source and it operates correctly.
FR<MS	Freq Ref < Minimum Speed (Y1-06)	The drive frequency reference setting is less than the value set in Y1-06 [Minimum Speed] in these conditions: <ul style="list-style-type: none"> <li>The drive is not in PI Mode</li> <li>The drive is running</li> <li>Minimum Speed is enabled (Y1-06 &gt; 0.00)</li> <li>Y1-06 &gt; Y4-12 [Thrust Frequency]</li> </ul>	Increase the frequency reference to a value more than Y1-06.
FR<TH	Freq. Reference < Thrust (Y4-12)	The drive frequency reference setting is less than the value set in Y4-12 [Thrust Frequency] in these conditions: <ul style="list-style-type: none"> <li>The drive is not in PI Mode</li> <li>The drive is running</li> <li>Thrust is enabled (Y4-11 [Thrust Acceleration Time] &gt; 0.00 and Y4-12 &gt; Y1-06 [Minimum Speed])</li> </ul>	Increase the frequency reference to a value more than Y4-12.

Code	Name	Causes	Possible Solutions
HCA	High Current Alarm	The load is too heavy.	<ul style="list-style-type: none"> <li>Decrease the load for applications with repetitive starts and stops.</li> <li>Replace the drive with a larger capacity model.</li> </ul>
HIAUX	High PI Aux Feedback Level	<p>PI Auxiliary Feedback is more than the level set in <i>YF-12 [PI Aux Control High Level Detect]</i> for the time set in <i>YF-13 [PI Aux High Level Detection Time]</i> in these conditions:</p> <ul style="list-style-type: none"> <li>The drive is running.</li> <li>The output frequency &gt; 0.</li> </ul>	<ul style="list-style-type: none"> <li>Decrease the PI Auxiliary Feedback level to less than <i>YF-12</i>.</li> <li>Set <i>YF-12</i> and <i>YF-13</i> correctly.</li> </ul>
HIFB	High Feedback Sensed	The feedback level is more than the level set in <i>Y1-11 [High Feedback Level]</i> .	<ul style="list-style-type: none"> <li>Decrease the feedback level to less than <i>Y1-11 - Y1-14 [Hysteresis Level]</i>.</li> <li>Set <i>Y1-11</i> and <i>Y1-12</i> correctly.</li> </ul>
L24v	Loss of External Power 24 Supply	The voltage of the backup 24 V power supply has decreased. The main circuit power supply is operating correctly.	<ul style="list-style-type: none"> <li>Examine the external 24 V power supply for disconnected wires and wiring errors and repair the problems.</li> <li>Examine the external 24 V power supply for problems.</li> </ul>
LCP	Low City Pressure	<p>Insufficient pressure is present on the inlet to the pump in these conditions:</p> <ul style="list-style-type: none"> <li><i>Y4-24 = 0 [Low City Alarm Text = Low City Pressure]</i></li> <li>The terminal set for <i>H1-xx = B8 or 1B8 [MFDI Function Selection = Low City Pressure or !Low City Pressure]</i> activates</li> </ul>	<ul style="list-style-type: none"> <li>Examine the pressure switch contact for correct operation.</li> <li>Examine control wiring to drive terminal strip from pressure switch contact.</li> <li>Make sure that suction pressure is present with an isolated measuring device.</li> <li>Set <i>Y4-22 [Low City On-Delay Time]</i> and <i>Y4-23 [Low City Off-Delay Time]</i> correctly.</li> <li>Deactivate the digital input terminals set to <i>H1-xx = B8 or 1B8</i>.</li> </ul>
LOAUX	Low PI Aux Feedback Level	When the drive is running, PI Auxiliary Feedback is less than the level set in <i>YF-09 [PI Aux Control Low Lvl Detection]</i> for the time set in <i>YF-10 [PI Aux Control Low Lvl Det Time]</i> .	<ul style="list-style-type: none"> <li>Increase the PI Auxiliary Feedback level more than <i>YF-09</i>.</li> <li>Set <i>YF-09</i> and <i>YF-10</i> correctly.</li> </ul>
LOFB	Low Feedback Sensed	The feedback level is less than the level set in <i>Y1-08 [Low Feedback Level]</i> for the time set in <i>Y1-09 [Low Feedback Lvl Fault Dly Time]</i> .	<ul style="list-style-type: none"> <li>Increase the feedback level to more than <i>Y1-08 + Y1-14 [High Feedback Hysteresis Level]</i>.</li> <li>Set <i>Y1-08</i> and <i>Y1-09</i> correctly.</li> </ul>
LoG	Com Error / Abnormal SD Card	There is not a micro SD card in the keypad.	Put a micro SD card in the keypad.
LOP	Loss of Prime	The drive used the method set in <i>Y1-18 [Prime Loss Detection Method]</i> to detect that the pump load is less than the level set in <i>Y1-19 [Prime Loss Level]</i> for the time set in <i>Y1-20 [Prime Loss Time]</i> , and the output frequency is <i>Y1-21 [Prime Loss Activation Freq]</i> or more.	<ul style="list-style-type: none"> <li>Examine a dry well, air in the system, or no water in the system. Use preferred priming method suggested by the pump manufacturer to restart the pump.</li> <li>When there is resistance in the pump, allow the system to pump water again.</li> <li>Set <i>Y1-18</i> to <i>Y1-21</i> correctly.</li> </ul>
LSP	Low Suction Pressure	<p>An external input has indicated that an insufficient suction pressure condition exists in these conditions:</p> <ul style="list-style-type: none"> <li><i>Y4-24 = 1 [Low City Alarm Text = Low Suction Pressure]</i></li> <li>The terminal set for <i>H1-xx = B8 or 1B8 [MFDI Function Selection = Low City Pressure or !Low City Pressure]</i> activates</li> </ul>	<ul style="list-style-type: none"> <li>Examine the pressure switch contact for correct operation.</li> <li>Examine control wiring to drive terminal strip from pressure switch contact.</li> <li>Make sure that suction pressure is present with an isolated measuring device.</li> <li>Increase the system pressure.</li> <li>Set <i>Y4-22 [Low City On-Delay Time]</i> and <i>Y4-23 [Low City Off-Delay Time]</i> correctly.</li> <li>Deactivate the digital input terminals set to <i>H1-xx = B8 or 1B8</i>.</li> </ul>
LT-1	Cooling Fan Maintenance Time	The cooling fan is at 90% of its performance life estimate.	<ol style="list-style-type: none"> <li>Replace the cooling fan.</li> <li>Set <i>o4-03 = 0 [Fan Operation Time Setting = 0 h]</i> to reset the cooling fan operation time.</li> </ol>
LT-2	Capacitor Maintenance Time	The capacitors for the main circuit and control circuit are at 90% of their performance life estimate.	Replace the control board or the drive. For information about replacing the control board, contact Yaskawa or your nearest sales representative.
LT-3	SoftChargeBypassRelay MainteTime	The soft charge bypass relay is at 90% of its performance life estimate.	Replace the control board or the drive. For information about replacing the control board, contact Yaskawa or your nearest sales representative.
LT-4	IGBT Maintenance Time (50%)	The IGBT is at 50% of its performance life estimate.	Check the load, carrier frequency, and output frequency.
LWT	Low Water In Tank	<p>An external input has indicated that the water level in the tank is too low in these conditions:</p> <ul style="list-style-type: none"> <li><i>Y4-24 = 2 [Low City Alarm Text = Low Water in Tank]</i></li> <li>The terminal set for <i>H1-xx = B8 or 1B8 [MFDI Function Selection = Low City Pressure or !Low City Pressure]</i> activates</li> </ul>	<ul style="list-style-type: none"> <li>Examine the pressure switch contact for correct operation.</li> <li>Examine control wiring to drive terminal strip from pressure switch contact.</li> <li>Make sure that suction pressure is present with an isolated measuring device.</li> <li>Increase the water level.</li> <li>Set <i>Y4-22 [Low City On-Delay Time]</i> and <i>Y4-23 [Low City Off-Delay Time]</i> correctly.</li> <li>Deactivate the digital input terminals set to <i>H1-xx = B8 or 1B8</i>.</li> </ul>

Code	Name	Causes	Possible Solutions
NMS	Setpoint Not Met	The feedback deviates from the setpoint at a level more than <i>Y1-15 [Maximum Setpoint Difference]</i> for the time set in <i>Y1-16 [Not Maintaining Setpoint Time]</i> .	<ul style="list-style-type: none"> <li>Examine for a blocked impeller, over cycling, or broken pipe.</li> <li>Set <i>Y1-15</i> and <i>Y1-16</i> correctly.</li> </ul>
OD	Output Disconnect	The output circuit between the drive and the motor is open, and the drive output current is less than 5% of <i>E2-01 [Motor Rated Current (FLA)]</i> .	<ul style="list-style-type: none"> <li>Close the disconnected output circuit between the drive and the motor.</li> <li>If you do not use a motor disconnect, set <i>Y4-42 = 0 [Disabled]</i>.</li> </ul>
oH	Heatsink Overheat	The ambient temperature is high and the heatsink temperature is more than the <i>L8-02 [Overheat Alarm Level]</i> .	<ul style="list-style-type: none"> <li>Measure the ambient temperature.</li> <li>Increase the airflow around the drive.</li> <li>Install a cooling device (cooling fan or air conditioner) to decrease the ambient temperature.</li> <li>Remove objects near the drive that are producing too much heat.</li> </ul>
oH2	External Overheat (H1-XX=B)	An external device sent an <i>oH2</i> alarm.	<ol style="list-style-type: none"> <li>Find the external device that output the overheat alarm.</li> <li>Remove the cause of the problem.</li> <li>Clear the <i>Overheat Alarm (oH2) [H1-xx = B]</i> in MFD1 terminals S1 to S7.</li> </ol>
oH3	Motor Overheat (PTC Input)	The thermistor wiring that detects motor temperature is defective.	Correct wiring errors.
oL3	Overtorque 1	A fault occurred on the machine. Example: The machine is locked.	Examine the machine and remove the cause of the fault.
oL4	Overtorque 2	A fault occurred on the machine. Example: The machine is locked.	Examine the machine and remove the cause of the fault.
oS	Overspeed	There is overshoot.	Decrease <i>C5-01 [ASR Proportional Gain 1]</i> and increase <i>C5-02 [ASR Integral Time 1]</i> .
ov	DC Bus Overvoltage	The drive output cable or motor is shorted to ground (the current short to ground is charging the main circuit capacitor of the drive through the power supply).	<ol style="list-style-type: none"> <li>Examine the motor main circuit cable, terminals, and motor terminal box, and then remove ground faults.</li> <li>Re-energize the drive.</li> </ol>
		The power supply voltage is too high.	Decrease the power supply voltage to align with the drive rated voltage.
		Electrical interference caused a drive malfunction.	<ul style="list-style-type: none"> <li>Examine the control circuit lines, main circuit lines, and ground wiring, and minimize the effects of noise.</li> <li>Find the source of the noise. If a magnetic contactor is the source, use Surge Protective Device if necessary.</li> <li>Set <i>L5-01 ≠ 0 [Number of Auto-Restart Attempts ≠ 0 times]</i>.</li> </ul>
ovEr	Too Many Parameters Changed	You tried to change more than 150 parameters.	<p>Make sure that parameters that do not have an effect on drive operation are at their default settings.</p> <p><b>Note:</b></p> <ul style="list-style-type: none"> <li>You can change 150 parameters maximum.</li> <li>If you change parameters that have dependencies, the drive can detect <i>ovEr</i> when the number of changed parameters is fewer than 150.</li> </ul>
PASS	Modbus Communication Test	The MEMOBUS/Modbus communications test is complete.	The <i>PASS</i> display will turn off after communications test mode is cleared.
PF	Input Phase Loss	There is a phase loss in the drive input power.	Correct errors with the wiring for main circuit drive input power.
		Loose wiring in the input power terminals.	Tighten the terminal screws to the correct tightening torque.
		The drive input power voltage is changing too much.	<ul style="list-style-type: none"> <li>Examine the input power for problems.</li> <li>Make the drive input power stable.</li> </ul>
		Unsatisfactory balance between voltage phases.	<ul style="list-style-type: none"> <li>Examine the input power for problems.</li> <li>Make the drive input power stable.</li> <li>If the input power supply is good, examine the magnetic contactor on the main circuit side for problems.</li> </ul>
		The main circuit capacitors are unserviceable.	<ul style="list-style-type: none"> <li>Examine the capacitor maintenance time in monitor <i>U4-05 [Capacitor Maintenance]</i>.</li> <li>If <i>U4-05</i> is more than 90%, replace the capacitor. Contact Yaskawa or your nearest sales representative for more information.</li> </ul>
		<ul style="list-style-type: none"> <li>Examine the input power for problems.</li> <li>Re-energize the drive.</li> <li>If the alarm stays, replace the circuit board or the drive. Contact Yaskawa or your nearest sales representative for more information.</li> </ul>	

Code	Name	Causes	Possible Solutions
R-DNE	Remote Drive Disable	<ul style="list-style-type: none"> <li>The digital input set to <math>H1-xx = BD</math> [MFDI Function Selection = Remote Drive Disable] activated.</li> <li>The digital input set to <math>H1-xx = 1BD</math> [!Remote Drive Disable] deactivated.</li> </ul>	Examine the statuses of the digital input terminals set to $H1-xx = BD$ or $1BD$
rUn	Motor Switch during Run	The drive received a <i>Motor 2 Selection</i> [ $H1-xx = 16$ ] during run.	Make sure that the drive receives the Motor 2 Selection while the drive is stopped.
SE	Modbus Test Mode Error	MEMOBUS/Modbus communications self-diagnostics [ $H1-xx = 67$ ] was done while the drive was running.	Stop the drive and do MEMOBUS/Modbus communications self-diagnostics.
SPCNR	Single Phase Converter Not Ready	When $YC-14 = 1$ [Behavior when SPC is Not Ready = Coast to Stop - Alarm], the digital input set to $H1-xx = BE$ [MFDI Function Selection = Single Phase Converter Ready NC] deactivated to show that the attached converter is faulted or not ready.	<ul style="list-style-type: none"> <li>Examine the wiring between the drive and converter.</li> <li>Examine the error code on converter.</li> </ul>
STo	Safe Torque OFF	Safe Disable inputs H1-HC and H2-HC are open.	<ul style="list-style-type: none"> <li>Make sure that the Safe Disable signal is input from an external source to terminal H1-HC and H2-HC.</li> <li>When the Safe Disable function is not in use, use a jumper to connect terminals H1-HC and H2-HC.</li> </ul>
		There is internal damage to the two Safe Disable channels.	Replace the board or the drive. Contact Yaskawa or your nearest sales representative to replace the board.
SToF	Safe Torque OFF Hardware	One of the two terminals H1-HC or H2-HC received the Safe Disable input signal.	<ul style="list-style-type: none"> <li>Make sure that the Safe Disable signal is input from an external source to terminals H1-HC or H2-HC.</li> <li>When the Safe Disable function is not in use, use a jumper to connect terminals H1-HC and H2-HC.</li> </ul>
		The Safe Disable input signal is wired incorrectly.	
		There is internal damage to one Safe Disable channel.	Replace the board or the drive. Contact Yaskawa or your nearest sales representative to replace the board.
TiM	Keypad Time Not Set	There is a battery in the keypad, but you have not set the date and time.	Use the keypad to set the date and time.
TrPC	IGBT Maintenance Time (90%)	The IGBT is at 90% of its performance life estimate.	Replace the IGBT or the drive. For more information, contact Yaskawa or your nearest sales representative.
UL3	Undertorque Detection 1	A fault occurred on the machine. Example: There is a broken pulley belt.	Examine the machine and remove the cause of the fault.
UL4	Undertorque Detection 2	A fault occurred on the machine. Example: There is a broken pulley belt.	Examine the machine and remove the cause of the fault.
UL6	Underload or Belt Break Detected	The output current decreased less than the motor underload curve set in $L6-14$ [Motor Underload Level @ Min Freq] for longer than the time set in $L6-03$ [Torque Detection Time 1].	Examine parameters $L6-13$ [Motor Underload Curve Select] and $L6-14$ .
		The belt has broken disconnecting the motor from the load.	
Uv	Undervoltage	The drive input power voltage is changing too much.	<ul style="list-style-type: none"> <li>Examine the input power for problems.</li> <li>Make the drive input power stable.</li> <li>If the input power supply is good, examine the magnetic contactor on the main circuit side for problems.</li> </ul>

## ◆ Parameter Setting Errors

Parameter setting errors occur when multiple parameter settings do not agree, or when parameter setting values are not correct. Refer to the table in this section, examine the parameter setting that caused the error, and remove the cause of the error. You must first correct the parameter setting errors before you can operate the drive. The drive will not send notification signals for the faults and alarms when these parameter setting errors occur.

Code	Name	Causes	Possible Solutions
oPE01	Drive Capacity Setting Error	The value set in $o2-04$ [Drive Model (KVA) Selection] does not agree with the drive model.	Set $o2-04$ to the correct value.
oPE02	Parameter Range Setting Error	Parameters settings are not in the applicable setting range.	<ol style="list-style-type: none"> <li>Push  to show <math>U1-18</math> [oPE Fault Parameter], and find parameters that are not in the applicable setting range.</li> <li>Correct the parameter settings.</li> </ol> <p><b>Note:</b> If more than one error occurs at the same time, other <math>oPE_{xx}</math> errors have priority over <math>oPE02</math>.</p>

Code	Name	Causes	Possible Solutions
oPE03	Multi-Function Input Setting Err	The settings for these parameters do not agree: <ul style="list-style-type: none"> <li>• <i>F3-10 to F3-25 [Terminal D1 to DF Function Selection]</i></li> <li>• <i>H1-01 to H1-08 [Terminals S1 to S8 Function Selection]</i></li> <li>• <i>H7-01 to H7-04 [Virtual Multi-Function Inputs 1 to 4]</i></li> </ul>	Correct the parameter settings.
oPE05	Run Cmd/Freq Ref Source Sel Err	The setting to assign the Run command or frequency reference to an option card or the pulse train input is incorrect.	Correct the parameter settings.
oPE07	Analog Input Selection Error	The settings for <i>H3-02, H3-06, H3-10 [MFAI Function Selection]</i> and <i>H7-30 [Virtual Analog Input Selection]</i> overlap.	Set <i>H3-02, H3-06, H3-10, and H7-30</i> correctly to prevent overlap. <b>Note:</b> It is possible to set these functions to multiple analog input terminals at the same time: <ul style="list-style-type: none"> <li>• Setting value 0 [Frequency Reference]</li> <li>• Setting values <i>F</i> and <i>1F</i> [Not Used]</li> </ul>
oPE08	Parameter Selection Error	You set a function that is not compatible with the control method set in <i>A1-02 [Control Method Selection]</i> .	<ol style="list-style-type: none"> <li>1. Push  to show <i>U1-18 [oPE Fault Parameter]</i>, and find parameters that are not in the applicable setting range.</li> <li>2. Correct the parameter settings.</li> </ol> <b>Note:</b> If more than one error occurs at the same time, other <i>oPExx</i> errors have priority over <i>oPE08</i> .
oPE09	PID Control Selection Fault	These parameters are set at the same time: <ul style="list-style-type: none"> <li>• <i>b5-01 = 1</i></li> <li>• <i>b5-11 = 1 [PID Output Reverse Selection = Negative Output Accepted]</i></li> </ul> And one of these parameters is set: <ul style="list-style-type: none"> <li>• <i>d2-02 ≠ 0.0 [Frequency Reference Lower Limit ≠ 0.0%]</i></li> <li>• <i>Y1-06 ≠ 0.0 [Minimum Speed ≠ 0.0%]</i></li> <li>• <i>Y4-12 ≠ 0.0 [Thrust Frequency ≠ 0.0%]</i></li> <li>• <i>Y1-01 ≠ 0 [Multiplex Mode ≠ Drive Only]</i></li> <li>• <i>YF-01 ≠ 0 [PI Aux Control Selection ≠ Disabled]</i></li> </ul>	Correct the parameter settings.
oPE10	V/f Data Setting Error	The parameters that set the V/f pattern do not satisfy these conditions: <ul style="list-style-type: none"> <li>• For motor 1: <math>E1-09 \leq E1-07 &lt; E1-06 \leq E1-11 \leq E1-04</math> [Minimum Output Frequency ≤ Mid Point A Frequency &lt; Base Frequency ≤ Mid Point B Frequency ≤ Maximum Output Frequency]</li> <li>• For motor 2: <math>E3-09 \leq E3-07 &lt; E3-06 \leq E3-11 \leq E3-04</math> [Minimum Output Frequency ≤ Mid Point A Frequency &lt; Base Frequency ≤ Mid Point B Frequency ≤ Maximum Output Frequency]</li> </ul>	Set the parameters correctly to satisfy the conditions.
oPE11	Carrier Frequency Setting Error	These parameters are set at the same time: <ul style="list-style-type: none"> <li>• <math>C6-05 &gt; 6</math> [Carrier Freq Proportional Gain &gt; 6]</li> <li>• <math>C6-04 &gt; C6-03</math> [Carrier Frequency Lower Limit &gt; Carrier Frequency Upper Limit]</li> </ul> <b>Note:</b> When $C6-05 < 7$ , $C6-04$ becomes disabled. $C6-03$ stays active.	Set <i>C6-02 to C6-05</i> correctly.
oPE16	Energy Saving Constants Error	The Energy Saving parameters are not set in the applicable setting range.	Make sure that <i>E5-xx</i> is set correctly as specified by the motor nameplate data.
oPE33	Digital Output Selection Error	These two parameters are set at the same time: <ul style="list-style-type: none"> <li>• <math>H2-60 \neq F</math> [Term M1-M2 Secondary Function ≠ Not Used]</li> <li>• <math>H2-01 = 1xx</math> [Term M1-M2 Function Selection = Inverse output of xx]</li> </ul>	Clear the $H2-01$ to $H2-03 = 1xx$ [Inverse output of xx] settings. <b>Note:</b> It is not possible to set $H2-01$ to $H2-03 = 1xx$ [Inverse output of xx] when using output functions for logic operations ( $H2-60, H2-63, H2-66 \neq F$ ).

## ◆ Auto-Tuning Errors

This table gives information about errors detected during Auto-Tuning. If the drive detects an Auto-Tuning error, the keypad will show the error and the motor will coast to stop. The drive will not send notification signals for faults and alarms when Auto-Tuning errors occur.

Two types of Auto-Tuning errors are: *Endx* and *Erx*. *Endx* identifies that Auto-Tuning has successfully completed with calculation errors. Find and repair the cause of the error and do Auto-Tuning again, or set the motor parameters manually. You can use the drive in the application if you cannot find the cause of the *Endx* error.



*Err* identifies that Auto-Tuning was not successful. Find and repair the cause of the error and do Auto-Tuning again.

Code	Name	Causes	Possible Solutions
End1	Excessive Rated Voltage Setting	The torque reference was more than 20% during Auto-Tuning or the no-load current that was measured after Auto-Tuning is more than 80%.	<ul style="list-style-type: none"> <li>Make sure that the input motor nameplate data is correct.</li> <li>Do Auto-Tuning again and correctly set the motor nameplate data.</li> <li>If you can uncouple the motor and load, remove the motor from the machine and do Rotational Auto-Tuning again.</li> <li>If you cannot uncouple the motor and load, use the results from Auto-Tuning.</li> </ul>
End2	Iron Core Saturation Coefficient	The motor nameplate data entered during Auto-Tuning is incorrect.	<ul style="list-style-type: none"> <li>Make sure that the input motor nameplate data is correct.</li> <li>Do Auto-Tuning again and correctly set the motor nameplate data.</li> </ul>
End3	Rated Current Setting Alarm	The rated current value is incorrect.	Do Auto-Tuning again and set the correct rated current shown on the motor nameplate.
End4	Adjusted Slip Calculation Error	The Auto-Tuning results were not in the applicable parameter setting range.	<ul style="list-style-type: none"> <li>Make sure the input motor nameplate data is correct.</li> <li>Do Rotational Auto-Tuning again and correctly set the motor nameplate data.</li> <li>If you cannot uncouple the motor and load, do Stationary Auto-Tuning 2.</li> </ul>
End5	Resistance Tuning Error	The Auto-Tuning results of the Line-to-Line Resistance were not in the applicable range.	<ul style="list-style-type: none"> <li>Make sure that the input motor nameplate data is correct.</li> <li>Examine and repair damaged motor wiring.</li> </ul>
End6	Leakage Inductance Alarm	The Auto-Tuning results were not in the applicable parameter setting range.	Make sure that the input motor nameplate data is correct, and do Auto-Tuning again.
End7	No-Load Current Alarm	The Auto-Tuning results of the motor no-load current value were not in the applicable range.	Examine and repair damaged motor wiring.
End8	HFI Alarm	<ul style="list-style-type: none"> <li>Inductance saliency ratio (<i>E5-07/E5-06</i>) is too small.</li> <li>The drive cannot find the <i>n8-36</i> [<i>HFI Frequency Level for L Tuning</i>] value.</li> </ul>	<ul style="list-style-type: none"> <li>Set the correct value on the motor nameplate to <i>E5-xx</i> [<i>PM Motor Settings</i>] or do rotational/stationary Auto-Tuning.</li> <li>When it is necessary to set <i>n8-35 = 1</i> [<i>Initial Pole Detection Method = High Frequency Injection</i>], make sure that there is no unusual noise in the low speed range (10% or less) and that the motor does not rotate in reverse at start.</li> </ul> <p><b>Note:</b> If the drive detects <i>End8</i>, it will automatically set <i>n8-35 = 0</i> [<i>Pull-in</i>]. Do not change the settings unless necessary.</p>
End9	Initial Pole Detection Alarm	The drive cannot calculate the correct value for <i>n8-84</i> [ <i>Polarity Detection Current</i> ] during High Frequency Injection Tuning.	<p>When <i>n8-35 = 1</i> [<i>Initial Pole Detection Method = High Frequency Injection</i>], make sure that the motor does not rotate in reverse at start.</p> <p><b>Note:</b> If the drive detects <i>End9</i>, it will automatically set <i>n8-35 = 0</i> [<i>Pull-in</i>]. Do not change the settings unless necessary.</p>
Er-01	Motor Data Error	The motor nameplate data entered during Auto-Tuning is incorrect.	<ul style="list-style-type: none"> <li>Make sure that the motor nameplate data is correct.</li> <li>Do Auto-Tuning again and correctly set the motor nameplate data.</li> </ul>
Er-02	Drive in an Alarm State	The motor nameplate data entered during Auto-Tuning is incorrect.	<ul style="list-style-type: none"> <li>Make sure that the motor nameplate data entered in Auto-Tuning is correct.</li> <li>Do Auto-Tuning again and correctly set the motor nameplate data.</li> </ul>
Er-03	STOP Button was Pressed	During Auto-Tuning,  was pushed.	Auto-Tuning did not complete correctly. Do Auto-Tuning again.
Er-04	Line-to-Line Resistance Error	The Auto-Tuning results were not in the applicable parameter setting range.	<ul style="list-style-type: none"> <li>Examine and repair motor wiring.</li> <li>Disconnect the machine from the motor and do Rotational Auto-Tuning again.</li> </ul>
Er-05	No-Load Current Error	The Auto-Tuning results were not in the applicable parameter setting range.	<ul style="list-style-type: none"> <li>Examine and repair motor wiring.</li> <li>Disconnect the machine from the motor and do Rotational Auto-Tuning again.</li> </ul>
Er-08	Rated Slip Error	The motor nameplate data entered during Auto-Tuning is incorrect.	<ul style="list-style-type: none"> <li>Make sure that the input motor nameplate data is correct.</li> <li>Do Auto-Tuning again and correctly set the motor nameplate data.</li> </ul>
Er-09	Acceleration Error	The motor did not accelerate for the specified acceleration time.	<ol style="list-style-type: none"> <li>Increase the value set in <i>C1-01</i> [<i>Acceleration Time 1</i>].</li> <li>Disconnect the machine from the motor and do Rotational Auto-Tuning again.</li> </ol>
Er-12	Current Detection Error	There is a phase loss in the drive input power. ( <i>U/T1</i> , <i>V/T2</i> , <i>W/T3</i> )	Examine and repair motor wiring.
Er-13	Leakage Inductance Error	The motor rated current value is incorrect.	Correctly set the rated current indicated on the motor nameplate and do Auto-Tuning again.

Code	Name	Causes	Possible Solutions
Er-18	Back EMF Error	The result of the induced voltage tuning was not in the applicable range.	<ol style="list-style-type: none"> <li>1. Make sure that the input motor nameplate data is correct.</li> <li>2. Do Auto-Tuning again and correctly set the motor nameplate data.</li> </ol>
Er-19	PM Inductance Error	The Auto-Tuning results of the PM motor inductance were not in the applicable range.	<ol style="list-style-type: none"> <li>1. Make sure that the input motor nameplate data is correct.</li> <li>2. Do Auto-Tuning again and correctly set the motor nameplate data.</li> </ol>
Er-20	Stator Resistance Error	The Auto-Tuning results of the PM Motor Stator Resistance were not in the applicable range.	<ol style="list-style-type: none"> <li>1. Make sure that the input motor nameplate data is correct.</li> <li>2. Do Auto-Tuning again and correctly set the motor nameplate data.</li> </ol>
Er-25	HighFreq Inject Param Tuning Err	The motor data is incorrect.	Do Stationary Auto-Tuning again. <b>Note:</b> If the drive detects <i>Er-25</i> after you do Stationary Auto-Tuning, it is possible that the motor cannot use high frequency injection. For more information, contact Yaskawa or your nearest sales representative.

## ◆ Backup Function Operating Mode Display and Errors

### ■ Operating Mode Display

When you use the backup function from the keypad, the keypad will show messages related to the current operation. These messages will not identify errors in the drive operation.

Keypad Display	Name	Display	State
Drive and Keypad mismatch. Should the parameters be restored?	Detection of inconsistency between the drive and keypad	Normally displayed	The drive detected the connection of a keypad from a different drive. Select [Yes] to copy parameters backed up in the keypad to the connected drive.
Restore Restore from keypad	Restoring parameters	Flashing	The parameters stored in the keypad have been restored to the drive.
End	Backup/restore/verify operation ended normally	Normally displayed	The parameter backup, restore, or verify operation ended normally.
Backup Backup from Drive	Backing up parameters	Flashing	The parameters stored in the drive are being backed up to the keypad.
Verify Keypad & Drive	Verifying parameters	Flashing	The parameter settings stored in the keypad and the parameter settings in the drive align or are being compared.

### ■ Backup Function Runtime Errors

When an error occurs, the keypad shows a code to identify the error.

The table in this section shows the error codes. Refer to this table to remove the cause of the errors.

**Note:**

Push any key on the keypad to clear an error.

Code	Name	Causes	Possible Solutions
CPEr	Control Mode Mismatch	The keypad setting and drive setting for <i>A1-02 [Control Method Selection]</i> do not agree.	<ol style="list-style-type: none"> <li>1. Set <i>A1-02</i> on the drive to the same value that is on the keypad.</li> <li>2. Restore the parameters.</li> </ol>
CPyE	Error Writing Data	Parameter restore did not end correctly.	Restore the parameters.
CSEr	Control Mode Mismatch	The keypad is broken.	Replace the keypad.
dFPS	Drive Model Mismatch	You tried to restore parameters to a different drive model than the one that you backed up.	<ol style="list-style-type: none"> <li>1. Examine the drive model that you used to back up the parameters.</li> <li>2. Restore the parameters.</li> </ol>
iFEr	Keypad Communication Error	There was a communications error between the keypad and the drive.	Examine the connector or cable connection.
ndAT	Error Received Data	The parameter settings for model and specifications (power supply voltage and capacity) are different between the keypad and the drive.	<ol style="list-style-type: none"> <li>1. Make sure that drive model and the value set in <i>o2-04 [Drive Model (KVA) Selection]</i> agree.</li> <li>2. Restore the parameters.</li> </ol>
		The parameters are not stored in the keypad.	<ol style="list-style-type: none"> <li>1. Connect a keypad that has the correct parameters.</li> <li>2. Restore the parameters.</li> </ol>

Code	Name	Causes	Possible Solutions
rdEr	Error Reading Data	You tried to back up the data when <i>o3-02 = 0 [Copy Allowed Selection = Disabled]</i> .	Set <i>o3-02 = 1 [Enabled]</i> and back up again.
vAEr	Voltage Class, Capacity Mismatch	The power supply specifications or drive capacity parameter settings are different between the keypad and the drive.	<ol style="list-style-type: none"> <li>1. Make sure that drive model and the value set in <i>o2-04 [Drive Model (KVA) Selection]</i> agree.</li> <li>2. Restore the parameters.</li> </ol>
vFyE	Parameters do not Match	The parameters that are backed up in the keypad and the parameters in the drive are not the same.	<ol style="list-style-type: none"> <li>1. Restore or backup the parameter again.</li> <li>2. Verify the parameters.</li> </ol>

---

## Revision History

Date of Publication	Revision Number	Section	Revised Content
October 2022	2	18	Addition: Seismic Standards
August 2022	1	All	Revision: Reviewed and corrected entire documentation. Addition: Upgraded drive software version to PRG: 01012.
		-	Format revision: Changed the design of front cover and back cover. LED labels for SI-P3, SI-S3, and SI-N3 communication options are packaged with this manual.
May 2021	-	-	First Edition



# YASKAWA

## FP605 DRIVE INSTALLATION & PRIMARY OPERATION

### YASKAWA AMERICA, INC.

2121, Norman Drive South, Waukegan, IL  
60085, U.S.A.  
+1-800-YASKAWA (927-5292)  
[www.yaskawa.com](http://www.yaskawa.com)

### DRIVE CENTER (INVERTER PLANT)

2-13-1, Nishimiyaichi, Yukuhashi, Fukuoka,  
824-8511, Japan  
Phone: +81-930-25-2548  
[www.yaskawa.co.jp](http://www.yaskawa.co.jp)

### YASKAWA EUROPE GmbH

Hauptstraße 185, 65760 Eschborn, Germany  
Phone: +49-6196-569-300  
E-mail: [support@yaskawa.eu.com](mailto:support@yaskawa.eu.com)  
[www.yaskawa.eu.com](http://www.yaskawa.eu.com)

### YASKAWA ELÉTRICO DO BRASIL LTDA.

777, Avenida Piraporinha, Diadema, São  
Paulo, 09950-000, Brasil  
Phone: +55-11-3585-1100  
[www.yaskawa.com.br](http://www.yaskawa.com.br)

In the event that the end user of this product is to be the military and said product is to be employed in any weapons systems or the manufacture thereof, the export will fall under the relevant regulations as stipulated in the Foreign Exchange and Foreign Trade Regulations. Therefore, be sure to follow all procedures and submit all relevant documentation according to any and all rules, regulations and laws that may apply.

Specifications are subject to change without notice for ongoing product modifications and improvements.

Original instructions.

© 2021 YASKAWA Electric Corporation

YASKAWA ELECTRIC CORPORATION

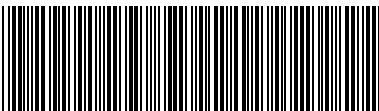

\*TOEPC7106171G\*

TOEPC7106171G  
Revision: C <2>-0  
October 2022  
Published in Japan  
22-3-23\_YAI