

\*TOEPC71061781\*

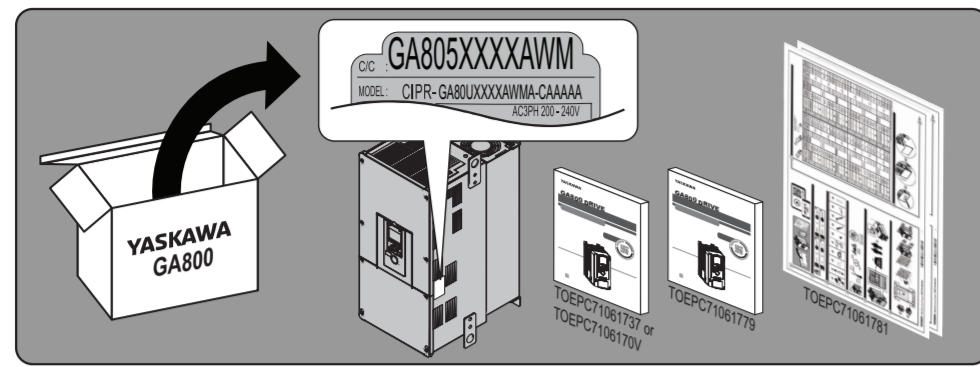

**1 Confirm the Drive and Motor Specifications**

VOLTS ≥ VOLTS    AMPS ≥ AMPS

HP ≥ HP    HERTZ ≥ HERTZ

**2 Collect the Required Tools and Equipment**

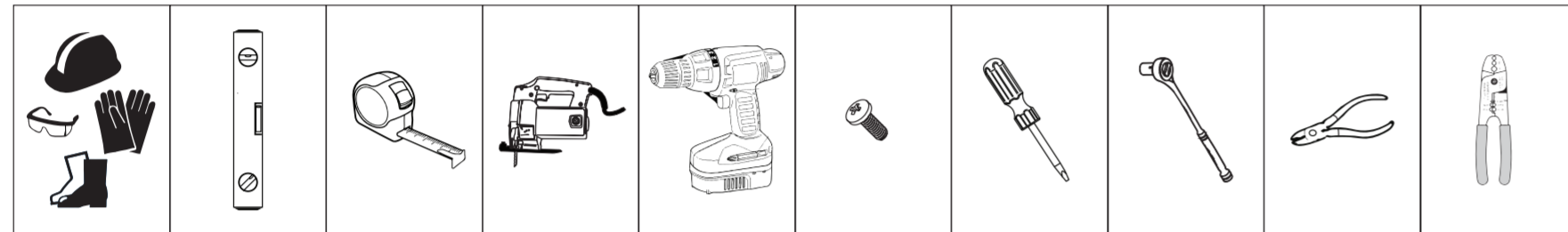

**3 Confirm the Correct Drive Installation Environment**

\*Refer to the drive manual for installations exceeding these conditions.

**4 Correctly Lift the Drive**

**5 Cut an Opening and Install the Drive**

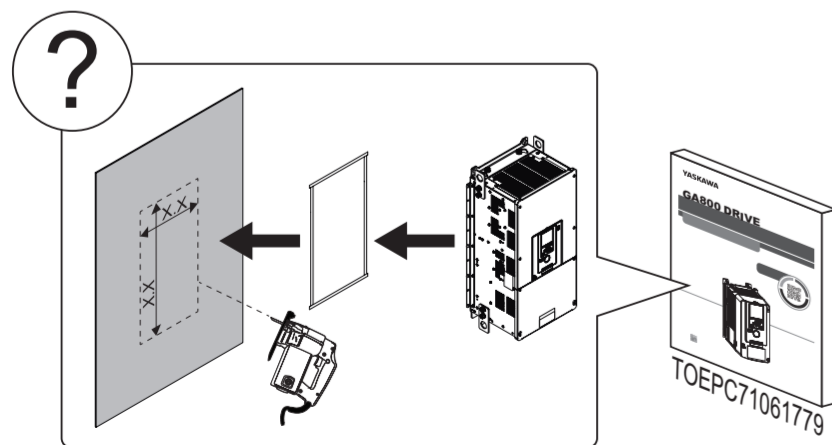

**6 Select the Correct Branch Circuit Protection, Wires, and Wire Strip Length, and Tightening Torque**

**Factory-Recommended Wires and Crimp Terminals:** Use UL-Listed, vinyl-coated insulated copper wires for operation with a continuous maximum permitted temperature of 75 °C at 600 V. Use UL-Listed closed-loop crimp terminals to maintain compliance with UL 508C. Use the tools recommended by Panduit Corp. to crimp the closed-loop crimp terminals. To comply with UL standards, use only insulated crimp terminals or crimp terminals with heat-shrinkable tubing.

**UL Compliance:** Install one of these types of short circuit protection devices to comply with UL 508C. Semiconductor protective type fuses are recommended, but the table also shows alternative short circuit protection devices. When you use MCCBs, RK1, or RK5 fuses as UL listed drive protection devices, you must mount the drive in a ventilated enclosure according to the minimum enclosure volume specified in this document.

**Molded Case Circuit Breaker (MCCB) and Non-Semiconductor Fuse Ratings:** Maximum MCCB rating is 200% of the Normal-Duty drive full load output amp (FLA) rating. Maximum CC, J, T, RK1, or RK5 fuse rating is 175% of the Normal-Duty drive full load output amp (FLA) rating. When you use MCCBs, Yaskawa recommends the current-limiting type.

**Short Circuit Current Rating (SCCR):** The maximum SCCR provided by drive and fuse, or drive and MCCB combinations in this document, is 100,000 RMS symmetrical amps. Use the protection specified in this document to prepare the drive for use on a circuit capable of delivering not more than 100,000 RMS symmetrical amps and not more than 240 Vac (240 V models), 480 Vac (480 V models), and 600 Vac (600 V models) when there is a short circuit in the power supply.

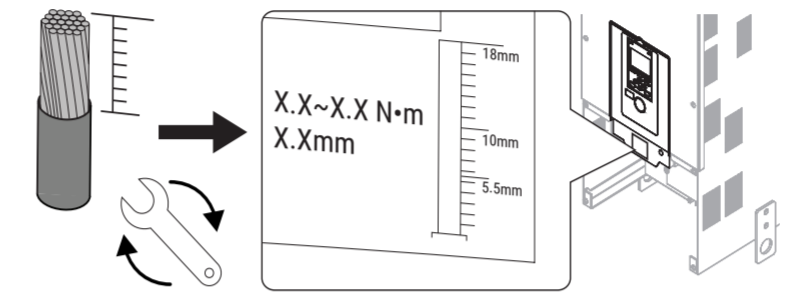

Model	R/L1 S/L2 T/L3		U/T1 V/T2 W/T3		- +1		+3		⊕	Semiconductor Fuse Manufacturer: Eaton/Bussmann or Mersen Part Number	Class CC, J, or T Fuse Maximum Size (Amps)	MCCB Maximum Size (Amps)	Class RK1 or RK5 Fuse Maximum Size (Amps)	Enclosure Volume Minimum Size (in³)	
	Wire AWG, kcmil **	Panduit Crimp Terminal Part Number **	Wire AWG, kcmil **	Panduit Crimp Terminal Part Number **	Wire AWG, kcmil **	Panduit Crimp Terminal Part Number **	Wire AWG, kcmil **	Panduit Crimp Terminal Part Number **							
<b>Three-Phase 200 V Class</b>															
2257	2/0 - 4/0 x 2P (2/0 x 2P)	S2/0-38R-X	2/0 - 4/0 x 2P (2/0 x 2P)	S2/0-38R-X	4/0 - 250 x 2P (4/0 x 2P)	S4/0-38R-5	1/0 x 2P (1/0 x 2P)	S1/0-38R-X	3 - 350 (3)	S2-38R-X	FWH-600A **	400	500	400	14657
2313	2/0 - 4/0 x 2P (4/0 x 2P)	S4/0-38R-5	2/0 - 4/0 x 2P (3/0 x 2P)	S3/0-38R-5	4/0 - 250 x 2P (250 x 2P)	S250-38R-5	1/0 x 2P (1/0 x 2P)	S1/0-38R-X	2 - 350 (2)	S2-38R-X	FWH-700A or FWH-800A **	500	600	500	14657
2360	250 - 300 x 2P (250 x 2P)	S250-12R-5	250 - 300 x 2P (250 x 2P)	S250-12R-5	300 - 400 x 2P (350 x 2P)	LCA350-12-X or LCAX350-12-6	1/0 - 4/0 x 2P (3/0 x 2P)	S3/0-12R-5	1 - 350 (1)	S2-12R-X	FWH-800A or FWH-1000B **	600	700	600	52800
2415	250 - 300 x 2P (250 x 2P)	S250-12R-5	250 - 300 x 2P (300 x 2P)	LCA300-12-X or LCAX300-12-6	300 - 400 x 2P (350 x 2P)	LCA350-12-X or LCAX350-12-6	1/0 - 4/0 x 2P (3/0 x 2P)	S3/0-12R-5	1 - 350 (1)	S2-12R-X	FWH-1000B **	700	800	n/a	52800
<b>Three-Phase 400 V Class</b>															
4208	2/0 - 4/0 x 2P (1/0 x 2P)	S1/0-38R-X	2/0 - 4/0 x 2P (1/0 x 2P)	S1/0-38R-X	4/0 - 250 x 2P (3/0 x 2P)	S3/0-38R-5	1/0 x 2P (1/0 x 2P)	S1/0-38R-X	4 - 350 (4)	P4-38R-E or S4-38R-E	FWH-500A **	350	400	350	14657
4250	2/0 - 4/0 x 2P (2/0 x 2P)	S2/0-38R-X	2/0 - 4/0 x 2P (2/0 x 2P)	S2/0-38R-X	4/0 - 250 x 2P (3/0 x 2P)	S3/0-38R-5	1/0 x 2P (1/0 x 2P)	S1/0-38R-X	2 - 350 (2)	P2-38R-X or S2-38R-X	FWH-600A **	400	500	400	14657
4302	2/0 - 4/0 x 2P (3/0 x 2P)	S3/0-38R-5	2/0 - 4/0 x 2P (3/0 x 2P)	S3/0-38R-5	4/0 - 250 x 2P (4/0 x 2P)	S4/0-38R-5	1/0 x 2P (1/0 x 2P)	S1/0-38R-X	2 - 350 (2)	P2-38R-X or S2-38R-X	FWH-700A **	500	600	500	14657
4371	250 - 300 x 2P (250 x 2P)	S250-12R-5	250 - 300 x 2P (250 x 2P)	S250-12R-5	300 - 400 x 2P (350 x 2P)	LCA350-12-X or LCAX350-12-6	1 - 4/0 x 2P (3/0 x 2P)	S3/0-12R-5	1 - 350 (1)	S2-12R-X	FWH-800A	600	700	600	52800
4414	250 - 300 x 2P (300 x 2P)	LCA300-12-X or LCAX300-12-6	250 - 300 x 2P (300 x 2P)	LCA300-12-X or LCAX300-12-6	300 - 400 x 2P (400 x 2P)	LCA400-12-6	1 - 4/0 x 2P (4/0 x 2P)	S4/0-12R-5	1 - 350 (1)	S2-12R-X	FWH-800A or FWH-1000B	700	800	n/a	52800
4477	250 - 300 x 4P (250 x 4P)	S250-12R-5	250 - 300 x 4P (4/0 x 4P)	S4/0-12R-5	300 - 400 x 4P (4/0 x 4P)	S4/0-12R-5	4/0 x 4P (3/0 x 4P)	S3/0-12R-5	1/0 - 300 (1/0)	S1/0-12R-X	FWH-1000B or FWH-1200B	800	900	n/a	52800
4568	250 - 300 x 4P (250 x 4P)	S250-12R-5	250 - 300 x 4P (4/0 x 4P)	S4/0-12R-5	300 - 400 x 4P (300 x 4P)	LCA300-12-X or LCAX300-12-6	4/0 x 4P (3/0 x 4P)	S3/0-12R-5	2/0 - 300 (2/0)	S2/0-12R-X	FWH-1000B or FWH-1200B	900	1000	n/a	52800
4605	250 - 300 x 4P (300 x 4P)	LCA300-12-X or LCAX300-12-6	250 - 300 x 4P (300 x 4P)	LCA300-12-X or LCAX300-12-6	300 - 400 x 4P (400 x 4P)	LCA400-12-6	4/0 x 4P (4/0 x 4P)	S4/0-12R-5	2/0 - 300 (2/0)	S2/0-12R-X	FWH-1200B or FWH-1400A	1000	1200	n/a	52800
4720	250 - 300 x 4P (300 x 4P)	LCA300-12-X or LCAX300-12-6	250 - 300 x 4P (300 x 4P)	LCA300-12-X or LCAX300-12-6	300 - 400 x 4P (400 x 4P)	LCA400-12-6	4/0 x 4P (4/0 x 4P)	S4/0-12R-5	2/0 - 300 (2/0)	S2/0-12R-X	FWH-1200B or FWH-1400A	1200	1400	n/a	52800
<b>Three-Phase 600 V Class</b>															
5289	250 - 300 (2/0 x 2P)	S2/0-12R	250 - 300 (3/0 x 2P)	S3/0-12R	300 - 400 (4/0 x 2P)	S4/0-12R	1 - 4/0 (1/0 x 2P)	S1/0-12R	1 - 350 (1)	S2-12R	A070UD32L1400	n/a	n/a	n/a	n/a
5382	250 - 300 (4/0 x 2P)	S4/0-12R	250 - 300 (250 x 2P)	S250-12R	300 - 400 (350 x 2P)	LCA350-12	4/0 (3/0 x 2P)	S3/0-12R	1 - 300 (1)	S2-12R	FWP-600A	n/a	n/a	n/a	n/a
5412	250 - 300 (2/0 x 4P)	S2/0-12R	250 - 300 (2/0 x 4P)	S2/0-12R	300 - 400 (4/0 x 4P)	S4/0-12R	4/0 (1/0 x 4P)	S1/0-12R	1 - 300 (1)	S2-12R	FWP-600A	n/a	n/a	n/a	n/a
5472	250 - 300 (3/0 x 4P)	S3/0-12R	250 - 300 (3/0 x 4P)	S3/0-12R	300 - 400 (4/0 x 4P)	S4/0-12R	4/0 (1/0 x 4P)	S1/0-12R	1 - 300 (1/0)	S1/0-12R	FWP-700A	n/a	n/a	n/a	n/a

\*\* Values in bold parentheses are the recommended values.  
 \*\* For use with PANDUIT Corp. heat-shrinkable tubing HSTT series or an equivalent UL-recognized heat-shrinkable tubing rated 600 V minimum.  
 \*\* When you use semiconductor fuses for the drive with UL Type 1 Kit, install the drive in a supplemental enclosure. The UL Type 1 Kit does not support internal fuses for this drive model.

**7 Remove the Terminal Cover**      **8 Remove the Terminal Block Cover and Wiring Cover**

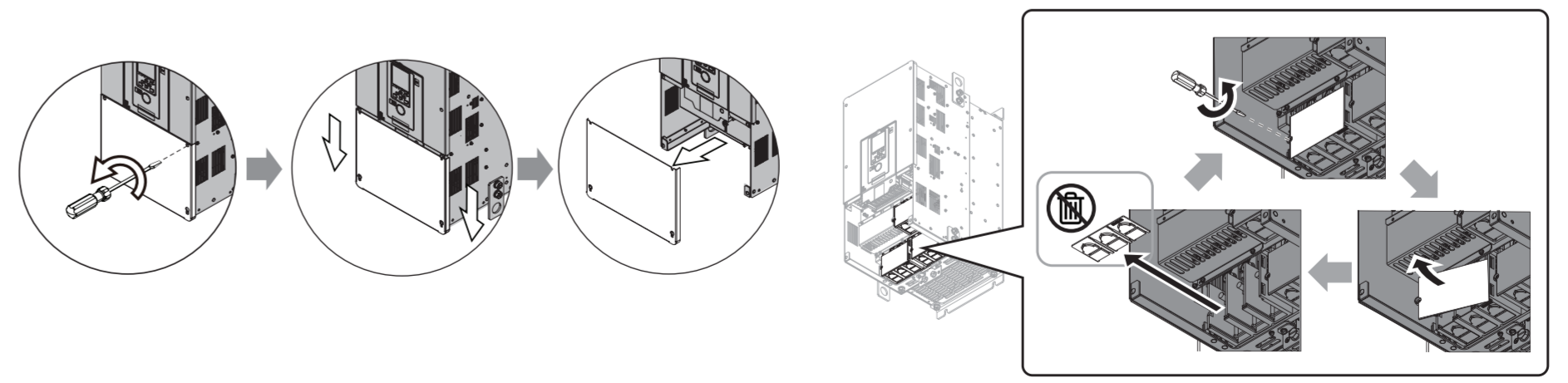



**9 Remove Terminal Block Nut to Attach Crimp Terminals**

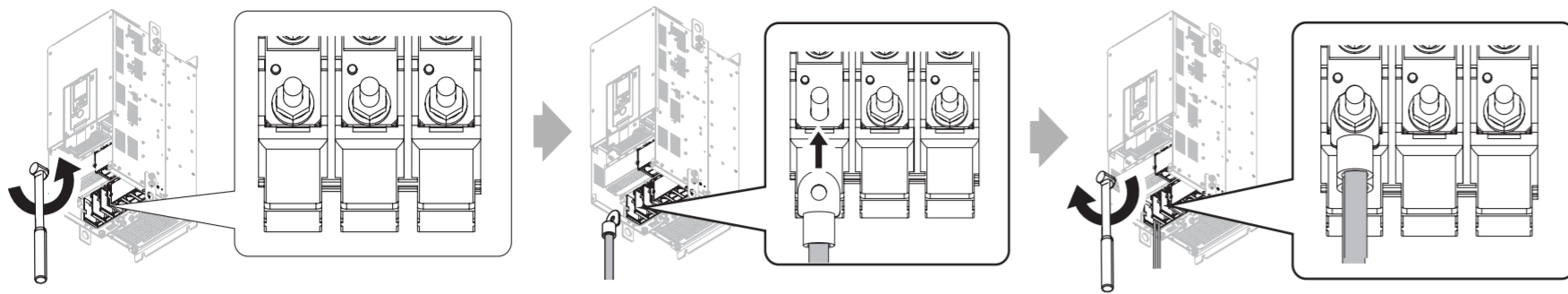

**10 Install the Motor Wiring**

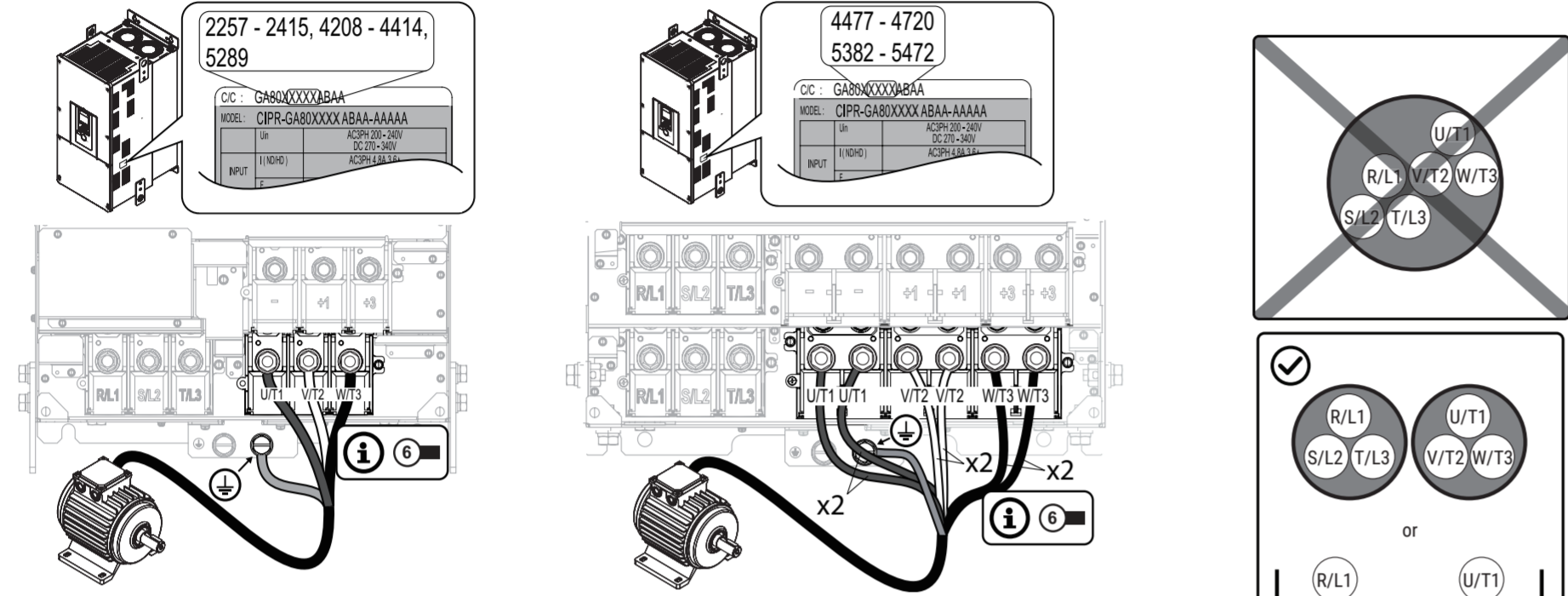

**11 Install the Power Wiring**

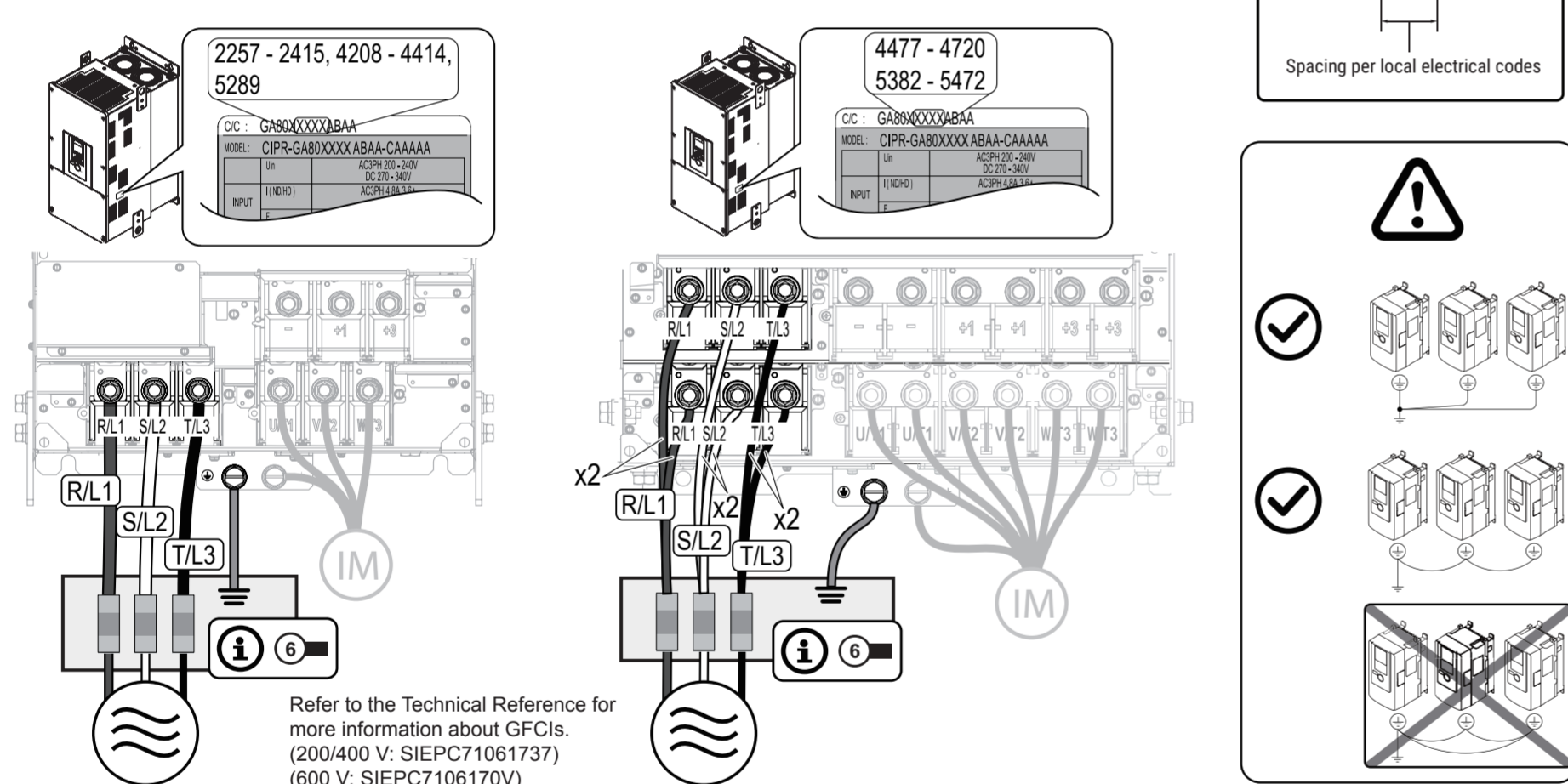

**12 Remove the Tabs and Install the Wiring Cover, Terminal Block Cover, and Terminal Cover**

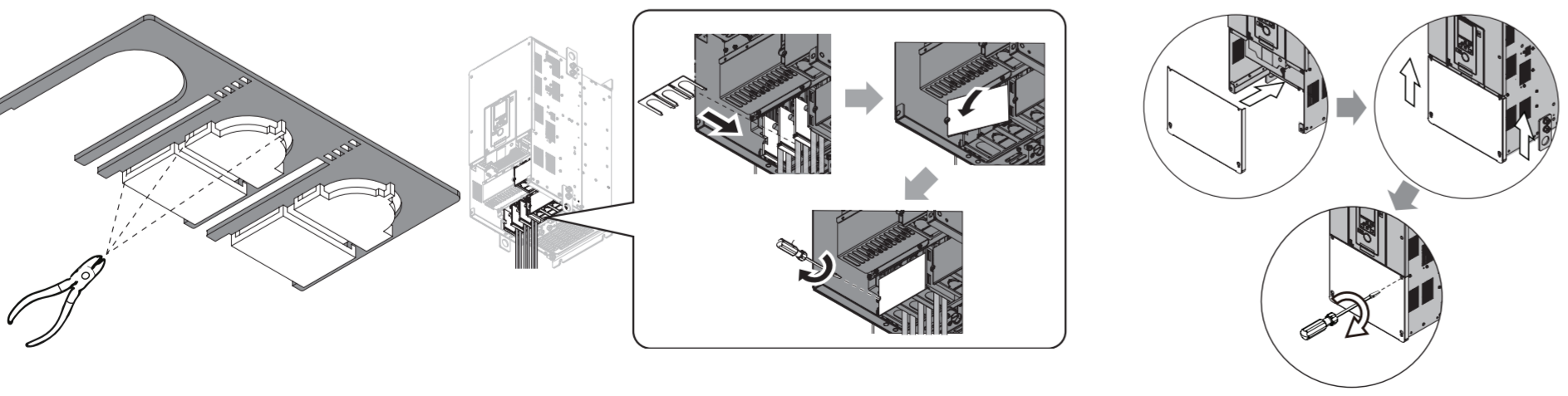

**13 Determine the Correct Auto-Tuning Method**

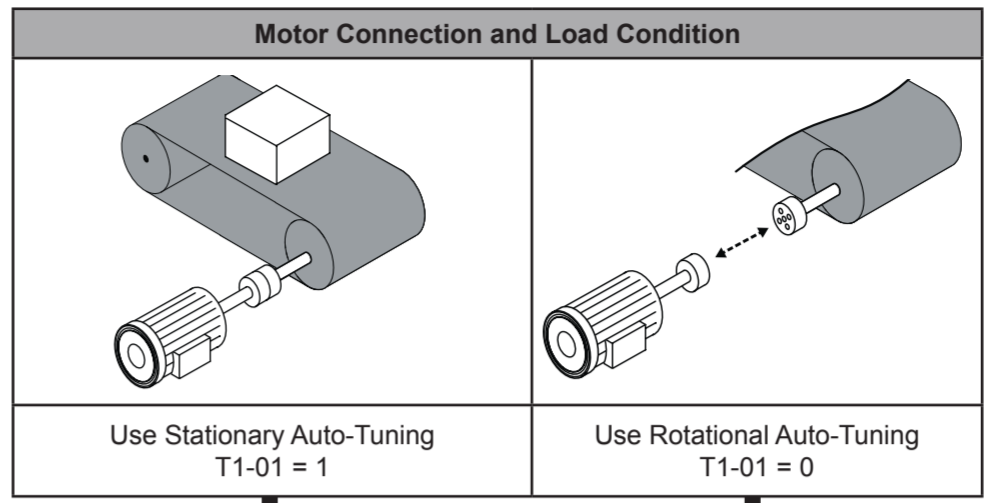

**14 Collect and Record Auto-Tuning Data from Motor Nameplate**

**3 PHASE INVERTER DUTY AC INDUCTION MOTOR NAMEPLATE EXAMPLE**

MODE E XX 123AAA123XX-X0 X FRAME 123AX  
 POLES X ENC XXX CODE X DES A TYPE ABC INS X0  
 VOLTS XXX B FL RPM XXXX C FL AMPS XX/XX  
 SF 1.0 DUTY CONT MAX XX TEMP. T-STATS  
 AMB °C N.L. AMPS G XX.X/X.X  
 SERIAL  
 MAX RPM 4200 S.E. BRG. 309 O.S.E. BRG. XXX ROTOR WK² X.X

Hz	HP	RPM	TORQUE (LB FT)	VOLTS (HIGH CONN)	AMPS (HIGH CONN)
60	XX	XXXX	XX.X	XXX	XX.X
120	XX	XXXX	XX.X	XXX	XX.X
OHMS PH.	R1: .XXX	R2: .XXX	X1: X.XX	X2: X.XX	XM: XX.X

P/N XXXXXXXX

Reference	Motor Nameplate Data	Motor Nameplate Value	T1-xx Parameter (Ex-xx Parameter *)
A	Motor Rated Power	(HP × 0.746) kW	T1-02 (E2-11)
B	Motor Rated Voltage	V	T1-03 (E1-05)
C	Motor Rated Current (FLA)	A	T1-04 (E2-01)
D	Motor Rated Frequency (Base Frequency)	Hz	T1-05 (E1-04/E1-06)
E	Motor Pole Count	-	T1-06 (E2-04)
F	Motor Rated RPM	RPM	T1-07
G	Motor No-Load Current *2	A	T1-09 (E2-03)
-	Motor Rated Slip *2 *3	0.000 Hz	T1-10 (E2-02)
-	Test Mode Selection *2	-	T1-12
-	Motor No-Load Voltage	V	T1-13

\*1 Auto-Tuning will automatically set the E1-xx and E2-xx parameters. You can manually adjust Ex-xx parameters after Auto-Tuning.  
 \*2 These values are only necessary for Stationary Auto-Tuning (T1-01 = 1).  
 \*3 If you do not know this value, leave at the default value of 0.000.

**15 Energize the Drive and Confirm It Is Ready**

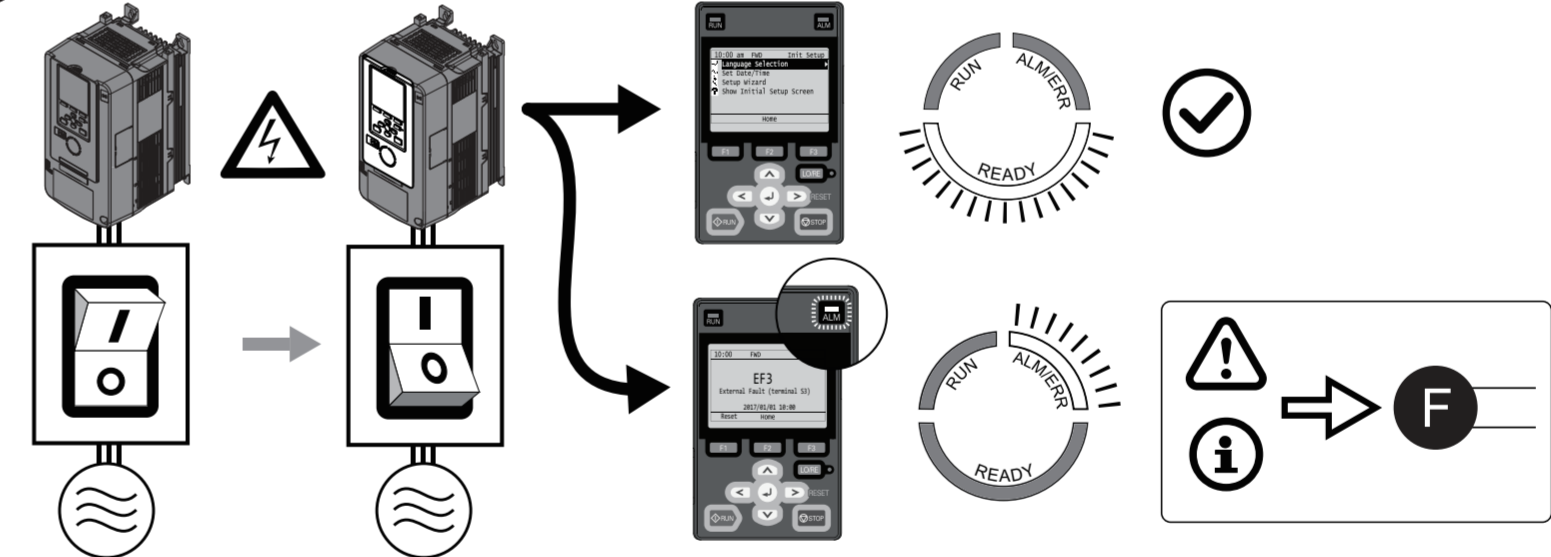

**16 Use Auto-Tuning Data from Motor Nameplate to Set Parameters and Auto-Tune the Drive**

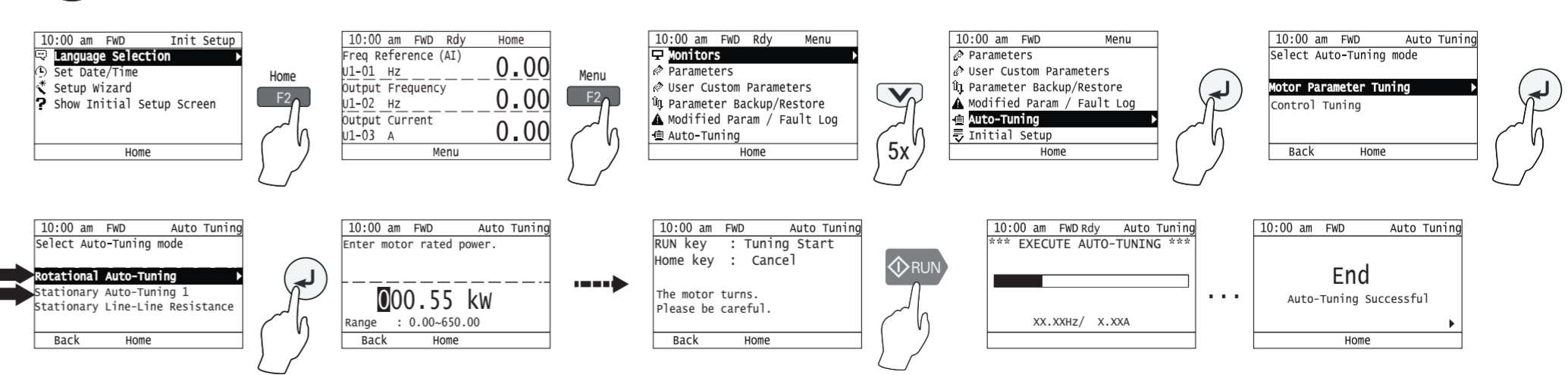



### 17 Set the Drive for LOCAL Control and Check the Motor Rotation Direction

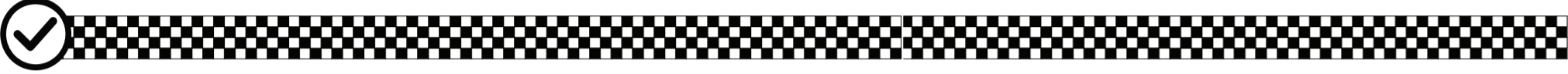
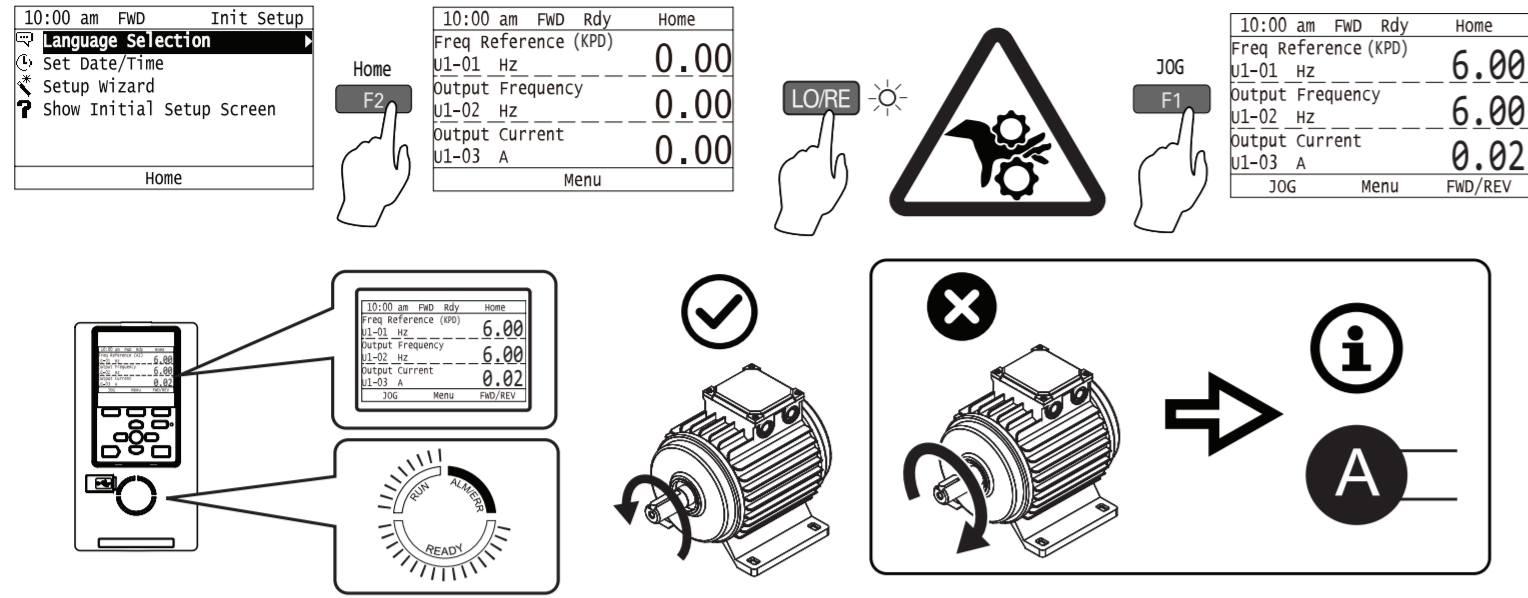

### A If the Motor Does Not Rotate in the Correct Direction

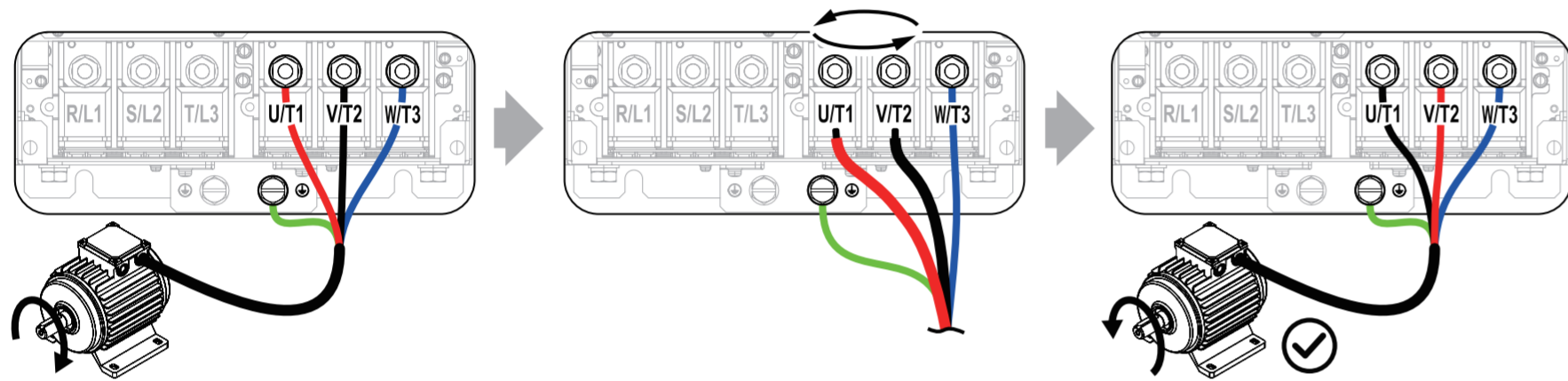

### B Control Circuit Configuration and Accessibility

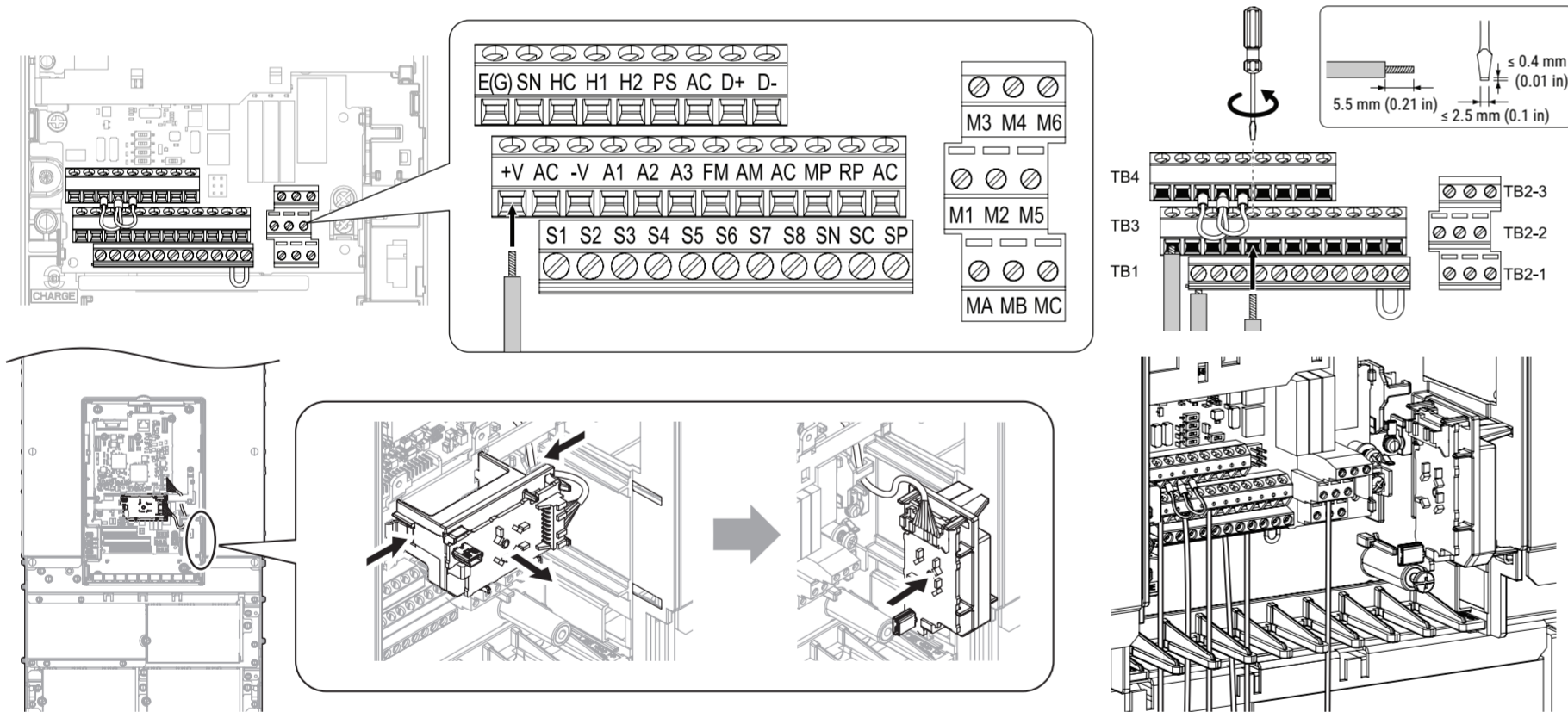

### C Switches and Jumpers on the Control Board

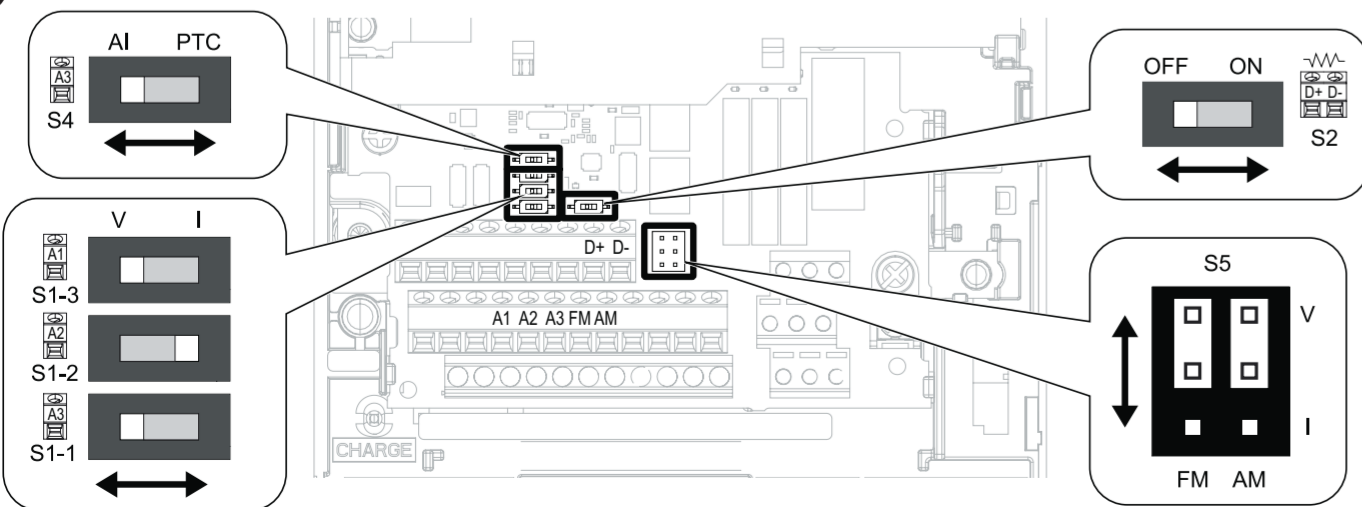

### D Connection Diagram and Terminal Functions

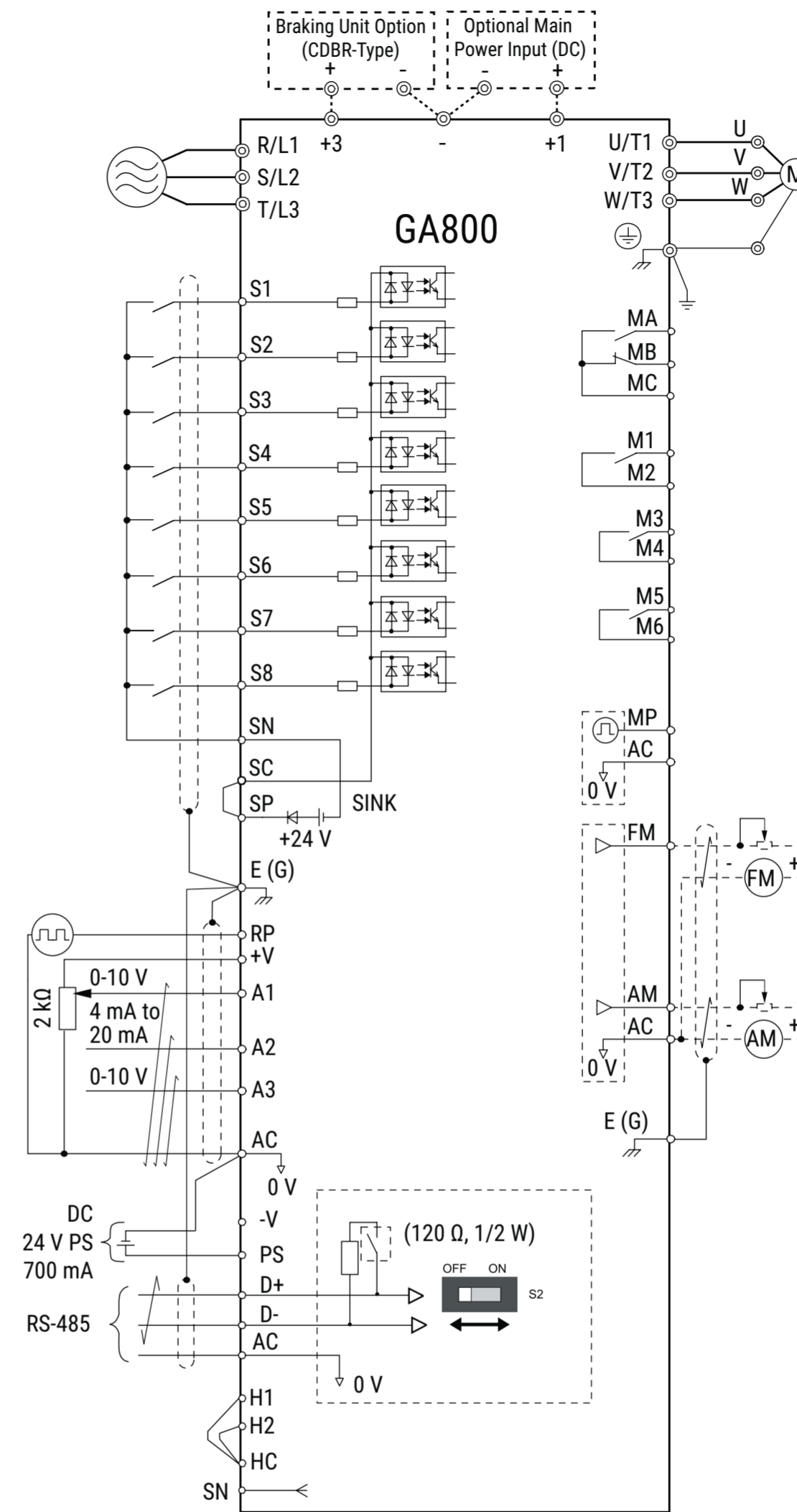





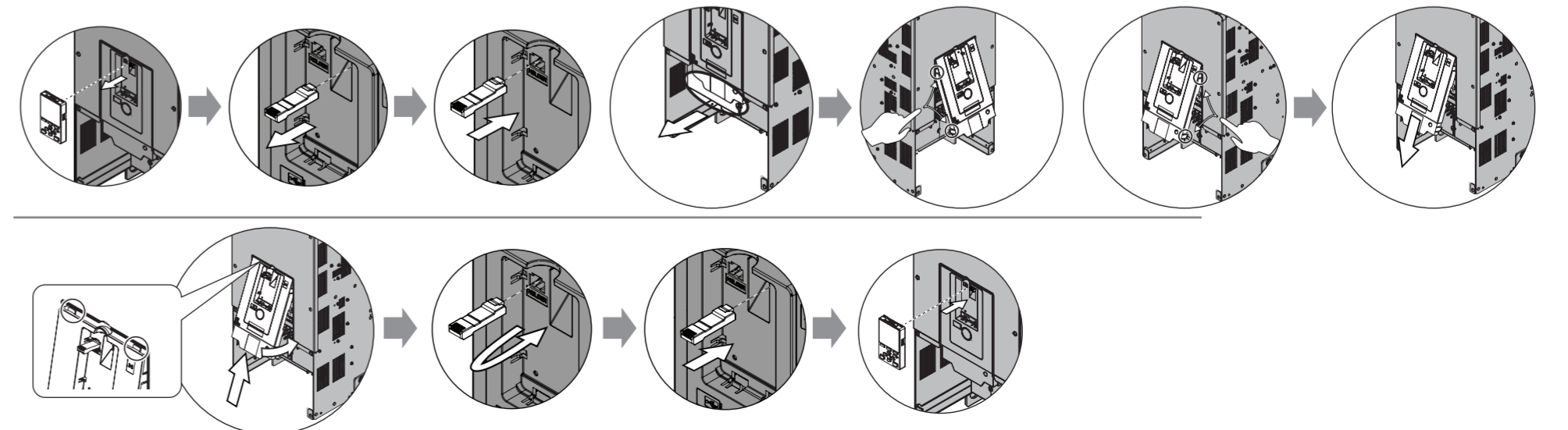

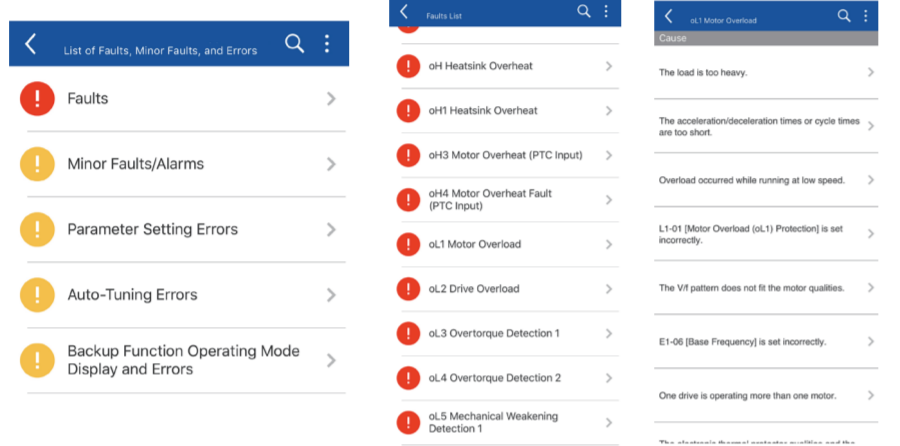

Terminal	Type	Signal Level	Default
S1	MFDI 1	Photocoupler 24 V, 6 mA	Forward run/Stop
S2	MFDI 2		Reverse run/Stop
S3	MFDI 3		External fault
S4	MFDI 4		Fault reset
S5	MFDI 5		Multi-step speed 1
S6	MFDI 6		Multi-step speed 2
S7	MFDI 7		Jog command
S8	MFDI 8		Baseblock command
SN	MFDI power 0 V		-
SC	MFDI common	24 V, 150 mA maximum	-
SP	MFDI power + 24 VDC		-
H1	Safe disable input 1	24 V, 6 mA Internal impedance: 4.7 kΩ Minimum OFF time: 2 ms	-
H2	Safe disable input 2		-
HC	Safe disable common		-
RP	Master frequency reference pulse train input	Response frequency: 0 ~ 32 kHz H level duty: 30 ~ 70% H level voltage: 3.5 ~ 13.2 V L level voltage: 0.0 ~ 0.8 V Input impedance: 3 kΩ	-
+V	Frequency setting power supply	10.5 V (20 mA maximum)	-
-V	Frequency setting power supply	-10.5 V (20 mA maximum)	-
A1	MFAI 1	-10 V ~ +10 V/-100% ~ +100% 0 V ~ 10 V/100% (input impedance 20 kΩ)	Master frequency reference
A2	MFAI 2	4 mA ~ 20 mA/100% 0 mA ~ 20 mA/100% (input impedance 250 Ω)	
A3	MFAI 3/PTC input	-10 V ~ +10 V/-100% ~ +100% 0 V ~ 10 V/100% (input impedance 20 kΩ) 4 mA ~ 20 mA/100% 0 mA ~ 20 mA/100% (input impedance 250 Ω) PTC input	Auxiliary frequency reference
AC	Common	0 V	-
E(G)	Connect shielded cable		-
MA	Fault relay out	30 VDC, 10 mA ~ 1 A 250 VAC, 10 mA ~ 1 A	Fault
MB	Fault relay out	Minimum load: 5 V, 10 mA	Fault
MC	Common		-
M1	MFDO	30 VDC, 10 mA ~ 1 A 250 VAC, 10 mA ~ 1 A Minimum load: 5 V, 10 mA	During run
M2	MFDO		Zero speed
M3	MFDO		Speed agree 1
M4	MFDO		
M5	MFDO		
M6	MFDO		
MP	Pulse train out	32 kHz maximum	Output frequency
FM	MFAO 1	0 V ~ +10 V/0% ~ 100% -10 V ~ +10 V/-100% ~ +100%	Output frequency
AM	MFAO 2	4 mA ~ 20 mA	Output current
AC	Common	0 V	-
PS	External 24 V PS input	21.6 VDC ~ 26.4 VDC, 700 mA	-
AC	External 24 V PS ground	0V	-
D+	Communication +	MEMOBUS/Modbus, RS-485	-
D-	Communication -	115.2 kbps maximum	-
AC	Common	0 V	-

### E How to Remove the Drive Front Cover



## F Troubleshooting Resources for Drive Faults and Alarms

Resource	Choose This When:	URL	QR Code for Download
Installation & Primary Operation	You have access to the paper copy of the manual that was packaged with the drive. This manual lists all drive faults and alarms, and offers a selection of causes and solutions. 	200/400 V Class: <a href="https://www.yaskawa.com/toepc71061737">https://www.yaskawa.com/toepc71061737</a>	
DriveWizard Mobile App	You want to use your smartphone or tablet and use the embedded help to look up the full complement of causes and solutions to all drive faults and alarms. 	<a href="https://www.yaskawa.com/dwm">https://www.yaskawa.com/dwm</a>	  App download
200/400 V Class: Maintenance & Troubleshooting Manual	You want to download a PDF of the manual to your smartphone or tablet. This manual lists the full complement of causes and solutions to all drive faults and alarms and also includes detailed information about drive maintenance, wiring, and programming. 	<a href="https://www.yaskawa.com/toepyaiga8001">https://www.yaskawa.com/toepyaiga8001</a>	
600 V Class: Technical Reference		<a href="https://www.yaskawa.com/siepc7106170v">https://www.yaskawa.com/siepc7106170v</a>	

## I Parameter Groups

A: Initialization	d: Reference Settings	F: Options	L: Protection Functions	o: Keypad-Related Settings
A1 Initialization	d1 Frequency Reference	F1 PG Option Setup (Encoder)	L1 Motor Protection	o1 Keypad Display
A2 User Parameters	d2 Reference Limits	F2 Analog Input Option	L2 Power Loss Ride Through	o2 Keypad Operation
b: Application		F3 Digital Input Option	L3 Stall Prevention	o3 Copy Keypad Function
b1 Operation Mode Selection	d3 Jump Frequency	F4 Analog Output Option	L4 Speed Detection	o4 Maintenance Monitors
b2 DC Injection Braking and Short Circuit Braking	d4 Freq. Ref. Up/Down & Hold	F5 Digital Output Option	L5 Fault Restart	o5 Log Function
b3 Speed Search	d5 Torque Control	F6 Communication Option	L6 Torque Detection	q: DriveWorksEZ Parameters
b4 Timer Function	d6 Field Weakening/Forcing	F7 Ethernet Options	L7 Torque Limit	r: DriveWorksEZ Connections
b5 PID Control	d7 Offset Frequency	H: Terminal Functions		T: Motor Tuning
b6 Dwell Function	E: Motor		L8 Drive Protection	U: Monitors
b7 Droop Control	E1 V/f Pattern for Motor 1	H1 Digital Inputs	L9 Drive Protection 2	U1 Operation Status Monitors
b8 Energy Saving	E2 Motor 1 Parameters	H2 Digital Outputs	n: Special Adjustment	
b9 Zero Servo	E3 V/f Pattern for Motor 2	H3 Analog Inputs	n1 Hunting Prevention	U2 Fault Trace
C: Tuning		H4 Analog Outputs	n2 Auto Freq. Regulator (AFR)	U3 Fault History
C1 Accel & Decel Time	E4 Motor 2 Parameters	H5 Modbus Communication	n3 High Slip/Overexcite Braking	U4 Maintenance Monitors
C2 S-Curve Characteristics	E5 PM Motor Settings	H6 Pulse Train Input/Output	n4 AOLV Tuning	U5 PID Monitors
C3 Slip Compensation	E9 Motor Setting	H7 Virtual Inputs/Outputs	n5 Feed Forward Control	U6 Operation Status Monitors
C4 Torque Compensation			n6 Online Tuning	U8 DriveWorksEZ Monitors
C5 Auto Speed Regulator (CSR)			n7 EZ Drive	
C6 Duty & Carrier Frequency			n8 PM Motor Control Tuning	

## J If You Push the Run Button but the Motor Does Not Spin

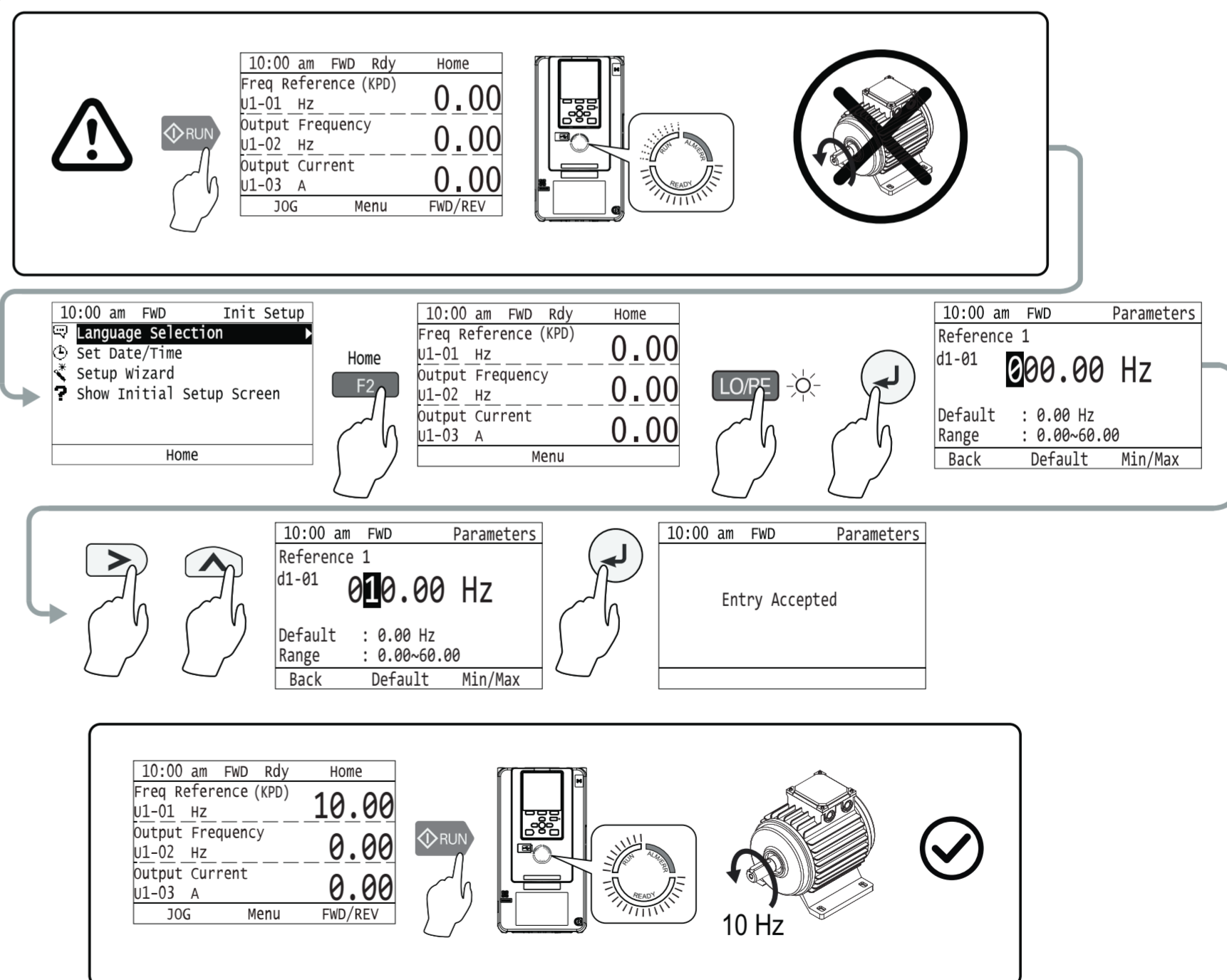

The flowchart starts with a warning icon and a 'RUN' button. The first screen shows the drive status: 10:00 am FWD Rdy Home, Freq Reference (KPD) 0.00 Hz, Output Frequency 0.00 Hz, Output Current 0.00 A. A 'LOPE' (Low Output Power) error is indicated. The user presses the 'F2' button to enter the 'Init Setup' menu, then 'Language Selection'. The next screen shows 'Parameters' with 'Reference 1 d1-01' set to 000.00 Hz. The user presses the 'F2' button to confirm the value. The final screen shows 'Entry Accepted' and the drive status changes to '10 Hz', indicating the motor is now spinning.

## G Additional Resources

Download on the **App Store** | GET IT ON **Google Play**

**Mobile App**  
  
DriveWizard® Mobile Commissioning Smartphone App  
<https://www.yaskawa.com/dwm>

**Product Manuals**  
  
•PDFs  
•Online HTML5-Searchable  
•Manuals App  
<https://www.yaskawa.com/ga800manuals>

## H Customer Feedback

Comments or questions about this document? Fill out our online form:  

or  
Email us: [technical\\_documentation@yaskawa.com](mailto:technical_documentation@yaskawa.com)  
Call us: 1-800-YASKAWA (927-5292)  
[www.yaskawa.com/DRV-F-0006](https://www.yaskawa.com/DRV-F-0006)

Please consider following us on social media:

**YouTube** [www.youtube.com/yaskawayea](http://www.youtube.com/yaskawayea)  
**LinkedIn** [www.linkedin.com/company/18822](http://www.linkedin.com/company/18822)  
**Twitter** [www.twitter.com/yaskawa](http://www.twitter.com/yaskawa)

**Headquarters Address:**  
**YASKAWA AMERICA, INC.**  
2121 Norman Drive South  
Waukegan, IL 60085  
USA