

YASKAWA

GA500 DRIVE

PROGRAMMING

INDUSTRIAL AC MICRODRIVE

CATALOG CODE:

GA50Uxxxxxxxx

CAPACITIES:

240 V Single-Phase Input: 1/6 to 5 HP

240 V Three-Phase Input: 1/6 to 30 HP

480 V Three-Phase Input: 1/2 to 40 HP

PDF

yaskawa.com/TOEPAIGA5002

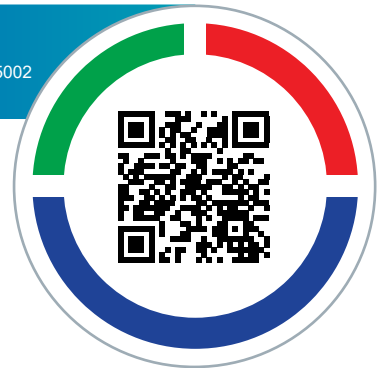

Simplify Drive Installation
Get DriveWizard® Mobile



<https://www.yaskawa.com/dwm>

DOCUMENT NUMBER: TOEPAIGA5002

This Page Intentionally Blank

Table of Contents

i.	Preface and General Precautions	9
i.1	Receiving	10
	Glossary	10
	About Registered Trademarks	10
i.2	Using the Product Safely	11
	Explanation of Signal Words	11
	Section Safety	11
	Warning Label Content and Location	13
i.3	Warranty Information	14
	Exclusion of Liability	14
1.	Parameter List	15
1.1	Section Safety	16
1.2	How to Read the Parameter List	17
	Icons and Terms that Identify Parameters and Control Modes	17
1.3	Parameter Groups	18
1.4	A: Initialization Parameters	19
	A1: Initialization	19
	A2: User Parameters	20
1.5	b: Application	22
	b1: Operation Mode Selection	22
	b2: DC Injection Braking and Short Circuit Braking	23
	b3: Speed Search	23
	b4: Timer Function	25
	b5: PID control	26
	b6: Dwell Function	30
	b8: Energy Saving	30
1.6	C: Tuning	32
	C1: Accel & Decel Time	32
	C2: S-Curve Characteristics	32
	C3: Slip Compensation	33
	C4: Torque Compensation	34
	C5: Automatic Speed Regulator (ASR: Automatic Speed Regulator)	34
	C6: Duty & Carrier Frequency	35
1.7	d: Reference Settings	37
	d1: Frequency Reference	37
	d2: Reference Limits	38
	d3: Jump Frequency	39
	d4: Frequency Ref Up/Down & Hold	39

	d6: Field Weakening /Forcing	40
	d7: Offset Frequency	40
1.8	E: Motor Parameters	41
	E1: V/f Pattern for Motor 1	41
	E2: Motor Parameters	42
	E3: V/f Pattern for Motor 2	42
	E4: Motor 2 Parameters	43
	E5: PM Motor Settings	44
	E9: Motor Setting	44
1.9	F: Options	46
	F1: Fault Detection in PG Speed Control	46
	F6: Communication Options	47
	F7: Communication Options	51
1.10	H: Terminal Functions	56
	H1: Digital Inputs	56
	H2: Digital Outputs	64
	H3: Analog Inputs	74
	H4: Analog Outputs	77
	H5: Modbus Communication	77
	H6: Pulse Train Input/Output	79
	H7: Virtual MFIO Selection	79
1.11	L: Protection Functions	81
	L1: Motor Protection	81
	L2: Power Loss Ride Through	82
	L3: Stall Prevention	83
	L4: Speed Detection	85
	L5: Fault Restart	85
	L6: Torque Detection	87
	L7: Torque Limit	88
	L8: Drive Protection	88
1.12	n: Special Adjustment	91
	n1: Hunting Prevention	91
	n2: Auto Freq Regulator (AFR)	91
	n3: High Slip/Overexcite Braking	91
	n5: Feed Forward Control	92
	n6: Online Tuning	92
	n7: EZ Drive	93
	n8: PM Motor Control Tuning	93
	nA: PM Motor Control Tuning	97
1.13	o: Keypad-Related Settings	98
	o1: Keypad Display	98
	o2: Keypad Operation	100
	o3: Copy Keypad Function	101
	o4: Maintenance Monitors	102
	o5: Log Function	103
1.14	q: DriveWorksEZ Parameters	104
	q1-01 to qx-xx: Reserved for DriveWorksEZ	104
1.15	r: DWEZ Connection 1-20	105
	r1-01 to r1-40: DriveWorksEZ Connection Parameters 1 to 20 (Upper / Lower)	105
1.16	T: Motor Tuning	106
	T0: Tuning Mode Selection	106
	T1: Induction Motor Auto-Tuning	106

	T2: PM Motor Auto-Tuning	107
	T3: ASR and Inertia Tuning	108
	T4: EZ Tuning	108
1.17	U: Monitors	109
	U1: Operation Status Monitors	109
	U2: Fault Trace	111
	U3: Fault History	113
	U4: Maintenance Monitors	115
	U5: PID Monitors	118
	U6: Operation Status Monitors	119
	U8: DriveWorksEZ Monitors	121
1.18	Parameters that Change from the Default Settings with A1-02 [Control Method Selection]	124
1.19	Parameters that Change from the Default Settings with E3-01 [Motor 2 Control Mode Selection]	128
1.20	Parameters Changed by E1-03 [V/f Pattern Selection]	129
1.21	Defaults by Drive Model and Duty Rating ND/HD	130
	Single-Phase 200 V Class	130
	Three-Phase 200 V Class	133
	Three-Phase 400 V Class	137
2.	Parameter Details	143
2.1	Section Safety	144
2.2	A: Initialization Parameters	145
	A1: Initialization	145
	A2: User Parameters	155
2.3	b: Application	157
	b1: Operation Mode Selection	157
	b2: DC Injection Braking and Short Circuit Braking	167
	b3: Speed Search	170
	b4: Timer Function	179
	b5: PID control	181
	b6: Dwell Function	197
	b8: Energy Saving	198
2.4	C: Tuning	203
	C1: Accel & Decel Time	203
	C2: S-Curve Characteristics	209
	C3: Slip Compensation	209
	C4: Torque Compensation	213
	C5: Auto Speed Regulator (ASR)	215
	C6: Duty & Carrier Frequency	220
2.5	d: References	225
	d1: Frequency Reference	225
	d2: Reference Limits	231
	d3: Jump Frequency	232
	d4: Frequency Ref Up/Down & Hold	233
	d6: Field Weakening /Forcing	238
	d7: Offset Frequency	239
2.6	E: Motor Parameters	241
	E1: V/f Pattern for Motor 1	241
	E2: Motor Parameters	249
	E3: V/f Pattern for Motor 2	252

	E4: Motor 2 Parameters	254
	E5: PM Motor Settings	256
	E9: Motor Setting	259
2.7	F: Options	262
	F1: Fault Detection in PG Speed Control	262
	F6, F7: Communication Options	264
2.8	H: Terminal Function Selection	287
	H1: Digital Inputs	287
	MFDI Setting Values	291
	H2: Digital Outputs	309
	H2 MFDO Parameters	312
	MFDO Setting Values	318
	H3: Analog Inputs	332
	H3: MFAI Parameters	334
	Multi-Function Analog Input Terminal Settings	337
	H4: Analog Outputs	343
	H5: Memobus/Modbus Communication	345
	H6: Pulse Train Input/Output	349
	H7: Virtual MFIO Selection	352
2.9	L: Protection Functions	357
	L1: Motor Protection	357
	L2: Power Loss Ride Through	364
	L3: Stall Prevention	374
	L4: Speed Detection	384
	L5: Fault Restart	386
	L6: Torque Detection	389
	L7: Torque Limit	394
	L8: Drive Protection	397
2.10	n: Special Adjustment	405
	n1: Hunting Prevention	405
	n2: Auto Freq Regulator (AFR)	406
	n3: High Slip Braking (HSB) and Overexcitation Braking	407
	n5: Feed Forward Control	411
	n6: Online Tuning	413
	n7: EZ Drive	414
	n8: PM Motor Control Tuning	415
	nA: PM Motor Control Tuning	426
2.11	o: Keypad-Related Settings	427
	o1: Keypad Display Selection	427
	o2: Keypad Operation	435
	o3: Copy Function	439
	o4: Maintenance Mon Settings	440
	o5: Log Function	443
2.12	T: Auto-Tuning	449
	T0: Tuning Mode Selection	449
	T1: Induction Motor Auto-Tuning	449
	T2: PM Motor Auto-Tuning	452
	T3: ASR and Inertia Tuning	455
	T4: EZ Tuning	455
3.	Startup Procedure and Test Run	457
3.1	Section Safety	458
3.2	Overview of Keypad Components and Functions	459

	Indicator flashing statuses	461
	Keypad Mode and Menu Displays	462
	Set up the Drive with General-Purpose Setup Mode	462
	Programming Mode	463
	Change Parameter Settings	464
	Verify and Set the Changed Parameters (Verify Menu)	464
	How to Switch between LOCAL and REMOTE	465
3.3	Keypad Operation	466
	Digital character mapping table	466
	Show the Monitor	466
	Check Modified Parameters	466
	Set and View Necessary Parameters	467
	Change Parameter Settings	467
	Save a Backup of Parameters	468
	Write Backed-up Parameters to the Drive	469
	Verify Keypad Parameters and Drive Parameters	469
	Delete Parameters Backed Up to the Keypad	470
3.4	Automatic Parameter Settings Optimized for Specific Applications (Application Presets)	471
3.5	Auto-Tuning	472
	Auto-Tuning for Induction Motors	472
	Auto-Tuning for PM Motors	473
	Auto-Tuning in EZ Open Loop Vector Control Method	474
	ASR and Inertia Tuning	475
	Precautions before Auto-Tuning	476
3.6	Test Run	479
	No-Load Test Run	479
	Do a No-Load Test Run	479
	Actual-Load Test Run	479
	Do an Actual-Load Test Run	480
3.7	Fine Tuning during Test Runs (Adjust the Control Function)	481
	V/f Control	481
	Open Loop Vector Control Method	482
	Open Loop Vector Control for PM Motors	484
	Advanced Open Loop Vector Control Method for PM Motors	485
	EZ Open Loop Vector Control Method	485
3.8	Test Run Checklist	486
4.	Mechanical Installation	489
4.1	Section Safety	490
4.2	Removing/Reattaching Covers	491
	Remove the Front Cover	491
	Reattach the Front Cover	491
4.3	Remove and Reattach the Keypad	493
	Remove the Keypad	493
	Reattach the Keypad	493
5.	Electrical Installation	495
5.1	Section Safety	496
5.2	Standard Connection Diagram	499
5.3	Control Circuit Wiring	502
	Control Circuit Connection Diagram	502

	Control Circuit Terminal Block Functions	503
	Control Circuit Terminal Configuration	506
	Switches and Jumpers on the Terminal Board	506
5.4	Control I/O Connections	508
	Pulse Train Output	508
	Set Sinking Mode/Sourcing Mode	509
	Set the Input Signal for the MFAI Terminal A2	509
	Set the Output Signal for the MFAO Terminal AM	510
	Switch ON Termination Resistor for MEMOBUS/Modbus Communications	510
5.5	Connect the Drive to a PC	511
6.	Preface and General Precautions	513
6.1	Receiving	514
	Glossary	514
	About Registered Trademarks	514
6.2	Using the Product Safely	515
	Explanation of Signal Words	515
	Section Safety	515
	Index	517
	Revision History	522

Preface and General Precautions

This chapter gives information about important safety precautions for the use of this product. Failure to obey these precautions can cause serious injury or death, or damage to the product or related devices and systems. Yaskawa must not be held responsible for any injury or equipment damage as a result of the failure to observe these precautions and instructions.

i.1	Receiving	10
i.2	Using the Product Safely	11
i.3	Warranty Information	14

i.1 Receiving

These instructions contain the information necessary to use the product correctly. Read and understand the safety information and precautions before you start to use the product.

◆ Glossary

Phrase	Definition
AOLV/PM	Advanced Open Loop Vector Control for Permanent Magnet Motors
Drive	YASKAWA AC Drive GA500
EDM	External Device Monitor
EZOLV	EZ Open Loop Vector Control
HD	Heavy Duty
IPM motor	Interior Permanent Magnet Synchronous Motor
MFAI	Multi-Function Analog Input
MFAO	Multi-Function Analog Output
MFDI	Multi-Function Digital Input
MFDO	Multi-Function Digital Output
ND	Normal Duty
OLV	Open Loop Vector Control
OLV/PM	Open Loop Vector Control for Permanent Magnet Motors
PM motor	Permanent Magnet Synchronous Motor (generic name for IPM motors and SPM motors)
SIL	Safety Integrity Level
SPM motor	Surface Permanent Magnet Synchronous Motor
V/f	V/f Control

◆ About Registered Trademarks

- CANopen is a registered trademark of CAN in Automation (CIA).
- CC-Link is a registered trademark of CC-Link Partner Association.
- DeviceNet is a registered trademark of Open DeviceNet Vendor Association, Inc. (ODVA).
- EtherCAT is a registered trademark of Beckhoff Automation GmbH.
- EtherNet/IP is a registered trademark of Open DeviceNet Vendor Association, Inc. (ODVA).
- LonWorks and LonTalk are registered trademarks of Echelon Corporation.
- MECHATROLINK-I, MECHATROLINK-II, and MECHATROLINK-III are registered trademarks of MECHATROLINK Members Association (MMA).
- Modbus is a registered trademark of Schneider Electric SA.
- PROFIBUS-DP and PROFINET are registered trademarks of PROFIBUS International.
- Other company names and product names in this document are trademarks or registered trademarks of the respective companies.

i.2 Using the Product Safely

◆ Explanation of Signal Words

⚠ WARNING

Read and understand this manual before you install, operate, or do maintenance on the drive. Install the drive as specified by this manual and local codes.

The symbols in this section identify safety messages in this manual. If you do not obey these safety messages, the hazards can cause serious injury, death, or damage to the products and related equipment and systems.

These identifier words categorize and emphasize important safety precautions in these instructions.

⚠ DANGER

This signal word identifies a hazard that will cause serious injury or death if you do not prevent it.

⚠ WARNING

This signal word identifies a hazard that can cause death or serious injuries if you do not prevent it.

⚠ CAUTION

This signal word identifies a hazard that can cause minor or moderate injuries if you do not prevent it.

NOTICE

This signal word identifies a property damage message that is not related to personal injury.

◆ Section Safety

General Precautions

- Some figures in the instructions include options and drives without covers or safety shields to more clearly show the inside of the drive. Replace covers and shields before operation. Use options and drives only as specified by the instructions.
- The figures in this manual are examples only. All figures do not apply to all products included in this manual.
- Yaskawa can change the products, specifications, and content of the instructions without notice to make the product and/or the instructions better.
- If you damage or lose these instructions, contact a Yaskawa representative or the nearest Yaskawa sales office on the rear cover of the manual, and tell them the document number on the front cover to order new copies.

⚠ DANGER

Do not ignore the safety messages in this manual.

If you ignore the safety messages in this manual, it will cause serious injury or death. The manufacturer is not responsible for injuries or damage to equipment.

Electrical Shock Hazard

Do not examine, connect, or disconnect wiring on an energized drive. Before servicing, disconnect all power to the equipment and wait for the time specified on the warning label at a minimum. The internal capacitor stays charged after the drive is de-energized. The charge indicator LED extinguishes when the DC bus voltage decreases below 50 Vdc. When all indicators are OFF, measure for dangerous voltages to make sure that the drive is safe.

If you do work on the drive when it is energized, it will cause serious injury or death from electrical shock.

⚠ WARNING

Crush Hazard

Test the system to make sure that the drive operates safely after you wire the drive and set parameters.

If you do not test the system, it can cause damage to equipment or serious injury or death.

Sudden Movement Hazard

Before you do a test run, make sure that the setting values for virtual input and output function parameters are correct. Virtual input and output functions can have different default settings and operation than wired input and output functions.

Incorrect function settings can cause serious injury or death.

Remove all personnel and objects from the area around the drive, motor, and machine and attach covers, couplings, shaft keys, and machine loads before you energize the drive.

If personnel are too close or if there are missing parts, it can cause serious injury or death.

Examine the I/O signals and internal sequence with the engineer who made the DriveWorksEZ program before you operate the drive.

If you do not know how the drive will operate, it can cause serious injury or death. When you use DriveWorksEZ to make custom programming, the drive I/O terminal functions change from factory settings and the drive will not operate as written in this manual.

Electrical Shock Hazard

Do not modify the drive body or drive circuitry.

Modifications to drive body and circuitry can cause serious injury or death, will cause damage to the drive, and will void the warranty. Yaskawa is not responsible for modifications of the product made by the user.

Only let approved personnel install, wire, maintain, examine, replace parts, and repair the drive.

If personnel are not approved, it can cause serious injury or death.

Do not remove covers or touch circuit boards while the drive is energized.

If you touch the internal components of an energized drive, it can cause serious injury or death.

After the drive blows a fuse or trips a GFCI, do not immediately energize the drive or operate peripheral devices. Wait for the time specified on the warning label at a minimum and make sure that all indicators are OFF. Then check the wiring and peripheral device ratings to find the cause of the problem. If you do not know the cause of the problem, contact Yaskawa before you energize the drive or peripheral devices.

If you do not fix the problem before you operate the drive or peripheral devices, it can cause serious injury or death.

Damage to Equipment

Do not apply incorrect voltage to the main circuit of the drive. Operate the drive in the specified range of the input voltage on the drive nameplate.

Voltages that are higher than the permitted nameplate tolerance can cause damage to the drive.

Fire Hazard

Install sufficient branch circuit short circuit protection as specified by applicable codes and this manual. The drive is suited for circuits that supply not more than 31,000 RMS symmetrical amperes, 240 Vac maximum (200 V Class), 480 Vac maximum (400 V Class).

Incorrect branch circuit short circuit protection can cause serious injury or death.

⚠ CAUTION

Crush Hazard

Tighten terminal cover screws and hold the case safely when you move the drive.

If the drive or covers fall, it can cause moderate injury.

NOTICE

Use an inverter-duty motor or vector-duty motor with reinforced insulation and windings applicable for use with an AC drive.

If the motor does not have the correct insulation, it can cause a short circuit or ground fault from insulation deterioration.

Damage to Equipment

When you touch the drive and circuit boards, make sure that you observe correct electrostatic discharge (ESD) procedures.

If you do not follow procedures, it can cause ESD damage to the drive circuitry.

Do not do a withstand voltage test or use a megohmmeter or megger insulation tester on the drive.

These tests can cause damage to the drive.

Do not operate a drive or connected equipment that has damaged or missing parts.

You can cause damage to the drive and connected equipment.

Do not use steam or other disinfectants to fumigate wood for packaging the drive. Use alternative methods, for example heat treatment, before you package the components.

Gas from wood packaging fumigated with halogen disinfectants, for example fluorine, chlorine, bromine, iodine or DOP gas (phthalic acid ester), can cause damage to the drive.

◆ Warning Label Content and Location

The drive warning label is in the location shown in [Figure i.1](#). Use the drive as specified by this information.



A - Warning label

Figure i.1 Warning Label Content and Location

i.3 Warranty Information

◆ Exclusion of Liability

- This product is not designed and manufactured for use in life-support machines or systems.
- Contact a Yaskawa representative or your Yaskawa sales representative if you are considering the application of this product for special purposes, such as machines or systems used for passenger cars, medicine, airplanes and aerospace, nuclear power, electric power, or undersea relaying.

⚠ WARNING

Injury to Personnel

When you use this product in applications where its failure could cause the loss of human life, a serious accident, or physical injury, you must install applicable safety devices.

If you do not correctly install safety devices, it can cause serious injury or death.

Parameter List

1.1	Section Safety	16
1.2	How to Read the Parameter List	17
1.3	Parameter Groups	18
1.4	A: Initialization Parameters.....	19
1.5	b: Application	22
1.6	C: Tuning	32
1.7	d: Reference Settings.....	37
1.8	E: Motor Parameters.....	41
1.9	F: Options.....	46
1.10	H: Terminal Functions	56
1.11	L: Protection Functions	81
1.12	n: Special Adjustment.....	91
1.13	o: Keypad-Related Settings	98
1.14	q: DriveWorksEZ Parameters.....	104
1.15	r: DWEZ Connection 1-20	105
1.16	T: Motor Tuning	106
1.17	U: Monitors.....	109
1.18	Parameters that Change from the Default Settings with A1-02 [Control Method Selection]	124
1.19	Parameters that Change from the Default Settings with E3-01 [Motor 2 Control Mode Selection]	128
1.20	Parameters Changed by E1-03 [V/f Pattern Selection]	129
1.21	Defaults by Drive Model and Duty Rating ND/HD.....	130

1.1 Section Safety





 **DANGER**

Do not ignore the safety messages in this manual.

If you ignore the safety messages in this manual, it will cause serious injury or death. The manufacturer is not responsible for injuries or damage to equipment.

1.2 How to Read the Parameter List

◆ Icons and Terms that Identify Parameters and Control Modes

Icon	Description
	The parameter is available when operating the drive with V/f Control.
	The parameter is available when operating the drive with Open Loop Vector Control.
	The parameter is available when operating the drive with Open Loop Vector Control for PM.
	The parameter is available when operating the drive with Advanced Open Loop Vector Control for PM.
	The parameter is available when operating the drive with EZ Open Loop Vector Control.
Hex.	Hexadecimal numbers that represent MEMOBUS addresses to change parameters over network communication.
RUN	The parameter can be changed settings during run.
Expert	The parameter that is available in Expert Mode only. <i>*1</i>

*1 Set $A1-01 = 3$ [*Access Level Selection = Expert Level*] to display and set Expert Mode parameters on the keypad.

Note:

Gray icons identify parameters that are not available in the specified control method.

1.3 Parameter Groups

Represents the type of product parameters.

Parameter	Name
A1	Initialization
A2	User Parameters
b1	Operation Mode Selection
b2	DC Injection Braking and Short Circuit Braking
b3	Speed Search
b4	Timer Function
b5	PID control
b6	Dwell Function
b8	Energy Saving
C1	Accel & Decel Time
C2	S-Curve Characteristics
C3	Slip Compensation
C4	Torque Compensation
C5	Automatic Speed Regulator (ASR: Automatic Speed Regulator)
C6	Carrier Frequency
d1	Frequency Reference
d2	Reference Limits
d3	Jump Frequency
d4	Frequency Ref Up/Down & Hold
d6	Field Weakening /Forcing
d7	Offset Frequency
E1	V/f Pattern for Motor 1
E2	Motor Parameters
E3	V/f Pattern for Motor 2
E4	Motor 2 Parameters
E5	PM Motor Settings
E9	Motor Setting
F1	Fault Detection during PG Speed Control
F6	Communication Options
F7	Communication Options
H1	Digital Inputs
H2	Digital Outputs
H3	Analog Inputs
H4	Analog Outputs
H5	Modbus Communication
H6	Pulse Train Input/Output

Parameter	Name
H7	Virtual MFIO selection
L1	Motor Protection
L2	Power Loss Ride Through
L3	Stall Prevention
L4	Speed Detection
L5	Fault Restart
L6	Torque Detection
L7	Torque Limit
L8	Drive Protection
n1	Hunting Prevention
n2	Auto Freq Regulator (AFR)
n3	High Slip/Overexcite Braking
n5	Feed Forward Control
n6	Online Tuning
n7	EZ Drive
n8	PM Motor Control Tuning
nA	PM Motor Control Tuning
o1	Keypad Display
o2	Keypad Operation
o3	Copy Keypad Function
o4	Maintenance Monitors
o5	Log Function
q	DriveWorksEZ Parameters
r	DWEZ Connection 1-20
T0	Tuning Mode Selection
T1	Induction Motor Auto-Tuning
T2	PM Motor Auto-Tuning
T3	ASR and Inertia Tuning
T4	EZ Tuning
U1	Operation Status Monitors
U2	Fault Trace
U3	Fault History
U4	Maintenance Monitors
U5	PID Monitors
U6	Operation Status Monitors
U8	DriveWorksEZ Monitors

1.4 A: Initialization Parameters

◆ A1: Initialization

No. (Hex.)	Name	Description	Default (Range)
A1-00 (0100) RUN	Language Selection	<p>V/f OLV OLV/PM AOLV/PM EZOLV</p> <p>Sets the language for the LCD keypad.</p> <p>Note: When you use A1-03 [Initialize Parameters] to initialize the drive, the drive will not reset this parameter.</p> <p>0 : English 1 : Japanese 2 : German 3 : French 4 : Italian 5 : Spanish 6 : Portuguese 7 : Chinese 8 : Czech 9 : Russian 10 : Turkish 11 : Polish 12 : Greek</p>	0 (0 - 12)
A1-01 (0101) RUN	Access Level Selection	<p>V/f OLV OLV/PM AOLV/PM EZOLV</p> <p>Sets user access to parameters. The access level controls which parameters the keypad will display, and which parameters the user can set.</p> <p>0 : Operation Only 1 : User Parameters 2 : Advanced Level 3 : Expert Level</p>	2 (0 - 3)
A1-02 (0102)	Control Method Selection	<p>V/f OLV OLV/PM AOLV/PM EZOLV</p> <p>Sets the control method for the drive application and the motor.</p> <p>0 : V/f Control 2 : Open Loop Vector 5 : PM Open Loop Vector 6 : PM Advanced Open Loop Vector 8 : EZ Vector Control</p>	2 (0, 2, 5, 6, 8)
A1-03 (0103)	Initialize Parameters	<p>V/f OLV OLV/PM AOLV/PM EZOLV</p> <p>Sets parameters to default values.</p> <p>0 : No Initialization 1110 : User Initialization 2220 : 2-Wire Initialization 3330 : 3-Wire Initialization</p>	0 (0 - 3330)
A1-04 (0104)	Password	<p>V/f OLV OLV/PM AOLV/PM EZOLV</p> <p>Entry point for the password set in A1-05 [Password Setting]. The user can view the settings of parameters that are locked without entering the password. Enter the correct password in this parameter to change parameter settings.</p>	0000 (0000 - 9999)
A1-05 (0105)	Password Setting	<p>V/f OLV OLV/PM AOLV/PM EZOLV</p> <p>Set the password to lock parameters and prevent changes to parameter settings. Enter the correct password in A1-04 [Password] to unlock parameters and accept changes.</p>	0000 (0000 - 9999)
A1-06 (0127)	Application Preset	<p>V/f OLV OLV/PM AOLV/PM EZOLV</p> <p>Sets the drive to operate in selected application conditions.</p> <p>0 : General-purpose 1 : Water Supply Pump 2 2 : Conveyor 3 : Exhaust Fan 4 : HVAC Fan 5 : Air Compressor 8 : Conveyor 2</p>	0 (0 - 5, 8)

1.4 A: Initialization Parameters

No. (Hex.)	Name	Description	Default (Range)
A1-07 (0128)	DriveWorksEZ Function Selection	<p><input type="checkbox"/> V/f <input type="checkbox"/> OLV <input type="checkbox"/> OLV/IPM <input type="checkbox"/> AOLV/IPM <input type="checkbox"/> EZOLV</p> <p>Sets the drive to operate with DriveWorksEZ. 0 : DWEZ Disabled 1 : DWEZ Enabled 2 : Enabled/Disabled wDigital Input</p>	0 (0 - 2)
A1-11 (111D) Expert	Firmware Update Lock	<p><input type="checkbox"/> V/f <input type="checkbox"/> OLV <input type="checkbox"/> OLV/IPM <input type="checkbox"/> AOLV/IPM <input type="checkbox"/> EZOLV</p> <p>Protects the drive firmware. When you enable the protection, you cannot update the drive firmware. 0 : Disabled 1 : Enabled</p>	0 (0, 1)
A1-12 (1564)	Bluetooth ID	<p><input type="checkbox"/> V/f <input type="checkbox"/> OLV <input type="checkbox"/> OLV/IPM <input type="checkbox"/> AOLV/IPM <input type="checkbox"/> EZOLV</p> <p>Sets the password necessary to use Bluetooth to control the drive with a smartphone or tablet.</p>	- (0000 - 9999)

◆ A2: User Parameters

No. (Hex.)	Name	Description	Default (Setting Range)
A2-01 (0106)	User Parameter 1	<p><input type="checkbox"/> V/f <input type="checkbox"/> OLV <input type="checkbox"/> OLV/IPM <input type="checkbox"/> AOLV/IPM <input type="checkbox"/> EZOLV</p> <p>Sets the parameter number to show on the first line in Setup Mode. You can select a maximum of 32 parameters for the drive and set them to parameters A2-01 to A2-32.</p>	A1-02 (Determined by A1-06)
A2-02 (0107)	User Parameter 2	<p><input type="checkbox"/> V/f <input type="checkbox"/> OLV <input type="checkbox"/> OLV/IPM <input type="checkbox"/> AOLV/IPM <input type="checkbox"/> EZOLV</p> <p>Sets the parameter number to show on the second line in Setup Mode. You can select a maximum of 32 parameters for the drive and set them to parameters A2-01 to A2-32.</p>	b1-01 (Determined by A1-06)
A2-03 (0108)	User Parameter 3	<p><input type="checkbox"/> V/f <input type="checkbox"/> OLV <input type="checkbox"/> OLV/IPM <input type="checkbox"/> AOLV/IPM <input type="checkbox"/> EZOLV</p> <p>Sets the parameter number to show on the third line in Setup Mode. You can select a maximum of 32 parameters for the drive and set them to parameters A2-01 to A2-32.</p>	b1-02 (Determined by A1-06)
A2-04 (0109)	User Parameter 4	<p><input type="checkbox"/> V/f <input type="checkbox"/> OLV <input type="checkbox"/> OLV/IPM <input type="checkbox"/> AOLV/IPM <input type="checkbox"/> EZOLV</p> <p>Sets the parameter number to show on the fourth line in Setup Mode. You can select a maximum of 32 parameters for the drive and set them to parameters A2-01 to A2-32.</p>	b1-03 (Determined by A1-06)
A2-05 (010A)	User Parameter 5	<p><input type="checkbox"/> V/f <input type="checkbox"/> OLV <input type="checkbox"/> OLV/IPM <input type="checkbox"/> AOLV/IPM <input type="checkbox"/> EZOLV</p> <p>Sets the parameter number to show on the fifth line in Setup Mode. You can select a maximum of 32 parameters for the drive and set them to parameters A2-01 to A2-32.</p>	C1-01 (Determined by A1-06)
A2-06 (010B)	User Parameter 6	<p><input type="checkbox"/> V/f <input type="checkbox"/> OLV <input type="checkbox"/> OLV/IPM <input type="checkbox"/> AOLV/IPM <input type="checkbox"/> EZOLV</p> <p>Sets the parameter number to show on the sixth line in Setup Mode. You can select a maximum of 32 parameters for the drive and set them to parameters A2-01 to A2-32.</p>	C1-02 (Determined by A1-06)
A2-07 (010C)	User Parameter 7	<p><input type="checkbox"/> V/f <input type="checkbox"/> OLV <input type="checkbox"/> OLV/IPM <input type="checkbox"/> AOLV/IPM <input type="checkbox"/> EZOLV</p> <p>Sets the parameter number to show on the seventh line in Setup Mode. You can select a maximum of 32 parameters for the drive and set them to parameters A2-01 to A2-32.</p>	C6-01 (Determined by A1-06)
A2-08 (010D)	User Parameter 8	<p><input type="checkbox"/> V/f <input type="checkbox"/> OLV <input type="checkbox"/> OLV/IPM <input type="checkbox"/> AOLV/IPM <input type="checkbox"/> EZOLV</p> <p>Sets the parameter number to show on the eighth line in Setup Mode. You can select a maximum of 32 parameters for the drive and set them to parameters A2-01 to A2-32.</p>	C6-02 (Determined by A1-06)
A2-09 (010E)	User Parameter 9	<p><input type="checkbox"/> V/f <input type="checkbox"/> OLV <input type="checkbox"/> OLV/IPM <input type="checkbox"/> AOLV/IPM <input type="checkbox"/> EZOLV</p> <p>Sets the parameter number to show on the ninth line in Setup Mode. You can select a maximum of 32 parameters for the drive and set them to parameters A2-01 to A2-32.</p>	d1-01 (Determined by A1-06)
A2-10 (010F)	User Parameter 10	<p><input type="checkbox"/> V/f <input type="checkbox"/> OLV <input type="checkbox"/> OLV/IPM <input type="checkbox"/> AOLV/IPM <input type="checkbox"/> EZOLV</p> <p>Sets the parameter number to show on the 10th line in Setup Mode. You can select a maximum of 32 parameters for the drive and set them to parameters A2-01 to A2-32.</p>	d1-02 (Determined by A1-06)
A2-11 (0110)	User Parameter 11	<p><input type="checkbox"/> V/f <input type="checkbox"/> OLV <input type="checkbox"/> OLV/IPM <input type="checkbox"/> AOLV/IPM <input type="checkbox"/> EZOLV</p> <p>Sets the parameter number to show on the 11th line in Setup Mode. You can select a maximum of 32 parameters for the drive and set them to parameters A2-01 to A2-32.</p>	d1-03 (Determined by A1-06)
A2-12 (0111)	User Parameter 12	<p><input type="checkbox"/> V/f <input type="checkbox"/> OLV <input type="checkbox"/> OLV/IPM <input type="checkbox"/> AOLV/IPM <input type="checkbox"/> EZOLV</p> <p>Sets the parameter number to show on the 12th line in Setup Mode. You can select a maximum of 32 parameters for the drive and set them to parameters A2-01 to A2-32.</p>	d1-04 (Determined by A1-06)
A2-13 (0112)	User Parameter 13	<p><input type="checkbox"/> V/f <input type="checkbox"/> OLV <input type="checkbox"/> OLV/IPM <input type="checkbox"/> AOLV/IPM <input type="checkbox"/> EZOLV</p> <p>Sets the parameter number to show on the 13th line in Setup Mode. You can select a maximum of 32 parameters for the drive and set them to parameters A2-01 to A2-32.</p>	d1-17 (Determined by A1-06)
A2-14 (0113)	User Parameter 14	<p><input type="checkbox"/> V/f <input type="checkbox"/> OLV <input type="checkbox"/> OLV/IPM <input type="checkbox"/> AOLV/IPM <input type="checkbox"/> EZOLV</p> <p>Sets the parameter number to show on the 14th line in Setup Mode. You can select a maximum of 32 parameters for the drive and set them to parameters A2-01 to A2-32.</p>	E1-01 (Determined by A1-06)
A2-15 (0114)	User Parameter 15	<p><input type="checkbox"/> V/f <input type="checkbox"/> OLV <input type="checkbox"/> OLV/IPM <input type="checkbox"/> AOLV/IPM <input type="checkbox"/> EZOLV</p> <p>Sets the parameter number to show on the 15th line in Setup Mode. You can select a maximum of 32 parameters for the drive and set them to parameters A2-01 to A2-32.</p>	E1-03 (Determined by A1-06)

No. (Hex.)	Name	Description	Default (Setting Range)
A2-16 (0115)	User Parameter 16	V/f OLV OLV/PM AOLV/PM EZOLV Sets the parameter number to show on the 16th line in Setup Mode. You can select a maximum of 32 parameters for the drive and set them to parameters <i>A2-01</i> to <i>A2-32</i> .	E1-04 (Determined by A1-06)
A2-17 (0116)	User Parameter 17	V/f OLV OLV/PM AOLV/PM EZOLV Sets the parameter number to show on the 17th line in Setup Mode. You can select a maximum of 32 parameters for the drive and set them to parameters <i>A2-01</i> to <i>A2-32</i> .	E1-05 (Determined by A1-06)
A2-18 (0117)	User Parameter 18	V/f OLV OLV/PM AOLV/PM EZOLV Sets the parameter number to show on the 18th line in Setup Mode. You can select a maximum of 32 parameters for the drive and set them to parameters <i>A2-01</i> to <i>A2-32</i> .	E1-06 (Determined by A1-06)
A2-19 (0118)	User Parameter 19	V/f OLV OLV/PM AOLV/PM EZOLV Sets the parameter number to show on the 19th line in Setup Mode. You can select a maximum of 32 parameters for the drive and set them to parameters <i>A2-01</i> to <i>A2-32</i> .	E1-09 (Determined by A1-06)
A2-20 (0119)	User Parameter 20	V/f OLV OLV/PM AOLV/PM EZOLV Sets the parameter number to show on the 20th line in Setup Mode. You can select a maximum of 32 parameters for the drive and set them to parameters <i>A2-01</i> to <i>A2-32</i> .	E1-13 (Determined by A1-06)
A2-21 (011A)	User Parameter 21	V/f OLV OLV/PM AOLV/PM EZOLV Sets the parameter number to show on the 21st line in Setup Mode. You can select a maximum of 32 parameters for the drive and set them to parameters <i>A2-01</i> to <i>A2-32</i> .	E2-01 (Determined by A1-06)
A2-22 (011B)	User Parameter 22	V/f OLV OLV/PM AOLV/PM EZOLV Sets the parameter number to show on the 22nd line in Setup Mode. You can select a maximum of 32 parameters for the drive and set them to parameters <i>A2-01</i> to <i>A2-32</i> .	E2-04 (Determined by A1-06)
A2-23 (011C)	User Parameter 23	V/f OLV OLV/PM AOLV/PM EZOLV Sets the parameter number to show on the 23rd line in Setup Mode. You can select a maximum of 32 parameters for the drive and set them to parameters <i>A2-01</i> to <i>A2-32</i> .	E2-11 (Determined by A1-06)
A2-24 (011D)	User Parameter 24	V/f OLV OLV/PM AOLV/PM EZOLV Sets the parameter number to show on the 24th line in Setup Mode. You can select a maximum of 32 parameters for the drive and set them to parameters <i>A2-01</i> to <i>A2-32</i> .	H4-02 (Determined by A1-06)
A2-25 (011E)	User Parameter 25	V/f OLV OLV/PM AOLV/PM EZOLV Sets the parameter number to show on the 25th line in Setup Mode. You can select a maximum of 32 parameters for the drive and set them to parameters <i>A2-01</i> to <i>A2-32</i> .	L1-01 (Determined by A1-06)
A2-26 (011F)	User Parameter 26	V/f OLV OLV/PM AOLV/PM EZOLV Sets the parameter number to show on the 26th line in Setup Mode. You can select a maximum of 32 parameters for the drive and set them to parameters <i>A2-01</i> to <i>A2-32</i> .	L3-04 (Determined by A1-06)
A2-27 (0120)	User Parameter 27	V/f OLV OLV/PM AOLV/PM EZOLV Sets the parameter number to show on the 27th line in Setup Mode. You can select a maximum of 32 parameters for the drive and set them to parameters <i>A2-01</i> to <i>A2-32</i> .	- (Determined by A1-06)
A2-28 (0121)	User Parameter 28	V/f OLV OLV/PM AOLV/PM EZOLV Sets the parameter number to show on the 28th line in Setup Mode. You can select a maximum of 32 parameters for the drive and set them to parameters <i>A2-01</i> to <i>A2-32</i> .	- (Determined by A1-06)
A2-29 (0122)	User Parameter 29	V/f OLV OLV/PM AOLV/PM EZOLV Sets the parameter number to show on the 29th line in Setup Mode. You can select a maximum of 32 parameters for the drive and set them to parameters <i>A2-01</i> to <i>A2-32</i> .	- (Determined by A1-06)
A2-30 (0123)	User Parameter 30	V/f OLV OLV/PM AOLV/PM EZOLV Sets the parameter number to show on the 30th line in Setup Mode. You can select a maximum of 32 parameters for the drive and set them to parameters <i>A2-01</i> to <i>A2-32</i> .	- (Determined by A1-06)
A2-31 (0124)	User Parameter 31	V/f OLV OLV/PM AOLV/PM EZOLV Sets the parameter number to show on the 31st line in Setup Mode. You can select a maximum of 32 parameters for the drive and set them to parameters <i>A2-01</i> to <i>A2-32</i> .	- (Determined by A1-06)
A2-32 (0125)	User Parameter 32	V/f OLV OLV/PM AOLV/PM EZOLV Sets the parameter number to show on the 32nd line in Setup Mode. You can select a maximum of 32 parameters for the drive and set them to parameters <i>A2-01</i> to <i>A2-32</i> .	- (Determined by A1-06)
A2-33 (0126)	User Parameter Auto Selection	V/f OLV OLV/PM AOLV/PM EZOLV Sets the automatic save feature for changes to parameters <i>A2-17</i> to <i>A2-32</i> [<i>User Parameters 17</i> to <i>32</i>]. 0 : Disabled: Manual Entry Required 1 : Enabled: Auto Save Recent Parm	Determined by A1-06 (0, 1)

1.5 b: Application

◆ b1: Operation Mode Selection

No. (Hex.)	Name	Description	Default (Setting Range)
b1-01 (0180)	Frequency Reference Selection 1	<p>V/f OLV OLV/PM AOLV/PM EZOLV</p> <p>Sets the input method for the frequency reference.</p> <p>0 : Keypad 1 : Analog Input 2 : Memobus/Modbus Communications 3 : Option PCB 4 : Pulse Train Input</p>	1 (0 - 4)
b1-02 (0181)	Run Command Selection 1	<p>V/f OLV OLV/PM AOLV/PM EZOLV</p> <p>Sets the input method for the Run command.</p> <p>0 : Keypad 1 : Digital Input 2 : Memobus/Modbus Communications 3 : Option PCB</p>	1 (0 - 3)
b1-03 (0182)	Stopping Method Selection	<p>V/f OLV OLV/PM AOLV/PM EZOLV</p> <p>Sets the method to stop the motor after removing a Run command or entering a Stop command.</p> <p>Note: When A1-02 = 5, 6, 8 [Control Method Selection = OLV/PM, AOLV/PM, EZOLV], the setting range is 0, 1, 3.</p> <p>0 : Ramp to Stop 1 : Coast to Stop 2 : DC Injection Braking to Stop 3 : Coast to Stop with Timer</p>	0 (0 - 3)
b1-04 (0183)	Reverse Operation Selection	<p>V/f OLV OLV/PM AOLV/PM EZOLV</p> <p>Sets the reverse operation function. Disable reverse operation in fan or pump applications where reverse rotation is dangerous.</p> <p>0 : Reverse Enabled 1 : Reverse Disabled</p>	0 (0, 1)
b1-06 (0185)	Digital Input Reading	<p>V/f OLV OLV/PM AOLV/PM EZOLV</p> <p>Sets the number of times that the drive reads the sequence input command to prevent malfunction because of electrical interference.</p> <p>0 : Single Scan 1 : Double Scan</p>	1 (0, 1)
b1-07 (0186)	LOCAL/REMOTE Run Selection	<p>V/f OLV OLV/PM AOLV/PM EZOLV</p> <p>Sets drive response to an existing Run command when the drive receives a second Run command from a different location.</p> <p>0 : Disregard Existing RUN Command 1 : Accept Existing RUN Command</p>	0 (0, 1)
b1-08 (0187)	Run Command Select in PRG Mode	<p>V/f OLV OLV/PM AOLV/PM EZOLV</p> <p>Sets the conditions for the drive to accept a Run command entered from an external source when using the keypad to set parameters.</p> <p>0 : Disregard RUN while Programming 1 : Accept RUN while Programming 2 : Allow Programming Only at Stop</p>	0 (0 - 2)
b1-14 (01C3)	Phase Order Selection	<p>V/f OLV OLV/PM AOLV/PM EZOLV</p> <p>Sets the phase order for output terminals U/T1, V/T2, and W/T3. This parameter can align the Forward Run command from the drive and the forward direction of the motor without changing wiring.</p> <p>0 : Standard 1 : Switch Phase Order</p>	0 (0, 1)
b1-15 (01C4)	Frequency Reference Selection 2	<p>V/f OLV OLV/PM AOLV/PM EZOLV</p> <p>Sets the input method for frequency reference 2.</p> <p>0 : Keypad 1 : Analog Input 2 : Memobus/Modbus Communications 3 : Option PCB 4 : Pulse Train Input</p>	0 (0 - 4)

No. (Hex.)	Name	Description	Default (Setting Range)
b1-16 (01C5)	Run Command Selection 2	V/f OLV OLV/PM AOLV/PM EZOLV Sets the input method for Run Command 2 when the user switches the control circuit terminals ON/OFF to change the Run command source. 0 : Keypad 1 : Digital Input 2 : Memobus/Modbus Communications 3 : Option PCB	0 (0 - 3)
b1-17 (01C6)	Run Command at Power Up	V/f OLV OLV/PM AOLV/PM EZOLV Sets drive response when the CPU changes from de-energized to energized and there is an active Run command. Set this parameter in applications where energizing or de-energizing the drive enables the Run command. When the CPU stays energized during loss of power, L2-01 [Power Loss Ride Through Select] sets operation. 0 : Disregard Existing RUN Command 1 : Accept Existing RUN Command	0 (0, 1)
b1-35 (1117) Expert	Digital Input Deadband Time	V/f OLV OLV/PM AOLV/PM EZOLV Sets the deadband time for MFDIs.	0.0 ms (0.0 to 100.0 ms)

◆ b2: DC Injection Braking and Short Circuit Braking

No. (Hex.)	Name	Description	Default (Range)
b2-01 (0189)	DC Injection/Zero SpeedThreshold	V/f OLV OLV/PM AOLV/PM EZOLV Sets the frequency to start DC Injection Braking or Short Circuit Braking near the end of a stop ramp. Note: This parameter is available when b1-03 = 0 [Stopping Method Selection = Ramp to Stop].	Determined by A1-02 (0.0 - 10.0 Hz)
b2-02 (018A)	DC Injection Braking Current	V/f OLV OLV/PM AOLV/PM EZOLV Sets the DC Injection Braking current as a percentage of the drive rated current.	50% (0 - 75%)
b2-03 (018B)	DC Inject Braking Time at Start	V/f OLV OLV/PM AOLV/PM EZOLV Sets the DC Injection Braking Time at stop.	0.00 s (0.00 - 10.00 s)
b2-04 (018C)	DC Inject Braking Time at Stop	V/f OLV OLV/PM AOLV/PM EZOLV Sets the DC Injection Braking Time at stop.	Determined by A1-02 (0.00 - 10.00 s)
b2-08 (0190)	Magnetic Flux Compensation Value	V/f OLV OLV/PM AOLV/PM EZOLV Sets how much current the drive injects when DC Injection Braking at Start starts (Initial Excitation) as a percentage of E2-03 [Motor No-Load Current].	0% (0 - 1000%)
b2-12 (01BA)	Short Circuit Brake Time @ Start	V/f OLV OLV/PM AOLV/PM EZOLV Sets the Short Circuit Braking time at start.	0.00 s (0.00 - 25.50 s)
b2-13 (01BB)	Short Circuit Brake Time @ Stop	V/f OLV OLV/PM AOLV/PM EZOLV Sets the Short Circuit Braking time at stop.	A1-02 = 8: 0.00 s Other than A1-02 = 8: 0.50 s (0.00 - 25.50 s)
b2-18 (0177)	Short Circuit Braking Current	V/f OLV OLV/PM AOLV/PM EZOLV Sets the Short Circuit Braking Current as a percentage of the motor rated current. Note: Parameter A1-02 [Control Method Selection] selects which parameter is the motor rated current. • A1-02 = 5, 6 [OLV/PM, AOLV/PM]: E5-03 [PM Motor Rated Current (FLA)] • A1-02 = 8 [EZOLV]: E9-06 [Motor Rated Current (FLA)]	100.0% (0.0 - 200.0%)

Parameter List

◆ b3: Speed Search

No. (Hex.)	Name	Description	Default (Range)
b3-01 (0191)	Speed Search at Start Selection	V/f OLV OLV/PM AOLV/PM EZOLV Sets the Speed Search at Start function so the drive will do Speed Search with each Run command. 0 : Disable 1 : Enabled	Determined by A1-02 (0, 1)
b3-02 (0192)	SpeedSearch Deactivation Current	V/f OLV OLV/PM AOLV/PM EZOLV Sets the current level that stops Speed Search as a percentage of the drive rated output current. Usually it is not necessary to change this setting.	Determined by A1-02 (0 - 200%)

1.5 b: Application

No. (Hex.)	Name	Description	Default (Range)
b3-03 (0193)	Speed Search Deceleration Time	<p>V/f OLV OLV/IPM AOLV/IPM EZOLV</p> <p>Sets the deceleration time during Speed Search operation. Set the length of time to decelerate from the maximum output frequency to the minimum output frequency.</p> <p>Note: When $A1-02 = 8$ [Control Method Selection = EZOLV], this parameter takes effect only in Expert Mode.</p>	2.0 s (0.1 - 10.0 s)
b3-04 (0194)	V/f Gain during Speed Search	<p>V/f OLV OLV/IPM AOLV/IPM EZOLV</p> <p>Sets the ratio used to reduce the V/f during searches to reduce the output current during speed searches.</p>	Determined by o2-04 (10 - 100)
b3-05 (0195)	Speed Search Delay Time	<p>V/f OLV OLV/IPM AOLV/IPM EZOLV</p> <p>Sets the Speed Search delay time to activate a magnetic contactor installed between the drive and motor.</p>	0.2 s (0.0 - 100.0 s)
b3-06 (0196) Expert	Speed Estimation Current Level 1	<p>V/f OLV OLV/IPM AOLV/IPM EZOLV</p> <p>Sets the level of current that flows to the motor during Speed Estimation Speed Search as a coefficient of the motor rated current. Usually it is not necessary to change this setting.</p>	Determined by o2-04 (0.0 - 2.0)
b3-07 (0197) Expert	Speed Estimation Current Level 2	<p>V/f OLV OLV/IPM AOLV/IPM EZOLV</p> <p>Sets the level of current that flows to the motor during Speed Estimation Speed Search as a coefficient of E2-03 [Motor No-Load Current] or E4-03 [Motor 2 Rated No-Load Current]. Usually it is not necessary to change this setting.</p>	1.0 (0.0 - 3.0)
b3-08 (0198)	Speed Estimation ACR P Gain	<p>V/f OLV OLV/IPM AOLV/IPM EZOLV</p> <p>Sets the proportional gain for the automatic current regulator during Speed Estimation Speed Search. Also adjusts speed search responsiveness. Usually it is not necessary to change this setting.</p>	Determined by A1-02 and o2-04 (0.00 - 6.00)
b3-09 (0199)	Speed Estimation ACR I Time	<p>V/f OLV OLV/IPM AOLV/IPM EZOLV</p> <p>Sets the integral time for the automatic current regulator during Speed Estimation Speed Search. Also adjusts speed search responsiveness. Usually it is not necessary to change this setting.</p>	Determined by A1-02 when $A1-02 \neq 5$ 20.0 when $A1-02 = 5$ (0.0 - 1000.0 ms)
b3-10 (019A) Expert	Speed Estimation Detection Gain	<p>V/f OLV OLV/IPM AOLV/IPM EZOLV</p> <p>Sets the gain to correct estimated frequencies from Speed Estimation Speed Search.</p>	1.05 (1.00 - 1.20)
b3-14 (019E)	Bi-directional Speed Search	<p>V/f OLV OLV/IPM AOLV/IPM EZOLV</p> <p>Sets the direction of Speed Search to the direction of the frequency reference or in the motor rotation direction as detected by the drive.</p> <p>0 : Disabled 1 : Enabled</p> <p>Note:</p> <ul style="list-style-type: none"> When $E9-01 = 0$ [Motor Type Selection = Induction (IM)] and $A1-02 = 0, 2, \text{ or } 8$ [Control Method Selection = V/f, OLV, or EZOLV], the default settings change when the setting of b3-24 [Speed Search Method Selection] changes. <ul style="list-style-type: none"> -b3-24 = 1 [Speed Estimation]: Refer to 124. -b3-24 = 2 [Current Detection 2]: 0 When $E9-01 = 1 \text{ or } 2$ [Permanent Magnet (PM), Synchronous Reluctance (SynRM)] and $A1-02 = 0 \text{ or } 8$ [V/f, EZOLV], refer to 124. <p>When you set A1-02, b3-24, and E9-01, set b3-14.</p>	Determined by A1-02 and b3-24 (0, 1)
b3-17 (01F0) Expert	Speed Est Retry Current Level	<p>V/f OLV OLV/IPM AOLV/IPM EZOLV</p> <p>Sets the current level for the search retry function in Speed Estimation Speed Search as a percentage where drive rated current is a setting value of 100%.</p>	150% (0 - 200%)
b3-18 (01F1) Expert	Speed Est Retry Detection Time	<p>V/f OLV OLV/IPM AOLV/IPM EZOLV</p> <p>Sets the length of time that the drive will wait to retry Speed Estimation Speed Search when too much current flow stopped the Speed Search.</p>	0.10 s (0.00 - 1.00 s)
b3-19 (01F2)	Speed Search Restart Attempts	<p>V/f OLV OLV/IPM AOLV/IPM EZOLV</p> <p>Sets the number of times to restart Speed Search if Speed Search does not complete.</p>	3 times (0 - 10 times)
b3-24 (01C0)	Speed Search Method Selection	<p>V/f OLV OLV/IPM AOLV/IPM EZOLV</p> <p>Sets the Speed Search method when you start the motor or when you restore power after a momentary power loss.</p> <p>Note:</p> <ul style="list-style-type: none"> When $A1-02 = 8$ [Control Method Selection = EZOLV], the default setting changes when the setting for E9-01 [Motor Type Selection] changes. <ul style="list-style-type: none"> -E9-01 = 0 [Induction (IM)]: 2 -E9-01 = 1, 2 [Permanent Magnet (PM), Synchronous Reluctance (SynRM)]: 1 When you set $A1-02 = 8$ and $E9-01 = 1 \text{ or } 2$, set b3-24 = 1. If b3-24 = 2, the drive will detect oPE08 [Parameter Selection Error]. When you set b3-24, it will trigger the drive to initialize b3-14 [Bi-directional Speed Search]. After you set b3-24, set b3-14. <p>1 : Speed Estimation 2 : Current Detection 2</p>	2 (1, 2)

No. (Hex.)	Name	Description	Default (Range)
b3-25 (01C8) Expert	Speed Search Wait Time	V/f OLV OLV/PM AOLV/PM EZOLV Sets the length of time the drive will wait to start the Speed Search Retry function.	0.5 s (0.0 - 30.0 s)
b3-26 (01C7) Expert	Direction Determination Level	V/f OLV OLV/PM AOLV/PM EZOLV Sets the level to find the motor rotation direction. Increase the value if the drive cannot find the direction.	1000 (40 to 60000)
b3-29 (077C) Expert	Speed Search Back-EMF Threshold	V/f OLV OLV/PM AOLV/PM EZOLV Sets the induced voltage for motors that use Speed Search. The drive will start Speed Search when the motor induced voltage level is the same as the setting value. Usually it is not necessary to change this setting.	10% (0 - 10%)
b3-31 (0BC0) Expert	Spd Search Current Reference Lvl	V/f OLV OLV/PM AOLV/PM EZOLV Sets the current level that decreases the output current during Current Detection Speed Search.	1.50 (1.50 - 3.50)
b3-32 (0BC1) Expert	Spd Search Current Complete Lvl	V/f OLV OLV/PM AOLV/PM EZOLV Sets the current level that completes Speed Search.	1.20 (0.00 - 1.49)
b3-33 (0B3F) Expert	Speed Search during Uv Selection	V/f OLV OLV/PM AOLV/PM EZOLV Sets the function that starts Speed Search at start-up if the drive detects a <i>Uv [Undervoltage]</i> when it receives a Run command. 0 : Disabled 1 : Enabled	1 (0, 1)
b3-39 (1B8F) Expert	Regen Judgment Lv of Spd Search	V/f OLV OLV/PM AOLV/PM EZOLV Sets the level to determine the regenerative state during speed search. Usually it is not necessary to change this setting.	15% (0 - 50%)
b3-54 (3123)	Search Time	V/f OLV OLV/PM AOLV/PM EZOLV Sets the length of time that the drive will run Speed Search.	400 ms (10 - 2000 ms)
b3-55 (3124) Expert	Current Increment Time	V/f OLV OLV/PM AOLV/PM EZOLV Sets the length of time that the drive will increase the current from zero current to the setting value of <i>b3-06 [Speed Estimation Current Level 1]</i> .	10 ms (10 - 2000 ms)
b3-56 (3126)	InverseRotationSearch WaitTime	V/f OLV OLV/PM AOLV/PM EZOLV Sets the wait time until the drive starts inverse rotation search after it completes forward search when you do inverse rotation search during Current Detection Speed Search.	Determined by o2-04 (0.1 - 5.0 s)
b3-61 (1B96) Expert	Initial Pole Detection Response Gain	V/f OLV OLV/PM AOLV/PM EZOLV Sets the responsiveness for initial motor magnetic pole calculation when <i>A1-02 = 6 [Control Method Selection = AOLV/PM]</i> . Set <i>b3-61 > 0.0</i> for an ordinary IPM motor. It is automatically set if High Frequency Injection Tuning is used. Note: • Set <i>n8-35 = 1 [Initial Pole Calculation Method = High Frequency Injection]</i> to enable this parameter. • Set <i>n8-41 [HFI P Gain]</i> to adjust the responsiveness for initial motor magnetic pole calculation when <i>A1-02 = 5 [OLV/PM]</i> .	5.0 (-20.0 - +20.0)

◆ b4: Timer Function

No. (Hex.)	Name	Description	Default (Range)
b4-01 (01A3)	Timer Function ON-Delay Time	V/f OLV OLV/PM AOLV/PM EZOLV Sets the ON-delay time for the timer input.	0.0 s (0.0 - 3000.0 s)
b4-02 (01A4)	Timer Function OFF-Delay Time	V/f OLV OLV/PM AOLV/PM EZOLV Sets the OFF-delay time for the timer input.	0.0 s (0.0 - 3000.0 s)
b4-03 (0B30) Expert	Terminal M1-M2 ON-Delay Time	V/f OLV OLV/PM AOLV/PM EZOLV Sets the delay time to activate the contact after the function set in <i>H2-01</i> activates.	0 ms (0 - 65000 ms)
b4-04 (0B31) Expert	Terminal M1-M2 OFF-Delay Time	V/f OLV OLV/PM AOLV/PM EZOLV Sets the delay time to deactivate the contact after the function set in <i>H2-01</i> deactivates.	0 ms (0 - 65000 ms)
b4-05 (0B32) Expert	Terminal M3-M4 ON-Delay Time	V/f OLV OLV/PM AOLV/PM EZOLV Sets the delay time to activate the contact after the function set in <i>H2-02</i> activates.	0 ms (0 - 65000 ms)

1.5 b: Application

No. (Hex.)	Name	Description	Default (Range)
b4-06 (0B33) Expert	Terminal M3-M4 OFF-Delay Time	V/f OLV OLV/IPM AOLV/IPM EZOLV Sets the delay time to deactivate the contact after the function set in H2-02 deactivates.	0 ms (0 - 65000 ms)
b4-07 (0B34) Expert	Terminal P2 ON-Delay Time	V/f OLV OLV/IPM AOLV/IPM EZOLV Sets the delay time until the contact is turned ON after the function set with H2-03 turns ON.	0 ms (0 - 65000 ms)
b4-08 (0B35) Expert	Terminal P2 OFF-Delay Time	V/f OLV OLV/IPM AOLV/IPM EZOLV Sets the delay time to deactivate the contact after the function set in H2-03 deactivates.	0 ms (0 - 65000 ms)

◆ b5: PID control

No. (Hex.)	Name	Description	Default (Range)
b5-01 (01A5)	PID Mode Setting	V/f OLV OLV/IPM AOLV/IPM EZOLV Sets the type of PID control. 0 : Disabled 1 : Standard 2 : Standard (D on feedback) 3 : Fref + PID Trim 4 : Fref + PID Trim (D on feedback) 5 : Same as 7series & prior, b5-01=1 6 : Same as 7series & prior, b5-01=2 7 : Same as 7series & prior, b5-01=3 8 : Same as 7series & prior, b5-01=4 Note: Use settings 5 to 8 instead of settings 1 to 4 when the drive is a replacement for Varispeed F7.	0 (0 - 8)
b5-02 (01A6) RUN	Proportional Gain (P)	V/f OLV OLV/IPM AOLV/IPM EZOLV Sets the proportional gain (P) that is applied to PID input.	1.00 (0.00 - 25.00)
b5-03 (01A7) RUN	Integral Time (I)	V/f OLV OLV/IPM AOLV/IPM EZOLV Sets the integral time (I) that is applied to PID input.	1.0 s (0.0 - 360.0 s)
b5-04 (01A8) RUN	Integral Limit	V/f OLV OLV/IPM AOLV/IPM EZOLV Sets the upper limit for integral control (I) as a percentage of the Maximum Output Frequency. Note: Parameter A1-02 [Control Method Selection] selects which parameter is the maximum output frequency. • A1-02 ≠ 8 [EZOLV]: E1-04 [Maximum Output Frequency] • A1-02 = 8: E9-02 [Maximum Speed]	100.0% (0.0 - 100.0%)
b5-05 (01A9) RUN	Derivative Time (D)	V/f OLV OLV/IPM AOLV/IPM EZOLV Sets the derivative time (D) for PID control. This parameter adjusts system responsiveness.	0.00 s (0.00 - 10.00 s)
b5-06 (01AA) RUN	PID Output Limit	V/f OLV OLV/IPM AOLV/IPM EZOLV Sets the maximum possible output from the PID controller as a percentage of the Maximum Output Frequency. Note: Parameter A1-02 [Control Method Selection] selects which parameter is the maximum output frequency. • A1-02 ≠ 8 [EZOLV]: E1-04 [Maximum Output Frequency] • A1-02 = 8: E9-02 [Maximum Speed]	100.0% (0.0 - 100.0%)
b5-07 (01AB) RUN	PID Offset Adjustment	V/f OLV OLV/IPM AOLV/IPM EZOLV Sets the offset for the PID control output as a percentage of the Maximum Output Frequency. Note: Parameter A1-02 [Control Method Selection] selects which parameter is the maximum output frequency. • A1-02 ≠ 8 [EZOLV]: E1-04 [Maximum Output Frequency] • A1-02 = 8: E9-02 [Maximum Speed]	0.0% (-100.0 - +100.0%)
b5-08 (01AC) RUN Expert	PID Primary Delay Time Constant	V/f OLV OLV/IPM AOLV/IPM EZOLV Sets the primary delay time constant for the PID control output. Usually it is not necessary to change this setting.	0.00 s (0.00 - 10.00 s)

No. (Hex.)	Name	Description	Default (Range)
b5-09 (01AD)	PID Output Level Selection	V/f OLV OLV/PM AOLV/PM EZOLV Sets the polarity of the PID output. 0 : Normal Output (Direct Acting) 1 : Reverse Output (Reverse Acting)	0 (0, 1)
b5-10 (01AE) RUN	PID Output Gain Setting	V/f OLV OLV/PM AOLV/PM EZOLV Sets the amount of gain to apply to the PID output.	1.00 (0.00 - 25.00)
b5-11 (01AF)	PID Output Reverse Selection	V/f OLV OLV/PM AOLV/PM EZOLV Sets the function that enables and disables reverse motor rotation for negative PID control output. 0 : Lower Limit is Zero 1 : Negative Output Accepted	0 (0, 1)
b5-12 (01B0)	Feedback Loss Detection Select	V/f OLV OLV/PM AOLV/PM EZOLV Sets the drive response to PID feedback loss/excess. Sets drive operation after the drive detects PID feedback loss/excess. 0 : Digital Out Only, Always Detect 1 : Alarm + Digital Out, Always Det 2 : Fault + Digital Out, Always Det 3 : Digital Out Only, @ PID Enable 4 : Alarm + Digital Out, @PID Enable 5 : Fault + Digital Out, @PID Enable	0 (0 - 5)
b5-13 (01B1)	PID Feedback Loss Detection Lvl	V/f OLV OLV/PM AOLV/PM EZOLV Sets the level that triggers <i>PID Feedback Loss [FbL]</i> detection as a percentage of the Maximum Output Frequency. Note: Parameter <i>A1-02 [Control Method Selection]</i> selects which parameter is the maximum output frequency. • <i>A1-02 ≠ 8 [EZOLV]: E1-04 [Maximum Output Frequency]</i> • <i>A1-02 = 8: E9-02 [Maximum Speed]</i>	0% (0 - 100%)
b5-14 (01B2)	PID Feedback Loss Detection Time	V/f OLV OLV/PM AOLV/PM EZOLV Sets the length of time that PID Feedback must be less than <i>b5-13 [PID Feedback Loss Detection Lvl]</i> to detect <i>PID Feedback Loss [FbL]</i> .	1.0 s (0.0 - 25.5 s)
b5-15 (01B3)	PID Sleep Function Start Level	V/f OLV OLV/PM AOLV/PM EZOLV Sets the output level that triggers the PID Sleep function.	Determined by A1-02 (0.0 - 590.0)
b5-16 (01B4)	PID Sleep Delay Time	V/f OLV OLV/PM AOLV/PM EZOLV Sets a delay time to start or stop the PID Sleep function.	0.0 s (0.0 - 25.5 s)
b5-17 (01B5) RUN	PID Accel/Decel Time	V/f OLV OLV/PM AOLV/PM EZOLV Raises or lowers the PID setpoint using the acceleration and deceleration times set to the drive. This is a soft-starter for the PID setpoint.	0.0 s (0.0 - 6000.0 s)
b5-18 (01DC)	b5-19 PID Setpoint Selection	V/f OLV OLV/PM AOLV/PM EZOLV Sets the function that enables and disables <i>b5-19 [PID Setpoint Value]</i> . 0 : Disabled 1 : Enabled	0 (0, 1)
b5-19 (01DD) RUN	PID Setpoint Value	V/f OLV OLV/PM AOLV/PM EZOLV Sets the PID setpoint when <i>b5-18 = 1 [b5-19 PID Setpoint Selection = Enabled]</i> .	0.00% (0.00 - 100.00%)
b5-20 (01E2)	PID Unit Selection	V/f OLV OLV/PM AOLV/PM EZOLV Sets the number of digits to set and show the PID setpoint. 0 : 0.01Hz units 1 : 0.01% units 2 : rev/min 3 : User Units	1 (0 - 3)
b5-34 (019F) RUN	PID Output Lower Limit Level	V/f OLV OLV/PM AOLV/PM EZOLV Sets the lower limit level for the PID control as a percentage of <i>E1-04 [Maximum Output Frequency]</i> . When you use <i>b5-34</i> , set <i>b5-91 = 0 [EZ Sleep Minimum Speed = 0 (Disabled)]</i> . When you set the output lower limit level as Hz units or min ⁻¹ (r/min) units, refer to page 196. Note: Parameter <i>A1-02 [Control Method Selection]</i> selects which parameter is the maximum output frequency. • <i>A1-02 ≠ 8 [EZOLV]: E1-04 [Maximum Output Frequency]</i> • <i>A1-02 = 8: E9-02 [Maximum Speed]</i>	0.0% (-100.0 - +100.0%)

1.5 b: Application

No. (Hex.)	Name	Description	Default (Range)
b5-35 (01A0) RUN	PID Input Limit Level	<p><input type="checkbox"/> V/f <input type="checkbox"/> OLV <input type="checkbox"/> OLV/IPM <input type="checkbox"/> AOLV/IPM <input type="checkbox"/> EZOLV</p> <p>Sets the output upper limit for the PID control as a percentage of the Maximum Output Frequency.</p> <p>Note: Parameter <i>A1-02 [Control Method Selection]</i> selects which parameter is the maximum output frequency. • <i>A1-02 ≠ 8 [EZOLV]: E1-04 [Maximum Output Frequency]</i> • <i>A1-02 = 8: E9-02 [Maximum Speed]</i></p>	1000.0% (0.0 - 1000.0%)
b5-36 (01A1)	PID High Feedback Detection Lvl	<p><input type="checkbox"/> V/f <input type="checkbox"/> OLV <input type="checkbox"/> OLV/IPM <input type="checkbox"/> AOLV/IPM <input type="checkbox"/> EZOLV</p> <p>Sets the level that triggers <i>Excessive PID Feedback [FbH]</i> as a percentage of the Maximum Output Frequency.</p> <p>Note: Parameter <i>A1-02 [Control Method Selection]</i> selects which parameter is the maximum output frequency. • <i>A1-02 ≠ 8 [EZOLV]: E1-04 [Maximum Output Frequency]</i> • <i>A1-02 = 8: E9-02 [Maximum Speed]</i></p>	100% (0 - 100%)
b5-37 (01A2)	PID High Feedback Detection Time	<p><input type="checkbox"/> V/f <input type="checkbox"/> OLV <input type="checkbox"/> OLV/IPM <input type="checkbox"/> AOLV/IPM <input type="checkbox"/> EZOLV</p> <p>Sets the length of time that the PID feedback signal must be more than the level set in <i>b5-36 [PID Feedback High Detection Lvl]</i> to cause <i>Excessive PID Feedback [FbH]</i>.</p>	1.0 s (0.0 - 25.5 s)
b5-38 (01FE)	PID User Unit Display Scaling	<p><input type="checkbox"/> V/f <input type="checkbox"/> OLV <input type="checkbox"/> OLV/IPM <input type="checkbox"/> AOLV/IPM <input type="checkbox"/> EZOLV</p> <p>Sets the value that the drive sets or shows as the PID setpoint when at the maximum output frequency.</p>	Determined by b5-20 (1 - 60000)
b5-39 (01FF)	PID User Unit Display Digits	<p><input type="checkbox"/> V/f <input type="checkbox"/> OLV <input type="checkbox"/> OLV/IPM <input type="checkbox"/> AOLV/IPM <input type="checkbox"/> EZOLV</p> <p>Sets the number of digits to set and show the PID setpoint. 0 : No Decimal Places (XXXXX) 1 : One Decimal Places (XXXX.X) 2 : Two Decimal Places (XXX.XX) 3 : Three Decimal Places (XX.XXX)</p>	Determined by b5-20 (0 - 3)
b5-40 (017F)	Frequency Reference Monitor @PID	<p><input type="checkbox"/> V/f <input type="checkbox"/> OLV <input type="checkbox"/> OLV/IPM <input type="checkbox"/> AOLV/IPM <input type="checkbox"/> EZOLV</p> <p>Sets the contents for monitor <i>U1-01 [Frequency Reference]</i> in PID control. 0 : U1-01 Includes PID Output 1 : U1-01 Excludes PID Output</p>	0 (0, 1)
b5-47 (017D)	PID Trim Mode Output Reverse Sel	<p><input type="checkbox"/> V/f <input type="checkbox"/> OLV <input type="checkbox"/> OLV/IPM <input type="checkbox"/> AOLV/IPM <input type="checkbox"/> EZOLV</p> <p>Sets reverse motor rotation when the PID control output is negative. 0 : Lower Limit is Zero 1 : Negative Output Accepted</p>	1 (0, 1)
b5-53 (0B8F) RUN	PID Integrator Ramp Limit	<p><input type="checkbox"/> V/f <input type="checkbox"/> OLV <input type="checkbox"/> OLV/IPM <input type="checkbox"/> AOLV/IPM <input type="checkbox"/> EZOLV</p> <p>Sets the responsiveness of PID control when the PID feedback changes quickly.</p>	0.0 Hz (0.0 - 10.0 Hz)
b5-55 (0BE1)	PID Feedback Monitor Selection	<p><input type="checkbox"/> V/f <input type="checkbox"/> OLV <input type="checkbox"/> OLV/IPM <input type="checkbox"/> AOLV/IPM <input type="checkbox"/> EZOLV</p> <p>Sets the monitor (<i>Ux-xx</i>) used as the PID Feedback. Set the <i>x-xx</i> part of the <i>Ux-xx [Monitor]</i>.</p>	000 (000 - 999)
b5-56 (0BE2)	PID Feedback Monitor Gain	<p><input type="checkbox"/> V/f <input type="checkbox"/> OLV <input type="checkbox"/> OLV/IPM <input type="checkbox"/> AOLV/IPM <input type="checkbox"/> EZOLV</p> <p>Sets the gain for the monitor set in <i>b5-55 [PID Feedback Monitor Selection]</i>.</p>	1.00 (0.00 - 10.00)
b5-57 (11DD)	PID Feedback Monitor Bias	<p><input type="checkbox"/> V/f <input type="checkbox"/> OLV <input type="checkbox"/> OLV/IPM <input type="checkbox"/> AOLV/IPM <input type="checkbox"/> EZOLV</p> <p>Sets the bias for the monitor specified in <i>b5-55 [PID Feedback Monitor Selection]</i>.</p>	0.00 (-10.00 - +10.00)
b5-58 (1182) RUN	PID Setpoints 2	<p><input type="checkbox"/> V/f <input type="checkbox"/> OLV <input type="checkbox"/> OLV/IPM <input type="checkbox"/> AOLV/IPM <input type="checkbox"/> EZOLV</p> <p>Sets the PID setpoint when <i>H1-xx = 3E or 3F [MFDI Function Select = PID Setpoint Selection 1/2]</i>. This value is a percentage of the maximum output frequency.</p> <p>Note: Parameter <i>A1-02 [Control Method Selection]</i> selects which parameter is the maximum output frequency. • <i>A1-02 ≠ 8 [EZOLV]: E1-04 [Maximum Output Frequency]</i> • <i>A1-02 = 8: E9-02 [Maximum Speed]</i></p>	0.00% (0.00 - 100.00%)
b5-59 (1183) RUN	PID Setpoints 3	<p><input type="checkbox"/> V/f <input type="checkbox"/> OLV <input type="checkbox"/> OLV/IPM <input type="checkbox"/> AOLV/IPM <input type="checkbox"/> EZOLV</p> <p>Sets the PID setpoint when <i>H1-xx = 3E or 3F [MFDI Function Select = PID Setpoint Selection 1/2]</i>. This value is a percentage of the maximum output frequency.</p> <p>Note: Parameter <i>A1-02 [Control Method Selection]</i> selects which parameter is the maximum output frequency. • <i>A1-02 ≠ 8 [EZOLV]: E1-04 [Maximum Output Frequency]</i> • <i>A1-02 = 8: E9-02 [Maximum Speed]</i></p>	0.00% (0.00 - 100.00%)

No. (Hex.)	Name	Description	Default (Range)
b5-60 (1184) RUN	PID Setpoints 4	V/f OLV OLV/PM AOLV/PM EZOLV Sets the PID setpoint when $H1-xx = 3E$ or $3F$ [MFDI Function Select = PID Setpoint Selection 1/2]. This value is a percentage of the maximum output frequency. Note: Parameter $A1-02$ [Control Method Selection] selects which parameter is the maximum output frequency. • $A1-02 \neq 8$ [EZOLV]: $E1-04$ [Maximum Output Frequency] • $A1-02 = 8$: $E9-02$ [Maximum Speed]	0.00% (0.00 - 100.00%)
b5-61 (119A)	PID Trim Mode Lower Limit Sel	V/f OLV OLV/PM AOLV/PM EZOLV Sets the function that adjusts the PID output in relation to the frequency reference. 0 : Disabled 1 : Enabled	0 (0, 1)
b5-62 (119B)	PID Trim Mode Lower Limit Value	V/f OLV OLV/PM AOLV/PM EZOLV Sets the PID Trim Mode Lower Limit Value as a percentage of the maximum output frequency. Note: Parameter $A1-02$ [Control Method Selection] selects which parameter is the maximum output frequency. • $A1-02 \neq 8$ [EZOLV]: $E1-04$ [Maximum Output Frequency] • $A1-02 = 8$: $E9-02$ [Maximum Speed]	0.00% (0.00 - 100.00%)
b5-63 (119C)	PID Differential FB Monitor Sel	V/f OLV OLV/PM AOLV/PM EZOLV Selects the monitor ($Ux-xx$) used as the PID Differential Feedback. Set the $x-xx$ part of the $Ux-xx$ [Monitor].	000 (000 - 999)
b5-64 (119D)	PID Differential FB Monitor Gain	V/f OLV OLV/PM AOLV/PM EZOLV Sets the gain for the monitor specified in $b5-63$ [PID Differential FB Monitor Sel].	1.00 (0.00 - 10.00)
b5-65 (119F)	PID Differential FB Monitor Bias	V/f OLV OLV/PM AOLV/PM EZOLV Sets the bias for the monitor specified in $b5-63$ [PID Differential FB Monitor Sel].	0.00 (-10.00 - +10.00)
b5-66 (11DE)	PID Feedback Monitor Level	V/f OLV OLV/PM AOLV/PM EZOLV Sets the signal level for the monitor specified in $b5-55$ [PID Feedback Monitor Selection]. 0 : Absolute 1 : Bi-directional (+/-)	0 (0, 1)
b5-67 (11DF)	PID Differential FB Monitor Lvl	V/f OLV OLV/PM AOLV/PM EZOLV Sets the signal level for the monitor specified in $b5-63$ [PID Differential FB Monitor Sel]. 0 : Absolute 1 : Bi-directional (+/-)	0 (0, 1)
b5-89 (0B89) RUN	Sleep Method Selection	V/f OLV OLV/PM AOLV/PM EZOLV Sets sleep and wake up operation when using PID. 0 : Standard 1 : EZ Sleep/Wake-up	0 (0, 1)
b5-90 (0B90)	EZ Sleep Unit	V/f OLV OLV/PM AOLV/PM EZOLV Sets the measurement units for $b5-91$ [EZ Sleep Minimum Speed] and $b5-92$ [EZ Sleep Level]. 0 : 0.1Hz units 1 : rev/min	0 (0, 1)
b5-91 (0B91) RUN	EZ Sleep Minimum Speed	V/f OLV OLV/PM AOLV/PM EZOLV Sets the output lower limit level for the PID control as Hz units or min^{-1} (r/min) units. When you use $b5-91$, set $b5-34 = 0.0$ [PID Output Lower Limit Level = 0.0 (disabled)]. When you set the output lower limit for PID output as a percentage of the Maximum Output Frequency, refer to page 191.	0.0 Hz or 0 min^{-1} (r/min) (0.0 to 590.0 Hz or 0 to 35400 min^{-1} (r/min))
b5-92 (0B92) RUN	EZ Sleep Level	V/f OLV OLV/PM AOLV/PM EZOLV Sets the value that the output frequency or motor speed must be less than for longer than $b5-93$ [EZ Sleep Time] to enter Sleep Mode.	0.0 Hz or 0 min^{-1} (r/min) (0.0 to 590.0 Hz or 0 to 35400 min^{-1} (r/min))
b5-93 (0B93) RUN	EZ Sleep Time	V/f OLV OLV/PM AOLV/PM EZOLV Sets the length of time that the output frequency or motor speed must be less than $b5-92$ [EZ Sleep Level] to enter Sleep Mode.	5.0 s (0.0 - 1000.0 s)
b5-94 (0B94) RUN	EZ Sleep Wake-up Level	V/f OLV OLV/PM AOLV/PM EZOLV Sets the level at which the drive resumes operation when exiting Sleep Mode.	0.00% (0.00 - 600.00%)

1.5 b: Application

No. (Hex.)	Name	Description	Default (Range)
b5-95 (0B95)	EZ Sleep Wake-up Mode	<p><input type="checkbox"/> V/f <input type="checkbox"/> OLV <input type="checkbox"/> OLV/PM <input type="checkbox"/> AOLV/PM <input type="checkbox"/> EZOLV</p> <p>Sets the wake-up mode to use when exiting Sleep Mode. 0 : Absolute 1 : Setpoint Delta</p>	0 (0, 1)
b5-96 (0B96) RUN	EZ Sleep Wake-up Time	<p><input type="checkbox"/> V/f <input type="checkbox"/> OLV <input type="checkbox"/> OLV/PM <input type="checkbox"/> AOLV/PM <input type="checkbox"/> EZOLV</p> <p>Sets the EZ Wake-up time.</p>	1.0 s (0.0 - 1000.0 s)

◆ b6: Dwell Function

No. (Hex.)	Name	Description	Default (Range)
b6-01 (01B6)	Dwell Reference at Start	<p><input type="checkbox"/> V/f <input type="checkbox"/> OLV <input type="checkbox"/> OLV/PM <input type="checkbox"/> AOLV/PM <input type="checkbox"/> EZOLV</p> <p>Sets the output frequency that the drive will hold momentarily when the motor starts.</p>	0.0 (Determined by A1-02)
b6-02 (01B7)	Dwell Time at Start	<p><input type="checkbox"/> V/f <input type="checkbox"/> OLV <input type="checkbox"/> OLV/PM <input type="checkbox"/> AOLV/PM <input type="checkbox"/> EZOLV</p> <p>Sets the length of time that the drive will hold the output frequency when the motor starts.</p>	0.0 s (0.0 - 10.0 s)
b6-03 (01B8)	Dwell Reference at Stop	<p><input type="checkbox"/> V/f <input type="checkbox"/> OLV <input type="checkbox"/> OLV/PM <input type="checkbox"/> AOLV/PM <input type="checkbox"/> EZOLV</p> <p>Sets the output frequency that the drive will hold momentarily when ramping to stop the motor.</p>	0.0 (Determined by A1-02)
b6-04 (01B9)	Dwell Time at Stop	<p><input type="checkbox"/> V/f <input type="checkbox"/> OLV <input type="checkbox"/> OLV/PM <input type="checkbox"/> AOLV/PM <input type="checkbox"/> EZOLV</p> <p>Sets the length of time for the drive to hold the output frequency when ramping to stop the motor.</p>	0.0 s (0.0 - 10.0 s)

◆ b8: Energy Saving

No. (Hex.)	Name	Description	Default (Range)
b8-01 (01CC)	Energy Saving Control Selection	<p><input type="checkbox"/> V/f <input type="checkbox"/> OLV <input type="checkbox"/> OLV/PM <input type="checkbox"/> AOLV/PM <input type="checkbox"/> EZOLV</p> <p>Sets the Energy-saving control function. 0 : Disabled 1 : Enabled 2 : Automatic Optimization Note: When A1-02 = 6 [Control Method Selection = AOLV/PM], you can only select setting 2 in Expert Mode.</p>	0 (0 - 2)
b8-02 (01CD) RUN Expert	Energy Saving Gain	<p><input type="checkbox"/> V/f <input type="checkbox"/> OLV <input type="checkbox"/> OLV/PM <input type="checkbox"/> AOLV/PM <input type="checkbox"/> EZOLV</p> <p>Sets the gain for Energy-saving control.</p>	Determined by A1-02 (0.0 - 10.0)
b8-03 (01CE) RUN Expert	Energy Saving Filter Time	<p><input type="checkbox"/> V/f <input type="checkbox"/> OLV <input type="checkbox"/> OLV/PM <input type="checkbox"/> AOLV/PM <input type="checkbox"/> EZOLV</p> <p>Sets the responsiveness for Energy-saving control.</p>	Determined by A1-02 , C6-01 and o2-04 (0.00 - 10.00 s)
b8-04 (01CF) Expert	Energy Saving Coefficient Value	<p><input type="checkbox"/> V/f <input type="checkbox"/> OLV <input type="checkbox"/> OLV/PM <input type="checkbox"/> AOLV/PM <input type="checkbox"/> EZOLV</p> <p>Sets the Energy-saving control coefficient to maintain maximum motor efficiency. The default setting is for Yaskawa motors.</p>	Determined by C6-01, E2-11, and o2-04 (0.00 - 655.00)
b8-05 (01D0) Expert	Power Detection Filter Time	<p><input type="checkbox"/> V/f <input type="checkbox"/> OLV <input type="checkbox"/> OLV/PM <input type="checkbox"/> AOLV/PM <input type="checkbox"/> EZOLV</p> <p>Sets the time constant to measure output power.</p>	20 ms (0 - 2000 ms)
b8-06 (01D1) Expert	Search Operation Voltage Limit	<p><input type="checkbox"/> V/f <input type="checkbox"/> OLV <input type="checkbox"/> OLV/PM <input type="checkbox"/> AOLV/PM <input type="checkbox"/> EZOLV</p> <p>Sets the voltage limit for Search Operation as a percentage of the motor rated voltage.</p>	0% (0 - 100%)
b8-16 (01F8) Expert	PM E-Save Coefficient Ki	<p><input type="checkbox"/> V/f <input type="checkbox"/> OLV <input type="checkbox"/> OLV/PM <input type="checkbox"/> AOLV/PM <input type="checkbox"/> EZOLV</p> <p>Sets torque linearity. This parameter uses the Ki value from the motor nameplate. Usually it is not necessary to change this setting.</p>	1.00 (0.00 - 3.00)
b8-17 (01F9) Expert	PM E-Save Coefficient Kt	<p><input type="checkbox"/> V/f <input type="checkbox"/> OLV <input type="checkbox"/> OLV/PM <input type="checkbox"/> AOLV/PM <input type="checkbox"/> EZOLV</p> <p>Sets torque linearity. This parameter uses the Kt value from the motor nameplate. Usually it is not necessary to change this setting.</p>	1.00 (0.00 - 3.00)

No. (Hex.)	Name	Description	Default (Range)
b8-18 (01FA) Expert	E-Save d-axis Current FilterTime	<input type="checkbox"/> V/f <input type="checkbox"/> OLV <input type="checkbox"/> OLV/PM <input checked="" type="checkbox"/> AOLV/PM <input type="checkbox"/> EZOLV Sets the d-axis current reference filter time constant.	0.100 s (0.000 - 5.000 s)
b8-19 (0B40) Expert	E-Save Search Frequency	<input type="checkbox"/> V/f <input type="checkbox"/> OLV <input type="checkbox"/> OLV/PM <input checked="" type="checkbox"/> AOLV/PM <input type="checkbox"/> EZOLV Sets the frequency of Energy-saving control search operations. Usually it is not necessary to change this setting.	Determined by A1-02 (10 - 300 Hz)
b8-20 (0B41) Expert	E-Save Search Width	<input type="checkbox"/> V/f <input type="checkbox"/> OLV <input type="checkbox"/> OLV/PM <input checked="" type="checkbox"/> AOLV/PM <input type="checkbox"/> EZOLV Sets the amplitude of Energy-saving control search operations.	1.0 degrees (0.1 - 5.0 degrees)
b8-21 (0B42) Expert	PM E-Save Search Gain	<input type="checkbox"/> V/f <input type="checkbox"/> OLV <input type="checkbox"/> OLV/PM <input checked="" type="checkbox"/> AOLV/PM <input type="checkbox"/> EZOLV Sets the gain of Energy-saving control search operations.	0.3Hz (0.1 - 20.0 Hz)
b8-22 (0B43) Expert	PM E-Save Search LPF Cutoff Freq	<input type="checkbox"/> V/f <input type="checkbox"/> OLV <input type="checkbox"/> OLV/PM <input checked="" type="checkbox"/> AOLV/PM <input type="checkbox"/> EZOLV Sets the frequency of the filter used to extract the high-efficiency phase from search operations. Usually it is not necessary to change this setting.	10.0 Hz (1.0 - 30.0 Hz)
b8-23 (0B44) Expert	PM E-Save Search Limit	<input type="checkbox"/> V/f <input type="checkbox"/> OLV <input type="checkbox"/> OLV/PM <input checked="" type="checkbox"/> AOLV/PM <input type="checkbox"/> EZOLV Sets the search operations output limit. Usually it is not necessary to change this setting.	15.0 degrees (0.0 - 30.0 degrees)
b8-24 (0B45) Expert	PM E-Save High Freq ACR Gain	<input type="checkbox"/> V/f <input type="checkbox"/> OLV <input type="checkbox"/> OLV/PM <input checked="" type="checkbox"/> AOLV/PM <input type="checkbox"/> EZOLV Sets the gain for high-frequency current control.	200.0 Hz (100.0 - 1000.0 Hz)
b8-25 (0B46) Expert	PM E-Save Search Start Level	<input type="checkbox"/> V/f <input type="checkbox"/> OLV <input type="checkbox"/> OLV/PM <input checked="" type="checkbox"/> AOLV/PM <input type="checkbox"/> EZOLV Sets the start level for search operations.	10.0% (0.0 - 100.0%)
b8-26 (0B47) Expert	PM E-Save Power Setpoint	<input type="checkbox"/> V/f <input type="checkbox"/> OLV <input type="checkbox"/> OLV/PM <input checked="" type="checkbox"/> AOLV/PM <input type="checkbox"/> EZOLV Sets a value to increase torque accuracy.	0.0% (-10.0 - +10.0%)
b8-28 (0B8B) Expert	Over Excitation Action Selection	<input type="checkbox"/> V/f <input type="checkbox"/> OLV <input type="checkbox"/> OLV/PM <input checked="" type="checkbox"/> AOLV/PM <input type="checkbox"/> EZOLV Sets the function for excitation operation. 0 : Disabled 1 : Enabled	0 (0, 1)
b8-29 (0B8C)	Energy Saving Priority Selection	<input type="checkbox"/> V/f <input type="checkbox"/> OLV <input type="checkbox"/> OLV/PM <input checked="" type="checkbox"/> AOLV/PM <input type="checkbox"/> EZOLV Sets the priority of drive response between changes to the load or Energy-saving control. Enable this to prioritize energy-saving control. Disable this to prioritize tracking related to fast load changes, and prevent motor stall. 0 : Priority: Drive Response 1 : Priority: Energy Savings	0 (0, 1)

1.6 C: Tuning

◆ C1: Accel & Decel Time

No. (Hex.)	Name	Description	Default (Range)
C1-01 (0200) RUN	Acceleration Time 1	V/f OLV OLV/PM AOLV/PM EZOLV Sets the length of time to accelerate from zero to maximum output frequency.	10.0 s (0.0 - 6000.0 s)
C1-02 (0201) RUN	Deceleration Time 1	V/f OLV OLV/PM AOLV/PM EZOLV Sets the length of time to decelerate from maximum output frequency to zero.	10.0 s (0.0 - 6000.0 s)
C1-03 (0202) RUN	Acceleration Time 2	V/f OLV OLV/PM AOLV/PM EZOLV Sets the length of time to accelerate from zero to maximum output frequency.	10.0 s (0.0 - 6000.0 s)
C1-04 (0203) RUN	Deceleration Time 2	V/f OLV OLV/PM AOLV/PM EZOLV Sets the length of time to decelerate from maximum output frequency to zero.	10.0 s (0.0 - 6000.0 s)
C1-05 (0204) RUN	Acceleration Time 3	V/f OLV OLV/PM AOLV/PM EZOLV Sets the length of time to accelerate from zero to maximum output frequency.	10.0 s (0.0 - 6000.0 s)
C1-06 (0205) RUN	Deceleration Time 3	V/f OLV OLV/PM AOLV/PM EZOLV Sets the length of time to decelerate from maximum output frequency to zero.	10.0 s (0.0 - 6000.0 s)
C1-07 (0206) RUN	Acceleration Time 4	V/f OLV OLV/PM AOLV/PM EZOLV Sets the length of time to accelerate from zero to maximum output frequency.	10.0 s (0.0 - 6000.0 s)
C1-08 (0207) RUN	Deceleration Time 4	V/f OLV OLV/PM AOLV/PM EZOLV Sets the length of time to decelerate from maximum output frequency to zero.	10.0 s (0.0 - 6000.0 s)
C1-09 (0208) RUN	Fast Stop Time	V/f OLV OLV/PM AOLV/PM EZOLV Sets the length of time that the drive will decelerate to zero for a Fast Stop. Note: • Decelerating too quickly can cause an <i>ov</i> [Overvoltage] fault that shuts off the drive while the motor to coasts to a stop. Set a Fast Stop time in <i>C1-09</i> that prevents motor coasting and makes sure that the motor stops quickly and safely. • When <i>L2-29 = 0</i> [Kinetic Energy Backup Method = Single Drive KEB Ride-Thru 1] and you do KEB Auto-Tuning, the drive will automatically set <i>C1-09</i> . If you must not change the Fast Stop time, do not do KEB Tuning.	10.0 s (0.0 - 6000.0 s)
C1-10 (0209)	Accel/Decel Time Setting Units	V/f OLV OLV/PM AOLV/PM EZOLV Sets the setting units for <i>C1-01</i> to <i>C1-08</i> [Accel/Decel Times 1 to 4], <i>C1-09</i> [Fast Stop Time], <i>L2-06</i> [Kinetic Energy Backup Decel Time], and <i>L2-07</i> [Kinetic Energy Backup Accel Time]. 0 : 0.01 s (0.00 to 600.00 s) 1 : 0.1 s (0.0 to 6000.0 s)	1 (0, 1)
C1-11 (020A)	Accel/Decel Time Switching Frequency	V/f OLV OLV/PM AOLV/PM EZOLV Sets the frequency at which the drive will automatically change acceleration and deceleration times.	Determined by A1-02 (0.0 - 590.0 Hz)
C1-14 (0264) RUN	Accel/Decel Rate Frequency	V/f OLV OLV/PM AOLV/PM EZOLV Sets the base frequency used to calculate acceleration and deceleration rates.	0.0 Hz (0.0 - 590.0 Hz)

◆ C2: S-Curve Characteristics

No. (Hex.)	Name	Description	Default (Range)
C2-01 (020B)	S-Curve Time @ Start of Accel	V/f OLV OLV/PM AOLV/PM EZOLV Sets the S-curve acceleration time at start.	Determined by A1-02 (0.00 - 10.00 s)
C2-02 (020C)	S-Curve Time @ End of Accel	V/f OLV OLV/PM AOLV/PM EZOLV Sets the S-curve acceleration time at completion.	0.20 s (0.00 - 10.00 s)

No. (Hex.)	Name	Description	Default (Range)
C2-03 (020D)	S-Curve Time @ Start of Decel	<input type="checkbox"/> V/f <input checked="" type="checkbox"/> OLV <input type="checkbox"/> OLV/PM <input type="checkbox"/> AOLV/PM <input type="checkbox"/> EZOLV Sets the S-curve deceleration time at start.	0.20 s (0.00 - 10.00 s)
C2-04 (020E)	S-Curve Time @ End of Decel	<input type="checkbox"/> V/f <input checked="" type="checkbox"/> OLV <input type="checkbox"/> OLV/PM <input type="checkbox"/> AOLV/PM <input type="checkbox"/> EZOLV Sets the S-curve deceleration time at completion.	0.00 s (0.00 - 10.00 s)

◆ C3: Slip Compensation

No. (Hex.)	Name	Description	Default (Range)
C3-01 (020F) RUN	Slip Compensation Gain	<input type="checkbox"/> V/f <input checked="" type="checkbox"/> OLV <input type="checkbox"/> OLV/PM <input type="checkbox"/> AOLV/PM <input type="checkbox"/> EZOLV Sets the gain for the slip compensation function. Usually it is not necessary to change this setting. Note: Correctly set these parameters before changing the slip compensation gain: • E2-01 [Motor Rated Current (FLA)] • E2-02 [Motor Rated Slip] • E2-03 [Motor No-Load Current]	Determined by A1-02 (0.0 - 2.5)
C3-02 (0210) RUN	Slip Compensation Delay Time	<input type="checkbox"/> V/f <input checked="" type="checkbox"/> OLV <input type="checkbox"/> OLV/PM <input type="checkbox"/> AOLV/PM <input type="checkbox"/> EZOLV Sets the slip compensation delay time when speed is unstable or when the slip compensation response is too slow. Usually it is not necessary to change this setting.	Determined by A1-02 (0 - 10000 ms)
C3-03 (0211)	Slip Compensation Limit	<input type="checkbox"/> V/f <input checked="" type="checkbox"/> OLV <input type="checkbox"/> OLV/PM <input type="checkbox"/> AOLV/PM <input type="checkbox"/> EZOLV Sets the upper limit for the slip compensation function as a percentage of the motor rated slip.	200% (0 - 250%)
C3-04 (0212)	Slip Compensation at Regen	<input type="checkbox"/> V/f <input checked="" type="checkbox"/> OLV <input type="checkbox"/> OLV/PM <input type="checkbox"/> AOLV/PM <input type="checkbox"/> EZOLV Sets the slip compensation function during regeneration. 0 : Disabled 1 : Enabled Above 6Hz 2 : Enabled Above Defined Range	0 (0 - 2)
C3-05 (0213)	Output Voltage Limit Selection	<input type="checkbox"/> V/f <input checked="" type="checkbox"/> OLV <input type="checkbox"/> OLV/PM <input type="checkbox"/> AOLV/PM <input type="checkbox"/> EZOLV Sets the automatic reduction of motor magnetic flux when the output voltage is saturated. 0 : Disabled 1 : Enabled	0 (0, 1)
C3-16 (0261) Expert	Vout Modulation Limit Start Lvl	<input type="checkbox"/> V/f <input checked="" type="checkbox"/> OLV <input type="checkbox"/> OLV/PM <input type="checkbox"/> AOLV/PM <input type="checkbox"/> EZOLV Sets the modulation factor that starts the output voltage limit operation when C3-05 = 1 [Output Voltage Limit Selection = Enabled].	90.0% (70.0 - 90.0%)
C3-17 (0262) Expert	Vout Modulation Limit Max Level	<input type="checkbox"/> V/f <input checked="" type="checkbox"/> OLV <input type="checkbox"/> OLV/PM <input type="checkbox"/> AOLV/PM <input type="checkbox"/> EZOLV Sets the modulation factor used with C3-18 [Output Voltage Limit Level] for the output voltage limit operation when C3-05 = 1 [Output Voltage Limit Selection = Enabled].	100.0% (85.0 - 100.0%)
C3-18 (0263) Expert	Output Voltage Limit Level	<input type="checkbox"/> V/f <input checked="" type="checkbox"/> OLV <input type="checkbox"/> OLV/PM <input type="checkbox"/> AOLV/PM <input type="checkbox"/> EZOLV Sets the maximum drop width of the voltage reference when C3-05 = 1 [Output Voltage Limit Selection = Enabled].	90.0% (50.0 - 100.0%)
C3-21 (033E) RUN	Motor 2 Slip Compensation Gain	<input type="checkbox"/> V/f <input checked="" type="checkbox"/> OLV <input type="checkbox"/> OLV/PM <input type="checkbox"/> AOLV/PM <input type="checkbox"/> EZOLV Sets the gain for the motor 2 slip compensation function. Usually it is not necessary to change this setting. Note: Correctly set these parameters before changing the slip compensation gain: • E4-01 [Motor 2 Rated Current] • E4-02 [Motor 2 Rated Slip] • E4-03 [Motor 2 Rated No-Load Current]	Determined by E3-01 (0.0 - 2.5)
C3-22 (0241) RUN	Motor 2 Slip Comp Delay Time	<input type="checkbox"/> V/f <input checked="" type="checkbox"/> OLV <input type="checkbox"/> OLV/PM <input type="checkbox"/> AOLV/PM <input type="checkbox"/> EZOLV Sets the slip compensation delay time for motor 2 when speed is unstable or when the slip compensation response is too slow. Usually it is not necessary to change this setting.	Determined by E3-01 (0 - 10000 ms)
C3-23 (0242)	Motor 2 Slip Compensation Limit	<input type="checkbox"/> V/f <input checked="" type="checkbox"/> OLV <input type="checkbox"/> OLV/PM <input type="checkbox"/> AOLV/PM <input type="checkbox"/> EZOLV Sets the upper limit for the slip compensation function as a percentage of the motor 2 rated slip.	200% (0 - 250%)

No. (Hex.)	Name	Description	Default (Range)
C3-24 (0243)	Motor 2 Slip Comp during Regen	<p><input type="checkbox"/> V/f <input type="checkbox"/> OLV <input type="checkbox"/> OLV/PM <input type="checkbox"/> AOLV/PM <input type="checkbox"/> EZOLV</p> <p>Sets the slip compensation during regenerative operation function for motor 2.</p> <p>0 : Disabled 1 : Enabled Above 6Hz 2 : Enabled Above Defined Range</p>	0 (0 - 2)
C3-29 (1B5D) Expert	Slip Compensation Gain @ Low Spd	<p><input type="checkbox"/> V/f <input type="checkbox"/> OLV <input type="checkbox"/> OLV/PM <input type="checkbox"/> AOLV/PM <input type="checkbox"/> EZOLV</p> <p>Sets the gain for the slip compensation function in the low speed range. Usually it is not necessary to change this setting.</p>	0.0 (0.0 - 2.5)

◆ C4: Torque Compensation

No. (Hex.)	Name	Description	Default (Range)
C4-01 (0215) RUN	Torque Compensation Gain	<p><input type="checkbox"/> V/f <input type="checkbox"/> OLV <input type="checkbox"/> OLV/PM <input type="checkbox"/> AOLV/PM <input type="checkbox"/> EZOLV</p> <p>Sets the gain for the torque compensation function. Use this parameter value for motor 1 when operating multiple motors.</p> <p>Note: When A1-02 = 8 [Control Method Selection = EZOLV], you cannot change this parameter during drive run.</p>	Determined by A1-02 (0.00 - 2.50)
C4-02 (0216) RUN	Torque Compensation Delay Time	<p><input type="checkbox"/> V/f <input type="checkbox"/> OLV <input type="checkbox"/> OLV/PM <input type="checkbox"/> AOLV/PM <input type="checkbox"/> EZOLV</p> <p>Sets the torque compensation delay time. Usually it is not necessary to change this setting.</p> <p>Note: When A1-02 = 5, 8 [Control Method Selection = OLV/PM, EZOLV], you cannot change the setting while the drive is running.</p>	Determined by A1-02 (0 - 60000 ms)
C4-03 (0217)	Torque Compensation @ FWD Start	<p><input type="checkbox"/> V/f <input type="checkbox"/> OLV <input type="checkbox"/> OLV/PM <input type="checkbox"/> AOLV/PM <input type="checkbox"/> EZOLV</p> <p>Set the amount of torque reference for forward start as a percentage of the motor rated torque.</p>	0.0% (0.0 - 200.0%)
C4-04 (0218)	Torque Compensation @ REV Start	<p><input type="checkbox"/> V/f <input type="checkbox"/> OLV <input type="checkbox"/> OLV/PM <input type="checkbox"/> AOLV/PM <input type="checkbox"/> EZOLV</p> <p>Sets the amount of torque reference for reverse start as a percentage of the motor rated torque.</p>	0.0% (-200.0 - 0.0%)
C4-05 (0219)	Torque Compensation Time	<p><input type="checkbox"/> V/f <input type="checkbox"/> OLV <input type="checkbox"/> OLV/PM <input type="checkbox"/> AOLV/PM <input type="checkbox"/> EZOLV</p> <p>Sets the starting torque constant to use with C4-03 and C4-04 [Torque Compensation @ FWD/REV Start].</p>	10 ms (0 - 200 ms)
C4-06 (021A)	Motor 2 Torque Comp Delay Time	<p><input type="checkbox"/> V/f <input type="checkbox"/> OLV <input type="checkbox"/> OLV/PM <input type="checkbox"/> AOLV/PM <input type="checkbox"/> EZOLV</p> <p>Sets the value if <i>ov</i> [Overvoltage] occurs with sudden changes in the load, at the end of acceleration, or at the start of deceleration.</p>	150 ms (0 - 10000 ms)
C4-07 (0341) RUN	Motor 2 Torque Compensation Gain	<p><input type="checkbox"/> V/f <input type="checkbox"/> OLV <input type="checkbox"/> OLV/PM <input type="checkbox"/> AOLV/PM <input type="checkbox"/> EZOLV</p> <p>Sets the gain for motor 2 torque compensation function when using the Motor Switch function.</p>	1.00 (0.00 - 2.50)
C4-23 (1583) Expert	Current Control Gain	<p><input type="checkbox"/> V/f <input type="checkbox"/> OLV <input type="checkbox"/> OLV/PM <input type="checkbox"/> AOLV/PM <input type="checkbox"/> EZOLV</p> <p>Sets the Current control gain. Usually it is not necessary to change this parameter.</p>	1.00 (0.50 - 2.50)

◆ C5: Automatic Speed Regulator (ASR: Automatic Speed Regulator)

No. (Hex.)	Name	Description	Default (Range)
C5-01 (021B) RUN	ASR Proportional Gain 1	<p><input type="checkbox"/> V/f <input type="checkbox"/> OLV <input type="checkbox"/> OLV/PM <input type="checkbox"/> AOLV/PM <input type="checkbox"/> EZOLV</p> <p>Sets the gain to adjust ASR response.</p> <p>Note: When A1-02 = 0 [Control Method Selection = V/f], set H6-01 = 3 [Terminal RP Pulse Train Function = Speed Feedback (V/F Control)] to enable this parameter.</p>	Determined by A1-02 (0.00 - 300.00)
C5-02 (021C) RUN	ASR Integral Time 1	<p><input type="checkbox"/> V/f <input type="checkbox"/> OLV <input type="checkbox"/> OLV/PM <input type="checkbox"/> AOLV/PM <input type="checkbox"/> EZOLV</p> <p>Sets the ASR integral time.</p> <p>Note: When A1-02 = 0 [Control Method Selection = V/f], set H6-01 = 3 [Terminal RP Pulse Train Function = Speed Feedback (V/F Control)] to enable this parameter.</p>	Determined by A1-02 (0.000 - 60.000 s)
C5-03 (021D) RUN	ASR Proportional Gain 2	<p><input type="checkbox"/> V/f <input type="checkbox"/> OLV <input type="checkbox"/> OLV/PM <input type="checkbox"/> AOLV/PM <input type="checkbox"/> EZOLV</p> <p>Sets the gain to adjust ASR response.</p> <p>Note: When A1-02 = 0 [Control Method Selection = V/f], set H6-01 = 3 [Terminal RP Pulse Train Function = Speed Feedback (V/F Control)] to enable this parameter.</p>	Determined by A1-02 (0.00 - 300.00)

No. (Hex.)	Name	Description	Default (Range)
C5-04 (021E) RUN	ASR Integral Time 2	V/f OLV OLV/PM AOLV/PM EZOLV Sets the ASR integral time. Note: When A1-02 = 0 [Control Method Selection = V/f], set H6-01 = 3 [Terminal RP Pulse Train Function = Speed Feedback (V/F Control)] to enable this parameter.	Determined by A1-02 (0.000 - 60.000 s)
C5-05 (021F)	ASR Limit	V/f OLV OLV/PM AOLV/PM EZOLV Sets the ASR output limit where E1-04 [Maximum Output Frequency] is 100%. Note: When A1-02 = 0 [Control Method Selection = V/f], set H6-01 = 3 [Terminal RP Pulse Train Function = Speed Feedback (V/F Control)] to enable this parameter.	5.0% (0.0 - 20.0%)
C5-06 (0220)	ASR Delay Time	V/f OLV OLV/PM AOLV/PM EZOLV Sets the filter time constant of the torque reference output from the speed loop. Usually it is not necessary to change this setting.	Determined by A1-02 (0.000 - 0.500 s)
C5-07 (0221)	ASR Gain Switchover Frequency	V/f OLV OLV/PM AOLV/PM EZOLV Sets the frequency where the drive will switch between these parameters: C5-01 and C5-03 [ASR Proportional Gain 1/2] C5-02 and C5-04 [ASR Integral Time 1/2]	Determined by A1-02 (Determined by A1-02)
C5-08 (0222)	ASR Integral Limit	V/f OLV OLV/PM AOLV/PM EZOLV Set the upper limit of the ASR integral amount as a percentage of the rated load.	400% (0 - 400%)
C5-12 (0386)	Integral Operation @ Accel/Decel	V/f OLV OLV/PM AOLV/PM EZOLV Sets ASR integral operation during acceleration and deceleration. 0 : No 1 : Yes Note: When A1-02 = 0 [Control Method Selection = V/f], set H6-01 = 3 [Terminal RP Pulse Train Function = Speed Feedback (V/F Control)] to enable this parameter.	0 (0, 1)
C5-29 (0B18) Expert	Speed Control Response	V/f OLV OLV/PM AOLV/PM EZOLV Sets the level of speed control responsiveness. Usually it is not necessary to change this setting. 0 : Standard 1 : High Performance 1	1 (0, 1)
C5-39 (030D)	ASR Primary Delay Time Const 2	V/f OLV OLV/PM AOLV/PM EZOLV Sets the filter time constant used when the torque reference is output from ASR. Usually it is not necessary to change this parameter.	0.000 s (0.000 - 0.500 s)

◆ C6: Duty & Carrier Frequency

No. (Hex.)	Name	Description	Default (Range)
C6-01 (0223)	Normal / Heavy Duty Selection	V/f OLV OLV/PM AOLV/PM EZOLV Sets the drive duty rating. 0 : Heavy Duty Rating 1 : Normal Duty Rating	1 (0, 1)
C6-02 (0224)	Carrier Frequency Selection	V/f OLV OLV/PM AOLV/PM EZOLV Sets the carrier frequency for the transistors in the drive. 1 : 2.0 kHz 2 : 5.0 kHz (AOLV/PM: 4.0 kHz) 3 : 8.0 kHz (AOLV/PM: 6.0 kHz) 4 : 10.0 kHz (AOLV/PM: 8.0 kHz) 5 : 12.5 kHz (AOLV/PM: 10.0 kHz) 6 : 15.0 kHz (AOLV/PM: 12.0 kHz) 7 : Swing PWM4 (Audible Sound 1) 8 : Swing PWM4 (Audible Sound 2) 9 : Swing PWM4 (Audible Sound 3) A : Swing PWM4 (Audible Sound 4) B : Leakage Current Rejection PWM F : User Defined (C6-03 to C6-05) Note: • The setting range changes when the A1-02 [Control Method Selection] value changes: -5, 8 [OLV/PM, EZOLV]: You can set C6-02 = 1 to 6, B, and F. -6 [AOLV/PM]: You can set C6-02 = 1 to 6. • The carrier frequency for Swing PWM 1 is equivalent to 2.0 kHz. Swing PWM applies a special PWM pattern to decrease the audible noise.	Determined by A1-02, C6-01, and o2-04 (Determined by A1-02)

1.6 C: Tuning

No. (Hex.)	Name	Description	Default (Range)
C6-03 (0225)	Carrier Frequency Upper Limit	<p><input checked="" type="radio"/> V/f <input type="radio"/> OLV <input checked="" type="radio"/> OLV/PM <input type="radio"/> AOLV/PM <input type="radio"/> EZOLV</p> <p>Sets the upper limit of the carrier frequency. Set $C6-02 = F$ [Carrier Frequency Selection = User Defined (C6-03 to C6-05)] to set this parameter.</p>	Determined by C6-02 (1.0 - 15.0 kHz)
C6-04 (0226)	Carrier Frequency Lower Limit	<p><input checked="" type="radio"/> V/f <input type="radio"/> OLV <input checked="" type="radio"/> OLV/PM <input type="radio"/> AOLV/PM <input type="radio"/> EZOLV</p> <p>Sets the lower limit of the carrier frequency. Set $C6-02 = F$ [Carrier Frequency Selection = User Defined (C6-03 to C6-05)] to set this parameter.</p>	Determined by C6-02 (1.0 - 15.0 kHz)
C6-05 (0227)	Carrier Freq Proportional Gain	<p><input checked="" type="radio"/> V/f <input type="radio"/> OLV <input checked="" type="radio"/> OLV/PM <input type="radio"/> AOLV/PM <input type="radio"/> EZOLV</p> <p>Sets the proportional gain for the carrier frequency. Set $C6-02 = F$ [Carrier Frequency Selection = User Defined (C6-03 to C6-05)] to set this parameter.</p>	Determined by C6-02 (0 - 99)
C6-09 (022B)	Carrier Freq at Rotational Tune	<p><input type="radio"/> V/f <input checked="" type="radio"/> OLV <input checked="" type="radio"/> OLV/PM <input type="radio"/> AOLV/PM <input type="radio"/> EZOLV</p> <p>Sets the Auto-Tuning carrier frequency. Usually it is not necessary to change this setting. 0 : 5 kHz 1 : Use C6-03</p>	0 (0, 1)

1.7 d: Reference Settings

◆ d1: Frequency Reference

No. (Hex.)	Name	Description	Default (Range)
d1-01 (0280) RUN	Reference 1	<p>V/f OLV OLV/PM AOLV/PM EZOLV</p> <p>Sets the frequency reference in the units from o1-03 [Frequency Display Unit Selection].</p> <p>Note: When A1-02 = 6 [Control Method Selection = AOLV/PM], the default setting is o1-03 = 1 [0.01% (100% = E1-04)].</p>	0.00 Hz (0.00 - 590.00 Hz)
d1-02 (0281) RUN	Reference 2	<p>V/f OLV OLV/PM AOLV/PM EZOLV</p> <p>Sets the frequency reference in the units from o1-03 [Frequency Display Unit Selection].</p> <p>Note: When A1-02 = 6 [Control Method Selection = AOLV/PM], the default setting is o1-03 = 1 [0.01% (100% = E1-04)].</p>	0.00 Hz (0.00 - 590.00 Hz)
d1-03 (0282) RUN	Reference 3	<p>V/f OLV OLV/PM AOLV/PM EZOLV</p> <p>Sets the frequency reference in the units from o1-03 [Frequency Display Unit Selection].</p> <p>Note: When A1-02 = 6 [Control Method Selection = AOLV/PM], the default setting is o1-03 = 1 [0.01% (100% = E1-04)].</p>	0.00 Hz (0.00 - 590.00 Hz)
d1-04 (0283) RUN	Reference 4	<p>V/f OLV OLV/PM AOLV/PM EZOLV</p> <p>Sets the frequency reference in the units from o1-03 [Frequency Display Unit Selection].</p> <p>Note: When A1-02 = 6 [Control Method Selection = AOLV/PM], the default setting is o1-03 = 1 [0.01% (100% = E1-04)].</p>	0.00 Hz (0.00 - 590.00 Hz)
d1-05 (0284) RUN	Reference 5	<p>V/f OLV OLV/PM AOLV/PM EZOLV</p> <p>Sets the frequency reference in the units from o1-03 [Frequency Display Unit Selection].</p> <p>Note: When A1-02 = 6 [Control Method Selection = AOLV/PM], the default setting is o1-03 = 1 [0.01% (100% = E1-04)].</p>	0.00 Hz (0.00 - 590.00 Hz)
d1-06 (0285) RUN	Reference 6	<p>V/f OLV OLV/PM AOLV/PM EZOLV</p> <p>Sets the frequency reference in the units from o1-03 [Frequency Display Unit Selection].</p> <p>Note: When A1-02 = 6 [Control Method Selection = AOLV/PM], the default setting is o1-03 = 1 [0.01% (100% = E1-04)].</p>	0.00 Hz (0.00 - 590.00 Hz)
d1-07 (0286) RUN	Reference 7	<p>V/f OLV OLV/PM AOLV/PM EZOLV</p> <p>Sets the frequency reference in the units from o1-03 [Frequency Display Unit Selection].</p> <p>Note: When A1-02 = 6 [Control Method Selection = AOLV/PM], the default setting is o1-03 = 1 [0.01% (100% = E1-04)].</p>	0.00 Hz (0.00 - 590.00 Hz)
d1-08 (0287) RUN	Reference 8	<p>V/f OLV OLV/PM AOLV/PM EZOLV</p> <p>Sets the frequency reference in the units from o1-03 [Frequency Display Unit Selection].</p> <p>Note: When A1-02 = 6 [Control Method Selection = AOLV/PM], the default setting is o1-03 = 1 [0.01% (100% = E1-04)].</p>	0.00 Hz (0.00 - 590.00 Hz)
d1-09 (0288) RUN	Reference 9	<p>V/f OLV OLV/PM AOLV/PM EZOLV</p> <p>Sets the frequency reference in the units from o1-03 [Frequency Display Unit Selection].</p> <p>Note: When A1-02 = 6 [Control Method Selection = AOLV/PM], the default setting is o1-03 = 1 [0.01% (100% = E1-04)].</p>	0.00 Hz (0.00 - 590.00 Hz)
d1-10 (028B) RUN	Reference 10	<p>V/f OLV OLV/PM AOLV/PM EZOLV</p> <p>Sets the frequency reference in the units from o1-03 [Frequency Display Unit Selection].</p> <p>Note: When A1-02 = 6 [Control Method Selection = AOLV/PM], the default setting is o1-03 = 1 [0.01% (100% = E1-04)].</p>	0.00 Hz (0.00 - 590.00 Hz)
d1-11 (028C) RUN	Reference 11	<p>V/f OLV OLV/PM AOLV/PM EZOLV</p> <p>Sets the frequency reference in the units from o1-03 [Frequency Display Unit Selection].</p> <p>Note: When A1-02 = 6 [Control Method Selection = AOLV/PM], the default setting is o1-03 = 1 [0.01% (100% = E1-04)].</p>	0.00 Hz (0.00 - 590.00 Hz)

1.7 d: Reference Settings

No. (Hex.)	Name	Description	Default (Range)
d1-12 (028D) RUN	Reference 12	<p>V/f OLV OLV/PM AOLV/PM EZOLV</p> <p>Sets the frequency reference in the units from o1-03 [Frequency Display Unit Selection].</p> <p>Note: When A1-02 = 6 [Control Method Selection = AOLV/PM], the default setting is o1-03 = 1 [0.01% (100% = E1-04)].</p>	0.00 Hz (0.00 - 590.00 Hz)
d1-13 (028E) RUN	Reference 13	<p>V/f OLV OLV/PM AOLV/PM EZOLV</p> <p>Sets the frequency reference in the units from o1-03 [Frequency Display Unit Selection].</p> <p>Note: When A1-02 = 6 [Control Method Selection = AOLV/PM], the default setting is o1-03 = 1 [0.01% (100% = E1-04)].</p>	0.00 Hz (0.00 - 590.00 Hz)
d1-14 (028F) RUN	Reference 14	<p>V/f OLV OLV/PM AOLV/PM EZOLV</p> <p>Sets the frequency reference in the units from o1-03 [Frequency Display Unit Selection].</p> <p>Note: When A1-02 = 6 [Control Method Selection = AOLV/PM], the default setting is o1-03 = 1 [0.01% (100% = E1-04)].</p>	0.00 Hz (0.00 - 590.00 Hz)
d1-15 (0290) RUN	Reference 15	<p>V/f OLV OLV/PM AOLV/PM EZOLV</p> <p>Sets the frequency reference in the units from o1-03 [Frequency Display Unit Selection].</p> <p>Note: When A1-02 = 6 [Control Method Selection = AOLV/PM], the default setting is o1-03 = 1 [0.01% (100% = E1-04)].</p>	0.00 Hz (0.00 - 590.00 Hz)
d1-16 (0291) RUN	Reference 16	<p>V/f OLV OLV/PM AOLV/PM EZOLV</p> <p>Sets the frequency reference in the units from o1-03 [Frequency Display Unit Selection].</p> <p>Note: When A1-02 = 6 [Control Method Selection = AOLV/PM], the default setting is o1-03 = 1 [0.01% (100% = E1-04)].</p>	0.00 Hz (0.00 - 590.00 Hz)
d1-17 (0292) RUN	Jog Reference	<p>V/f OLV OLV/PM AOLV/PM EZOLV</p> <p>Sets the Jog frequency reference in the units from o1-03 [Frequency Display Unit Selection]. Set HI-xx = 6 [MFDI Function Select = Jog Reference Selection] to use the Jog frequency reference.</p> <p>Note: When A1-02 = 6 [Control Method Selection = AOLV/PM], the default setting is o1-03 = 1 [0.01% (100% = E1-04)].</p>	6.00 Hz (0.00 - 590.00 Hz)

◆ d2: Reference Limits

No. (Hex.)	Name	Description	Default (Range)
d2-01 (0289)	Frequency Reference Upper Limit	<p>V/f OLV OLV/PM AOLV/PM EZOLV</p> <p>Sets maximum limit for all frequency references. The maximum output frequency is 100%.</p> <p>Note: Parameter A1-02 [Control Method Selection] selects which parameter is the maximum output frequency. <ul style="list-style-type: none"> • A1-02 ≠ 8 [EZOLV]: E1-04 [Maximum Output Frequency] • A1-02 = 8: E9-02 [Motor Max Revolutions] </p>	100.0% (0.0 - 110.0%)
d2-02 (028A)	Frequency Reference Lower Limit	<p>V/f OLV OLV/PM AOLV/PM EZOLV</p> <p>Sets minimum limit for all frequency references. The maximum output frequency is 100%.</p> <p>Note: Parameter A1-02 [Control Method Selection] selects which parameter is the maximum output frequency. <ul style="list-style-type: none"> • A1-02 ≠ 8 [EZOLV]: E1-04 [Maximum Output Frequency] • A1-02 = 8: E9-02 [Motor Max Revolutions] </p>	0.0% (0.0 - 110.0%)
d2-03 (0293)	Analog Frequency Ref Lower Limit	<p>V/f OLV OLV/PM AOLV/PM EZOLV</p> <p>Sets the lower limit for the master frequency reference (the first frequency of the multi-step speed reference) as a percentage. The maximum output frequency is 100%.</p> <p>Note: Parameter A1-02 [Control Method Selection] selects which parameter is the maximum output frequency. <ul style="list-style-type: none"> • A1-02 ≠ 8: E1-04 [Maximum Output Frequency] • A1-02 = 8: E9-02 [Maximum Speed] </p>	0.0% (0.0 - 110.0%)

◆ d3: Jump Frequency

No. (Hex.)	Name	Description	Default (Range)
d3-01 (0294)	Jump Frequency 1	V/f OLV OLV/PM AOLV/PM EZOLV Sets the median value of the frequency band that the drive will avoid.	0.0 Hz (Determined by A1-02)
d3-02 (0295)	Jump Frequency 2	V/f OLV OLV/PM AOLV/PM EZOLV Sets the median value of the frequency band that the drive will avoid.	0.0 Hz (Determined by A1-02)
d3-03 (0296)	Jump Frequency 3	V/f OLV OLV/PM AOLV/PM EZOLV Sets the median value of the frequency band that the drive will avoid.	0.0 Hz (Determined by A1-02)
d3-04 (0297)	Jump Frequency Width	V/f OLV OLV/PM AOLV/PM EZOLV Sets the width of the frequency band that the drive will avoid.	1.0 Hz (Determined by A1-02)

◆ d4: Frequency Ref Up/Down & Hold

No. (Hex.)	Name	Description	Default (Range)
d4-01 (0298)	Freq Reference Hold Selection	V/f OLV OLV/PM AOLV/PM EZOLV Sets the function that saves the frequency reference or the frequency bias (Up/Down 2) after a Stop command or when de-energizing the drive. Set <i>H1-xx</i> [MFDI Function Selection] to one of these values to enable this parameter: • <i>A</i> [Accel/Decel Ramp Hold] • <i>10/11</i> [Up/Down Command] • <i>75/76</i> [Up/Down 2 Command] 0 : Disabled 1 : Enabled	0 (0, 1)
d4-03 (02AA) RUN	Up/Down 2 Bias Step Frequency	V/f OLV OLV/PM AOLV/PM EZOLV Sets the bias that the Up/Down 2 function adds to or subtracts from the frequency reference.	0.00 Hz (0.00 - 99.99 Hz)
d4-04 (02AB) RUN	Up/Down 2 Ramp Selection	V/f OLV OLV/PM AOLV/PM EZOLV Sets the acceleration and deceleration times for the Up/Down 2 function to apply the bias to the frequency reference. 0 : Use Selected Accel/Decel Time 1 : Use Accel/Decel Time 4	0 (0, 1)
d4-05 (02AC) RUN	Up/Down 2 Bias Mode Selection	V/f OLV OLV/PM AOLV/PM EZOLV Sets the function that saves the bias value to the drive when you open or close the two <i>Up/Down 2</i> Commands [<i>H1-xx</i> = 75, 76]. Set <i>d4-03</i> [Up/Down 2 Bias Step Frequency] = 0.00 before you set this parameter. 0 : Hold when Neither Up/Down Closed 1 : Reset when Neither / Both Closed	0 (0, 1)
d4-06 (02AD)	Frequency Ref Bias (Up/Down 2)	V/f OLV OLV/PM AOLV/PM EZOLV Saves the bias value from the Up/Down 2 Command where the Maximum Output Frequency is 100%. Note: Parameter <i>A1-02</i> [Control Method Selection] selects which parameter is the maximum output frequency. • <i>A1-02</i> ≠ 8 [EZOLV]: <i>E1-04</i> [Maximum Output Frequency] • <i>A1-02</i> = 8: <i>E9-02</i> [Maximum Speed]	0.0% (-99.9 - +100.0%)
d4-07 (02AE) RUN	Analog Freq Ref Fluctuate Limit	V/f OLV OLV/PM AOLV/PM EZOLV If the frequency reference changes for more than the level set to this parameter, then the bias value will be held. The value is set as a percentage of the Maximum Output Frequency. Note: Parameter <i>A1-02</i> [Control Method Selection] selects which parameter is the maximum output frequency. • <i>A1-02</i> ≠ 8 [EZOLV]: <i>E1-04</i> [Maximum Output Frequency] • <i>A1-02</i> = 8: <i>E9-02</i> [Maximum Speed]	1.0% (0.1 - 100.0%)
d4-08 (02AF) RUN	Up/Down 2 Bias Upper Limit	V/f OLV OLV/PM AOLV/PM EZOLV Sets the upper limit of the Up/Down 2 bias as a percentage of the Maximum Output Frequency. Note: Parameter <i>A1-02</i> [Control Method Selection] selects which parameter is the maximum output frequency. • <i>A1-02</i> ≠ 8 [EZOLV]: <i>E1-04</i> [Maximum Output Frequency] • <i>A1-02</i> = 8: <i>E9-02</i> [Maximum Speed]	100.0% (0.0 - 100.0%)

1.7 d: Reference Settings

No. (Hex.)	Name	Description	Default (Range)
d4-09 (02B0) RUN	Up/Down 2 Bias Lower Limit	<p>V/f OLV OLV/PM AOLV/PM EZOLV</p> <p>Sets the lower limit of the Up/Down 2 bias as a percentage of the Maximum Output Frequency.</p> <p>Note: Parameter <i>A1-02 [Control Method Selection]</i> selects which parameter is the maximum output frequency.</p> <ul style="list-style-type: none"> • <i>A1-02 ≠ 8 [EZOLV]: E1-04 [Maximum Output Frequency]</i> • <i>A1-02 = 8: E9-02 [Maximum Speed]</i> 	0.0% (-99.9 - 0.0%)
d4-10 (02B6)	Up/Down Freq Lower Limit Select	<p>V/f OLV OLV/PM AOLV/PM EZOLV</p> <p>Sets the lower frequency limit for the Up/Down function.</p> <p>0 : Greater of d2-02 or Analog 1 : d2-02</p>	0 (0, 1)

◆ d6: Field Weakening /Forcing

No. (Hex.)	Name	Description	Default (Range)
d6-01 (02A0)	Field Weakening Level	<p>V/f OLV OLV/PM AOLV/PM EZOLV</p> <p>Sets the drive output voltage as a percentage of <i>E1-05 [Maximum Output Voltage]</i> when <i>H1-xx = 63 [Field Weakening]</i> is activated.</p>	80% (0 - 100%)
d6-02 (02A1)	Field Weakening Frequency Limit	<p>V/f OLV OLV/PM AOLV/PM EZOLV</p> <p>Sets the minimum output frequency to start field weakening.</p>	0.0 Hz (0.0 - 590.0 Hz)
d6-03 (02A2)	Field Forcing Selection	<p>V/f OLV OLV/PM AOLV/PM EZOLV</p> <p>Sets the field forcing function.</p> <p>0 : Disabled 1 : Enabled</p>	0 (0, 1)
d6-06 (02A5)	Field Forcing Limit	<p>V/f OLV OLV/PM AOLV/PM EZOLV</p> <p>Sets the limit value for field forcing to increase the motor excitation current reference as a percentage of <i>E2-03 [Motor No-Load Current]</i>. Usually it is not necessary to change this setting.</p>	400% (100 - 400%)

◆ d7: Offset Frequency

No. (Hex.)	Name	Description	Default (Range)
d7-01 (02B2) RUN	Offset Frequency 1	<p>V/f OLV OLV/PM AOLV/PM EZOLV</p> <p>Uses <i>H1-xx = 44 [MFDI Function Select = Add Offset Frequency 1 (d7-01)]</i> as a percentage of the Maximum Output Frequency to add or subtract the set frequency to/from the frequency reference.</p> <p>Note: Parameter <i>A1-02 [Control Method Selection]</i> selects which parameter is the maximum output frequency.</p> <ul style="list-style-type: none"> • <i>A1-02 ≠ 8 [EZOLV]: E1-04 [Maximum Output Frequency]</i> • <i>A1-02 = 8: E9-02 [Maximum Speed]</i> 	0.0% (-100.0 - +100.0%)
d7-02 (02B3) RUN	Offset Frequency 2	<p>V/f OLV OLV/PM AOLV/PM EZOLV</p> <p>Uses <i>H1-xx = 45 [MFDI Function Select = Add Offset Frequency 2 (d7-02)]</i> as a percentage of the Maximum Output Frequency to add or subtract the set frequency to/from the frequency reference.</p> <p>Note: Parameter <i>A1-02 [Control Method Selection]</i> selects which parameter is the maximum output frequency.</p> <ul style="list-style-type: none"> • <i>A1-02 ≠ 8 [EZOLV]: E1-04 [Maximum Output Frequency]</i> • <i>A1-02 = 8: E9-02 [Maximum Speed]</i> 	0.0% (-100.0 - +100.0%)
d7-03 (02B4) RUN	Offset Frequency 3	<p>V/f OLV OLV/PM AOLV/PM EZOLV</p> <p>Uses <i>H1-xx = 46 [MFDI Function Select = Add Offset Frequency 3 (d7-03)]</i> as a percentage of the Maximum Output Frequency to add or subtract the set frequency to/from the frequency reference.</p> <p>Note: Parameter <i>A1-02 [Control Method Selection]</i> selects which parameter is the maximum output frequency.</p> <ul style="list-style-type: none"> • <i>A1-02 ≠ 8 [EZOLV]: E1-04 [Maximum Output Frequency]</i> • <i>A1-02 = 8: E9-02 [Maximum Speed]</i> 	0.0% (-100.0 - +100.0%)

1.8 E: Motor Parameters

◆ E1: V/f Pattern for Motor 1

No. (Hex.)	Name	Description	Default (Range)
E1-01 (0300)	Input AC Supply Voltage	<p>V/f OLV OLV/PM AOLV/PM EZOLV</p> <p>Sets the drive input voltage.</p> <p>NOTICE: Damage to Equipment. Set E1-01 [Input AC Supply Voltage] to align with the drive input voltage (not motor voltage). If this parameter is incorrect, the protective functions of the drive will not operate correctly and it can cause damage to the drive.</p>	200 V Class: 240 V, 400 V Class: 480 V (200 V Class: 155 to 255 V, 400 V Class: 310 to 510 V)
E1-03 (0302)	V/f Pattern Selection	<p>V/f OLV OLV/PM AOLV/PM EZOLV</p> <p>Sets the V/f pattern for the drive and motor. You can use one of the preset patterns or you can make a custom pattern.</p> <p>0 : Const Trq, 50Hz base, 50Hz max 1 : Const Trq, 60Hz base, 60Hz max 2 : Const Trq, 50Hz base, 60Hz max 3 : Const Trq, 60 Hz base, 72 Hz max 4 : VT, 50Hz, 65% Vmid reduction 5 : VT, 50Hz, 50% Vmid reduction 6 : VT, 60 Hz, 65% Vmid reduction 7 : VT, 60 Hz, 50% Vmid reduction 8 : High Trq, 50Hz, 25% Vmin Boost 9 : High Trq, 50Hz, 65% Vmin Boost A : High Trq, 60 Hz, 25% Vmin Boost B : High Trq, 60 Hz, 65% Vmin Boost C : Const Trq, 60 Hz base, 90 Hz max D : Const Trq, 60 Hz base, 120 Hz max E : Const Trq, 60 Hz base, 180 Hz max F : V/f Pattern Selection</p> <p>Note:</p> <ul style="list-style-type: none"> When A1-02 = 2 [Control Method Selection = OLV], settings 0 to E are not available. Set the correct V/f pattern for the application and operation area. An incorrect V/f pattern can decrease motor torque and increase current from overexcitation. 	F (Determined by A1-02)
E1-04 (0303)	Maximum Output Frequency	<p>V/f OLV OLV/PM AOLV/PM EZOLV</p> <p>Sets the maximum output frequency for the V/f pattern.</p>	Determined by A1-02 and E5-01 (Determined by A1-02 and E5-01)
E1-05 (0304)	Maximum Output Voltage	<p>V/f OLV OLV/PM AOLV/PM EZOLV</p> <p>Sets the maximum output voltage for the V/f pattern.</p>	200 V Class: 230.0 V, 400 V: 460.0 V (200 V Class: 0.0 - 255.0 V, 400 V Class: 0.0 - 510.0 V)
E1-06 (0305)	Base Frequency	<p>V/f OLV OLV/PM AOLV/PM EZOLV</p> <p>Sets the base frequency for the V/f pattern.</p>	Determined by A1-02 and E5-01 (0.0 - E1-04)
E1-07 (0306)	Mid Point A Frequency	<p>V/f OLV OLV/PM AOLV/PM EZOLV</p> <p>Sets a middle output frequency for the V/f pattern.</p>	Determined by A1-02 (0.0 - E1-04)
E1-08 (0307)	Mid Point A Voltage	<p>V/f OLV OLV/PM AOLV/PM EZOLV</p> <p>Sets a middle output voltage for the V/f pattern.</p>	Determined by A1-02 , C6- 01 and o2-04 (200 V Class: 0.0 - 255.0 V, 400 V Class: 0.0 - 510.0 V)
E1-09 (0308)	Minimum Output Frequency	<p>V/f OLV OLV/PM AOLV/PM EZOLV</p> <p>Sets the minimum output frequency for the V/f pattern.</p>	Determined by A1-02 and E5-01 (Determined by A1-02, E1- 04, and E5-01)
E1-10 (0309)	Minimum Output Voltage	<p>V/f OLV OLV/PM AOLV/PM EZOLV</p> <p>Sets the minimum output voltage for the V/f pattern.</p>	Determined by A1-02 (200 V Class: 0.0 to 255.0 V, 400 V Class: 0.0 to 510.0 V)
E1-11 (030A) Expert	Mid Point B Frequency	<p>V/f OLV OLV/PM AOLV/PM EZOLV</p> <p>Sets a middle output frequency for the V/f pattern.</p>	0.0 Hz (0.0 - E1-04)

1.8 E: Motor Parameters

No. (Hex.)	Name	Description	Default (Range)
E1-12 (030B) Expert	Mid Point B Voltage	<input type="checkbox"/> V/f <input type="checkbox"/> OLV <input type="checkbox"/> OLV/IPM <input type="checkbox"/> AOLV/IPM <input type="checkbox"/> EZOLV Sets a middle point voltage for the V/f pattern.	0.0 V (200 V Class: 0.0 to 255.0 V, 400 V Class: 0.0 to 510.0 V)
E1-13 (030C) Expert	Base Voltage	<input type="checkbox"/> V/f <input type="checkbox"/> OLV <input type="checkbox"/> OLV/IPM <input type="checkbox"/> AOLV/IPM <input type="checkbox"/> EZOLV Sets the base voltage for the V/f pattern.	0.0 V (200 V Class: 0.0 - 255.0 V, 400 V Class: 0.0 - 510.0 V)

◆ E2: Motor Parameters

No. (Hex.)	Name	Description	Default (Range)
E2-01 (030E)	Motor Rated Current (FLA)	<input type="checkbox"/> V/f <input type="checkbox"/> OLV <input type="checkbox"/> OLV/IPM <input type="checkbox"/> AOLV/IPM <input type="checkbox"/> EZOLV Sets the motor rated current in amps.	Determined by o2-04, C6-01 (10% to 200% of the drive rated current)
E2-02 (030F)	Motor Rated Slip	<input type="checkbox"/> V/f <input type="checkbox"/> OLV <input type="checkbox"/> OLV/IPM <input type="checkbox"/> AOLV/IPM <input type="checkbox"/> EZOLV Sets motor rated slip.	Determined by o2-04, C6-01 (0.000 - 20.000 Hz)
E2-03 (0310)	Motor No-Load Current	<input type="checkbox"/> V/f <input type="checkbox"/> OLV <input type="checkbox"/> OLV/IPM <input type="checkbox"/> AOLV/IPM <input type="checkbox"/> EZOLV Sets the no-load current for the motor in amps when operating at the rated frequency and the no-load voltage.	Determined by o2-04, C6-01 (0 to E2-01)
E2-04 (0311)	Motor Pole Count	<input type="checkbox"/> V/f <input type="checkbox"/> OLV <input type="checkbox"/> OLV/IPM <input type="checkbox"/> AOLV/IPM <input type="checkbox"/> EZOLV Sets the number of motor poles. Note: <ul style="list-style-type: none"> When A1-02 = 0 [Control Method Selection = V/f], the maximum value is 120. When A1-02 = 2 [OLV], the maximum value is 48. 	4 (2 - 120)
E2-05 (0312)	Motor Line-to-Line Resistance	<input type="checkbox"/> V/f <input type="checkbox"/> OLV <input type="checkbox"/> OLV/IPM <input type="checkbox"/> AOLV/IPM <input type="checkbox"/> EZOLV Sets the line-to-line resistance for the motor stator windings.	Determined by o2-04, C6-01 (0.000 - 65.000 Ω)
E2-06 (0313)	Motor Leakage Inductance	<input type="checkbox"/> V/f <input type="checkbox"/> OLV <input type="checkbox"/> OLV/IPM <input type="checkbox"/> AOLV/IPM <input type="checkbox"/> EZOLV Sets the voltage drop from motor leakage inductance when the motor is operating at the rated frequency and rated current. This value is a percentage of Motor Rated Voltage.	Determined by o2-04, C6-01 (0.0 - 60.0%)
E2-07 (0314)	Motor Saturation Coefficient 1	<input type="checkbox"/> V/f <input type="checkbox"/> OLV <input type="checkbox"/> OLV/IPM <input type="checkbox"/> AOLV/IPM <input type="checkbox"/> EZOLV Sets the motor iron-core saturation coefficient at 50% of the magnetic flux.	0.50 (0.00 - 0.50)
E2-08 (0315)	Motor Saturation Coefficient 2	<input type="checkbox"/> V/f <input type="checkbox"/> OLV <input type="checkbox"/> OLV/IPM <input type="checkbox"/> AOLV/IPM <input type="checkbox"/> EZOLV Sets the motor iron-core saturation coefficient at 75% of the magnetic flux.	0.75 (E2-07 - 0.75)
E2-09 (0316) Expert	Motor Mechanical Loss	<input type="checkbox"/> V/f <input type="checkbox"/> OLV <input type="checkbox"/> OLV/IPM <input type="checkbox"/> AOLV/IPM <input type="checkbox"/> EZOLV Sets the mechanical loss of the motor. It is set as a percentage of E2-11 [Motor Rated Power]. Usually it is not necessary to change this setting.	0.0% (0.0 - 10.0%)
E2-10 (0317)	Motor Iron Loss	<input type="checkbox"/> V/f <input type="checkbox"/> OLV <input type="checkbox"/> OLV/IPM <input type="checkbox"/> AOLV/IPM <input type="checkbox"/> EZOLV Sets the motor iron loss.	Determined by o2-04, C6-01 (0 - 65535 W)
E2-11 (0318)	Motor Rated Power	<input type="checkbox"/> V/f <input type="checkbox"/> OLV <input type="checkbox"/> OLV/IPM <input type="checkbox"/> AOLV/IPM <input type="checkbox"/> EZOLV Sets the motor rated output in the units from o1-58 [Motor Power Unit Selection].	Determined by o2-04, C6-01 (0.00 - 650.00)

◆ E3: V/f Pattern for Motor 2

No. (Hex.)	Name	Description	Default (Range)
E3-01 (0319)	Motor 2 Control Mode Selection	<input type="checkbox"/> V/f <input type="checkbox"/> OLV <input type="checkbox"/> OLV/IPM <input type="checkbox"/> AOLV/IPM <input type="checkbox"/> EZOLV Sets the control method for motor 2. Note: When you change this setting, the drive will set all parameters that are dependent on this parameter to their default settings. 0 : V/f Control 2 : Open Loop Vector	0 (0, 2)
E3-04 (031A)	Motor 2 Maximum Output Frequency	<input type="checkbox"/> V/f <input type="checkbox"/> OLV <input type="checkbox"/> OLV/IPM <input type="checkbox"/> AOLV/IPM <input type="checkbox"/> EZOLV Set the maximum output frequency for the motor 2 V/f pattern.	Determined by E3-01 (40.0 - 590.0 Hz)
E3-05 (031B)	Motor 2 Maximum Output Voltage	<input type="checkbox"/> V/f <input type="checkbox"/> OLV <input type="checkbox"/> OLV/IPM <input type="checkbox"/> AOLV/IPM <input type="checkbox"/> EZOLV Sets the maximum output voltage for the motor 2 V/f pattern.	Determined by E3-01 (200 V Class: 0.0 - 255.0 V, 400 V Class: 0.0 - 510.0 V)

No. (Hex.)	Name	Description	Default (Range)
E3-06 (031C)	Motor 2 Base Frequency	<input type="checkbox"/> V/f <input type="checkbox"/> OLV <input type="checkbox"/> OLV/PM <input type="checkbox"/> AOLV/PM <input type="checkbox"/> EZOLV Sets the base frequency for the motor 2 V/f pattern.	Determined by E3-01 (0.0 - E3-04)
E3-07 (031D)	Motor 2 Mid Point A Frequency	<input type="checkbox"/> V/f <input type="checkbox"/> OLV <input type="checkbox"/> OLV/PM <input type="checkbox"/> AOLV/PM <input type="checkbox"/> EZOLV Sets a middle output frequency for the motor 2 V/f pattern.	Determined by E3-01 (0.0 - E3-04)
E3-08 (031E)	Motor 2 Mid Point A Voltage	<input type="checkbox"/> V/f <input type="checkbox"/> OLV <input type="checkbox"/> OLV/PM <input type="checkbox"/> AOLV/PM <input type="checkbox"/> EZOLV Sets a middle output voltage for the motor 2 V/f pattern.	Determined by E3-01 (200 V Class: 0.0 - 255.0 V, 400 V Class: 0.0 - 510.0 V)
E3-09 (031F)	Motor 2 Minimum Output Frequency	<input type="checkbox"/> V/f <input type="checkbox"/> OLV <input type="checkbox"/> OLV/PM <input type="checkbox"/> AOLV/PM <input type="checkbox"/> EZOLV Sets the minimum output frequency for the motor 2 V/f pattern.	Determined by E3-01 (0.0 - E3-04)
E3-10 (0320)	Motor 2 Minimum Output Voltage	<input type="checkbox"/> V/f <input type="checkbox"/> OLV <input type="checkbox"/> OLV/PM <input type="checkbox"/> AOLV/PM <input type="checkbox"/> EZOLV Sets the minimum output voltage for the motor 2 V/f pattern.	Determined by E3-01 (200 V Class: 0.0 - 255.0 V, 400 V Class: 0.0 - 510.0 V)
E3-11 (0345) Expert	Motor 2 Mid Point B Frequency	<input type="checkbox"/> V/f <input type="checkbox"/> OLV <input type="checkbox"/> OLV/PM <input type="checkbox"/> AOLV/PM <input type="checkbox"/> EZOLV Sets a middle output frequency for the motor 2 V/f pattern. Set this parameter to adjust the V/f pattern for the constant output range. Usually it is not necessary to change this parameter.	0.0 Hz (0.0 - E3-04)
E3-12 (0346) Expert	Motor 2 Mid Point B Voltage	<input type="checkbox"/> V/f <input type="checkbox"/> OLV <input type="checkbox"/> OLV/PM <input type="checkbox"/> AOLV/PM <input type="checkbox"/> EZOLV Sets a middle output voltage for the motor 2 V/f pattern. Set this parameter to adjust the V/f pattern for the constant output range. Usually it is not necessary to change this parameter.	0.0 V (200 V Class: 0.0 to 255.0 V, 400 V Class: 0.0 to 510.0 V)
E3-13 (0347) Expert	Motor 2 Base Voltage	<input type="checkbox"/> V/f <input type="checkbox"/> OLV <input type="checkbox"/> OLV/PM <input type="checkbox"/> AOLV/PM <input type="checkbox"/> EZOLV Sets the base voltage for the motor 2 V/f pattern. Set this parameter to adjust the V/f pattern for the constant output range. Usually it is not necessary to change this parameter.	0.0 V (200 V Class: 0.0 to 255.0 V, 400 V Class: 0.0 to 510.0 V)

◆ E4: Motor 2 Parameters

No. (Hex.)	Name	Description	Default (Range)
E4-01 (0321)	Motor 2 Rated Current	<input type="checkbox"/> V/f <input type="checkbox"/> OLV <input type="checkbox"/> OLV/PM <input type="checkbox"/> AOLV/PM <input type="checkbox"/> EZOLV Sets the motor rated current for motor 2 in amps.	Determined by o2-04, C6-01 (10% to 200% of the drive rated current)
E4-02 (0322)	Motor 2 Rated Slip	<input type="checkbox"/> V/f <input type="checkbox"/> OLV <input type="checkbox"/> OLV/PM <input type="checkbox"/> AOLV/PM <input type="checkbox"/> EZOLV Sets the motor rated slip for motor 2.	Determined by o2-04, C6-01 (0.000 - 20.000 Hz)
E4-03 (0323)	Motor 2 Rated No-Load Current	<input type="checkbox"/> V/f <input type="checkbox"/> OLV <input type="checkbox"/> OLV/PM <input type="checkbox"/> AOLV/PM <input type="checkbox"/> EZOLV Sets the no-load current for motor 2 in amps when operating at the rated frequency and the no-load voltage.	Determined by o2-04, C6-01 (0 to E4-01)
E4-04 (0324)	Motor 2 Motor Poles	<input type="checkbox"/> V/f <input type="checkbox"/> OLV <input type="checkbox"/> OLV/PM <input type="checkbox"/> AOLV/PM <input type="checkbox"/> EZOLV Sets the number of poles for motor 2.	4 (2 - 120)
E4-05 (0325)	Motor 2 Line-to-Line Resistance	<input type="checkbox"/> V/f <input type="checkbox"/> OLV <input type="checkbox"/> OLV/PM <input type="checkbox"/> AOLV/PM <input type="checkbox"/> EZOLV Sets the line-to-line resistance for the motor 2 stator windings.	Determined by o2-04, C6-01 (0.000 - 65.000 Ω)
E4-06 (0326)	Motor 2 Leakage Inductance	<input type="checkbox"/> V/f <input type="checkbox"/> OLV <input type="checkbox"/> OLV/PM <input type="checkbox"/> AOLV/PM <input type="checkbox"/> EZOLV Sets the voltage drop from motor 2 leakage inductance as a percentage of Motor Rated Voltage when motor 2 operates at the rated frequency and rated current.	Determined by o2-04, C6-01 (0.0 - 60.0%)
E4-07 (0343)	Motor 2 Saturation Coefficient 1	<input type="checkbox"/> V/f <input type="checkbox"/> OLV <input type="checkbox"/> OLV/PM <input type="checkbox"/> AOLV/PM <input type="checkbox"/> EZOLV Sets the motor 2 iron-core saturation coefficient at 50% of the magnetic flux.	0.50 (0.00 - 0.50)
E4-08 (0344)	Motor 2 Saturation Coefficient 2	<input type="checkbox"/> V/f <input type="checkbox"/> OLV <input type="checkbox"/> OLV/PM <input type="checkbox"/> AOLV/PM <input type="checkbox"/> EZOLV Sets the motor 2 iron-core saturation coefficient at 75% of the magnetic flux.	0.75 (E4-07 - 0.75)
E4-09 (033F) Expert	Motor 2 Mechanical Loss	<input type="checkbox"/> V/f <input type="checkbox"/> OLV <input type="checkbox"/> OLV/PM <input type="checkbox"/> AOLV/PM <input type="checkbox"/> EZOLV Sets the mechanical loss of motor 2. It is set as a percentage of E4-11 [Motor 2 Rated Power]. Usually it is not necessary to change this setting.	0.0% (0.0 - 10.0%)
E4-10 (0340)	Motor 2 Iron Loss	<input type="checkbox"/> V/f <input type="checkbox"/> OLV <input type="checkbox"/> OLV/PM <input type="checkbox"/> AOLV/PM <input type="checkbox"/> EZOLV Sets the motor iron loss for motor 2.	Determined by o2-04, C6-01 (0 - 65535 W)
E4-11 (0327)	Motor 2 Rated Power	<input type="checkbox"/> V/f <input type="checkbox"/> OLV <input type="checkbox"/> OLV/PM <input type="checkbox"/> AOLV/PM <input type="checkbox"/> EZOLV Sets the motor rated power in the units from o1-58 [Motor Power Unit Selection].	Determined by o2-04, C6-01 (0.00 - 650.00 HP)

◆ E5: PM Motor Settings

No. (Hex.)	Name	Description	Default (Range)
E5-01 (0329)	PM Motor Code Selection	<input type="checkbox"/> V/f <input type="checkbox"/> OLV <input checked="" type="checkbox"/> OLV/PM <input type="checkbox"/> AOLV/PM <input type="checkbox"/> EZOLV Sets the motor code for Yaskawa PM motors. The drive uses the motor code to automatically set some parameters to their correct settings.	FFFF (0000 - FFFF)
E5-02 (032A)	PM Motor Rated Power	<input type="checkbox"/> V/f <input type="checkbox"/> OLV <input checked="" type="checkbox"/> OLV/PM <input type="checkbox"/> AOLV/PM <input type="checkbox"/> EZOLV Sets the PM motor rated output in the units from 01-58 [Motor Power Unit Selection].	Determined by o2-04, C6-01 (0.10 - 30.00 kW)
E5-03 (032B)	Motor Rated Current (FLA)	<input type="checkbox"/> V/f <input type="checkbox"/> OLV <input checked="" type="checkbox"/> OLV/PM <input type="checkbox"/> AOLV/PM <input type="checkbox"/> EZOLV Sets the PM motor rated current (FLA).	Determined by o2-04, C6-01 (10% to 200% of the drive rated current)
E5-04 (032C)	PM Motor Pole Count	<input type="checkbox"/> V/f <input type="checkbox"/> OLV <input checked="" type="checkbox"/> OLV/PM <input type="checkbox"/> AOLV/PM <input type="checkbox"/> EZOLV Sets the number of PM motor poles.	4 (2 - 120)
E5-05 (032D)	PM Motor Resistance (ohms/phase)	<input type="checkbox"/> V/f <input type="checkbox"/> OLV <input checked="" type="checkbox"/> OLV/PM <input type="checkbox"/> AOLV/PM <input type="checkbox"/> EZOLV Sets the resistance per phase of a PM motor. Set 50% of the line-to-line resistance.	0.100 Ω (0.000 - 65.000 Ω)
E5-06 (032E)	PM d-axis Inductance (mH/phase)	<input type="checkbox"/> V/f <input type="checkbox"/> OLV <input checked="" type="checkbox"/> OLV/PM <input type="checkbox"/> AOLV/PM <input type="checkbox"/> EZOLV Sets the PM motor d-axis inductance.	1.00 mH (0.00 - 300.00 mH)
E5-07 (032F)	PM q-axis Inductance (mH/phase)	<input type="checkbox"/> V/f <input type="checkbox"/> OLV <input checked="" type="checkbox"/> OLV/PM <input type="checkbox"/> AOLV/PM <input type="checkbox"/> EZOLV Sets the PM motor q-axis inductance.	1.00 mH (0.00 - 600.00 mH)
E5-09 (0331)	PM Back-EMF Vpeak (mV/(rad/s))	<input type="checkbox"/> V/f <input type="checkbox"/> OLV <input checked="" type="checkbox"/> OLV/PM <input type="checkbox"/> AOLV/PM <input type="checkbox"/> EZOLV Sets the peak value of PM motor induced voltage.	0.0 mV/(rad/sec) (0.0 - 2000.0 mV/(rad/s))
E5-24 (0353)	PM Back-EMF L-L Vrms (mV/rpm)	<input type="checkbox"/> V/f <input type="checkbox"/> OLV <input checked="" type="checkbox"/> OLV/PM <input type="checkbox"/> AOLV/PM <input type="checkbox"/> EZOLV Sets the RMS value for PM motor line voltage.	200 V Class: 100.0 mV/min ⁻¹ 400 V Class: 200.0 mV/min ⁻¹ (0.0 - 6500.0 mV/min ⁻¹)
E5-25 (035E) Expert	Polarity Estimation Timeout	<input type="checkbox"/> V/f <input type="checkbox"/> OLV <input checked="" type="checkbox"/> OLV/PM <input type="checkbox"/> AOLV/PM <input type="checkbox"/> EZOLV Sets the function that switches polarity for initial polarity estimation. Usually it is not necessary to change this setting. 0 : Disabled 1 : Enabled	0 (0, 1)

◆ E9: Motor Setting

No. (Hex.)	Name	Description	Default (Range)
E9-01 (11E4)	Motor Type Selection	<input type="checkbox"/> V/f <input type="checkbox"/> OLV <input checked="" type="checkbox"/> OLV/PM <input type="checkbox"/> AOLV/PM <input type="checkbox"/> EZOLV Sets the type of motor. 0 : Induction (IM) 1 : Permanent Magnet (PM) 2 : Synchronous Reluctance (SynRM)	0 (0 - 2)
E9-02 (11E5)	Maximum Speed	<input type="checkbox"/> V/f <input type="checkbox"/> OLV <input checked="" type="checkbox"/> OLV/PM <input type="checkbox"/> AOLV/PM <input type="checkbox"/> EZOLV Sets the maximum speed of the motor.	Determined by E9-01 (40.0 - 120.0 Hz)
E9-03 (11E6)	Rated Speed	<input type="checkbox"/> V/f <input type="checkbox"/> OLV <input checked="" type="checkbox"/> OLV/PM <input type="checkbox"/> AOLV/PM <input type="checkbox"/> EZOLV Sets the rated rotation speed of the motor.	Determined by E9-01 (100 - 7200 min ⁻¹)
E9-04 (11E7)	Base Frequency	<input type="checkbox"/> V/f <input type="checkbox"/> OLV <input checked="" type="checkbox"/> OLV/PM <input type="checkbox"/> AOLV/PM <input type="checkbox"/> EZOLV Sets the rated frequency of the motor.	Determined by E9-01 (40.0 - 120.0 Hz)
E9-05 (11E8)	Motor Rated Voltage	<input type="checkbox"/> V/f <input type="checkbox"/> OLV <input checked="" type="checkbox"/> OLV/PM <input type="checkbox"/> AOLV/PM <input type="checkbox"/> EZOLV Sets the rated voltage of the motor.	200 V Class: 230.0 V, 400 V Class: 460.0 V (200 V Class: 0.0 - 255.0 V, 400 V Class: 0.0 - 510.0 V)
E9-06 (11E9)	Motor Rated Current (FLA)	<input type="checkbox"/> V/f <input type="checkbox"/> OLV <input checked="" type="checkbox"/> OLV/PM <input type="checkbox"/> AOLV/PM <input type="checkbox"/> EZOLV Sets the motor rated current in amps.	Determined by E9-01 and o2-04 (10% to 200% of the drive rated current)
E9-07 (11EA)	Motor Rated Power	<input type="checkbox"/> V/f <input type="checkbox"/> OLV <input checked="" type="checkbox"/> OLV/PM <input type="checkbox"/> AOLV/PM <input type="checkbox"/> EZOLV Sets the motor rated output in the units from 01-58 [Motor Power Unit Selection].	Determined by E9-02 and o2-04 (0.00 - 650.00 kW)

No. (Hex.)	Name	Description	Default (Range)
E9-08 (11EB)	Motor Pole Count	<input type="checkbox"/> V/f <input type="checkbox"/> OLV <input type="checkbox"/> OLV/PM <input type="checkbox"/> AOLV/PM <input checked="" type="checkbox"/> EZOLV Sets the number of motor poles.	4 (2 to 120)
E9-09 (11EC)	Motor Rated Slip	<input type="checkbox"/> V/f <input type="checkbox"/> OLV <input type="checkbox"/> OLV/PM <input type="checkbox"/> AOLV/PM <input checked="" type="checkbox"/> EZOLV Sets the motor rated slip.	0.000 Hz (0.000 - 20.000 Hz)
E9-10 (11ED)	Motor Line-to-Line Resistance	<input type="checkbox"/> V/f <input type="checkbox"/> OLV <input type="checkbox"/> OLV/PM <input type="checkbox"/> AOLV/PM <input checked="" type="checkbox"/> EZOLV Sets the line-to-line resistance for the motor stator windings.	Determined by o2-04 (0.000 - 65.000 Ω)

1.9 F: Options

◆ F1: Fault Detection in PG Speed Control

No. (Hex.)	Name	Description	Default (Range)
F1-02 (0381)	Encoder Signal Loss Detect Sel	<p><input checked="" type="checkbox"/> V/f <input type="checkbox"/> OLV <input type="checkbox"/> OLV/PM <input type="checkbox"/> AOLV/PM <input type="checkbox"/> EZOLV</p> <p>Sets the method to stop the motor or let the motor continue operating when the drive detects <i>PGO</i> [Encoder (PG) Feedback Loss].</p> <p>0 : Ramp to Stop 1 : Coast to Stop 2 : Fast Stop (Use C1-09) 3 : Alarm Only 4 : No Alarm Display</p> <p>Note: When <i>A1-02</i> = 0 [Control Method Selection = V/f], set <i>H6-01</i> = 3 [Terminal RP Pulse Train Function = Speed Feedback (V/F Control)] to enable this parameter.</p>	1 (0 - 4)
F1-03 (0382)	Overspeed Detection Selection	<p><input checked="" type="checkbox"/> V/f <input type="checkbox"/> OLV <input type="checkbox"/> OLV/PM <input type="checkbox"/> AOLV/PM <input type="checkbox"/> EZOLV</p> <p>Sets the method to stop the motor or let the motor continue to operate when the drive detects <i>oS</i> [Overspeed].</p> <p>0 : Ramp to Stop 1 : Coast to Stop 2 : Fast Stop (Use C1-09) 3 : Alarm Only</p> <p>Note: When <i>A1-02</i> = 0 [Control Method Selection = V/f], set <i>H6-01</i> = 3 [Terminal RP Pulse Train Function = Speed Feedback (V/F Control)] to enable this parameter.</p>	1 (0 - 3)
F1-04 (0383)	Speed Deviation Detection Select	<p><input checked="" type="checkbox"/> V/f <input type="checkbox"/> OLV <input type="checkbox"/> OLV/PM <input type="checkbox"/> AOLV/PM <input type="checkbox"/> EZOLV</p> <p>Sets the method to stop the motor or let the motor continue to operate when the drive detects <i>dEv</i> [Speed Deviation].</p> <p>0 : Ramp to Stop 1 : Coast to Stop 2 : Fast Stop (Use C1-09) 3 : Alarm Only</p> <p>Note: When <i>A1-02</i> = 0 [Control Method Selection = V/f], set <i>H6-01</i> = 3 [Terminal RP Pulse Train Function = Speed Feedback (V/F Control)] to enable this parameter.</p>	3 (0 - 3)
F1-08 (0387)	Overspeed Detection Level	<p><input checked="" type="checkbox"/> V/f <input type="checkbox"/> OLV <input type="checkbox"/> OLV/PM <input type="checkbox"/> AOLV/PM <input type="checkbox"/> EZOLV</p> <p>Sets the detection level of <i>oS</i> [Overspeed] as a percentage when the maximum output frequency is 100%.</p> <p>Note:</p> <ul style="list-style-type: none"> Parameter <i>A1-02</i> [Control Method Selection] selects which parameter is the maximum output frequency. <ul style="list-style-type: none"> <i>A1-02</i> ≠ 8 [EZOLV]: <i>E1-04</i> [Maximum Output Frequency] <i>A1-02</i> = 8: <i>E9-02</i> [Motor Max Revolutions] When <i>A1-02</i> = 0 [Control Method Selection = V/f], set <i>H6-01</i> = 3 [Terminal RP Pulse Train Function = Speed Feedback (V/F Control)] to enable this parameter. 	115% (0 - 120%)
F1-09 (0388)	Overspeed Detection Delay Time	<p><input checked="" type="checkbox"/> V/f <input type="checkbox"/> OLV <input type="checkbox"/> OLV/PM <input type="checkbox"/> AOLV/PM <input type="checkbox"/> EZOLV</p> <p>Sets the length of time that the speed feedback must be more than the <i>F1-08</i> level to cause <i>oS</i> [Overspeed].</p> <p>Note: When <i>A1-02</i> = 0 [Control Method Selection = V/f], set <i>H6-01</i> = 3 [Terminal RP Pulse Train Function = Speed Feedback (V/F Control)] to enable this parameter.</p>	Determined by <i>A1-02</i> (0.0 - 2.0 s)
F1-10 (0389)	Speed Deviation Detection Level	<p><input checked="" type="checkbox"/> V/f <input type="checkbox"/> OLV <input type="checkbox"/> OLV/PM <input type="checkbox"/> AOLV/PM <input type="checkbox"/> EZOLV</p> <p>Sets the detection level of <i>dEv</i> [Speed Deviation] as a percentage when the maximum output frequency is 100%.</p> <p>Note:</p> <ul style="list-style-type: none"> Parameter <i>A1-02</i> [Control Method Selection] selects which parameter is the maximum output frequency. <ul style="list-style-type: none"> <i>A1-02</i> ≠ 8 [EZOLV]: <i>E1-04</i> [Maximum Output Frequency] <i>A1-02</i> = 8: <i>E9-02</i> [Maximum Speed] When <i>A1-02</i> = 0 [Control Method Selection = V/f], set <i>H6-01</i> = 3 [Terminal RP Pulse Train Function = Speed Feedback (V/F Control)] to enable this parameter. 	10% (0 - 50%)

No. (Hex.)	Name	Description	Default (Range)
F1-11 (038A)	Speed Deviation Detect DelayTime	<p><input type="checkbox"/> V/f <input type="checkbox"/> OLV <input type="checkbox"/> OLV/PM <input type="checkbox"/> AOLV/PM <input type="checkbox"/> EZOLV</p> <p>Sets the length of time that the difference between the frequency reference and speed feedback must be more than the level in <i>F1-10</i> to cause <i>dEv</i> [Speed Deviation].</p> <p>Note: When <i>A1-02</i> = 0 [Control Method Selection = V/f], set <i>H6-01</i> = 3 [Terminal RP Pulse Train Function = Speed Feedback (V/F Control)] to enable this parameter.</p>	0.5 s (0.0 - 10.0 s)
F1-14 (038D)	Encoder Open-Circuit Detect Time	<p><input type="checkbox"/> V/f <input type="checkbox"/> OLV <input type="checkbox"/> OLV/PM <input type="checkbox"/> AOLV/PM <input type="checkbox"/> EZOLV</p> <p>Sets the length of time that the drive must not receive a pulse signal to cause <i>PGo</i> [Encoder (PG) Feedback Loss].</p> <p>Note: Motor speed and load conditions can cause <i>ov</i> [Overvoltage] and <i>oC</i> [Overcurrent] faults. When <i>A1-02</i> = 0 [Control Method Selection = V/f], set <i>H6-01</i> = 3 [Terminal RP Pulse Train Function = Speed Feedback (V/F Control)] to enable this parameter.</p>	2.0 s (0.0 - 10.0 s)

◆ F6: Communication Options

No. (Hex.)	Name	Description	Default (Range)
F6-01 (03A2)	Communication Error Selection	<p><input type="checkbox"/> V/f <input type="checkbox"/> OLV <input type="checkbox"/> OLV/PM <input type="checkbox"/> AOLV/PM <input type="checkbox"/> EZOLV</p> <p>Sets the method to stop the motor or let the motor continue operating when the drive detects <i>bUS</i> [Option Communication Error].</p> <p>0 : Ramp to Stop 1 : Coast to Stop 2 : Fast Stop (Use C1-09) 3 : Alarm Only 4 : Alarm (Run at d1-04) 5 : Alarm - Ramp Stop</p>	1 (0 - 5)
F6-02 (03A3)	Comm External Fault (EF0) Detect	<p><input type="checkbox"/> V/f <input type="checkbox"/> OLV <input type="checkbox"/> OLV/PM <input type="checkbox"/> AOLV/PM <input type="checkbox"/> EZOLV</p> <p>Sets the conditions at which <i>EF0</i> [Option Card External Fault] is detected.</p> <p>0 : Always Detected 1 : Detected during RUN Only</p>	0 (0, 1)
F6-03 (03A4)	Comm External Fault (EF0) Select	<p><input type="checkbox"/> V/f <input type="checkbox"/> OLV <input type="checkbox"/> OLV/PM <input type="checkbox"/> AOLV/PM <input type="checkbox"/> EZOLV</p> <p>Sets the method to stop the motor or let the motor continue operating when the drive detects <i>EF0</i> [Option Card External Fault].</p> <p>0 : Ramp to Stop 1 : Coast to Stop 2 : Fast Stop (Use C1-09) 3 : Alarm Only</p>	1 (0 - 3)
F6-04 (03A5)	bUS Error Detection Time	<p><input type="checkbox"/> V/f <input type="checkbox"/> OLV <input type="checkbox"/> OLV/PM <input type="checkbox"/> AOLV/PM <input type="checkbox"/> EZOLV</p> <p>Sets the delay time for the drive to detect <i>bUS</i> [Option Communication Error].</p> <p>Note: When you install a CC-Link option (SI-C3) to the drive, the setting value changes to 0.0 s.</p>	2.0 s (0.0 - 12.0 s)
F6-06 (03A7)	Torque Reference/Limit by Comm	<p><input type="checkbox"/> V/f <input type="checkbox"/> OLV <input type="checkbox"/> OLV/PM <input type="checkbox"/> AOLV/PM <input type="checkbox"/> EZOLV</p> <p>Sets the function that enables and disables the torque reference and torque limit received from the communication option.</p> <p>0 : Disabled 1 : Enabled</p>	0 (0, 1)
F6-07 (03A8)	Multi-Step Ref @ NetRef/ ComRef	<p><input type="checkbox"/> V/f <input type="checkbox"/> OLV <input type="checkbox"/> OLV/PM <input type="checkbox"/> AOLV/PM <input type="checkbox"/> EZOLV</p> <p>Sets the function that enables and disables the multi-step speed reference when the frequency reference source is NetRef or ComRef (communication option card or MEMOBUS/Modbus communications).</p> <p>0 : Disable Multi-Step References 1 : Enable Multi-Step References</p>	1 (0, 1)
F6-08 (036A)	Comm Parameter Reset @Initialize	<p><input type="checkbox"/> V/f <input type="checkbox"/> OLV <input type="checkbox"/> OLV/PM <input type="checkbox"/> AOLV/PM <input type="checkbox"/> EZOLV</p> <p>Sets the function to initialize <i>F6-xx</i> and <i>F7-xx</i> parameters when the drive is initialized with <i>A1-03</i> [Initialize Parameters].</p> <p>0 : No Reset - Parameters Retained 1 : Reset Back to Factory Default</p>	0 (0, 1)

1.9 F: Options

No. (Hex.)	Name	Description	Default (Range)
F6-10 (03B6)	CC-Link Node Address	<p>V/f OLV OLV/IPM AOLV/IPM EZOLV</p> <p>Sets the node address for CC-Link communication. Restart the drive after you change the parameter setting.</p> <p>Note: Be sure to set a node address that is different than all other node addresses. Do not set this parameter to 0. Incorrect parameter settings will cause <i>AEr</i> [Station Address Setting Error] errors and the L.ERR LED on the option will come on.</p>	0 (0 - 64)
F6-11 (03B7)	CC-Link Communication Speed	<p>V/f OLV OLV/IPM AOLV/IPM EZOLV</p> <p>Sets the communication speed for CC-Link communication. Restart the drive after you change the parameter setting.</p> <p>0 : 156 kbps 1 : 625 kbps 2 : 2.5 Mbps 3 : 5 Mbps 4 : 10 Mbps</p>	0 (0 - 4)
F6-14 (03BB)	BUS Error Auto Reset	<p>V/f OLV OLV/IPM AOLV/IPM EZOLV</p> <p>Sets the automatic reset function for <i>BUS</i> [Option Communication Errors].</p> <p>0 : Disable 1 : Enabled</p>	0 (0, 1)
F6-15 (0B5B)	Comm. Option Parameters Reload	<p>V/f OLV OLV/IPM AOLV/IPM EZOLV</p> <p>Sets the update method when you change <i>F6-xx, F7-xx</i> [Communication Options].</p> <p>0 : Reload at Next Power Cycle 1 : Reload Now 2 : Cancel Reload Request</p>	0 (0 - 2)
F6-16 (0B8A)	Gateway Mode	<p>V/f OLV OLV/IPM AOLV/IPM EZOLV</p> <p>Sets the gateway mode operation and the number of connected slave drives.</p> <p>0 : Disabled 1 : Enabled: 1 Slave Drives 2 : Enabled: 2 Slave Drives 3 : Enabled: 3 Slave Drives 4 : Enabled: 4 Slave Drives</p>	0 (0 to 4)
F6-20 (036B)	MECHATROLINK Station Address	<p>V/f OLV OLV/IPM AOLV/IPM EZOLV</p> <p>Sets the station address for MECHATROLINK communication. Change the parameter then cycle power on the drive.</p> <p>Note:</p> <ul style="list-style-type: none"> The setting range changes if using MECHATROLINK-II or MECHATROLINK-III: –MECHATROLINK-II (SI-T3) range: 20 - 3F –MECHATROLINK-III (SI-ET3) range: 03 - EF Be sure to set a node address that is different than all other node addresses. Incorrect parameter settings will cause <i>AEr</i> [Station Address Setting Error] errors and the L.ERR LED on the option will come on. The drive detects <i>AEr</i> errors when the station address is 20 or 3F. 	0021h (MECHATROLINK-II: 0020h - 003Fh, MECHATROLINK-III: 0003h - 00EFh)
F6-21 (036C)	MECHATROLINK Frame Size	<p>V/f OLV OLV/IPM AOLV/IPM EZOLV</p> <p>Sets the frame size for MECHATROLINK communication. Restart the drive after you change the parameter setting.</p> <p>0 : 32byte (M-2) / 64byte (M-3) 1 : 17byte (M-2) / 32byte (M-3)</p>	0 (0, 1)
F6-22 (036D)	MECHATROLINK Link Speed	<p>V/f OLV OLV/IPM AOLV/IPM EZOLV</p> <p>Sets the communications speed for MECHATROLINK-II. Restart the drive after you change the parameter setting.</p> <p>Note: This parameter is only available with the MECHATROLINK-II option.</p> <p>0 : 10 Mbps 1 : 4 Mbps</p>	0 (0, 1)
F6-23 (036E)	MECHATROLINK Monitor Select (E)	<p>V/f OLV OLV/IPM AOLV/IPM EZOLV</p> <p>Sets the MEMOBUS register used for the monitor functions of INV_CTL (drive operation control command) and INV_I/O (drive I/O control command). Restart the drive after you change the parameter setting.</p>	0000h (0000h - FFFFh)
F6-24 (036F)	MECHATROLINK Monitor Select (F)	<p>V/f OLV OLV/IPM AOLV/IPM EZOLV</p> <p>Sets the MEMOBUS register used for the monitor functions of INV_CTL (drive operation control command) and INV_I/O (drive I/O control command). Restart the drive after you change the parameter setting.</p>	0000h (0000h - FFFFh)

No. (Hex.)	Name	Description	Default (Range)
F6-25 (03C9)	MECHATROLINK Watchdog Error Sel	V/f OLV OLV/PM AOLV/PM EZOLV Sets the method to stop the motor or let the motor continue operating when the drive detects <i>E5</i> [<i>MECHATROLINK Watchdog Timer Err</i>]. 0 : Ramp to Stop 1 : Coast to Stop 2 : Fast Stop (Use C1-09) 3 : Alarm Only	1 (0 - 3)
F6-26 (03CA)	MECHATROLINK Allowable No of Err	V/f OLV OLV/PM AOLV/PM EZOLV Sets the number of times that the option must detect a <i>bUS</i> alarm to cause a <i>bUS</i> [<i>Option Communication Error</i>].	2 (2 - 10 times)
F6-30 (03CB)	PROFIBUS-DP Node Address	V/f OLV OLV/PM AOLV/PM EZOLV Sets the node address for PROFIBUS-DP communication. Restart the drive after you change the parameter setting. Note: Be sure to set an address that is different than all other node addresses. Do not set this parameter to 0.	0 (0 - 125)
F6-31 (03CC)	PROFIBUS-DP Clear Mode Selection	V/f OLV OLV/PM AOLV/PM EZOLV Sets what the drive will do after it receives the Clear Mode command. 0 : Reset 1 : Hold Previous State	0 (0, 1)
F6-32 (03CD)	PROFIBUS-DP Data Format Select	V/f OLV OLV/PM AOLV/PM EZOLV Sets the data format of PROFIBUS-DP communication. Restart the drive after you change the parameter setting. 0 : PPO Type 1 : Conventional 2 : PPO (bit0) 3 : PPO (Enter) 4 : Conventional (Enter) 5 : PPO (bit0, Enter)	0 (0 - 5)
F6-35 (03D0)	CANopen Node ID Selection	V/f OLV OLV/PM AOLV/PM EZOLV Sets the node address for CANopen communication. Restart the drive after you change the parameter setting. Note: Be sure to set an address that is different than all other node addresses. Do not set this parameter to 0. Incorrect parameter settings will cause <i>AEr</i> [<i>Station Address Setting Error</i>] errors and the L. ERR LED on the option will come on.	0 (0 - 126)
F6-36 (03D1)	CANopen Communication Speed	V/f OLV OLV/PM AOLV/PM EZOLV Sets the CANopen communications speed. Restart the drive after you change the parameter setting. 0 : Auto-detection 1 : 10 kbps 2 : 20 kbps 3 : 50 kbps 4 : 125 kbps 5 : 250 kbps 6 : 500 kbps 7 : 800 kbps 8 : 1 Mbps	6 (0 - 8)
F6-50 (03C1)	DeviceNet MAC Address	V/f OLV OLV/PM AOLV/PM EZOLV Sets the MAC address for DeviceNet communication. Restart the drive after you change the parameter setting. Note: Be sure to set a MAC address that is different than all other node addresses. Do not set this parameter to 0. Incorrect parameter settings will cause <i>AEr</i> [<i>Station Address Setting Error</i>] errors and the MS LED on the option will flash.	64 (0 - 64)
F6-51 (03C2)	DeviceNet Baud Rate	V/f OLV OLV/PM AOLV/PM EZOLV Sets the DeviceNet communications speed. Restart the drive after you change the parameter setting. 0 : 125 kbps 1 : 250 kbps 2 : 500 kbps 3 : Adjustable from Network 4 : Detect Automatically	4 (0 - 4)
F6-52 (03C3)	DeviceNet PCA Setting	V/f OLV OLV/PM AOLV/PM EZOLV Sets the format of data that the DeviceNet communication master sends to the drive.	21 (0 - 255)

1.9 F: Options

No. (Hex.)	Name	Description	Default (Range)
F6-53 (03C4)	DeviceNet PPA Setting	<input type="checkbox"/> V/f <input type="checkbox"/> OLV <input type="checkbox"/> OLV/IPM <input type="checkbox"/> AOLV/IPM <input type="checkbox"/> EZOLV Sets the format of data that the drive sends to the DeviceNet communication master.	71 (0 - 255)
F6-54 (03C5)	DeviceNet Idle Fault Detection	<input type="checkbox"/> V/f <input type="checkbox"/> OLV <input type="checkbox"/> OLV/IPM <input type="checkbox"/> AOLV/IPM <input type="checkbox"/> EZOLV Sets the function to detect <i>EF0 [Option Card External Fault]</i> when the drive does not receive data from the DeviceNet master. 0 : Enabled 1 : Disabled, No Fault Detection 2 : Vendor Specific 3 : RUN Forward 4 : RUN Reverse	0 (0 - 4)
F6-55 (03C6)	DeviceNet Baud Rate Monitor	<input type="checkbox"/> V/f <input type="checkbox"/> OLV <input type="checkbox"/> OLV/IPM <input type="checkbox"/> AOLV/IPM <input type="checkbox"/> EZOLV Sets the function to see the actual DeviceNet communications speed using the keypad. This parameter functions as a monitor only. 0 : 125 kbps 1 : 250 kbps 2 : 500 kbps	0 (0 - 2)
F6-56 (03D7)	DeviceNet Speed Scaling	<input type="checkbox"/> V/f <input type="checkbox"/> OLV <input type="checkbox"/> OLV/IPM <input type="checkbox"/> AOLV/IPM <input type="checkbox"/> EZOLV Sets the speed scale for DeviceNet communication.	0 (-15 - +15)
F6-57 (03D8)	DeviceNet Current Scaling	<input type="checkbox"/> V/f <input type="checkbox"/> OLV <input type="checkbox"/> OLV/IPM <input type="checkbox"/> AOLV/IPM <input type="checkbox"/> EZOLV Sets the current scale of the DeviceNet communication master.	0 (-15 - +15)
F6-58 (03D9)	DeviceNet Torque Scaling	<input type="checkbox"/> V/f <input type="checkbox"/> OLV <input type="checkbox"/> OLV/IPM <input type="checkbox"/> AOLV/IPM <input type="checkbox"/> EZOLV Sets the torque scale of the DeviceNet communication master.	0 (-15 - +15)
F6-59 (03DA)	DeviceNet Power Scaling	<input type="checkbox"/> V/f <input type="checkbox"/> OLV <input type="checkbox"/> OLV/IPM <input type="checkbox"/> AOLV/IPM <input type="checkbox"/> EZOLV Sets the power scale of the DeviceNet communication master.	0 (-15 - +15)
F6-60 (03DB)	DeviceNet Voltage Scaling	<input type="checkbox"/> V/f <input type="checkbox"/> OLV <input type="checkbox"/> OLV/IPM <input type="checkbox"/> AOLV/IPM <input type="checkbox"/> EZOLV Sets the voltage scale of the DeviceNet communication master.	0 (-15 - +15)
F6-61 (03DC)	DeviceNet Time Scaling	<input type="checkbox"/> V/f <input type="checkbox"/> OLV <input type="checkbox"/> OLV/IPM <input type="checkbox"/> AOLV/IPM <input type="checkbox"/> EZOLV Sets the time scale of the DeviceNet communication master.	0 (-15 - +15)
F6-62 (03DD)	DeviceNet Heartbeat Interval	<input type="checkbox"/> V/f <input type="checkbox"/> OLV <input type="checkbox"/> OLV/IPM <input type="checkbox"/> AOLV/IPM <input type="checkbox"/> EZOLV Sets the heartbeat for DeviceNet communication. Set this parameter to 0 to disable the heartbeat function.	0 (0 - 10)
F6-63 (03DE)	DeviceNet Network MAC ID	<input type="checkbox"/> V/f <input type="checkbox"/> OLV <input type="checkbox"/> OLV/IPM <input type="checkbox"/> AOLV/IPM <input type="checkbox"/> EZOLV Sets the function to see the actual DeviceNet MAC address using the keypad. This parameter functions as a monitor only.	63 (0 - 63)
F6-64 (03DF)	Dynamic Out Assembly 109 Param1	<input type="checkbox"/> V/f <input type="checkbox"/> OLV <input type="checkbox"/> OLV/IPM <input type="checkbox"/> AOLV/IPM <input type="checkbox"/> EZOLV Sets Configurable Output 1 written to the MEMOBUS register.	0000H (0000H - FFFFH)
F6-65 (03E0)	Dynamic Out Assembly 109 Param2	<input type="checkbox"/> V/f <input type="checkbox"/> OLV <input type="checkbox"/> OLV/IPM <input type="checkbox"/> AOLV/IPM <input type="checkbox"/> EZOLV Sets Configurable Output 2 written to the MEMOBUS register.	0000H (0000H - FFFFH)
F6-66 (03E1)	Dynamic Out Assembly 109 Param3	<input type="checkbox"/> V/f <input type="checkbox"/> OLV <input type="checkbox"/> OLV/IPM <input type="checkbox"/> AOLV/IPM <input type="checkbox"/> EZOLV Sets Configurable Output 3 written to the MEMOBUS register.	0000H (0000H - FFFFH)
F6-67 (03E2)	Dynamic Out Assembly 109 Param4	<input type="checkbox"/> V/f <input type="checkbox"/> OLV <input type="checkbox"/> OLV/IPM <input type="checkbox"/> AOLV/IPM <input type="checkbox"/> EZOLV Sets Configurable Output 4 written to the MEMOBUS register.	0000H (0000H - FFFFH)
F6-68 (03E3)	Dynamic In Assembly 159 Param 1	<input type="checkbox"/> V/f <input type="checkbox"/> OLV <input type="checkbox"/> OLV/IPM <input type="checkbox"/> AOLV/IPM <input type="checkbox"/> EZOLV Sets Configurable Input 1 read from the MEMOBUS register.	0000H (0000H - FFFFH)
F6-69 (03E4)	Dynamic In Assembly 159 Param 2	<input type="checkbox"/> V/f <input type="checkbox"/> OLV <input type="checkbox"/> OLV/IPM <input type="checkbox"/> AOLV/IPM <input type="checkbox"/> EZOLV Sets Configurable Input 2 read from the MEMOBUS register.	0000H (0000H - FFFFH)
F6-70 (03C7)	Dynamic In Assembly 159 Param 3	<input type="checkbox"/> V/f <input type="checkbox"/> OLV <input type="checkbox"/> OLV/IPM <input type="checkbox"/> AOLV/IPM <input type="checkbox"/> EZOLV Sets Configurable Input 3 read from the MEMOBUS register.	0000H (0000H - FFFFH)
F6-71 (03C8)	Dynamic In Assembly 159 Param 4	<input type="checkbox"/> V/f <input type="checkbox"/> OLV <input type="checkbox"/> OLV/IPM <input type="checkbox"/> AOLV/IPM <input type="checkbox"/> EZOLV Sets Configurable Input 4 read from the MEMOBUS register.	0000H (0000H - FFFFH)
F6-72 (081B)	PowerLink Node Address	<input type="checkbox"/> V/f <input type="checkbox"/> OLV <input type="checkbox"/> OLV/IPM <input type="checkbox"/> AOLV/IPM <input type="checkbox"/> EZOLV Sets the node ID for PowerLink communication. Note: Be sure to set an address that is different than all other node addresses. Do not set this parameter to 0.	0 (0 - 255)

◆ F7: Communication Options

No. (Hex.)	Name	Description	Default (Range)
F7-01 (03E5)	IP Address 1	<p>V/f OLV OLV/PM AOLV/PM EZOLV</p> <p>Sets the first octet of the IP Address for the device that is connecting to the network. Restart the drive after you change this parameter.</p> <p>Note: When $F7-13 = 0$ [Address Mode at Startup = Static]:</p> <ul style="list-style-type: none"> Use parameters $F7-01$ to $F7-04$ [IP Address 1 to 4] to set the IP Address. Be sure to set a different IP address for each drive on the network. Also set parameters $F7-05$ to $F7-12$ [Subnet Mask 1 to 4, Gateway Address 1 to 4]. 	192 (0 - 255)
F7-02 (03E6)	IP Address 2	<p>V/f OLV OLV/PM AOLV/PM EZOLV</p> <p>Sets the second octet of the IP Address for the device that is connecting to the network. Restart the drive after you change this parameter.</p> <p>Note: When $F7-13 = 0$ [Address Mode at Startup = Static]:</p> <ul style="list-style-type: none"> Use parameters $F7-01$ to $F7-04$ [IP Address 1 to 4] to set the IP Address. Be sure to set a different IP address for each drive on the network. Also set parameters $F7-05$ to $F7-12$ [Subnet Mask 1 to 4, Gateway Address 1 to 4]. 	168 (0 - 255)
F7-03 (03E7)	IP Address 3	<p>V/f OLV OLV/PM AOLV/PM EZOLV</p> <p>Sets the third octet of the IP Address for the device that is connecting to the network. Restart the drive after you change this parameter.</p> <p>Note: When $F7-13 = 0$ [Address Mode at Startup = Static]:</p> <ul style="list-style-type: none"> Use parameters $F7-01$ to $F7-04$ [IP Address 1 to 4] to set the IP Address. Be sure to set a different IP address for each drive on the network. Also set parameters $F7-05$ to $F7-12$ [Subnet Mask 1 to 4, Gateway Address 1 to 4]. 	1 (0 - 255)
F7-04 (03E8)	IP Address 4	<p>V/f OLV OLV/PM AOLV/PM EZOLV</p> <p>Sets the fourth octet of the IP Address for the device that is connecting to the network. Restart the drive after you change this parameter.</p> <p>Note: When $F7-13 = 0$ [Address Mode at Startup = Static]:</p> <ul style="list-style-type: none"> Use parameters $F7-01$ to $F7-04$ [IP Address 1 to 4] to set the IP Address. Be sure to set a different IP address for each drive on the network. Also set parameters $F7-05$ to $F7-12$ [Subnet Mask 1 to 4, Gateway Address 1 to 4]. 	20 (0 - 255)
F7-05 (03E9)	Subnet Mask 1	<p>V/f OLV OLV/PM AOLV/PM EZOLV</p> <p>Sets the first octet of the subnet mask of the connected network.</p> <p>Note: Set this parameter when $F7-13 = 0$ [Address Mode at Startup = Static].</p>	255 (0 - 255)
F7-06 (03EA)	Subnet Mask 2	<p>V/f OLV OLV/PM AOLV/PM EZOLV</p> <p>Sets the second octet of the subnet mask of the connected network.</p> <p>Note: Set this parameter when $F7-13 = 0$ [Address Mode at Startup = Static].</p>	255 (0 - 255)
F7-07 (03EB)	Subnet Mask 3	<p>V/f OLV OLV/PM AOLV/PM EZOLV</p> <p>Sets the third octet of the subnet mask of the connected network.</p> <p>Note: Set this parameter when $F7-13 = 0$ [Address Mode at Startup = Static].</p>	255 (0 - 255)
F7-08 (03EC)	Subnet Mask 4	<p>V/f OLV OLV/PM AOLV/PM EZOLV</p> <p>Sets the fourth octet of the subnet mask of the connected network.</p> <p>Note: Set this parameter when $F7-13 = 0$ [Address Mode at Startup = Static].</p>	0 (0 - 255)
F7-09 (03ED)	Gateway Address 1	<p>V/f OLV OLV/PM AOLV/PM EZOLV</p> <p>Sets the first octet of the gateway address of the connected network.</p> <p>Note: Set this parameter when $F7-13 = 0$ [Address Mode at Startup = Static].</p>	192 (0 - 255)
F7-10 (03EE)	Gateway Address 2	<p>V/f OLV OLV/PM AOLV/PM EZOLV</p> <p>Sets the second octet of the gateway address of the connected network.</p> <p>Note: Set this parameter when $F7-13 = 0$ [Address Mode at Startup = Static].</p>	168 (0 - 255)
F7-11 (03EF)	Gateway Address 3	<p>V/f OLV OLV/PM AOLV/PM EZOLV</p> <p>Sets the third octet of the gateway address of the connected network.</p> <p>Note: Set this parameter when $F7-13 = 0$ [Address Mode at Startup = Static].</p>	1 (0 - 255)

1.9 F: Options

No. (Hex.)	Name	Description	Default (Range)
F7-12 (03F0)	Gateway Address 4	<p><input type="checkbox"/> V/f <input type="checkbox"/> OLV <input type="checkbox"/> OLV/IPM <input type="checkbox"/> AOLV/IPM <input type="checkbox"/> EZOLV</p> <p>Sets the fourth octet of the gateway address of the connected network.</p> <p>Note: Set this parameter when $F7-13 = 0$ [Address Mode at Startup = Static].</p>	1 (0 - 255)
F7-13 (03F1)	Address Mode at Startup	<p><input type="checkbox"/> V/f <input type="checkbox"/> OLV <input type="checkbox"/> OLV/IPM <input type="checkbox"/> AOLV/IPM <input type="checkbox"/> EZOLV</p> <p>Sets the method to set option card IP addresses.</p> <p>0 : Static 1 : BOOTP 2 : DHCP</p> <p>Note:</p> <ul style="list-style-type: none"> The following setting values are available when using the PROFINET communication option card (SI-EP3). -0: Static -2: DHCP When $F7-13 = 0$, set parameters $F7-01$ to $F7-12$ [IP Address 1 to Gateway Address 4] to set the IP Address. Be sure to set a different IP address for each drive on the network. 	2 (0 - 2)
F7-14 (03F2)	Duplex Mode Selection	<p><input type="checkbox"/> V/f <input type="checkbox"/> OLV <input type="checkbox"/> OLV/IPM <input type="checkbox"/> AOLV/IPM <input type="checkbox"/> EZOLV</p> <p>Sets the duplex mode setting method.</p> <p>0 : Half/Half 1 : Auto/Auto 2 : Full/Full 3 : Half/Auto 4 : Half/Full 5 : Auto/Half 6 : Auto/Full 7 : Full/Half 8 : Full/Auto</p>	1 (0 - 8)
F7-15 (03F3)	Communication Speed Selection	<p><input type="checkbox"/> V/f <input type="checkbox"/> OLV <input type="checkbox"/> OLV/IPM <input type="checkbox"/> AOLV/IPM <input type="checkbox"/> EZOLV</p> <p>Sets the communications speed.</p> <p>10 : 10/10 Mbps 100 : 100/100 Mbps 101 : 10/100 Mbps 102 : 100/10 Mbps</p>	10 (10, 100 - 102)
F7-16 (03F4)	Timeout Value	<p><input type="checkbox"/> V/f <input type="checkbox"/> OLV <input type="checkbox"/> OLV/IPM <input type="checkbox"/> AOLV/IPM <input type="checkbox"/> EZOLV</p> <p>Sets the detection time for a communications timeout.</p> <p>Note: Set this parameter to 0.0 to disable the connection timeout function.</p>	0.0 s (0.0 - 30.0 s)
F7-17 (03F5)	EtherNet/IP Speed Scaling Factor	<p><input type="checkbox"/> V/f <input type="checkbox"/> OLV <input type="checkbox"/> OLV/IPM <input type="checkbox"/> AOLV/IPM <input type="checkbox"/> EZOLV</p> <p>Sets the scaling factor for the speed monitor in the EtherNet/IP Class ID 2AH Object.</p>	0 (-15 - +15)
F7-18 (03F6)	EtherNet/IP Current Scale Factor	<p><input type="checkbox"/> V/f <input type="checkbox"/> OLV <input type="checkbox"/> OLV/IPM <input type="checkbox"/> AOLV/IPM <input type="checkbox"/> EZOLV</p> <p>Sets the scaling factor for the output current monitor in the EtherNet/IP Class ID 2AH Object.</p>	0 (-15 - +15)
F7-19 (03F7)	EtherNet/IP Torque Scale Factor	<p><input type="checkbox"/> V/f <input type="checkbox"/> OLV <input type="checkbox"/> OLV/IPM <input type="checkbox"/> AOLV/IPM <input type="checkbox"/> EZOLV</p> <p>Sets the scaling factor for the torque monitor in the EtherNet/IP Class ID 2AH Object.</p>	0 (-15 - +15)
F7-20 (03F8)	EtherNet/IP Power Scaling Factor	<p><input type="checkbox"/> V/f <input type="checkbox"/> OLV <input type="checkbox"/> OLV/IPM <input type="checkbox"/> AOLV/IPM <input type="checkbox"/> EZOLV</p> <p>Sets the scaling factor for the power monitor in the EtherNet/IP Class ID 2AH Object.</p>	0 (-15 - +15)
F7-21 (03F9)	EtherNet/IP Voltage Scale Factor	<p><input type="checkbox"/> V/f <input type="checkbox"/> OLV <input type="checkbox"/> OLV/IPM <input type="checkbox"/> AOLV/IPM <input type="checkbox"/> EZOLV</p> <p>Sets the scaling factor for the voltage monitor in the EtherNet/IP Class ID 2AH Object.</p>	0 (-15 - +15)
F7-22 (03FA)	EtherNet/IP Time Scaling	<p><input type="checkbox"/> V/f <input type="checkbox"/> OLV <input type="checkbox"/> OLV/IPM <input type="checkbox"/> AOLV/IPM <input type="checkbox"/> EZOLV</p> <p>Sets the scaling factor for the time monitor in the EtherNet/IP Class ID 2AH Object.</p>	0 (-15 - +15)
F7-23 (03FB)	Dynamic Out Param 1 for CommCard	<p><input type="checkbox"/> V/f <input type="checkbox"/> OLV <input type="checkbox"/> OLV/IPM <input type="checkbox"/> AOLV/IPM <input type="checkbox"/> EZOLV</p> <p>When you use an Ethernet/IP option, sets Output Assembly 116. The drive writes the values from Output Assembly 116 to the MEMOBUS/Modbus address register that is stored for each parameter. The drive will not write the values from Output Assembly 116 to the registers when the MEMOBUS/Modbus address is 0. When you use a PROFINET option, set this parameter to set to configurable output 1.</p>	0
F7-24 (03FC)	Dynamic Out Param 2 for CommCard	<p><input type="checkbox"/> V/f <input type="checkbox"/> OLV <input type="checkbox"/> OLV/IPM <input type="checkbox"/> AOLV/IPM <input type="checkbox"/> EZOLV</p> <p>When you use an Ethernet/IP option, sets Output Assembly 116. The drive writes the values from Output Assembly 116 to the MEMOBUS/Modbus address register that is stored for each parameter. The drive will not write the values from Output Assembly 116 to the registers when the MEMOBUS/Modbus address is 0. When you use a PROFINET option, set this parameter to set to configurable output 2.</p>	0

No. (Hex.)	Name	Description	Default (Range)
F7-25 (03FD)	Dynamic Out Param 3 for CommCard	V/f OLV OLV/PM AOLV/PM EZOLV When you use an Ethernet/IP option, sets Output Assembly 116. The drive writes the values from Output Assembly 116 to the MEMOBUS/Modbus address register that is stored for each parameter. The drive will not write the values from Output Assembly 116 to the registers when the MEMOBUS/Modbus address is 0. When you use a PROFINET option, set this parameter to set to configurable output 3.	0
F7-26 (03FE)	Dynamic Out Param 4 for CommCard	V/f OLV OLV/PM AOLV/PM EZOLV Sets Output Assembly 116 when you use an Ethernet/IP option. The drive writes the values from Output Assembly 116 to the MEMOBUS/Modbus address register that is stored for each parameter. The drive will not write the values from Output Assembly 116 to the registers when the MEMOBUS/Modbus address is 0. When you use a ProfiNet option, set this parameter to set to configurable output 4.	0
F7-27 (03FF)	Dynamic Out Param 5 for CommCard	V/f OLV OLV/PM AOLV/PM EZOLV When you use an Ethernet/IP option, sets Output Assembly 116. The drive writes the values from Output Assembly 116 to the MEMOBUS/Modbus address register that is stored for each parameter. The drive will not write the values from Output Assembly 116 to the registers when the MEMOBUS/Modbus address is 0. When you use a PROFINET option, set this parameter to set to configurable output 5.	0
F7-28 (0370)	Dynamic Out Param 6 for CommCard	V/f OLV OLV/PM AOLV/PM EZOLV When you use an Ethernet/IP option, sets Output Assembly 116. The drive writes the values from Output Assembly 116 to the MEMOBUS/Modbus address register that is stored for each parameter. The drive will not write the values from Output Assembly 116 to the registers when the MEMOBUS/Modbus address is 0.	0
F7-29 (0371)	Dynamic Out Param 7 for CommCard	V/f OLV OLV/PM AOLV/PM EZOLV When you use an Ethernet/IP option, sets Output Assembly 116. The drive writes the values from Output Assembly 116 to the MEMOBUS/Modbus address register that is stored for each parameter. The drive will not write the values from Output Assembly 116 to the registers when the MEMOBUS/Modbus address is 0.	0
F7-30 (0372)	Dynamic Out Param 8 for CommCard	V/f OLV OLV/PM AOLV/PM EZOLV When you use an Ethernet/IP option, sets Output Assembly 116. The drive writes the values from Output Assembly 116 to the MEMOBUS/Modbus address register that is stored for each parameter. The drive will not write the values from Output Assembly 116 to the registers when the MEMOBUS/Modbus address is 0.	0
F7-31 (0373)	Dynamic Out Param 9 for CommCard	V/f OLV OLV/PM AOLV/PM EZOLV When you use an Ethernet/IP option, sets Output Assembly 116. The drive writes the values from Output Assembly 116 to the MEMOBUS/Modbus address register that is stored for each parameter. The drive will not write the values from Output Assembly 116 to the registers when the MEMOBUS/Modbus address is 0.	0
F7-32 (0374)	Dynamic Out Param 10 for CommCard	V/f OLV OLV/PM AOLV/PM EZOLV When you use an Ethernet/IP option, sets Output Assembly 116. The drive writes the values from Output Assembly 116 to the MEMOBUS/Modbus address register that is stored for each parameter. The drive will not write the values from Output Assembly 116 to the registers when the MEMOBUS/Modbus address is 0.	0
F7-33 (0375)	Dynamic In Param 1 for CommCard	V/f OLV OLV/PM AOLV/PM EZOLV Sets Input Assembly 166 when you use an Ethernet/IP option. The drive sends the values from the MEMOBUS/Modbus address registers stored for each parameter to Input Assembly 166. The drive returns the default register value for the option card when the MEMOBUS/Modbus address is 0 and the value sent to Input Assembly 166 is not defined. When you use a ProfiNet option, set this parameter to set to configurable input 1.	0
F7-34 (0376)	Dynamic In Param 2 for CommCard	V/f OLV OLV/PM AOLV/PM EZOLV Sets Input Assembly 166 when you use an Ethernet/IP option. The drive sends the values from the MEMOBUS/Modbus address registers stored for each parameter to Input Assembly 166. The drive returns the default register value for the option card when the MEMOBUS/Modbus address is 0 and the value sent to Input Assembly 166 is not defined. When you use a ProfiNet option, set this parameter to set to configurable input 2.	0
F7-35 (0377)	Dynamic In Param 3 for CommCard	V/f OLV OLV/PM AOLV/PM EZOLV Sets Input Assembly 166 when you use an Ethernet/IP option. The drive sends the values from the MEMOBUS/Modbus address registers stored for each parameter to Input Assembly 166. The drive returns the default register value for the option card when the MEMOBUS/Modbus address is 0 and the value sent to Input Assembly 166 is not defined. When you use a ProfiNet option, set this parameter to set to configurable input 3.	0
F7-36 (0378)	Dynamic In Param 4 for CommCard	V/f OLV OLV/PM AOLV/PM EZOLV Sets Input Assembly 166 when you use an Ethernet/IP option. The drive sends the values from the MEMOBUS/Modbus address registers stored for each parameter to Input Assembly 166. The drive returns the default register value for the option card when the MEMOBUS/Modbus address is 0 and the value sent to Input Assembly 166 is not defined. When you use a ProfiNet option, set this parameter to set to configurable input 4.	0
F7-37 (0379)	Dynamic In Param 5 for CommCard	V/f OLV OLV/PM AOLV/PM EZOLV Sets Input Assembly 166 when you use an Ethernet/IP option. The drive sends the values from the MEMOBUS/Modbus address registers stored for each parameter to Input Assembly 166. The drive returns the default register value for the option card when the MEMOBUS/Modbus address is 0 and the value sent to Input Assembly 166 is not defined. When you use a ProfiNet option, set this parameter to set to configurable input 5.	0

1.9 F: Options

No. (Hex.)	Name	Description	Default (Range)
F7-38 (037A)	Dynamic In Param 6 for CommCard	V/f OLV OLV/IPM AOLV/IPM EZOLV Sets Input Assembly 166 when you use an Ethernet/IP option. The drive sends the values from the MEMOBUS/Modbus address registers stored for each parameter to Input Assembly 166. The drive returns the default register value for the option card when the MEMOBUS/Modbus address is 0 and the value sent to Input Assembly 166 is not defined.	0
F7-39 (037B)	Dynamic In Param 7 for CommCard	V/f OLV OLV/IPM AOLV/IPM EZOLV Sets Input Assembly 166 when you use an Ethernet/IP option. The drive sends the values from the MEMOBUS/Modbus address registers stored for each parameter to Input Assembly 166. The drive returns the default register value for the option card when the MEMOBUS/Modbus address is 0 and the value sent to Input Assembly 166 is not defined.	0
F7-40 (037C)	Dynamic In Param 8 for CommCard	V/f OLV OLV/IPM AOLV/IPM EZOLV Sets Input Assembly 166 when you use an Ethernet/IP option. The drive sends the values from the MEMOBUS/Modbus address registers stored for each parameter to Input Assembly 166. The drive returns the default register value for the option card when the MEMOBUS/Modbus address is 0 and the value sent to Input Assembly 166 is not defined.	0
F7-41 (037D)	Dynamic In Param 9 for CommCard	V/f OLV OLV/IPM AOLV/IPM EZOLV Sets Input Assembly 166 when you use an Ethernet/IP option. The drive sends the values from the MEMOBUS/Modbus address registers stored for each parameter to Input Assembly 166. The drive returns the default register value for the option card when the MEMOBUS/Modbus address is 0 and the value sent to Input Assembly 166 is not defined.	0
F7-42 (037E)	Dynamic In Param 10 for CommCard	V/f OLV OLV/IPM AOLV/IPM EZOLV Sets Input Assembly 166 when you use an Ethernet/IP option. The drive sends the values from the MEMOBUS/Modbus address registers stored for each parameter to Input Assembly 166. The drive returns the default register value for the option card when the MEMOBUS/Modbus address is 0 and the value sent to Input Assembly 166 is not defined.	0
F7-60 (0780)	PZD1 Write (Control Word)	V/f OLV OLV/IPM AOLV/IPM EZOLV When you use a Profibus option, set the MEMOBUS/Modbus address for PZD1 (PPO output). PZD1 (PPO output) functions as the STW when $F7-60 = 0$ to 2.	0
F7-61 (0781)	PZD2 Write (Frequency Reference)	V/f OLV OLV/IPM AOLV/IPM EZOLV When you use a Profibus option, sets the MEMOBUS/Modbus address for PZD2 (PPO output). PZD2 (PPO output) functions as the HSW when $F7-61 = 0$ to 2.	0
F7-62 (0782)	PZD3 Write	V/f OLV OLV/IPM AOLV/IPM EZOLV When you use a Profibus option, sets the MEMOBUS/Modbus address for PZD3 (PPO output). A value of 0, 1, or 2 will disable the PZD3 (PPO output) write operation to the MEMOBUS/Modbus register.	0
F7-63 (0783)	PZD4 Write	V/f OLV OLV/IPM AOLV/IPM EZOLV When you use a Profibus option, sets the MEMOBUS/Modbus address for PZD4 (PPO output). A value of 0, 1, or 2 will disable the PZD4 (PPO output) write operation to the MEMOBUS/Modbus register.	0
F7-64 (0784)	PZD5 Write	V/f OLV OLV/IPM AOLV/IPM EZOLV When you use a Profibus option, sets the MEMOBUS/Modbus address for PZD5 (PPO output). A value of 0, 1, or 2 will disable the PZD5 (PPO output) write operation to the MEMOBUS/Modbus register.	0
F7-65 (0785)	PZD6 Write	V/f OLV OLV/IPM AOLV/IPM EZOLV When you use a Profibus option, sets the MEMOBUS/Modbus address for PZD6 (PPO output). A value of 0, 1, or 2 will disable the PZD6 (PPO output) write operation to the MEMOBUS/Modbus register.	0
F7-66 (0786)	PZD7 Write	V/f OLV OLV/IPM AOLV/IPM EZOLV When you use a Profibus option, sets the MEMOBUS/Modbus address for PZD7 (PPO output). A value of 0, 1, or 2 will disable the PZD7 (PPO output) write operation to the MEMOBUS/Modbus register.	0
F7-67 (0787)	PZD8 Write	V/f OLV OLV/IPM AOLV/IPM EZOLV When you use a Profibus option, sets the MEMOBUS/Modbus address for PZD8 (PPO output). A value of 0, 1, or 2 will disable the PZD8 (PPO output) write operation to the MEMOBUS/Modbus register.	0
F7-68 (0788)	PZD9 Write	V/f OLV OLV/IPM AOLV/IPM EZOLV When you use a Profibus option, sets the MEMOBUS/Modbus address for PZD9 (PPO output). A value of 0, 1, or 2 will disable the PZD9 (PPO output) write operation to the MEMOBUS/Modbus register.	0
F7-69 (0789)	PZD10 Write	V/f OLV OLV/IPM AOLV/IPM EZOLV When you use a Profibus option, sets the MEMOBUS/Modbus address for PZD10 (PPO output). A value of 0, 1, or 2 will disable the PZD10 (PPO output) write operation to the MEMOBUS/Modbus register.	0
F7-70 (078A)	PZD1 Read (Status Word)	V/f OLV OLV/IPM AOLV/IPM EZOLV When you use a Profibus option, sets the MEMOBUS/Modbus address for PZD1 (PPO input). PZD1 (PPO input) functions as the ZSW when $F7-70 = 0$.	0
F7-71 (078B)	PZD2 Read (Output Frequency)	V/f OLV OLV/IPM AOLV/IPM EZOLV When you use a Profibus option, sets the MEMOBUS/Modbus address for PZD2 (PPO input). PZD2 (PPO input) functions as the HIW when $F7-71 = 0$.	0

No. (Hex.)	Name	Description	Default (Range)
F7-72 (078C)	PZD3 Read	V/f OLV OLV/PM AOLV/PM EZOLV When you use a Profibus option, sets the MEMOBUS/Modbus address for PZD3 (PPO input). A value of 0 will disable the PZD3 (PPO input) load operation from the MEMOBUS/Modbus register.	0
F7-73 (078D)	PZD4 Read	V/f OLV OLV/PM AOLV/PM EZOLV When you use a Profibus option, sets the MEMOBUS/Modbus address for PZD4 (PPO input). A value of 0 will disable the PZD4 (PPO input) load operation from the MEMOBUS/Modbus register.	0
F7-74 (078E)	PZD5 Read	V/f OLV OLV/PM AOLV/PM EZOLV When you use a Profibus option, sets the MEMOBUS/Modbus address for PZD5 (PPO input). A value of 0 will disable the PZD5 (PPO input) load operation from the MEMOBUS/Modbus register.	0
F7-75 (078F)	PZD6 Read	V/f OLV OLV/PM AOLV/PM EZOLV When you use a Profibus option, sets the MEMOBUS/Modbus address for PZD6 (PPO input). A value of 0 will disable the PZD6 (PPO input) load operation from the MEMOBUS/Modbus register.	0
F7-76 (0790)	PZD7 Read	V/f OLV OLV/PM AOLV/PM EZOLV When you use a Profibus option, sets the MEMOBUS/Modbus address for PZD7 (PPO input). A value of 0 will disable the PZD7 (PPO input) load operation from the MEMOBUS/Modbus register.	0
F7-77 (0791)	PZD8 Read	V/f OLV OLV/PM AOLV/PM EZOLV When you use a Profibus option, sets the MEMOBUS/Modbus address for PZD8 (PPO input). A value of 0 will disable the PZD8 (PPO input) load operation from the MEMOBUS/Modbus register.	0
F7-78 (0792)	PZD9 Read	V/f OLV OLV/PM AOLV/PM EZOLV When you use a Profibus option, sets the MEMOBUS/Modbus address for PZD9 (PPO input). A value of 0 will disable the PZD9 (PPO input) load operation from the MEMOBUS/Modbus register.	0
F7-79 (0793)	PZD10 Read	V/f OLV OLV/PM AOLV/PM EZOLV When you use a Profibus option, sets the MEMOBUS/Modbus address for PZD10 (PPO input). A value of 0 will disable the PZD10 (PPO input) load operation from the MEMOBUS/Modbus register.	0

1.10 H: Terminal Functions

◆ H1: Digital Inputs

No. (Hex.)	Name	Description	Default (Range)
H1-01 (0438)	Terminal S1 Function Selection	V/f OLV OLV/PM AOLV/PM EZOLV Sets the function for MFDI terminal S1. Note: The default setting is <i>F</i> when you initialize the drive for <i>3-Wire Initialization</i> [A1-03 = 3330].	40 (1 - 1FF)
H1-02 (0439)	Terminal S2 Function Selection	V/f OLV OLV/PM AOLV/PM EZOLV Sets the function for MFDI terminal S2. Note: The default setting is <i>F</i> when you initialize the drive for <i>3-Wire Initialization</i> [A1-03 = 3330].	41 (1 - 1FF)
H1-03 (0400)	Terminal S3 Function Selection	V/f OLV OLV/PM AOLV/PM EZOLV Sets the function for MFDI terminal S3.	24 (0 - 1FF)
H1-04 (0401)	Terminal S4 Function Selection	V/f OLV OLV/PM AOLV/PM EZOLV Sets the function for MFDI terminal S4.	14 (0 - 1FF)
H1-05 (0402)	Terminal S5 Function Selection	V/f OLV OLV/PM AOLV/PM EZOLV Sets the function for MFDI terminal S5. Note: The default setting is <i>0</i> when the drive is initialized for <i>3-Wire Initialization</i> [A1-03 = 3330].	3 (0 - 1FF)
H1-06 (0403)	Terminal S6 Function Selection	V/f OLV OLV/PM AOLV/PM EZOLV Sets the function for MFDI terminal S6. Note: The default setting is <i>3</i> when the drive is initialized for <i>3-Wire Initialization</i> [A1-03 = 3330].	4 (0 - 1FF)
H1-07 (0404)	Terminal S7 Function Selection	V/f OLV OLV/PM AOLV/PM EZOLV Sets the function for MFDI terminal S7. Note: The default setting is <i>4</i> when the drive is initialized for <i>3-Wire Initialization</i> [A1-03 = 3330].	6 (0 - 1FF)
H1-21 (0B70)	Terminal S1 Function Selection 2	V/f OLV OLV/PM AOLV/PM EZOLV Sets the second function for MFDI terminal S1.	F (1 - 19F)
H1-22 (0B71)	Terminal S2 Function Selection 2	V/f OLV OLV/PM AOLV/PM EZOLV Sets the second function for MFDI terminal S2.	F (1 - 19F)
H1-23 (0B72)	Terminal S3 Function Selection 2	V/f OLV OLV/PM AOLV/PM EZOLV Sets the second function for MFDI terminal S3.	F (1 - 19F)
H1-24 (0B73)	Terminal S4 Function Selection 2	V/f OLV OLV/PM AOLV/PM EZOLV Sets the second function for MFDI terminal S4.	F (1 - 19F)
H1-25 (0B74)	Terminal S5 Function Selection 2	V/f OLV OLV/PM AOLV/PM EZOLV Sets the second function for MFDI terminal S5.	F (1 - 19F)
H1-26 (0B75)	Terminal S6 Function Selection 2	V/f OLV OLV/PM AOLV/PM EZOLV Sets the second function for MFDI terminal S6.	F (1 - 19F)
H1-27 (0B76)	Terminal S7 Function Selection 2	V/f OLV OLV/PM AOLV/PM EZOLV Sets the second function for MFDI terminal S7.	F (1 - 19F)
H1-40 (0B54)	Mbus Reg 15C0h bit0 Input Func	V/f OLV OLV/PM AOLV/PM EZOLV Sets MFDI function to set to <i>bit 0</i> of the MEMOBUS register <i>15C0</i> (Hex.).	F (1 - 19F)
H1-41 (0B55)	Mbus Reg 15C0h bit1 Input Func	V/f OLV OLV/PM AOLV/PM EZOLV Sets MFDI function to set to <i>bit 1</i> of the MEMOBUS register <i>15C0</i> (Hex.).	F (1 - 19F)
H1-42 (0B56)	Mbus Reg 15C0h bit2 Input Func	V/f OLV OLV/PM AOLV/PM EZOLV Sets MFDI function to set to <i>bit 2</i> of the MEMOBUS register <i>15C0</i> (Hex.).	F (1 - 19F)

■ H1-xx: MFDI Setting Values

Setting Value	Function	Description
0	3-Wire Sequence	<input type="checkbox"/> V/f <input type="checkbox"/> OLV <input type="checkbox"/> OLV/PM <input type="checkbox"/> AOLV/PM <input type="checkbox"/> EZOLV Sets the direction of motor rotation for 3-wire sequence.
1	LOCAL/REMOTE Selection	<input type="checkbox"/> V/f <input type="checkbox"/> OLV <input type="checkbox"/> OLV/PM <input type="checkbox"/> AOLV/PM <input type="checkbox"/> EZOLV Sets drive control for the keypad (LOCAL) or an external source (REMOTE). ON : LOCAL OFF : REMOTE
2	External Reference 1/2 Selection	<input type="checkbox"/> V/f <input type="checkbox"/> OLV <input type="checkbox"/> OLV/PM <input type="checkbox"/> AOLV/PM <input type="checkbox"/> EZOLV Sets the drive to use Run command source 1/2 or Reference command source 1/2 when in REMOTE Mode. ON : b1-15 [Frequency Reference Selection 2], b1-16 [Run Command Selection 2] OFF : b1-01 [Frequency Reference Selection 1], b1-02 [Run Command Selection 1]
3	Multi-Step Speed Reference 1	<input type="checkbox"/> V/f <input type="checkbox"/> OLV <input type="checkbox"/> OLV/PM <input type="checkbox"/> AOLV/PM <input type="checkbox"/> EZOLV Uses speed references d1-01 to d1-16 to set a multi-step speed reference.
4	Multi-Step Speed Reference 2	<input type="checkbox"/> V/f <input type="checkbox"/> OLV <input type="checkbox"/> OLV/PM <input type="checkbox"/> AOLV/PM <input type="checkbox"/> EZOLV Uses speed references d1-01 to d1-16 to set a multi-step speed reference.
5	Multi-Step Speed Reference 3	<input type="checkbox"/> V/f <input type="checkbox"/> OLV <input type="checkbox"/> OLV/PM <input type="checkbox"/> AOLV/PM <input type="checkbox"/> EZOLV Uses speed references d1-01 to d1-16 to set a multi-step speed reference.
6	Jog Reference Selection	<input type="checkbox"/> V/f <input type="checkbox"/> OLV <input type="checkbox"/> OLV/PM <input type="checkbox"/> AOLV/PM <input type="checkbox"/> EZOLV Sets the drive to use the JOG Frequency Reference (JOG command) set in d1-17. The JOG Frequency Reference (JOG command) overrides Frequency References 1 to 16 (d1-01 to d1-16).
7	Accel/Decel Time Selection 1	<input type="checkbox"/> V/f <input type="checkbox"/> OLV <input type="checkbox"/> OLV/PM <input type="checkbox"/> AOLV/PM <input type="checkbox"/> EZOLV Sets the drive to use Acceleration/Deceleration Time 1 [C1-01, C1-02] or Acceleration/Deceleration Time 2 [C1-03, C1-04].
8	Baseblock Command (N.O.)	<input type="checkbox"/> V/f <input type="checkbox"/> OLV <input type="checkbox"/> OLV/PM <input type="checkbox"/> AOLV/PM <input type="checkbox"/> EZOLV Sets the command that stops drive output and coasts the motor to stop when the input is ON. ON : Baseblock (drive output stop) OFF : Normal operation
9	Baseblock Command (N.C.)	<input type="checkbox"/> V/f <input type="checkbox"/> OLV <input type="checkbox"/> OLV/PM <input type="checkbox"/> AOLV/PM <input type="checkbox"/> EZOLV Sets the command that stops drive output and coasts the motor to stop when the input terminal is OFF. ON : Normal operation OFF : Baseblock (drive output stop)
A	Accel/Decel Ramp Hold	<input type="checkbox"/> V/f <input type="checkbox"/> OLV <input type="checkbox"/> OLV/PM <input type="checkbox"/> AOLV/PM <input type="checkbox"/> EZOLV Momentarily pauses motor acceleration and deceleration when the terminal is turned ON, retains the output frequency that was stored in the drive at the time of the pause, and restarts motor operation.
B	Overheat Alarm (oH2)	<input type="checkbox"/> V/f <input type="checkbox"/> OLV <input type="checkbox"/> OLV/PM <input type="checkbox"/> AOLV/PM <input type="checkbox"/> EZOLV Sets the drive to show an oH2 [External Overheat (H1-XX=B)] alarm when the input terminal is ON. The alarm does not have an effect on drive operation.
C	Analog Terminal Enable Selection	<input type="checkbox"/> V/f <input type="checkbox"/> OLV <input type="checkbox"/> OLV/PM <input type="checkbox"/> AOLV/PM <input type="checkbox"/> EZOLV Sets the command that enables or disables the terminals selected in H3-14 [Analog Input Terminal Enable Sel]. ON : Input to the terminal selected with H3-14 is enabled OFF : Input to the terminal selected with H3-14 is disabled
E	ASR Integral Reset	<input type="checkbox"/> V/f <input type="checkbox"/> OLV <input type="checkbox"/> OLV/PM <input type="checkbox"/> AOLV/PM <input type="checkbox"/> EZOLV Sets the command to reset the integral value and use PI control or P control for the speed control loop. ON : P control OFF : PI control
F	Not Used	<input type="checkbox"/> V/f <input type="checkbox"/> OLV <input type="checkbox"/> OLV/PM <input type="checkbox"/> AOLV/PM <input type="checkbox"/> EZOLV Use this setting for unused terminals or to use terminals in through mode.
10	Up Command	<input type="checkbox"/> V/f <input type="checkbox"/> OLV <input type="checkbox"/> OLV/PM <input type="checkbox"/> AOLV/PM <input type="checkbox"/> EZOLV Sets the command to use a push button switch to increase the drive frequency reference. You must also set Setting 11 [Down Command]. ON : Increases the frequency reference. OFF : Holds the current frequency reference.
11	Down Command	<input type="checkbox"/> V/f <input type="checkbox"/> OLV <input type="checkbox"/> OLV/PM <input type="checkbox"/> AOLV/PM <input type="checkbox"/> EZOLV Sets the command to use a push button switch to decrease the drive frequency reference. You must also set Setting 10 [Up Command]. ON : Decreases the frequency reference. OFF : Holds the current frequency reference.
12	Forward Jog	<input type="checkbox"/> V/f <input type="checkbox"/> OLV <input type="checkbox"/> OLV/PM <input type="checkbox"/> AOLV/PM <input type="checkbox"/> EZOLV Sets the command to operate the motor in the forward direction at the Jog Frequency set in d1-17 [Jog Reference].

1.10 H: Terminal Functions

Setting Value	Function	Description
13	Reverse Jog	V/f OLV OLV/PM AOLV/PM EZOLV Sets the command to operate the motor in the reverse direction at the Jog Frequency set in <i>d1-17 [Jog Reference]</i> .
14	Fault Reset	V/f OLV OLV/PM AOLV/PM EZOLV Sets the command to reset the current fault when the Run command is inactive. Note: The drive ignores the fault reset command when the Run command is active. Remove the Run command before trying to reset a fault.
15	Fast Stop (N.O.)	V/f OLV OLV/PM AOLV/PM EZOLV Sets the command to ramp to stop in the deceleration time set in <i>C1-09 [Fast Stop Time]</i> when the input terminal is ON while the drive is operating.
16	Motor 2 Selection	V/f OLV OLV/PM AOLV/PM EZOLV Sets the command for the drive to operate motor 1 or motor 2. Stop the motors before switching. ON : Operate motor 2 OFF : Operate motor 1
17	Fast Stop (N.C.)	V/f OLV OLV/PM AOLV/PM EZOLV Sets the command to ramp to stop in the deceleration time set in <i>C1-09 [Fast Stop Time]</i> when the input terminal is ON while the drive is operating.
18	Timer Function	V/f OLV OLV/PM AOLV/PM EZOLV Sets the command to start the timer function. Use this setting with <i>Timer Output [H2-xx = 12]</i> .
19	PID Disable	V/f OLV OLV/PM AOLV/PM EZOLV Sets the command to disable PID control when <i>b5-01 = 1 to 8 [PID Mode Setting = Enabled]</i> . ON : PID control disabled OFF : PID control enabled
1 A	Accel/Decel Time Selection 2	V/f OLV OLV/PM AOLV/PM EZOLV Set this function and <i>H1-xx = 7 [Accel/Decel Time Selection 1]</i> together. Sets the drive to use <i>Acceleration/Deceleration Time 3 [C1-05, C1-06]</i> or <i>Acceleration/Deceleration Time 4 [C1-07, C1-08]</i> .
1B	Programming Lockout	V/f OLV OLV/PM AOLV/PM EZOLV Sets the command to prevent parameter changes when the terminal is OFF. ON : Programming Lockout OFF : Parameter Write Prohibit
1E	Reference Sample Hold	V/f OLV OLV/PM AOLV/PM EZOLV Sets the command to sample the frequency reference at terminal A1 or A2, and hold the frequency reference at that frequency.
20	External Fault (NO-Always-Ramp)	V/f OLV OLV/PM AOLV/PM EZOLV When the terminal activates, the drive ramps to stop in the selected deceleration time. Fault relay output terminal MA-MC will turn ON, and MB-MC will turn OFF. The drive always detects external faults whether the drive is stopped or running.
21	External Fault (NC-Always-Ramp)	V/f OLV OLV/PM AOLV/PM EZOLV When the terminal deactivates, the drive ramps to stop in the selected deceleration time. Fault relay output terminal MA-MC will turn ON, and MB-MC will turn OFF. The drive always detects external faults whether the drive is stopped or running.
22	External Fault (NO-@Run-Ramp)	V/f OLV OLV/PM AOLV/PM EZOLV When the terminal activates during run, the drive ramps to stop in the selected deceleration time. Fault relay output terminal MA-MC will turn ON, and MB-MC will turn OFF. The drive does not detect external faults while the drive is stopped.
23	External Fault (NC-@Run-Ramp)	V/f OLV OLV/PM AOLV/PM EZOLV When the terminal deactivates during run, the drive ramps to stop in the selected deceleration time. Fault relay output terminal MA-MC will turn ON, and MB-MC will turn OFF. The drive does not detect external faults while the drive is stopped.
24	External Fault (NO-Always-Coast)	V/f OLV OLV/PM AOLV/PM EZOLV When the terminal activates, the drive shuts off the output and the motor coasts to stop. Fault relay output terminal MA-MC will turn ON, and MB-MC will turn OFF. The drive always detects external faults whether the drive is stopped or running.
25	External Fault (NC-Always-Coast)	V/f OLV OLV/PM AOLV/PM EZOLV When the terminal deactivates, the drive shuts off the output and the motor coasts to stop. Fault relay output terminal MA-MC will turn ON, and MB-MC will turn OFF. The drive always detects external faults whether the drive is stopped or running.
26	External Fault (NO-@Run-Coast)	V/f OLV OLV/PM AOLV/PM EZOLV When the terminal activates during run, the drive shuts off the output and the motor coasts to stop. Fault relay output terminal MA-MC will turn ON, and MB-MC will turn OFF. The drive does not detect external faults while the drive is stopped.
27	External Fault (NC-@Run-Coast)	V/f OLV OLV/PM AOLV/PM EZOLV When the terminal deactivates during run, the drive shuts off the output and the motor coasts to stop. Fault relay output terminal MA-MC will turn ON, and MB-MC will turn OFF. The drive does not detect external faults while the drive is stopped.
28	External Fault (NO-Always-FStop)	V/f OLV OLV/PM AOLV/PM EZOLV When the terminal activates, the drive stops the motor in the deceleration time set to <i>C1-09 [Fast Stop Time]</i> . Fault relay output terminal MA-MC turns ON, and MB-MC turns OFF. Stopped drives and running drives will detect external faults.
29	External Fault (NC-Always-FStop)	V/f OLV OLV/PM AOLV/PM EZOLV When the terminal deactivates, the drive stops the motor in the deceleration time set to <i>C1-09 [Fast Stop Time]</i> . Fault relay output terminal MA-MC turns ON, and MB-MC turns OFF. Stopped drives and running drives will detect external faults.

Setting Value	Function	Description
2A	External Fault (NO-@Run-FStop)	V/f OLV OLV/PM AOLV/PM EZOLV When the terminal activates during run, the drive stops the motor in the deceleration time set to <i>C1-09 [Fast Stop Time]</i> . Fault relay output terminal MA-MC turns ON, and MB-MC turns OFF. Stopped drives will not detect external faults.
2B	External Fault (NC-@Run-FStop)	V/f OLV OLV/PM AOLV/PM EZOLV When the terminal deactivates during run, the drive stops the motor in the deceleration time set to <i>C1-09 [Fast Stop Time]</i> . Fault relay output terminal MA-MC turns ON, and MB-MC turns OFF. Stopped drives will not detect external faults.
2C	External Fault (NO-Always-Alarm)	V/f OLV OLV/PM AOLV/PM EZOLV When the terminal activates, the keypad shows <i>EFx [External Fault (Input Terminal Sx)]</i> and the output terminal set for Alarm [<i>H2-01 to H2-03 = 10</i>] activates. The drive continues operation. Stopped drives and running drives will detect external faults.
2D	External Fault (NC-Always-Alarm)	V/f OLV OLV/PM AOLV/PM EZOLV When the terminal deactivates, the keypad shows <i>EFx [External Fault (Input Terminal Sx)]</i> and the output terminal set for Alarm [<i>H2-01 to H2-03 = 10</i>] activates. The drive continues operation. Stopped drives and running drives will detect external faults.
2E	External Fault (NO-@Run-Alarm)	V/f OLV OLV/PM AOLV/PM EZOLV When the terminal activates during run, the keypad shows <i>EFx [External Fault (Input Terminal Sx)]</i> and the output terminal set for Alarm [<i>H2-01 to H2-03 = 10</i>] activates. The drive continues operation. Stopped drives will not detect external faults.
2F	External Fault (NC-@Run-Alarm)	V/f OLV OLV/PM AOLV/PM EZOLV When the terminal deactivates during run, the keypad shows <i>EFx [External Fault (Input Terminal Sx)]</i> and the output terminal set for Alarm [<i>H2-01 to H2-03 = 10</i>] activates. The drive continues operation. Stopped drives will not detect external faults.
30	PID Integrator Reset	V/f OLV OLV/PM AOLV/PM EZOLV Sets the command to reset and hold the PID control integral to 0 when the terminal is ON.
31	PID Integrator Hold	V/f OLV OLV/PM AOLV/PM EZOLV Sets the command to hold the integral value of the PID control while the terminal is activated.
32	Multi-Step Speed Reference 4	V/f OLV OLV/PM AOLV/PM EZOLV Uses speed references <i>d1-01 to d1-16</i> to set a multi-step speed reference.
34	PID Soft Starter Disable	V/f OLV OLV/PM AOLV/PM EZOLV Sets the PID soft starter function. ON : Disable OFF : Enabled
35	PID Input (Error) Invert	V/f OLV OLV/PM AOLV/PM EZOLV Sets the command to turn the terminal ON and OFF to switch the PID input level (polarity).
3E	PID Setpoint Selection 1	V/f OLV OLV/PM AOLV/PM EZOLV Set this function and <i>H1-xx = 3F [PID Setpoint Selection 2]</i> together. Sets the function to switch the PID setpoint to <i>b5-58 to b5-60 [PID Setpoint 2 to 4]</i> .
3F	PID Setpoint Selection 2	V/f OLV OLV/PM AOLV/PM EZOLV Set this function and <i>H1-xx = 3E [PID Setpoint Selection 1]</i> at the same time. Sets the function to switch the PID setpoint to <i>b5-58 to b5-60 [PID Setpoint 2 to 4]</i> .
40	Forward RUN (2-Wire)	V/f OLV OLV/PM AOLV/PM EZOLV Sets the Forward Run command for 2-wire sequence 1. Set this function and <i>H1-xx = 41 [Reverse RUN (2-Wire)]</i> together. ON : Forward Run OFF : Stop Note: • If you turn ON the Forward Run command terminal and the Reverse Run command terminal, it will cause an <i>EF [FWD/REV Run Command Input Error]</i> alarm and the motor will ramp to stop. • Initialize the drive with a 2-wire sequence to set the Forward Run command to terminal S1. • This function will not operate at the same time as <i>H1-xx = 42, 43 [Run Command (2-Wire Sequence 2), FWD/REV (2-Wire Sequence 2)]</i> .
41	Reverse RUN (2-Wire)	V/f OLV OLV/PM AOLV/PM EZOLV Sets the Forward Run command for 2-wire sequence 1. Set this function and <i>H1-xx = 40 [Forward RUN (2-Wire)]</i> together. ON : Reverse Run OFF : Stop Note: • If you turn ON the Forward Run command terminal and the Reverse Run command terminal, it will cause an <i>EF [FWD/REV Run Command Input Error]</i> alarm and the motor will ramp to stop. • Initialize the drive with a 2-wire sequence to set the Reverse Run command to terminal S2. • This function will not operate at the same time as <i>H1-xx = 42, 43 [Run Command (2-Wire Sequence 2), FWD/REV (2-Wire Sequence 2)]</i> .
42	Run Command (2-Wire Sequence 2)	V/f OLV OLV/PM AOLV/PM EZOLV Sets the Run command for 2-wire sequence 2. Set this function and <i>H1-xx = 43 [FWD/REV (2-Wire Sequence 2)]</i> together. ON : Run OFF : Stop Note: This function will not operate at the same time as <i>H1-xx = 40, 41 [Forward RUN (2-Wire), Reverse RUN (2-Wire)]</i> .

1.10 H: Terminal Functions

Setting Value	Function	Description
43	FWD/REV (2-Wire Sequence 2)	<p>V/f OLV OLV/PM AOLV/PM EZOLV</p> <p>Sets the direction of motor rotation for 2-wire sequence 2. Set this function and $H1-xx = 42$ [Run Command (2-Wire Sequence 2)] together. ON : Reverse Run OFF : Forward Run</p> <p>Note:</p> <ul style="list-style-type: none"> You must input the Run command to rotate the motor. This function will not operate at the same time as $H1-xx = 40, 41$ [Forward RUN (2-Wire), Reverse RUN (2-Wire)].
44	Add Offset Frequency 1 (d7-01)	<p>V/f OLV OLV/PM AOLV/PM EZOLV</p> <p>Sets the function to add the offset frequency set in d7-01 [Offset Frequency 1] to the frequency reference when the terminal activates.</p>
45	Add Offset Frequency 2 (d7-02)	<p>V/f OLV OLV/PM AOLV/PM EZOLV</p> <p>Sets the function to add the offset frequency set in d7-02 [Offset Frequency 2] to the frequency reference when the terminal activates.</p>
46	Add Offset Frequency 3 (d7-03)	<p>V/f OLV OLV/PM AOLV/PM EZOLV</p> <p>Sets the function to add the offset frequency set in d7-03 [Offset Frequency 3] to the frequency reference when the terminal activates.</p>
47	Node Setup (CANopen)	<p>V/f OLV OLV/PM AOLV/PM EZOLV</p> <p>Sets the function in CANopen communications to start the Node Setup function to set the drive node address from the host controller.</p>
60	DC Injection Braking Command	<p>V/f OLV OLV/PM AOLV/PM EZOLV</p> <p>Sets the command to use DC Injection Braking to stop the motor.</p> <p>Note:</p> <p>When $A1-02 = 8$ [Control Method Selection = EZOLV], this function is available with a PM motor.</p>
61	Speed Search from Fmax	<p>V/f OLV OLV/PM AOLV/PM EZOLV</p> <p>Sets the function to use an external reference to start speed search although $b3-01 = 0$ [Speed Search Selection at Start = Disabled] to not allow speed search at start.</p> <p>Note:</p> <p>The drive will detect $oPE03$ [Multi-Function Input Setting Err] when $H1-xx = 61$ [Speed Search from Fmax] and $H1-xx = 62$ [Speed Search from Fref] are set at the same time.</p>
62	Speed Search from Fref	<p>V/f OLV OLV/PM AOLV/PM EZOLV</p> <p>Sets the function to use an external reference to start speed search although $b3-01 = 0$ [Speed Search Selection at Start = Disabled] to not allow speed search at start.</p> <p>Note:</p> <p>The drive will detect $oPE03$ [Multi-Function Input Setting Err] when $H1-xx = 61$ [Speed Search from Fmax] and $H1-xx = 62$ [Speed Search from Fref] are set at the same time.</p>
63	Field Weakening	<p>V/f OLV OLV/PM AOLV/PM EZOLV</p> <p>Sets the function to send the Field Weakening Level and Field Weakening Frequency Limit commands set in d6-01 [Field Weakening Level] and d6-02 [Field Weakening Frequency Limit] when the input terminal is activated.</p>
65	KEB Ride-Thru 1 Activate (N.C.)	<p>V/f OLV OLV/PM AOLV/PM EZOLV</p> <p>Sets operation of the KEB1 function through the KEB Ride-Thru 1 (N.C.). ON : Normal operation OFF : Deceleration during momentary power loss</p>
66	KEB Ride-Thru 1 Activate (N.O.)	<p>V/f OLV OLV/PM AOLV/PM EZOLV</p> <p>Sets operation of the KEB1 function through the KEB Ride-Thru 1 (N.O.). ON : Deceleration during momentary power loss OFF : Normal operation</p>
67	Communications Test Mode	<p>V/f OLV OLV/PM AOLV/PM EZOLV</p> <p>Set the function for the drive to self-test RS-485 serial communications operation.</p>
68	High Slip Braking (HSB) Activate	<p>V/f OLV OLV/PM AOLV/PM EZOLV</p> <p>Sets the command to use high-slip braking to stop the motor.</p>
6 A	Drive Enable	<p>V/f OLV OLV/PM AOLV/PM EZOLV</p> <p>Sets the function to show dnE [Drive Disabled] on the keypad and ignore Run commands when the terminal is OFF.</p>
75	Up 2 Command	<p>V/f OLV OLV/PM AOLV/PM EZOLV</p> <p>Sets the function to increase the frequency reference bias value to accelerate the motor when the terminal is activated. Set this function and $H1-xx = 76$ [Down 2 Command] together.</p> <p>Note:</p> <p>When you use this function, set the optimal bias limit values with d4-08 and d4-09 [Up/Down 2 Bias Upper Limit/Lower Limit].</p>
76	Down 2 Command	<p>V/f OLV OLV/PM AOLV/PM EZOLV</p> <p>Sets the function to decrease the frequency reference bias value to decelerate the motor when the terminal is activated. Set this function and $H1-xx = 75$ [Up 2 Command] together.</p> <p>Note:</p> <p>When you use this function, set the optimal bias limit values with d4-08 and d4-09 [Up/Down 2 Bias Upper Limit/Lower Limit].</p>

Setting Value	Function	Description
77	ASR Gain (C5-03) Select	<p>V/f OLV OLV/PM AOLV/PM EZOLV</p> <p>Sets the function to switch the ASR proportional gain to C5-01 [ASR Proportional Gain 1] or C5-03 [ASR Proportional Gain 2]. ON : C5-03 OFF : C5-01</p>
78	Analog TorqueRef Polarity Invert	<p>V/f OLV OLV/PM AOLV/PM EZOLV</p> <p>Sets the rotation direction of the external torque reference. ON : External torque reference reverse direction OFF : External torque reference forward direction</p>
7A	KEB Ride-Thru 2 Activate (N.C.)	<p>V/f OLV OLV/PM AOLV/PM EZOLV</p> <p>Sets operation of the KEB2 function through the KEB Ride-Thru 2 (N.C.). ON : Normal operation OFF : Deceleration during momentary power loss</p>
7B	KEB Ride-Thru 2 Activate (N.O.)	<p>V/f OLV OLV/PM AOLV/PM EZOLV</p> <p>Sets operation of the KEB2 function through the KEB Ride-Thru 2 (N.O.). ON : Deceleration during momentary power loss OFF : Normal operation</p>
7C	Short Circuit Braking (N.O.)	<p>V/f OLV OLV/PM AOLV/PM EZOLV</p> <p>Sets operation of Short Circuit Braking (N.O.). ON : Short Circuit Braking is enabled. OFF : Normal operation Note: When A1-02 = 8 [Control Method Selection = EZOLV], this function is available only when you use a PM motor.</p>
7D	Short Circuit Braking (N.C.)	<p>V/f OLV OLV/PM AOLV/PM EZOLV</p> <p>Sets operation of Short Circuit Braking (N.C.). ON : Normal operation OFF : Short Circuit Braking is enabled. Note: When A1-02 = 8 [Control Method Selection = EZOLV], this function is available only when you use a PM motor.</p>
7E	Reverse Rotation Identifier	<p>V/f OLV OLV/PM AOLV/PM EZOLV</p> <p>Sets the motor rotation direction when you use Simple Closed Loop V/f Control method. ON : Reverse run OFF : Forward run</p>
90	DWEZ Digital Input 1	<p>V/f OLV OLV/PM AOLV/PM EZOLV</p> <p>Sets the DriveWorksEZ digital input 1. Refer to the DriveWorksEZ online manual for more information.</p>
91	DWEZ Digital Input 2	<p>V/f OLV OLV/PM AOLV/PM EZOLV</p> <p>Sets the DriveWorksEZ digital input 2. Refer to the DriveWorksEZ online manual for more information.</p>
92	DWEZ Digital Input 3	<p>V/f OLV OLV/PM AOLV/PM EZOLV</p> <p>Sets the DriveWorksEZ digital input 3. Refer to the DriveWorksEZ online manual for more information.</p>
93	DWEZ Digital Input 4	<p>V/f OLV OLV/PM AOLV/PM EZOLV</p> <p>Sets the DriveWorksEZ digital input 4. Refer to the DriveWorksEZ online manual for more information.</p>
94	DWEZ Digital Input 5	<p>V/f OLV OLV/PM AOLV/PM EZOLV</p> <p>Sets the DriveWorksEZ digital input 5. Refer to the DriveWorksEZ online manual for more information.</p>
95	DWEZ Digital Input 6	<p>V/f OLV OLV/PM AOLV/PM EZOLV</p> <p>Sets the DriveWorksEZ digital input 6. Refer to the DriveWorksEZ online manual for more information.</p>
96	DWEZ Digital Input 7	<p>V/f OLV OLV/PM AOLV/PM EZOLV</p> <p>Sets the DriveWorksEZ digital input 7. Refer to the DriveWorksEZ online manual for more information.</p>
9F	DWEZ Disable	<p>V/f OLV OLV/PM AOLV/PM EZOLV</p> <p>Sets operation of the DriveWorksEZ program saved in the drive. ON : Disabled OFF : Enabled Note: Set A1-07 = 2 [DriveWorksEZ Function Selection = Enabled/Disabled wDigital Input] to use this function.</p>
101	!LOCAL/REMOTE Selection	<p>V/f OLV OLV/PM AOLV/PM EZOLV</p> <p>Sets drive control for the keypad (LOCAL) or an external source (REMOTE). ON : REMOTE OFF : LOCAL</p>

1.10 H: Terminal Functions

Setting Value	Function	Description
102	!External Reference 1/2 Selection	<p>V/f OLV OLV/IPM AOLV/IPM EZOLV</p> <p>Sets the drive to use Run command source 1/2 or Reference command source 1/2 when in REMOTE Mode. ON : $b1-01 = [Frequency\ Reference\ Selection\ 1]$, $b1-02 [Run\ Command\ Selection\ 1]$ OFF : $b1-15 = [Frequency\ Reference\ Selection\ 2]$, $b1-16 [Run\ Command\ Selection\ 2]$</p>
103	!Multi-Step Speed Reference 1	<p>V/f OLV OLV/IPM AOLV/IPM EZOLV</p> <p>Uses a combination of multi-step speed references 1, 2, 3, and 4 (N.C.) to switch $d1-01$ to $d1-16 [Reference\ 1\ to\ 16]$.</p>
104	!Multi-Step Speed Reference 2	<p>V/f OLV OLV/IPM AOLV/IPM EZOLV</p> <p>Uses a combination of multi-step speed references 1, 2, 3, and 4 (N.C.) to switch $d1-01$ to $d1-16 [Reference\ 1\ to\ 16]$.</p>
105	!Multi-Step Speed Reference 3	<p>V/f OLV OLV/IPM AOLV/IPM EZOLV</p> <p>Uses a combination of multi-step speed references 1, 2, 3, and 4 (N.C.) to switch $d1-01$ to $d1-16 [Reference\ 1\ to\ 16]$.</p>
106	!Jog Reference Selection	<p>V/f OLV OLV/IPM AOLV/IPM EZOLV</p> <p>Sets the drive to use the JOG Frequency Reference (JOG command) set in $d1-17 [Jog\ Reference]$. The JOG Frequency Reference (JOG command) overrides the $d1-01$ to $d1-16 [References\ 1\ to\ 16]$.</p>
107	!Accel/Decel Time Selection 1	<p>V/f OLV OLV/IPM AOLV/IPM EZOLV</p> <p>Sets the drive to use $C1-01$, $C1-02 [Acceleration/Deceleration\ Time\ 1]$ or $C1-03$, $C1-04 [Acceleration/Deceleration\ Time\ 2]$.</p>
10 A	!Accel/Decel Ramp Hold	<p>V/f OLV OLV/IPM AOLV/IPM EZOLV</p> <p>Momentarily pauses motor acceleration and deceleration when the terminal deactivates, retains the output frequency that was stored in the drive at the time of the pause, and restarts motor operation.</p>
10B	!Overheat Alarm (oH2)	<p>V/f OLV OLV/IPM AOLV/IPM EZOLV</p> <p>Sets the drive to display an $oH2 [Drive\ Overheat\ Warning]$ alarm when the input terminal deactivates. The alarm does not have an effect on drive operation.</p>
10C	!Analog Terminal Enable Selection	<p>V/f OLV OLV/IPM AOLV/IPM EZOLV</p> <p>Enables and disables the terminal selected with the $H3-14 [Analog\ Input\ Term\ Enable\ Select]$ function. ON : Input to the terminal selected with $H3-14$ is disabled OFF : Input to the terminal selected with $H3-14$ is enabled</p>
10E	!ASR Integral Reset	<p>V/f OLV OLV/IPM AOLV/IPM EZOLV</p> <p>Sets the command to reset the integral value and use PI control or P control for the speed control loop. ON : PI control OFF : P control</p>
110	!Up Command	<p>V/f OLV OLV/IPM AOLV/IPM EZOLV</p> <p>Set this function and $111 [!Down\ Command]$ together. Sets the Up command and Down command to use the two push button switches to increase and decrease the drive frequency reference. ON : Holds the current frequency reference. OFF : Increases the frequency reference.</p>
111	!Down Command	<p>V/f OLV OLV/IPM AOLV/IPM EZOLV</p> <p>Set this function and $110 [!Up\ Command]$ together. Sets the Up command and Down command to use the two push button switches to increase and decrease the drive frequency reference. ON : Holds the current frequency reference. OFF : Decreases the frequency reference.</p>
114	!Fault Reset	<p>V/f OLV OLV/IPM AOLV/IPM EZOLV</p> <p>Sets the command to reset the current fault when the Run command is not active. Note: The drive ignores the fault reset command when the Run command is active. Remove the Run command before you try to reset a fault.</p>
116	!Motor 2 Selection	<p>V/f OLV OLV/IPM AOLV/IPM EZOLV</p> <p>Sets the command for the drive to operate motor 1 or motor 2. Stop the motors before switching. ON : Operate motor 1 OFF : Operate motor 2</p>
118	!Timer Function	<p>V/f OLV OLV/IPM AOLV/IPM EZOLV</p> <p>Sets the command to start the timer function. Use this setting with $H2-xx = 112 [!Timer\ Output]$.</p>
119	!PID Disable	<p>V/f OLV OLV/IPM AOLV/IPM EZOLV</p> <p>Sets the command to disable PID control with an external input when $b5-01 = 1$ to $8 [PID\ Function\ Setting = Enabled]$. ON : PID control enabled OFF : PID control disabled</p>
11 A	!Accel/Decel Time Selection 2	<p>V/f OLV OLV/IPM AOLV/IPM EZOLV</p> <p>Set this function and $H1-xx = 107 [!Accel/Decel\ Time\ Selection\ 1]$ together. Sets the drive to use $C1-01$ to $C1-08 [Acceleration/Deceleration\ Times\ 1\ to\ 4]$.</p>

Setting Value	Function	Description
11B	!Programming Lockout	V/f OLV OLV/PM AOLV/PM EZOLV Sets the command to prevent parameter changes when the terminal is OFF. You can continue to view parameter setting values when the terminal is ON [Parameter Write Prohibit]. ON : Parameter Write Prohibit OFF : Programming Lockout
11E	!Reference Sample Hold	V/f OLV OLV/PM AOLV/PM EZOLV Sets the command to sample the frequency reference at terminal A1 or A2, and hold the frequency reference at that frequency.
130	!PID Integrator Reset	V/f OLV OLV/PM AOLV/PM EZOLV Sets the command to reset and hold the PID control integral to 0 when the terminal deactivates.
131	!PID Integrator Hold	V/f OLV OLV/PM AOLV/PM EZOLV Sets the command to hold the integral value of the PID control while the terminal deactivates.
132	!Multi-Step Speed Reference 4	V/f OLV OLV/PM AOLV/PM EZOLV Uses a combination of multi-step speed references 1, 2, 3, and 4 (N.C.) to switch <i>d1-01</i> to <i>d1-16</i> [Reference 1 to 16].
134	!PID Soft Starter Disable	V/f OLV OLV/PM AOLV/PM EZOLV Sets the PID soft starter function. ON : Enabled OFF : Disable
135	!PID Input (Error) Invert	V/f OLV OLV/PM AOLV/PM EZOLV Sets the command to turn the terminal ON and OFF to switch the PID input level (polarity).
13E	!PID Setpoint Selection 1	V/f OLV OLV/PM AOLV/PM EZOLV Set this function and <i>H1-xx</i> = 13F [!PID Setpoint Selection 2] together. Sets the function to use the PID setpoint set in <i>b5-58</i> to <i>b5-60</i> [PID setpoint2 to 4].
13F	!PID Setpoint Selection 2	V/f OLV OLV/PM AOLV/PM EZOLV Set this function and <i>H1-xx</i> = 13E [!PID Setpoint Selection 1] together. Sets the function to use the PID setpoint set in <i>b5-58</i> to <i>b5-60</i> [PID setpoint2 to 4].
144	!Add Offset Frequency 1 (d7-01)	V/f OLV OLV/PM AOLV/PM EZOLV Sets the function to add the offset frequency set in <i>d7-01</i> to the frequency reference when the terminal deactivates.
145	!Add Offset Frequency 2 (d7-02)	V/f OLV OLV/PM AOLV/PM EZOLV Sets the function to add the offset frequency set in <i>d7-02</i> to the frequency reference when the terminal deactivates.
146	!Add Offset Frequency 3 (d7-03)	V/f OLV OLV/PM AOLV/PM EZOLV Sets the function to add the offset frequency set in <i>ind7-03</i> to the frequency reference when the terminal deactivates.
147	!Node Setup (CANopen)	V/f OLV OLV/PM AOLV/PM EZOLV Sets the function in CANopen communications to start the Node Setup function to set the drive node address from the host controller.
160	!DC Injection Braking Command	V/f OLV OLV/PM AOLV/PM EZOLV Sets the command to use DC Injection Braking to stop the motor. Note: When <i>A1-02</i> = 8 [Control Method Selection = EZ Vector Control], this function is available if you use a PM motor.
161	!Speed Search from Fmax	V/f OLV OLV/PM AOLV/PM EZOLV Sets the function to use an external reference to start speed search although <i>b3-01</i> = 0 [Speed Search Selection at Start = Disabled] to not allow speed search at start. Note: The drive will detect <i>oPE03</i> [Multi-Function Input Setting Err] when <i>H1-xx</i> = 161 [!Speed Search from Fmax] and <i>H1-xx</i> = 162 [!Speed Search from Fref] are set at the same time.
162	!Speed Search from Fref	V/f OLV OLV/PM AOLV/PM EZOLV Sets the function to use an external reference to start speed search although <i>b3-01</i> = 0 [Speed Search Selection at Start = Disabled] to not allow speed search at start. Note: The drive will detect <i>oPE03</i> [Multi-Function Input Setting Err] when <i>H1-xx</i> = 161 [!Speed Search from Fmax] and <i>H1-xx</i> = 162 [!Speed Search from Fref] are set at the same time.
163	!Field Weakening	V/f OLV OLV/PM AOLV/PM EZOLV Sets the function to send the Field Weakening Level and Field Weakening Frequency Limit commands set in <i>d6-01</i> and <i>d6-02</i> when the input terminal deactivates.
167	!Communications Test Mode	V/f OLV OLV/PM AOLV/PM EZOLV Set the function for the drive to self-test RS-485 serial communications operation.
168	!High Slip Braking (HSB) Activate	V/f OLV OLV/PM AOLV/PM EZOLV Sets the command to use high-slip braking to stop the motor.
16 A	!Drive Enable	V/f OLV OLV/PM AOLV/PM EZOLV Sets the function to show <i>dnE</i> [Drive Enabled] on the keypad and ignore Run commands when the terminal activates.

1.10 H: Terminal Functions

Setting Value	Function	Description
175	!Up 2 Command	<p>V/f OLV OLV/PM AOLV/PM EZOLV</p> <p>When the terminal deactivates, the motor accelerates by increasing the frequency reference bias value. Set !Up 2 Command and !Down 2 Command together.</p> <p>Note: When you use the functions, set the optimal bias limit values with <i>d4-08</i> and <i>d4-09</i> [Up/Down 2 Bias Upper Limit/Lower Limit (Up/Down 2)].</p>
176	!Down 2 Command	<p>V/f OLV OLV/PM AOLV/PM EZOLV</p> <p>When the terminal deactivates, the motor decelerates by decreasing the frequency reference bias value. Set !Up 2 Command and !Down 2 Command together.</p> <p>Note: When you use the functions, set the optimal bias limit values with <i>d4-08</i> and <i>d4-09</i> [Up/Down 2 Bias Upper Limit/Lower Limit (Up/Down 2)].</p>
177	!ASR Gain (C5-03) Select	<p>V/f OLV OLV/PM AOLV/PM EZOLV</p> <p>Sets the function to switch the ASR proportional gain to <i>C5-01</i> [ASR Proportional Gain 1] or <i>C5-03</i> [ASR Proportional Gain 2]. ON : C5-01 OFF : C5-03</p>
178	!Analog TorqueRef Polarity Invert	<p>V/f OLV OLV/PM AOLV/PM EZOLV</p> <p>Sets the rotation direction of the external torque reference. ON : External torque reference forward direction OFF : External torque reference reverse direction</p>
17E	!Reverse Rotation Identifier	<p>V/f OLV OLV/PM AOLV/PM EZOLV</p> <p>Sets the motor rotation direction when you use Simple Closed Loop V/f Control method. ON : Forward run OFF : Reverse run</p>
17F	!PID Bi-Directional Enable	<p>V/f OLV OLV/PM AOLV/PM EZOLV</p> <p>Switches the PID Bi-Directional output to enable or disable. ON : Disable OFF : Enabled</p>
19F	!DWEZ Disable	<p>V/f OLV OLV/PM AOLV/PM EZOLV</p> <p>Switches the DriveWorksEZ program saved in the drive to enable or disable. ON : Enabled OFF : Disable</p> <p>Note: Set <i>A1-07</i> = 2 [DriveWorksEZ Function Selection = Digital input] to use this function.</p>

◆ H2: Digital Outputs

No. (Hex.)	Name	Description	Default (Range)
H2-01 (040B)	Term MA/MB-MC Function Selection	<p>V/f OLV OLV/PM AOLV/PM EZOLV</p> <p>Sets the function set for MFDO terminal MA-MC or MB-MC.</p> <p>Note: Set this parameter to <i>F</i> when the terminal is not being used or to use the terminal in through mode.</p>	E (0 - 1FF)
H2-02 (040C)	Term P1-C1 Function Selection	<p>V/f OLV OLV/PM AOLV/PM EZOLV</p> <p>Sets the function for MFDO terminal P1-C1.</p> <p>Note: Set this parameter to <i>F</i> when the terminal is not being used or to use the terminal in through mode.</p>	0 (0 - 1FF)
H2-03 (040D)	Term P2-C2 Function Selection	<p>V/f OLV OLV/PM AOLV/PM EZOLV</p> <p>Sets the function for MFDO terminal P2-C2.</p> <p>Note: Set this parameter to <i>F</i> when the terminal is not being used or to use the terminal in through mode.</p>	2 (0 - 1FF)
H2-06 (0437)	Watt Hour Output Unit Selection	<p>V/f OLV OLV/PM AOLV/PM EZOLV</p> <p>Sets the unit for the output signal when <i>H2-01</i> to <i>H2-03</i> = 39 [MFDO Function Selection = Watt Hour Pulse Output]. 0 : 0.1 kWh units 1 : 1 kWh units 2 : 10 kWh units 3 : 100 kWh units 4 : 1000 kWh units</p>	0 (0 - 4)

No. (Hex.)	Name	Description	Default (Range)
H2-07 (0B3A)	Modbus Register 1 Address Select	V/f OLV OLV/PM AOLV/PM EZOLV Sets the address of the MEMOBUS/Modbus register output to the MFDO terminal.	0001 (0001 - 1FFF)
H2-08 (0B3B)	Modbus Register 1 Bit Select	V/f OLV OLV/PM AOLV/PM EZOLV Sets the bit of the MEMOBUS/Modbus register output to the MFDO terminal.	0000 (0000 - FFFF)
H2-09 (0B3C)	Modbus Register 2 Address Select	V/f OLV OLV/PM AOLV/PM EZOLV Sets the address of the MEMOBUS/Modbus register output to the MFDO terminal.	0001 (0001 - 1FFF)
H2-10 (0B3D)	Modbus Register 2 Bit Select	V/f OLV OLV/PM AOLV/PM EZOLV Sets the bit of the MEMOBUS/Modbus register output to the MFDO terminal.	0000 (0000 - FFFF)
H2-20 (1540)	Comparator 1 Monitor Selection	V/f OLV OLV/PM AOLV/PM EZOLV Sets the monitor number for comparator 1. Set the <i>x-xx</i> part of the <i>Ux-xx [Monitor]</i> . For example, set <i>H2-20 = 102</i> to monitor <i>U1-02 [Output Frequency]</i> .	102 (000 - 999)
H2-21 (1541)	Comparator 1 Lower Limit	V/f OLV OLV/PM AOLV/PM EZOLV Sets the lower limit detection level for comparator 1 when the full scale analog output for the monitor selected in <i>H2-20 [Comparator 1 Monitor Selection]</i> is the 100% value.	0.0% (0.0 - 300.0%)
H2-22 (1542)	Comparator 1 Upper Limit	V/f OLV OLV/PM AOLV/PM EZOLV Sets the upper limit detection level for comparator 1 when the full scale analog output for the monitor selected in <i>H2-20 [Comparator 1 Monitor Selection]</i> is the 100% value.	0.0% (0.0 - 300.0%)
H2-23 (1543)	Comparator 1 Hysteresis	V/f OLV OLV/PM AOLV/PM EZOLV Sets the hysteresis level for comparator 1 as a percentage of the full scale analog output for the monitor selected in <i>H2-20 [Comparator 1 Monitor Selection]</i> .	0.0% (0.0 - 10.0%)
H2-24 (1544)	Comparator 1 On-Delay Time	V/f OLV OLV/PM AOLV/PM EZOLV Sets the on-delay time for comparator 1.	0.0 s (0.0 - 600.0 s)
H2-25 (1545)	Comparator 1 Off-Delay Time	V/f OLV OLV/PM AOLV/PM EZOLV Sets the off-delay time for comparator 1.	0.0 s (0.0 - 600.0 s)
H2-26 (1546)	Comparator 2 Monitor Selection	V/f OLV OLV/PM AOLV/PM EZOLV Sets the monitor number for comparator 2. Set the <i>x-xx</i> part of the <i>Ux-xx [Monitor]</i> . For example, set <i>H2-26 = 103</i> to monitor <i>U1-03 [Output Current]</i> .	103 (000 - 999)
H2-27 (1547)	Comparator 2 Lower Limit	V/f OLV OLV/PM AOLV/PM EZOLV Sets the lower limit detection level for comparator 2 as a percentage of the full scale analog output for the monitor selected in <i>H2-26 [Comparator 2 Monitor Selection]</i> .	0.0% (0.0 - 300.0%)
H2-28 (1548)	Comparator 2 Upper Limit	V/f OLV OLV/PM AOLV/PM EZOLV Sets the upper limit detection level for comparator 2 as a percentage of the full scale analog output for the monitor selected in <i>H2-26 [Comparator 2 Monitor Selection]</i> .	0.0% (0.0 - 300.0%)
H2-29 (1549)	Comparator 2 Hysteresis	V/f OLV OLV/PM AOLV/PM EZOLV Sets the hysteresis level for comparator 2 as a percentage of the full scale analog output for the monitor selected in <i>H2-26 [Comparator 2 Monitor Selection]</i> .	0.0% (0.0 - 10.0%)
H2-30 (154A)	Comparator 2 On-Delay Time	V/f OLV OLV/PM AOLV/PM EZOLV Sets the on-delay time for comparator 2.	0.0 s (0.0 - 600.0 s)
H2-31 (154B)	Comparator 2 Off-Delay Time	V/f OLV OLV/PM AOLV/PM EZOLV Sets the off-delay time for comparator 2.	0.0 s (0.0 - 600.0 s)
H2-32 (159A)	Comparator 1 Filter Time	V/f OLV OLV/PM AOLV/PM EZOLV Sets the time constant that is applied to the primary delay filter used for the analog output of the monitor selected with <i>H2-20 [Comparator 1 Monitor Selection]</i> .	0.0s (0.0 - 10.0 s)
H2-33 (159B)	Comparator1 Protection Selection	V/f OLV OLV/PM AOLV/PM EZOLV Sets drive operation when it detects <i>CP1 [Comparator1 Limit Fault]</i> . 0 : Ramp to Stop 1 : Coast to Stop 2 : Fast Stop (Use C1-09) 3 : Alarm Only 4 : Digital Output Only	4 (0 - 4)
H2-34 (159C)	Comparator 2 Filter Time	V/f OLV OLV/PM AOLV/PM EZOLV Sets the time constant that is applied to the primary delay filter used for the analog output of the monitor selected with <i>H2-26 [Comparator 2 Monitor Selection]</i> .	0.0s (0.0 - 10.0 s)
H2-35 (159D)	Comparator2 Protection Selection	V/f OLV OLV/PM AOLV/PM EZOLV Sets drive operation when it detects <i>CP2 [Comparator2 Limit Fault]</i> . 0 : Ramp to Stop 1 : Coast to Stop 2 : Fast Stop (Use C1-09) 3 : Alarm Only 4 : Digital Output Only	4 (0 - 4)

1.10 H: Terminal Functions

No. (Hex.)	Name	Description	Default (Range)
H2-36 (159E)	Comparator 1 Ineffective Time	V/f OLV OLV/IPM AOLV/IPM EZOLV Sets the length of time that <i>CP1 [Comparator1 Limit Fault]</i> is disabled.	0.0 s (0.0 - 1000.0 s)
H2-37 (159F)	Comparator 2 Ineffective Time	V/f OLV OLV/IPM AOLV/IPM EZOLV Sets the length of time that <i>CP2 [Comparator2 Limit Fault]</i> is disabled.	0.0 s (0.0 - 1000.0 s)
H2-40 (0B58)	Mbus Reg 15E0h bit0 Output Func	V/f OLV OLV/IPM AOLV/IPM EZOLV Sets the MFDO for bit 0 of MEMOBUS register 15E0 (Hex.).	F (0 - 1FF)
H2-41 (0B59)	Mbus Reg 15E0h bit1 Output Func	V/f OLV OLV/IPM AOLV/IPM EZOLV Sets the MFDO for bit 1 of MEMOBUS register 15E0 (Hex.).	F (0 - 1FF)
H2-42 (0B5A)	Mbus Reg 15E0h bit2 Output Func	V/f OLV OLV/IPM AOLV/IPM EZOLV Sets the MFDO for bit 2 of MEMOBUS register 15E0 (Hex.).	F (0 - 1FF)
H2-60 (1B46) Expert	Term MA,MB,MC Secondary Function	V/f OLV OLV/IPM AOLV/IPM EZOLV Sets the second function for terminal MA/MB-MC. Outputs the logical calculation results of the terminals set to functions by <i>H2-01 [Term MA,MB,MC Function Selection]</i> .	F (0 - FF)
H2-61 (1B47) Expert	Term MA,MB,MC Logical Operation	V/f OLV OLV/IPM AOLV/IPM EZOLV Sets the logical operation for the functions set in <i>H2-01 [Term MA,MB,MC Function Selection]</i> and <i>H2-60 [Term MA,MB,MC Secondary Function]</i> .	0 (0 - 8)
H2-62 (1B48) Expert	Term MA,MB,MC Minimum ON Time	V/f OLV OLV/IPM AOLV/IPM EZOLV Sets the minimum ON time that the drive uses to output the logical calculation results from terminal MA/MB-MC.	0.1 s (0.0 - 25.0 s)
H2-63 (1B49) Expert	Terminal P1 Secondary Function	V/f OLV OLV/IPM AOLV/IPM EZOLV Sets the second function for terminal P1-C1. Outputs the logical calculation results of the terminals set to functions by <i>H2-02 [Term P1 Function Selection]</i> .	F (0 - FF)
H2-64 (1B4A) Expert	Terminal P1 Logical Operation	V/f OLV OLV/IPM AOLV/IPM EZOLV Sets the logical operation for the functions set in <i>H2-02 [Term P1 Function Selection]</i> and <i>H2-63 [Terminal P1 Secondary Function]</i> .	0 (0 - 8)
H2-65 (1B4B) Expert	Terminal P1 Minimum ON Time	V/f OLV OLV/IPM AOLV/IPM EZOLV Sets the minimum ON time used to output the logical calculation results from terminal P1-C1.	0.1 s (0.0 - 25.0 s)
H2-66 (1B4C) Expert	Terminal P2 Secondary Function	V/f OLV OLV/IPM AOLV/IPM EZOLV Sets the second function for terminal P2-C2. Outputs the logical calculation results of the terminals assigned to functions by <i>H2-03 [Term P2 Function Selection]</i> .	F (0 - FF)
H2-67 (1B4D) Expert	Terminal P2 Logical Operation	V/f OLV OLV/IPM AOLV/IPM EZOLV Sets the logical operation for the functions set in <i>H2-03 [Term P2 Function Selection]</i> and <i>H2-66 [Terminal P2 Secondary Function]</i> .	0 (0 - 8)
H2-68 (1B4E) Expert	Terminal P2 Minimum ON Time	V/f OLV OLV/IPM AOLV/IPM EZOLV Sets the minimum ON time used to output the logical calculation results from terminal P2-C2.	0.1 s (0.0 - 25.0 s)

■ H2-xx: MFDO Setting Values

Setting Value	Function	Description																		
0	During Run	<p>V/f OLV OLV/PM AOLV/PM EZOLV</p> <p>The terminal activates when you input a Run command and when the drive is outputting voltage. ON : Drive is running OFF : Drive is stopping</p>																		
1	Zero Speed	<p>V/f OLV OLV/PM AOLV/PM EZOLV</p> <p>The terminal activates when the output frequency is less than <i>E1-09</i> [Minimum Output Frequency] or <i>b2-01</i> [DC Injection/Zero Speed Threshold].</p> <p>Note: Parameter <i>A1-02</i> [Control Method Selection] selects which parameter is the reference.</p> <table border="1"> <thead> <tr> <th>A1-02 Setting</th> <th>Control Method Selection</th> <th>Parameter Used as the Reference</th> </tr> </thead> <tbody> <tr> <td>0</td> <td>V/f</td> <td><i>E1-09</i></td> </tr> <tr> <td>2</td> <td>OLV</td> <td><i>b2-01</i></td> </tr> <tr> <td>5</td> <td>OLV/PM</td> <td><i>E1-09</i></td> </tr> <tr> <td>6</td> <td>AOLV/PM</td> <td><i>E1-09</i></td> </tr> <tr> <td>8</td> <td>EZOLV</td> <td><i>E1-09</i></td> </tr> </tbody> </table> <p>ON : Output frequency < value of <i>E1-09</i> or <i>b2-01</i>. OFF : Output frequency ≥ <i>E1-09</i> or <i>b2-01</i>.</p>	A1-02 Setting	Control Method Selection	Parameter Used as the Reference	0	V/f	<i>E1-09</i>	2	OLV	<i>b2-01</i>	5	OLV/PM	<i>E1-09</i>	6	AOLV/PM	<i>E1-09</i>	8	EZOLV	<i>E1-09</i>
A1-02 Setting	Control Method Selection	Parameter Used as the Reference																		
0	V/f	<i>E1-09</i>																		
2	OLV	<i>b2-01</i>																		
5	OLV/PM	<i>E1-09</i>																		
6	AOLV/PM	<i>E1-09</i>																		
8	EZOLV	<i>E1-09</i>																		
2	Speed Agree 1	<p>V/f OLV OLV/PM AOLV/PM EZOLV</p> <p>The terminal activates when the output frequency is in the range of the frequency reference ± <i>L4-02</i> [Speed Agree Detection Width]. ON : The output frequency is in the range of "frequency reference ± <i>L4-02</i>". OFF : The output frequency does not align with the frequency reference although the drive is running.</p>																		
3	User-Set Speed Agree 1	<p>V/f OLV OLV/PM AOLV/PM EZOLV</p> <p>The terminal activates when the output frequency is in the range of <i>L4-01</i> [Speed Agree Detection Level] ± <i>L4-02</i> [Speed Agree Detection Width] and in the range of the frequency reference ± <i>L4-02</i>.</p> <p>Note: The detection function operates in the two motor rotation directions. The drive uses the <i>L4-01</i> value as the forward/reverse detection level.</p> <p>ON : The output frequency is in the range as defined by the result of "<i>L4-01</i> ± <i>L4-02</i>" and the range of frequency reference ± <i>L4-02</i>. OFF : The output frequency is not in the range of "<i>L4-01</i> ± <i>L4-02</i>" nor the range of frequency reference ± <i>L4-02</i>.</p>																		
4	Frequency Detection 1	<p>V/f OLV OLV/PM AOLV/PM EZOLV</p> <p>The terminal deactivates when the output frequency is higher than the value of <i>L4-01</i> [Speed Agree Detection Level] + <i>L4-02</i> [Speed Agree Detection Width]. After the terminal deactivates, the terminal stays deactivated until the output frequency = <i>L4-01</i>.</p> <p>Note: The detection function operates in the two motor rotation directions. The drive uses the <i>L4-01</i> value as the forward/reverse detection level.</p> <p>ON : The output frequency is less than <i>L4-01</i> or is not more than <i>L4-01</i> + <i>L4-02</i>. OFF : The output frequency is more than <i>L4-01</i> + <i>L4-02</i>.</p>																		
5	Frequency Detection 2	<p>V/f OLV OLV/PM AOLV/PM EZOLV</p> <p>The terminal activates when the output frequency is higher than the value of <i>L4-01</i> [Speed Agree Detection Level]. After the terminal activates, the terminal stays activated until the output frequency is at the value of <i>L4-01</i> - <i>L4-02</i>.</p> <p>Note: The detection function operates in the two motor rotation directions. The drive uses the <i>L4-01</i> value as the forward/reverse detection level.</p> <p>ON : The output frequency is more than <i>L4-01</i>. OFF : The output frequency is less than "<i>L4-01</i> - <i>L4-02</i>," or it is not more than <i>L4-01</i>.</p>																		
6	Drive Ready	<p>V/f OLV OLV/PM AOLV/PM EZOLV</p> <p>The terminal activates when the drive is ready and running.</p>																		
7	DC Bus Undervoltage	<p>V/f OLV OLV/PM AOLV/PM EZOLV</p> <p>The terminal activates when the DC bus voltage or control circuit power supply is at the voltage set in <i>L2-05</i> [Undervoltage Detection Lvl (Uv1)] or less. The terminal also activates when there is a fault with the DC bus voltage.</p> <p>ON : The DC bus voltage ≤ <i>L2-05</i> OFF : The DC bus voltage > <i>L2-05</i></p>																		
8	During Baseblock (N.O.)	<p>V/f OLV OLV/PM AOLV/PM EZOLV</p> <p>The terminal activates during baseblock. When the drive is in baseblock, the drive output transistor stops switching and does not make DC bus voltage.</p> <p>ON : During baseblock OFF : The drive is not in baseblock.</p>																		

1.10 H: Terminal Functions

Setting Value	Function	Description
9	Frequency Reference from Keypad	<p><input type="checkbox"/> V/f <input type="checkbox"/> OLV <input type="checkbox"/> OLV/IPM <input type="checkbox"/> AOLV/IPM <input type="checkbox"/> EZOLV</p> <p>Shows the selected frequency reference source. ON : The keypad is the frequency reference source. OFF : Parameter <i>b1-01</i> or <i>b1-15</i> [<i>Frequency Reference Selection 1 or 2</i>] is the frequency reference source.</p>
A	Run Command Source	<p><input type="checkbox"/> V/f <input type="checkbox"/> OLV <input type="checkbox"/> OLV/IPM <input type="checkbox"/> AOLV/IPM <input type="checkbox"/> EZOLV</p> <p>Shows the selected Run command source. ON : The keypad is the Run command source. OFF : Parameter <i>b1-02</i> or <i>b1-16</i> [<i>Run Command Selection 1 or 2</i>] is the Run command source.</p>
B	Torque Detection 1 (N.O.)	<p><input type="checkbox"/> V/f <input type="checkbox"/> OLV <input type="checkbox"/> OLV/IPM <input type="checkbox"/> AOLV/IPM <input type="checkbox"/> EZOLV</p> <p>The terminal activates when the drive detects overtorque or undertorque. ON : The output current/torque > <i>L6-02</i> [<i>Torque Detection Level 1</i>], or the output current/torque < <i>L6-02</i> for longer than the time set in <i>L6-03</i> [<i>Torque Detection Time 1</i>].</p>
C	Frequency Reference Loss	<p><input type="checkbox"/> V/f <input type="checkbox"/> OLV <input type="checkbox"/> OLV/IPM <input type="checkbox"/> AOLV/IPM <input type="checkbox"/> EZOLV</p> <p>The terminal activates when the drive detects a loss of frequency reference.</p>
D	Braking Resistor Fault	<p><input type="checkbox"/> V/f <input type="checkbox"/> OLV <input type="checkbox"/> OLV/IPM <input type="checkbox"/> AOLV/IPM <input type="checkbox"/> EZOLV</p> <p>The terminal activates when the mounting-type braking resistor is overheating or when there is a braking transistor fault.</p>
E	Fault	<p><input type="checkbox"/> V/f <input type="checkbox"/> OLV <input type="checkbox"/> OLV/IPM <input type="checkbox"/> AOLV/IPM <input type="checkbox"/> EZOLV</p> <p>The terminal activates when the drive detects a fault. Note: The terminal will not activate for <i>CPF00</i> and <i>CPF01</i> [<i>Control Circuit Error</i>] faults.</p>
F	Not Used	<p><input type="checkbox"/> V/f <input type="checkbox"/> OLV <input type="checkbox"/> OLV/IPM <input type="checkbox"/> AOLV/IPM <input type="checkbox"/> EZOLV</p> <p>Use this setting for unused terminals or to use terminals in through mode. Also use this setting as the PLC contact output via MEMOBUS/Modbus or the communication option. This signal does not function if you do not configure signals from the PLC.</p>
10	Alarm	<p><input type="checkbox"/> V/f <input type="checkbox"/> OLV <input type="checkbox"/> OLV/IPM <input type="checkbox"/> AOLV/IPM <input type="checkbox"/> EZOLV</p> <p>The terminal activates when the drive detects a minor fault.</p>
11	Fault Reset Command Active	<p><input type="checkbox"/> V/f <input type="checkbox"/> OLV <input type="checkbox"/> OLV/IPM <input type="checkbox"/> AOLV/IPM <input type="checkbox"/> EZOLV</p> <p>The terminal activates when the drive receives the Reset command from the control circuit terminal, serial communications, or the communication option.</p>
12	Timer Output	<p><input type="checkbox"/> V/f <input type="checkbox"/> OLV <input type="checkbox"/> OLV/IPM <input type="checkbox"/> AOLV/IPM <input type="checkbox"/> EZOLV</p> <p>Sets the terminal as the timer output. Use this setting with the timer input set in <i>H1-xx = 18</i> [<i>MFDI Function Selection = Timer Function</i>].</p>
13	Speed Agree 2	<p><input type="checkbox"/> V/f <input type="checkbox"/> OLV <input type="checkbox"/> OLV/IPM <input type="checkbox"/> AOLV/IPM <input type="checkbox"/> EZOLV</p> <p>The terminal activates when the output frequency is in the range of the frequency reference $\pm L4-04$ [<i>Speed Agree Detection Width (+/-)</i>]. Note: The detection function operates in the two motor rotation directions. ON : The output frequency is in the range of "frequency reference $\pm L4-04$". OFF : The output frequency is not in the range of "frequency reference $\pm L4-04$".</p>
14	User-Set Speed Agree 2	<p><input type="checkbox"/> V/f <input type="checkbox"/> OLV <input type="checkbox"/> OLV/IPM <input type="checkbox"/> AOLV/IPM <input type="checkbox"/> EZOLV</p> <p>The terminal activates when the output frequency is in the range of <i>L4-03</i> [<i>Speed Agree Detection Level(+/-)</i>] $\pm L4-04$ [<i>Speed Agree Detection Width(+/-)</i>] and in the range of the frequency reference $\pm L4-04$. Note: The detection level set in <i>L4-03</i> is a signed value. The drive will only detect in one direction. ON : The output frequency is in the range as defined by the result of "<i>L4-03</i> $\pm L4-04$" and the range of frequency reference $\pm L4-04$. OFF : The output frequency is not in the range of "<i>L4-03</i> $\pm L4-04$" nor the range of frequency reference $\pm L4-04$.</p>
15	Frequency Detection 3	<p><input type="checkbox"/> V/f <input type="checkbox"/> OLV <input type="checkbox"/> OLV/IPM <input type="checkbox"/> AOLV/IPM <input type="checkbox"/> EZOLV</p> <p>The terminal deactivates when the output frequency is more than "<i>L4-03</i> [<i>Speed Agree Detection Level(+/-)</i>] + <i>L4-04</i> [<i>Speed Agree Detection Width(+/-)</i>]" . After the terminal deactivates, the terminal stays deactivated until the output frequency is at the value of <i>L4-03</i>. Note: The detection level set in <i>L4-03</i> is a signed value. The drive will only detect in one direction. ON : The output frequency is less than <i>L4-03</i> or is not more than <i>L4-03</i> + <i>L4-04</i>. OFF : The output frequency is higher than <i>L4-03</i> + <i>L4-04</i>.</p>
16	Frequency Detection 4	<p><input type="checkbox"/> V/f <input type="checkbox"/> OLV <input type="checkbox"/> OLV/IPM <input type="checkbox"/> AOLV/IPM <input type="checkbox"/> EZOLV</p> <p>The terminal activates when the output frequency is higher than the value of <i>L4-03</i> [<i>Speed Agree Detection Level(+/-)</i>]. After the terminal activates, the terminal stays activated until the output frequency = <i>L4-03</i> - <i>L4-04</i>. Note: The detection level set in <i>L4-03</i> is a signed value. The drive will only detect in one direction. ON : The output frequency is more than <i>L4-03</i>. OFF : The output frequency is less than "<i>L4-03</i> - <i>L4-04</i>," or it is not more than <i>L4-03</i>.</p>
17	Torque Detection 1 (N.C.)	<p><input type="checkbox"/> V/f <input type="checkbox"/> OLV <input type="checkbox"/> OLV/IPM <input type="checkbox"/> AOLV/IPM <input type="checkbox"/> EZOLV</p> <p>The terminal deactivates when the drive detects overtorque or undertorque. OFF : The output current/torque > <i>L6-02</i> [<i>Torque Detection Level 1</i>], or the output current/torque < <i>L6-02</i> for longer than the time set in <i>L6-03</i> [<i>Torque Detection Time 1</i>].</p>

Setting Value	Function	Description
18	Torque Detection 2 (N.O.)	<p>V/f OLV OLV/PM AOLV/PM EZOLV</p> <p>The terminal activates when the drive detects overtorque or undertorque. ON : The output current/torque > L6-05 [Torque Detection Level 2], or the output current/torque < L6-05 for longer than the time set in L6-06 [Torque Detection Time 2].</p>
19	Torque Detection 2 (N.C.)	<p>V/f OLV OLV/PM AOLV/PM EZOLV</p> <p>The terminal deactivates when the drive detects overtorque or undertorque. OFF : The output current/torque > L6-05 [Torque Detection Level 2], or the output current/torque < L6-05 for longer than the time set in L6-06 [Torque Detection Time 2].</p>
1A	During Reverse	<p>V/f OLV OLV/PM AOLV/PM EZOLV</p> <p>The terminal activates when the motor operates in the reverse direction. ON : The motor is operating in the reverse direction. OFF : The motor is operating in the forward direction or the motor stopped.</p>
1B	During Baseblock (N.C.)	<p>V/f OLV OLV/PM AOLV/PM EZOLV</p> <p>The terminal deactivates during baseblock. When the drive is in baseblock, the drive output transistor stops switching and does not make DC bus voltage. ON : The drive is not in baseblock. OFF : During baseblock</p>
1C	Motor 2 Selected	<p>V/f OLV OLV/PM AOLV/PM EZOLV</p> <p>The terminal activates when you select motor 2. ON : Motor 2 Selected OFF : Motor 1 Selected</p>
1E	Executing Auto-Restart	<p>V/f OLV OLV/PM AOLV/PM EZOLV</p> <p>The terminal activates when the Auto Restart function is trying to restart after a fault.</p>
1F	Motor Overload Alarm (oL1)	<p>V/f OLV OLV/PM AOLV/PM EZOLV</p> <p>The terminal activates when the electronic thermal protection value of the motor overload protective function is a minimum of 90% of the detection level.</p>
20	Drive Overheat Pre-Alarm (oH)	<p>V/f OLV OLV/PM AOLV/PM EZOLV</p> <p>The terminal activates when the drive heatsink temperature is at the level set with L8-02 [Overheat Alarm Level].</p>
21	Safe Torque OFF	<p>V/f OLV OLV/PM AOLV/PM EZOLV</p> <p>The terminal activates (safety stop state) when the safety circuit and safety diagnosis circuit are operating correctly and when terminals H1-HC and H2-HC are OFF (Open). ON : Safety stop state OFF : Safety circuit fault or RUN/READY</p>
22	Mechanical Weakening Detection	<p>V/f OLV OLV/PM AOLV/PM EZOLV</p> <p>The terminal activates when the drive detects mechanical weakening.</p>
2F	Maintenance Notification	<p>V/f OLV OLV/PM AOLV/PM EZOLV</p> <p>The terminal activates when drive components are at their estimated maintenance period. Tells you about the maintenance period for these items:</p> <ul style="list-style-type: none"> • IGBT • Cooling Fan • Capacitor • Soft charge bypass relay
30	During Torque Limit	<p>V/f OLV OLV/PM AOLV/PM EZOLV</p> <p>The terminal activates when the torque reference is the torque limit set with L7 parameters or H3-02 or H3-10 [MFAI Function Selection].</p>
37	During Frequency Output	<p>V/f OLV OLV/PM AOLV/PM EZOLV</p> <p>The terminal activates when the drive outputs frequency. ON : The drive is outputting frequency. OFF : The drive is not outputting frequency.</p>
38	Drive Enabled	<p>V/f OLV OLV/PM AOLV/PM EZOLV</p> <p>This terminal activates when the H1-xx = 6A [Drive Enable] terminal activates.</p>
39	Watt Hour Pulse Output	<p>V/f OLV OLV/PM AOLV/PM EZOLV</p> <p>Outputs the pulse that shows the watt hours.</p>
3C	LOCAL Control Selected	<p>V/f OLV OLV/PM AOLV/PM EZOLV</p> <p>The terminal activates when the Run command source or frequency reference source is LOCAL. ON : LOCAL OFF : REMOTE</p>
3D	During Speed Search	<p>V/f OLV OLV/PM AOLV/PM EZOLV</p> <p>The terminal activates when the drive is doing speed search.</p>
3E	PID Feedback Low	<p>V/f OLV OLV/PM AOLV/PM EZOLV</p> <p>The terminal activates when the drive detects FbL [PID Feedback Loss].</p>

1.10 H: Terminal Functions

Setting Value	Function	Description
3F	PID Feedback High	V/f OLV OLV/PM AOLV/PM EZOLV The terminal activates when the drive detects <i>FbH</i> [Excessive PID Feedback].
4 A	During KEB Ride-Thru	V/f OLV OLV/PM AOLV/PM EZOLV The activates during KEB Ride-Thru.
4B	During Short Circuit Braking	V/f OLV OLV/PM AOLV/PM EZOLV The terminal activates during Short Circuit Braking. Note: When <i>A1-02</i> = 8 [Control Method Selection = EZOLV], this function is available only when you use a PM motor.
4C	During Fast Stop	V/f OLV OLV/PM AOLV/PM EZOLV The terminal activates when the fast stop is in operation.
4D	oH Pre-Alarm Time Limit	V/f OLV OLV/PM AOLV/PM EZOLV The terminal activates when <i>L8-03</i> = 4 [Overheat Pre-Alarm Selection = Operate at Reduced Speed (L8-19)] and <i>oH</i> [Heatsink Overheat] does not clear after the drive decreases the frequency for 10 cycles.
4E	Braking Transistor Fault (rr)	V/f OLV OLV/PM AOLV/PM EZOLV The terminal activates when the internal braking transistor overheats and the drive detects an <i>rr</i> [Dynamic Braking Transistor Fault] fault.
4F	Braking Resistor Overheat (rH)	V/f OLV OLV/PM AOLV/PM EZOLV The terminal activates when the braking resistor overheats and the drive detects an <i>rH</i> [Braking Resistor Overheat] fault.
61	Pole Position Detection Complete	V/f OLV OLV/PM AOLV/PM EZOLV The terminal activates when drive receives a Run command and the drive detects the motor magnetic pole position of the PM motor.
62	Modbus Reg 1 Status Satisfied	V/f OLV OLV/PM AOLV/PM EZOLV The terminal activates when the bit specified by <i>H2-08</i> [Modbus Register 1 Bit Select] for the MEMOBUS register address set with <i>H2-07</i> [Modbus Register 1 Address Select] activates.
63	Modbus Reg 2 Status Satisfied	V/f OLV OLV/PM AOLV/PM EZOLV The terminal activates when the bit specified by <i>H2-10</i> [Modbus Register 2 Bit Select] for the MEMOBUS register address set with <i>H2-09</i> [Modbus Register 2 Address Select] activates.
66	Comparator1	V/f OLV OLV/PM AOLV/PM EZOLV The terminal activates if the monitor value set with <i>H2-20</i> [Comparator 1 Monitor Selection] is in range of the values of <i>H2-21</i> [Comparator 1 Lower Limit] and <i>H2-22</i> [Comparator 1 Upper Limit] for the time set in <i>H2-24</i> [Comparator 1 On-Delay Time].
67	Comparator2	V/f OLV OLV/PM AOLV/PM EZOLV The terminal activates if the monitor value set with <i>H2-26</i> [Comparator 2 Monitor Selection] is not in the range of the values of <i>H2-27</i> [Comparator 2 Lower Limit] and <i>H2-28</i> [Comparator 2 Upper Limit] for the time set in <i>H2-30</i> [Comparator 2 On-Delay Time].
69	External Power 24V Supply	V/f OLV OLV/PM AOLV/PM EZOLV The terminal activates when there is an external 24V power supply between terminals PS-AC. ON : The external 24V power supply is supplying power. OFF : The external 24V power supply is not supplying power.
6 A	Data Logger Error	V/f OLV OLV/PM AOLV/PM EZOLV The terminal activates when the drive detects a <i>LoG</i> [Com Error / Abnormal SD card].
90	DWEZ Digital Output 1	V/f OLV OLV/PM AOLV/PM EZOLV Sets the DriveWorksEZ digital output 1. Refer to the DriveWorksEZ online manual for more information.
91	DWEZ Digital Output 2	V/f OLV OLV/PM AOLV/PM EZOLV Sets the DriveWorksEZ digital output 2. Refer to the DriveWorksEZ online manual for more information.
92	DWEZ Digital Output 3	V/f OLV OLV/PM AOLV/PM EZOLV Sets the DriveWorksEZ digital output 3. Refer to the DriveWorksEZ online manual for more information.
100	!During Run	V/f OLV OLV/PM AOLV/PM EZOLV The terminal deactivates when you input a Run command and when the drive is outputting voltage. ON : Drive is stopping OFF : Drive is running

Setting Value	Function	Description																		
101	!Zero Speed	<p>V/f OLV OLV/PM AOLV/PM EZOLV</p> <p>The terminal deactivates when the output frequency is less than $E1-09$ [Minimum Output Frequency] or $b2-01$ [DC Injection/Zero SpeedThreshold].</p> <p>Note: Parameter $A1-02$ [Control Method Selection] selects which parameter is the reference.</p> <table border="1"> <thead> <tr> <th>A1-02 Setting</th> <th>Control Method Selection</th> <th>Parameter Used as the Reference</th> </tr> </thead> <tbody> <tr> <td>0</td> <td>V/f</td> <td>$E1-09$</td> </tr> <tr> <td>2</td> <td>OLV</td> <td>$b2-01$</td> </tr> <tr> <td>5</td> <td>OLV/PM</td> <td>$E1-09$</td> </tr> <tr> <td>6</td> <td>AOLV/PM</td> <td>$E1-09$</td> </tr> <tr> <td>8</td> <td>EZOLV</td> <td>$E1-09$</td> </tr> </tbody> </table> <p>ON : Output frequency $\geq E1-09$ or $b2-01$. OFF : Output frequency $<$ value of $E1-09$ or $b2-01$.</p>	A1-02 Setting	Control Method Selection	Parameter Used as the Reference	0	V/f	$E1-09$	2	OLV	$b2-01$	5	OLV/PM	$E1-09$	6	AOLV/PM	$E1-09$	8	EZOLV	$E1-09$
A1-02 Setting	Control Method Selection	Parameter Used as the Reference																		
0	V/f	$E1-09$																		
2	OLV	$b2-01$																		
5	OLV/PM	$E1-09$																		
6	AOLV/PM	$E1-09$																		
8	EZOLV	$E1-09$																		
102	!Speed Agree 1	<p>V/f OLV OLV/PM AOLV/PM EZOLV</p> <p>The terminal deactivates when the output frequency is in the range of the frequency reference $\pm L4-02$ [Speed Agree Detection Width].</p> <p>ON : The output frequency does not align with the frequency reference although the drive is running. OFF : The output frequency is in the range of "frequency reference $\pm L4-02$".</p>																		
103	!User-Set Speed Agree 1	<p>V/f OLV OLV/PM AOLV/PM EZOLV</p> <p>The terminal deactivates when the output frequency is in the range of $L4-01$ [Speed Agree Detection Level] $\pm L4-02$ [Speed Agree Detection Width] and in the range of the frequency reference $\pm L4-02$.</p> <p>Note: The detection function operates in the two motor rotation directions. The drive uses the $L4-01$ value as the forward/reverse detection level.</p> <p>ON : The output frequency is not in the range of "$L4-01 \pm L4-02$" nor the range of frequency reference $\pm L4-02$. OFF : The output frequency is in the range as defined by the result of "$L4-01 \pm L4-02$" and the range of frequency reference $\pm L4-02$.</p>																		
104	!Frequency Detection 1	<p>V/f OLV OLV/PM AOLV/PM EZOLV</p> <p>The terminal activates when the output frequency is higher than the value of $L4-01$ [Speed Agree Detection Level] + $L4-02$ [Speed Agree Detection Width]. When the terminal activates, it stays activated until the output frequency = $L4-01$.</p> <p>Note: The detection function operates in the two motor rotation directions. The drive uses the $L4-01$ value as the forward/reverse detection level.</p> <p>ON : The output frequency is higher than $L4-01 + L4-02$. OFF : The output frequency is less than $L4-01$ or is not more than $L4-01 + L4-02$.</p>																		
105	!Frequency Detection 2	<p>V/f OLV OLV/PM AOLV/PM EZOLV</p> <p>The terminal deactivates when the output frequency is higher than the value of $L4-01$ [Speed Agree Detection Level]. After the terminal activates, the terminal stays on until the output frequency = $L4-01 - L4-02$.</p> <p>Note: The detection function operates in the two motor rotation directions. The drive uses the $L4-01$ value as the forward/reverse detection level.</p> <p>ON : The output frequency is less than "$L4-01 - L4-02$," or it is not more than $L4-01$. OFF : The output frequency is more than $L4-01$.</p>																		
106	!Drive Ready	<p>V/f OLV OLV/PM AOLV/PM EZOLV</p> <p>The terminal deactivates when the drive is ready and running.</p>																		
107	!DC Bus Undervoltage	<p>V/f OLV OLV/PM AOLV/PM EZOLV</p> <p>The terminal deactivates when the DC bus voltage or control circuit power supply is at or below the voltage set in $L2-05$ [Undervoltage Detection Lvl (Uv1)]. The terminal also deactivates when there is a fault with the DC bus voltage.</p> <p>ON : The DC bus voltage is more than the setting value of $L2-05$. OFF : The DC bus voltage is less than the setting value of $L2-05$.</p>																		
108	During Baseblock (N.C.)	<p>V/f OLV OLV/PM AOLV/PM EZOLV</p> <p>The terminal deactivates during baseblock. When the drive is in baseblock, the drive output transistor stops switching and does not make DC bus voltage.</p> <p>ON : The drive is not in baseblock. OFF : During baseblock</p>																		
109	!Frequency Reference from Keypad	<p>V/f OLV OLV/PM AOLV/PM EZOLV</p> <p>Shows the selected frequency reference source.</p> <p>ON : $b1-01$ [Frequency Reference Selection 1] or $b1-15$ [Frequency Reference Selection 2] is the frequency reference source. OFF : The keypad is the frequency reference source.</p>																		
10A	!Run Command from Keypad	<p>V/f OLV OLV/PM AOLV/PM EZOLV</p> <p>Shows the selected Run command source.</p> <p>ON : $b1-02$ [Run Command Selection 1] or $b1-16$ [Run Command Selection 2] is the Run command source. OFF : The keypad is the Run command source.</p>																		

1.10 H: Terminal Functions

Setting Value	Function	Description
10B	Torque Detection 1 (N.C.)	<p>V/f OLV OLV/IPM AOLV/IPM EZOLV</p> <p>The terminal deactivates when the drive detects overtorque or undertorque. OFF : The output current/torque exceeds the torque value set with L6-02 [Torque Detection Level 1], or the level has dropped and remained in this state longer than the time set with L6-03 [Torque Detection Time 1].</p>
10C	!Frequency Reference Loss	<p>V/f OLV OLV/IPM AOLV/IPM EZOLV</p> <p>The terminal deactivates when the drive detects a loss of frequency reference.</p>
10D	!Braking Resistor Fault	<p>V/f OLV OLV/IPM AOLV/IPM EZOLV</p> <p>The terminal deactivates when the mounting-type braking resistor is overheating or when there is a braking transistor fault.</p>
10E	!Fault	<p>V/f OLV OLV/IPM AOLV/IPM EZOLV</p> <p>The terminal deactivates when the drive detects a fault. Note: Faults CPF00 and CPF01 [Control Circuit Error] are excluded.</p>
110	!Alarm	<p>V/f OLV OLV/IPM AOLV/IPM EZOLV</p> <p>The terminal deactivates when the drive detects a minor fault.</p>
111	!Fault Reset Command Active	<p>V/f OLV OLV/IPM AOLV/IPM EZOLV</p> <p>The terminal deactivates when the drive receives the Reset command from the control circuit terminal, serial communications, or the communication option.</p>
112	!Timer Output	<p>V/f OLV OLV/IPM AOLV/IPM EZOLV</p> <p>Sets the terminal as the timer output. Use this setting with the timer input set in H1-xx = 118 [MFDI Function Selection = !Timer Function].</p>
113	!Speed Agree 2	<p>V/f OLV OLV/IPM AOLV/IPM EZOLV</p> <p>The terminal deactivates when the output frequency is in the range of the frequency reference $\pm L4-04$ [Speed Agree Detection Width(+/-)]. Note: The detection function operates in the two motor rotation directions. ON : The output frequency is not in the range of "frequency reference $\pm L4-04$". OFF : The output frequency is in the range of "frequency reference $\pm L4-04$".</p>
114	!User-Set Speed Agree 2	<p>V/f OLV OLV/IPM AOLV/IPM EZOLV</p> <p>The terminal deactivates when the output frequency is in the range of $L4-03$ [Speed Agree Detection Level(+/-)] $\pm L4-04$ [Speed Agree Detection Width(+/-)] and in the range of the frequency reference $\pm L4-04$. Note: The detection level set in L4-03 is a signed value. The drive will only detect in one direction. ON : The output frequency is not in the range of "$L4-03 \pm L4-04$" nor the range of frequency reference $\pm L4-04$. OFF : The output frequency is in the range of "$L4-03 \pm L4-04$" and the range of frequency reference $\pm L4-04$.</p>
115	!Frequency Detection 3	<p>V/f OLV OLV/IPM AOLV/IPM EZOLV</p> <p>The terminal activates when the output frequency is higher than "$L4-03$ [Speed Agree Detection Level(+/-)] + $L4-04$ [Speed Agree Detection Width(+/-)]". After the terminal deactivates, the terminal stays deactivated until the output frequency = $L4-03$. Note: The detection level set in L4-03 is a signed value. The drive will only detect in one direction. ON : The output frequency is higher than $L4-03 + L4-04$. OFF : The output frequency is less than $L4-03$ or is not more than $L4-03 + L4-04$.</p>
116	!Frequency Detection 4	<p>V/f OLV OLV/IPM AOLV/IPM EZOLV</p> <p>The terminal deactivates when the output frequency is higher than the value of $L4-03$ [Speed Agree Detection Level(+/-)]. After the terminal deactivates, the terminal stays deactivated until the output frequency = $L4-03 - L4-04$. Note: The detection level set in L4-03 is a signed value. The drive will only detect in one direction. ON : The output frequency is less than "$L4-03 - L4-04$," or it is not more than $L4-03$. OFF : The output frequency is more than $L4-03$.</p>
117	Torque Detection 1 (N.O.)	<p>V/f OLV OLV/IPM AOLV/IPM EZOLV</p> <p>The terminal activates when the drive detects overtorque or undertorque. ON : The output current/torque exceeds the torque value set with L6-02 [Torque Detection Level 1], or the level has dropped and remained in this state longer than the time set with L6-03 [Torque Detection Time 1].</p>
118	Torque Detection 2 (N.C.)	<p>V/f OLV OLV/IPM AOLV/IPM EZOLV</p> <p>The terminal deactivates when the drive detects overtorque or undertorque. OFF : The output current/torque exceeds the torque value set with L6-05 [Torque Detection Level 2], or the level has dropped and remained in this state longer than the time set with L6-06 [Torque Detection Time 2].</p>
119	Torque Detection 2 (N.O.)	<p>V/f OLV OLV/IPM AOLV/IPM EZOLV</p> <p>The terminal activates when the drive detects overtorque or undertorque. ON : The output current/torque exceeds the torque value set with L6-05 [Torque Detection Level 2], or the level has dropped and remained in this state longer than the time set with L6-06 [Torque Detection Time 2].</p>
11A	!During Reverse	<p>V/f OLV OLV/IPM AOLV/IPM EZOLV</p> <p>The terminal deactivates when the motor operates in the reverse direction. ON : The motor is operating in the forward direction or the motor stopped. OFF : The motor is operating in the reverse direction.</p>

Setting Value	Function	Description
11B	During Baseblock (N.O.)	<p>V/f OLV OLV/PM AOLV/PM EZOLV</p> <p>The terminal activates during baseblock. When the drive is in baseblock, the drive output transistor stops switching and does not make DC bus voltage. ON : During baseblock OFF : The drive is not in baseblock.</p>
11C	!Motor 2 Selected	<p>V/f OLV OLV/PM AOLV/PM EZOLV</p> <p>The terminal deactivates when motor 2 is selected. ON : Motor 1 Selection OFF : Motor 2 Selection</p>
11E	!Executing Auto-Restart	<p>V/f OLV OLV/PM AOLV/PM EZOLV</p> <p>The terminal deactivates when the Auto Restart function is trying to restart after a fault.</p>
11F	!Motor Overload Alarm (oL1)	<p>V/f OLV OLV/PM AOLV/PM EZOLV</p> <p>The terminal deactivates when the electronic thermal protection value of the motor overload protective function is a minimum of 90% of the detection level.</p>
120	!Drive Overheat Pre-Alarm (oH)	<p>V/f OLV OLV/PM AOLV/PM EZOLV</p> <p>The terminal deactivates when the drive heatsink temperature is at the level set with <i>L8-02 [Overheat Alarm Level]</i>.</p>
121	!Safe Torque OFF	<p>V/f OLV OLV/PM AOLV/PM EZOLV</p> <p>The terminal deactivates (safety stop state) when the safety circuit and safety diagnosis circuit are operating correctly and when terminals H1-HC and H2-HC are OFF (Open). ON : Safety circuit fault or RUN/READY OFF : Safety stop state</p>
122	!Mechanical Weakening Detection	<p>V/f OLV OLV/PM AOLV/PM EZOLV</p> <p>The terminal deactivates when the drive detects mechanical weakening.</p>
12F	!Maintenance Notification	<p>V/f OLV OLV/PM AOLV/PM EZOLV</p> <p>The terminal deactivates when drive components are at their estimated maintenance period. Tells you about the maintenance period for these items:</p> <ul style="list-style-type: none"> • IGBT • Cooling Fan • Capacitor • Soft charge bypass relay
130	!During Torque Limit	<p>V/f OLV OLV/PM AOLV/PM EZOLV</p> <p>The terminal deactivates when the torque reference is the torque limit set with <i>L7 parameters</i> or <i>H3-02</i> or <i>H3-10 [MFAI Function Selection]</i>.</p>
137	!During Frequency Output	<p>V/f OLV OLV/PM AOLV/PM EZOLV</p> <p>The terminal deactivates when the drive outputs frequency. ON : The drive is not outputting frequency. OFF : The drive is outputting frequency.</p>
138	!Drive Enabled	<p>V/f OLV OLV/PM AOLV/PM EZOLV</p> <p>This terminal deactivates when the <i>H1-xx = 16A [Drive Enable]</i> terminal deactivates.</p>
139	!Watt Hour Pulse Output	<p>V/f OLV OLV/PM AOLV/PM EZOLV</p> <p>Outputs the pulse that shows the watt hours.</p>
13C	!LOCAL Control Selected	<p>V/f OLV OLV/PM AOLV/PM EZOLV</p> <p>The terminal deactivates when the Run command source or frequency reference source is LOCAL. ON : REMOTE OFF : LOCAL</p>
13D	!During Speed Search	<p>V/f OLV OLV/PM AOLV/PM EZOLV</p> <p>The terminal deactivates when the drive does speed search.</p>
13E	!PID Feedback Low	<p>V/f OLV OLV/PM AOLV/PM EZOLV</p> <p>The terminal deactivates when the drive detects <i>FbL [PID Feedback Loss]</i>.</p>
13F	!PID Feedback High	<p>V/f OLV OLV/PM AOLV/PM EZOLV</p> <p>The terminal deactivates when the drive detects <i>FbH [Excessive PID Feedback]</i>.</p>
14A	!During KEB Ride-Thru	<p>V/f OLV OLV/PM AOLV/PM EZOLV</p> <p>The terminal deactivates when the drive executes the KEB Ride-Thru function.</p>
14B	!During Short Circuit Braking	<p>V/f OLV OLV/PM AOLV/PM EZOLV</p> <p>The terminal deactivates during Short Circuit Braking. Note: When <i>A1-02 = 8 [Control Method Selection = EZ Vector Control]</i>, this function is available when you use a PM motor.</p>
14C	!During Fast Stop	<p>V/f OLV OLV/PM AOLV/PM EZOLV</p> <p>The terminal deactivates when the fast stop is in operation.</p>

1.10 H: Terminal Functions

Setting Value	Function	Description
14D	!oH Pre-Alarm Reduction Limit	V/f OLV OLV/PM AOLV/PM EZOLV The terminal deactivates when $L8-03 = 4$ [Overheat Pre-Alarm Selection = Operate at Reduced Speed (L8-19)] and oH [Heatsink Overheat] does not clear after the drive decreases the frequency for 10 cycles.
14E	!Braking Transistor Fault (rr)	V/f OLV OLV/PM AOLV/PM EZOLV The terminal deactivates when the internal braking transistor overheats and the drive detects an rr [Dynamic Braking Transistor Fault] fault.
14F	!Braking Resistor Overheat (rH)	V/f OLV OLV/PM AOLV/PM EZOLV The terminal deactivates when the braking resistor overheats and the drive detects an rH [Braking Resistor Overheat] fault.
161	!RotorPositionDetection Complete	V/f OLV OLV/PM AOLV/PM EZOLV The terminal deactivates when drive receives a Run command and the drive detects the motor magnetic pole position of the PM motor.
162	!Modbus Reg 1 Status Satisfied	V/f OLV OLV/PM AOLV/PM EZOLV The terminal deactivates when the bit specified by H2-07 turns on regarding the MEMOBUS register address configured with H2-08.
163	!Modbus Reg 2 Status Satisfied	V/f OLV OLV/PM AOLV/PM EZOLV The terminal deactivates when the bit specified by H2-10 turns on regarding the MEMOBUS register address configured with H2-09.
166	!Comparator 1	V/f OLV OLV/PM AOLV/PM EZOLV The terminal deactivates when the monitor value set with H2-20 is within range of H2-21 and H2-22 for the time set in H2-24.
167	!Comparator 2	V/f OLV OLV/PM AOLV/PM EZOLV The terminal deactivates when the when the monitor value set with H2-26 is outside the range of H2-27 and H2-28 for the time set in H2-30.
169	!External Power 24V Supply	V/f OLV OLV/PM AOLV/PM EZOLV The terminal deactivates when there is an external 24V power supply between terminals PS-AC. ON : The external 24V power supply is not supplying power. OFF : The external 24V power supply is supplying power.
16A	!Data Logger Error	V/f OLV OLV/PM AOLV/PM EZOLV The terminal deactivates when the drive detects a LoG [Com Error / Abnormal SD card].
190	!DWEZ Digital Output 1	V/f OLV OLV/PM AOLV/PM EZOLV Sets the DriveWorksEZ digital output 1. Refer to the DriveWorksEZ online manual for more information.
191	!DWEZ Digital Output 2	V/f OLV OLV/PM AOLV/PM EZOLV Sets the DriveWorksEZ digital output 2. Refer to the DriveWorksEZ online manual for more information.
192	!DWEZ Digital Output 3	V/f OLV OLV/PM AOLV/PM EZOLV Sets the DriveWorksEZ digital output 3. Refer to the DriveWorksEZ online manual for more information.

◆ H3: Analog Inputs

No. (Hex.)	Name	Description	Default (Range)
H3-01 (0410)	Terminal A1 Signal Level Select	V/f OLV OLV/PM AOLV/PM EZOLV Sets the input signal level for MFAI terminal A1. 0 : 0 to 10V (Lower Limit at 0) 4 : -10 to +10V (Bipolar Reference)	0 (0, 4)
H3-02 (0434)	Terminal A1 Function Selection	V/f OLV OLV/PM AOLV/PM EZOLV Sets the function for MFAI terminal A1.	0 (0 - 32)
H3-03 (0411) RUN	Terminal A1 Gain Setting	V/f OLV OLV/PM AOLV/PM EZOLV Sets the gain of the analog signal input to MFAI terminal A1.	100.0% (-999.9 - +999.9%)
H3-04 (0412) RUN	Terminal A1 Bias Setting	V/f OLV OLV/PM AOLV/PM EZOLV Sets the bias of the analog signal input to MFAI terminal A1.	0.0% (-999.9 - +999.9%)
H3-09 (0417)	Terminal A2 Signal Level Select	V/f OLV OLV/PM AOLV/PM EZOLV Sets the input signal level for MFAI terminal A2. 0 : 0-10V (LowLim=0) 2 : 4 to 20 mA 3 : 0 to 20 mA 4 : -10 to +10V (Bipolar Reference)	2 (0, 2 - 4)
H3-10 (0418)	Terminal A2 Function Selection	V/f OLV OLV/PM AOLV/PM EZOLV Sets the function for MFAI terminal A2.	0 (0 - 32)

No. (Hex.)	Name	Description	Default (Range)
H3-11 (0419) RUN	Terminal A2 Gain Setting	V/f OLV OLV/PM AOLV/PM EZOLV Sets the gain of the analog signal input to MFAI terminal A2.	100.0% (-999.9 - +999.9%)
H3-12 (041A) RUN	Terminal A2 Bias Setting	V/f OLV OLV/PM AOLV/PM EZOLV Sets the bias of the analog signal input to MFAI terminal A2.	0.0% (-999.9 - +999.9%)
H3-13 (041B)	Analog Input FilterTime Constant	V/f OLV OLV/PM AOLV/PM EZOLV Sets the time constant for primary delay filters on MFAI terminals.	0.03 s (0.00 - 2.00 s)
H3-14 (041C)	Analog Input Terminal Enable Sel	V/f OLV OLV/PM AOLV/PM EZOLV Sets the enabled terminal or terminals when $H1-xx = C$ [MFDI Function Select = Analog Terminal Enable Selection] is ON. 1 : Terminal A1 only 2 : Terminal A2 only 7 : Terminals A1 and A2	7 (1, 2, 7)
H3-16 (02F0)	Terminal A1 Offset	V/f OLV OLV/PM AOLV/PM EZOLV Sets the offset level for analog signals input to terminal A1. Usually it is not necessary to change this setting.	0 (-500 - +500)
H3-17 (02F1)	Terminal A2 Offset	V/f OLV OLV/PM AOLV/PM EZOLV Sets the offset level for analog signals input to terminal A2. Usually it is not necessary to change this setting.	0 (-500 - +500)
H3-40 (0B5C)	Mbus Reg 15C1h Input Function	V/f OLV OLV/PM AOLV/PM EZOLV Sets the MEMOBUS A11 function.	F (4 - 2F)
H3-41 (0B5F)	Mbus Reg 15C2h Input Function	V/f OLV OLV/PM AOLV/PM EZOLV Sets the MEMOBUS A12 function.	F (4 - 2F)
H3-42 (0B62)	Mbus Reg 15C3h Input Function	V/f OLV OLV/PM AOLV/PM EZOLV Sets the MEMOBUS A13 function.	F (4 - 2F)
H3-43 (117F)	Mbus Reg Inputs FilterTime Const	V/f OLV OLV/PM AOLV/PM EZOLV Sets the time constant to apply a primary delay filter to the MEMOBUS analog input register values.	0.00 s (0.00 - 2.00 s)

■ H3-xx: MFAI Setting Values

Setting Value	Function	Description
0	Frequency Reference	V/f OLV OLV/PM AOLV/PM EZOLV The input value from the MFAI terminal set with this function becomes the master frequency reference.
1	Frequency Gain	V/f OLV OLV/PM AOLV/PM EZOLV The drive multiplies the analog frequency reference with the input value from the MFAI set with this function.
2	Auxiliary Frequency Reference 1	V/f OLV OLV/PM AOLV/PM EZOLV Sets Reference 2 through multi-step speed reference to enable the command reference (Auxiliary Frequency Reference 1) from the analog input terminal set here. This value is a percentage where the Maximum Output Frequency setting is a setting value of 100%. Note: Parameter $A1-02$ [Control Method Selection] selects which parameter is the maximum output frequency. • $A1-02 \neq 8$ [EZOLV]: $E1-04$ [Maximum Output Frequency] • $A1-02 = 8$: $E9-02$ [Maximum Speed]
3	Auxiliary Frequency Reference 2	V/f OLV OLV/PM AOLV/PM EZOLV Sets Reference 3 through multi-step speed reference to enable the command reference (Auxiliary Frequency Reference 2) from the analog input terminal set here. This value is a percentage where the Maximum Output Frequency setting is a setting value of 100%. Note: Parameter $A1-02$ [Control Method Selection] selects which parameter is the maximum output frequency. • $A1-02 \neq 8$ [EZOLV]: $E1-04$ [Maximum Output Frequency] • $A1-02 = 8$: $E9-02$ [Maximum Speed]
4	Output Voltage Bias	V/f OLV OLV/PM AOLV/PM EZOLV Set this parameter to input a bias signal to amplify the output voltage.
5	Accel/Decel Time Gain	V/f OLV OLV/PM AOLV/PM EZOLV Enters a signal to adjust the gain used for $C1-01$ to $C1-08$ [Acceleration/Deceleration Times 1 to 4] and $C1-09$ [Fast Stop Time] when the full scale analog signal (10 V or 20 mA) is 100%.
6	DC Injection Braking Current	V/f OLV OLV/PM AOLV/PM EZOLV Enters a signal to adjust the current level used for DC Injection Braking when the drive rated output current is 100%.

1.10 H: Terminal Functions

Setting Value	Function	Description
7	Torque Detection Level	<p>V/f OLV OLV/PM AOLV/PM EZOLV</p> <p>Enters a signal to adjust the overtorque/undertorque detection level.</p> <p>Note: Use this function with L6-01 [Torque Detection Selection 1]. This parameter functions as an alternative to L6-02 [Torque Detection Level 1].</p>
8	Stall Prevent Level during Run	<p>V/f OLV OLV/PM AOLV/PM EZOLV</p> <p>Enters a signal to adjust the stall prevention level during run if the drive rated current is 100%.</p>
9	Output Frequency Lower Limit	<p>V/f OLV OLV/PM AOLV/PM EZOLV</p> <p>Enters a signal to adjust the output frequency lower limit level as a percentage of the maximum output frequency.</p> <p>Note: Parameter A1-02 [Control Method Selection] selects which parameter is the maximum output frequency. <ul style="list-style-type: none"> • A1-02 ≠ 8 [EZOLV]: E1-04 [Maximum Output Frequency] • A1-02 = 8: E9-02 [Maximum Speed] </p>
B	PID Feedback	<p>V/f OLV OLV/PM AOLV/PM EZOLV</p> <p>Enter the PID feedback value as a percentage of the maximum output frequency.</p> <p>Note: Parameter A1-02 [Control Method Selection] selects which parameter is the maximum output frequency. <ul style="list-style-type: none"> • A1-02 ≠ 8 [EZOLV]: E1-04 [Maximum Output Frequency] • A1-02 = 8: E9-02 [Maximum Speed] </p>
C	PID Setpoint	<p>V/f OLV OLV/PM AOLV/PM EZOLV</p> <p>Enters the PID setpoint as a percentage of the maximum output frequency.</p> <p>Note: Parameter A1-02 [Control Method Selection] selects which parameter is the maximum output frequency. <ul style="list-style-type: none"> • A1-02 ≠ 8 [EZOLV]: E1-04 [Maximum Output Frequency] • A1-02 = 8: E9-02 [Maximum Speed] </p>
D	Frequency Bias	<p>V/f OLV OLV/PM AOLV/PM EZOLV</p> <p>Enters the bias value added to the frequency reference as a percentage of the maximum output frequency.</p> <p>Note: Parameter A1-02 [Control Method Selection] selects which parameter is the maximum output frequency. <ul style="list-style-type: none"> • A1-02 ≠ 8 [EZOLV]: E1-04 [Maximum Output Frequency] • A1-02 = 8: E9-02 [Maximum Speed] </p>
E	Motor Temperature (PTC Input)	<p>V/f OLV OLV/PM AOLV/PM EZOLV</p> <p>Uses the motor Positive Temperature Coefficient (PTC) thermistor to prevent heat damage to the motor as a percentage of the current value when the 10 V analog signal is input.</p>
F	Not Used	<p>V/f OLV OLV/PM AOLV/PM EZOLV</p> <p>Use this setting for unused terminals or to use terminals in through mode.</p>
10	Forward Torque Limit	<p>V/f OLV OLV/PM AOLV/PM EZOLV</p> <p>Enters the forward torque limit if the motor rated torque is 100%.</p>
11	Reverse Torque Limit	<p>V/f OLV OLV/PM AOLV/PM EZOLV</p> <p>Enters the load torque limit if the motor rated torque is 100%.</p>
12	Regenerative Torque Limit	<p>V/f OLV OLV/PM AOLV/PM EZOLV</p> <p>Enters the regenerative torque limit if the motor rated torque is 100%.</p>
13	Torque Reference / Torque Limit	<p>V/f OLV OLV/PM AOLV/PM EZOLV</p> <p>Enters the torque reference if the motor rated torque is 100%. This setting is the torque limit for speed control.</p>
14	Torque Compensation	<p>V/f OLV OLV/PM AOLV/PM EZOLV</p> <p>Enters the torque compensation value if the motor rated torque is 100%.</p>
15	General Torque Limit	<p>V/f OLV OLV/PM AOLV/PM EZOLV</p> <p>Enters the torque limit that is the same for all quadrants for forward, reverse, and regenerative operation if the motor rated torque is 100%.</p>
16	Differential PID Feedback	<p>V/f OLV OLV/PM AOLV/PM EZOLV</p> <p>Enters the PID differential feedback value if the full scale analog signal (10 V or 20 mA) is 100%.</p>
1F	Not Used	<p>V/f OLV OLV/PM AOLV/PM EZOLV</p> <p>Use this setting for unused terminals or to use terminals in through mode.</p>
30	DWEZ Analog Input 1	<p>V/f OLV OLV/PM AOLV/PM EZOLV</p> <p>Use with DriveWorksEZ. Refer to the DriveWorksEZ online manual for more information.</p>
31	DWEZ Analog Input 2	<p>V/f OLV OLV/PM AOLV/PM EZOLV</p> <p>Use with DriveWorksEZ. Refer to the DriveWorksEZ online manual for more information.</p>

◆ H4: Analog Outputs

No. (Hex.)	Name	Description	Default (Range)
H4-01 (041D)	Terminal AM Analog Output Select	<p>V/f OLV OLV/PM AOLV/PM EZOLV</p> <p>Sets the monitoring number to be output from the MFAO terminal AM. Set the x-xx part of the Ux-xx [Monitor]. For example, set H4-01 = 102 to monitor U1-02 [Output Frequency].</p>	102 (000 - 999)
H4-02 (041E) RUN	Terminal AM Analog Output Gain	<p>V/f OLV OLV/PM AOLV/PM EZOLV</p> <p>Sets the gain of the monitor signal that is sent from MFAO terminal AM. Sets the analog signal output level from the terminal AM at 10 V or 20 mA as 100% when an output for monitoring items is 100%.</p>	100.0% (-999.9 - +999.9%)
H4-03 (041F) RUN	Terminal AM Analog Output Bias	<p>V/f OLV OLV/PM AOLV/PM EZOLV</p> <p>Sets the bias of the monitor signal that is sent from MFAO terminal AM. When an output for monitoring items is 0%, this parameter sets the analog signal output level from the AM terminal at 10 V or 20 mA as 0%.</p>	0.0% (-999.9 - +999.9%)
H4-07 (0423)	Terminal AM Signal Level Select	<p>V/f OLV OLV/PM AOLV/PM EZOLV</p> <p>Sets the MFAO terminal AM output signal level.</p> <p>Note: Make sure that you set jumper S5 on the control circuit terminal board when you change these parameters. 0 : 0-10V 2 : 4 to 20 mA</p>	0 (0, 2)
H4-20 (0B53)	Analog Power Monitor 100% Level	<p>V/f OLV OLV/PM AOLV/PM EZOLV</p> <p>Sets the level at 10 V when U1-08 [Output Power] is set for analog output.</p>	0.00 kW (0.00 - 650.00 kW)

◆ H5: Modbus Communication

No. (Hex.)	Name	Description	Default (Range)
H5-01 (0425)	Drive Node Address	<p>V/f OLV OLV/PM AOLV/PM EZOLV</p> <p>Sets the communication slave address for drives.</p> <p>Note: • Re-energize the drive or set H5-20 = 1 [Communication Parameters Reload = Reload Now] after you change the parameter setting. • Setting 0 will not let the drive respond to MEMOBUS/Modbus communications.</p>	1FH (0 - FFH)
H5-02 (0426)	Communication Speed Selection	<p>V/f OLV OLV/PM AOLV/PM EZOLV</p> <p>Sets the communications speed for MEMOBUS/Modbus communications.</p> <p>Note: Re-energize the drive or set H5-20 = 1 [Communication Parameters Reload = Reload Now] after you change the parameter setting. 0 : 1200 bps 1 : 2400 bps 2 : 4800 bps 3 : 9600 bps 4 : 19.2 kbps 5 : 38.4 kbps 6 : 57.6 kbps 7 : 76.8 kbps 8 : 115.2 kbps</p>	3 (0 - 8)
H5-03 (0427)	Communication Parity Selection	<p>V/f OLV OLV/PM AOLV/PM EZOLV</p> <p>Sets the communications parity used for MEMOBUS/Modbus communications.</p> <p>Note: Re-energize the drive or set H5-20 = 1 [Communication Parameters Reload = Reload Now] after you change the parameter setting. 0 : No parity 1 : Even parity 2 : Odd parity</p>	0 (0 - 2)
H5-04 (0428)	Communication Error Stop Method	<p>V/f OLV OLV/PM AOLV/PM EZOLV</p> <p>Sets the motor Stopping Method when the drive detects CE [MEMOBUS/Modbus Communication Err] issues. 0 : Ramp to Stop 1 : Coast to Stop 2 : Fast Stop (Use C1-09) 3 : Alarm Only</p>	3 (0 - 3)

1.10 H: Terminal Functions

No. (Hex.)	Name	Description	Default (Range)
H5-05 (0429)	Comm Fault Detection Selection	<input type="checkbox"/> V/f <input type="checkbox"/> OLV <input type="checkbox"/> OLV/IPM <input type="checkbox"/> AOLV/IPM <input type="checkbox"/> EZOLV Sets the function that detects <i>CE [Modbus Communication Error]</i> issues during MEMOBUS/Modbus communications. 0 : Disabled 1 : Enabled	1 (0, 1)
H5-06 (042A)	Drive Transmit Wait Time	<input type="checkbox"/> V/f <input type="checkbox"/> OLV <input type="checkbox"/> OLV/IPM <input type="checkbox"/> AOLV/IPM <input type="checkbox"/> EZOLV Sets the time to wait to send a response message after the drive receives a command message from the master. Note: Restart the drive after changing the parameter setting.	5 ms (0 - 65 ms)
H5-09 (0435)	CE Detection Time	<input type="checkbox"/> V/f <input type="checkbox"/> OLV <input type="checkbox"/> OLV/IPM <input type="checkbox"/> AOLV/IPM <input type="checkbox"/> EZOLV Sets the detection time for <i>CE [Modbus Communication Error]</i> issues when communication stops.	2.0 s (0.0 - 25.0 s)
H5-10 (0436)	Modbus Register 0025H Unit Sel	<input type="checkbox"/> V/f <input type="checkbox"/> OLV <input type="checkbox"/> OLV/IPM <input type="checkbox"/> AOLV/IPM <input type="checkbox"/> EZOLV Sets the unit of measure used for the MEMOBUS/Modbus communications monitor register 0025H (output voltage reference monitor). 0 : 0.1 V units 1 : 1 V units	0 (0, 1)
H5-11 (043C) RUN	Comm ENTER Command Mode	<input type="checkbox"/> V/f <input type="checkbox"/> OLV <input type="checkbox"/> OLV/IPM <input type="checkbox"/> AOLV/IPM <input type="checkbox"/> EZOLV Sets the function to make the Enter command necessary to change parameters through MEMOBUS/Modbus communications. 0 : ENTER Command Required 1 : ENTER Command Not Required	1 (0, 1)
H5-12 (043D)	Run Command Method Selection	<input type="checkbox"/> V/f <input type="checkbox"/> OLV <input type="checkbox"/> OLV/IPM <input type="checkbox"/> AOLV/IPM <input type="checkbox"/> EZOLV Sets the input method for the Run command when <i>b1-02 = 2 [Run Command Selection 1 = Memobus/Modbus Communications]</i> or <i>b1-16 = 2 [Run Command Selection 2 = Memobus/Modbus Communications]</i> . 0 : FWD/Stop, REV/Stop 1 : Run/Stop, FWD/REV	0 (0, 1)
H5-17 (11A1) Expert	ENTER command response @CPU BUSY	<input type="checkbox"/> V/f <input type="checkbox"/> OLV <input type="checkbox"/> OLV/IPM <input type="checkbox"/> AOLV/IPM <input type="checkbox"/> EZOLV Sets operation when the EEPROM write command is sent without EEPROM write available. Usually it is not necessary to change this setting. 0 : Ignore Command(No ROM/RAM Write) 1 : Write to RAM Only	0 (0, 1)
H5-18 (11A2)	Motor Speed Filter over Comms	<input type="checkbox"/> V/f <input type="checkbox"/> OLV <input type="checkbox"/> OLV/IPM <input type="checkbox"/> AOLV/IPM <input type="checkbox"/> EZOLV Sets the filter time constant used when monitoring motor speed during MEMOBUS/Modbus communications or with a communication option.	0 ms (0 - 100 ms)
H5-20 (0B57)	Communication Parameters Reload	<input type="checkbox"/> V/f <input type="checkbox"/> OLV <input type="checkbox"/> OLV/IPM <input type="checkbox"/> AOLV/IPM <input type="checkbox"/> EZOLV Sets the function to immediately enable updated MEMOBUS/Modbus communications parameters. 0 : Reload at Next Power Cycle 1 : Reload Now	0 (0, 1)
H5-22 (11CF)	Speed Search from MODBUS	<input type="checkbox"/> V/f <input type="checkbox"/> OLV <input type="checkbox"/> OLV/IPM <input type="checkbox"/> AOLV/IPM <input type="checkbox"/> EZOLV Enables the MEMOBUS/Modbus communication register Speed Search function (bit0 of 15DFH). 0 : Disabled 1 : Enabled	0 (0, 1)
H5-25 (1589) RUN	Function 5A Register 1 Selection	<input type="checkbox"/> V/f <input type="checkbox"/> OLV <input type="checkbox"/> OLV/IPM <input type="checkbox"/> AOLV/IPM <input type="checkbox"/> EZOLV Returns the contents of the specified MEMOBUS/Modbus communications register when responding to the master device.	0044H (U1-05) (0000H - FFFFH)
H5-26 (158A) RUN	Function 5A Register 2 Selection	<input type="checkbox"/> V/f <input type="checkbox"/> OLV <input type="checkbox"/> OLV/IPM <input type="checkbox"/> AOLV/IPM <input type="checkbox"/> EZOLV Returns the contents of the specified MEMOBUS/Modbus communications register when responding to the master device.	0045H (U1-06) (0000H - FFFFH)
H5-27 (158B) RUN	Function 5A Register 3 Selection	<input type="checkbox"/> V/f <input type="checkbox"/> OLV <input type="checkbox"/> OLV/IPM <input type="checkbox"/> AOLV/IPM <input type="checkbox"/> EZOLV Returns the contents of the specified MEMOBUS/Modbus communications register when responding to the master device.	0042H (U1-03) (0000H - FFFFH)
H5-28 (158C) RUN	Function 5A Register 4 Selection	<input type="checkbox"/> V/f <input type="checkbox"/> OLV <input type="checkbox"/> OLV/IPM <input type="checkbox"/> AOLV/IPM <input type="checkbox"/> EZOLV Returns the contents of the specified MEMOBUS/Modbus communications register when responding to the master device.	0049H (U1-10) (0000H - FFFFH)

◆ H6: Pulse Train Input/Output

No. (Hex.)	Name	Description	Default (Range)
H6-01 (042C) RUN	Terminal RP Pulse Train Function	<p>V/f OLV OLV/PM AOLV/PM EZOLV</p> <p>Sets the function for pulse train input terminal RP.</p> <p>0 : Frequency Reference 1 : PID Feedback Value 2 : PID Setpoint Value 3 : Speed Feedback (V/F Control)</p>	0 (0 - 3)
H6-02 (042D) RUN	Terminal RP Frequency Scaling	<p>V/f OLV OLV/PM AOLV/PM EZOLV</p> <p>Sets the frequency of the pulse train input signal used when the item selected with H6-01 [Terminal RP Pulse Train Function] is input at 100%.</p>	1440 Hz (100 - 32000 Hz)
H6-03 (042E) RUN	Terminal RP Function Gain	<p>V/f OLV OLV/PM AOLV/PM EZOLV</p> <p>Sets the gain used when the function in H6-01 [Terminal RP Pulse Train Function] is input to terminal RP.</p>	100.0% (0.0 - 1000.0%)
H6-04 (042F) RUN	Terminal RP Function Bias	<p>V/f OLV OLV/PM AOLV/PM EZOLV</p> <p>Sets the bias used when the function in H6-01 [Terminal RP Pulse Train Function] is input to terminal RP. Sets a value at the time when the pulse train is 0 Hz.</p>	0.0% (-100.0 - 100.0%)
H6-05 (0430) RUN	Terminal RP Filter Time	<p>V/f OLV OLV/PM AOLV/PM EZOLV</p> <p>Sets the time constant for the pulse train input primary delay filters.</p>	0.10 s (0.00 - 2.00 s)
H6-06 (0431) RUN	Terminal MP Monitor Selection	<p>V/f OLV OLV/PM AOLV/PM EZOLV</p> <p>Sets a function for pulse train monitor output terminal MP. Sets the "x-xx" part of the Ux-xx monitor.</p>	102 (000, 031, 101, 102, 105, 116, 501, 502, 801 - 809, 821 - 825, 831 - 839, 851 - 855)
H6-07 (0432) RUN	Terminal MP Frequency Scaling	<p>V/f OLV OLV/PM AOLV/PM EZOLV</p> <p>Sets the frequency of the pulse train output signal used when the monitor set with H6-06 [Terminal MP Monitor Selection] is 100%.</p>	1440 Hz (0 - 32000 Hz)
H6-08 (043F)	Terminal RP Minimum Frequency	<p>V/f OLV OLV/PM AOLV/PM EZOLV</p> <p>Sets the minimum frequency of the pulse train signal that terminal RP can detect.</p>	0.5 Hz (0.1 - 1000.0 Hz)

◆ H7: Virtual MFIO Selection

No. (Hex.)	Name	Description	Default (Range)
H7-00 (116F) Expert	Virtual MFIO selection	<p>V/f OLV OLV/PM AOLV/PM EZOLV</p> <p>Sets the function to enable and disable the virtual I/O function. Set this parameter to 1 to operate the virtual I/O function.</p> <p>0 : Disabled 1 : Enabled</p>	0 (0, 1)
H7-01 (1185) Expert	Virtual Multi-Function Input 1	<p>V/f OLV OLV/PM AOLV/PM EZOLV</p> <p>Sets the function that enters the virtual input set in H7-10 [Virtual Multi-Function Output 1].</p> <p>Note: 1B [Programming Lockout] and 11B [Inverse Input of 1B] are not available.</p>	F (1 - 19F)
H7-02 (1186) Expert	Virtual Multi-Function Input 2	<p>V/f OLV OLV/PM AOLV/PM EZOLV</p> <p>Sets the function that enters the virtual input set in H7-12 [Virtual Multi-Function Output 2].</p> <p>Note: 1B [Programming Lockout] and 11B [Inverse Input of 1B] are not available.</p>	F (1 - 19F)
H7-03 (1187) Expert	Virtual Multi-Function Input 3	<p>V/f OLV OLV/PM AOLV/PM EZOLV</p> <p>Sets the function that enters the virtual input set in H7-14 [Virtual Multi-Function Output 3].</p> <p>Note: 1B [Programming Lockout] and 11B [Inverse Input of 1B] are not available.</p>	F (1 - 19F)
H7-04 (1188) Expert	Virtual Multi-Function Input 4	<p>V/f OLV OLV/PM AOLV/PM EZOLV</p> <p>Sets the function that enters the virtual input set in H7-16 [Virtual Multi-Function Output 4].</p> <p>Note: 1B [Programming Lockout] and 11B [Inverse Input of 1B] are not available.</p>	F (1 - 19F)
H7-10 (11A4) Expert	Virtual Multi-Function Output 1	<p>V/f OLV OLV/PM AOLV/PM EZOLV</p> <p>Sets the function for virtual digital output 1.</p>	F (0 - 1A7)

1.10 H: Terminal Functions

No. (Hex.)	Name	Description	Default (Range)
H7-11 (11A5) Expert	Virtual Output 1 Delay Time	V/f OLV OLV/IPM AOLV/IPM EZOLV Sets the minimum ON time for virtual digital output 1.	0.1 s (0.0 - 25.0 s)
H7-12 (11A6) Expert	Virtual Multi-Function Output 2	V/f OLV OLV/IPM AOLV/IPM EZOLV Sets the function for virtual digital output 2.	F (0 - 1A7)
H7-13 (11A7) Expert	Virtual Output 2 Delay Time	V/f OLV OLV/IPM AOLV/IPM EZOLV Sets the minimum ON time for virtual digital output 2.	0.1 s (0.0 - 25.0 s)
H7-14 (11A8) Expert	Virtual Multi-Function Output 3	V/f OLV OLV/IPM AOLV/IPM EZOLV Sets the function for virtual digital output 3.	F (0 - 1A7)
H7-15 (11A9) Expert	Virtual Output 3 Delay Time	V/f OLV OLV/IPM AOLV/IPM EZOLV Sets the minimum ON time for virtual digital output 3.	0.1 s (0.0 - 25.0 s)
H7-16 (11AA) Expert	Virtual Multi-Function Output 4	V/f OLV OLV/IPM AOLV/IPM EZOLV Sets the function for virtual digital output 4.	F (0 - 1A7)
H7-17 (11AB) Expert	Virtual Output 4 Delay Time	V/f OLV OLV/IPM AOLV/IPM EZOLV Sets the minimum ON time for virtual digital output 4.	0.1 s (0.0 - 25.0 s)
H7-30 (1177) Expert	Virtual Analog Input Selection	V/f OLV OLV/IPM AOLV/IPM EZOLV Sets the virtual analog input function.	F (0 - 32)
H7-31 (1178) RUN Expert	Virtual Analog Input Gain	V/f OLV OLV/IPM AOLV/IPM EZOLV Sets the virtual analog input gain.	100.0% (-999.9 - 999.9%)
H7-32 (1179) RUN Expert	Virtual Analog Input Bias	V/f OLV OLV/IPM AOLV/IPM EZOLV Sets the virtual analog input bias.	0.0% (-999.9 - 999.9%)
H7-40 (1163)	Virtual Analog Out Signal Select	V/f OLV OLV/IPM AOLV/IPM EZOLV Sets the signal level of the virtual analog output. 0 : 0 to 100% (Absolute Value) 1 : -100 to 100% 2 : 0 to 100% (Lower Limit at 0)	0 (0 - 2)
H7-41 (1164)	Virtual Analog Output Function	V/f OLV OLV/IPM AOLV/IPM EZOLV Sets the monitor to be output from the virtual analog output. Set the x-xx part of the Ux-xx [Monitor]. For example, set H7-41 = 102 to monitor U1-02 [Output Frequency].	102 (0 - 999)
H7-42 (1165)	Virtual Analog Output FilterTime	V/f OLV OLV/IPM AOLV/IPM EZOLV Sets the time constant for a primary filter of the virtual analog output.	0.00 s (0.00 - 2.00 s)

1.11 L: Protection Functions

◆ L1: Motor Protection

No. (Hex.)	Name	Description	Default (Range)
L1-01 (0480)	Motor Overload (oL1) Protection	<p>V/f OLV OLV/PM AOLV/PM EZOLV</p> <p>Sets the motor overload protection with electronic thermal protectors.</p> <p>0 : No 1 : Variable Torque 2 : Constant Torque 10:1 Speed Range 3 : Constant Torque 100:1 SpeedRange 4 : PM Variable Torque 5 : PM Constant Torque 6 : Variable Torque (50Hz)</p> <p>Note: When only one motor is connected to a drive, set <i>L1-01 = 1 to 6 [Enabled]</i>. External thermal relays are not necessary in these conditions.</p>	Determined by A1-02 (0 - 6)
L1-02 (0481)	Motor Overload Protection Time	<p>V/f OLV OLV/PM AOLV/PM EZOLV</p> <p>Sets the operation time for the electronic thermal protector of the drive to prevent damage to the motor. Usually it is not necessary to change this setting.</p>	1.0 min (0.1 - 5.0 min)
L1-03 (0482)	Motor Thermistor oH Alarm Select	<p>V/f OLV OLV/PM AOLV/PM EZOLV</p> <p>Sets drive operation when the PTC input signal entered into the drive is at the <i>oH3 [Motor Overheat Alarm]</i> detection level.</p> <p>0 : Ramp to Stop 1 : Coast to Stop 2 : Fast Stop 3 : Alarm Only</p>	3 (0 - 3)
L1-04 (0483)	Motor Thermistor oH Fault Select	<p>V/f OLV OLV/PM AOLV/PM EZOLV</p> <p>Sets the drive operation when the PTC input signal to the drive is at the <i>oH4 [Motor Overheat Fault (PTC Input)]</i> detection level.</p> <p>0 : Ramp to Stop 1 : Coast to Stop 2 : Fast Stop</p>	1 (0 - 2)
L1-05 (0484)	Motor Thermistor Filter Time	<p>V/f OLV OLV/PM AOLV/PM EZOLV</p> <p>Sets the primary delay time constant for the PTC input signal entered to the drive. This parameter prevents accidental motor overheat faults.</p>	0.20 s (0.00 - 10.00 s)
L1-08 (1103)	oL1 Current Level	<p>V/f OLV OLV/PM AOLV/PM EZOLV</p> <p>Sets the reference current for the motor 1 thermal overload detection. When the current level > 0.0 A, you cannot set this value < 10% of drive rated current.</p>	0.0 A (0.0 A or 10% to 150% of the drive rated current)
L1-09 (1104)	oL1 Current Level for Motor 2	<p>V/f OLV OLV/PM AOLV/PM EZOLV</p> <p>Sets the reference current for the motor 2 thermal overload detection. When the current level > 0.0 A, you cannot set this value < 10% of drive rated current.</p>	0.0 A (0.0 A or 10 to 150% of the drive rated current)
L1-13 (046D)	Motor Overload Memory Selection	<p>V/f OLV OLV/PM AOLV/PM EZOLV</p> <p>Sets the function that keeps the current electronic thermal protector value when the drive stops receiving power.</p> <p>0 : Disabled 1 : Enabled</p>	1 (0, 1)
L1-22 (0768) RUN	Leakage Current Filter Time1	<p>V/f OLV OLV/PM AOLV/PM EZOLV</p> <p>Sets the leakage current detection reduction filter time constant during constant speed run.</p> <p>Note: You can set this parameter when <i>C6-02 = B [Carrier Frequency Selection = Leakage Current Detection Reduction Rate PWM]</i>.</p>	Determined by C6-02 (0.0 - 60.0 s)
L1-23 (0769) RUN	Leakage Current Filter Time2	<p>V/f OLV OLV/PM AOLV/PM EZOLV</p> <p>Sets the leakage current detection reduction filter time constant during acceleration/deceleration.</p> <p>Note:</p> <ul style="list-style-type: none"> You can set this parameter when <i>C6-02 = B [Carrier Frequency Selection = Leakage Current Detection Reduction Rate PWM]</i>. When the setting value increases, the current monitor also starts up slowly. Examine the relevant sequence for problems. 	Determined by C6-02 (0.0 - 60.0 s)

◆ L2: Power Loss Ride Through

No. (Hex.)	Name	Description	Default (Range)
L2-01 (0485)	Power Loss Ride Through Select	<p>V/f OLV OLV/PM AOLV/PM EZOLV</p> <p>Sets the drive operation after a momentary power loss.</p> <p>0 : Disabled 1 : Enabled for L2-02 Time 2 : Enabled while CPU Power Active 3 : Kinetic Energy Backup: L2-02 4 : Kinetic Energy Backup: CPU Power 5 : Kinetic Energy Backup: DecelStop</p>	0 (0 - 5)
L2-02 (0486)	Power Loss Ride Through Time	<p>V/f OLV OLV/PM AOLV/PM EZOLV</p> <p>Sets the length of time that the drive will wait before it tries to restart if the DC bus voltage is less than L2-05 [Undervoltage Detection Lvl (Uv1)] after a momentary power loss.</p>	Determined by o2-04, C6-01 (0.0 - 25.5 s)
L2-03 (0487)	Minimum Baseblock Time	<p>V/f OLV OLV/PM AOLV/PM EZOLV</p> <p>Sets the minimum time to continue the drive output block (baseblock) after a baseblock.</p>	Determined by o2-04, C6-01 (0.1 - 5.0 s)
L2-04 (0488)	Powerloss V/f Recovery Ramp Time	<p>V/f OLV OLV/PM AOLV/PM EZOLV</p> <p>Sets the time for the drive output voltage to go back to correct voltage after completing speed searches.</p>	Determined by o2-04, C6-01 (0.0 - 5.0 s)
L2-05 (0489)	Undervoltage Detection Lvl (Uv1)	<p>V/f OLV OLV/PM AOLV/PM EZOLV</p> <p>Sets the voltage at which a Uv1 [DC Bus Undervoltage] fault is triggered or at which the KEB function is activated. Usually it is not necessary to change this setting.</p> <p>NOTICE: Damage to Equipment. When you set this parameter to a value lower than the default, you must install an AC reactor on the input side of the power supply. If you do not install an AC reactor, it will cause damage to the drive circuitry.</p>	Determined by o2-04 and E1-01 (200 V Class: 150 - 210 V, 400 V Class: 300 - 420 V)
L2-06 (048A) Expert	Kinetic Energy Backup Decel Time	<p>V/f OLV OLV/PM AOLV/PM EZOLV</p> <p>Sets the deceleration time during KEB operation used to decrease the maximum output frequency to 0.</p> <p>Note: When L2-29 = 1, 2, or 3 [Kinetic Energy Backup Method = Single Drive KEB Ride-Thru 2, System KEB Ride-Thru 1, or System KEB Ride-Thru 2] and you do KEB Auto-Tuning, the drive will automatically set this value.</p>	0.0 s (0.0 - 6000.0 s)
L2-07 (048B) Expert	Kinetic Energy Backup Accel Time	<p>V/f OLV OLV/PM AOLV/PM EZOLV</p> <p>Sets the acceleration time to return the frequency to the frequency reference before a power loss after canceling KEB operation.</p>	0.0 s (0.0 - 6000.0 s)
L2-08 (048C) Expert	Frequency Gain at KEB Start	<p>V/f OLV OLV/PM AOLV/PM EZOLV</p> <p>Sets the quantity of output frequency reduction used when KEB operation starts as a percentage of the motor rated slip before starting KEB operation.</p>	100% (0 - 300%)
L2-09 (048D) Expert	KEB Minimum Frequency Level	<p>V/f OLV OLV/PM AOLV/PM EZOLV</p> <p>Sets the quantity of output frequency reduction used as a percentage of E2-02 [Motor Rated Slip] when KEB operation starts.</p>	20% (0 - 100%)
L2-10 (048E) Expert	Minimum KEB Time	<p>V/f OLV OLV/PM AOLV/PM EZOLV</p> <p>Sets the minimum length of time to operate the KEB after the drive detects a momentary power loss.</p>	50 ms (0 - 25500 ms)
L2-11 (0461) Expert	KEB DC Bus Voltage Setpoint	<p>V/f OLV OLV/PM AOLV/PM EZOLV</p> <p>Sets the target value that controls the DC bus voltage to a constant level in Single Drive KEB Ride-Thru 2. Sets the DC bus voltage level that completes the KEB operation for all other KEB methods.</p>	Determined by E1-01 (Determined by E1-01)
L2-29 (0475) Expert	Kinetic Energy Backup Method	<p>V/f OLV OLV/PM AOLV/PM EZOLV</p> <p>Sets the KEB function operation mode.</p> <p>0 : Single Drive KEB Ride-Thru 1 1 : Single Drive KEB Ride-Thru 2 2 : System KEB Ride-Thru 1 3 : System KEB Ride-Thru 2</p>	0 (0 - 3)

No. (Hex.)	Name	Description	Default (Range)
L2-30 (045E) Expert	KEB Zero Speed Operation	<p>V/f OLV OLV/PM AOLV/PM EZOLV</p> <p>Sets the operation when the output frequency decreases below the zero level (DC braking injection starting frequency) during KEB deceleration when L2-01 = 3 to 5 [Power Loss Ride Through Select = Kinetic Energy Backup: L2-02, Kinetic Energy Backup: CPU Power, or Kinetic Energy Backup: DecelStop].</p> <p>0 : Baseblock 1 : DC/SC Braking</p>	0 (0, 1)
L2-31 (045D) Expert	KEB Start Voltage Offset Level	<p>V/f OLV OLV/PM AOLV/PM EZOLV</p> <p>Sets the KEB start voltage offset.</p>	Determined by A1-02 (200 V Class: 0 - 100 V, 400 V Class: 0 - 200 V)

◆ L3: Stall Prevention

No. (Hex.)	Name	Description	Default (Range)
L3-01 (048F)	Stall Prevention during Accel	<p>V/f OLV OLV/PM AOLV/PM EZOLV</p> <p>Sets the method of the Stall Prevention During Acceleration.</p> <p>0 : Disable 1 : Enabled 2 : Intelligent (Ignore Accel Ramp) 3 : Current Limit Acceleration</p>	1 (0 - 3)
L3-02 (0490)	Stall Prevent Level during Accel	<p>V/f OLV OLV/PM AOLV/PM EZOLV</p> <p>Sets the output current level at which the Stall Prevention function operates during acceleration where the drive rated output current is 100%.</p> <p>Note: The upper limit to the setting range changes when the setting for C6-01 [Normal / Heavy Duty Selection] changes.</p> <ul style="list-style-type: none"> • 150% when C6-01 = 0 [Heavy Duty Rating] • 120% when C6-01 = 1 [Normal Duty Rating] 	Determined by C6-01 (0 - 150%)
L3-03 (0491)	Stall Prevent Limit during Accel	<p>V/f OLV OLV/PM AOLV/PM EZOLV</p> <p>Sets the lower limit for the stall prevention level used in the constant output range as a percentage of the drive rated output current.</p>	50% (0 - 100%)
L3-04 (0492)	Stall Prevention during Decel	<p>V/f OLV OLV/PM AOLV/PM EZOLV</p> <p>Sets the method that the drive will use to prevent overvoltage faults when decelerating.</p> <p>Note:</p> <ol style="list-style-type: none"> To connect a dynamic braking option (braking resistor or braking resistor unit) to the drive, set this parameter to 0 or 3. Parameter settings 1, 2, 4, 5, and 7 will enable Stall Prevention function during deceleration, and the dynamic braking option will not function. The setting range changes when the A1-02 [Control Method Selection] value changes: <ul style="list-style-type: none"> • When A1-02 = 5 [OLV/PM], the setting range is 0 to 2. • When A1-02 = 6 or 8 [AOLV/PM or EZOLV], the setting range is 0 or 1. <p>0 : No 1 : General Purpose 2 : Intelligent (Ignore Decel Ramp) 3 : General Purpose w/ DB resistor 4 : Overexcitation/High Flux 5 : Overexcitation/High Flux 2 7 : Overexcitation/High Flux 3</p>	1 (Determined by A1-02)
L3-05 (0493)	Stall Prevention during RUN	<p>V/f OLV OLV/PM AOLV/PM EZOLV</p> <p>Sets the function to enable and disable Stall Prevention During Run.</p> <p>Note:</p> <ul style="list-style-type: none"> • An output frequency less than 6 Hz disables Stall Prevention during Run. The setting values of L3-05 and L3-06 [Stall Prevent Level during Run] do not have an effect. • The setting range changes when the A1-02 [Control Method Selection] value changes: <ul style="list-style-type: none"> -A1-02 = 0, 5 [V/f, OLV/PM] : 0 to 2 -A1-02 = 8 [EZOLV] : 0, 3 <p>0 : No 1 : Deceleration Time 1 (C1-02) 2 : Deceleration Time 2 (C1-04) 3 : Intelligent (Ignore Decel Ramp)</p>	2 (0 - Determined by A1-02)

1.11 L: Protection Functions

No. (Hex.)	Name	Description	Default (Range)
L3-06 (0494)	Stall Prevent Level during Run	<p>V/f OLV OLV/IPM AOLV/IPM EZOLV</p> <p>Sets the output current level at which the Stall Prevention function is enabled during run when the drive rated output current is 100%.</p> <p>Note:</p> <ul style="list-style-type: none"> This parameter is applicable when L3-05 = 1, 2 [Stall Prevention during RUN = Deceleration Time 1 (C1-02), Deceleration Time 2 (C1-04)]. The upper limit to the setting range changes when the setting for C6-01 [Normal / Heavy Duty Selection] changes. <ul style="list-style-type: none"> -150% when C6-01 = 0 [Heavy Duty Rating] -120% when C6-01 = 1 [Normal Duty Rating] 	Determined by C6-01 (5 - 150%)
L3-11 (04C7)	Overvoltage Suppression Select	<p>V/f OLV OLV/IPM AOLV/IPM EZOLV</p> <p>Sets the overvoltage suppression function.</p> <p>0 : Disabled 1 : Enabled</p>	0 (0, 1)
L3-17 (0462)	DC Bus Regulation Level	<p>V/f OLV OLV/IPM AOLV/IPM EZOLV</p> <p>Sets the target value for the DC bus voltage when the overvoltage suppression function and the Decel Stall Prevention function (Intelligent Stall Prevention) are active.</p>	200 V Class: 375 V, 400 V Class: 750 V (200 V Class: 150 to 400 V, 400 V Class: 300 to 800 V)
L3-20 (0465) Expert	DC Bus Voltage Adjustment Gain	<p>V/f OLV OLV/IPM AOLV/IPM EZOLV</p> <p>Sets the proportional gain used to control the DC bus voltage.</p>	Determined by A1-02 (0.00 - 5.00)
L3-21 (0466) Expert	OVSuppression Accel/Decel P Gain	<p>V/f OLV OLV/IPM AOLV/IPM EZOLV</p> <p>Sets the proportional gain to calculate acceleration and deceleration rates.</p>	Determined by A1-02 (0.10 - 10.00)
L3-22 (04F9)	PM Stall Prevention Decel Time	<p>V/f OLV OLV/IPM AOLV/IPM EZOLV</p> <p>Sets the momentary deceleration time that the drive will use when it tries to accelerate a PM motor and detected motor stalls. This function is applicable when L3-01 = 1 [Stall Prevention during Accel = Enabled].</p>	0.0 s (0.0 - 6000.0 s)
L3-23 (04FD)	Stall P Reduction at Constant HP	<p>V/f OLV OLV/IPM AOLV/IPM EZOLV</p> <p>Sets the function to automatically decrease the Stall Prevention Level during Run for constant output ranges.</p> <p>0 : Use L3-06 for Entire Speed Range 1 : Automatic Reduction @ CHP Region</p>	0 (0, 1)
L3-24 (046E) Expert	Motor Accel Time @ Rated Torque	<p>V/f OLV OLV/IPM AOLV/IPM EZOLV</p> <p>Sets the motor acceleration time to reach the maximum frequency at the motor rated torque for stopped single-drive motors.</p>	Determined by o2-04, C6-01, E2-11, and E5-01 (0.001 - 10.000 s)
L3-25 (046F) Expert	Load Inertia Ratio	<p>V/f OLV OLV/IPM AOLV/IPM EZOLV</p> <p>Sets the ratio between motor inertia and machine inertia.</p>	1.0 (0.1 - 1000.0)
L3-26 (0455) Expert	Additional DC Bus Capacitors	<p>V/f OLV OLV/IPM AOLV/IPM EZOLV</p> <p>Sets the capacity for external main circuit capacitors. Usually it is not necessary to change this setting. Sets this parameter when you use the KEB Ride-Thru function.</p>	0 μF (0 to 65000 μF)
L3-27 (0456)	Stall Prevention Detection Time	<p>V/f OLV OLV/IPM AOLV/IPM EZOLV</p> <p>Sets a delay time between reaching the Stall Prevention level and starting the Stall Prevention function.</p>	60 ms (0 - 5000 ms)
L3-34 (016F) Expert	Torque Limit Delay Time	<p>V/f OLV OLV/IPM AOLV/IPM EZOLV</p> <p>Sets the filter time constant that returns the torque limit to its initial value when KEB operation operates in Single Drive KEB Ride-Thru mode.</p>	Determined by A1-02 (0.000 - 1.000 s)
L3-35 (0747) Expert	Speed Agree Width for Auto Decel	<p>V/f OLV OLV/IPM AOLV/IPM EZOLV</p> <p>Sets the width for speed agreement when L3-04 = 2 [Stall Prevention during Decel = Intelligent (Ignore Decel Ramp)]. Usually it is not necessary to change this setting.</p>	0.00 Hz (0.00 - 1.00 Hz)
L3-36 (11D0)	Current Suppression Gain@Accel	<p>V/f OLV OLV/IPM AOLV/IPM EZOLV</p> <p>Sets the gain to suppress current and motor speed hunting during operation when L3-01 = 3 [Stall Prevention during Accel = Current Limit Method]. Usually it is not necessary to change this setting.</p>	Determined by A1-02 (0.0 - 100.0)
L3-37 (11D1) Expert	Current Limit P Gain @Accel	<p>V/f OLV OLV/IPM AOLV/IPM EZOLV</p> <p>Suppresses current hunting during acceleration. Usually it is not necessary to change this setting.</p>	5 ms (0 - 100 ms)
L3-38 (11D2) Expert	Current Limit I Time @ Accel	<p>V/f OLV OLV/IPM AOLV/IPM EZOLV</p> <p>Suppresses current hunting and overshooting that occurs when the drive stalls during acceleration. Usually it is not necessary to change this setting.</p>	10.0 (0.0 - 100.0)

No. (Hex.)	Name	Description	Default (Range)
L3-39 (11D3)	Current Limit Filter Time@Accel	<input type="checkbox"/> V/f <input type="checkbox"/> OLV <input type="checkbox"/> OLV/PM <input type="checkbox"/> AOLV/PM <input type="checkbox"/> EZOLV Sets the time constant to adjust the acceleration rate when L3-01 = 3 [Stall Prevention during Accel = Current Limit Acceleration]. Usually it is not necessary to change this setting.	100.0 ms (1.0 - 1000.0 ms)
L3-40 (11D4)	Current Limit S-Curve @ Acc/Dec	<input type="checkbox"/> V/f <input type="checkbox"/> OLV <input type="checkbox"/> OLV/PM <input type="checkbox"/> AOLV/PM <input type="checkbox"/> EZOLV Sets the function to enable and disable the best S-curve characteristic used for current-limited acceleration. 0 : Disabled 1 : Enabled	0 (0, 1)

◆ L4: Speed Detection

No. (Hex.)	Name	Description	Default (Range)
L4-01 (0499)	Speed Agree Detection Level	<input type="checkbox"/> V/f <input type="checkbox"/> OLV <input type="checkbox"/> OLV/PM <input type="checkbox"/> AOLV/PM <input type="checkbox"/> EZOLV Sets the level to detect speed agree or motor speed. Sets the level to detect speed agree or motor speed when H2-01 to H2-03 = 2, 3, 4, 5 [MFDO Function Selection = Speed Agree 1, User-set Speed Agree 1, Frequency Detection 1, Frequency Detection 2].	Determined by A1-02 (Determined by A1-02)
L4-02 (049A)	Speed Agree Detection Width	<input type="checkbox"/> V/f <input type="checkbox"/> OLV <input type="checkbox"/> OLV/PM <input type="checkbox"/> AOLV/PM <input type="checkbox"/> EZOLV Sets the width to detect speed agree or motor speed. Sets the width to detect speed agree or motor speed when H2-01 to H2-03 = 2, 3, 4, 5 [MFDO Function Selection = Speed Agree 1, User-set Speed Agree 1, Frequency Detection 1, Frequency Detection 2].	Determined by A1-02 (Determined by A1-02)
L4-03 (049B)	Speed Agree Detection Level(+/-)	<input type="checkbox"/> V/f <input type="checkbox"/> OLV <input type="checkbox"/> OLV/PM <input type="checkbox"/> AOLV/PM <input type="checkbox"/> EZOLV Sets the level to detect speed agree or motor speed. Sets the level to detect speed agree or motor speed when H2-01 to H2-03 = 13, 14, 15, 16 [MFDO Function Selection = Speed Agree 2, User-set Speed Agree 2, Frequency Detection 3, Frequency Detection 4].	Determined by A1-02 (Determined by A1-02)
L4-04 (049C)	Speed Agree Detection Width(+/-)	<input type="checkbox"/> V/f <input type="checkbox"/> OLV <input type="checkbox"/> OLV/PM <input type="checkbox"/> AOLV/PM <input type="checkbox"/> EZOLV Sets the width to detect speed agree or motor speed. Sets the width to detect speed agree or motor speed when H2-01 to H2-03 = 13, 14, 15, 16 [MFDO Function Selection = Speed Agree 2, User-set Speed Agree 2, Frequency Detection 3, Frequency Detection 4].	Determined by A1-02 (Determined by A1-02)
L4-05 (049D)	Fref Loss Detection Selection	<input type="checkbox"/> V/f <input type="checkbox"/> OLV <input type="checkbox"/> OLV/PM <input type="checkbox"/> AOLV/PM <input type="checkbox"/> EZOLV Sets the operation when the drive detects a loss of frequency reference. 0 : Stop 1 : Run at (L4-06 x Last Reference)	0 (0, 1)
L4-06 (04C2)	Frequency Reference @Loss of Ref	<input type="checkbox"/> V/f <input type="checkbox"/> OLV <input type="checkbox"/> OLV/PM <input type="checkbox"/> AOLV/PM <input type="checkbox"/> EZOLV Sets the frequency reference as a percentage to continue drive operation after it detects a frequency reference loss. The value is a percentage of the frequency reference before the drive detected the loss.	80.0% (0.0 - 100.0%)
L4-07 (0470)	Speed Agree Detection Selection	<input type="checkbox"/> V/f <input type="checkbox"/> OLV <input type="checkbox"/> OLV/PM <input type="checkbox"/> AOLV/PM <input type="checkbox"/> EZOLV Sets the condition that activates speed detection. 0 : No Detection during Baseblock 1 : Detection Always Enabled	0 (0, 1)
L4-08 (047F)	Speed Agree Source Selection	<input type="checkbox"/> V/f <input type="checkbox"/> OLV <input type="checkbox"/> OLV/PM <input type="checkbox"/> AOLV/PM <input type="checkbox"/> EZOLV Sets the drive to use the soft starter output frequency or the motor speed (estimation value) for speed detection. 0 : Softstarter Output (Reference) 1 : Motor Speed (Actual Speed)	0 (0, 1)

◆ L5: Fault Restart

No. (Hex.)	Name	Description	Default (Range)
L5-01 (049E)	Number of Auto-Restart Attempts	<input type="checkbox"/> V/f <input type="checkbox"/> OLV <input type="checkbox"/> OLV/PM <input type="checkbox"/> AOLV/PM <input type="checkbox"/> EZOLV Sets the number of times that the drive will try to restart.	0 (0 - 10 times)
L5-02 (049F)	Fault Contact at Restart Select	<input type="checkbox"/> V/f <input type="checkbox"/> OLV <input type="checkbox"/> OLV/PM <input type="checkbox"/> AOLV/PM <input type="checkbox"/> EZOLV Sets the function that sends signals to the MFDO terminal set for Fault [H2-xx = E] while the drive is automatically restarting. 0 : Active Only when Not Restarting 1 : Always Active	0 (0, 1)

1.11 L: Protection Functions

No. (Hex.)	Name	Description	Default (Range)
L5-04 (046C)	Interval Method Restart Time	<p>V/f OLV OLV/PM AOLV/PM EZOLV</p> <p>Sets the time interval between each Auto Restart attempt. This function is enabled when <i>L5-05 = 1</i> [<i>Auto Restart Operation Selection = Use L5-04 Time</i>].</p>	10.0 s (0.5 - 600.0 s)
L5-05 (0467)	Auto-Restart Method	<p>V/f OLV OLV/PM AOLV/PM EZOLV</p> <p>Sets the count method for the Auto Restart operation. 0 : Continuous/Immediate Attempts 1 : Interval/Attempt after L5-04 sec</p>	0 (0, 1)
L5-07 (0B2A)	Fault Reset Enable Select Grp1	<p>V/f OLV OLV/PM AOLV/PM EZOLV</p> <p>Use these 4 digits to set the Auto Restart function for <i>oL1</i> to <i>oL4</i>. From left to right, the digits set <i>oL1</i>, <i>oL2</i>, <i>oL3</i>, and <i>oL4</i>, in order. 0000 : Disabled 0001 : Enabled (—/—/—/oL4) 0010 : Enabled (—/—/oL3/—) 0011 : Enabled (—/—/oL3/oL4) 0100 : Enabled (—/oL2/—/—) 0101 : Enabled (—/oL2/—/oL4) 0110 : Enabled (—/oL2/oL3/—) 0111 : Enabled (—/oL2/oL3/oL4) 1000 : Enabled (oL1/—/—/—) 1001 : Enabled (oL1/—/—/oL4) 1010 : Enabled (oL1/—/oL3/—) 1011 : Enabled (oL1/—/oL3/oL4) 1100 : Enabled (oL1/oL2/—/—) 1101 : Enabled (oL1/oL2/—/oL4) 1110 : Enabled (oL1/oL2/oL3/—) 1111 : Enabled (oL1/oL2/oL3/oL4)</p>	1111 (0000 - 1111)
L5-08 (0B2B)	Fault Reset Enable Select Grp2	<p>V/f OLV OLV/PM AOLV/PM EZOLV</p> <p>Use these 4 digits to set the Auto Restart function for <i>Uv1</i>, <i>ov</i>, <i>oH1</i>, and <i>GF</i>. From left to right, the digits set <i>Uv1</i>, <i>ov</i>, <i>oH1</i>, and <i>GF</i>, in order. 0000 : Disabled 0001 : Enabled (—/—/—/GF) 0010 : Enabled (—/—/oH1/—) 0011 : Enabled (—/—/oH1/GF) 0100 : Enabled (—/ov/—/—) 0101 : Enabled (—/ov/—/GF) 0110 : Enabled (—/ov/oH1/—) 0111 : Enabled (—/ov/oH1/GF) 1000 : Enabled (Uv1/—/—/—) 1001 : Enabled (Uv1/—/—/GF) 1010 : Enabled (Uv1/—/oH1/—) 1011 : Enabled (Uv1/—/oH1/GF) 1100 : Enabled (Uv1/ov/—/—) 1101 : Enabled (Uv1/ov/—/GF) 1110 : Enabled (Uv1/ov/oH1/—) 1111 : Enabled (Uv1/ov/oH1/GF)</p>	1111 (0000 - 1111)

◆ L6: Torque Detection

No. (Hex.)	Name	Description	Default (Range)
L6-01 (04A1)	Torque Detection Selection 1	<p>V/f OLV OLV/PM AOLV/PM EZOLV</p> <p>Sets torque detection conditions that will trigger an overtorque or undertorque response from the drive.</p> <p>0 : Disabled 1 : oL @ Speed Agree - Alarm only 2 : oL @ RUN - Alarm only 3 : oL @ Speed Agree - Fault 4 : oL @ RUN - Fault 5 : UL @ Speed Agree - Alarm only 6 : UL @ RUN - Alarm only 7 : UL @ Speed Agree - Fault 8 : UL @ RUN - Fault</p>	0 (0 - 8)
L6-02 (04A2)	Torque Detection Level 1	<p>V/f OLV OLV/PM AOLV/PM EZOLV</p> <p>Sets the detection level for Overtorque/Undertorque Detection 1. In V/f control, drive rated output current = 100% value. In vector control, motor rated torque = 100% value.</p>	150% (0 - 300%)
L6-03 (04A3)	Torque Detection Time 1	<p>V/f OLV OLV/PM AOLV/PM EZOLV</p> <p>Sets the detection time for Overtorque/Undertorque Detection 1.</p>	0.1 s (0.0 - 10.0 s)
L6-04 (04A4)	Torque Detection Selection 2	<p>V/f OLV OLV/PM AOLV/PM EZOLV</p> <p>Sets the speed range that detects overtorque and undertorque and the operation of drives (operation status) after detection.</p> <p>0 : Disabled 1 : oL @ Speed Agree - Alarm only 2 : oL @ RUN - Alarm only 3 : oL @ Speed Agree - Fault 4 : oL @ RUN - Fault 5 : UL @ Speed Agree - Alarm only 6 : UL @ RUN - Alarm only 7 : UL @ Speed Agree - Fault 8 : UL @ RUN - Fault</p>	0 (0 - 8)
L6-05 (04A5)	Torque Detection Level 2	<p>V/f OLV OLV/PM AOLV/PM EZOLV</p> <p>Sets the detection level for Overtorque/Undertorque Detection 2. In V/f control, drive rated output current = 100% value. In vector control, motor rated torque = 100% value.</p>	150% (0 - 300%)
L6-06 (04A6)	Torque Detection Time 2	<p>V/f OLV OLV/PM AOLV/PM EZOLV</p> <p>Sets the detection time for Overtorque/Undertorque Detection 2.</p>	0.1 s (0.0 - 10.0 s)
L6-07 (04E5)	Torque Detection Filter Time	<p>V/f OLV OLV/PM AOLV/PM EZOLV</p> <p>Sets the time constant for a primary filter to the torque reference or to the output current used to detect overtorque/undertorque.</p>	0 ms (0 - 1000 ms)
L6-08 (0468)	Mechanical Fatigue Detect Select	<p>V/f OLV OLV/PM AOLV/PM EZOLV</p> <p>Sets the speed where the drive detects mechanical deterioration and how the drive operates (operation status) after detection.</p> <p>0 : Disabled 1 : oL5 @ Speed > L6-09 - Alarm 2 : oL5 @ Speed > L6-09 - Alarm 3 : oL5 @ Speed > L6-09 - Fault 4 : oL5 @ Speed > L6-09 - Fault 5 : UL5 @ Speed < L6-09 - Alarm 6 : UL5 @ Speed < L6-09 - Alarm 7 : UL5 @ Speed < L6-09 - Fault 8 : UL5 @ Speed < L6-09 - Fault</p>	0 (0 - 8)
L6-09 (0469)	Mech Fatigue Detect Speed Level	<p>V/f OLV OLV/PM AOLV/PM EZOLV</p> <p>Sets the speed level where the drive will operate the mechanical deterioration detection function, as a percentage of the Maximum Output Frequency.</p> <p>Note: Parameter A1-02 [Control Method Selection] selects which parameter is the maximum output frequency. • A1-02 ≠ 8 [EZOLV]: E1-04 [Maximum Output Frequency] • A1-02 = 8: E9-02 [Maximum Speed]</p>	110.0% (-110.0 - 110.0%)

1.11 L: Protection Functions

No. (Hex.)	Name	Description	Default (Range)
L6-10 (046A)	Mech Fatigue Detect Delay Time	V/f OLV OLV/PM AOLV/PM EZOLV Sets the time for mechanical deterioration detection.	0.1 s (0.0 - 10.0 s)
L6-11 (046B)	Mech Fatigue Hold Off Time	V/f OLV OLV/PM AOLV/PM EZOLV Sets the time that the drive will start mechanical deterioration detection triggered by the cumulative operation time of the drive.	0 h (0 - 65535 h)

◆ L7: Torque Limit

No. (Hex.)	Name	Description	Default (Range)
L7-01 (04A7) RUN	Forward Torque Limit	V/f OLV OLV/PM AOLV/PM EZOLV Sets the torque limit value for forward motoring as a percentage, where motor rated torque is the 100% value.	200% (0 - 300%)
L7-02 (04A8) RUN	Reverse Torque Limit	V/f OLV OLV/PM AOLV/PM EZOLV Sets the torque limit value for reversed motoring as a percentage, where motor rated torque is the 100% value.	200% (0 - 300%)
L7-03 (04A9) RUN	Forward Regenerative Trq Limit	V/f OLV OLV/PM AOLV/PM EZOLV Sets the torque limit value for forward regenerative conditions as a percentage of the motor rated torque.	200% (0 - 300%)
L7-04 (04AA) RUN	Reverse Regenerative Trq Limit	V/f OLV OLV/PM AOLV/PM EZOLV Sets the torque limit value for reversed regenerative conditions as a percentage of the motor rated torque.	200% (0 - 300%)
L7-06 (04AC)	Torque Limit Integral Time	V/f OLV OLV/PM AOLV/PM EZOLV Sets the integral time constant for the torque limit function.	200 ms (5 - 10000 ms)
L7-07 (04C9)	Torque Limit during Accel/Decel	V/f OLV OLV/PM AOLV/PM EZOLV Sets the torque limit function during acceleration and deceleration. 0 : Proportional only 1 : Proportional & Integral control	0 (0, 1)
L7-16 (044D)	Torque Limit Process at Start	V/f OLV OLV/PM AOLV/PM EZOLV Assigns a time filter to allow the torque limit to build at start. 0 : Disabled 1 : Enabled	1 (0, 1)

◆ L8: Drive Protection

No. (Hex.)	Name	Description	Default (Range)
L8-01 (04AD)	3% ERF DB Resistor Protection	V/f OLV OLV/PM AOLV/PM EZOLV Sets the function to enable braking resistor protection with a Yaskawa ERF series braking resistor (3% ED) installed on the heatsink. 0 : No 1 : Yes	0 (0, 1)
L8-02 (04AE)	Overheat Alarm Level	V/f OLV OLV/PM AOLV/PM EZOLV Sets the <i>oH</i> detection level in temperature.	Determined by o2-04, C6-01 (50 - 150 °C)
L8-03 (04AF)	Overheat Pre-Alarm Selection	V/f OLV OLV/PM AOLV/PM EZOLV Sets operation after the drive detects an <i>oH</i> alarm. 0 : Ramp to Stop 1 : Coast to Stop 2 : Fast Stop (Use C1-09) 3 : Alarm Only 4 : Operate at Reduced Speed (L8-19)	3 (0 - 4)
L8-05 (04B1)	Input Phase Loss Protection Sel	V/f OLV OLV/PM AOLV/PM EZOLV Sets the function to enable and disable input phase loss detection. 0 : Disabled 1 : Enabled	Determined by o2-04 (Determined by o2-04)

No. (Hex.)	Name	Description	Default (Range)
L8-07 (04B3)	Output Phase Loss Protection Sel	<p><input type="checkbox"/> V/f <input type="checkbox"/> OLV <input type="checkbox"/> OLV/PM <input type="checkbox"/> AOLV/PM <input type="checkbox"/> EZOLV</p> <p>Sets the function to enable and disable output phase loss detection. The drive starts output phase loss detection when the output current decreases to less than 5% of the drive rated current.</p> <p>Note: The drive can incorrectly start output phase loss detection in these conditions:</p> <ul style="list-style-type: none"> • The motor rated current is very small compared to the drive rating. • The drive is operating a PM motor with a small load. <p>0 : Disabled 1 : Fault when one phase is lost 2 : Fault when two phases are lost</p>	1 (0 - 2)
L8-09 (04B5)	Output Ground Fault Detection	<p><input type="checkbox"/> V/f <input type="checkbox"/> OLV <input type="checkbox"/> OLV/PM <input type="checkbox"/> AOLV/PM <input type="checkbox"/> EZOLV</p> <p>Sets the function to enable and disable ground fault protection.</p> <p>0 : Disabled 1 : Enabled</p>	Determined by o2-04 (0, 1)
L8-10 (04B6)	Heatsink Fan Operation Selection	<p><input type="checkbox"/> V/f <input type="checkbox"/> OLV <input type="checkbox"/> OLV/PM <input type="checkbox"/> AOLV/PM <input type="checkbox"/> EZOLV</p> <p>Sets operation of the heatsink cooling fan.</p> <p>0 : During Run, w/ L8-11 Off-Delay 1 : Always On 2 : Temperature-Dependent Fan Ctrl.</p>	0 (0 - 2)
L8-11 (04B7)	Heatsink Fan Off-Delay Time	<p><input type="checkbox"/> V/f <input type="checkbox"/> OLV <input type="checkbox"/> OLV/PM <input type="checkbox"/> AOLV/PM <input type="checkbox"/> EZOLV</p> <p>Sets the length of time that the drive will wait before it stops the cooling fan after it cancels the Run command when L8-10 = 0 [Heatsink Fan Operation Selection = During Run, w/ L8-11 Off-Delay].</p>	60 s (0 - 300 s)
L8-12 (04B8)	Ambient Temperature Setting	<p><input type="checkbox"/> V/f <input type="checkbox"/> OLV <input type="checkbox"/> OLV/PM <input type="checkbox"/> AOLV/PM <input type="checkbox"/> EZOLV</p> <p>Sets the ambient temperature of the drive installation area.</p> <p>Note: The setting range changes when the L8-35 [Installation Method Selection] value changes:</p> <ul style="list-style-type: none"> • 0 [IP20/UL Open Type]: -10 °C to +60 °C • 1 [Side-by-Side Mounting]: -10 °C to +50 °C • 2 [IP20/UL Type 1]: -10 °C to +50 °C • 3 [External Heatsink/Finless]: -10 °C to +50 °C 	40 °C (-10 °C - +60 °C)
L8-15 (04BB)	Drive oL2 @ Low Speed Protection	<p><input type="checkbox"/> V/f <input type="checkbox"/> OLV <input type="checkbox"/> OLV/PM <input type="checkbox"/> AOLV/PM <input type="checkbox"/> EZOLV</p> <p>Sets the function to decrease the drive overload level at which the drive will trigger oL2 [Drive Overload] during low speed operation (6 Hz or slower) to prevent damage to the main circuit transistors.</p> <p>Note: Contact Yaskawa or your nearest sales representative before disabling this function at low speeds. If you frequently operate drives with high output current in low speed ranges, it can cause heat stress and decrease the life span of drive IGBTs.</p> <p>0 : Disabled (No Additional Derate) 1 : Enabled (Reduced oL2 Level)</p>	1 (0, 1)
L8-18 (04BE)	Software Current Limit Selection	<p><input type="checkbox"/> V/f <input type="checkbox"/> OLV <input type="checkbox"/> OLV/PM <input type="checkbox"/> AOLV/PM <input type="checkbox"/> EZOLV</p> <p>Set the software current limit selection function to prevent damage to the main circuit transistor caused by too much current.</p> <p>0 : Disabled 1 : Enabled</p>	0 (0, 1)
L8-19 (04BF)	Freq Reduction @ oH Pre-Alarm	<p><input type="checkbox"/> V/f <input type="checkbox"/> OLV <input type="checkbox"/> OLV/PM <input type="checkbox"/> AOLV/PM <input type="checkbox"/> EZOLV</p> <p>Sets the ratio at which the drive derates the frequency reference during an oH alarm.</p>	0.8 (0.1 - 0.9)
L8-27 (04DD)	Overcurrent Detection Gain	<p><input type="checkbox"/> V/f <input type="checkbox"/> OLV <input type="checkbox"/> OLV/PM <input type="checkbox"/> AOLV/PM <input type="checkbox"/> EZOLV</p> <p>Sets the PM motor overcurrent detection level as a percentage of the motor rated current value.</p> <p>Note: Parameter A1-02 [Control Method Selection] selects which parameter is the motor rated current.</p> <ul style="list-style-type: none"> • A1-02 ≠ 8 [EZOLV]: E5-03 [PM Motor Rated Current (FLA)] • A1-02 = 8: E9-06 [Motor Rated Current (FLA)] 	300.0% (0.0 - 1000.0%)
L8-29 (04DF)	Output Unbalance Detection Sel	<p><input type="checkbox"/> V/f <input type="checkbox"/> OLV <input type="checkbox"/> OLV/PM <input type="checkbox"/> AOLV/PM <input type="checkbox"/> EZOLV</p> <p>Sets the function to detect LF2 [Output Current Imbalance].</p> <p>0 : Disabled 1 : Enabled</p>	1 (0, 1)
L8-31 (04E1)	LF2 Detection Time	<p><input type="checkbox"/> V/f <input type="checkbox"/> OLV <input type="checkbox"/> OLV/PM <input type="checkbox"/> AOLV/PM <input type="checkbox"/> EZOLV</p> <p>Sets the LF2 [Output Current Imbalance] detection time.</p>	3 (1 - 100)

1.11 L: Protection Functions

No. (Hex.)	Name	Description	Default (Range)
L8-35 (04EC)	Installation Method Selection	<p><input type="checkbox"/> V/f <input type="checkbox"/> OLV <input type="checkbox"/> OLV/IPM <input type="checkbox"/> AOLV/IPM <input type="checkbox"/> EZOLV</p> <p>Sets the type of drive installation.</p> <p>Note: This parameter is set to the correct value when the drive is shipped. 0 : IP20/UL Open Type 1 : Side-by-Side Mounting 2 : IP20/UL Type1 3 : External Heatsink/Finless</p>	0, 3 (0 - 3)
L8-40 (04F1)	Carrier Freq Reduction Off-Delay	<p><input type="checkbox"/> V/f <input type="checkbox"/> OLV <input type="checkbox"/> OLV/IPM <input type="checkbox"/> AOLV/IPM <input type="checkbox"/> EZOLV</p> <p>Sets the length of time until the automatically reduced carrier frequency returns to the condition before the reduction.</p>	Determined by A1-02 (0.00 - 2.00 s)
L8-41 (04F2)	High Current Alarm Selection	<p><input type="checkbox"/> V/f <input type="checkbox"/> OLV <input type="checkbox"/> OLV/IPM <input type="checkbox"/> AOLV/IPM <input type="checkbox"/> EZOLV</p> <p>Sets the function to cause an <i>HCA</i> [<i>Current Alarm</i>] when the output current is more than 150% of the drive rated current.</p> <p>0 : No 1 : Yes</p>	0 (0, 1)
L8-51 (0471) Expert	STPo I Detection Level	<p><input type="checkbox"/> V/f <input type="checkbox"/> OLV <input type="checkbox"/> OLV/IPM <input type="checkbox"/> AOLV/IPM <input type="checkbox"/> EZOLV</p> <p>Sets the <i>STPo</i> [<i>Motor Step-Out Detected</i>] detection level as a percentage of the motor rated current.</p> <p>Note: Parameter <i>A1-02</i> [<i>Control Method Selection</i>] selects which parameter is the motor rated current. • <i>A1-02</i> = 5 [<i>OLV/IPM</i>]: <i>E5-03</i> [<i>IPM Motor Rated Current (FLA)</i>] • <i>A1-02</i> = 8 [<i>EZOLV</i>]: <i>E9-06</i> [<i>Motor Rated Current (FLA)</i>]</p>	0.0% (0.0 - 300.0%)
L8-52 (0472) Expert	STPo Integration Level	<p><input type="checkbox"/> V/f <input type="checkbox"/> OLV <input type="checkbox"/> OLV/IPM <input type="checkbox"/> AOLV/IPM <input type="checkbox"/> EZOLV</p> <p>Sets the detection level for <i>STPo</i> [<i>Motor Step-Out Detected</i>] related to the ACR integral value.</p>	1.0 (0.1 - 2.0)
L8-53 (0473) Expert	STPo Integration Time	<p><input type="checkbox"/> V/f <input type="checkbox"/> OLV <input type="checkbox"/> OLV/IPM <input type="checkbox"/> AOLV/IPM <input type="checkbox"/> EZOLV</p> <p>Sets the length of time until the drive detects <i>STPo</i> after it is more than the value of <i>L8-51</i> [<i>STPo I Detection Level</i>].</p>	1.0 s (1.0 - 10.0 s)
L8-54 (0474) Expert	STPo Id Diff Detection	<p><input type="checkbox"/> V/f <input type="checkbox"/> OLV <input type="checkbox"/> OLV/IPM <input type="checkbox"/> AOLV/IPM <input type="checkbox"/> EZOLV</p> <p>Sets the Id deviation detection function for <i>STPo</i> [<i>Motor Step-Out Detected</i>].</p> <p>0 : Disabled 1 : Enabled</p>	1 (0, 1)
L8-55 (045F)	Internal DB TransistorProtection	<p><input type="checkbox"/> V/f <input type="checkbox"/> OLV <input type="checkbox"/> OLV/IPM <input type="checkbox"/> AOLV/IPM <input type="checkbox"/> EZOLV</p> <p>Sets the protection function for the internal braking transistor.</p> <p>0 : Disable 1 : Protection Enabled</p>	1 (0, 1)
L8-56 (047D) Expert	Stall P @ Accel Activation Time	<p><input type="checkbox"/> V/f <input type="checkbox"/> OLV <input type="checkbox"/> OLV/IPM <input type="checkbox"/> AOLV/IPM <input type="checkbox"/> EZOLV</p> <p>Sets the length time that the acceleration stall prevention function can continue to operate before the drive detects an <i>STPo</i> [<i>Motor Step-Out Detected</i>].</p>	5000 ms (100 - 5000 ms)
L8-57 (047E) Expert	Stall Prevention Retry Counts	<p><input type="checkbox"/> V/f <input type="checkbox"/> OLV <input type="checkbox"/> OLV/IPM <input type="checkbox"/> AOLV/IPM <input type="checkbox"/> EZOLV</p> <p>Sets the number of times the acceleration stall prevention function can operate until speeds agree before the drive detects an <i>STPo</i> [<i>Motor Step-Out Detected</i>].</p>	10 (1 - 10 times)
L8-90 (0175) Expert	STPo Detection Level (Low Speed)	<p><input type="checkbox"/> V/f <input type="checkbox"/> OLV <input type="checkbox"/> OLV/IPM <input type="checkbox"/> AOLV/IPM <input type="checkbox"/> EZOLV</p> <p>Sets the detection level that the control fault must be equal to or more than to cause an <i>STPo</i> [<i>Motor Step-Out Detected</i>].</p>	Determined by A1-02 (0 - 5000 times)
L8-93 (073C) Expert	Low Speed Pull-out DetectionTime	<p><input type="checkbox"/> V/f <input type="checkbox"/> OLV <input type="checkbox"/> OLV/IPM <input type="checkbox"/> AOLV/IPM <input type="checkbox"/> EZOLV</p> <p>Sets the length of time the drive will wait to start baseblock after detecting <i>LSo</i> [<i>Low Speed Motor Step-Out</i>].</p>	1.0 s (0.0 - 10.0 s)
L8-94 (073D) Expert	Low Speed Pull-out Detect Level	<p><input type="checkbox"/> V/f <input type="checkbox"/> OLV <input type="checkbox"/> OLV/IPM <input type="checkbox"/> AOLV/IPM <input type="checkbox"/> EZOLV</p> <p>Sets the detection level for <i>LSo</i> [<i>Low Speed Motor Step-Out</i>] as a percentage of <i>E1-04</i> [<i>Maximum Output Frequency</i>].</p>	3% (0 - 10%)
L8-95 (077F) Expert	Low Speed Pull-out Amount	<p><input type="checkbox"/> V/f <input type="checkbox"/> OLV <input type="checkbox"/> OLV/IPM <input type="checkbox"/> AOLV/IPM <input type="checkbox"/> EZOLV</p> <p>Sets the average count of <i>LSo</i> [<i>Low Speed Motor Step-Out</i>] detections.</p>	10 (1 - 50 times)

1.12 n: Special Adjustment

◆ n1: Hunting Prevention

No. (Hex.)	Name	Description	Default (Range)
n1-01 (0580)	Hunting Prevention Selection	<p><input type="checkbox"/> V/f <input type="checkbox"/> OLV <input type="checkbox"/> OLV/PM <input type="checkbox"/> AOLV/PM <input type="checkbox"/> EZOLV</p> <p>Sets the function to prevent hunting.</p> <p>Note: When you replace a V1000-series drive with a GA500 drive, set $n1-01 = 1$ [<i>Hunting Prevention Selection = Enabled</i>].</p> <p>0 : Disabled 1 : Enabled</p>	0 (0, 1)
n1-02 (0581) Expert	Hunting Prevention Gain Setting	<p><input type="checkbox"/> V/f <input type="checkbox"/> OLV <input type="checkbox"/> OLV/PM <input type="checkbox"/> AOLV/PM <input type="checkbox"/> EZOLV</p> <p>Sets the performance of the hunting prevention function. Usually it is not necessary to change this parameter.</p>	1.00 (0.00 - 2.50)
n1-03 (0582) Expert	Hunting Prevention Time Constant	<p><input type="checkbox"/> V/f <input type="checkbox"/> OLV <input type="checkbox"/> OLV/PM <input type="checkbox"/> AOLV/PM <input type="checkbox"/> EZOLV</p> <p>Sets the primary delay time constant of the hunting prevention function. Usually it is not necessary to change this parameter.</p>	Determined by o2-04 (0 - 500 ms)
n1-05 (0530) Expert	Hunting Prevent Gain in Reverse	<p><input type="checkbox"/> V/f <input type="checkbox"/> OLV <input type="checkbox"/> OLV/PM <input type="checkbox"/> AOLV/PM <input type="checkbox"/> EZOLV</p> <p>Sets the performance of the hunting prevention function. This parameter adjusts Reverse run. Usually it is not necessary to change this parameter.</p>	0.00 (0.00 - 2.50)
n1-13 (1B59) Expert	DC Bus Stabilization Control	<p><input type="checkbox"/> V/f <input type="checkbox"/> OLV <input type="checkbox"/> OLV/PM <input type="checkbox"/> AOLV/PM <input type="checkbox"/> EZOLV</p> <p>Sets the oscillation suppression function for the DC bus voltage.</p> <p>0 : Disabled 1 : Enabled</p>	0 (0, 1)
n1-14 (1B5A) Expert	DC Bus Stabilization Time	<p><input type="checkbox"/> V/f <input type="checkbox"/> OLV <input type="checkbox"/> OLV/PM <input type="checkbox"/> AOLV/PM <input type="checkbox"/> EZOLV</p> <p>Adjusts the responsiveness of the oscillation suppression function for the DC bus voltage. Set $n1-13 = 1$ [<i>DC Bus Stabilization Control = Enabled</i>] to enable this parameter.</p>	100.0 ms (50.0 - 500.0 ms)

◆ n2: Auto Freq Regulator (AFR)

No. (Hex.)	Name	Description	Default (Range)
n2-01 (0584)	Automatic Freq Regulator Gain	<p><input type="checkbox"/> V/f <input checked="" type="checkbox"/> OLV <input type="checkbox"/> OLV/PM <input type="checkbox"/> AOLV/PM <input type="checkbox"/> EZOLV</p> <p>Sets the gain of the AFR function as a magnification value. Usually it is not necessary to change this setting.</p>	1.00 (0.00 - 10.00)
n2-02 (0585)	Automatic Freq Regulator Time 1	<p><input type="checkbox"/> V/f <input checked="" type="checkbox"/> OLV <input type="checkbox"/> OLV/PM <input type="checkbox"/> AOLV/PM <input type="checkbox"/> EZOLV</p> <p>Sets the time constant that sets the rate of change for the AFR function. Usually it is not necessary to change this setting.</p>	50 ms (0 - 2000 ms)
n2-03 (0586)	Automatic Freq Regulator Time 2	<p><input type="checkbox"/> V/f <input checked="" type="checkbox"/> OLV <input type="checkbox"/> OLV/PM <input type="checkbox"/> AOLV/PM <input type="checkbox"/> EZOLV</p> <p>Sets the time constant that sets the speed difference of the AFR function. Use this parameter for speed searches or regeneration. Usually it is not necessary to change this setting.</p>	750 ms (0 - 2000 ms)

◆ n3: High Slip/Overexcite Braking

No. (Hex.)	Name	Description	Default (Range)
n3-01 (0588) Expert	HSB Deceleration Frequency Width	<p><input type="checkbox"/> V/f <input type="checkbox"/> OLV <input type="checkbox"/> OLV/PM <input type="checkbox"/> AOLV/PM <input type="checkbox"/> EZOLV</p> <p>Sets the amount by which the output frequency is to be lowered during high-slip braking, as a percentage of $E1-04$ [<i>Maximum Output Frequency</i>], which represents the 100% value.</p>	5% (1 - 20%)
n3-02 (0589) Expert	HSB Current Limit Level	<p><input type="checkbox"/> V/f <input type="checkbox"/> OLV <input type="checkbox"/> OLV/PM <input type="checkbox"/> AOLV/PM <input type="checkbox"/> EZOLV</p> <p>Sets the maximum current output during high-slip braking as a percentage, where $E2-01$ [<i>Motor Rated Current (FLA)</i>] is 100%. Also set the current suppression to prevent exceeding drive overload tolerance.</p> <p>Note: The upper limit to the setting range changes when the setting for $C6-01$ [<i>Normal / Heavy Duty Selection</i>] changes.</p> <ul style="list-style-type: none"> • 150% when $C6-01 = 0$ [<i>Heavy Duty Rating</i>] • 120% when $C6-01 = 1$ [<i>Normal Duty Rating</i>] 	Determined by C6-01 (0 - 150%)

1.12 n: Special Adjustment

No. (Hex.)	Name	Description	Default (Range)
n3-03 (058A) Expert	HSB Dwell Time at Stop	<input checked="" type="checkbox"/> V/f <input type="checkbox"/> OLV <input type="checkbox"/> OLV/IPM <input type="checkbox"/> AOLV/IPM <input type="checkbox"/> EZOLV Sets the dwell time, a length of time when high-slip braking is ending and during which the motor speed decreases and runs at a stable speed. For a set length of time, the drive will hold the actual output frequency at the minimum output frequency set in <i>E1-09</i> .	1.0 s (0.0 - 10.0 s)
n3-04 (058B) Expert	HSB Overload Time	<input checked="" type="checkbox"/> V/f <input type="checkbox"/> OLV <input type="checkbox"/> OLV/IPM <input type="checkbox"/> AOLV/IPM <input type="checkbox"/> EZOLV Sets the time used to detect <i>oL7 [High Slip Braking Overload]</i> , which occurs when the output frequency does not change during high-slip braking. Usually it is not necessary to change this parameter.	40 s (30 - 1200 s)
n3-13 (0531)	OverexcitationBraking (OEB) Gain	<input checked="" type="checkbox"/> V/f <input type="checkbox"/> OLV <input type="checkbox"/> OLV/IPM <input type="checkbox"/> AOLV/IPM <input type="checkbox"/> EZOLV Sets the gain value that the drive multiplies by the V/f pattern output value during overexcitation deceleration to calculate the overexcitation level.	1.10 (1.00 - 1.40)
n3-14 (0532) Expert	OEB High Frequency Injection	<input checked="" type="checkbox"/> V/f <input type="checkbox"/> OLV <input type="checkbox"/> OLV/IPM <input type="checkbox"/> AOLV/IPM <input type="checkbox"/> EZOLV Sets the function that injects harmonic signals during overexcitation deceleration. 0 : Disabled 1 : Enabled	0 (0, 1)
n3-21 (0579)	HSB Current Suppression Level	<input checked="" type="checkbox"/> V/f <input type="checkbox"/> OLV <input type="checkbox"/> OLV/IPM <input type="checkbox"/> AOLV/IPM <input type="checkbox"/> EZOLV Sets the upper limit of the current that is suppressed at the time of overexcitation deceleration as a percentage of the drive rated current.	100% (0 - 150%)
n3-23 (057B)	Overexcitation Braking Operation	<input checked="" type="checkbox"/> V/f <input type="checkbox"/> OLV <input type="checkbox"/> OLV/IPM <input type="checkbox"/> AOLV/IPM <input type="checkbox"/> EZOLV Sets the direction of motor rotation where the drive will enable overexcitation. 0 : Disabled 1 : Enabled Only when Rotating FWD 2 : Enabled Only when Rotating REV	0 (0 - 2)

◆ n5: Feed Forward Control

No. (Hex.)	Name	Description	Default (Range)
n5-01 (05B0)	Feed Forward Control Selection	<input checked="" type="checkbox"/> V/f <input type="checkbox"/> OLV <input type="checkbox"/> OLV/IPM <input type="checkbox"/> AOLV/IPM <input type="checkbox"/> EZOLV Sets the feed forward function. 0 : Disabled 1 : Enabled	0 (0, 1)
n5-02 (05B1)	Motor Inertia Acceleration Time	<input checked="" type="checkbox"/> V/f <input type="checkbox"/> OLV <input type="checkbox"/> OLV/IPM <input type="checkbox"/> AOLV/IPM <input type="checkbox"/> EZOLV Sets the length of time for the motor to accelerate from the stopped to the maximum frequency with a single motor at the rated torque. Inertia Tuning automatically sets the motor acceleration time.	Determined by C6-01, E5-01, and o2-04 (0.001 - 10.000 s)
n5-03 (05B2)	Feed Forward Control Gain	<input checked="" type="checkbox"/> V/f <input type="checkbox"/> OLV <input type="checkbox"/> OLV/IPM <input type="checkbox"/> AOLV/IPM <input type="checkbox"/> EZOLV Sets the ratio between load inertia and motor inertia. Inertia Tuning automatically sets the Feedforward Control Gain value.	1.00 (0.00 - 100.00)
n5-04 (05B3) RUN Expert	Speed Response Frequency	<input checked="" type="checkbox"/> V/f <input type="checkbox"/> OLV <input type="checkbox"/> OLV/IPM <input type="checkbox"/> AOLV/IPM <input type="checkbox"/> EZOLV Sets the response frequency for the speed reference. Usually it is not necessary to change this parameter.	Determined by A1-02 (0.00 - 500.00 Hz)

◆ n6: Online Tuning

No. (Hex.)	Name	Description	Default (Range)
n6-01 (0570)	Online Tuning Selection	<input checked="" type="checkbox"/> V/f <input type="checkbox"/> OLV <input type="checkbox"/> OLV/IPM <input type="checkbox"/> AOLV/IPM <input type="checkbox"/> EZOLV Sets the type of motor data that Online Tuning uses for OLV control. 0 : Disabled 1 : Line-to-Line Resistance Tuning 2 : Voltage Correction Tuning	0 (0 - 2)
n6-05 (05C7) Expert	Online Tuning Gain	<input checked="" type="checkbox"/> V/f <input type="checkbox"/> OLV <input type="checkbox"/> OLV/IPM <input type="checkbox"/> AOLV/IPM <input type="checkbox"/> EZOLV Sets the compensation gain when <i>n6-01 = 2 [Online Tuning Selection = Voltage Correction Tuning]</i> . Usually it is not necessary to change this parameter.	1.0 (0.1 - 50.0)

◆ n7: EZ Drive

No. (Hex.)	Name	Description	Default (Range)
n7-01 (3111) Expert	Damping Gain for Low Frequency	<input type="checkbox"/> V/f <input type="checkbox"/> OLV <input type="checkbox"/> OLV/PM <input type="checkbox"/> AOLV/PM <input checked="" type="checkbox"/> EZOLV Sets the oscillation suppression gain for the low speed range.	1.0 (0.1 - 10.0)
n7-05 (3115) Expert	Response Gain for Load Changes	<input type="checkbox"/> V/f <input type="checkbox"/> OLV <input type="checkbox"/> OLV/PM <input type="checkbox"/> AOLV/PM <input checked="" type="checkbox"/> EZOLV Sets the response gain related to changes in the load.	50 (10 - 1000)
n7-07 (3117) Expert	Speed Calculation Gain1	<input type="checkbox"/> V/f <input type="checkbox"/> OLV <input type="checkbox"/> OLV/PM <input type="checkbox"/> AOLV/PM <input checked="" type="checkbox"/> EZOLV Sets the speed calculation gain during usual operation. Usually it is not necessary to change this setting.	15.0 (1.0 - 50.0)
n7-08 (3118) Expert	Speed Calculation Gain2	<input type="checkbox"/> V/f <input type="checkbox"/> OLV <input type="checkbox"/> OLV/PM <input type="checkbox"/> AOLV/PM <input checked="" type="checkbox"/> EZOLV Sets the speed calculation gain during a speed search.	25.0 (1.0 - 50.0)
n7-10 (311A) Expert	Pull-in Current Switching Speed	<input type="checkbox"/> V/f <input type="checkbox"/> OLV <input type="checkbox"/> OLV/PM <input type="checkbox"/> AOLV/PM <input checked="" type="checkbox"/> EZOLV Sets the speed range to operate with the pull-in current command. Drive rated frequency = 100% value. If there is a large quantity of oscillation when you operate in the low speed range, increase the setting value.	10.0% (0.0 - 100.0%)
n7-17 (3122)	Resistance Temperature Correction	<input type="checkbox"/> V/f <input type="checkbox"/> OLV <input type="checkbox"/> OLV/PM <input type="checkbox"/> AOLV/PM <input checked="" type="checkbox"/> EZOLV Sets the function to adjust for changes in the motor resistance value caused by changes in the temperature. 0 : Invalid 1 : Valid (Only 1 time) 2 : Valid (Every time)	1 (0 to 2)
n7-19 (3128) Expert	Flux Error Compensation Gain	<input type="checkbox"/> V/f <input type="checkbox"/> OLV <input type="checkbox"/> OLV/PM <input type="checkbox"/> AOLV/PM <input checked="" type="checkbox"/> EZOLV Sets the gain for magnetic flux compensation. Usually it is not necessary to change this setting.	5000% (0 - 50000%)

◆ n8: PM Motor Control Tuning

No. (Hex.)	Name	Description	Default (Range)
n8-01 (0540)	Pole Position Detection Current	<input type="checkbox"/> V/f <input type="checkbox"/> OLV <input checked="" type="checkbox"/> OLV/PM <input type="checkbox"/> AOLV/PM <input type="checkbox"/> EZOLV Sets the Initial Rotor Position Estimated Current as a percentage where E5-03 [PM Motor Rated Current (FLA)] = 100%. Usually it is not necessary to change this setting.	50% (0 - 100%)
n8-02 (0541)	Pole Alignment Current Level	<input type="checkbox"/> V/f <input type="checkbox"/> OLV <input type="checkbox"/> OLV/PM <input type="checkbox"/> AOLV/PM <input checked="" type="checkbox"/> EZOLV Sets the current at the time of polar attraction as a percentage where E5-03 [motor rated current] is 100%. Usually it is not necessary to change this setting.	80% (0 - 150%)
n8-11 (054A) Expert	Observer Calculation Gain 2	<input type="checkbox"/> V/f <input type="checkbox"/> OLV <input type="checkbox"/> OLV/PM <input type="checkbox"/> AOLV/PM <input checked="" type="checkbox"/> EZOLV Sets the gain for speed estimation. Usually it is not necessary to change this setting.	Determined by n8-72 (0.0 - 1000.0)
n8-14 (054D) Expert	Polarity Compensation Gain 3	<input type="checkbox"/> V/f <input type="checkbox"/> OLV <input type="checkbox"/> OLV/PM <input type="checkbox"/> AOLV/PM <input checked="" type="checkbox"/> EZOLV Sets the gain for speed estimation. Usually it is not necessary to change this setting.	1.000 (0.000 - 10.000)
n8-15 (054E) Expert	Polarity Compensation Gain 4	<input type="checkbox"/> V/f <input type="checkbox"/> OLV <input type="checkbox"/> OLV/PM <input type="checkbox"/> AOLV/PM <input checked="" type="checkbox"/> EZOLV Sets the gain for speed estimation. Usually it is not necessary to change this setting.	0.500 (0.000 - 10.000)
n8-21 (0554) Expert	Motor Back-EMF (Ke) Gain	<input type="checkbox"/> V/f <input type="checkbox"/> OLV <input type="checkbox"/> OLV/PM <input type="checkbox"/> AOLV/PM <input checked="" type="checkbox"/> EZOLV Sets the gain for speed estimation. Usually it is not necessary to change this setting.	0.90 (0.80 - 1.00)
n8-23 (0556) Expert	ACR q Gain @PoleEst	<input type="checkbox"/> V/f <input type="checkbox"/> OLV <input checked="" type="checkbox"/> OLV/PM <input type="checkbox"/> AOLV/PM <input type="checkbox"/> EZOLV Sets the proportional gain for current regulator q-axis control when the drive estimates the initial pole. Usually it is not necessary to change this setting.	0 (0 - 2000)
n8-24 (0557) Expert	ACR q Integral Time @PoleEst	<input type="checkbox"/> V/f <input type="checkbox"/> OLV <input checked="" type="checkbox"/> OLV/PM <input type="checkbox"/> AOLV/PM <input type="checkbox"/> EZOLV Sets the integral time for current regulator q-axis control when the drive estimates the initial pole. Usually it is not necessary to change this setting.	0.0 ms (0.0 - 100.0 ms)
n8-25 (0558) Expert	ACR q Limit @PoleEst	<input type="checkbox"/> V/f <input type="checkbox"/> OLV <input checked="" type="checkbox"/> OLV/PM <input type="checkbox"/> AOLV/PM <input type="checkbox"/> EZOLV Sets the q-axis limit of the current regulator when the drive estimates the initial pole. Usually it is not necessary to change this setting.	0% (0 - 150%)

1.12 n: Special Adjustment

No. (Hex.)	Name	Description	Default (Range)
n8-26 (0559) Expert	ACR d Gain @PoleEst	<input type="checkbox"/> V/f <input type="checkbox"/> OLV <input checked="" type="checkbox"/> OLV/PM <input type="checkbox"/> AOLV/PM <input type="checkbox"/> EZOLV Sets the proportional gain for current regulator d-axis control when the drive estimates the initial pole. Usually it is not necessary to change this setting.	500 (0 - 2000)
n8-27 (055A) Expert	ACR d Integral Time @PoleEst	<input type="checkbox"/> V/f <input type="checkbox"/> OLV <input checked="" type="checkbox"/> OLV/PM <input type="checkbox"/> AOLV/PM <input type="checkbox"/> EZOLV Sets the integral time for current regulator d-axis control when the drive estimates the initial pole. Usually it is not necessary to change this setting.	0.0 ms (0.0 - 100.0 ms)
n8-28 (055B) Expert	ACR d Lim @PoleEst	<input type="checkbox"/> V/f <input type="checkbox"/> OLV <input checked="" type="checkbox"/> OLV/PM <input type="checkbox"/> AOLV/PM <input type="checkbox"/> EZOLV Sets the d-axis limit of the current regulator when the drive estimates the initial pole. Usually it is not necessary to change this setting.	100% (0 - 150%)
n8-35 (0562)	Initial Pole Detection Method	<input type="checkbox"/> V/f <input type="checkbox"/> OLV <input checked="" type="checkbox"/> OLV/PM <input type="checkbox"/> AOLV/PM <input type="checkbox"/> EZOLV Sets how the drive detects the position of the rotor when the motor starts. Note: • When you use an SPM motor, set $n8-35 = 0$. When you use an IPM motor, set $n8-35 = 0$ to 2 . • When you set $n8-35 = 1$, do High Frequency Injection Auto-Tuning. 0 : Pull-in 1 : High Frequency Injection 2 : Pulse Injection	Determined by A1-02 (0 - 2)
n8-36 (0563)	HFI Frequency Level for L Tuning	<input type="checkbox"/> V/f <input type="checkbox"/> OLV <input checked="" type="checkbox"/> OLV/PM <input type="checkbox"/> AOLV/PM <input type="checkbox"/> EZOLV Sets the injection frequency for high frequency injection. Note: • Set $n8-35 = 1$ [Initial Pole Detection Method = High Frequency Injection] or $n8-57 = 1$ [HFI Overlap Selection = Enabled] to enable this parameter. • The drive automatically calculates this value when High Frequency Injection Auto-Tuning completes successfully.	500 Hz (200 - 1000 Hz)
n8-37 (0564) Expert	HFI Voltage Amplitude Level	<input type="checkbox"/> V/f <input type="checkbox"/> OLV <input checked="" type="checkbox"/> OLV/PM <input type="checkbox"/> AOLV/PM <input type="checkbox"/> EZOLV Sets the high frequency injection amplitude as a percentage where 200 V = 100% for 200 V class drives and 400 V = 100% for a 400 V class drives. Usually it is not necessary to change this setting. Note: • Set $n8-35 = 1$ [Initial Pole Detection Method = High Frequency Injection] or $n8-57 = 1$ [HFI Overlap Selection = Enabled] to enable this parameter. • The drive automatically calculates this value when High Frequency Injection Auto-Tuning completes successfully.	20.0% (0.0 - 50.0%)
n8-39 (0566)	HFI LPF Cutoff Freq	<input type="checkbox"/> V/f <input type="checkbox"/> OLV <input checked="" type="checkbox"/> OLV/PM <input type="checkbox"/> AOLV/PM <input type="checkbox"/> EZOLV Sets the low-pass filter shut-off frequency for high frequency injection. Note: • Set $n8-35 = 1$ [Initial Pole Detection Method = High Frequency Injection] or $n8-57 = 1$ [HFI Overlap Selection = Enabled] to enable this parameter. • The drive automatically calculates this value when High Frequency Injection Auto-Tuning completes successfully.	250 Hz (0 - 1000 Hz)
n8-41 (0568) Expert	HFI P Gain	<input type="checkbox"/> V/f <input type="checkbox"/> OLV <input checked="" type="checkbox"/> OLV/PM <input type="checkbox"/> AOLV/PM <input type="checkbox"/> EZOLV Sets the response gain for the high frequency injection speed estimation. Note: • Set $n8-35 = 1$ [Initial Pole Detection Method = High Frequency Injection] or $n8-57 = 1$ [HFI Overlap Selection = Enabled] to enable this parameter. • When $A1-02 = 6$ [Control Method Selection = AOLV/PM] and you do High Frequency Injection Auto-Tuning, the drive automatically sets this parameter.	2.5 (-10.0 - +10.0)
n8-42 (0569) Expert	HFI I Time	<input type="checkbox"/> V/f <input type="checkbox"/> OLV <input checked="" type="checkbox"/> OLV/PM <input type="checkbox"/> AOLV/PM <input type="checkbox"/> EZOLV Sets the integral time constant for the high frequency injection speed estimation. Usually it is not necessary to change this setting.	0.10 s (0.00 - 9.99 s)
n8-45 (0538)	Speed Feedback Detection Gain	<input type="checkbox"/> V/f <input type="checkbox"/> OLV <input checked="" type="checkbox"/> OLV/PM <input type="checkbox"/> AOLV/PM <input type="checkbox"/> EZOLV Sets the internal speed feedback detection reduction unit gain as a magnification value. Usually it is not necessary to change this setting.	0.80 (0.00 - 10.00)
n8-46 (0539) Expert	PM Phase Compensation Gain	<input type="checkbox"/> V/f <input type="checkbox"/> OLV <input checked="" type="checkbox"/> OLV/PM <input type="checkbox"/> AOLV/PM <input type="checkbox"/> EZOLV Sets the gain to compensate for phase differences. Usually it is not necessary to change this setting.	0.3 (0.0 - 10.0)
n8-47 (053A)	Pull-in Current Comp Filter Time	<input type="checkbox"/> V/f <input type="checkbox"/> OLV <input checked="" type="checkbox"/> OLV/PM <input type="checkbox"/> AOLV/PM <input type="checkbox"/> EZOLV Sets the time constant the drive uses to align the pull-in current reference value with the actual current value. Usually it is not necessary to change this setting.	5.0 s (0.0 - 100.0 s)
n8-48 (053B) RUN	Pull-in/Light Load Id Current	<input type="checkbox"/> V/f <input type="checkbox"/> OLV <input checked="" type="checkbox"/> OLV/PM <input type="checkbox"/> AOLV/PM <input type="checkbox"/> EZOLV On the basis that parameter $E5-03$ [Motor Rated Current (FLA)] is the 100% value, this parameter sets the d-axis current that flows to the motor during run at constant speed as a percentage.	30% (0 - 200%)
n8-49 (053C) RUN Expert	Heavy Load Id Current	<input type="checkbox"/> V/f <input type="checkbox"/> OLV <input checked="" type="checkbox"/> OLV/PM <input type="checkbox"/> AOLV/PM <input type="checkbox"/> EZOLV Sets the d-axis current to that the drive will supply to the motor to run it at a constant speed with a heavy load. Considers $E5-03$ [PM Motor Rated Current (FLA)] to be 100%. Usually it is not necessary to change this setting.	Determined by E5-01 (-200.0 - +200.0%)

No. (Hex.)	Name	Description	Default (Range)
n8-50 (053D) Expert	Medium Load Iq Level (High)	<input type="checkbox"/> V/f <input type="checkbox"/> OLV <input checked="" type="checkbox"/> OLV/PM <input type="checkbox"/> AOLV/PM <input type="checkbox"/> EZOLV Sets the load current level at which heavy load control starts where E5-03 [Motor Rated Current (FLA)] is 100%. Usually it is not necessary to change this setting.	80% (50 - 255)
n8-51 (053E)	Pull-in Current @ Acceleration	<input type="checkbox"/> V/f <input type="checkbox"/> OLV <input checked="" type="checkbox"/> OLV/PM <input type="checkbox"/> AOLV/PM <input checked="" type="checkbox"/> EZOLV Sets the pull-in current allowed to flow during acceleration/deceleration as a percentage of the motor rated current. Note: Parameter A1-02 [Control Method Selection] selects which parameter is the motor rated current. • A1-02 = 5 [OLV/PM]: E5-03 [PM Motor Rated Current (FLA)] • A1-02 = 8 [EZOLV]: E9-06 [Motor Rated Current (FLA)]	Determined by A1-02 (0 - 200%)
n8-54 (056D) Expert	Voltage Error Compensation Time	<input type="checkbox"/> V/f <input type="checkbox"/> OLV <input checked="" type="checkbox"/> OLV/PM <input type="checkbox"/> AOLV/PM <input type="checkbox"/> EZOLV Sets the time constant that the drive uses when adjusting for voltage errors.	1.00 s (0.00 - 10.00 s)
n8-55 (056E)	Motor to Load Inertia Ratio	<input type="checkbox"/> V/f <input type="checkbox"/> OLV <input checked="" type="checkbox"/> OLV/PM <input type="checkbox"/> AOLV/PM <input type="checkbox"/> EZOLV Sets the ratio between motor inertia and machine inertia. 0 : Below 1:10 1 : Between 1:10 and 1:30 2 : Between 1:30 and 1:50 3 : Beyond 1:50	0 (0 - 3)
n8-56 (056F) Expert	PM High Performance Selection	<input type="checkbox"/> V/f <input type="checkbox"/> OLV <input checked="" type="checkbox"/> OLV/PM <input type="checkbox"/> AOLV/PM <input type="checkbox"/> EZOLV Sets the high efficiency control method for IPM motors. Usually it is not necessary to change this setting. 0 : Disabled 1 : Enabled (Vd) 2 : Enabled (Vd & Vq)	1 (0 - 2)
n8-57 (0574)	HFI Overlap Selection	<input type="checkbox"/> V/f <input type="checkbox"/> OLV <input checked="" type="checkbox"/> OLV/PM <input type="checkbox"/> AOLV/PM <input type="checkbox"/> EZOLV Sets the function that detects motor speed with high frequency injection. Note: When you set n8-57 = 1, do High Frequency Injection Auto-Tuning. 0 : Disabled 1 : Enabled	0 (0, 1)
n8-62 (057D) Expert	Output Voltage Limit Level	<input type="checkbox"/> V/f <input type="checkbox"/> OLV <input checked="" type="checkbox"/> OLV/PM <input type="checkbox"/> AOLV/PM <input type="checkbox"/> EZOLV Sets the output voltage limit to prevent saturation of the output voltage. Usually it is not necessary to change this parameter. Note: When A1-02 = 8 [Control Method Selection = EZOLV], the default settings are: • 200 V class: 230.0 V • 400 V class: 460.0 V	200 V Class: 200.0 V, 400 V: 400.0 V (200 V Class: 0.0 to 240.0 V, 400 V Class: 0.0 to 480.0 V)
n8-63 (057E) Expert	Output Voltage Limit P Gain	<input type="checkbox"/> V/f <input type="checkbox"/> OLV <input checked="" type="checkbox"/> OLV/PM <input type="checkbox"/> AOLV/PM <input type="checkbox"/> EZOLV Sets the proportional gain for output voltage control. Usually it is not necessary to change this setting.	1.00 (0.00 - 100.00)
n8-64 (057F) Expert	Output Voltage Limit I Time	<input type="checkbox"/> V/f <input type="checkbox"/> OLV <input checked="" type="checkbox"/> OLV/PM <input type="checkbox"/> AOLV/PM <input type="checkbox"/> EZOLV Sets the integral time for output voltage control. Usually it is not necessary to change this setting.	0.040 s (0.000 - 5.000)
n8-65 (065C) Expert	Speed Fdbk Gain @ oV Suppression	<input type="checkbox"/> V/f <input type="checkbox"/> OLV <input checked="" type="checkbox"/> OLV/PM <input type="checkbox"/> AOLV/PM <input type="checkbox"/> EZOLV Sets the gain of internal speed feedback detection suppression while the overvoltage suppression function is operating as a magnification value. Usually it is not necessary to change this parameter.	1.50 (0.00 - 10.00)
n8-69 (065D) Expert	Speed Observer Control P Gain	<input type="checkbox"/> V/f <input type="checkbox"/> OLV <input type="checkbox"/> OLV/PM <input type="checkbox"/> AOLV/PM <input type="checkbox"/> EZOLV Usually it is not necessary to change this setting. Sets the Proportional gain that the drive uses for speed estimation.	1.00 (0.00 - 20.00)
n8-70 (065E) Expert	Speed Observer Control I Time	<input type="checkbox"/> V/f <input type="checkbox"/> OLV <input type="checkbox"/> OLV/PM <input type="checkbox"/> AOLV/PM <input type="checkbox"/> EZOLV Sets the speed estimator integral time constant. It is available when n8-72 = 1 [Speed Estimation Method Select = Method 2]. Usually it is not necessary to change this setting.	0.0 s (0.0 - 100.0)
n8-71 (065F) Expert	Speed Observer Control D Gain	<input type="checkbox"/> V/f <input type="checkbox"/> OLV <input type="checkbox"/> OLV/PM <input type="checkbox"/> AOLV/PM <input type="checkbox"/> EZOLV Set the speed estimator differential gain. It is available when n8-72 = 1 [Speed Estimation Method Select = Method 2]. Usually it is not necessary to change this setting.	5.00 (0.00 - 50.00)
n8-72 (0655) Expert	Speed Estimation Method Select	<input type="checkbox"/> V/f <input type="checkbox"/> OLV <input type="checkbox"/> OLV/PM <input type="checkbox"/> AOLV/PM <input type="checkbox"/> EZOLV Selects the speed estimation method. Usually it is not necessary to change this setting. 0 : Method 1 1 : Method 2	1 (0, 1)

1.12 n: Special Adjustment

No. (Hex.)	Name	Description	Default (Range)
n8-73 (0656) Expert	Observer Mode Switch-Over Speed	<input type="checkbox"/> V/f <input type="checkbox"/> OLV <input checked="" type="checkbox"/> OLV/PM <input type="checkbox"/> AOLV/PM <input type="checkbox"/> EZOLV Sets the speed level for pull-in current control at motor start as a percentage of E1-06 [Base Frequency]. Usually it is not necessary to change this setting.	10% (0 - 100)
n8-74 (05C3) Expert	Light Load Iq Level	<input type="checkbox"/> V/f <input type="checkbox"/> OLV <input checked="" type="checkbox"/> OLV/PM <input type="checkbox"/> AOLV/PM <input type="checkbox"/> EZOLV Set n8-48 [Pull-in/Light Load Id Current] to the percentage of load current (q-axis current) that you will apply, where E5-03 [Motor Rated Current (FLA)] = a setting value of 100%.	30% (0 - 255%)
n8-75 (05C4) Expert	Medium Load Iq Level (low)	<input type="checkbox"/> V/f <input type="checkbox"/> OLV <input checked="" type="checkbox"/> OLV/PM <input type="checkbox"/> AOLV/PM <input type="checkbox"/> EZOLV Set n8-78 [Medium Load Id Current] to the percentage of load current (q-axis current) that you will apply, where E5-03 [Motor Rated Current (FLA)] = a setting value of 100%.	50% (0 - 255%)
n8-76 (05CD) Expert	Id Switching Filter Time	<input type="checkbox"/> V/f <input type="checkbox"/> OLV <input checked="" type="checkbox"/> OLV/PM <input type="checkbox"/> AOLV/PM <input type="checkbox"/> EZOLV Sets the filter time constant for the d-axis current reference. Usually it is not necessary to change this setting.	200 ms (0 - 5000 ms)
n8-77 (05CE) Expert	Heavy Load Iq Level	<input type="checkbox"/> V/f <input type="checkbox"/> OLV <input checked="" type="checkbox"/> OLV/PM <input type="checkbox"/> AOLV/PM <input type="checkbox"/> EZOLV Set n8-49 [Heavy Load Id Current] to the percentage of load current (q-axis current) that you will apply, where E5-03 [Motor Rated Current (FLA)] = a setting value of 100%.	90% (0 - 255%)
n8-78 (05F4) RUN Expert	Medium Load Id Current	<input type="checkbox"/> V/f <input type="checkbox"/> OLV <input checked="" type="checkbox"/> OLV/PM <input type="checkbox"/> AOLV/PM <input type="checkbox"/> EZOLV Sets the level of the pull-in current as a percentage, where E5-03 [PM Motor Rated Current (FLA)] = 100%.	0% (0 - 255%)
n8-79 (05FE)	Pull-in Current @ Deceleration	<input type="checkbox"/> V/f <input type="checkbox"/> OLV <input checked="" type="checkbox"/> OLV/PM <input type="checkbox"/> AOLV/PM <input type="checkbox"/> EZOLV Sets the pull-in current that can flow during deceleration as a percentage of the E5-03 [PM Motor Rated Current (FLA)]. Note: When n8-79 = 0, the drive will use the value set in n8-51 [Pull-in Current @ Acceleration].	50% (0 - 200%)
n8-84 (02D3) Expert	Polarity Detection Current	<input type="checkbox"/> V/f <input type="checkbox"/> OLV <input checked="" type="checkbox"/> OLV/PM <input type="checkbox"/> AOLV/PM <input type="checkbox"/> EZOLV Sets the current that the drive uses to estimate the initial motor magnetic pole as a percentage where E5-03 [PM Motor Rated Current (FLA)] = 100%.	100% (0 - 150%)
n8-87 (02DA)	Output Voltage Limit Method	<input type="checkbox"/> V/f <input type="checkbox"/> OLV <input checked="" type="checkbox"/> OLV/PM <input type="checkbox"/> AOLV/PM <input type="checkbox"/> EZOLV Sets the method of output voltage limit. If there is vibration in the constant output range, set Feedforward Method. Usually it is not necessary to change this setting. 0 : Feedback Method 1 : Feedforward Method	0 (0, 1)
n8-88 (02BD)	Vout Limit Switching Level	<input type="checkbox"/> V/f <input type="checkbox"/> OLV <input checked="" type="checkbox"/> OLV/PM <input type="checkbox"/> AOLV/PM <input type="checkbox"/> EZOLV Sets the current level at which output voltage limit sequence selection occurs as a percentage where the motor rated current is 100%. Normally there is no need to change this setting. Note: Parameter A1-02 [Control Method Selection] selects which parameter is the motor rated current. • A1-02 = 5, 6 [OLV/PM, AOLV/PM]; E5-03 [PM Motor Rated Current (FLA)] • A1-02 = 8 [EZOLV]; E9-06 [PM Motor Rated Current (FLA)]	400% (0 - 400%)
n8-89 (02BE)	Vout Limit Switching Hysteresis	<input type="checkbox"/> V/f <input type="checkbox"/> OLV <input checked="" type="checkbox"/> OLV/PM <input type="checkbox"/> AOLV/PM <input type="checkbox"/> EZOLV Sets the hysteresis width of the current level at which output voltage limit sequence selection occurs as a percentage where the motor rated current is 100%. Normally there is no need to change this setting. Note: Parameter A1-02 [Control Method Selection] selects which parameter is the motor rated current. • A1-02 = 5, 6 [OLV/PM, AOLV/PM]; E5-03 [PM Motor Rated Current (FLA)] • A1-02 = 8 [EZOLV]; E9-06 [PM Motor Rated Current (FLA)]	3% (0 - 400%)
n8-90 (02BF)	Vout Limit Switching Speed	<input type="checkbox"/> V/f <input type="checkbox"/> OLV <input checked="" type="checkbox"/> OLV/PM <input type="checkbox"/> AOLV/PM <input type="checkbox"/> EZOLV Sets the speed level at which output voltage limit sequence selection occurs as a percentage where the maximum output frequency is 100%. Usually it is not necessary to change this setting. Note: Parameter A1-02 [Control Method Selection] selects which parameter is the maximum output frequency. • A1-02 = 5, 6 [OLV/PM, AOLV/PM]; E1-04 [Maximum Output Frequency] • A1-02 = 8: E9-02 [Motor Max Revolutions]	200% (0 - 200%)
n8-91 (02F7)	Id Limit at Voltage Saturation	<input type="checkbox"/> V/f <input type="checkbox"/> OLV <input checked="" type="checkbox"/> OLV/PM <input type="checkbox"/> AOLV/PM <input type="checkbox"/> EZOLV Sets the limit value of feedback output voltage limit Id operation. Enabled when n8-87 = 0 [Output Voltage Control Selection = Speed Feedback Form]. Usually it is not necessary to change this setting.	-50% (-200 - 0%)

No. (Hex.)	Name	Description	Default (Range)
n8-94 (012D) Expert	Flux Position Estimation Method	<p>V/f OLV OLV/PM AOLV/PM EZOLV</p> <p>Sets the criteria that the drive uses to find changes in speed or load. Usually it is not necessary to change this setting.</p> <p>0 : Softstarter 1 : Speed Feedback</p>	1 (0, 1)
n8-95 (012E) Expert	Flux Position Est Filter Time	<p>V/f OLV OLV/PM AOLV/PM EZOLV</p> <p>Sets the time constant of the filter used for the recognition criteria value for speed and load changes. Usually it is not necessary to change this setting.</p>	30 ms (0 - 100 ms)

◆ nA: PM Motor Control Tuning

No. (Hex.)	Name	Description	Default (Range)
nA-01 (3129) Expert	Observer Calc Gain 3	<p>V/f OLV OLV/PM AOLV/PM EZOLV</p> <p>Sets the gain for speed estimation. Usually it is not necessary to change this setting.</p>	30.0 (0.0 - 1000.0)

1.13 o: Keypad-Related Settings

◆ o1: Keypad Display

No. (Hex.)	Name	Description	Default (Range)
o1-01 (0500) RUN	User Monitor Selection	V/f OLV OLV/PM AOLV/PM EZOLV Sets the <i>U</i> monitor for the Drive Mode. This parameter is only available with an LED keypad.	106 (104 - 855)
o1-02 (0501) RUN	Monitor Selection at Power-up	V/f OLV OLV/PM AOLV/PM EZOLV Sets the monitor item that the keypad screen shows after you energize the drive. Refer to "U: Monitors" for information about the monitor items that the keypad screen can show. This parameter is only available with an LED keypad. 1 : Frequency Reference (U1-01) 2 : Direction 3 : Output Frequency (U1-02) 4 : Output Current (U1-03) 5 : User Monitor (<i>o1-01</i>)	1 (1 - 5)
o1-03 (0502)	Frequency Display Unit Selection	V/f OLV OLV/PM AOLV/PM EZOLV Sets the display units for the frequency reference and output frequency. 0 : 0.01 Hz 1 : 0.01% (100% = E1-04) 2 : Revolutions Per Minute (RPM) 3 : User units (Set with o1-10, o1-11)	Determined by A1-02 (0 - 3)
o1-04 (0503)	V/f Pattern Display Unit	V/f OLV OLV/PM AOLV/PM EZOLV Sets the setting unit for parameters that set the V/f pattern frequency. 0 : Hz 1 : min ⁻¹ (r/min) units	Determined by A1-02 (0, 1)
o1-05 (0504) RUN	LCD Contrast Adjustment	V/f OLV OLV/PM AOLV/PM EZOLV Sets the contrast of the LCD display on the keypad.	5 (0 - 10)
o1-10 (0520)	User Units Maximum Value	V/f OLV OLV/PM AOLV/PM EZOLV Sets the value that the drive shows as the maximum output frequency.	Determined by o1-03 (1 - 60000)
o1-11 (0521)	User Units Decimal Position	V/f OLV OLV/PM AOLV/PM EZOLV Sets the number of decimal places for frequency reference and monitor values. 0 : No Decimal Places (XXXXX) 1 : One Decimal Places (XXXX.X) 2 : Two Decimal Places (XXX.XX) 3 : Three Decimal Places (XX.XXX)	Determined by o1-03 (0 - 3)
o1-24 (11AD) RUN	Custom Monitor 1	V/f OLV OLV/PM AOLV/PM EZOLV You can select a maximum of 12 monitors as user monitors and set them to parameters <i>o1-24</i> to <i>o1-35</i> . This parameter sets the user monitor to show on the first line. The registered monitor is also used for different monitor displays of bar graph, analog meter, and waveform.	101 (0, 101 - 999)
o1-25 (11AE) RUN	Custom Monitor 2	V/f OLV OLV/PM AOLV/PM EZOLV You can select a maximum of 12 monitors as user monitors and set them to parameters <i>o1-24</i> to <i>o1-35</i> . This parameter sets the user monitor to show on the second line. The registered monitor is also used for different monitor displays of bar graph and waveform.	102 (0, 101 - 999)
o1-26 (11AF) RUN	Custom Monitor 3	V/f OLV OLV/PM AOLV/PM EZOLV You can select a maximum of 12 monitors as user monitors and set them to parameters <i>o1-24</i> to <i>o1-35</i> . This parameter sets the user monitor to show on the third line. The registered monitor is also used for the monitor display of the bar graph.	103 (0, 101 - 999)
o1-27 (11B0) RUN	Custom Monitor 4	V/f OLV OLV/PM AOLV/PM EZOLV You can select a maximum of 12 monitors as user monitors and set them to parameters <i>o1-24</i> to <i>o1-35</i> . This parameter sets the user monitor to show on the fourth line.	0 (0, 101 - 999)
o1-28 (11B1) RUN	Custom Monitor 5	V/f OLV OLV/PM AOLV/PM EZOLV You can select a maximum of 12 monitors as user monitors and set them to parameters <i>o1-24</i> to <i>o1-35</i> . This parameter sets the user monitor to show on the fifth line.	0 (0, 101 - 999)
o1-29 (11B2) RUN	Custom Monitor 6	V/f OLV OLV/PM AOLV/PM EZOLV You can select a maximum of 12 monitors as user monitors and set them to parameters <i>o1-24</i> to <i>o1-35</i> . This parameter sets the user monitor to show on the sixth line.	0 (0, 101 - 999)

No. (Hex.)	Name	Description	Default (Range)
o1-30 (11B3) RUN	Custom Monitor 7	V/f OLV OLV/PM AOLV/PM EZOLV You can select a maximum of 12 monitors as user monitors and set them to parameters o1-24 to o1-35. This parameter sets the user monitor to show on the seventh line.	0 (0, 101 - 999)
o1-31 (11B4) RUN	Custom Monitor 8	V/f OLV OLV/PM AOLV/PM EZOLV You can select a maximum of 12 monitors as user monitors and set them to parameters o1-24 to o1-35. This parameter sets the user monitor to show on the eighth line.	0 (0, 101 - 999)
o1-32 (11B5) RUN	Custom Monitor 9	V/f OLV OLV/PM AOLV/PM EZOLV You can select a maximum of 12 monitors as user monitors and set them to parameters o1-24 to o1-35. This parameter sets the user monitor to show on the ninth line.	0 (0, 101 - 999)
o1-33 (11B6) RUN	Custom Monitor 10	V/f OLV OLV/PM AOLV/PM EZOLV You can select a maximum of 12 monitors as user monitors and set them to parameters o1-24 to o1-35. This parameter sets the user monitor to show on the 10th line.	0 (0, 101 - 999)
o1-34 (11B7) RUN	Custom Monitor 11	V/f OLV OLV/PM AOLV/PM EZOLV You can select a maximum of 12 monitors as user monitors and set them to parameters o1-24 to o1-35. This parameter sets the user monitor to show on the 11th line.	0 (0, 101 - 999)
o1-35 (11B8) RUN	Custom Monitor 12	V/f OLV OLV/PM AOLV/PM EZOLV You can select a maximum of 12 monitors as user monitors and set them to parameters o1-24 to o1-35. This parameter sets the user monitor to show on the 12th line.	0 (0, 101 - 999)
o1-36 (11B9) RUN	LCD Backlight Brightness	V/f OLV OLV/PM AOLV/PM EZOLV Sets the intensity of the LCD keypad backlight.	5 (1 - 5)
o1-37 (11BA) RUN	LCD Backlight ON/OFF Selection	V/f OLV OLV/PM AOLV/PM EZOLV Sets the automatic shut off function for the LCD backlight. 0 : OFF 1 : ON	1 (0, 1)
o1-38 (11BB) RUN	LCD Backlight Off-Delay	V/f OLV OLV/PM AOLV/PM EZOLV Sets the time until the LCD backlight automatically turns off.	60 s (10 - 300 s)
o1-39 (11BC) RUN	Show Initial Setup Screen	V/f OLV OLV/PM AOLV/PM EZOLV Sets the function to show the LCD keypad initial setup screen each time you energize the drive. This parameter is only available with an LCD keypad. 0 : No 1 : Yes	1 (0, 1)
o1-40 (11BD) RUN	Home Screen Display Selection	V/f OLV OLV/PM AOLV/PM EZOLV Sets the monitor display mode for the Home screen. This parameter is only available with an LCD keypad. 0 : Custom Monitor 1 : Bar Graph 2 : Analog Gauge 3 : Trend Plot	0 (0 - 3)
o1-41 (11C1) RUN	1st Monitor Area Selection	V/f OLV OLV/PM AOLV/PM EZOLV Sets the horizontal axis value used to display the monitor set in o1-24 [Custom Monitor 1] as a bar graph. This parameter is only available with an LCD keypad. 0 : +/- Area (- o1-42 ~ o1-42) 1 : + Area (0 ~ o1-42)	0 (0 - 1)
o1-42 (11C2) RUN	1st Monitor Area Setting	V/f OLV OLV/PM AOLV/PM EZOLV Sets the horizontal axis value used to display the monitor set in o1-24 [Custom Monitor 1] as a bar graph. This parameter is only available with an LCD keypad.	100.0% (0.0 - 100.0%)
o1-43 (11C3) RUN	2nd Monitor Area Selection	V/f OLV OLV/PM AOLV/PM EZOLV Selects the horizontal range used to display the monitor set in o1-25 [Custom Monitor 2] as a bar graph. This parameter is only available with an LCD keypad. 0 : +/- Area (- o1-44 ~ o1-44) 1 : + Area (0 ~ o1-44)	0 (0 - 1)
o1-44 (11C4) RUN	2nd Monitor Area Setting	V/f OLV OLV/PM AOLV/PM EZOLV Sets the horizontal axis value used to display the monitor set in o1-25 [Custom Monitor 2] as a bar graph. This parameter is only available with an LCD keypad.	100.0% (0.0 - 100.0%)

1.13 o: Keypad-Related Settings

No. (Hex.)	Name	Description	Default (Range)
o1-45 (11C5) RUN	3rd Monitor Area Selection	V/f OLV OLV/PM AOLV/PM EZOLV Sets the horizontal axis value used to display the monitor set in o1-26 [Custom Monitor 3] as a bar graph. This parameter is only available with an LCD keypad. 0 : +/- Area (- o1-46 ~ o1-46) 1 : + Area (0 ~ o1-46)	0 (0 - 1)
o1-46 (11C6) RUN	3rd Monitor Area Setting	V/f OLV OLV/PM AOLV/PM EZOLV Sets the horizontal axis value used to display the monitor set in o1-26 [Custom Monitor 3] as a bar graph. This parameter is only available with an LCD keypad.	100.0% (0.0 - 100.0%)
o1-47 (11C7) RUN	Trend Plot 1 Scale Minimum Value	V/f OLV OLV/PM AOLV/PM EZOLV Sets the horizontal axis minimum value used to display the monitor set in o1-24 [Custom Monitor 1] as a trend plot. This parameter is only available with an LCD keypad.	-100.0% (-300.0 - +299.9%)
o1-48 (11C8) RUN	Trend Plot 1 Scale Maximum Value	V/f OLV OLV/PM AOLV/PM EZOLV Sets the maximum value for the vertical axis used to display the monitor that was set in o1-24 [Custom Monitor 1] as a trend plot. This parameter is only available with an LCD keypad.	100.0% (-299.9 - +300.0%)
o1-49 (11C9) RUN	Trend Plot 2 Scale Minimum Value	V/f OLV OLV/PM AOLV/PM EZOLV Sets the horizontal axis minimum value used to display the monitor set in o1-25 [Custom Monitor 2] as a trend plot. This parameter is only available with an LCD keypad.	-100.0% (-300.0 - +299.9%)
o1-50 (11CA) RUN	Trend Plot 2 Scale Maximum Value	V/f OLV OLV/PM AOLV/PM EZOLV Sets the maximum value for the vertical axis used to display the monitor that was set in o1-25 [Custom Monitor 2] as a trend plot. This parameter is only available with an LCD keypad.	100.0% (-299.9 - +300.0%)
o1-51 (11CB) RUN	Trend Plot Time Scale Setting	V/f OLV OLV/PM AOLV/PM EZOLV Sets the time scale (horizontal axis) to display the trend plot. When you change this setting, the drive automatically adjusts the data sampling time. This parameter is only available with an LCD keypad.	300 s (1 - 3600 s)
o1-55 (11EE) RUN	Analog Gauge Area Selection	V/f OLV OLV/PM AOLV/PM EZOLV Sets the range used to display the monitor set in o1-24 [Custom Monitor 1] as an analog gauge. This parameter is only available with an LCD keypad. 0 : +/- Area (- o1-56 ~ o1-56) 1 : + Area (0 ~ o1-56)	1 (0, 1)
o1-56 (11EF) RUN	Analog Gauge Area Setting	V/f OLV OLV/PM AOLV/PM EZOLV Sets the value used to display the monitor set in o1-24 [Custom Monitor 1] as an analog meter. This parameter is only available with an LCD keypad.	100.0% (0.0 - 100.0%)
o1-58 (3125)	Motor Power Unit Selection	V/f OLV OLV/PM AOLV/PM EZOLV Sets the setting unit for parameters that set the motor rated power. 0 : kW 1 : HP	1 (0, 1)

◆ o2: Keypad Operation

No. (Hex.)	Name	Description	Default (Range)
o2-01 (0505)	LO/RE Key Function Selection	V/f OLV OLV/PM AOLV/PM EZOLV Sets the function that lets you use LO/RE to switch between LOCAL and REMOTE Modes. 0 : Disabled 1 : Enabled	1 (0, 1)
o2-02 (0506)	STOP Key Function Selection	V/f OLV OLV/PM AOLV/PM EZOLV Sets the function to use  on the keypad to stop the drive when the Run command source for the drive is REMOTE (external) and not assigned to the keypad. 0 : Disabled 1 : Enabled	1 (0, 1)
o2-03 (0507)	User Parameter Default Value	V/f OLV OLV/PM AOLV/PM EZOLV Sets the function to keep the settings of changed parameters as user parameter defaults to use during initialization. 0 : No change 1 : Set defaults 2 : Clear all	0 (0 - 2)
o2-04 (0508)	Drive Model (KVA) Selection	V/f OLV OLV/PM AOLV/PM EZOLV Sets the Drive Model code. Set this parameter after replacing the control board.	Determined by the drive (-)

No. (Hex.)	Name	Description	Default (Range)
o2-05 (0509)	Home Mode Freq Ref Entry Mode	<p>V/f OLV OLV/PM AOLV/PM EZOLV</p> <p>Sets the function that makes it necessary to push  to use the keypad to change the frequency reference value while in Drive Mode.</p> <p>0 : ENTER Key Required 1 : Immediate / MOP-style</p>	0 (0, 1)
o2-06 (050A)	Keypad Disconnect Detection	<p>V/f OLV OLV/PM AOLV/PM EZOLV</p> <p>Sets the function that stops the drive if you disconnect the keypad connection cable from the drive or if you damage the cable while the keypad is the Run command source.</p> <p>0 : Disabled 1 : Enabled</p>	1 (0, 1)
o2-07 (0527)	Keypad RUN Direction @ Power-up	<p>V/f OLV OLV/PM AOLV/PM EZOLV</p> <p>Sets the direction of motor rotation when the drive is energized and the keypad is the Run command source.</p> <p>0 : Forward 1 : Reverse</p>	0 (0, 1)
o2-09 (050D)	Reserved	-	-
o2-19 (061F) Expert	Parameter Write during Uv	<p>V/f OLV OLV/PM AOLV/PM EZOLV</p> <p>Lets you change parameters during Uv [<i>Undervoltage</i>].</p> <p>0 : Disable 1 : Enabled</p>	0 (0, 1)
o2-23 (11F8) RUN	External 24V Powerloss Detection	<p>V/f OLV OLV/PM AOLV/PM EZOLV</p> <p>Sets the function to give a warning if the backup external 24 V power supply turns off when the main circuit power supply is in operation.</p> <p>0 : Disabled 1 : Enabled</p>	0 (0, 1)
o2-26 (1563)	Alarm Display at Ext. 24V Power	<p>V/f OLV OLV/PM AOLV/PM EZOLV</p> <p>When you connect a backup external 24 V power supply, this parameter sets the function to trigger an alarm when the main circuit power supply voltage decreases.</p> <p>Note: The drive will not run when it is operating from one 24-V external power supply.</p> <p>0 : Disabled 1 : Enabled</p>	1 (0, 1)
o2-27 (1565)	bCE Detection Selection	<p>V/f OLV OLV/PM AOLV/PM EZOLV</p> <p>Sets drive operation if the Bluetooth device is disconnected when you operate the drive in Bluetooth Mode.</p> <p>0 : Ramp to Stop 1 : Coast to Stop 2 : Fast Stop (Use C1-09) 3 : Alarm Only 4 : No Alarm Display</p>	3 (0 - 4)

◆ o3: Copy Keypad Function

No. (Hex.)	Name	Description	Default (Range)
o3-01 (0515)	Copy Keypad Function Selection	<p>V/f OLV OLV/PM AOLV/PM EZOLV</p> <p>Sets the function that saves and copies drive parameters to a different drive with the keypad.</p> <p>0 : Copy Select 1 : Backup (drive → keypad) 2 : Restore (keypad → drive) 3 : Verify (check for mismatch) 4 : Erase (backup data of keypad)</p>	0 (0 - 4)
o3-02 (0516)	Copy Allowed Selection	<p>V/f OLV OLV/PM AOLV/PM EZOLV</p> <p>Sets the copy function when o3-01 = 1 [<i>Copy Keypad Function Selection = Backup (drive → keypad)</i>].</p> <p>0 : Disabled 1 : Enabled</p>	0 (0, 1)

1.13 o: Keypad-Related Settings

No. (Hex.)	Name	Description	Default (Range)
o3-04 (0B3E)	Select Backup/Restore Location	<p>V/f OLV OLV/IPM AOLV/IPM EZOLV</p> <p>Sets the storage location for drive parameters when you back up and restore parameters. This parameter is only available when using an LCD keypad.</p> <p>0 : Memory Location 1 1 : Memory Location 2 2 : Memory Location 3 3 : Memory Location 4</p>	0 (0 - 3)
o3-05 (0BDA)	Select Items to Backup/Restore	<p>V/f OLV OLV/IPM AOLV/IPM EZOLV</p> <p>Sets which parameters are backed up, restored, and referenced. This parameter is only available when using an LCD keypad.</p> <p>0 : Standard Parameters 1 : Standard + DWEZ Parameters</p>	1 (0, 1)
o3-06 (0BDE)	Auto Parameter Backup Selection	<p>V/f OLV OLV/IPM AOLV/IPM EZOLV</p> <p>Sets the function that automatically backs up parameters. This parameter is only available when using an LCD keypad.</p> <p>0 : Disabled 1 : Enabled</p>	1 (0, 1)
o3-07 (0BDF)	Auto Parameter Backup Interval	<p>V/f OLV OLV/IPM AOLV/IPM EZOLV</p> <p>Sets the interval at which the automatic parameter backup function saves parameters from the drive to the keypad.</p> <p>Note: This parameter is only available when using an LCD keypad.</p> <p>0 : Every 10 minutes 1 : Every 30 minutes 2 : Every 60 minutes 3 : Every 12 hours</p>	1 (0 - 3)

◆ o4: Maintenance Monitors

No. (Hex.)	Name	Description	Default (Range)
o4-01 (050B)	Elapsed Operating Time Setting	<p>V/f OLV OLV/IPM AOLV/IPM EZOLV</p> <p>Sets the initial value of the cumulative drive operation time in 10-hour units.</p>	0 h (0 - 9999 h)
o4-02 (050C)	Elapsed Operating Time Selection	<p>V/f OLV OLV/IPM AOLV/IPM EZOLV</p> <p>Sets the condition that counts the cumulative operation time.</p> <p>0 : U4-01 Shows Total Power-up Time 1 : U4-01 Shows Total RUN Time</p>	0 (0, 1)
o4-03 (050E)	Fan Operation Time Setting	<p>V/f OLV OLV/IPM AOLV/IPM EZOLV</p> <p>Sets the value from which to start the cumulative drive cooling fan operation time in 10-hour units.</p>	0 h (0 - 9999 h)
o4-05 (051D)	Capacitor Maintenance Setting	<p>V/f OLV OLV/IPM AOLV/IPM EZOLV</p> <p>Sets the U4-05 [<i>CapacitorMaintenance</i>] monitor value.</p>	0% (0 - 150%)
o4-07 (0523)	Softcharge Relay Maintenance Set	<p>V/f OLV OLV/IPM AOLV/IPM EZOLV</p> <p>Sets the U4-06 [<i>PreChargeRelayMainte</i>] monitor value.</p>	0% (0 - 150%)
o4-09 (0525)	IGBT Maintenance Setting	<p>V/f OLV OLV/IPM AOLV/IPM EZOLV</p> <p>Sets the U4-07 [<i>IGBT Maintenance</i>] monitor value.</p>	0% (0 - 150%)
o4-11 (0510)	Fault Trace/History Init (U2/U3)	<p>V/f OLV OLV/IPM AOLV/IPM EZOLV</p> <p>Resets the records of Monitors U2-xx [<i>Fault Trace</i>] and U3-xx [<i>Fault History</i>].</p> <p>0 : Disabled 1 : Enabled</p>	0 (0, 1)
o4-12 (0512)	kWh Monitor Initialization	<p>V/f OLV OLV/IPM AOLV/IPM EZOLV</p> <p>Resets the monitor values for U4-10 [<i>kWh, Lower 4 Digits</i>] and U4-11 [<i>kWh, Upper 5 Digits</i>].</p> <p>0 : No Reset 1 : Reset</p>	0 (0, 1)
o4-13 (0528)	RUN Command Counter @ Initialize	<p>V/f OLV OLV/IPM AOLV/IPM EZOLV</p> <p>Resets the monitor values for U4-02 [<i>Num of Run Commands</i>], U4-24 [<i>Number of Runs (Low)</i>], and U4-25 [<i>Number of Runs (High)</i>].</p> <p>0 : No Reset 1 : Reset</p>	0 (0, 1)

No. (Hex.)	Name	Description	Default (Range)
o4-22 (154F) RUN	Time Format	V/f OLV OLV/PM AOLV/PM EZOLV Sets the time display format. This parameter is only available when using an LCD keypad. 0 : 24 Hour Clock 1 : 12 Hour Clock 2 : 12 Hour JP Clock	1 (0 - 2)
o4-23 (1550) RUN	Date Format	V/f OLV OLV/PM AOLV/PM EZOLV Sets the date display format. This parameter is only available when using an LCD keypad. 0 : YYYY/MM/DD 1 : DD/MM/YYYY 2 : MM/DD/YYYY	2 (0 - 2)
o4-24 (310F) RUN	bAT Detection Selection	V/f OLV OLV/PM AOLV/PM EZOLV Sets the operation when the drive detects <i>bAT</i> [Keypad Battery Low Voltage] and <i>TiM</i> [Keypad Time Not Set]. This parameter is only available when you use an LCD keypad. 0 : Disable 1 : Enable (Alarm Detected) 2 : Enable (Fault Detected)	0 (0 - 2)

◆ o5: Log Function

No. (Hex.)	Name	Description	Default (Range)
o5-01 (1551) RUN	Log Start/Stop Selection	V/f OLV OLV/PM AOLV/PM EZOLV Sets the data log function. This parameter is only available when using an LCD keypad. 0 : OFF 1 : ON	0 (0 - 1)
o5-02 (1552) RUN	Log Sampling Interval	V/f OLV OLV/PM AOLV/PM EZOLV Sets the data log sampling cycle. This parameter is only available when using an LCD keypad.	100 ms (100 - 60000 ms)
o5-03 (1553) RUN	Log Monitor Data 1	V/f OLV OLV/PM AOLV/PM EZOLV Sets the data log monitor. This parameter is only available with an LCD keypad.	101 (000, 101 - 999)
o5-04 (1554) RUN	Log Monitor Data 2	V/f OLV OLV/PM AOLV/PM EZOLV Sets the data log monitor. This parameter is only available when using an LCD keypad.	102 (000, 101 - 999)
o5-05 (1555) RUN	Log Monitor Data 3	V/f OLV OLV/PM AOLV/PM EZOLV Sets the data log monitor. This parameter is only available with an LCD keypad.	103 (000, 101 - 999)
o5-06 (1556) RUN	Log Monitor Data 4	V/f OLV OLV/PM AOLV/PM EZOLV Sets the data log monitor. This parameter is only available with an LCD keypad.	107 (000, 101 - 999)
o5-07 (1557) RUN	Log Monitor Data 5	V/f OLV OLV/PM AOLV/PM EZOLV Sets the data log monitor. This parameter is only available with an LCD keypad.	108 (000, 101 - 999)
o5-08 (1558) RUN	Log Monitor Data 6	V/f OLV OLV/PM AOLV/PM EZOLV Sets the data log monitor. This parameter is only available when using an LCD keypad.	V/f, OLV/PM : 000, OLV, AOLV/PM, EZOLV : 105 (000, 101 - 999)
o5-09 (1559) RUN	Log Monitor Data 7	V/f OLV OLV/PM AOLV/PM EZOLV Sets the data log monitor. This parameter is only available when using an LCD keypad.	110 (000, 101 - 999)
o5-10 (155A) RUN	Log Monitor Data 8	V/f OLV OLV/PM AOLV/PM EZOLV Sets the data log monitor. This parameter is only available with an LCD keypad.	112 (000, 101 - 999)
o5-11 (155B) RUN	Log Monitor Data 9	V/f OLV OLV/PM AOLV/PM EZOLV Sets the data log monitor. This parameter is only available with an LCD keypad.	000 (000, 101 - 999)
o5-12 (155C) RUN	Log Monitor Data 10	V/f OLV OLV/PM AOLV/PM EZOLV Sets the data log monitor. This parameter is only available with an LCD keypad.	000 (000, 101 - 999)

1.14 q: DriveWorksEZ Parameters

◆ q1-01 to qx-xx: Reserved for DriveWorksEZ

No. (Hex.)	Name	Description	Default (Range)
q1-01 to qx-xx (1600 - xxxx)	Reserved for DriveWorksEZ	V/f OLV OLV/PM AOLV/PM EZOLV These parameters are reserved for use with DriveWorksEZ.	Refer to "DriveWorksEZ Operation Manual".

1.15 r: DWEZ Connection 1-20

◆ r1-01 to r1-40: DriveWorksEZ Connection Parameters 1 to 20 (Upper / Lower)

No. (Hex.)	Name	Description	Default (Range)
r1-01 to r1-40: (1840 - 1867)	DriveWorksEZ Connection Parameters 1 to 20 (Upper / Lower)	V/f OLV OLV/PM AOLV/PM EZOLV DriveWorksEZ Connection Parameters 1 to 20 (Upper / Lower)	0 (0 - FFFFH)

1.16 T: Motor Tuning

◆ T0: Tuning Mode Selection

No. (Hex.)	Name	Description	Default (Range)
T0-00 (1197)	Tuning Mode Selection	<p><input type="checkbox"/> V/f <input type="checkbox"/> OLV <input type="checkbox"/> OLV/PM <input type="checkbox"/> AOLV/PM <input type="checkbox"/> EZOLV</p> <p>Sets the type of Auto-Tuning. 0 : Motor Parameter Tuning 1 : Control Tuning</p>	0 (0, 1)

◆ T1: Induction Motor Auto-Tuning

No. (Hex.)	Name	Description	Default (Range)
T1-00 (0700)	Motor 1/Motor 2 Selection	<p><input type="checkbox"/> V/f <input type="checkbox"/> OLV <input type="checkbox"/> OLV/PM <input type="checkbox"/> AOLV/PM <input type="checkbox"/> EZOLV</p> <p>Sets which motor to tune when motor 1/2 switching is enabled. You can only use the keypad to set this parameter. You cannot use external input terminals to set it. Note: This parameter is enabled when $H1-xx = 16$ [Motor 2 Selection] is set. When $H1-xx \neq 16$ the keypad will not show this parameter. 1 : Motor 1 2 : Motor 2</p>	1 (1, 2)
T1-01 (0701)	Auto-Tuning Mode Selection	<p><input type="checkbox"/> V/f <input type="checkbox"/> OLV <input type="checkbox"/> OLV/PM <input type="checkbox"/> AOLV/PM <input type="checkbox"/> EZOLV</p> <p>Sets the type of Auto-Tuning. 0 : Rotational Auto-Tuning 1 : Stationary Auto-Tuning 1 2 : Stationary Line-Line Resistance</p>	Determined by A1-02 (Determined by A1-02)
T1-02 (0702)	Motor Rated Power	<p><input type="checkbox"/> V/f <input type="checkbox"/> OLV <input type="checkbox"/> OLV/PM <input type="checkbox"/> AOLV/PM <input type="checkbox"/> EZOLV</p> <p>Uses the units set in $o1-58$ [Motor Power Unit Selection] to set the motor rated output power.</p>	Determined by o2-04, C6-01 (0.00 - 650.00 HP)
T1-03 (0703)	Motor Rated Voltage	<p><input type="checkbox"/> V/f <input type="checkbox"/> OLV <input type="checkbox"/> OLV/PM <input type="checkbox"/> AOLV/PM <input type="checkbox"/> EZOLV</p> <p>Sets the rated voltage (V) of the motor. Enter the base speed voltage for constant output motors.</p>	Determined by o2-04, C6-01 (200 V Class: 0.0 - 255.5 V, 400 V Class: 0.0 - 511.0 V)
T1-04 (0704)	Motor Rated Current	<p><input type="checkbox"/> V/f <input type="checkbox"/> OLV <input type="checkbox"/> OLV/PM <input type="checkbox"/> AOLV/PM <input type="checkbox"/> EZOLV</p> <p>Sets the rated current (A) of the motor.</p>	Determined by o2-04 (10% to 200% of the drive rated current)
T1-05 (0705)	Motor Base Frequency	<p><input type="checkbox"/> V/f <input type="checkbox"/> OLV <input type="checkbox"/> OLV/PM <input type="checkbox"/> AOLV/PM <input type="checkbox"/> EZOLV</p> <p>Sets the base frequency (Hz) of the motor.</p>	60.0 Hz (0.0 - 590.0 Hz)
T1-06 (0706)	Number of Motor Poles	<p><input type="checkbox"/> V/f <input type="checkbox"/> OLV <input type="checkbox"/> OLV/PM <input type="checkbox"/> AOLV/PM <input type="checkbox"/> EZOLV</p> <p>Sets the number of motor poles.</p>	4 (2 to 120)
T1-07 (0707)	Motor Base Speed	<p><input type="checkbox"/> V/f <input type="checkbox"/> OLV <input type="checkbox"/> OLV/PM <input type="checkbox"/> AOLV/PM <input type="checkbox"/> EZOLV</p> <p>Sets the motor base speed for Auto-Tuning (min^{-1} (r/min)).</p>	1750 min^{-1} (r/min) (0 - 35400 min^{-1} (r/min))
T1-09 (0709)	Motor No-Load Current	<p><input type="checkbox"/> V/f <input type="checkbox"/> OLV <input type="checkbox"/> OLV/PM <input type="checkbox"/> AOLV/PM <input type="checkbox"/> EZOLV</p> <p>Sets the no-load current of the motor.</p>	- (0A - T1-04; max. of 2999.9)
T1-10 (070A)	Motor Rated Slip Frequency	<p><input type="checkbox"/> V/f <input type="checkbox"/> OLV <input type="checkbox"/> OLV/PM <input type="checkbox"/> AOLV/PM <input type="checkbox"/> EZOLV</p> <p>Sets motor rated slip.</p>	- (0.000 - 20.000 Hz)
T1-11 (070B)	Motor Iron Loss	<p><input type="checkbox"/> V/f <input type="checkbox"/> OLV <input type="checkbox"/> OLV/PM <input type="checkbox"/> AOLV/PM <input type="checkbox"/> EZOLV</p> <p>Sets the iron loss to calculate the energy-saving coefficient.</p>	Determined by E2-10 or E4-10 10 (0 - 65535 W)

No. (Hex.)	Name	Description	Default (Range)
T1-12 (0BDB)	Test Mode Selection	<p>V/f <input type="checkbox"/> OLV <input checked="" type="checkbox"/> OLV/PM <input type="checkbox"/> AOLV/PM <input type="checkbox"/> EZOLV <input type="checkbox"/></p> <p>Sets the function to enable Test Mode after Stationary Auto-Tuning. When you can operate the motor with a light load attached after Stationary Auto-Tuning is complete, enable this parameter.</p> <p>Note: You must first set $T1-10 = 0$ [Motor Rated Slip Frequency = 0 Hz] to enable this parameter.</p> <p>0 : No 1 : Yes</p>	0 (0, 1)
T1-13 (0BDC)	No-load voltage	<p>V/f <input type="checkbox"/> OLV <input checked="" type="checkbox"/> OLV/PM <input type="checkbox"/> AOLV/PM <input type="checkbox"/> EZOLV <input type="checkbox"/></p> <p>Sets the no-load voltage of the motor. When the no-load voltage at rated speed is available, for example on the motor test report, set the voltage in this parameter. If the no-load voltage is not available, do not change this parameter.</p> <p>Note:</p> <ul style="list-style-type: none"> To get the same qualities as a Yaskawa 1000-series drive or previous series drive, set this parameter = $T1-03$ [Motor Rated Voltage]. The default setting is different for different models. <ul style="list-style-type: none"> -B001 - B006, 2001 - 2008, 4001 - 4004: $T1-03 \times 0.85$ -B010 - B018, 2010 - 2082, 4005 - 4060: $T1-03 \times 0.90$ 	$T1-03 \times 0.9$ (200 V Class: 0.0 - 255.0 V, 400 V Class: 0.0 - 510.0 V)

◆ T2: PM Motor Auto-Tuning

No. (Hex.)	Name	Description	Default (Range)
T2-01 (0750)	PM Auto-Tuning Selection	<p>V/f <input type="checkbox"/> OLV <input type="checkbox"/> OLV/PM <input checked="" type="checkbox"/> AOLV/PM <input type="checkbox"/> EZOLV <input type="checkbox"/></p> <p>Sets the type of Auto-Tuning for PM motors.</p> <p>0 : Manual Entry w/ Motor Data Sheet 1 : Stationary (Ld, Lq, R) 2 : Stationary (R Only) 4 : Rotational (Ld, Lq, R, back-EMF) 5 : High Frequency Injection</p>	0 (Determined by A1-02)
T2-02 (0751)	PM Motor Code Selection	<p>V/f <input type="checkbox"/> OLV <input type="checkbox"/> OLV/PM <input checked="" type="checkbox"/> AOLV/PM <input type="checkbox"/> EZOLV <input type="checkbox"/></p> <p>If the drive is operating an SMRD, SMRA, or SSR1 series Yaskawa PM motor, enter the PM motor code in to align with the rotation speed and motor output.</p>	FFFF (0000 - FFFF)
T2-03 (0752)	PM Motor Type	<p>V/f <input type="checkbox"/> OLV <input type="checkbox"/> OLV/PM <input checked="" type="checkbox"/> AOLV/PM <input type="checkbox"/> EZOLV <input type="checkbox"/></p> <p>Sets the type of PM motor the drive will operate.</p> <p>0 : IPM motor 1 : SPM motor</p>	1 (0, 1)
T2-04 (0730)	PM Motor Rated Power	<p>V/f <input type="checkbox"/> OLV <input type="checkbox"/> OLV/PM <input checked="" type="checkbox"/> AOLV/PM <input type="checkbox"/> EZOLV <input type="checkbox"/></p> <p>Uses the units set in $o1-58$ [Motor Power Unit Selection] to set the PM motor rated output power.</p>	Determined by $o2-04$, C6-01 (0.00 - 650.00 HP)
T2-05 (0732)	PM Motor Rated Voltage	<p>V/f <input type="checkbox"/> OLV <input type="checkbox"/> OLV/PM <input checked="" type="checkbox"/> AOLV/PM <input type="checkbox"/> EZOLV <input type="checkbox"/></p> <p>Sets the rated voltage (V) of the motor.</p>	200 V Class: 230.0 V, 400 V Class: 460.0 V (200 V Class: 0.0 - 255.0 V, 400 V Class: 0.0 - 510.0 V)
T2-06 (0733)	PM Motor Rated Current	<p>V/f <input type="checkbox"/> OLV <input type="checkbox"/> OLV/PM <input checked="" type="checkbox"/> AOLV/PM <input type="checkbox"/> EZOLV <input type="checkbox"/></p> <p>Sets the rated current (A) of the motor.</p>	Determined by $o2-04$ (10% to 200% of the drive rated current)
T2-07 (0753)	PM Motor Base Frequency	<p>V/f <input type="checkbox"/> OLV <input type="checkbox"/> OLV/PM <input checked="" type="checkbox"/> AOLV/PM <input type="checkbox"/> EZOLV <input type="checkbox"/></p> <p>Sets the base frequency (Hz) of the motor.</p>	60.0 Hz (0.0 - 590.0 Hz)
T2-08 (0734)	Number of PM Motor Poles	<p>V/f <input type="checkbox"/> OLV <input type="checkbox"/> OLV/PM <input checked="" type="checkbox"/> AOLV/PM <input type="checkbox"/> EZOLV <input type="checkbox"/></p> <p>Sets the number of motor poles.</p>	4 (2 - 120)
T2-09 (0731)	PM Motor Base Speed	<p>V/f <input type="checkbox"/> OLV <input type="checkbox"/> OLV/PM <input checked="" type="checkbox"/> AOLV/PM <input type="checkbox"/> EZOLV <input type="checkbox"/></p> <p>Sets the motor base speed (min^{-1} (r/min)).</p>	1750 min^{-1} (r/min) (0 - 34500 min^{-1} (r/min))
T2-10 (0754)	PM Motor Stator Resistance	<p>V/f <input type="checkbox"/> OLV <input type="checkbox"/> OLV/PM <input checked="" type="checkbox"/> AOLV/PM <input type="checkbox"/> EZOLV <input type="checkbox"/></p> <p>Sets the stator resistance for each motor phase.</p> <p>Note: This parameter does not set line-to-line resistance.</p>	Determined by T2-02 (0.000 - 65.000 Ω)
T2-11 (0735)	PM Motor d-Axis Inductance	<p>V/f <input type="checkbox"/> OLV <input type="checkbox"/> OLV/PM <input checked="" type="checkbox"/> AOLV/PM <input type="checkbox"/> EZOLV <input type="checkbox"/></p> <p>Sets the d-axis inductance of the motor on a per phase basis.</p>	Determined by T2-02 (0.00 - 600.00 mH)
T2-12 (0736)	PM Motor q-Axis Inductance	<p>V/f <input type="checkbox"/> OLV <input type="checkbox"/> OLV/PM <input checked="" type="checkbox"/> AOLV/PM <input type="checkbox"/> EZOLV <input type="checkbox"/></p> <p>Sets the q-Axis inductance of the motor on a per phase basis.</p>	Determined by T2-02 (0.00 - 600.00 mH)

1.16 T: Motor Tuning

No. (Hex.)	Name	Description	Default (Range)
T2-13 (0755)	Back-EMF Units Selection	<input type="radio"/> V/f <input type="radio"/> OLV <input checked="" type="radio"/> OLV/PM <input type="radio"/> AOLV/PM <input type="radio"/> EZOLV Sets the units that the drive uses to set the induced voltage constant. 0 : mV/(rev/min) 1 : mV/(rad/sec)	0 (0, 1)
T2-14 (0737)	Back-EMF Voltage Constant (Ke)	<input type="radio"/> V/f <input type="radio"/> OLV <input checked="" type="radio"/> OLV/PM <input type="radio"/> AOLV/PM <input type="radio"/> EZOLV Sets the motor induced voltage constant (Ke).	Determined by T2-13 (0.0 - 2000.0)
T2-15 (0756)	Pull-In Current Level	<input type="radio"/> V/f <input type="radio"/> OLV <input checked="" type="radio"/> OLV/PM <input type="radio"/> AOLV/PM <input type="radio"/> EZOLV Sets the level of the pull-in current as a percentage of E5-03 [PM Motor Rated Current (FLA)]. Usually it is not necessary to change this setting.	30% (0 - 120%)

◆ T3: ASR and Inertia Tuning

No. (Hex.)	Name	Description	Default (Range)
T3-00 (1198)	Control Loop Tuning Selection	<input checked="" type="radio"/> V/f <input type="radio"/> OLV <input checked="" type="radio"/> OLV/PM <input type="radio"/> AOLV/PM <input type="radio"/> EZOLV Sets the type of Control Auto-Tuning. 2 : Deceleration Rate Tuning 3 : KEB Tuning	2 (2, 3)

◆ T4: EZ Tuning



No. (Hex.)	Name	Description	Default (Range)
T4-01 (3130)	EZ Tuning Mode Selection	<input type="radio"/> V/f <input type="radio"/> OLV <input type="radio"/> OLV/PM <input type="radio"/> AOLV/PM <input checked="" type="radio"/> EZOLV Sets the type of Auto-Tuning for EZOLV control. 0 : Motor Parameter Setting 1 : Line-to-Line Resistance	0 (0, 1)
T4-02 (3131)	Motor Type Selection	<input type="radio"/> V/f <input type="radio"/> OLV <input type="radio"/> OLV/PM <input type="radio"/> AOLV/PM <input checked="" type="radio"/> EZOLV Sets the type of motor. 0 : Induction (IM) 1 : Permanent Magnet (PM) 2 : Synchronous Reluctance (SynRM)	0 (0, 1, 2)
T4-04 (3133)	Motor Rated Revolutions	<input type="radio"/> V/f <input type="radio"/> OLV <input type="radio"/> OLV/PM <input type="radio"/> AOLV/PM <input checked="" type="radio"/> EZOLV Sets rated rotation speed (min^{-1}) of the motor.	- ($(40 \text{ Hz to } 120 \text{ Hz}) \times 60 \times 2 / \text{E9-08}$)
T4-05 (3134)	Motor Rated Frequency	<input type="radio"/> V/f <input type="radio"/> OLV <input type="radio"/> OLV/PM <input type="radio"/> AOLV/PM <input checked="" type="radio"/> EZOLV Sets the rated frequency (Hz) of the motor.	Determined by E9-01 and o2-04 (40.0 - 120.0 Hz)
T4-06 (3135)	Motor Rated Voltage	<input type="radio"/> V/f <input type="radio"/> OLV <input type="radio"/> OLV/PM <input type="radio"/> AOLV/PM <input checked="" type="radio"/> EZOLV Sets the rated voltage (V) of the motor.	200 V Class: 230.0 V, 400 V Class: 460.0 V (200 V Class: 0.0 - 255.0 V, 400 V Class: 0.0 - 510.0 V)
T4-07 (3136)	Motor Rated Current	<input type="radio"/> V/f <input type="radio"/> OLV <input type="radio"/> OLV/PM <input type="radio"/> AOLV/PM <input checked="" type="radio"/> EZOLV Sets the rated current (A) of the motor.	Determined by o2-04, C6-01 (10% to 200% of the drive rated current)
T4-08 (3137)	Motor Rated Capacity	<input type="radio"/> V/f <input type="radio"/> OLV <input type="radio"/> OLV/PM <input type="radio"/> AOLV/PM <input checked="" type="radio"/> EZOLV Sets the motor rated power in the units set in o1-58 [Motor Power Unit Selection].	Determined by E9-10 (0.10 - 650.00 HP)
T4-09 (3138)	Number of Poles	<input type="radio"/> V/f <input type="radio"/> OLV <input type="radio"/> OLV/PM <input type="radio"/> AOLV/PM <input checked="" type="radio"/> EZOLV Sets the number of motor poles.	Determined by E9-01 (2 - 120)

1.17 U: Monitors

◆ U1: Operation Status Monitors

No. (Hex.)	Name	Description	MFAO Signal Level
U1-01 (0040)	Frequency Reference	<p>V/f OLV OLV/PM AOLV/PM EZOLV</p> <p>Shows the frequency reference value. Parameter <i>o1-03</i> [Keypad Display Unit Selection] sets the display units. Unit: 0.01 Hz</p>	10 V = Maximum frequency (0 V to +10 V)
U1-02 (0041)	Output frequency	<p>V/f OLV OLV/PM AOLV/PM EZOLV</p> <p>Shows the output frequency. Parameter <i>o1-03</i> [Keypad Display Unit Selection] sets the display units. Unit: 0.01 Hz</p>	10 V = Maximum frequency (0 V to +10 V)
U1-03 (0042)	Output Current	<p>V/f OLV OLV/PM AOLV/PM EZOLV</p> <p>Shows the actual output current. The keypad shows the value of <i>U1-03</i> in amperes (A). When looking at the monitor through MEMOBUS/Modbus communications, the current is "8192 = drive rated current (A)". Calculate the current from the monitor value that is in at MEMOBUS/Modbus communications using "Numerals being displayed / 8192 × drive rated current (A)." Unit: When the drive model changes, the display units for this parameter also change. <ul style="list-style-type: none"> • 0.01 A units: B001 - B018, 2001 - 2042, 4001 - 4023 • 0.1A units: 2056 - 2082, 4031 - 4060 </p>	10 V = Drive rated current
U1-04 (0043)	Control method selection	<p>V/f OLV OLV/PM AOLV/PM EZOLV</p> <p>Shows the drive control method. 0 : V/f Control 2 : Open Loop Vector 5 : PM Open Loop Vector 6 : PM Advanced Open Loop Vector 8 : EZ Vector Control</p>	No signal output available
U1-05 (0044)	Motor Speed	<p>V/f OLV OLV/PM AOLV/PM EZOLV</p> <p>Shows the detected motor speed. Parameter <i>o1-03</i> [Keypad Display Unit Selection] sets the display units. Unit: 0.01 Hz</p>	10 V = Maximum frequency (0 V to +10 V)
U1-06 (0045)	Output Voltage Ref	<p>V/f OLV OLV/PM AOLV/PM EZOLV</p> <p>Shows the output voltage reference. Unit: 0.1 V</p>	200 V Class: 10 V = 200 Vrms 400 V Class: 10 V = 400 Vrms
U1-07 (0046)	DC Bus Voltage	<p>V/f OLV OLV/PM AOLV/PM EZOLV</p> <p>Shows the DC bus voltage. Unit: 1 V</p>	200 V Class: 10 V = 400 V 400 V Class: 10 V = 800 V
U1-08 (0047)	Output Power	<p>V/f OLV OLV/PM AOLV/PM EZOLV</p> <p>Shows the internally-calculated output power. When you change <i>A1-02</i> [Control Method Selection], it will also change the signal level of the analog output. <ul style="list-style-type: none"> • A1-02 = 0: Drive capacity (kW) • A1-02 = 2: Motor Rated Power [E2-11] (kW) • A1-02 = 5, 6: PM Motor Rated Power [E5-02] (kW) • A1-02 = 8: Motor Rated Power [E9-07] (kW) Unit: When the drive model changes, the display units for this parameter also change. <ul style="list-style-type: none"> • 0.01 kW: B001 - B018, 2001 - 2042, 4001 - 4023 • 0.1 kW: 2056 - 2082, 4031 - 4060 </p>	10 V: Drive capacity (motor rated power) kW (0 V to +10 V)
U1-09 (0048)	Torque Reference	<p>V/f OLV OLV/PM AOLV/PM EZOLV</p> <p>Shows the internal torque reference value. Unit: 0.1%</p>	10 V = Motor rated torque (0 V to +10 V)

1.17 U: Monitors



No. (Hex.)	Name	Description	MFAO Signal Level
U1-10 (0049)	Input Terminal Status	<p>V/f OLV OLV/IPM AOLV/IPM EZOLV</p> <p>Shows the status of the MFDO terminal where $\bar{1}$ = ON and 1 = OFF.</p> <p>For example, U1-10 shows  when terminals S1 and S3 are ON.</p> <p>bit0 : Terminal S1 (MFDI 1) bit1 : Terminal S2 (MFDI 2) bit2 : Terminal S3 (MFDI 3) bit3 : Terminal S4 (MFDI 4) bit4 : Terminal S5 (MFDI 5) bit5 : Terminal S6 (MFDI 6) bit6 : Terminal S7 (MFDI 7) bit7 : Not used (normal value of [1]).</p>	No signal output available
U1-11 (004A)	Output Terminal Status	<p>V/f OLV OLV/IPM AOLV/IPM EZOLV</p> <p>Shows the status of the MFDO terminal where $\bar{1}$ = ON and 1 = OFF.</p> <p>For example, U1-11 shows  when terminals MA and P2 are ON.</p> <p>Note: When H2-xx = 100 to 1A7 [U1-11 Inverse U1-11 Output of Function], U1-11 does not show the status in inverse.</p> <p>bit0 : Terminal MA/MB-MC bit1 : Terminal P1-C1 bit2 : Terminal P2-C2 bit3 : Not used (normal value of [1]). bit4 : Not used (normal value of [1]). bit5 : Not used (normal value of [1]). bit6 : Not used (normal value of [1]). bit7 : Not used (normal value of [1]).</p>	No signal output available
U1-12 (004B)	Drive Status	<p>V/f OLV OLV/IPM AOLV/IPM EZOLV</p> <p>Shows drive status where $\bar{1}$ = ON and 1 = OFF.</p> <p>For example, U1-12 shows  during run with the Reverse Run command.</p> <p>bit0 : During Run bit1 : During zero-speed bit2 : During reverse bit3 : During fault reset signal input bit4 : During speed agreement bit5 : Drive Ready bit6 : During minor fault detection bit7 : During fault detection</p>	No signal output available
U1-13 (004E)	Terminal A1 Level	<p>V/f OLV OLV/IPM AOLV/IPM EZOLV</p> <p>Shows the signal level of terminal A1. Unit: 0.1%</p>	10 V = 100% (0 V to +10 V)
U1-14 (004F)	Terminal A2 Level	<p>V/f OLV OLV/IPM AOLV/IPM EZOLV</p> <p>Shows the signal level of terminal A2. Unit: 0.1%</p>	10 V = 100% (0 V to +10 V)
U1-16 (0053)	SFS Output Frequency	<p>V/f OLV OLV/IPM AOLV/IPM EZOLV</p> <p>Shows the output frequency after soft start. Shows the frequency with acceleration and deceleration times and S-curves. Parameter o1-03 [Keypad Display Unit Selection] sets the display units. Unit: 0.01 Hz</p>	10 V = Maximum frequency (0 V to +10 V)
U1-18 (0061)	oPE Fault Parameter	<p>V/f OLV OLV/IPM AOLV/IPM EZOLV</p> <p>Shows the parameter number that caused the oPE02 [Parameter Range Setting Error] or oPE08 [Parameter Selection Error].</p>	No signal output available

No. (Hex.)	Name	Description	MFAO Signal Level
U1-19 (0066)	MEMOBUS/Modbus Error Code	<p>V/f OLV OLV/PM AOLV/PM EZOLV</p> <p>Shows the contents of the MEMOBUS/Modbus communication error where i = "error" and t = "no error".</p> <p>For example, U1-19 shows  when the drive detects a CRC error.</p> <p>bit0 : CRC Error bit1 : Data Length Error</p> <p>bit2 : Not used (normal value of [t]). bit3 : Parity Error bit4 : Overrun Error bit5 : Framing Error bit6 : Timed Out bit7 : Not used (normal value of [t]).</p>	No signal output available
U1-24 (007D)	Input Pulse Monitor	<p>V/f OLV OLV/PM AOLV/PM EZOLV</p> <p>Shows the frequency to pulse train input terminal RP. Unit: 1 Hz</p>	Determined by H6-02
U1-25 (004D)	Software number	<p>V/f OLV OLV/PM AOLV/PM EZOLV</p> <p>Shows the ID.</p>	No signal output available
U1-26 (005B)	SoftwareNumber ROM	<p>V/f OLV OLV/PM AOLV/PM EZOLV</p> <p>Shows the ROM ID.</p>	No signal output available
U1-50 (1199) Expert	Virtual Analog Input	<p>V/f OLV OLV/PM AOLV/PM EZOLV</p> <p>Shows the virtual analog input value.</p>	Determined by H7-40

◆ U2: Fault Trace

No. (Hex.)	Name	Description	MFAO Signal Level
U2-01 (0080)	Current Fault	<p>V/f OLV OLV/PM AOLV/PM EZOLV</p> <p>Shows the fault that the drive has when viewing the monitor.</p>	No signal output available
U2-02 (0081)	Previous Fault	<p>V/f OLV OLV/PM AOLV/PM EZOLV</p> <p>Shows the fault that occurred most recently.</p>	No signal output available
U2-03 (0082)	Freq Reference@Fault	<p>V/f OLV OLV/PM AOLV/PM EZOLV</p> <p>Shows the frequency reference at the fault that occurred most recently. Use U1-01 [Frequency Reference] to monitor the frequency reference value. Unit: 0.01 Hz</p>	No signal output available
U2-04 (0083)	Output Freq @ Fault	<p>V/f OLV OLV/PM AOLV/PM EZOLV</p> <p>Shows the output frequency at the fault that occurred most recently. Use U1-02 [Output Frequency] to monitor the actual output frequency. Unit: 0.01 Hz</p>	No signal output available
U2-05 (0084)	Output Current@Fault	<p>V/f OLV OLV/PM AOLV/PM EZOLV</p> <p>Shows the output current at the fault that occurred most recently. Use U1-03 [Output Current] to monitor the actual output current. The keypad shows the value of U1-03 in amperes (A). When looking at the monitor through MEMOBUS/Modbus communications, the current is "8192 = drive rated current (A)". Calculate the current from the monitor value that is in at MEMOBUS/Modbus communications using "Numerals being displayed / 8192 × drive rated current (A)." Unit: When the drive model changes, the display units for this parameter also change. • 0.01 A units: B001 - B018, 2001 - 2042, 4001 - 4023 • 0.1A units: 2056 - 2082, 4031 - 4060</p>	No signal output available
U2-06 (0085)	Motor Speed @ Fault	<p>V/f OLV OLV/PM AOLV/PM EZOLV</p> <p>Shows the motor speed at the fault that occurred most recently. Use U1-05 [Motor Speed] to monitor the motor speed. Unit: 0.01 Hz</p>	No signal output available
U2-07 (0086)	Output Voltage@Fault	<p>V/f OLV OLV/PM AOLV/PM EZOLV</p> <p>Shows the output voltage reference at the fault that occurred most recently. Use U1-06 [Output Voltage Ref] to monitor the output voltage reference. Unit: 0.1 V</p>	No signal output available

1.17 U: Monitors

No. (Hex.)	Name	Description	MFAO Signal Level
U2-08 (0087)	DC Bus Voltage@Fault	<p>V/f OLV OLV/PM AOLV/PM EZOLV</p> <p>Shows the DC bus voltage at the fault that occurred most recently. Use <i>U1-07 [DC Bus Voltage]</i> to monitor the DC bus voltage. Unit: 1 V</p>	No signal output available
U2-09 (0088)	Output Power @ Fault	<p>V/f OLV OLV/PM AOLV/PM EZOLV</p> <p>Shows the output power at the fault that occurred most recently. Use <i>U1-08 [Output Power]</i> to monitor the output power. Unit: 0.1 kW</p>	No signal output available
U2-10 (0089)	Torque Ref @ Fault	<p>V/f OLV OLV/PM AOLV/PM EZOLV</p> <p>Shows the torque reference at the fault that occurred most recently as a percentage of the motor rated torque. Use <i>U1-09 [Torque Reference]</i> to monitor the torque reference. Unit: 0.1%</p>	No signal output available
U2-11 (008A)	Input Terminal Status @ Fault	<p>V/f OLV OLV/PM AOLV/PM EZOLV</p> <p>Shows the status of the MFDI terminals at the most recent fault where $\bar{1}$ = ON and 1 = OFF.</p> <p>For example, <i>U2-11</i> shows  when terminals S1 and S3 are ON. Use <i>U1-10 [Input Terminal Status]</i> to monitor the actual MFDI terminal status.</p> <p>bit0 : Terminal S1 bit1 : Terminal S2 bit2 : Terminal S3 bit3 : Terminal S4 bit4 : Terminal S5 bit5 : Terminal S6 bit6 : Terminal S7 bit7 : Not used (normal value of [1]).</p>	No signal output available
U2-12 (008B)	Output Terminal Status @ Fault	<p>V/f OLV OLV/PM AOLV/PM EZOLV</p> <p>Shows the status of the MFDO terminals at the most recent fault where $\bar{1}$ = ON and 1 = OFF.</p> <p>For example, <i>U2-12</i> shows  when terminals MA and P2 are ON. Use <i>U1-11 [Output Terminal Status]</i> to monitor the actual MFDO terminal status.</p> <p>bit0 : Terminal MA/MB-MC bit1 : Terminal P1-C1 bit2 : Terminal P2-C2 bit3 : Not used (normal value of [1]). bit4 : Not used (normal value of [1]). bit5 : Not used (normal value of [1]). bit6 : Not used (normal value of [1]). bit7 : Not used (normal value of [1]).</p>	No signal output available
U2-13 (008C)	Operation Status @ Fault	<p>V/f OLV OLV/PM AOLV/PM EZOLV</p> <p>Shows the status of the MFDO terminals at the most recent fault where $\bar{1}$ = ON and 1 = OFF.</p> <p>For example, <i>U2-13</i> shows  during run. Use <i>U1-12 [Drive Status]</i> to monitor the actual MFDO terminal status.</p> <p>bit0 : During Run bit1 : During zero-speed bit2 : During reverse bit3 : During fault reset signal input bit4 : During speed agreement bit5 : Drive Ready bit6 : During minor fault detection bit7 : During fault detection</p>	No signal output available
U2-14 (008D)	Elapsed Time @ Fault	<p>V/f OLV OLV/PM AOLV/PM EZOLV</p> <p>Shows the cumulative operation time of the drive at the fault that occurred most recently. Use <i>U4-01 [Cumulative Ope Time]</i> to monitor the cumulative operation time. Unit: 1 h</p>	No signal output available

No. (Hex.)	Name	Description	MFAO Signal Level
U2-15 (07E0)	SFS Output @ Fault	V/f OLV OLV/PM AOLV/PM EZOLV Shows the output frequency after soft start at the fault that occurred most recently. Use U1-16 [SFS Output Frequency] to monitor the output frequency after soft start. Unit: 0.01 Hz	No signal output available
U2-16 (07E1)	q-Axis Current@Fault	V/f OLV OLV/PM AOLV/PM EZOLV Shows the q-Axis current of the motor at the fault that occurred most recently. Use U6-01 [Iq Secondary Current] to monitor the q-Axis current of the motor. Unit: 0.1 %	No signal output available
U2-17 (07E2)	d-Axis Current@Fault	V/f OLV OLV/PM AOLV/PM EZOLV Shows the d-Axis current of the motor at the fault that occurred most recently. Use U6-02 [Id ExcitationCurrent] to monitor the d-Axis current of the motor. Unit: 0.1%	No signal output available
U2-19 (07E4)	ControlDeviation@Flt	V/f OLV OLV/PM AOLV/PM EZOLV Shows the amount of control axis deviation ($\Delta\theta$) at the fault that occurred most recently. Use U6-10 [ContAxisDeviation $\Delta\theta$] to monitor the actual amount of control axis deviation ($\Delta\theta$). Unit: 0.1 °	No signal output available
U2-20 (008E)	Heatsink Temp @Fault	V/f OLV OLV/PM AOLV/PM EZOLV Shows the heatsink temperature at the fault that occurred most recently. Use U4-08 [Heatsink Temperature] to monitor the temperature of the heatsink. Unit: 1 °C	No signal output available
U2-21 (1166) Expert	STPo Detect @ Fault	V/f OLV OLV/PM AOLV/PM EZOLV Monitors conditions to detect STPo [Motor Step-Out Detected] faults. The bit for each condition is shown as \uparrow = ON or \downarrow = OFF. For example, U2-21 shows  when the drive detects excessive current. bit0 : Excessive current bit1 : Induced voltage deviation bit2 : d-axis current deviation bit3 : Motor lock at startup bit4 : Acceleration stall continue bit5 : Acceleration stall repeat bit6 : Not used (normal value of [\downarrow]). bit7 : Not used (normal value of [\downarrow]).	No signal output available

◆ U3: Fault History

No. (Hex.)	Name	Description	MFAO Signal Level
U3-01 (0090)	1st MostRecent Fault	V/f OLV OLV/PM AOLV/PM EZOLV Shows the fault history of the most recent fault. Note: The drive saves this fault history to two types of registers at the same time for the MEMOBUS/Modbus communications.	No signal output available
U3-02 (0091)	2nd MostRecent Fault	V/f OLV OLV/PM AOLV/PM EZOLV Shows the fault history of the second most recent fault. Note: The drive saves this fault history to two types of registers at the same time for the MEMOBUS/Modbus communications.	No signal output available
U3-03 (0092)	3rd MostRecent Fault	V/f OLV OLV/PM AOLV/PM EZOLV Shows the fault history of the third most recent fault. Note: The drive saves this fault history to two types of registers at the same time for the MEMOBUS/Modbus communications.	No signal output available
U3-04 (0093)	4th MostRecent Fault	V/f OLV OLV/PM AOLV/PM EZOLV Shows the fault history of the fourth most recent fault. Note: The drive saves this fault history to two types of registers at the same time for the MEMOBUS/Modbus communications.	No signal output available
U3-05 (0804)	5th MostRecent Fault	V/f OLV OLV/PM AOLV/PM EZOLV Shows the fault history of the fifth most recent fault.	No signal output available

1.17 U: Monitors

No. (Hex.)	Name	Description	MFAO Signal Level
U3-06 (0805)	6th MostRecent Fault	V/f OLV OLV/PM AOLV/PM EZOLV Shows the fault history of the sixth most recent fault.	No signal output available
U3-07 (0806)	7th MostRecent Fault	V/f OLV OLV/PM AOLV/PM EZOLV Shows the fault history of the seventh most recent fault.	No signal output available
U3-08 (0807)	8th MostRecent Fault	V/f OLV OLV/PM AOLV/PM EZOLV Shows the fault history of the eighth most recent fault.	No signal output available
U3-09 (0808)	9th MostRecent Fault	V/f OLV OLV/PM AOLV/PM EZOLV Shows the fault history of the ninth most recent fault.	No signal output available
U3-10 (0809)	10th MostRecentFault	V/f OLV OLV/PM AOLV/PM EZOLV Shows the fault history of the tenth most recent fault.	No signal output available
U3-11 (0094)	ElapsedTime@1stFault	V/f OLV OLV/PM AOLV/PM EZOLV Shows the cumulative operation time when the most recent fault occurred. Note: The drive saves this cumulative operation time to two types of registers at the same time for the MEMOBUS/Modbus communications. Unit: 1 h	No signal output available
U3-12 (0095)	ElapsedTime@2ndFault	V/f OLV OLV/PM AOLV/PM EZOLV Shows the cumulative operation time when the second most recent fault occurred. Note: The drive saves this cumulative operation time to two types of registers at the same time for the MEMOBUS/Modbus communications. Unit: 1 h	No signal output available
U3-13 (0096)	ElapsedTime@3rdFault	V/f OLV OLV/PM AOLV/PM EZOLV Shows the cumulative operation time when the third most recent fault occurred. Note: The drive saves this cumulative operation time to two types of registers at the same time for the MEMOBUS/Modbus communications. Unit: 1 h	No signal output available
U3-14 (0097)	ElapsedTime@4thFault	V/f OLV OLV/PM AOLV/PM EZOLV Shows the cumulative operation time when the fourth most recent fault occurred. Note: The drive saves this cumulative operation time to two types of registers at the same time for the MEMOBUS/Modbus communications. Unit: 1 h	No signal output available
U3-15 (080E)	ElapsedTime@5thFault	V/f OLV OLV/PM AOLV/PM EZOLV Shows the cumulative operation time when the fifth most recent fault occurred. Unit: 1 h	No signal output available
U3-16 (080F)	ElapsedTime@6thFault	V/f OLV OLV/PM AOLV/PM EZOLV Shows the cumulative operation time when the sixth most recent fault occurred. Unit: 1 h	No signal output available
U3-17 (0810)	ElapsedTime@7thFault	V/f OLV OLV/PM AOLV/PM EZOLV Shows the cumulative operation time when the seventh most recent fault occurred. Unit: 1 h	No signal output available
U3-18 (0811)	ElapsedTime@8thFault	V/f OLV OLV/PM AOLV/PM EZOLV Shows the cumulative operation time when the eighth most recent fault occurred. Unit: 1 h	No signal output available
U3-19 (0812)	ElapsedTime@9thFault	V/f OLV OLV/PM AOLV/PM EZOLV Shows the cumulative operation time when the ninth most recent fault occurred. Unit: 1 h	No signal output available
U3-20 (0813)	ElapsedTime@10 Fault	V/f OLV OLV/PM AOLV/PM EZOLV Shows the cumulative operation time when the tenth most recent fault occurred. Unit: 1 h	No signal output available

◆ U4: Maintenance Monitors

No. (Hex.)	Name	Description	MFAO Signal Level
U4-01 (004C)	Cumulative Ope Time	<p>V/f OLV OLV/PM AOLV/PM EZOLV</p> <p>Shows the cumulative operation time of the drive.</p> <p>Use parameter <i>o4-01 [Elapsed Operating Time Setting]</i> to reset this monitor. Use parameter <i>o4-02 [Elapsed Operating Time Selection]</i> to select the cumulative operation times from:</p> <ul style="list-style-type: none"> The time from when the drive is energized until it is de-energized. The time at which the Run command is turned ON. <p>The maximum value that the monitor will show is <i>99999</i>. After this value is more than <i>99999</i>, the drive automatically resets it and starts to count from <i>0</i> again.</p> <p>Unit: 1 h</p> <p>Note: The MEMOBUS/Modbus communication data is shown in 10 h units. Use register 0099H for data in 1 h units.</p>	10 V: 99999 h
U4-02 (0075)	Num of Run Commands	<p>V/f OLV OLV/PM AOLV/PM EZOLV</p> <p>Shows how many times that the drive has received a Run command.</p> <p>Use parameter <i>o4-13 [RUN Command Counter @ Initialize]</i> to reset this monitor. The maximum value that the monitor will show is <i>65535</i>. After this value is more than <i>65535</i>, the drive automatically resets it and starts to count from <i>0</i> again.</p> <p>Unit: 1</p>	10 V: 65535 times
U4-03 (0067)	Cooling Fan Ope Time	<p>V/f OLV OLV/PM AOLV/PM EZOLV</p> <p>Shows the cumulative operation time of the cooling fans.</p> <p>Use parameter <i>o4-03 [Fan Operation Time Setting]</i> to reset this monitor. The maximum value that the monitor will show is <i>99999</i>. After this value is more than <i>99999</i>, the drive automatically resets it and starts to count from <i>0</i> again.</p> <p>Unit: 1 h</p> <p>Note: The MEMOBUS/Modbus communication data is shown in 10 h units. Use register 009BH for data in 1 h units.</p>	10 V: 99999 h
U4-04 (007E)	Cool Fan Maintenance	<p>V/f OLV OLV/PM AOLV/PM EZOLV</p> <p>Shows the cumulative operation time of the cooling fans as a percentage of the estimated performance life of the cooling fans.</p> <p>The default value is 0. The value counts up from 0.</p> <p>Use <i>o4-03 [Fan Operation Time Setting]</i> to reset this monitor.</p> <p>Unit: 1%</p> <p>Note: Replace the cooling fans when this monitor is at 90%.</p>	10 V: 100%
U4-05 (007C)	CapacitorMaintenance	<p>V/f OLV OLV/PM AOLV/PM EZOLV</p> <p>Shows the operation time of the electrolytic capacitors for the main circuit and control circuit as a percentage of the estimated performance life of the electrolytic capacitors.</p> <p>The default value is 0. The value counts up from 0.</p> <p>Use <i>o4-05 [Capacitor Maintenance Setting]</i> to reset this monitor.</p> <p>Unit: 1%</p> <p>Note: Replace the electrolytic capacitor when this monitor is at 90%.</p>	10 V: 100%
U4-06 (07D6)	PreChargeRelayMainte	<p>V/f OLV OLV/PM AOLV/PM EZOLV</p> <p>Shows the operation time of the soft charge bypass relay as a percentage of the estimated performance life of the soft charge bypass relay.</p> <p>The default value is 0. The value counts up from 0.</p> <p>Use <i>o4-07 [Softcharge Relay Maintenance Set]</i> to reset this monitor.</p> <p>Unit: 1%</p> <p>Note: Replace the drive when this monitor is at 90%.</p>	10 V: 100%
U4-07 (07D7)	IGBT Maintenance	<p>V/f OLV OLV/PM AOLV/PM EZOLV</p> <p>Shows the operation time of the IGBTs as a percentage of the estimated performance life of the IGBTs.</p> <p>The default value is 0. The value counts up from 0.</p> <p>Use <i>o4-09 [IGBT Maintenance Setting]</i> to reset this monitor.</p> <p>Unit: 1%</p> <p>Note: Replace the drive when this monitor is at 90%.</p>	10 V: 100%
U4-08 (0068)	Heatsink Temperature	<p>V/f OLV OLV/PM AOLV/PM EZOLV</p> <p>Shows the heatsink temperature of the drive.</p> <p>Unit: 1 °C</p>	10 V: 100 °C

1.17 U: Monitors

No. (Hex.)	Name	Description	MFAO Signal Level
U4-09 (005E)	LED Check	<p>V/f OLV OLV/PM AOLV/PM EZOLV</p> <p>Turns on all of the keypad LEDs to make sure that the LEDs operate correctly.</p> <p>1. With <i>U4-09</i> displayed, press . All LEDs on the keypad will turn on.</p> <p>Note: When Safety input 2 CH is open (STo), READY will flash.</p>	No signal output available
U4-10 (005C)	kWh, Lower 4 Digits	<p>V/f OLV OLV/PM AOLV/PM EZOLV</p> <p>Shows the lower 4 digits of the watt hour value for the drive. Unit: 1 kWh</p> <p>Note: The watt hour is displayed in 9 digits. Monitor <i>U4-11 [kWh, Upper 5 Digits]</i> shows the upper 5 digits and <i>U4-10</i> shows the lower 4 digits. Example for 12345678.9 kWh: <i>U4-10</i>: 678.9 kWh <i>U4-11</i>: 12345 MWh</p>	No signal output available
U4-11 (005D)	kWh, Upper 5 Digits	<p>V/f OLV OLV/PM AOLV/PM EZOLV</p> <p>Shows the upper 5 digits of the watt hour value for the drive. Unit: 1 MWh</p> <p>Note: Monitor <i>U4-11</i> shows the upper 5 digits and <i>U4-10 [kWh, Lower 4 Digits]</i> shows the lower 4 digits. Example for 12345678.9 kWh: <i>U4-10</i>: 678.9 kWh <i>U4-11</i>: 12345 MWh</p>	No signal output available
U4-13 (07CF)	Peak Hold Current	<p>V/f OLV OLV/PM AOLV/PM EZOLV</p> <p>Shows the hold value of the peak value (rms) for the drive output current. Use <i>U4-14 [PeakHold Output Freq]</i> to show the drive output frequency at the time that the drive holds the output current. The drive will hold the peak hold current at the next start up and restart of the power supply. The drive keeps the value that was under hold during baseblock (during stop). The keypad shows the value of <i>U4-13</i> in amperes (A). When looking at the monitor through MEMOBUS/Modbus communications, the current is "8192 = drive rated current (A)". Calculate the current from the monitor value that is in at MEMOBUS/Modbus communications using "Numerals being displayed / 8192 × drive rated current (A)." Unit: When the drive model changes, the display units for this parameter also change. • 0.01 A units: B001 - B018, 2001 - 2042, 4001 - 4023 • 0.1A units: 2056 - 2082, 4031 - 4060</p>	No signal output available
U4-14 (07D0)	PeakHold Output Freq	<p>V/f OLV OLV/PM AOLV/PM EZOLV</p> <p>Shows the output frequency at which the peak value (rms) of the drive output current is held. The peak hold current can be monitored by <i>U4-13 [Peak Hold Current]</i>. The peak hold output frequency will be cleared at the next startup and restart of the power supply. The drive keeps the value that was under hold during baseblock (during stop). Unit: 0.01 Hz</p>	No signal output available
U4-16 (07D8)	Motor oL1 Level	<p>V/f OLV OLV/PM AOLV/PM EZOLV</p> <p>Shows the integrated value of <i>oL1 [Motor Overload]</i> as a percentage of <i>oL1</i> detection level. Unit: 0.1%</p>	10 V: 100%
U4-18 (07DA)	Reference Source	<p>V/f OLV OLV/PM AOLV/PM EZOLV</p> <p>Shows the selected frequency reference source. The keypad shows the frequency reference source as "XY-nn" as specified by these rules: X: External Reference 1/2 Selection [H1-xx = 2] selection status • 1: <i>b1-01 [Frequency Reference Selection 1]</i> • 2: <i>b1-15 [Frequency Reference Selection 2]</i> Y-nn: Frequency reference source • 0-01: Keypad (<i>d1-01 [Reference 1]</i>) • 1-00: Analog input (unassigned) • 1-01: MFAI terminal A1 • 1-02: MFAI terminal A2 • 2-02 to 2-17: Multi-step speed reference (<i>d1-02 to d1-17 [Reference 2 to 16, Jog Reference]</i>) • 3-01: MEMOBUS/Modbus communications • 4-01: Communication option card • 5-01: Pulse train input • 7-01: DriveWorksEZ • 9-01: Up/Down command</p>	No signal output available

No. (Hex.)	Name	Description	MFAO Signal Level
U4-19 (07DB)	Modbus FreqRef (dec)	<p>V/f OLV OLV/PM AOLV/PM EZOLV</p> <p>Shows the frequency reference sent to the drive from the MEMOBUS/Modbus communications as a decimal. Unit: 0.01%</p>	10 V: Maximum frequency (0 V to +10 V)
U4-20 (07DC)	Option Freq Ref(dec)	<p>V/f OLV OLV/PM AOLV/PM EZOLV</p> <p>Shows the frequency reference sent to the drive from the communication option as a decimal. Unit: 0.01 %</p>	10 V: Maximum frequency (0 V to +10 V)
U4-21 (07DD)	Run Command Source	<p>V/f OLV OLV/PM AOLV/PM EZOLV</p> <p>Shows the selected Run command source. The keypad shows the Run command source as "XY-nn" as specified by these rules: X: External Reference 1/2 Selection [H1-xx = 2] selection status • 1: b1-02 [Run Command Selection 1] • 2: b1-16 [Run Command Selection 2] Y: Run command source • 0: Keypad • 1: Control circuit terminal • 3: MEMOBUS/Modbus communications • 4: Communication option card • 7: DriveWorksEZ nn: Run command limit status data • 00: No limit status. • 01: The Run command was left ON when the drive stopped in the Programming Mode. • 02: The Run command was left ON when switching from LOCAL Mode to REMOTE Mode. • 03: The Run command is in standby after the drive was energized until the soft charge bypass contactor turns ON. Note: The drive will detect <i>Uv1</i> [DC Bus Undervoltage] or <i>Uv</i> [Undervoltage] if the soft charge bypass contactor does not turn ON after 10 s. • 04: Restart after run stop is prohibited. • 05: Fast stop has been executed using the MFDI terminal. Or, the motor has ramped to stop by pressing the STOP key on the keypad. • 06: b1-17 = 0 [Run Command at Power Up = Disregard Existing RUN Command] is set. • 07: During baseblock while coast to stop with timer. • 08: Frequency reference is below E1-09 [Minimum Output Frequency] during baseblock. • 09: Waiting for the Enter command from PLC.</p>	No signal output The keypad shows the Run command source as "XY-nn" as specified by these rules: available
U4-22 (07DE)	Modbus CmdData (hex)	<p>V/f OLV OLV/PM AOLV/PM EZOLV</p> <p>Shows the operation signal (register 0001H) sent to the drive from MEMOBUS/Modbus communications as a 4-digit hexadecimal number (zero suppress). The keypad shows the operation signal as specified by these rules: bit 0 : Forward run/Stop bit 1 : Reverse run/Stop bit 2 : External fault bit 3 : Fault Reset Procedure bit 4 : Multi-function input 1 bit 5 : Multi-function input 2 bit 6 : Multi-function input 3 bit 7 : Multi-function input 4 bit 8 : Multi-function input 5 bit 9 : Multi-function input 6 bit A : Multi-function input 7 bit B : Not used (normal value of 0). bit C : Not used (normal value of 0). bit D : Not used (normal value of 0). bit E : Not used (normal value of 0). bit F : Not used (normal value of 0).</p>	No signal output available

1.17 U: Monitors

No. (Hex.)	Name	Description	MFAO Signal Level
U4-23 (07DF)	Option CmdData (hex)	<p>V/f OLV OLV/PM AOLV/PM EZOLV</p> <p>Shows the operation signal (register 0001H) sent to the drive from MEMOBUS/Modbus communications as a 4-digit hexadecimal number.</p> <p>The keypad shows the operation signal as specified by these rules:</p> <ul style="list-style-type: none"> bit 0 : Forward run/Stop bit 1 : Reverse run/Stop bit 2 : External fault bit 3 : Fault Reset Procedure bit 4 : Multi-function input 1 bit 5 : Multi-function input 2 bit 6 : Multi-function input 3 bit 7 : Multi-function input 4 bit 8 : Multi-function input 5 bit 9 : Multi-function input 6 bit A : Multi-function input 7 bit B : Not used (normal value of 0). bit C : Not used (normal value of 0). bit D : Not used (normal value of 0). bit E : Not used (normal value of 0). bit F : Not used (normal value of 0). 	No signal output available
U4-24 (07E6)	Number of Runs (Low)	<p>V/f OLV OLV/PM AOLV/PM EZOLV</p> <p>Shows the lower 4 digits of the drive run count.</p> <p>Note: The drive run count is an 8-digit number. Monitor <i>U4-25 [Number of Runs(High)]</i> shows the upper 4 digits and <i>U4-24</i> shows the lower 4 digits.</p>	No signal output available
U4-25 (07E7)	Number of Runs(High)	<p>V/f OLV OLV/PM AOLV/PM EZOLV</p> <p>Shows the upper 4 digits of the drive run count.</p> <p>Note: The drive run count is an 8-digit number. Monitor <i>U4-25</i> shows the upper 4 digits and <i>U4-24 [Number of Runs (Low)]</i> shows the lower 4 digits.</p>	No signal output available
U4-52 (1592)	Torque Ref from Comm	<p>V/f OLV OLV/PM AOLV/PM EZOLV</p> <p>Shows the torque reference that the drive received from a serial communication option card or from MEMOBUS/Modbus communications as a decimal number.</p> <p>Unit: 0.1%</p>	10 V: 100% (0 V to +10 V)

◆ U5: PID Monitors

No. (Hex.)	Name	Description	MFAO Signal Level
U5-01 (0057)	PID Feedback	<p>V/f OLV OLV/PM AOLV/PM EZOLV</p> <p>Shows the PID control feedback value. Parameter <i>b5-20 [PID Unit Selection]</i> sets the display units.</p> <p>Unit: 0.01%</p>	10 V: Maximum frequency (0 V to +10 V)
U5-02 (0063)	PID Input	<p>V/f OLV OLV/PM AOLV/PM EZOLV</p> <p>Shows the change between the PID setpoint and PID feedback (the quantity of PID input) as a percentage of the maximum output frequency.</p> <p>Unit: 0.01%</p>	10 V: Maximum frequency (0 V to +10 V)
U5-03 (0064)	PID Output	<p>V/f OLV OLV/PM AOLV/PM EZOLV</p> <p>Shows the PID control output as a percentage of the maximum output frequency.</p> <p>Unit: 0.01%</p>	10 V: Maximum frequency (0 V to +10 V)
U5-04 (0065)	PID Setpoint	<p>V/f OLV OLV/PM AOLV/PM EZOLV</p> <p>Shows the PID setpoint. Parameter <i>b5-20 [PID Unit Selection]</i> sets the display units.</p> <p>Unit: 0.01%</p>	10 V: Maximum frequency (0 V to +10 V)
U5-05 (07D2)	PID DifferentialFdbk	<p>V/f OLV OLV/PM AOLV/PM EZOLV</p> <p>Shows the PID differential feedback value as a percentage of the maximum output frequency.</p> <p>Set <i>H3-02</i> or <i>H3-10 = 16 [MFAI Function Selection = Differential PID Feedback]</i> to enable this monitor.</p> <p>Unit: 0.01%</p>	10 V: Maximum frequency (0 V to +10 V)
U5-06 (07D3)	PID Fdbk-Diff PID Fdbk	<p>V/f OLV OLV/PM AOLV/PM EZOLV</p> <p>Shows the difference from calculating <i>U5-05 - U5-01 [PID DifferentialFdbk] - [PID Feedback]</i>.</p> <p>Unit: 0.01%</p> <p>Note: <i>U5-01 [PID Feedback] = U5-06</i> when <i>H3-02</i> or <i>H3-10 ≠ 16 [MFAI Function Selection ≠ Differential PID Feedback]</i>.</p>	10 V: Maximum frequency (0 V to +10 V)

No. (Hex.)	Name	Description	MFAO Signal Level
U5-21 (0872) Expert	Energy Save Coeff Ki	<input type="checkbox"/> V/f <input type="checkbox"/> OLV <input type="checkbox"/> OLV/PM <input type="checkbox"/> AOLV/PM <input type="checkbox"/> EZOLV Shows the energy-saving coefficient Ki value for PM. Unit: 0.01	No signal output available
U5-22 (0873) Expert	Energy Save Coeff Kt	<input type="checkbox"/> V/f <input type="checkbox"/> OLV <input type="checkbox"/> OLV/PM <input type="checkbox"/> AOLV/PM <input type="checkbox"/> EZOLV Shows the energy-saving coefficient Kt value for PM. Unit: 0.01	No signal output available
U5-99 (1599)	PID Setpoint Command	<input checked="" type="checkbox"/> V/f <input type="checkbox"/> OLV <input type="checkbox"/> OLV/PM <input type="checkbox"/> AOLV/PM <input type="checkbox"/> EZOLV Shows the PID setpoint command. Parameter b5-20 [PID Unit Selection] sets the display units. Unit: 0.01%	10 V: Maximum frequency (0 V to +10 V)

◆ U6: Operation Status Monitors

No. (Hex.)	Name	Description	MFAO Signal Level
U6-01 (0051)	Iq Secondary Current	<input type="checkbox"/> V/f <input type="checkbox"/> OLV <input type="checkbox"/> OLV/PM <input type="checkbox"/> AOLV/PM <input type="checkbox"/> EZOLV Shows the value calculated for the motor secondary current (q-Axis) as a percentage of the motor rated secondary current. Unit: 0.1%	10 V: Motor secondary rated current (0 V to +10 V)
U6-02 (0052)	Id ExcitationCurrent	<input type="checkbox"/> V/f <input type="checkbox"/> OLV <input type="checkbox"/> OLV/PM <input type="checkbox"/> AOLV/PM <input type="checkbox"/> EZOLV Shows the value calculated for the motor excitation current (d-Axis) as a percentage of the motor rated secondary current. Unit: 0.1%	10 V: Motor secondary rated current (0 V to +10 V)
U6-03 (0054)	ASR Input	<input type="checkbox"/> V/f <input type="checkbox"/> OLV <input type="checkbox"/> OLV/PM <input type="checkbox"/> AOLV/PM <input type="checkbox"/> EZOLV Shows the ASR input value as a percentage of the maximum frequency. Unit: 0.01%	10 V: Maximum frequency (0 V to +10 V)
U6-04 (0055)	ASR Output	<input type="checkbox"/> V/f <input type="checkbox"/> OLV <input type="checkbox"/> OLV/PM <input type="checkbox"/> AOLV/PM <input type="checkbox"/> EZOLV Shows the ASR output value as a percentage of the motor rated secondary current. Unit: 0.01%	10 V: Motor secondary rated current (0 V to +10 V)
U6-05 (0059)	OutputVoltageRef: Vq	<input type="checkbox"/> V/f <input type="checkbox"/> OLV <input type="checkbox"/> OLV/PM <input type="checkbox"/> AOLV/PM <input type="checkbox"/> EZOLV Shows the drive internal voltage reference for motor secondary current control (q-Axis). Unit: 0.1 V	200 V Class: 10 V = 200 Vrms 400 V Class: 10 V = 400 Vrms (0 V to +10 V)
U6-06 (005A)	OutputVoltageRef: Vd	<input type="checkbox"/> V/f <input type="checkbox"/> OLV <input type="checkbox"/> OLV/PM <input type="checkbox"/> AOLV/PM <input type="checkbox"/> EZOLV Shows the drive internal voltage reference for motor excitation current control (d-Axis). Unit: 0.1 V	200 V Class: 10 V = 200 Vrms 400 V Class: 10 V = 400 Vrms (0 V to +10 V)
U6-07 (005F) Expert	q-Axis ACR Output	<input type="checkbox"/> V/f <input type="checkbox"/> OLV <input type="checkbox"/> OLV/PM <input type="checkbox"/> AOLV/PM <input type="checkbox"/> EZOLV Shows the output value for current control related to motor secondary current (q axis). Unit: 0.1 %	200 V Class: 10 V = 200 Vrms 400 V Class: 10 V = 400 Vrms (0 V to +10 V)
U6-08 (0060) Expert	d-Axis ACR Output	<input type="checkbox"/> V/f <input type="checkbox"/> OLV <input type="checkbox"/> OLV/PM <input type="checkbox"/> AOLV/PM <input type="checkbox"/> EZOLV Shows the output value for current control related to motor excitation current (d axis). Unit: 0.1 %	200 V Class: 10 V = 200 Vrms 400 V Class: 10 V = 400 Vrms (0 V to +10 V)
U6-09 (07C0) Expert	AdvPhase Compen Δθcmp	<input type="checkbox"/> V/f <input type="checkbox"/> OLV <input type="checkbox"/> OLV/PM <input type="checkbox"/> AOLV/PM <input type="checkbox"/> EZOLV Displays the data on forward phase compensation for the calculation results of the amount of control axis deviation. Unit: 1 °	5 V: 180 ° (-10 V to +10 V)
U6-10 (07C1) Expert	ContAxisDeviation Δθ	<input type="checkbox"/> V/f <input type="checkbox"/> OLV <input type="checkbox"/> OLV/PM <input type="checkbox"/> AOLV/PM <input type="checkbox"/> EZOLV Shows the deviation between the γδ-Axis that the drive uses for motor control and the dq-Axis. Unit: 0.1 °	5 V: 180 ° (-10 V to +10 V)
U6-14 (07CB) Expert	MagPolePosition(Obs)	<input type="checkbox"/> V/f <input type="checkbox"/> OLV <input type="checkbox"/> OLV/PM <input type="checkbox"/> AOLV/PM <input type="checkbox"/> EZOLV Shows the value of the flux position estimation. Unit: 0.1 °	10 V: 180 ° (-10 V to +10 V)

1.17 U: Monitors

No. (Hex.)	Name	Description	MFAO Signal Level
U6-17 (07D1) Expert	Energy Save Coeff	<p>V/f OLV OLV/IPM AOLV/IPM EZOLV</p> <p>Shows the total time of direction of motor rotation detections for Speed Estimation Speed Searches. This value adjusts <i>b3-26 [Direction Determination Level]</i>.</p> <p>Note: Upper limit is +32767 and lower limit is -32767.</p>	No signal output available
U6-20 (07D4)	UP/DOWN 2 Bias Value	<p>V/f OLV OLV/IPM AOLV/IPM EZOLV</p> <p>Shows the bias value used to adjust the frequency reference. Unit: 0.1%</p>	10 V: Maximum Frequency
U6-21 (07D5)	Offset Frequency	<p>V/f OLV OLV/IPM AOLV/IPM EZOLV</p> <p>Shows the total value of <i>d7-01 to d7-03 [Offset Frequency 1 to 3]</i> selected with <i>Add Offset Frequency 1 to 3 [H1-xx = 44 to 46]</i>. Unit: 0.1%</p>	10 V: Maximum Frequency
U6-31 (007B)	TorqueDetect Monitor	<p>V/f OLV OLV/IPM AOLV/IPM EZOLV</p> <p>Monitors the torque reference or the output current after applying the filter set to <i>L6-07 [Torque Detection Filter Time]</i>. Unit: 0.1%</p>	10 V:100%
U6-36 (0720) Expert	Comm Errors-Host	<p>V/f OLV OLV/IPM AOLV/IPM EZOLV</p> <p>Shows the number of inter-CPU communication errors. When you de-energize the drive, this value resets to 0.</p>	No signal output available
U6-37 (0721) Expert	Comm Errors-Sensor	<p>V/f OLV OLV/IPM AOLV/IPM EZOLV</p> <p>Shows the number of inter-CPU communication errors. When you de-energize the drive, this value resets to 0.</p>	No signal output available
U6-57 (07C4)	PolePolarityDeterVal	<p>V/f OLV OLV/IPM AOLV/IPM EZOLV</p> <p>Shows the change from the integrated current when the drive finds the polarity. Unit: 1</p> <p>Note: If the change from the integrated current is less than 819, increase <i>n8-84 [Polarity Detection Current]</i>. <i>U6-57 = 8192</i> is equivalent to the motor rated current.</p>	No signal output available
U6-80 (07B0)	Option IP Address 1	<p>V/f OLV OLV/IPM AOLV/IPM EZOLV</p> <p>Shows the currently available local IP Address (1st octet).</p>	No signal output available
U6-81 (07B1)	Option IP Address 2	<p>V/f OLV OLV/IPM AOLV/IPM EZOLV</p> <p>Shows the currently available local IP Address (2nd octet).</p>	No signal output available
U6-82 (07B2)	Option IP Address 3	<p>V/f OLV OLV/IPM AOLV/IPM EZOLV</p> <p>Shows the currently available local IP Address (3rd octet).</p>	No signal output available
U6-83 (07B3)	Option IP Address 4	<p>V/f OLV OLV/IPM AOLV/IPM EZOLV</p> <p>Shows the currently available local IP Address (4th octet).</p>	No signal output available
U6-84 (07B4)	Online Subnet 1	<p>V/f OLV OLV/IPM AOLV/IPM EZOLV</p> <p>Shows the currently available subnet mask (1st octet).</p>	No signal output available
U6-85 (07B5)	Online Subnet 2	<p>V/f OLV OLV/IPM AOLV/IPM EZOLV</p> <p>Shows the currently available subnet mask (2nd octet).</p>	No signal output available
U6-86 (07B6)	Online Subnet 3	<p>V/f OLV OLV/IPM AOLV/IPM EZOLV</p> <p>Shows the currently available subnet mask (3rd octet).</p>	No signal output available
U6-87 (07B7)	Online Subnet 4	<p>V/f OLV OLV/IPM AOLV/IPM EZOLV</p> <p>Shows the currently available subnet mask (4th octet).</p>	No signal output available
U6-88 (07B8)	Online Gateway 1	<p>V/f OLV OLV/IPM AOLV/IPM EZOLV</p> <p>Shows the currently available Gateway address (1st octet).</p>	No signal output available
U6-89 (07B9)	Online Gateway 2	<p>V/f OLV OLV/IPM AOLV/IPM EZOLV</p> <p>Shows the currently available Gateway address (2nd octet).</p>	No signal output available
U6-90 (07F0)	Online Gateway 3	<p>V/f OLV OLV/IPM AOLV/IPM EZOLV</p> <p>Shows the currently available Gateway address (3rd octet).</p>	No signal output available
U6-91 (07F1)	Online Gateway 4	<p>V/f OLV OLV/IPM AOLV/IPM EZOLV</p> <p>Shows the currently available Gateway address (4th octet).</p>	No signal output available
U6-92 (07F2)	Online Speed	<p>V/f OLV OLV/IPM AOLV/IPM EZOLV</p> <p>Shows the currently available communications speed. 10: 10 Mbps 100: 100 Mbps</p>	No signal output available
U6-93 (07F3)	Online Duplex	<p>V/f OLV OLV/IPM AOLV/IPM EZOLV</p> <p>Shows the currently available Duplex setting.</p>	No signal output available

No. (Hex.)	Name	Description	MFAO Signal Level
U6-98 (07F8)	First Fault	V/f OLV OLV/PM AOLV/PM EZOLV Shows the contents of the most recent communication options fault (DeviceNet, Modbus TCP/IP, EtherNet/IP).	No signal output available
U6-99 (07F9)	Current Fault	V/f OLV OLV/PM AOLV/PM EZOLV Shows the contents of current fault from communication options (DeviceNet, Modbus TCP/IP, EtherNet/IP).	No signal output available

◆ U8: DriveWorksEZ Monitors

No. (Hex.)	Name	Description	MFAO Signal Level
U8-01 (1950)	DWEZ Monitor 1	V/f OLV OLV/PM AOLV/PM EZOLV Shows DWEZ Monitor 1. (Display range: 0.00% to 999.99%) Unit: 0.01%	10 V = 100%
U8-02 (1951)	DWEZ Monitor 2	V/f OLV OLV/PM AOLV/PM EZOLV Shows DWEZ Monitor 2. (Display range: 0.00% to 999.99%) Unit: 0.01%	10 V = 100%
U8-03 (1952)	DWEZ Monitor 3	V/f OLV OLV/PM AOLV/PM EZOLV Shows DWEZ Monitor 3. (Display range: 0.00% to 999.99%) Unit: 0.01%	10 V = 100%
U8-04 (1953)	DWEZ Monitor 4	V/f OLV OLV/PM AOLV/PM EZOLV Shows DWEZ Monitor 4. (Display range: 0.00% to 999.99%) Unit: 0.01%	10 V = 100%
U8-05 (1954)	DWEZ Monitor 5	V/f OLV OLV/PM AOLV/PM EZOLV Shows DWEZ Monitor 5. (Display range: 0.00% to 999.99%) Unit: 0.01%	10 V = 100%
U8-06 (1955)	DWEZ Monitor 6	V/f OLV OLV/PM AOLV/PM EZOLV Shows DWEZ Monitor 6. (Display range: 0.00% to 999.99%) Unit: 0.01%	10 V = 100%
U8-07 (1956)	DWEZ Monitor 7	V/f OLV OLV/PM AOLV/PM EZOLV Shows DWEZ Monitor 7. (Display range: -999.9% to +999.99%) Unit: 0.01%	10 V = 100%
U8-08 (1957)	DWEZ Monitor 8	V/f OLV OLV/PM AOLV/PM EZOLV Shows DWEZ Monitor 8. (Display range: -999.9% to +999.99%) Unit: 0.01%	10 V = 100%
U8-09 (1958)	DWEZ Monitor 9	V/f OLV OLV/PM AOLV/PM EZOLV Shows DWEZ Monitor 9. (Display range: -999.9% to +999.99%) Unit: 0.01%	10 V = 100%
U8-10 (1959)	DWEZ Monitor 10	V/f OLV OLV/PM AOLV/PM EZOLV Shows DWEZ Monitor 10.	No signal output available
U8-11 (195A)	DWEZ Version 1	V/f OLV OLV/PM AOLV/PM EZOLV Shows the Upper three digits of the user ID. When you click the setting button on the title bar of the PC tool to open the setting screen, you can confirm the user ID with the primary user ID display.	No signal output available
U8-12 (195B)	DWEZ Version 2	V/f OLV OLV/PM AOLV/PM EZOLV Shows the lower five digits of the user ID. When you click the setting button on the title bar of the PC tool to open the setting screen, you can confirm the user ID with the primary user ID display.	No signal output available
U8-13 (195C)	DWEZ Version 3	V/f OLV OLV/PM AOLV/PM EZOLV Shows the software ID.	No signal output available
U8-18 (1961)	DWEZ Platform Ver	V/f OLV OLV/PM AOLV/PM EZOLV Shows the DriveWorksEZ platform version.	No signal output available
U8-21 (1964)	DWEZ Monitor 21	V/f OLV OLV/PM AOLV/PM EZOLV Shows DWEZ Monitor 21. (Display range: -999.9% to +999.99%) Unit: 0.01%	10 V = 100%
U8-22 (1965)	DWEZ Monitor 22	V/f OLV OLV/PM AOLV/PM EZOLV Shows DWEZ Monitor 22. Unit: The number of decimal points shown is set with Q2-21.	10 V = 100%

1.17 U: Monitors

No. (Hex.)	Name	Description	MFAO Signal Level
U8-23 (1966)	DWEZ Monitor 23	V/f OLV OLV/IPM AOLV/IPM EZOLV Shows DWEZ Monitor 23. Unit: The number of decimal points shown is set with Q2-22.	10 V = 100%
U8-24 (1967)	DWEZ Monitor 24	V/f OLV OLV/IPM AOLV/IPM EZOLV Shows DWEZ Monitor 24. Unit: The number of decimal points shown is set with Q2-23.	10 V = 100%
U8-25 (1968)	DWEZ Monitor 25	V/f OLV OLV/IPM AOLV/IPM EZOLV Shows DWEZ Monitor 25. Unit: The number of decimal points shown is set with Q2-24.	10 V = 100%
U8-31 (196E)	DWEZ Monitor 31	V/f OLV OLV/IPM AOLV/IPM EZOLV Shows DWEZ Monitor 31. (Display range: 0.00% to 999.99%) Unit: 0.01%	10 V = 100%
U8-32 (196F)	DWEZ Monitor 32	V/f OLV OLV/IPM AOLV/IPM EZOLV Shows DWEZ Monitor 32. (Display range: 0.00% to 999.99%) Unit: 0.01%	10 V = 100%
U8-33 (1970)	DWEZ Monitor 33	V/f OLV OLV/IPM AOLV/IPM EZOLV Shows DWEZ Monitor 33. (Display range: 0.00% to 999.99%) Unit: 0.01%	10 V = 100%
U8-34 (1971)	DWEZ Monitor 34	V/f OLV OLV/IPM AOLV/IPM EZOLV Shows DWEZ Monitor 34. (Display range: 0.00% to 999.99%) Unit: 0.01%	10 V = 100%
U8-35 (1972)	DWEZ Monitor 35	V/f OLV OLV/IPM AOLV/IPM EZOLV Shows DWEZ Monitor 35. (Display range: 0.00% to 999.99%) Unit: 0.01%	10 V = 100%
U8-36 (1973)	DWEZ Monitor 36	V/f OLV OLV/IPM AOLV/IPM EZOLV Shows DWEZ Monitor 36. (Display range: 0.00% to 999.99%) Unit: 0.01%	10 V = 100%
U8-37 (1974)	DWEZ Monitor 37	V/f OLV OLV/IPM AOLV/IPM EZOLV Shows DWEZ Monitor 37. (Display range: -999.9% to +999.99%) Unit: 0.01%	10 V = 100%
U8-38 (1975)	DWEZ Monitor 38	V/f OLV OLV/IPM AOLV/IPM EZOLV Shows DWEZ Monitor 38. (Display range: -999.9% to +999.99%) Unit: 0.01%	10 V = 100%
U8-39 (1976)	DWEZ Monitor 39	V/f OLV OLV/IPM AOLV/IPM EZOLV Shows DWEZ Monitor 39. (Display range: -999.9% to +999.99%) Unit: 0.01%	10 V = 100%
U8-40 (1977)	DWEZ Monitor 40	V/f OLV OLV/IPM AOLV/IPM EZOLV Shows DWEZ Monitor 40.	No signal output available
U8-51 (1982)	DWEZ Monitor 51	V/f OLV OLV/IPM AOLV/IPM EZOLV Shows DWEZ Monitor 51. (Display range: -999.9% to +999.99%) Unit: 0.01%	10 V = 100%
U8-52 (1983)	DWEZ Monitor 52	V/f OLV OLV/IPM AOLV/IPM EZOLV Shows DWEZ Monitor 52. Unit: The number of decimal points shown is set with Q2-41.	10 V = 100%
U8-53 (1984)	DWEZ Monitor 53	V/f OLV OLV/IPM AOLV/IPM EZOLV Shows DWEZ Monitor 53. Unit: The number of decimal points shown is set with Q2-42.	10 V = 100%
U8-54 (1985)	DWEZ Monitor 54	V/f OLV OLV/IPM AOLV/IPM EZOLV Shows DWEZ Monitor 54. Unit: The number of decimal points shown is set with Q2-43.	10 V = 100%
U8-55 (1986)	DWEZ Monitor 55	V/f OLV OLV/IPM AOLV/IPM EZOLV Shows DWEZ Monitor 55. Unit: The number of decimal points shown is set with Q2-44.	10 V = 100%

No. (Hex.)	Name	Description	MFAO Signal Level
U8-60 (198B)	RemoteIO Status	<p>V/f OLV OLV/PM AOLV/PM EZOLV</p> <p>Shows the operation status of Remote IO as 1 (ON) and 0 (OFF). If the DriveWorksEZ MEMOBUS master active signal is ON, for example, the monitor shows <i>U8-60 = 00000001</i>.</p> <p>bit 0 : Bit 0: DriveWorksEZ MEMOBUS Master Active bit 1 : Not used (normal value of 0) bit 2 : Not used (normal value of 0) bit 3 : Not used (normal value of 0) bit 4 : Not used (normal value of 0) bit 5 : Not used (normal value of 0) bit 6 : Not used (normal value of 0) bit 7 : Not used (normal value of 0)</p>	No signal output available
U8-61 (198C)	RemoteDI Monitor 0-7bit	<p>V/f OLV OLV/PM AOLV/PM EZOLV</p> <p>Shows the operation status of Remote DI1 to DI8 as 1 (ON) and 0 (OFF). If Remote DI1 and DI2 are ON, for example, the monitor shows <i>U8-61 = 00000011</i>.</p> <p>bit 0 : Remote DI1 bit 1 : Remote DI2 bit 2 : Remote DI3 bit 3 : Remote DI4 bit 4 : Remote DI5 bit 5 : Remote DI6 bit 6 : Remote DI7 bit 7 : Remote DI8</p>	No signal output available
U8-62 (198D)	RemoteDI Monitor 8-Fbit	<p>V/f OLV OLV/PM AOLV/PM EZOLV</p> <p>Shows the operation status of Remote DI9 to DI16 as 1 (ON) and 0 (OFF). If Remote DI9 and DI10 are ON, for example, the monitor shows <i>U8-62 = 00000011</i>.</p> <p>bit 0 : Remote DI9 bit 1 : Remote DI10 bit 2 : Remote DI11 bit 3 : Remote DI12 bit 4 : Remote DI13 bit 5 : Remote DI14 bit 6 : Remote DI15 bit 7 : Remote DI16</p>	No signal output available
U8-63 (198E)	RemoteDO Monitor 0-7bit	<p>V/f OLV OLV/PM AOLV/PM EZOLV</p> <p>Shows the operation status of Remote DO1 to DO8 as 1 (ON) and 0 (OFF). If Remote DO1 and DO2 are ON, for example, the monitor shows <i>U8-63 = 00000011</i>.</p> <p>bit 0 : Remote DO1 bit 1 : Remote DO2 bit 2 : Remote DO3 bit 3 : Remote DO4 bit 4 : Remote DO5 bit 5 : Remote DO6 bit 6 : Remote DO7 bit 7 : Remote DO8</p>	No signal output available
U8-64 (198F)	RemoteDO Monitor 8-Fbit	<p>V/f OLV OLV/PM AOLV/PM EZOLV</p> <p>Shows the operation status of Remote DO9 to DO16 as 1 (ON) and 0 (OFF). If Remote DO9 and DO10 are ON, for example, the monitor shows <i>U8-64 = 00000011</i>.</p> <p>bit 0 : Remote DO9 bit 1 : Remote DO10 bit 2 : Remote DO11 bit 3 : Remote DO12 bit 4 : Remote DO13 bit 5 : Remote DO14 bit 6 : Remote DO15 bit 7 : Remote DO16</p>	No signal output available

1.18 Parameters that Change from the Default Settings with A1-02 [Control Method Selection]

The values for the parameters in these tables depend on the values for parameter A1-02. When you change the setting for A1-02, the default settings will change.

Table 1.1 A1-02 = 0, 2 [V/f, OLV]

No.	Name	Range	Unit	Control Method (A1-02 Setting)	
				V/f (0)	OLV (2)
b2-01	DC Injection/Zero SpeedThreshold	0.0 - 10.0	0.1 Hz	0.5	0.5
b2-04	DC Inject Braking Time at Stop	0.00 - 10.00	0.01 s	0.50	0.50
b3-01	Speed Search at Start Selection	0 - 1	1	0	0
b3-02	SpeedSearch Deactivation Current	0 - 200	1%	120	100
b3-08	Speed Estimation ACR P Gain	0.00 - 6.00	0.01	0.50 ^{*/1}	0.50 ^{*/1}
b3-09	Speed Estimation ACR I Time	0.0 - 1000.0	0.1 ms	2.0	2.0
b3-14	Bi-directional Speed Search	0 - 1	1	0	0
b5-15	PID Sleep Function Start Level	0.0 - 400.0	0.1 Hz	0.0	0.0
b6-01	Dwell Reference at Start	0.0 - 400.0	0.1 Hz	0.0	0.0
b6-03	Dwell Reference at Stop	0.0 - 400.0	0.1 Hz	0.0	0.0
b8-02	Energy Saving Gain	0.0 - 10.0	0.1	-	0.7
b8-03	Energy Saving Filter Time	0.00 - 10.00	0.01 s	-	0.50
b8-19	E-Save Search Injection Freq	10 - 300	1 Hz	100	100
C1-11	Accel/Decel Time Switchover Freq	0.0 - 400.0	0.1 Hz	0.0	0.0
C2-01	S-Curve Time @ Start of Accel	0.00 - 10.00	0.01 s	0.20	0.20
C3-01	Slip Compensation Gain	0.0 - 2.5	0.1	0.0	1.0
C3-02	Slip Compensation Delay Time	0 - 10000	1 ms	2000	200
C4-01	Torque Compensation Gain	0.00 - 2.50	0.01	1.00	1.00
C4-02	Torque Compensation Delay Time	0 - 10000	1 ms	200	20
C5-01	ASR Proportional Gain 1	0.00 - 300.00	0.01	-	-
C5-02	ASR Integral Time 1	0.000 - 60.000	0.001 s	-	-
C5-03	ASR Proportional Gain 2	0.00 - 300.00	0.01	-	-
C5-04	ASR Integral Time 2	0.000 - 10.000	0.001 s	-	-
C5-06	ASR Delay Time	0.000 - 0.500	0.001 s	-	-
C5-07	ASR Gain Switchover Frequency	0.0 - 400.0	0.1 Hz	0.0Hz	0.0Hz
C6-02	Carrier Frequency Selection	1 - F	1	1 ^{*2}	1 ^{*2}
d3-01	Jump Frequency 1	0.0 - 400.0	0.1 Hz	0.0	0.0
d3-02	Jump Frequency 2	0.0 - 400.0	0.1 Hz	0.0	0.0
d3-03	Jump Frequency 3	0.0 - 400.0	0.1 Hz	0.0	0.0
d3-04	Jump Frequency Width	0.0 - 20.0	0.1 Hz	1.0	1.0

1.18 Parameters that Change from the Default Settings with A1-02 [Control Method Selection]

No.	Name	Range	Unit	Control Method (A1-02 Setting)	
				V/f (0)	OLV (2)
E1-04	Maximum Output Frequency	40.0 - 400.0 *2 *3	0.1 Hz	60.0 *4	60.0
E1-05	Maximum Output Voltage	0.0 - 255.0 *5	0.1 V	200.0 *4	200.0
E1-06	Base Frequency	0.0 - 400.0 *3	0.1 Hz	60.0 *4	60.0
E1-07	Mid Point A Frequency	0.0 - 400.0 *3	0.1 Hz	3.0 *4	3.0
E1-08	Mid Point A Voltage	0.0 - 255.0 *5	0.1 V	15.0 *4	11.0
E1-09	Minimum Output Frequency	0.0 - 400.0 *3	0.1 Hz	1.5 *4	0.5
E1-10	Minimum Output Voltage	0.0 - 255.0 *5	0.1 V	9.0 *4	2.0
F1-09	Overspeed Detection Delay Time	0.0 - 2.0	0.1 s	-	-
L1-01	Motor Overload (oL1) Protection	0 - 4	1	2	2
L2-31	KEB Start Voltage Offset Level	0 - 100 *5	1 V	0	0
L3-05	Stall Prevention during RUN	0 - 3	1	1	1
L3-20	DC Bus Voltage Adjustment Gain	0.00 - 5.00	0.01	1.00	0.30
L3-21	OVSUPPRESSION Accel/Decel P Gain	0.10 - 10.00	0.01	1.00	1.00
L3-36	Current Suppression Gain@Accel	0.0 - 100.0	0.1	10.0	20.0
L4-01	Speed Agree Detection Level	0.0 - 400.0 *6	0.1	0.0 Hz	0.0 Hz
L4-02	Speed Agree Detection Width	0.0 - 20.0	0.1	2.0 Hz	2.0 Hz
L4-03	Speed Agree Detection Level(+/-)	-400.0 - +400.0 *7	0.1	0.0 Hz	0.0 Hz
L4-04	Speed Agree Detection Width(+/-)	0.0 - 20.0	0.1	2.0 Hz	2.0 Hz
L8-40	Carrier Freq Reduction Off-Delay	0.00 - 2.00	0.01 s	0.50	0.50
L8-90	STP _o Detection Level (Low Speed)	0 - 5000	1	-	-
n5-04	Speed Response Frequency	0.00 - 500.00	0.00 Hz	-	-
n8-35	Initial Pole Detection Method	0 - 2	1	-	-
n8-51	Pull-in Current @ Acceleration	0 - 200%	1	0	0
o1-03	Frequency Display Unit Selection	0 - 3	1	0	0
o1-04	V/f Pattern Display Unit	0 - 1	1	-	-

- *1 The default setting changes when the setting for o2-04 [Drive Model Selection] changes.
- *2 The default setting changes when the setting of C6-01 [Normal / Heavy Duty Selection] changes.
- *3 The setting range changes when the setting of E5-01 [PM Motor Code Selection] changes when A1-02 = 5 [OLV/PM].
- *4 The default setting changes when the drive model and E1-03 [V/f Pattern Selection] change.
- *5 This is the value for 200 V class drives. Double the value for 400 V class drives.
- *6 When A1-02 = 5 [OLV/PM], the maximum value of the setting range is 100.0.
- *7 When A1-02 = 5 [OLV/PM], the setting range is -100.0 to +100.0.

1.18 Parameters that Change from the Default Settings with A1-02 [Control Method Selection]

Table 1.2 A1-02 = 5, 6, 8 [OLV/PM, AOLV/PM, EZOLV]

No.	Name	Range	Unit	Control Method (A1-02 Setting)		
				OLV/PM (5)	AOLV/PM (6)	EZOLV (8)
b2-01	DC Injection/Zero SpeedThreshold	0.0 - 10.0	0.1	0.5 Hz	1.0%	0.5Hz
b2-04	DC Inject Braking Time at Stop	0.00 - 10.00	0.01 s	0.00	0.00	0.00
b3-01	Speed Search at Start Selection	0 - 1	1	0	0	0
b3-02	SpeedSearch Deactivation Current	0 - 200	1%	-	-	-
b3-08	Speed Estimation ACR P Gain	0.00 - 6.00	0.01	0.30	0.30	0.30
b3-09	Speed Estimation ACR I Time	0.0 - 1000.0	0.1 ms	4.0	4.0	4.0
b3-14	Bi-directional Speed Search	0 - 1	1	-	-	0
b5-15	PID Sleep Function Start Level	0.0 - 400.0 *1	0.1	0.0 Hz	0.0%	0.0%
b6-01	Dwell Reference at Start	0.0 - 400.0 *1	0.1	0.0 Hz	0.0%	0.0%
b6-03	Dwell Reference at Stop	0.0 - 400.0 *1	0.1	0.0 Hz	0.0%	0.0%
b8-02	Energy Saving Gain	0.0 - 10.0	0.1	-	-	-
b8-03	Energy Saving Filter Time	0.00 - 10.00	0.01 s	-	-	-
b8-19	E-Save Search Injection Freq	10 - 300	1 Hz	100	100	20
C1-11	Accel/Decel Time Switchover Freq	0.0 - 400.0 *1	0.1	0.0 Hz	0.0%	0.0%
C2-01	S-Curve Time @ Start of Accel	0.00 - 10.00	0.01 s	1.00	0.20	1.00
C3-01	Slip Compensation Gain	0.0 - 2.5	0.1	-	-	0
C3-02	Slip Compensation Delay Time	0 - 10000	1 ms	-	-	200
C4-01	Torque Compensation Gain	0.00 - 2.50	0.01	0.00	-	0.00
C4-02	Torque Compensation Delay Time	0 - 10000	1 ms	100	-	100
C5-01	ASR Proportional Gain 1	0.00 - 300.00	0.01	10.00	10.00	10.00
C5-02	ASR Integral Time 1	0.000 - 60.000	0.001 s	0.500	0.500	0.500
C5-03	ASR Proportional Gain 2	0.00 - 300.00	0.01	-	10.00	10.00
C5-04	ASR Integral Time 2	0.000 - 10.000	0.001 s	-	0.500	0.500
C5-06	ASR Delay Time	0.000 - 0.500	0.001 s	-	0.016	0.004
C5-07	ASR Gain Switchover Frequency	0.0 - 400.0 *1	0.1	0.0Hz	0.0%	0.0%
C6-02	Carrier Frequency Selection	1 - F	1	2	2	2
d3-01	Jump Frequency 1	0.0 - 400.0 *1	0.1	0.0 Hz	0.0%	0.0%
d3-02	Jump Frequency 2	0.0 - 400.0 *1	0.1	0.0 Hz	0.0%	0.0%
d3-03	Jump Frequency 3	0.0 - 400.0 *1	0.1	0.0 Hz	0.0 %	0.0 %
d3-04	Jump Frequency Width	0.0 - 20.0 *2	0.1	1.0 Hz	1.0 %	1.0 %
E1-04	Maximum Output Frequency	40.0 - 400.0 *3	0.1 Hz	Determined by E5-01	Determined by E5-01	Determined by E5-01
E1-05	Maximum Output Voltage	0.0 - 255.0 *4	0.1 V	Determined by E5-01	Determined by E5-01	Determined by E5-01
E1-06	Base Frequency	0.0 - 400.0	0.1 Hz	Determined by E5-01	Determined by E5-01	Determined by E5-01
E1-07	Mid Point A Frequency	0.0 - 400.0	0.1 Hz	-	-	-
E1-08	Mid Point A Voltage	0.0 - 255.0 *4	0.1 V	-	-	-

1.18 Parameters that Change from the Default Settings with A1-02 [Control Method Selection]

No.	Name	Range	Unit	Control Method (A1-02 Setting)		
				OLV/PM (5)	AOLV/PM (6)	EZOLV (8)
E1-09	Minimum Output Frequency	0.0 - 400.0	0.1 Hz	Determined by E5-01	Determined by E5-01	Determined by E5-01
E1-10	Minimum Output Voltage	0.0 - 255.0 *4	0.1 V	-	-	-
F1-09	Overspeed Detection Delay Time	0.0 - 2.0	0.1 s	-	0.0	-
L1-01	Motor Overload (oL1) Protection	0 - 4	1	4	4	Determined by E9-01
L2-31	KEB Start Voltage Offset Level	0 - 100 *4	1 V	50	50	50
L3-05	Stall Prevention during RUN	0 - 3	1	1	-	3
L3-20	DC Bus Voltage Adjustment Gain	0.00 - 5.00	0.01	0.65	0.65	0.65
L3-21	OVSUPPRESSION Accel/Decel P Gain	0.10 - 10.00	0.01	1.00	1.00	1.00
L3-36	Current Suppression Gain@Accel	0.0 - 100.0	0.1	-	-	-
L4-01	Speed Agree Detection Level	0.0 - 400.0 *1	0.1	0.0 Hz	0.0%	0.0%
L4-02	Speed Agree Detection Width	0.0 - 20.0 *2	0.1	2.0 Hz	4.0%	4.0%
L4-03	Speed Agree Detection Level(+/-)	-400.0 - +400.0 *5	0.1	0.0 Hz	0.0%	0.0%
L4-04	Speed Agree Detection Width(+/-)	0.0 - 20.0 *2	0.1	2.0 Hz	4.0%	4.0%
L8-40	Carrier Freq Reduction Off-Delay	0.00 - 2.00	0.01 s	0.00	0.00	0.00
L8-90	STP _o Detection Level (Low Speed)	0 - 5000	1	0	80	-
n5-04	Speed Response Frequency	0.00 - 500.00	0.00 Hz	-	20.00	-
n8-35	Initial Pole Detection Method	0 - 2	1	0	1	-
n8-51	Pull-in Current @ Acceleration	0 - 200%	1	50%	0	80%
o1-03	Frequency Display Unit Selection	0 - 3	1	0	1	1
o1-04	V/f Pattern Display Unit	0 - 1	1	-	1	-

- *1 The setting range is 0.0 to 100.0 when A1-02 = 6 [PM Advanced Open Loop Vector].
- *2 The setting range is 0.0 to 40.0 when A1-02 = 6 [PM Advanced Open Loop Vector].
- *3 The default setting changes when the setting for C6-01 [Normal / Heavy Duty Selection] changes.
- *4 This is the value for 200 V class drives. Double the value for 400 V class drives.
- *5 The setting range is -100.0 to +100.0 when A1-02 = 6 [PM Advanced Open Loop Vector].

1.19 Parameters that Change from the Default Settings with E3-01 [Motor 2 Control Mode Selection]

The values for the parameters in these tables depend on the values for parameter *E3-01*. When you change the setting for *E3-01*, the default settings will change.

No.	Name	Range	Unit	Motor 2 Control Method (setting value of E3-01)	
				V/f (0)	OLV (2)
C3-21	Motor 2 Slip Compensation Gain	0.0 - 2.50	0.1	0.0	1.0
C3-22	Motor 2 Slip Comp Delay Time	0 - 10000	1 ms	2000	200
E3-04	Motor 2 Maximum Output Frequency	40.0 - 590.0	0.1 Hz	60.0	60.0
E3-05	Motor 2 Maximum Output Voltage	0.0 - 255.0 *1	0.1 V	200.0	200.0
E3-06	Motor 2 Base Frequency	0.0 - 590.0	0.1 Hz	60.0	60.0
E3-07	Motor 2 Mid Point A Frequency	0.0 - 590.0	0.1 Hz	3.0	3.0
E3-08	Motor 2 Mid Point A Voltage	0.0 - 255.0 *1	0.1 V	15.0	11.0
E3-09	Motor 2 Minimum Output Frequency	0.0 - 590.0	0.1 Hz	1.5	0.5
E3-10	Motor 2 Minimum Output Voltage	0.0 - 255.0 *1	0.1 V	9.0	2.0
E3-11	Motor 2 Mid Point B Frequency	0.0 - 590.0	Determined by o1-04	0.0	0.0
E3-12	Motor 2 Mid Point B Voltage	0.0 - 255.0 *1	0.1 V	0.0	0.0
E3-13	Motor 2 Base Voltage	0.0 - 255.0 *1	0.1 V	0.0	0.0

*1 This is the value for 200 V class drives. Double the value for 400 V class drives.

1.20 Parameters Changed by E1-03 [V/f Pattern Selection]

The values for parameters *A1-02* [Control Method Selection] and *E1-03* [V/f Pattern Selection] change the default settings for the parameters in these tables:

Table 1.3 Parameters Changed by E1-03 (B001 - B018, 2001 - 2021, and 4001 - 4012)

No.	Unit	Setting Value																Control Method (A1-02 Setting)		
		0	1	2	3	4	5	6	7	8	9	A	B	C	D	E	F */	OLV (2)	OLV/ PM (5)	AOL V/PM (6)
E1-04	Hz	50.0	60.0	60.0	72.0	50.0	50.0	60.0	60.0	50.0	50.0	60.0	60.0	90.0	120.0	180.0	60.0	60.0	*2	*2
E1-05 *3	V	230.0	230.0	230.0	230.0	230.0	230.0	230.0	230.0	230.0	230.0	230.0	230.0	230.0	230.0	230.0	230.0	230.0	*2	*2
E1-06	Hz	50.0	60.0	50.0	60.0	50.0	50.0	60.0	60.0	50.0	50.0	60.0	60.0	60.0	60.0	60.0	60.0	60.0	*2	*2
E1-07	Hz	2.5	3.0	3.0	3.0	25.0	25.0	30.0	30.0	2.5	2.5	3.0	3.0	3.0	3.0	3.0	3.0	3.0	-	-
E1-08 *3	V	18.4	18.4	18.4	18.4	40.3	57.5	40.3	57.5	21.9	27.6	21.9	27.6	18.4	18.4	18.4	18.4	13.8	-	-
E1-09	Hz	1.3	1.5	1.5	1.5	1.3	1.3	1.5	1.5	1.3	1.3	1.5	1.5	1.5	1.5	1.5	1.5	0.5	*2	*2
E1-10 *3	V	13.8	13.8	13.8	13.8	9.2	10.4	9.2	10.4	13.8	15.0	13.8	17.3	13.8	13.8	13.8	13.8	2.9	-	-

*1 These values are the default settings for *E1-04* to *E1-10* and *E3-04* to *E3-10* [V/f Pattern for Motor 2]. These settings are the same as those for the V/f pattern when *E1-03* = 1 [Const Trq, 60Hz base, 60Hz max].

*2 The default setting varies depending on the setting of *E5-01* [PM Motor Code Selection].

*3 This is the value for 200 V class drives. Double the value for 400 V class drives.

Table 1.4 Parameters Changed by E1-03 (2030 - 2082 and 4018 - 4060)

No.	Unit	Setting Value																Control Method (A1-02 Setting)		
		0	1	2	3	4	5	6	7	8	9	A	B	C	D	E	F */	OLV (2)	OLV/ PM (5)	AOL V/PM (6)
E1-04	Hz	50.0	60.0	60.0	72.0	50.0	50.0	60.0	60.0	50.0	50.0	60.0	60.0	90.0	120.0	180.0	60.0	60.0	*2	*2
E1-05 *3	V	230.0	230.0	230.0	230.0	230.0	230.0	230.0	230.0	230.0	230.0	230.0	230.0	230.0	230.0	230.0	230.0	230.0	*2	*2
E1-06	Hz	50.0	60.0	50.0	60.0	50.0	50.0	60.0	60.0	50.0	50.0	60.0	60.0	60.0	60.0	60.0	60.0	60.0	*2	*2
E1-07	Hz	2.5	3.0	3.0	3.0	25.0	25.0	30.0	30.0	2.5	2.5	3.0	3.0	3.0	3.0	3.0	3.0	3.0	-	-
E1-08 *3	V	16.1	16.1	16.1	16.1	40.3	57.5	40.3	57.5	20.7	26.5	20.7	26.5	16.1	16.1	16.1	16.1	12.7	-	-
E1-09	Hz	1.3	1.5	1.5	1.5	1.3	1.3	1.5	1.5	1.3	1.3	1.5	1.5	1.5	1.5	1.5	1.5	0.5	*2	*2
E1-10 *3	V	8.1	8.1	8.1	8.1	6.9	8.1	6.9	8.1	10.4	12.7	10.4	15.0	8.1	8.1	8.1	8.1	2.3	-	-

*1 These values are the default settings for *E1-04* to *E1-10* and *E3-04* to *E3-10* [V/f Pattern for Motor 2]. These settings are the same as those for the V/f pattern when *E1-03* = 1 [Const Trq, 60Hz base, 60Hz max].

*2 The default setting varies depending on the setting of *E5-01* [PM Motor Code Selection].

*3 This is the value for 200 V class drives. Double the value for 400 V class drives.

1.21 Defaults by Drive Model and Duty Rating ND/HD

The values for the parameters in these tables depend on the values for parameters *o2-04* and *C6-01*. Changing the settings for *o2-04* and *C6-01* will change the default settings.

◆ Single-Phase 200 V Class

No. */	Name	Unit	Default							
			B001		B002		B004		B006	
-	Drive Model	-	HD	ND	HD	ND	HD	ND	HD	ND
C6-01	Normal / Heavy Duty Selection	-	0	1	0	1	0	1	0	1
o2-04	Drive Model (KVA) Selection	Hex.	30		31		32		33	
E2-11 (E4-11, E5-02)	Motor Rated Power	kW	0.1	0.2	0.2	0.4	0.4	0.75	0.75	1.1
b3-04	V/f Gain during Speed Search	%	100	100	100	100	100	100	100	100
b3-06	Speed Estimation Current Level 1	-	1	1	1	1	1	1	0.5	0.5
b3-08	Speed Estimation ACR P Gain	-	0.5	0.5	0.5	0.5	0.5	0.5	0.5	0.5
b3-26	Direction Determination Level	-	1000	1000	1000	1000	1000	1000	1000	1000
b8-03	Energy Saving Filter Time	s	0.5	0.5	0.5	0.5	0.5	0.5	0.5	0.5
b8-04	Energy Saving Coefficient Value	-	481.7	356.9	356.9	288.2	288.2	223.7	223.7	196.6
C6-02	Carrier Frequency Selection	-	4	7	4	7	4	7	4	7
E2-01 (E4-01)	Motor Rated Current (FLA)	A	0.6	1.1	1.1	1.9	1.9	3.3	3.3	6.2
E2-02 (E4-02)	Motor Rated Slip	Hz	2.5	2.6	2.6	2.9	2.9	2.5	2.5	2.6
E2-03 (E4-03)	Motor No-Load Current	A	0.4	0.8	0.8	1.2	1.2	1.8	1.8	2.8
E2-05 (E4-05)	Motor Line-to-Line Resistance	Ω	35.98	20.56	20.56	9.842	9.842	5.156	5.156	1.997
E2-06 (E4-06)	Motor Leakage Inductance	%	21.6	20.1	20.1	18.2	18.2	13.8	13.8	18.5
E2-10 (E4-10)	Motor Iron Loss	W	6	11	11	14	14	26	26	53
E5-01	PM Motor Code Selection	-	FFFF	FFFF	FFFF	FFFF	FFFF	FFFF	FFFF	FFFF
L2-02	Power Loss Ride Through Time	s	0.1	0.1	0.1	0.1	0.1	0.1	0.2	0.2
L2-03	Minimum Baseblock Time	s	0.2	0.3	0.2	0.3	0.2	0.3	0.3	0.4
L2-04	Powerloss V/f Recovery Ramp Time	s	0.3	0.3	0.3	0.3	0.3	0.3	0.3	0.3

No. */	Name	Unit	Default							
			B001		B002		B004		B006	
-	Drive Model	-	HD	ND	HD	ND	HD	ND	HD	ND
C6-01	Normal / Heavy Duty Selection	-	0	1	0	1	0	1	0	1
o2-04	Drive Model (KVA) Selection	Hex.	30		31		32		33	
E2-11 (E4-11, E5-02)	Motor Rated Power	kW	0.1	0.2	0.2	0.4	0.4	0.75	0.75	1.1
L2-05	Undervoltage Detection Lvl (Uv1)	-	160	160	160	160	160	160	160	160
L3-02	Stall Prevent Level during Accel	%	150	120	150	120	150	120	150	120
L3-06	Stall Prevent Level during Run	%	150	120	150	120	150	120	150	120
L3-24	Motor Accel Time @ Rated Torque	s	0.178	0.178	0.178	0.178	0.178	0.142	0.142	0.142
L8-02	Overheat Alarm Level	°C	105	105	105	105	115	115	115	115
L8-09	Output Ground Fault Detection	-	0	0	0	0	0	0	0	0
n1-03	Hunting Prevention Time Constant	ms	10	10	10	10	10	10	10	10
n3-02	HSB Current Limit Level	%	150	120	150	120	150	120	150	120
n5-02	Motor Inertia Acceleration Time	s	0.178	0.178	0.178	0.142	0.178	0.142	0.142	0.142

*1 Parameters within parentheses are for motor 2.

No. */	Name	Unit	Default					
			B010		B012		B018	
-	Drive Model	-	HD	ND	HD	ND	HD	ND
C6-01	Normal / Heavy Duty Selection	-	0	1	0	1	0	1
o2-04	Drive Model (KVA) Selection	Hex.	34		35		37	
E2-11 (E4-11, E5-02)	Motor Rated Power	kW	1.5	2.2	2.2	3.0	3.7	5.5
b3-04	V/f Gain during Speed Search	%	100	100	100	100	100	100
b3-06	Speed Estimation Current Level 1	-	0.5	0.5	0.5	0.5	0.5	0.5
b3-08	Speed Estimation ACR P Gain	-	0.5	0.5	0.5	0.5	0.5	0.5
b3-26	Direction Determination Level	-	1000	1000	1000	1000	1000	1000
b8-03	Energy Saving Filter Time	s	0.5	0.5	0.5	0.5	0.5	0.5
b8-04	Energy Saving Coefficient Value	-	169.4	156.8	156.8	136.4	122.9	94.75
C6-02	Carrier Frequency Selection	-	3	7	3	7	3	7
E2-01 (E4-01)	Motor Rated Current (FLA)	A	6.2	8.5	8.5	11.4	14	19.6

Parameter List

1

1.21 Defaults by Drive Model and Duty Rating ND/HD

No. */	Name	Unit	Default					
			B010		B012		B018	
-	Drive Model	-	HD	ND	HD	ND	HD	ND
C6-01	Normal / Heavy Duty Selection	-	0	1	0	1	0	1
o2-04	Drive Model (KVA) Selection	Hex.	34		35		37	
E2-11 (E4-11, E5-02)	Motor Rated Power	kW	1.5	2.2	2.2	3.0	3.7	5.5
E2-02 (E4-02)	Motor Rated Slip	Hz	2.6	2.9	2.9	2.7	2.73	1.5
E2-03 (E4-03)	Motor No-Load Current	A	2.8	3	3	3.7	4.5	5.1
E2-05 (E4-05)	Motor Line-to-Line Resistance	Ω	1.997	1.601	1.601	1.034	0.771	0.399
E2-06 (E4-06)	Motor Leakage Inductance	%	18.5	18.4	18.4	19	19.6	18.2
E2-10 (E4-10)	Motor Iron Loss	W	53	77	77	91	112	172
E5-01	PM Motor Code Selection	-	FFFF	FFFF	FFFF	FFFF	FFFF	FFFF
L2-02	Power Loss Ride Through Time	s	0.3	0.3	0.5	0.5	1	1
L2-03	Minimum Baseblock Time	s	0.4	0.5	0.5	0.5	0.6	0.7
L2-04	Powerloss V/f Recovery Ramp Time	s	0.3	0.3	0.3	0.3	0.3	0.3
L2-05	Undervoltage Detection Lvl (Uv1)	-	160	160	160	160	160	160
L3-02	Stall Prevent Level during Accel	%	150	120	150	120	150	120
L3-06	Stall Prevent Level during Run	%	150	120	150	120	150	120
L3-24	Motor Accel Time @ Rated Torque	s	0.166	0.145	0.145	0.145	0.154	0.168
L8-02	Overheat Alarm Level	°C	105	105	110	110	115	115
L8-09	Output Ground Fault Detection	-	0	0	0	0	0	0
n1-03	Hunting Prevention Time Constant	ms	10	10	10	10	10	10
n3-02	HSB Current Limit Level	%	150	120	150	120	150	120
n5-02	Motor Inertia Acceleration Time	s	0.166	0.145	0.145	0.145	0.154	0.168

*1 Parameters within parentheses are for motor 2.

◆ Three-Phase 200 V Class

No. */	Name	Unit	Default							
			2001		2002		2004		2006	
-	Drive Model	-	HD	ND	HD	ND	HD	ND	HD	ND
C6-01	Normal / Heavy Duty Selection	-	0	1	0	1	0	1	0	1
o2-04	Drive Model (KVA) Selection	Hex.	60		61		62		63	
E2-11 (E4-11, E5-02)	Motor Rated Power	kW	0.1	0.2	0.2	0.4	0.4	0.75	0.75	1.1
b3-04	V/f Gain during Speed Search	%	100	100	100	100	100	100	100	100
b3-06	Speed Estimation Current Level 1	-	1	1	1	1	1	1	0.5	0.5
b3-08	Speed Estimation ACR P Gain	-	0.5	0.5	0.5	0.5	0.5	0.5	0.5	0.5
b3-26	Direction Determination Level	-	1000	1000	1000	1000	1000	1000	1000	1000
b8-03	Energy Saving Filter Time	s	0.5	0.5	0.5	0.5	0.5	0.5	0.5	0.5
b8-04	Energy Saving Coefficient Value	-	481.7	356.9	356.9	288.2	288.2	223.7	223.7	196.6
C6-02	Carrier Frequency Selection	-	4	7	4	7	4	7	4	7
E2-01 (E4-01)	Motor Rated Current (FLA)	A	0.6	1.1	1.1	1.9	1.9	3.3	3.3	4.9
E2-02 (E4-02)	Motor Rated Slip	Hz	2.5	2.6	2.6	2.9	2.9	2.5	2.5	2.6
E2-03 (E4-03)	Motor No-Load Current	A	0.4	0.8	0.8	1.2	1.2	1.8	1.8	2.3
E2-05 (E4-05)	Motor Line-to-Line Resistance	Ω	35.98	20.56	20.56	9.842	9.842	5.156	5.156	3.577
E2-06 (E4-06)	Motor Leakage Inductance	%	21.6	20.1	20.1	18.2	18.2	13.8	13.8	18.5
E2-10 (E4-10)	Motor Iron Loss	W	6	11	11	14	14	26	26	38
E5-01	PM Motor Code Selection	-	FFFF	FFFF	FFFF	FFFF	FFFF	FFFF	FFFF	FFFF
L2-02	Power Loss Ride Through Time	s	0.1	0.1	0.1	0.1	0.1	0.1	0.2	0.2
L2-03	Minimum Baseblock Time	s	0.2	0.3	0.2	0.3	0.2	0.3	0.3	0.4
L2-04	Powerloss V/f Recovery Ramp Time	s	0.3	0.3	0.3	0.3	0.3	0.3	0.3	0.3
L2-05	Undervoltage Detection Lvl (Uv1)	-	190	190	190	190	190	190	190	190
L3-02	Stall Prevent Level during Accel	%	150	120	150	120	150	120	150	120

1.21 Defaults by Drive Model and Duty Rating ND/HD

No. */	Name	Unit	Default							
			2001		2002		2004		2006	
-	Drive Model	-								
C6-01	Normal / Heavy Duty Selection	-	HD	ND	HD	ND	HD	ND	HD	ND
			0	1	0	1	0	1	0	1
o2-04	Drive Model (KVA) Selection	Hex.	60		61		62		63	
E2-11 (E4-11, E5-02)	Motor Rated Power	kW	0.1	0.2	0.2	0.4	0.4	0.75	0.75	1.1
L3-06	Stall Prevent Level during Run	%	150	120	150	120	150	120	150	120
L3-24	Motor Accel Time @ Rated Torque	s	0.178	0.178	0.178	0.178	0.178	0.142	0.142	0.142
L8-02	Overheat Alarm Level	°C	115	115	115	115	115	115	120	120
L8-09	Output Ground Fault Detection	-	0	0	0	0	0	0	0	0
n1-03	Hunting Prevention Time Constant	ms	10	10	10	10	10	10	10	10
n3-02	HSB Current Limit Level	l	150	120	150	120	150	120	150	120
n5-02	Motor Inertia Acceleration Time	s	0.178	0.178	0.178	0.142	0.178	0.142	0.142	0.142

*1 Parameters within parentheses are for motor 2.

No. */	Name	Unit	Default							
			2010		2012		2021		2030	
-	Drive Model	-								
C6-01	Normal / Heavy Duty Selection	-	HD	ND	HD	ND	HD	ND	HD	ND
			0	1	0	1	0	1	0	1
o2-04	Drive Model (KVA) Selection	Hex.	65		66		68		6A	
E2-11 (E4-11, E5-02)	Motor Rated Power	kW	1.5	2.2	2.2	3.0	3.7	5.5	5.5	7.5
b3-04	V/f Gain during Speed Search	%	100	100	100	100	100	100	100	100
b3-06	Speed Estimation Current Level 1	-	0.5	0.5	0.5	0.5	0.5	0.5	0.5	0.5
b3-08	Speed Estimation ACR P Gain	-	0.5	0.5	0.5	0.5	0.5	0.5	0.5	0.5
b3-26	Direction Determination Level	-	1000	1000	1000	1000	1000	1000	1000	1000
b8-03	Energy Saving Filter Time	s	0.5	0.5	0.5	0.5	0.5	0.5	0.5	0.5
b8-04	Energy Saving Coefficient Value	-	169.4	156.8	156.8	136.4	122.9	94.75	94.75	72.69
C6-02	Carrier Frequency Selection	-	3	7	3	7	3	7	3	7
E2-01 (E4-01)	Motor Rated Current (FLA)	A	6.2	8.5	8.5	11.4	14	19.6	19.6	26.6

1.21 Defaults by Drive Model and Duty Rating ND/HD

No. */	Name	Unit	Default							
			2010		2012		2021		2030	
-	Drive Model	-	HD	ND	HD	ND	HD	ND	HD	ND
C6-01	Normal / Heavy Duty Selection	-	0	1	0	1	0	1	0	1
o2-04	Drive Model (KVA) Selection	Hex.	65		66		68		6A	
E2-11 (E4-11, E5-02)	Motor Rated Power	kW	1.5	2.2	2.2	3.0	3.7	5.5	5.5	7.5
E2-02 (E4-02)	Motor Rated Slip	Hz	2.6	2.9	2.9	2.7	2.73	1.5	1.5	1.3
E2-03 (E4-03)	Motor No-Load Current	A	2.8	3	3	3.7	4.5	5.1	5.1	8
E2-05 (E4-05)	Motor Line-to-Line Resistance	Ω	1.997	1.601	1.601	1.034	0.771	0.399	0.399	0.288
E2-06 (E4-06)	Motor Leakage Inductance	%	18.5	18.4	18.4	19	19.6	18.2	18.2	15.5
E2-10 (E4-10)	Motor Iron Loss	W	53	77	77	91	112	172	172	262
E5-01	PM Motor Code Selection	-	FFFF	FFFF	FFFF	FFFF	FFFF	FFFF	FFFF	FFFF
L2-02	Power Loss Ride Through Time	s	0.3	0.3	0.5	0.5	1	1	1	1
L2-03	Minimum Baseblock Time	s	0.4	0.5	0.5	0.5	0.6	0.7	0.7	0.8
L2-04	Powerloss V/f Recovery Ramp Time	s	0.3	0.3	0.3	0.3	0.3	0.3	0.3	0.3
L2-05	Undervoltage Detection Lvl (Uv1)	-	190	190	190	190	190	190	190	190
L3-02	Stall Prevent Level during Accel	%	150	120	150	120	150	120	150	120
L3-06	Stall Prevent Level during Run	%	150	120	150	120	150	120	150	120
L3-24	Motor Accel Time @ Rated Torque	s	0.166	0.145	0.145	0.145	0.154	0.168	0.168	0.175
L8-02	Overheat Alarm Level	°C	110	110	110	110	115	115	105	105
L8-09	Output Ground Fault Detection	-	0	0	0	0	0	0	1	1
n1-03	Hunting Prevention Time Constant	ms	10	10	10	10	10	10	10	10
n3-02	HSB Current Limit Level	l	150	120	150	120	150	120	150	120
n5-02	Motor Inertia Acceleration Time	s	0.166	0.145	0.145	0.145	0.154	0.168	0.168	0.175

*1 Parameters within parentheses are for motor 2.

1.21 Defaults by Drive Model and Duty Rating ND/HD

No. */	Name	Unit	Default							
			2042		2056		2070		2082	
-	Drive Model	-	HD	ND	HD	ND	HD	ND	HD	ND
C6-01	Normal / Heavy Duty Selection	-	0	1	0	1	0	1	0	1
o2-04	Drive Model (KVA) Selection	Hex.	6B		6D		6E		6F	
E2-11 (E4-11, E5-02)	Motor Rated Power	kW	7.5	11	11	15	15	18.5	18.5	22
b3-04	V/f Gain during Speed Search	%	100	100	100	100	100	100	100	100
b3-06	Speed Estimation Current Level 1	-	0.5	0.5	0.5	0.5	0.5	0.5	0.5	0.5
b3-08	Speed Estimation ACR P Gain	-	0.5	0.5	0.5	0.5	0.5	0.5	0.5	0.5
b3-26	Direction Determination Level	-	1000	1000	1000	1000	1000	1000	1000	1000
b8-03	Energy Saving Filter Time	s	0.5	0.5	0.5	0.5	0.5	0.5	0.5	0.5
b8-04	Energy Saving Coefficient Value	-	72.69	70.44	70.44	63.13	63.13	57.87	57.87	51.79
C6-02	Carrier Frequency Selection	-	3	7	3	7	3	7	3	7
E2-01 (E4-01)	Motor Rated Current (FLA)	A	26.6	39.7	39.7	53	53	65.8	65.8	77.2
E2-02 (E4-02)	Motor Rated Slip	Hz	1.3	1.7	1.7	1.6	1.6	1.67	1.67	1.7
E2-03 (E4-03)	Motor No-Load Current	A	8	11.2	11.2	15.2	15.2	15.7	15.7	18.5
E2-05 (E4-05)	Motor Line-to-Line Resistance	Ω	0.288	0.23	0.23	0.138	0.138	0.101	0.101	0.079
E2-06 (E4-06)	Motor Leakage Inductance	%	15.5	19.5	19.5	17.2	17.2	15.7	20.1	19.5
E2-10 (E4-10)	Motor Iron Loss	W	262	245	245	272	272	505	505	538
E5-01	PM Motor Code Selection	-	FFFF	FFFF	FFFF	FFFF	FFFF	FFFF	FFFF	FFFF
L2-02	Power Loss Ride Through Time	s	1	1	2	2	2	2	2	2
L2-03	Minimum Baseblock Time	s	0.8	0.9	0.9	1	1	1	1	1
L2-04	Powerloss V/f Recovery Ramp Time	s	0.3	0.3	0.3	0.6	0.6	0.6	0.6	0.6
L2-05	Undervoltage Detection Lvl (Uv1)	-	190	190	190	190	190	190	190	190
L3-02	Stall Prevent Level during Accel	%	150	120	150	120	150	120	150	120
L3-06	Stall Prevent Level during Run	%	150	120	150	120	150	120	150	120

No. */	Name	Unit	Default							
			2042		2056		2070		2082	
-	Drive Model	-								
C6-01	Normal / Heavy Duty Selection	-	HD	ND	HD	ND	HD	ND	HD	ND
			0	1	0	1	0	1	0	1
o2-04	Drive Model (KVA) Selection	Hex.	6B		6D		6E		6F	
E2-11 (E4-11, E5-02)	Motor Rated Power	kW	7.5	11	11	15	15	18.5	18.5	22
L3-24	Motor Accel Time @ Rated Torque	s	0.175	0.265	0.265	0.244	0.244	0.317	0.317	0.355
L8-02	Overheat Alarm Level	°C	115	115	125	125	120	120	135	135
L8-09	Output Ground Fault Detection	-	1	1	1	1	1	1	1	1
n1-03	Hunting Prevention Time Constant	ms	10	10	10	10	10	10	10	10
n3-02	HSB Current Limit Level	l	150	120	150	120	150	120	150	120
n5-02	Motor Inertia Acceleration Time	s	0.175	0.265	0.265	0.244	0.244	0.317	0.317	0.355

*1 Parameters within parentheses are for motor 2.

◆ Three-Phase 400 V Class

No. */	Name	Unit	Default							
			4001		4002		4004		4005	
-	Drive Model	-								
C6-01	Normal / Heavy Duty Selection	-	HD	ND	HD	ND	HD	ND	HD	ND
			0	1	0	1	0	1	0	1
o2-04	Drive Model (KVA) Selection	Hex.	91		92		93		94	
E2-11 (E4-11, E5-02)	Motor Rated Power	kW	0.2	0.4	0.4	0.75	0.75	1.5	1.5	2.2
b3-04	V/f Gain during Speed Search	%	100	100	100	100	100	100	100	100
b3-06	Speed Estimation Current Level 1	-	1.0	1.0	0.5	0.5	0.5	0.5	0.5	0.5
b3-08	Speed Estimation ACR P Gain	-	0.5	0.5	0.5	0.5	0.5	0.5	0.5	0.5
b3-26	Direction Determination Level	-	1000	1000	1000	1000	1000	1000	1000	1000
b8-03	Energy Saving Filter Time	s	0.5	0.5	0.5	0.5	0.5	0.5	0.5	0.5
b8-04	Energy Saving Coefficient Value	-	713.8	576.4	576.4	447.4	447.4	338.8	338.8	313.6
C6-02	Carrier Frequency Selection	-	3	7	3	7	3	7	3	7
E2-01 (E4-01)	Motor Rated Current (FLA)	A	0.6	1	1	1.6	1.6	3.1	3.1	4.2

1.21 Defaults by Drive Model and Duty Rating ND/HD

No. */	Name	Unit	Default							
			4001		4002		4004		4005	
-	Drive Model	-	HD	ND	HD	ND	HD	ND	HD	ND
C6-01	Normal / Heavy Duty Selection	-	0	1	0	1	0	1	0	1
o2-04	Drive Model (KVA) Selection	Hex.	91		92		93		94	
E2-11 (E4-11, E5-02)	Motor Rated Power	kW	0.2	0.4	0.4	0.75	0.75	1.5	1.5	2.2
E2-02 (E4-02)	Motor Rated Slip	Hz	2.5	2.9	2.9	2.6	2.6	2.5	2.5	3
E2-03 (E4-03)	Motor No-Load Current	A	0.4	0.6	0.6	0.8	0.8	1.4	1.4	1.5
E2-05 (E4-05)	Motor Line-to-Line Resistance	Ω	83.94	38.198	38.198	22.459	22.459	10.1	10.1	6.495
E2-06 (E4-06)	Motor Leakage Inductance	%	21.9	18.2	18.2	14.3	14.3	18.3	18.3	18.7
E2-10 (E4-10)	Motor Iron Loss	W	12	14	14	26	26	53	53	77
E5-01	PM Motor Code Selection	-	FFFF	FFFF	FFFF	FFFF	FFFF	FFFF	FFFF	FFFF
L2-02	Power Loss Ride Through Time	s	0.1	0.1	0.1	0.1	0.2	0.2	0.3	0.3
L2-03	Minimum Baseblock Time	s	0.2	0.2	0.2	0.3	0.3	0.4	0.4	0.5
L2-04	Powerloss V/f Recovery Ramp Time	s	0.3	0.3	0.3	0.3	0.3	0.3	0.3	0.3
L2-05	Undervoltage Detection Lvl (Uvl)	-	380	380	380	380	380	380	380	380
L3-02	Stall Prevent Level during Accel	%	150	120	150	120	150	120	150	120
L3-06	Stall Prevent Level during Run	%	150	120	150	120	150	120	150	120
L3-24	Motor Accel Time @ Rated Torque	s	0.178	0.178	0.178	0.142	0.142	0.166	0.166	0.145
L8-02	Overheat Alarm Level	°C	120	120	120	120	105	105	90	90
L8-09	Output Ground Fault Detection	-	0	0	0	0	0	0	0	0
n1-03	Hunting Prevention Time Constant	ms	10	10	10	10	10	10	10	10
n3-02	HSB Current Limit Level	%	150	120	150	120	150	120	150	120
n5-02	Motor Inertia Acceleration Time	s	0.178	0.178	0.178	0.142	0.142	0.166	0.166	0.145

*1 Parameters within parentheses are for motor 2.

1.21 Defaults by Drive Model and Duty Rating ND/HD

No. */	Name	Unit	Default							
			4007		4009		4012		4018	
-	Drive Model	-	HD	ND	HD	ND	HD	ND	HD	ND
C6-01	Normal / Heavy Duty Selection	-	0	1	0	1	0	1	0	1
o2-04	Drive Model (KVA) Selection	Hex.	95		96		97		99	
E2-11 (E4-11, E5-02)	Motor Rated Power	kW	2.2	3.0	3.0	3.7	4.0	5.5	5.5	7.5
b3-04	V/f Gain during Speed Search	%	100	100	100	100	100	100	100	100
b3-06	Speed Estimation Current Level 1	-	0.5	0.5	0.5	0.5	0.5	0.5	0.5	0.5
b3-08	Speed Estimation ACR P Gain	-	0.5	0.5	0.5	0.5	0.5	0.5	0.5	0.5
b3-26	Direction Determination Level	-	1000	1000	1000	1000	1000	1000	1000	1000
b8-03	Energy Saving Filter Time	s	0.5	0.5	0.5	0.5	0.5	0.5	0.5	0.5
b8-04	Energy Saving Coefficient Value	-	313.6	265.7	265.7	245.8	245.8	189.5	189.5	145.38
C6-02	Carrier Frequency Selection	-	3	7	3	7	3	7	3	7
E2-01 (E4-01)	Motor Rated Current (FLA)	A	4.2	5.7	5.7	7	7	9.8	9.8	13.3
E2-02 (E4-02)	Motor Rated Slip	Hz	3	2.7	2.7	2.7	2.7	1.5	1.5	1.3
E2-03 (E4-03)	Motor No-Load Current	A	1.5	1.9	1.9	2.3	2.3	2.6	2.6	4
E2-05 (E4-05)	Motor Line-to-Line Resistance	Ω	6.495	4.36	4.36	3.333	3.333	1.595	1.595	1.152
E2-06 (E4-06)	Motor Leakage Inductance	%	18.7	19	19	19.3	19.3	18.2	18.2	15.5
E2-10 (E4-10)	Motor Iron Loss	W	77	105	105	130	130	193	193	263
E5-01	PM Motor Code Selection	-	FFFF	FFFF	FFFF	FFFF	FFFF	FFFF	FFFF	FFFF
L2-02	Power Loss Ride Through Time	s	0.5	0.5	0.5	0.5	0.5	0.5	0.8	0.8
L2-03	Minimum Baseblock Time	s	0.5	0.5	0.5	0.6	0.6	0.7	0.7	0.8
L2-04	Powerloss V/f Recovery Ramp Time	s	0.3	0.3	0.3	0.3	0.3	0.3	0.3	0.3
L2-05	Undervoltage Detection Lvl (Uv1)	-	380	380	380	380	380	380	380	380
L3-02	Stall Prevent Level during Accel	%	150	120	150	120	150	120	150	120
L3-06	Stall Prevent Level during Run	%	150	120	150	120	150	120	150	120

1.21 Defaults by Drive Model and Duty Rating ND/HD

No. */	Name	Unit	Default							
			4007		4009		4012		4018	
-	Drive Model	-								
C6-01	Normal / Heavy Duty Selection	-	HD	ND	HD	ND	HD	ND	HD	ND
			0	1	0	1	0	1	0	1
o2-04	Drive Model (KVA) Selection	Hex.	95		96		97		99	
E2-11 (E4-11, E5-02)	Motor Rated Power	kW	2.2	3.0	3.0	3.7	4.0	5.5	5.5	7.5
L3-24	Motor Accel Time @ Rated Torque	s	0.145	0.145	0.145	0.154	0.154	0.168	0.168	0.175
L8-02	Overheat Alarm Level	°C	90	90	115	115	110	110	120	120
L8-09	Output Ground Fault Detection	-	0	0	0	0	0	0	0	0
n1-03	Hunting Prevention Time Constant	ms	10	10	10	10	10	10	10	10
n3-02	HSB Current Limit Level	%	150	120	150	120	150	120	150	120
n5-02	Motor Inertia Acceleration Time	s	0.145	0.145	0.145	0.154	0.154	0.168	0.168	0.175

*1 Parameters within parentheses are for motor 2.

No. */	Name	Unit	Default							
			4023		4031		4038		4044	
-	Drive Model	-								
C6-01	Normal / Heavy Duty Selection	-	HD	ND	HD	ND	HD	ND	HD	ND
			0	1	0	1	0	1	0	1
o2-04	Drive Model (KVA) Selection	Hex.	9A		REV:A: 9C REV:B: 19C *2		REV:A: 9D REV:B: 19D *2		9E	
E2-11 (E4-11, E5-02)	Motor Rated Power	kW	7.5	11	11	15	15	18.5	18.5	22
b3-04	V/f Gain during Speed Search	%	100	100	100	100	100	100	100	100
b3-06	Speed Estimation Current Level 1	-	0.5	0.5	0.5	0.5	0.5	0.5	0.5	0.5
b3-08	Speed Estimation ACR P Gain	-	0.5	0.5	0.5	0.5	0.5	0.5	0.5	0.5
b3-26	Direction Determination Level	-	1000	1000	1000	1000	1000	1000	1000	1000
b8-03	Energy Saving Filter Time	s	0.5	0.5	0.5	0.5	0.5	0.5	0.5	0.5
b8-04	Energy Saving Coefficient Value	-	145.38	140.88	140.88	126.26	126.26	115.74	115.74	103.58
C6-02	Carrier Frequency Selection	-	3	7	3	7	3	7	3	7
E2-01 (E4-01)	Motor Rated Current (FLA)	A	13.3	19.9	19.9	26.5	26.5	32.9	32.9	38.6
E2-02 (E4-02)	Motor Rated Slip	Hz	1.3	1.7	1.7	1.6	1.6	1.67	1.67	1.7

1.21 Defaults by Drive Model and Duty Rating ND/HD

No. */	Name	Unit	Default							
			4023		4031		4038		4044	
-	Drive Model	-	HD	ND	HD	ND	HD	ND	HD	ND
C6-01	Normal / Heavy Duty Selection	-	0	1	0	1	0	1	0	1
o2-04	Drive Model (KVA) Selection	Hex.	9A		REV:A: 9C REV:B: 19C *2		REV:A: 9D REV:B: 19D *2		9E	
E2-11 (E4-11, E5-02)	Motor Rated Power	kW	7.5	11	11	15	15	18.5	18.5	22
E2-03 (E4-03)	Motor No-Load Current	A	4	5.6	5.6	7.6	7.6	7.8	7.8	9.2
E2-05 (E4-05)	Motor Line-to-Line Resistance	Ω	1.152	0.922	0.922	0.55	0.55	0.403	0.403	0.316
E2-06 (E4-06)	Motor Leakage Inductance	%	15.5	19.6	19.6	17.2	17.2	20.1	20.1	23.5
E2-10 (E4-10)	Motor Iron Loss	W	263	385	385	440	440	508	508	586
E5-01	PM Motor Code Selection	-	FFFF	FFFF	FFFF	FFFF	FFFF	FFFF	FFFF	FFFF
L2-02	Power Loss Ride Through Time	s	1	1	2	2	2	2	2	2
L2-03	Minimum Baseblock Time	s	0.8	0.9	0.9	1	1	1	1	1
L2-04	Powerloss V/f Recovery Ramp Time	s	0.3	0.3	0.3	0.6	0.6	0.6	0.6	0.6
L2-05	Undervoltage Detection Lvl (Uv1)	-	380	380	380	380	380	380	380	380
L3-02	Stall Prevent Level during Accel	%	150	120	150	120	150	120	150	120
L3-06	Stall Prevent Level during Run	%	150	120	150	120	150	120	150	120
L3-24	Motor Accel Time @ Rated Torque	s	0.175	0.265	0.265	0.244	0.244	0.317	0.317	0.355
L8-02	Overheat Alarm Level	°C	120	120	120	120	120	120	125	125
L8-09	Output Ground Fault Detection	-	0	0	1	1	1	1	1	1
n1-03	Hunting Prevention Time Constant	ms	10	10	10	10	10	10	10	10
n3-02	HSB Current Limit Level	%	150	120	150	120	150	120	150	120
n5-02	Motor Inertia Acceleration Time	s	0.175	0.265	0.265	0.244	0.244	0.317	0.317	0.355

*1 Parameters within parentheses are for motor 2.

*2 The value is different for different drive hardware revisions. The "REV" column on the nameplate on the right side of the drive identifies the hardware revision.

1.21 Defaults by Drive Model and Duty Rating ND/HD

No. */	Name	Unit	Default	
-	Drive Model	-	4060	
C6-01	Normal / Heavy Duty Selection	-	HD	ND
			0	1
o2-04	Drive Model (KVA) Selection	Hex.	9F	
E2-11 (E4-11, E5-02)	Motor Rated Power	kW	22	30
b3-04	V/f Gain during Speed Search	%	100	100
b3-06	Speed Estimation Current Level 1	-	0.5	0.5
b3-08	Speed Estimation ACR P Gain	-	0.5	0.5
b3-26	Direction Determination Level	-	1000	1000
b8-03	Energy Saving Filter Time	s	0.5	0.5
b8-04	Energy Saving Coefficient Value	-	103.58	92.54
C6-02	Carrier Frequency Selection	-	3	7
E2-01 (E4-01)	Motor Rated Current (FLA)	A	38.6	52.3
E2-02 (E4-02)	Motor Rated Slip	Hz	1.7	1.8
E2-03 (E4-03)	Motor No-Load Current	A	9.2	10.9
E2-05 (E4-05)	Motor Line-to-Line Resistance	Ω	0.316	0.269
E2-06 (E4-06)	Motor Leakage Inductance	%	23.5	20.7
E2-10 (E4-10)	Motor Iron Loss	W	586	750
E5-01	PM Motor Code Selection	-	FFFF	FFFF
L2-02	Power Loss Ride Through Time	s	2	2
L2-03	Minimum Baseblock Time	s	1	1.1
L2-04	Powerloss V/f Recovery Ramp Time	s	0.6	0.6
L2-05	Undervoltage Detection Lvl (Uv1)	-	380	380
L3-02	Stall Prevent Level during Accel	%	150	120
L3-06	Stall Prevent Level during Run	%	150	120
L3-24	Motor Accel Time @ Rated Torque	s	0.355	0.323
L8-02	Overheat Alarm Level	°C	115	115
L8-09	Output Ground Fault Detection	-	1	1
n1-03	Hunting Prevention Time Constant	ms	10	10
n3-02	HSB Current Limit Level	%	150	120
n5-02	Motor Inertia Acceleration Time	s	0.355	0.323

*1 Parameters within parentheses are for motor 2.

Parameter Details

2.1	Section Safety	144
2.2	A: Initialization Parameters.....	145
2.3	b: Application	157
2.4	C: Tuning	203
2.5	d: References	225
2.6	E: Motor Parameters.....	241
2.7	F: Options.....	262
2.8	H: Terminal Function Selection	287
2.9	L: Protection Functions	357
2.10	n: Special Adjustment.....	405
2.11	o: Keypad-Related Settings	427
2.12	T: Auto-Tuning.....	449

2.1 Section Safety

 **DANGER**

Do not ignore the safety messages in this manual.

If you ignore the safety messages in this manual, it will cause serious injury or death. The manufacturer is not responsible for injuries or damage to equipment.

2.2 A: Initialization Parameters

A parameters [Initialization Parameters] set the operating environment and operating conditions for the drive.

◆ A1: Initialization

A1 parameters set the operating environment and operating conditions for the drive. For example, these parameters set the keypad language, the control method, and the parameter access level for the drive.

■ A1-00: Language Selection

No. (Hex.)	Name	Description	Default (Range)
A1-00 (0100) RUN	Language Selection	<div style="display: flex; gap: 5px;"> V/f OLV OLV/PM AOLV/PM EZOLV </div> Sets the language for the LCD keypad.	0 (0 - 12)

Note:

- This parameter is only available when you use an LCD keypad or a Bluetooth LCD Keypad.
- When you use A1-03 [Initialize Parameters] to initialize the drive, the drive will not reset this parameter.

0 : English

1 : Japanese

2 : German

3 : French

4 : Italian

5 : Spanish

6 : Portuguese

7 : Chinese

8 : Czech

9 : Russian

10 : Turkish

11 : Polish

12 : Greek

■ A1-01: Access Level Selection

No. (Hex.)	Name	Description	Default (Range)
A1-01 (0101) RUN	Access Level Selection	<div style="display: flex; gap: 5px;"> V/f OLV OLV/PM AOLV/PM EZOLV </div> Sets user access to parameters. The access level controls which parameters the keypad will display, and which parameters the user can set.	2 (0 - 3)

0 : Operation Only

Access to A1-00, A1-01, A1-04 [Password], and the U Monitors.

1 : User Parameters

Access to A1-00, A1-01, A1-04, and A2-01 to A2-32 [User Parameters 1 to 32].

2 : Advanced Level

Access to all parameters, but not Expert Mode parameters.

3 : Expert Level

Access to all parameters including Expert Mode parameters.

Table 2.1 shows which keypad screens are available for each A1-01 settings.

Table 2.1 Access Level and Available Keypad Screens

Mode	Keypad Screen	A1-01 [Access Level Selection] Setting			
		0	1	2	3
Drive Mode	Monitors	Yes	Yes	Yes	Yes
Programming Mode	Parameters	Yes	Yes	Yes	Yes
	User Custom Parameters	No	Yes	Yes	Yes
	Parameter Backup/Restore	No	No	Yes	Yes
	Modified Parameters/Fault Log	No	No	Yes	Yes
	Auto-Tuning	No	No	Yes	Yes
	Initial Setup Screen	No	No	Yes	Yes
	Diagnostic Tools	No	No	Yes	Yes

Note:

- When you use A1-04 and A1-05 [Password Setting] to set a password, you cannot change the values set in A1-01 to A1-03, A1-06, A1-07, or A2-01 to A2-32.
- When H1-xx = 1B [MFDI Function Select = Program Lockout], you must activate the terminal to change parameter settings.
- When you use MEMOBUS/Modbus communications, you must send the Enter command from the controller to the drive and complete the serial communication write process before you can use the keypad to change parameter settings.

■ A1-02: Control Method Selection

No. (Hex.)	Name	Description	Default (Range)
A1-02 (0102)	Control Method Selection	<div style="display: flex; gap: 5px;"> V/f OLV OLV/PM AOLV/PM EZOLV </div> Sets the control method for the drive application and the motor.	2 (0, 2, 5, 6, 8)

Note:

When you change the control methods, the parameter values specified by A1-02 and E3-01 [Motor 2 Control Mode Selection] are changed to their default values.

Sets the control method for the drive application and the motor.

0 : V/f Control

Use this control method in these applications and conditions:

- For general variable-speed control applications in which a high level of responsiveness or high-precision speed control is not necessary.
- Applications in which more than one motor are connected to one drive
- When there is not sufficient data to set the motor parameters
- When it is not possible to do Auto-Tuning. The speed control range is 1:40.

2 : Open Loop Vector

Use this control method for general variable-speed control applications in which high-precision speed control is necessary. In this control method, a feedback signal from the motor is not necessary to have high torque response and high torque when operating at low speeds. The speed control range is 1:100.

5 : PM Open Loop Vector

The drive controls an IPM motor or SPM motor in this control method. Use this control method for general variable-speed control applications in which a high level of responsiveness or high-precision speed control are not necessary. The speed control range is 1:10.

6 : PM Advanced Open Loop Vector

The drive can control an IPM motor in this control method. Use this control method for general variable-speed control applications in which high-precision speed control and torque limit are necessary. The speed control range is 1:20. The speed control range is 1:10 when n8-57 = 1 [HFI Overlap Selection = Enabled].

8 : EZ Vector Control

The drive controls induction motors and PM motors in this control method. This control method uses an easier procedure to operate motors with more efficiency. Use this control method for derating torque applications. For example, fans and pumps.

■ A1-03: Initialize Parameters

No. (Hex.)	Name	Description	Default (Range)
A1-03 (0103)	Initialize Parameters	V/f OLV OLV/PM AOLV/PM EZOLV Sets parameters to default values.	0 (0 - 3330)

Note:

- After you initialize the drive, the drive automatically sets $A1-03 = 0$.
- User Parameters can save the parameter values for your application and use these values as default values for drive initialization.
- To use the 2 motor switchover function, first turn OFF the terminal to which $H1-xx = 16$ [MFDI Function Selection = Motor 2 Selection] is set, then change the $A1-03$ setting. An incorrect procedure will trigger $oPE08$ [Parameter Selection Error].

0 : No Initialization

1110 : User Initialization

Sets parameters to the values set by the user as user settings. Set $o2-03 = 1$ [User Parameter Default Value = Set defaults] to save the user settings.

You can save the parameter settings that were adjusted for the test run as user-set default values to the drive. When you make changes to the parameter values after you save the settings as User Parameter Settings, the drive will set the parameters to the User Parameter Setting value when you initialize with $A1-03 = 1110$.

Follow this procedure to save User Parameter setting values, and to do a User Initialization.

1. Set parameters correctly for the application.
2. Set $o2-03 = 1$ [User Parameter Default Value = Set defaults].
This saves parameter settings for a User Initialization.
The drive will then automatically set $o2-03 = 0$.
3. Set $A1-03 = 1110$ to reset to the saved parameter settings.
When you initialize the drive, the drive sets the parameter values to the User Parameter setting values.

2220 : 2-Wire Initialization

Sets MFDI terminal S1 to Forward Run and terminal S2 to Reverse Run, and resets all parameters to default settings.

3330 : 3-Wire Initialization

Sets MFDI terminal S1 to Run, terminal S2 to Stop, and terminal S5 to FWD/REV, and resets all parameters to default settings.

The drive will not initialize the parameters in [Table 2.2](#) when $A1-03 = 2220, 3330$.

Table 2.2 Parameters that are not Initialized Using a 2-Wire Sequence or a 3-Wire Sequence

No.	Name
A1-00	Language Selection
A1-02	Control Method Selection
A1-07	DriveWorksEZ Function Selection
A1-12 <i>*1</i>	Bluetooth ID
E1-03	V/f Pattern Selection
E5-01	PM Motor Code Selection
E5-02	PM Motor Rated Power
E5-03	Motor Rated Current (FLA)
E5-04	PM Motor Pole Count
E5-05	PM Motor Resistance (ohms/phase)
E5-06	PM d-axis Inductance (mH/phase)
E5-07	PM q-axis Inductance (mH/phase)

2.2 A: Initialization Parameters





No.	Name
E5-09	PM Back-EMF V _{peak} (mV/(rad/s))
E5-24	PM Back-EMF L-L V _{rms} (mV/rpm)
E5-25	Polarity Estimation Timeout
F6-08	Comm Parameter Reset @Initialize
F6-xx/F7-xx	Communication Option Parameters Set F6-08 = 1 [Comm Parameter Reset @Initialize = Reset Back to Factory Default] to initialize communication option parameters.
L8-35	Installation Method Selection
o2-04	Drive Model (KVA) Selection
q1-xx - q8-xx	DriveWorksEZ Parameters
r1-xx	DWEZ Connection 1-20

*1 When you use A1-03 [Initialize Parameters] to initialize drives with software versions PRG:01013 and later, the drive will not reset A1-12. The "PRG" column on the nameplate on the right side of the drive identifies the software version. You can also use UI-25 [SoftwareNumber Flashr] to identify the software version.

Note:

- Set A1-06 [Application Preset] to let the drive automatically set the best parameter settings for the selected application. The drive does not initialize A1-02 when A1-03 = 2220, 3330.
- When A1-03 = 2220, 3330, the drive automatically set A1-05 [Password Setting] = 0000. Make sure that you set the password again for applications where a password is necessary.

■ A1-04: Password

No. (Hex.)	Name	Description	Default (Range)
A1-04 (0104)	Password	     Entry point for the password set in A1-05 [Password Setting]. The user can view the settings of parameters that are locked without entering the password. Enter the correct password in this parameter to change parameter settings.	0000 (0000 - 9999)

If the password entered in A1-04 does not agree with the password setting in A1-05, you cannot change these parameters:

- A1-01 [Access Level Selection]
- A1-02 [Control Method Selection]
- A1-03 [Initialize Parameters]
- A1-06 [Application Preset]
- A1-07 [DriveWorksEZ Function Selection]
- A2-01 to A2-32 [User Parameter 1 to 32]









To lock parameter settings after making changes without changing the password, enter the incorrect password in A1-04 and push .





Enter the Password to Unlock Parameters

Use this procedure to unlock parameter settings.

Set the password in A1-05 [Password Setting], and show the Parameter Setting Mode screen on the keypad.





This procedure verifies the password, and makes sure that the parameter settings are unlocked.

1. Push  or  to select "A: Initialization Parameters", then push .
2. Push  or  to select [A1-04], then push .
You can now change parameter settings.
3. Push  or  to move the digit and enter the password.
4. Push  to confirm the password.
The drive unlocks the parameters and automatically shows the Parameters Screen.

5. Push  or  to show [A1-02], then push .
- The keypad shows the setting value for [A1-02].
6. Push  or  to make sure that you can change the setting value.

Push  (Back) until the keypad shows the Parameter Setup Mode screen.



■ A1-05: Password Setting

No. (Hex.)	Name	Description	Default (Range)
A1-05 (0105)	Password Setting	     Set the password to lock parameters and prevent changes to parameter settings. Enter the correct password in A1-04 [Password] to unlock parameters and accept changes.	0000 (0000 - 9999)

This parameter locks these parameters:





- A1-01 [Access Level Selection]
- A1-02 [Control Method Selection]
- A1-03 [Initialize Parameters]
- A1-06 [Application Preset]
- A1-07 [DriveWorksEZ Function Selection]
- A2-01 to A2-32 [User Parameter 1 to 32]

Note:

- Usually, the keypad will not show A1-05. To show and set A1-05, show A1-04 [Password] and then push  and  on the keypad at the same time.
- After you set A1-05, the keypad will not show it again until you enter the correct password in A1-04. Make sure that you remember the A1-05 setting value. If you do not know the A1-05 setting value, contact Yaskawa or your nearest sales representative.
- When A1-03 = 2220, 3330 [2-Wire Initialization, 3-Wire Initialization], the drive is initialized to A1-05 = 0000. Be sure to set the password again when a password is necessary for the application.
- Change the setting value in A1-05 to change the password. The new setting value becomes the new password.
- When you use the password to unlock and change a parameter, enter a value other than the password in A1-04 to lock the parameter again with the same password.
- If A1-04 ≠ A1-05, MEMOBUS Communication cannot read or write A1-05.

■ A1-06: Application Preset

WARNING! Sudden Movement Hazard. Check the I/O signals and the external sequences for the drive before you set the Application Preset function. When you set the Application Preset function (A1-06 ≠ 0), it changes the I/O terminal functions for the drive and it can cause equipment to operate unusually. This can cause serious injury or death.

No. (Hex.)	Name	Description	Default (Range)
A1-06 (0127)	Application Preset	     Sets the drive to operate in selected application conditions.	0 (0 - 5, 8)

The drive software contains the application presets shown below. Set A1-06 to align with the application to let the drive automatically set the best parameter settings for the selected application. The drive saves parameters that you frequently use the application in parameters A2-01 to A2-16 [User Parameters 1 to 16] for easy configuration and reference in Setup Mode.

- Water supply pump
- Conveyor
- Exhaust fan
- HVAC fan
- Air compressor

2.2 A: Initialization Parameters

Note:

- Before you set *A1-06*, make sure that you set *A1-03* = 2220, 3330 [*Initialize Parameters* = 2-Wire Initialization, 3-Wire Initialization] to initialize parameters.
- It is not possible to change the *A1-06* value. To set an application preset, set *A1-03* = 2220 to initialize parameters, then set this parameter. If initializing all parameters will cause a problem, do not change the settings.
If you set *A2-33* = 1 [*User Parameter Auto Selection* = Enabled: Auto Save Recent Params] to set parameters to *A2-17* to *A2-32* [*User Parameters 17 to 32*] automatically, the drive will reset these parameters when you change the *A1-06* setting.

0 : General-purpose

The drive saves the parameters in [Table 2.3](#) as User Parameters.

Table 2.3 Parameters Saved as User Parameters with the General-purpose Preset

User Parameter No.	Parameter No. Saved	Name
A2-01	A1-02	Control Method Selection
A2-02	b1-01	Frequency Reference Selection 1
A2-03	b1-02	Run Command Selection 1
A2-04	b1-03	Stopping Method Selection
A2-05	C1-01	Acceleration Time 1
A2-06	C1-02	Deceleration Time 1
A2-07	C6-01	Normal / Heavy Duty Selection
A2-08	C6-02	Carrier Frequency Selection
A2-09	d1-01	Reference 1
A2-10	d1-02	Reference 2
A2-11	d1-03	Reference 3
A2-12	d1-04	Reference 4
A2-13	d1-17	Jog Reference
A2-14	E1-01	Input AC Supply Voltage
A2-15	E1-03	V/f Pattern Selection
A2-16	E1-04	Maximum Output Frequency
A2-17	E1-05	Maximum Output Voltage
A2-18	E1-06	Base Frequency
A2-19	E1-09	Minimum Output Frequency
A2-20	E1-13	Base Voltage
A2-21	E2-01	Motor Rated Current (FLA)
A2-22	E2-04	Motor Pole Count
A2-23	E2-11	Motor Rated Power
A2-24	H4-02	Terminal AM Analog Output Gain
A2-25	L1-01	Motor Overload (oL1) Protection
A2-26	L3-04	Stall Prevention during Decel

1 : Water Supply Pump 2

The drive automatically sets the parameters in [Table 2.4](#) for a water supply pump application.

Table 2.4 Best Parameter Settings for Water Supply Pump Applications

No.	Name	Optimal Value
A1-02	Control Method Selection	0: V/f Control
b1-04	Reverse Operation Selection	1: Reverse Disabled
C1-01	Acceleration Time 1	1.0 s
C1-02	Deceleration Time 1	1.0 s

No.	Name	Optimal Value
C6-01	Normal / Heavy Duty Selection	1: Normal Duty Rating
E1-03	V/f Pattern Selection	F: Custom
E1-07	Mid Point A Frequency	30.0 Hz
E1-08	Mid Point A Voltage	50.0 V
L2-01	Power Loss Ride Through Select	1: Enabled
L3-04	Stall Prevention during Decel	1: General Purpose

The drive saves the parameters in [Table 2.5](#) as User Parameters.

Table 2.5 Parameters Saved as User Parameters with the Water Supply Pump Preset

User Parameter No.	Parameter No. Saved	Name
A2-01	b1-01	Frequency Reference Selection 1
A2-02	b1-02	Run Command Selection 1
A2-03	b1-04	Reverse Operation Selection
A2-04	C1-01	Acceleration Time 1
A2-05	C1-02	Deceleration Time 1
A2-06	E1-03	V/f Pattern Selection
A2-07	E1-07	Mid Point A Frequency
A2-08	E1-08	Mid Point A Voltage
A2-09	E2-01	Motor Rated Current (FLA)
A2-10	H1-05	Terminal S5 Function Selection
A2-11	H1-06	Terminal S6 Function Selection
A2-12	H1-07	Terminal S7 Function Selection
A2-13	L5-01	Number of Auto-Restart Attempts

2 : Conveyor

The drive automatically sets the parameters in [Table 2.6](#) for a conveyor application.

Table 2.6 Best Parameter Settings for Conveyor Applications

No.	Name	Optimal Value
A1-02	Control Method Selection	0: V/f Control
C1-01	Acceleration Time 1	3.0 s
C1-02	Deceleration Time 1	3.0 s
C6-01	Normal / Heavy Duty Selection	0: Heavy Duty Rating
L3-04	Stall Prevention during Decel	1: General Purpose

The drive saves the parameters in [Table 2.7](#) as User Parameters.

Table 2.7 Parameters Saved as User Parameters with the Conveyor Preset

User Parameter No.	Parameter No. Saved	Name
A2-01	A1-02	Control Method Selection
A2-02	b1-01	Frequency Reference Selection 1
A2-03	b1-02	Run Command Selection 1
A2-04	C1-01	Acceleration Time 1
A2-05	C1-02	Deceleration Time 1
A2-06	E2-01	Motor Rated Current (FLA)
A2-07	L3-04	Stall Prevention during Decel

3 : Exhaust Fan

The drive automatically sets the parameters in [Table 2.8](#) for an exhaust fan application.

Table 2.8 Best Parameter Settings for Exhaust Fan Applications

No.	Name	Optimal Value
A1-02	Control Method Selection	0: V/f Control
b1-04	Reverse Operation Selection	1: Reverse Disabled
C6-01	Normal / Heavy Duty Selection	1: Normal Duty Rating
E1-03	V/f Pattern Selection	F: Custom
E1-07	Mid Point A Frequency	30.0 Hz
E1-08	Mid Point A Voltage	50.0 V
L2-01	Power Loss Ride Through Select	1: Enabled
L3-04	Stall Prevention during Decel	1: General Purpose

The drive saves the parameters in [Table 2.9](#) as User Parameters.

Table 2.9 Parameters Saved as User Parameters with the Exhaust Fan Preset

User Parameter No.	Parameter No. Saved	Name
A2-01	b1-01	Frequency Reference Selection 1
A2-02	b1-02	Run Command Selection 1
A2-03	b1-04	Reverse Operation Selection
A2-04	b3-01	Speed Search at Start Selection
A2-05	C1-01	Acceleration Time 1
A2-06	C1-02	Deceleration Time 1
A2-07	E1-03	V/f Pattern Selection
A2-08	E1-07	Mid Point A Frequency
A2-09	E1-08	Mid Point A Voltage
A2-10	E2-01	Motor Rated Current (FLA)
A2-11	H1-05	Terminal S5 Function Selection
A2-12	H1-06	Terminal S6 Function Selection
A2-13	H1-07	Terminal S7 Function Selection
A2-14	L5-01	Number of Auto-Restart Attempts

4 : HVAC Fan

The drive automatically sets the parameters in [Table 2.10](#) for an HVAC fan application.

Table 2.10 Best Parameter Settings for HVAC Fan Applications

No.	Name	Optimal Value
A1-02	Control Method Selection	0: V/f Control
b1-04	Reverse Operation Selection	1: Reverse Disabled
b1-17	Run Command at Power Up	1: Accept Existing RUN Command
C6-01	Normal / Heavy Duty Selection	1: Normal Duty Rating
C6-02	Carrier Frequency Selection	3: 8.0 kHz (6.0 kHz for AOLV/PM)
H2-03	Terminal P2-C2 Function Selection	39: Watt Hour Pulse Output
L2-01	Power Loss Ride Through Select	2: Enabled while CPU Power Active
L8-03	Overheat Pre-Alarm Selection	4: Operate at Reduced Speed (L8-19)

The drive saves the parameters in [Table 2.11](#) as User Parameters.

Table 2.11 Parameters Saved as User Parameters with the HVAC Fan Preset

User Parameter No.	Parameter No. Saved	Name
A2-01	b1-01	Frequency Reference Selection 1
A2-02	b1-02	Run Command Selection 1
A2-03	b1-03	Stopping Method Selection
A2-04	b1-04	Reverse Operation Selection
A2-05	C1-01	Acceleration Time 1
A2-06	C1-02	Deceleration Time 1
A2-07	C6-02	Carrier Frequency Selection
A2-08	d2-01	Frequency Reference Upper Limit
A2-09	d2-02	Frequency Reference Lower Limit
A2-10	E1-03	V/f Pattern Selection
A2-11	E1-04	Maximum Output Frequency
A2-12	E2-01	Motor Rated Current (FLA)
A2-13	H3-11	Terminal A2 Gain Setting
A2-14	H3-12	Terminal A2 Bias Setting
A2-15	L2-01	Power Loss Ride Through Select
A2-16	o4-12	kWh Monitor Initialization

5 : Air Compressor

The drive automatically sets the parameters in [Table 2.12](#) for an air compressor application.

Table 2.12 Best Parameter Settings for Air Compressor Applications

No.	Name	Optimal Value
A1-02	Control Method Selection	0: V/f Control
b1-04	Reverse Operation Selection	1: Reverse Disabled
C1-01	Acceleration Time 1	5.0 s
C1-02	Deceleration Time 1	5.0 s
C6-01	Normal / Heavy Duty Selection	0: Heavy Duty Rating
E1-03	V/f Pattern Selection	F: Custom
L2-01	Power Loss Ride Through Select	1: Enabled
L3-04	Stall Prevention during Decel	1: General Purpose

The drive saves the parameters in [Table 2.13](#) as User Parameters.

Table 2.13 Parameters Saved as User Parameters with the Air Compressor Preset

User Parameter No.	Parameter No. Saved	Name
A2-01	b1-01	Frequency Reference Selection 1
A2-02	b1-02	Run Command Selection 1
A2-03	b1-04	Reverse Operation Selection
A2-04	C1-01	Acceleration Time 1
A2-05	C1-02	Deceleration Time 1
A2-06	E1-03	V/f Pattern Selection
A2-07	E1-07	Mid Point A Frequency
A2-08	E1-08	Mid Point A Voltage
A2-09	E2-01	Motor Rated Current (FLA)

8 : Conveyor 2

The drive automatically sets the parameters in [Table 2.14](#) for a conveyor 2 application.

Table 2.14 Best Parameter Settings for Conveyor 2 Application

No.	Name	Optimal Value
A1-02	Control Method Selection	0: V/f Control
C1-01	Acceleration Time 1	3.0 s
C1-02	Deceleration Time 1	3.0 s
C6-01	Normal / Heavy Duty Selection	0: Heavy Duty Rating
L3-04	Stall Prevention during Decel	7: Overexcitation/High Flux 3
n3-13	OverexcitationBraking (OEB) Gain	1.40
n3-21	HSB Current Suppression Level	150

The drive saves the parameters in [Table 2.15](#) as User Parameters.

Table 2.15 Parameters Saved as User Parameters with the Conveyor 2 Preset

User Parameter No.	Parameter No. Saved	Name
A2-01	A1-02	Control Method Selection
A2-02	b1-01	Frequency Reference Selection 1
A2-03	b1-02	Run Command Selection 1
A2-04	C1-01	Acceleration Time 1
A2-05	C1-02	Deceleration Time 1
A2-06	E2-01	Motor Rated Current (FLA)
A2-07	L3-04	Stall Prevention during Decel
A2-08	n3-13	OverexcitationBraking (OEB) Gain
A2-09	n3-21	HSB Current Suppression Level

■ A1-07: DriveWorksEZ Function Selection

No. (Hex.)	Name	Description	Default (Range)
A1-07 (0128)	DriveWorksEZ Function Selection	<div style="display: flex; gap: 5px;"> V/f OLV OLV/PM AOLV/PM EZOLV </div> Sets the drive to operate with DriveWorksEZ.	0 (0 - 2)

DriveWorksEZ is a simple visual programming tool that lets you connect function blocks to customize the drive and add PLC functions.

Note:

- DriveWorksEZ will overwrite drive settings when it uses MFDI/MFDO and MFAI/MFAO. When you use DriveWorksEZ to make changes to the drive, the changes will stay after you disable DriveWorksEZ.
- For more information about DriveWorksEZ, contact Yaskawa or your nearest sales representative.

0 : DWEZ Disabled

1 : DWEZ Enabled

2 : Enabled/Disabled wDigital Input

Set $H1-xx = 9F$ [MFDI Function Select = DWEZ Disable]. Deactivate the digital input to enable programs made with DriveWorksEZ. Activate the terminal to disable the programs.

If $A1-07 = 1$ [DriveWorksEZ Function Selection = DWEZ Enabled], the drive will continue to disable DWEZ when these conditions are true:

- Drive is not in operation
- The MFDI terminals set for $H1-xx = 9F$ activate.

■ A1-11: Firmware Update Lock

No. (Hex.)	Name	Description	Default (Range)
A1-11 (111D) Expert	Firmware Update Lock	<div style="display: flex; gap: 5px;"> V/f OLV OLV/PM AOLV/PM EZOLV </div> Protects the drive firmware. When you enable the protection, you cannot update the drive firmware.	0 (0, 1)

0 : Disabled

Lock is disabled.

1 : Enabled

Lock is enabled.

■ A1-12: Bluetooth ID

No. (Hex.)	Name	Description	Default (Range)
A1-12 (1564)	Bluetooth ID	<div style="display: flex; gap: 5px;"> V/f OLV OLV/PM AOLV/PM EZOLV </div> Sets the password necessary to use Bluetooth to control the drive with a smartphone or tablet.	- (0000 - 9999)

◆ A2: User Parameters

You can register frequently used parameters and recently changed parameters here to access them quickly. Use Setup Mode to show the saved parameters.

■ A2-01 to A2-32: User Parameters 1 to 32

No. (Hex.)	Name	Description	Default (Range)
A2-01 to A2-32 (0106 - 0125)	User Parameters 1 to 32	<div style="display: flex; gap: 5px;"> V/f OLV OLV/PM AOLV/PM EZOLV </div> You can select a maximum of 32 parameters for the drive and save the values to parameters <i>A2-01 to A2-32</i> . Use Setup Mode to show the saved parameters. You can immediately access these saved parameters.	Parameters in General-Purpose Setup Mode (Determined by A1-06)

Note:

- When the *A1-06 [Application Preset]* value changes, the settings for *A2-01 to A2-32* change.
- You must set *A1-01 = 1 [Access Level Selection = User Parameters]* to access parameters *A2-01 to A2-32*.
- When *A1-07 = 1 or 2 [DriveWorksEZ Function Selection = DWEZ Enabled or Enabled/Disabled wDigital Input]*, the drive saves *qx-xx [DriveWorksEZ Parameters]* to *A2-01 to A2-32*.

The drive saves these parameters to *A2-01 to A2-32*.

- The drive saves a maximum of 32 parameters.

Note:

Set *A1-01 = 2 [Advanced Level]* or *A1-01 = 3 [Expert Level]* to save the necessary parameters.

- The drive automatically saves changed parameters to *A2-17 to A2-32*.

Note:

Set *A2-33 = 1 [User Parameter Auto Selection = Enabled]*.

■ A2-33: User Parameter Auto Selection

No. (Hex.)	Name	Description	Default (Range)
A2-33 (0126)	User Parameter Auto Selection	<div style="display: flex; gap: 5px;"> V/f OLV OLV/PM AOLV/PM EZOLV </div> Sets the automatic save feature for changes to parameters <i>A2-17 to A2-32 [User Parameters 17 to 32]</i> .	Determined by A1-06 (0, 1)

0 : Disabled: Manual Entry Required

Set User Parameters manually.

1 : Enabled: Auto Save Recent Parm

2.2 A: Initialization Parameters

The drive automatically registers changed parameter *A2-17 to A2-32*. The drive automatically saves the most recently changed parameter to *A2-17*, and saves a maximum of 16 parameters. After the drive registers 16 parameters, when you save a new parameter, the drive will remove a parameter from the User Parameter list to make space for the new parameter. The drive removes parameters with First In, First Out.

Use Setup Mode to show the saved parameters.

Note:

In General-Purpose Setup Mode, the drive saves parameters starting with *A2-27* because the drive saves parameters *A2-26* and lower by default.

2.3 b: Application

b parameters set these functions:

- Frequency reference source/Run command source
- Stopping method settings
- DC Injection Braking
- Speed Search
- Timer Function
- PID control
- Dwell function
- Energy-Saving Control

◆ b1: Operation Mode Selection

b1 parameters set the operation mode for the drive.

■ b1-01: Frequency Reference Selection 1

No. (Hex.)	Name	Description	Default (Setting Range)
b1-01 (0180)	Frequency Reference Selection 1	<div style="display: flex; gap: 5px;"> V/f OLV OLV/PM AOLV/PM EZOLV </div> Sets the input method for the frequency reference.	1 (0 - 4)

Note:

- Push **LO/RE** on the keypad to set the input mode to LOCAL and use the keypad to enter the frequency reference.
- If the frequency reference is 0 Hz or less than the value set in *E1-09 [Minimum Output Frequency]* and the drive receives the Run command, the RUN LED on the keypad will flash. Examine the setting for the frequency reference input and enter a value $\geq E1-09$.

0 : Keypad

Use the keypad to enter the frequency reference.

Use **▲** and **▼** on the keypad to change the frequency reference.

1 : Analog Input

Use MFAI terminals A1 and A2 to input an analog frequency reference with a voltage or current input signal.

• Voltage Input

Refer to [Table 2.16](#) to use a voltage signal input to one of the MFAI terminals.

Table 2.16 Frequency Reference Voltage Input

Terminal	Terminal Signal Level	Parameter Settings				Note
		Signal Level Selection	Function Selection	Gain	Bias	
A1	0 - 10 V	H3-01 = 0	H3-02 = 0	H3-03	H3-04	-
	-10 - +10 V	H3-01 = 4	[Frequency Reference]			
A2	0 - 10 V	H3-09 = 0	H3-10 = 0	H3-11	H3-12	Set DIP switch S1 to "V" for voltage input.
	-10 - +10 V	H3-09 = 4	[Frequency Reference]			

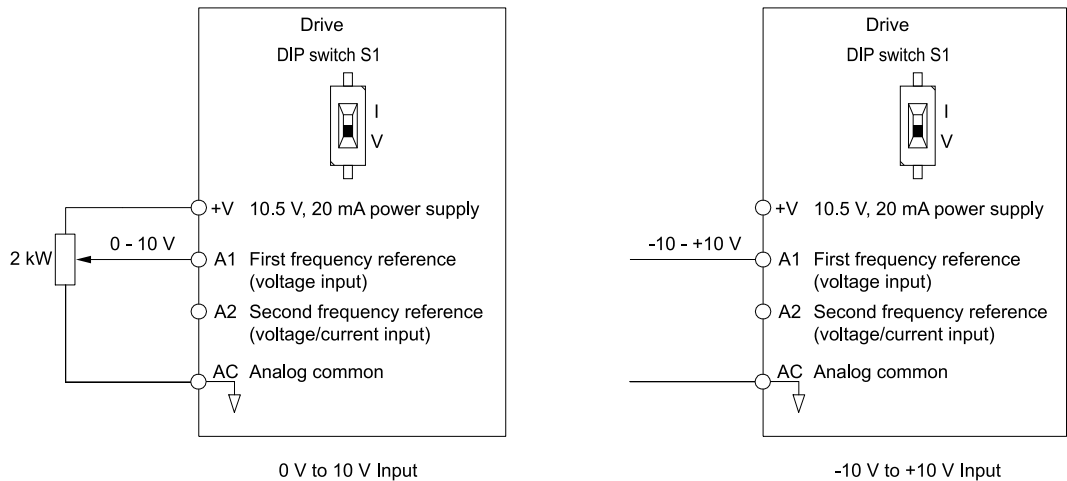

Figure 2.1 Example of Setting the Frequency Reference with a Voltage Signal to Terminal A1

Note:

You can also use this diagram to wire terminal A2.

• **Current Input**

Refer to [Table 2.17](#) to use a current signal input to one of the MFAI terminals.

Table 2.17 Frequency Reference Current Input

Terminal	Signal Level	Parameter Settings				Note
		Signal Level Selection	Function Selection	Gain	Bias	
A2	4 - 20 mA	H3-09 = 2	H3-10 = 0 [Frequency Reference]	H3-11	H3-12	Set DIP switch S1 to "I" for current input.
	0 - 20 mA	H3-09 = 3				

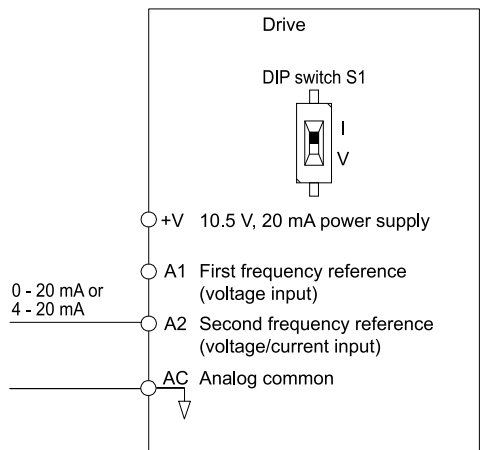

Figure 2.2 Example of Setting the Frequency Reference with a Current Signal to Terminal A2

Changing between Master and Auxiliary Frequency References

Use the multi-step speed reference function to change the frequency reference input between terminals A1 and A2.

2 : Memobus/Modbus Communications

Use MEMOBUS/Modbus communications to enter the frequency reference.

3 : Option PCB

Use a communications option connected to the drive to enter the Run command.

Refer to the instruction manual included with the option to install and set the option.

Note:

If *b1-01 = 3* but you did not connect an option, *oPE05 [Run Cmd/Freq Ref Source Sel Err]* will flash on the keypad.





4 : Pulse Train Input

Use a pulse train signal from the pulse train input terminal RP to enter the frequency reference.

Do this procedure to make sure that the pulse train signal is operating correctly.

1. Set $b1-01 = 4$, $H6-01 = 0$ [Terminal RP Pulse Train Function = Frequency Reference].
2. Set $H6-02$ [Terminal RP Frequency Scaling] to the number of pulses that determine 100% of the frequency reference.
3. Enter a pulse train signal on the terminal RP and make sure that the keypad shows a correct frequency reference.

■ b1-02: Run Command Selection 1

No. (Hex.)	Name	Description	Default (Range)
b1-02 (0181)	Run Command Selection 1	     Sets the input method for the Run command.	1 (0 - 3)

0 : Keypad

Use the keypad to enter the Run command.

You can use the JOG operation or the FWD/REV commands from the keypad.

Note:

The  on the keypad is on while keypad is the Run command source.

1 : Analog Input

Use the control circuit terminals to enter the Run command. Select the input method for the Run command with an $H1-xx$ parameter.

Set $H1-xx = 0, 40$ to 43 [3-Wire Sequence, Run Command (2-Wire Sequence)]. The default setting is 2-wire sequence 1.

- 2-wire Sequence 1
This sequence has two input types: FWD/Stop and REV/Stop. Set $A1-03 = 2220$ [Initialize Parameters = 2-Wire Initialization] to initialize the drive and set terminals S1 and S2 for a 2-wire sequence.
- 2-wire Sequence 2
This sequence has two input types: Run/Stop and FWD/REV.
- 3-Wire Sequence
This sequence has three input types: Run, Stop, and FWD/REV. Set $A1-03 = 3330$ [Initialize Parameters = 3-Wire Initialization] to initialize the drive and set terminals S1, S2, and S5 for a 3-wire sequence.

2 : Memobus/Modbus Communications

Use MEMOBUS/Modbus communications to enter the Run command.

3 : Option PCB





Use a communications option card or input option card connected to the drive to enter the Run command.

Refer to the instruction manual included with the option card to install and set the option card.

Note:

If $b1-02 = 3$, but you did not connect a communications option card, $oPE05$ [Run Cmd/Freq Ref Source Sel Err] will flash on the keypad.

■ b1-03: Stopping Method Selection

No. (Hex.)	Name	Description	Default (Range)
b1-03 (0182)	Stopping Method Selection	     Sets the method to stop the motor after removing a Run command or entering a Stop command.	0 (0 - 3)

Note:

When $A1-02 = 5, 6, 8$ [Control Method Selection = OLV/PM, AOLV/PM, EZOLV], the setting range is 0, 1, 3.

Select the applicable stopping method for the application from these four options:

0 : Ramp to Stop

When you enter the Stop command or turn OFF the Run command, the drive ramps the motor to stop.

The drive ramps the motor to stop as specified by the deceleration time. The default setting for the deceleration time is $C1-02$ [Deceleration Time 1]. The actual deceleration time changes as the load conditions change (for example, mechanical loss and inertia).

If the output frequency is less than or equal to the value set in $b2-01$ [DC Injection/Zero SpeedThreshold] during deceleration, the drive will do DC Injection Braking, Zero Speed Control, or Short Circuit Braking, as specified by the control method.

• Ramp to Stop with V/f Control and OLV Control Methods

Parameter $b2-01$ sets the frequency to start DC Injection Braking at stop. If the output frequency is less than or equal to the value set in $b2-01$ during deceleration, then the drive will perform DC Injection Braking for the time set in $b2-04$ [DC Inject Braking Time at Stop].

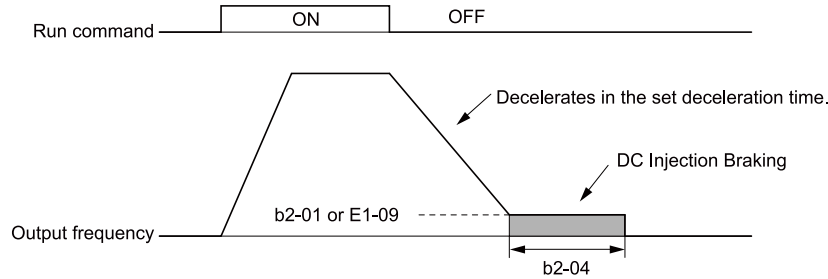

Figure 2.3 Ramp to Stop with V/f and OLV Control Methods

Note:

When $b2-01 \leq E1-09$ [Minimum Output Frequency], the drive will start DC Injection Braking from the frequency set in $E1-09$.

• Ramp to Stop with OLV/PM, AOLV/PM, and EZOLV Control Methods

Parameter $b2-01$ sets the frequency to start Short Circuit Braking. When the output frequency is less than or equal to the value set in $b2-01$ during deceleration, then the drive will do Short Circuit Braking for the time set in $b2-13$ [Short Circuit Brake Time @ Stop]. When $b2-04 \neq 0$, the drive will do DC Injection Braking for the time set in $b2-04$ when Short Circuit Braking is complete.

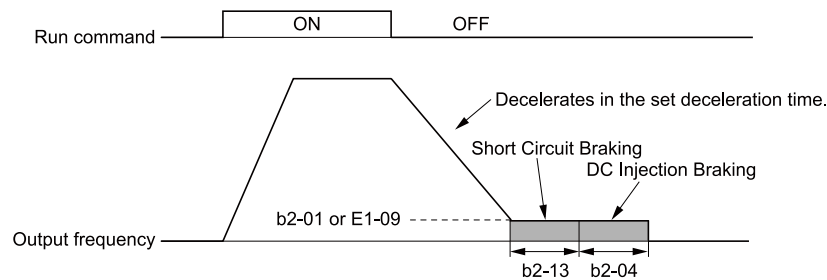

Figure 2.4 Ramp to Stop with OLV/PM, AOLV/PM, and EZOLV Control Methods

Note:

When $b2-01 \leq E1-09$, the drive will start Short Circuit Braking from the frequency set in $E1-09$.

If $b2-01 = 0$ Hz and $E1-09 = 0$ Hz, the drive will not do Short Circuit Braking.

1 : Coast to Stop

When you enter the Stop command or turn OFF the Run command, the drive turns OFF the output and coasts the motor to stop.

Load conditions will have an effect on the deceleration rate as the motor coasts to stop (for example, mechanical loss and inertia).

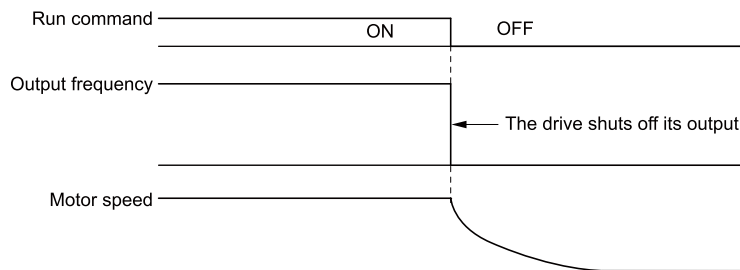

Figure 2.5 Coast to Stop

Note:

When you enter the Stop command or turn OFF the Run command, the drive ignores the Run command for the time set in *L2-03* [Minimum Baseblock Time]. Do not enter the Run command until the motor comes to a complete stop. Use DC Injection or Speed Search to restart the motor before it stops.

2 : DC Injection Braking to Stop

When you enter the Stop command or turn OFF the Run command, the drive turns OFF the output for the time set in *L2-03*. The drive waits for the minimum baseblock time and then injects the amount of DC current into the motor set in *b2-02* [DC Injection Braking Current] to stop the motor with DC current.

DC Injection Braking stops the motor more quickly than coast to stop.

Note:

If *A1-02* = 5, 6, DC Injection Braking to Stop is not available.

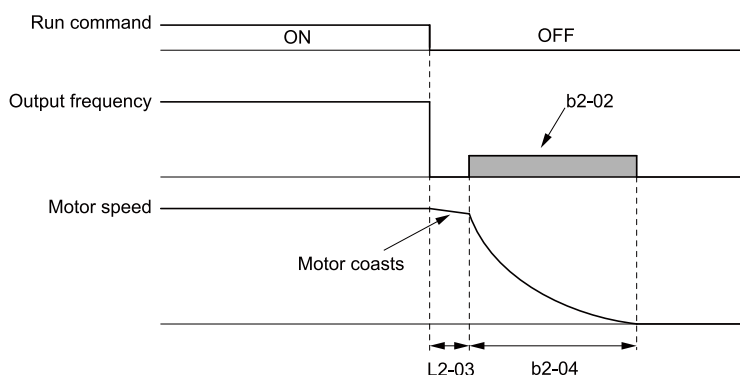

Figure 2.6 DC Injection Braking to Stop

The value set in *b2-04* and the output frequency when the drive receives the Stop command determine the DC Injection Braking time. The drive calculates the DC Injection Braking time as in [Figure 2.7](#).

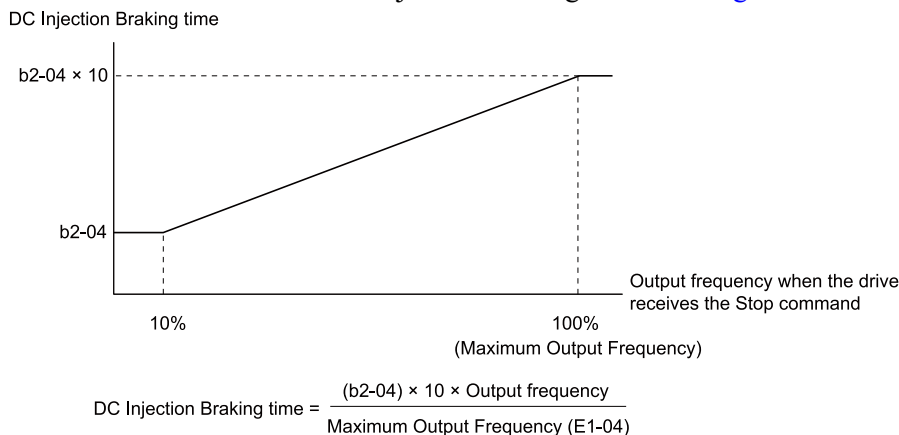

Figure 2.7 DC Injection Braking Time and Output Frequency

Note:

Set *L2-03* to a high value that will not trigger *oC* [Overcurrent] when the drive uses DC Injection Braking to stop the motor.

3 : Coast to Stop with Timer

Enter the Stop command or turn OFF the Run command and turn OFF drive output and coast the motor to stop. The drive ignores the Run command until the “Run wait time t ” is expired.

To start the drive again, wait until the the “Run wait time t ” is expired then enter the Run command.

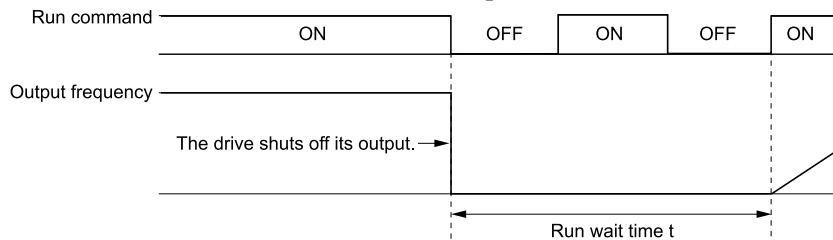

Figure 2.8 Coast to Stop with Timer

The active deceleration time and the output frequency when drive receives the Stop command determine the length of “Run wait time t ”.

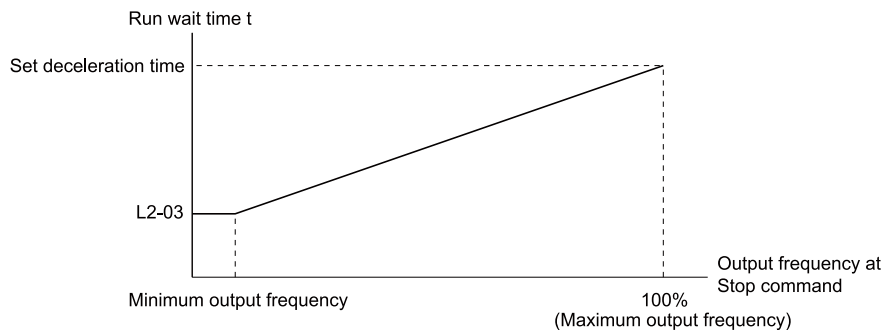

Figure 2.9 Run Wait Time and Output Frequency

■ b1-04: Reverse Operation Selection

No. (Hex.)	Name	Description	Default (Range)
b1-04 (0183)	Reverse Operation Selection	<input type="checkbox"/> V/f <input type="checkbox"/> OLV <input type="checkbox"/> OLV/PM <input type="checkbox"/> AOLV/PM <input type="checkbox"/> EZOLV Sets the reverse operation function. Disable reverse operation in fan or pump applications where reverse rotation is dangerous.	0 (0, 1)

When reverse operation is prohibited, the drive will not accept a Reverse operation command.

0 : Reverse Enabled

The drive will accept a Reverse operation command.

1 : Reverse Disabled

The drive will not accept a Reverse operation command.

■ b1-06: Digital Input Reading

No. (Hex.)	Name	Description	Default (Range)
b1-06 (0185)	Digital Input Reading	<input type="checkbox"/> V/f <input type="checkbox"/> OLV <input type="checkbox"/> OLV/PM <input type="checkbox"/> AOLV/PM <input type="checkbox"/> EZOLV Sets the number of times that the drive reads the sequence input command to prevent malfunction because of electrical interference.	1 (0, 1)

0 : Single Scan

The drive reads the terminal status one time. The drive immediately reads all changes to the terminal status.

This setting lets the drive quickly respond to changes in the sequence, but noise can cause malfunction.

1 : Double Scan

The drive reads all changes to the terminal status two times to make sure that the reading is the same.

The drive responds slower than when it reads the sequence one time, but this setting prevents malfunction because of electrical interference.

■ b1-07: LOCAL/REMOTE Run Selection

No. (Hex.)	Name	Description	Default (Range)
b1-07 (0186)	LOCAL/REMOTE Run Selection	V/f OLV OLV/PM AOLV/PM EZOLV Sets drive response to an existing Run command when the drive receives a second Run command from a different location.	0 (0, 1)

This parameter interlocks the drive to help prevent accidents that can occur if the motor starts to rotate because the Run command source changed.

To switch the RUN command source, push **LO/RE** on the keypad or set $HI-xx = 1, 2$ [MFDI Function Selection = LOCAL/REMOTE Selection, External Reference 1/2 Selection] and activate/deactivate the terminal.

0 : Disregard Existing RUN Command

If a Run command is enabled when you switch between Run command sources, the drive will not operate the motor. When the drive is operating the motor, turn OFF the Run command to stop the motor. Enter the Run command again to start operation.

1 : Accept Existing RUN Command

If a Run command is enabled when you switch between Run command sources, the drive will start to operate the motor or continue to operate the motor.

WARNING! Sudden Movement Hazard. When you use a 3-Wire sequence, set $A1-03 = 3330$ [Initialize Parameters = 3-Wire Initialization] and make sure that $b1-17 = 0$ [Run Command at Power Up = Disregard Existing RUN Command] (default). If you do not correctly set the drive parameters for 3-Wire operation before you energize the drive, the motor can suddenly rotate when you energize the drive.

■ b1-08: Run Command Select in PRG Mode

No. (Hex.)	Name	Description	Default (Range)
b1-08 (0187)	Run Command Select in PRG Mode	V/f OLV OLV/PM AOLV/PM EZOLV Sets the conditions for the drive to accept a Run command entered from an external source when using the keypad to set parameters.	0 (0 - 2)

As a safety precaution, when the drive is in Programming Mode, it will not respond to a Run command.

This parameter helps prevent accidents that can occur if the motor starts to rotate because the drive received a Run command from an external source while the user is programming the drive. You can also set the drive to not show the Programming Mode when a Run command is active.

Note:

Refer to this table for Drive Mode and Programming Mode functions.

Mode	Keypad Screen	Function
Drive Mode	Monitors	Sets monitor display.
Programming Mode	Parameters	Changes parameter settings.
	User Custom Parameters	Shows the User Parameters.
	Parameter Backup/Restore	Saves parameters to the keypad as backup.
	Modified Parameters/Fault Log	Shows modified parameters and fault history.
	Auto-Tuning	Auto-Tunes the drive.
	Initial Setup Screen	Changes initial settings.
	Diagnostic Tools	Sets data logs and backlight.

0 : Disregard RUN while Programming

The drive does not accept the Run command when setting the parameters in the Programming Mode.

1 : Accept RUN while Programming

2.3 b: Application

The drive accepts a Run command entered from an external source when setting the parameters in Programming Mode.

2 : Allow Programming Only at Stop

The drive does not allow the user to enter the Programming Mode while the drive is operating. The keypad does not display the Programming Mode while the drive is operating.

■ b1-14: Phase Order Selection

No. (Hex.)	Name	Description	Default (Range)
b1-14 (01C3)	Phase Order Selection	<div style="display: flex; gap: 5px;"> V/f OLV OLV/PM AOLV/PM EZOLV </div> <p>Sets the phase order for output terminals U/T1, V/T2, and W/T3. This parameter can align the Forward Run command from the drive and the forward direction of the motor without changing wiring.</p>	0 (0, 1)

0 : Standard

1 : Switch Phase Order

■ b1-15: Frequency Reference Selection 2

No. (Hex.)	Name	Description	Default (Range)
b1-15 (01C4)	Frequency Reference Selection 2	<div style="display: flex; gap: 5px;"> V/f OLV OLV/PM AOLV/PM EZOLV </div> <p>Sets the input method for frequency reference 2.</p>	0 (0 - 4)

This parameter is enabled when $H1-xx = 2$ [*MFDI Function Selection = External Reference 1/2 Selection*] is activated.

Note:

- Push LO/RE on the keypad to set the input mode to LOCAL and use the keypad to enter the frequency reference.
- If the frequency reference is 0 Hz or less than or equal to the value set in $E1-09$ [*Minimum Output Frequency*] and the drive receives the Run command, the RUN LED on the keypad will flash. Examine the setting for the frequency reference input and enter a value more than or equal to $E1-09$.

0 : Keypad

Use the keypad to enter the frequency reference.

Use ▲ and ▼ on the keypad to change the frequency reference.

1 : Analog Input

Use MFAI terminals A1 and A2 to input an analog frequency reference with a voltage or current input signal.

• Voltage Input

Refer to [Table 2.18](#) to use a voltage signal input to one of the MFAI terminals.

Table 2.18 Frequency Reference Voltage Input

Terminal	Terminal Signal Level	Parameter Settings				Note
		Signal Level Selection	Function Selection	Gain	Bias	
A1	0 - 10 V	H3-01 = 0	H3-02 = 0	H3-03	H3-04	-
	-10 - +10 V	H3-01 = 4	[Frequency Reference]			
A2	0 - 10 V	H3-09 = 0	H3-10 = 0	H3-11	H3-12	Set DIP switch S1 to "V" for voltage input.
	-10 - +10 V	H3-09 = 4	[Frequency Reference]			

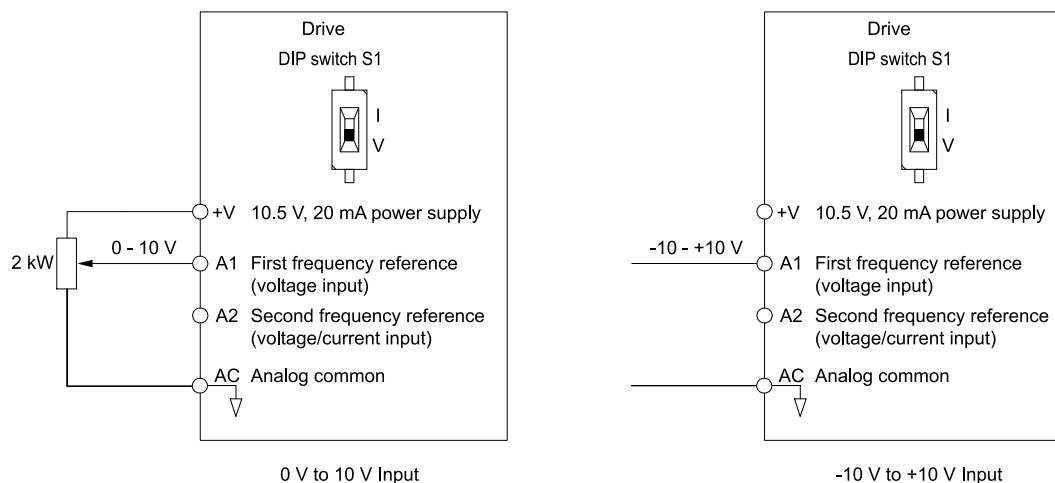

Figure 2.10 Example of Setting the Frequency Reference with a Voltage Signal to Terminal A1

Note:

You can also use this diagram to wire terminal A2.

• **Current Input**

Refer to [Table 2.19](#) to use a current signal input to one of the MFAI terminals.

Table 2.19 Frequency Reference Current Input

Terminal	Signal Level	Parameter Settings				Note
		Signal Level Selection	Function Selection	Gain	Bias	
A2	4 - 20 mA	H3-09 = 2	H3-10 = 0	H3-11	H3-12	Set DIP switch S1 to "I" for current input.
	0 - 20 mA	H3-09 = 3	[Frequency Reference]			

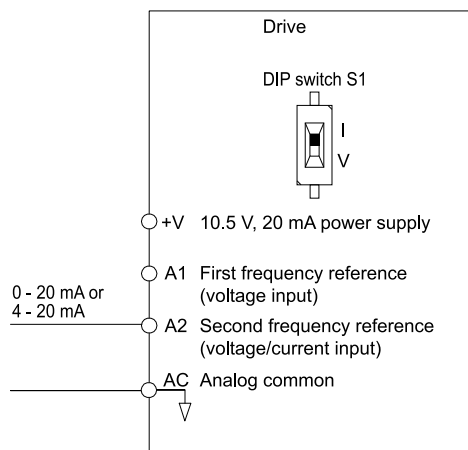

Figure 2.11 Example of Setting the Frequency Reference with a Current Signal to Terminal A2

Changing between Master and Auxiliary Frequency References

Use the multi-step speed reference function to change the frequency reference input between terminals A1 and A2.

2 : Memobus/Modbus Communications

Use MEMOBUS/Modbus communications to enter the frequency reference.

3 : Option PCB

Use a communications option card connected to the drive to enter the Run command.

Refer to the instruction manual included with the option card to install and set the option card.

Note:

If you set *b1-15* = 3 but you do not connect an option card, *oPE03* [Multi-Function Input Setting Err] will flash on the keypad.

4 : Pulse Train Input





2.3 b: Application

Use a pulse train signal from the pulse train input terminal RP to enter the frequency reference.

Do this procedure to make sure that the pulse train signal is operating correctly.

1. Set $b1-15 = 4$, $H6-01 = 0$ [Terminal RP Pulse Train Function = Frequency Reference].
2. Set $H6-02$ [Terminal RP Frequency Scaling] to the number of pulses that determine 100% of the frequency reference.
3. The terminal set in $H1-xx = 2$ [MFDI Function Selection = External Reference 1/2 Selection] is activated.
4. Enter a pulse train signal on the terminal RP and make sure that the keypad shows a correct frequency reference.

■ b1-16: Run Command Selection 2

No. (Hex.)	Name	Description	Default (Range)
b1-16 (01C5)	Run Command Selection 2	     Sets the input method for Run Command 2 when the user switches the control circuit terminals ON/OFF to change the Run command source.	0 (0 - 3)

Activate $H1-xx = 2$ [MFDI Function Selection = External Reference 1/2 Selection] to enable this parameter.

0 : Keypad

Use the keypad to enter the Run command.

You can use the JOG operation or the FWD/REV commands from the keypad.

Note:

The  is on while the keypad is the Run command source.

1 : Digital Input

Use the control circuit terminals to enter the Run command. Select the input method for the Run command with an $H1-xx$ parameter.

Set $H1-xx = 0, 40$ to 43 [3-Wire Sequence, Run Command (2-Wire Sequence)]. The default setting is 2-wire sequence 1.

- 2-wire Sequence 1
This sequence has two input types: FWD/Stop and REV/Stop. Set $A1-03 = 2220$ [Initialize Parameters = 2-Wire Initialization] to initialize the drive and set terminals S1 and S2 for a 2-wire sequence.
- 2-wire Sequence 2
This sequence has two input types: Run/Stop and FWD/REV.
- 3-Wire Sequence
This sequence has three input types: Run, Stop, and FWD/REV. Set $A1-03 = 3330$ [Initialize Parameters = 3-Wire Initialization] to initialize the drive and set terminals S1, S2, and S5 for a 3-wire sequence.

2 : Memobus/Modbus Communications

Use MEMOBUS/Modbus communications to enter the Run command.

3 : Option PCB





Use a communications option card or input option card connected to the drive to enter the Run command.

Refer to the instruction manual included with the option card to install and set the option card.

Note:

If $b1-16 = 3$ but no option card is connected, then $oPE03$ [Multi-Function Input Setting Err] will flash on the keypad.

■ b1-17: Run Command at Power Up

No. (Hex.)	Name	Description	Default (Range)
b1-17 (01C6)	Run Command at Power Up	     Sets drive response when the CPU changes from de-energized to energized and there is an active Run command. Set this parameter in applications where energizing or de-energizing the drive enables the Run command. When the CPU stays energized during loss of power, $L2-01$ [Power Loss Ride Through Select] sets operation.	0 (0, 1)

0 : Disregard Existing RUN Command

The drive does not start to operate the application when you apply power, even when there is an existing Run command.

Enter the Run command again to operate the application.

Note:



When you energize the drive,  on the keypad will flash quickly if the Run command is already enabled from an external source.

1 : Accept Existing RUN Command

When there is an existing Run command, the drive starts to operate the application when you apply power.

WARNING! Sudden Movement Hazard. When you use a 3-Wire sequence, set $A1-03 = 3330$ [Initialize Parameters = 3-Wire Initialization] and make sure that $b1-17 = 0$ [Run Command at Power Up = Disregard Existing RUN Command] (default). If you do not correctly set the drive parameters for 3-Wire operation before you energize the drive, the motor can suddenly rotate when you energize the drive.

■ b1-35: Digital Input Deadband Time

No. (Hex.)	Name	Description	Default (Range)
b1-35 (1117) Expert	Digital Input Deadband Time	V/f OLV OLV/PM AOLV/PM EZOLV Sets the deadband time for MFDIs.	0.0 ms (0.0 to 100.0 ms)

When the on/off time for MFDIs is longer than the time set in $b1-35$, the drive activates the MFDI. Set this parameter to prevent malfunctions caused by relay chattering for applications in which relays send input to MFDI terminals.

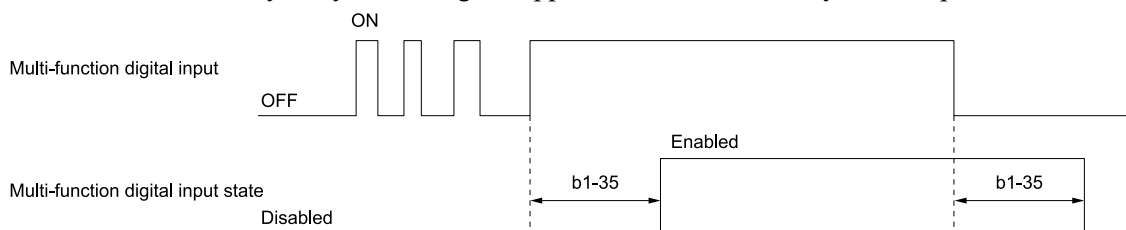

◆ b2: DC Injection Braking and Short Circuit Braking

$b2$ parameters set the DC Injection Braking and Short Circuit Braking functions.

- DC Injection Braking: A braking method that injects DC current into the motor windings. This function should not be used too frequently, because it generates a fair amount of heat in the motor.
- Short Circuit Braking: A braking method for PM motors.

■ b2-01: DC Injection/Zero SpeedThreshold

No. (Hex.)	Name	Description	Default (Range)
b2-01 (0189)	DC Injection/Zero SpeedThreshold	V/f OLV OLV/PM AOLV/PM EZOLV Sets the frequency to start DC Injection Braking or Short Circuit Braking near the end of a stop ramp.	Determined by A1-02 (0.0 - 10.0 Hz)

Note:

This parameter is available when $b1-03 = 0$ [Stopping Method Selection = Ramp to Stop].

When the control method selected in $A1-02$ [Control Method Selection] changes, the $b2-01$ function changes.

Parameter Settings	Functions of b2-01
$A1-02 = 0, 2 [V/f \text{ or } OLV]$	<p>Parameter $b2-01$ sets the frequency to start DC Injection Braking at stop. When the output frequency is less than or equal to the value set in $b2-01$, the drive will inject the quantity of DC current set in $b2-02$ [DC Injection Braking Current] into the motor for the time set in $b2-04$ [DC Inject Braking Time at Stop].</p> <p>Figure 2.12 DC Injection Braking at Stop</p> <p>Note: When $b2-01 \leq E1-09$ [Minimum Output Frequency], the drive will start DC Injection Braking from the frequency set in $E1-09$.</p>
$A1-02 = 5, 6, \text{ or } 8 [OLV/PM, AOLV/PM, \text{ or } EZOLV]$	<p>Parameter $b2-01$ sets the frequency to start Short Circuit Braking at stop. When the output frequency is less than or equal to the value set in $b2-01$, the drive will do Short Circuit Braking for the time set in $b2-13$ [Short Circuit Brake Time @ Stop]. When $b2-04 > 0.00$ s, the drive will complete Short Circuit Braking, then do DC Injection Braking for the time set in $b2-04$.</p> <p>Figure 2.13 Short Circuit Braking at Stop</p> <p>Note: When $b2-01 \leq E1-09$, the drive will start Short Circuit Braking from the frequency set in $E1-09$. If $b2-01$ and $E1-09 = 0$ Hz, the drive will not do Short Circuit Braking.</p>

■ **b2-02: DC Injection Braking Current**

No. (Hex.)	Name	Description	Default (Range)
b2-02 (018A)	DC Injection Braking Current	<input type="checkbox"/> V/f <input type="checkbox"/> OLV <input type="checkbox"/> OLV/PM <input type="checkbox"/> AOLV/PM <input type="checkbox"/> EZOLV Sets the DC Injection Braking current as a percentage of the drive rated current.	50% (0 - 75%)

When the DC Injection Braking current is more than 50%, the drive decreases the carrier frequency to 1 kHz. The motor rated current determines how much DC Injection Braking current that the drive can use.

The DC Injection Braking current level has an effect on the strength of the magnetic field that locks the motor shaft. As the current level increases, the motor windings will supply more heat. Do not set this parameter higher than the level that is necessary to hold the motor shaft.

■ **b2-03: DC Inject Braking Time at Start**

No. (Hex.)	Name	Description	Default (Range)
b2-03 (018B)	DC Inject Braking Time at Start	<input type="checkbox"/> V/f <input type="checkbox"/> OLV <input type="checkbox"/> OLV/PM <input type="checkbox"/> AOLV/PM <input type="checkbox"/> EZOLV Sets the DC Injection Braking Time at stop.	0.00 s (0.00 - 10.00 s)

This function stops then restarts a coasting motor and increases motor flux to make high starting torque (a process called initial excitation). Set this parameter to 0.00 to disable the function.

Note:

To restart a coasting motor, use DC Injection Braking to stop and then restart the motor, or enable Speed Search. Enable DC Injection Braking or Speed Search to prevent *ov* [Overvoltage] or *oC* [Overcurrent] faults.

■ **b2-04: DC Inject Braking Time at Stop**

No. (Hex.)	Name	Description	Default (Range)
b2-04 (018C)	DC Inject Braking Time at Stop	<input type="checkbox"/> V/f <input type="checkbox"/> OLV <input type="checkbox"/> OLV/PM <input type="checkbox"/> AOLV/PM <input type="checkbox"/> EZOLV Sets the DC Injection Braking Time at stop.	Determined by A1-02 (0.00 - 10.00 s)

This function fully stops a motor with a large inertia during deceleration and will not let the inertia continue to rotate the motor.

Set this parameter to 0.00 to disable the function.

When a longer time is required to stop the motor, increase the value.

■ b2-08: Magnetic Flux Compensation Value

No. (Hex.)	Name	Description	Default (Range)
b2-08 (0190)	Magnetic Flux Compensation Value	<input type="checkbox"/> V/f <input checked="" type="checkbox"/> OLV <input type="checkbox"/> OLV/PM <input type="checkbox"/> AOLV/PM <input type="checkbox"/> EZOLV Sets how much current the drive injects when DC Injection Braking at Start starts (Initial Excitation) as a percentage of E2-03 [Motor No-Load Current].	0% (0 - 1000%)

This parameter is effective when you start a high-capacity motor (a motor with a large secondary circuit time constant). This function can quickly increase motor flux to make high starting torque (a process called initial excitation).

The current level for DC Injection Braking at start changes linearly from the setting of b2-08 to the setting of b2-03 as shown in Figure 2.14.

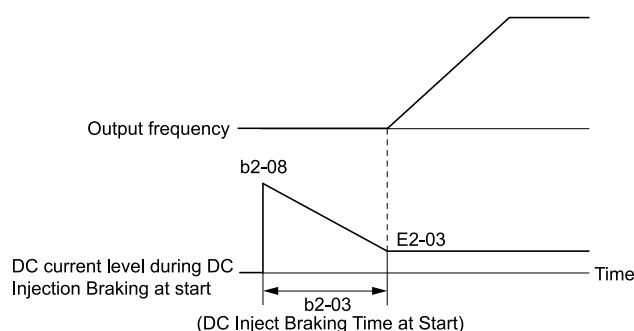

Figure 2.14 DC Current Level during DC Injection Braking at Start

Note:

- If $b2-08 < 100\%$, flux will develop very slowly.
- When $b2-08 = 0\%$, the DC current level will be the DC Injection current set in b2-02 [DC Injection Braking Current].
- If $b2-08$ is set too high, DC Injection Braking at start can cause a large noise. Adjust $b2-08$ to decrease the volume to the permitted level.

■ b2-12: Short Circuit Brake Time @ Start

No. (Hex.)	Name	Description	Default (Range)
b2-12 (01BA)	Short Circuit Brake Time @ Start	<input type="checkbox"/> V/f <input type="checkbox"/> OLV <input checked="" type="checkbox"/> OLV/PM <input type="checkbox"/> AOLV/PM <input type="checkbox"/> EZOLV Sets the Short Circuit Braking time at start.	0.00 s (0.00 - 25.50 s)

This function stops and restarts a coasting PM motor. The drive short circuits all the three motor phases to make braking torque in the motor.

Set this parameter to 0.00 to disable the function.

Note:

- Short circuit Braking will let external forces rotate the PM motor. Use DC Injection Braking to prevent motor rotation from external forces.
- Motor speed and load conditions can make it necessary to install a dynamic braking option on the drive.

■ b2-13: Short Circuit Brake Time @ Stop

No. (Hex.)	Name	Description	Default (Range)
b2-13 (01BB)	Short Circuit Brake Time @ Stop	<input type="checkbox"/> V/f <input type="checkbox"/> OLV <input checked="" type="checkbox"/> OLV/PM <input type="checkbox"/> AOLV/PM <input type="checkbox"/> EZOLV Sets the Short Circuit Braking time at stop.	A1-02 = 8: 0.00 s Other than A1-02 = 8: 0.50 s (0.00 - 25.50 s)

This function fully stops a PM motor with a large inertia during deceleration and will not let the inertia continue to rotate the motor.

2.3 b: Application

Short Circuit Braking operates for the time set in *b2-13* when output frequency is less than the value set in *b2-01* [*DC Injection/Zero SpeedThreshold*] or *E1-09* [*Minimum Output Frequency*].

Set this parameter to 0.00 to disable the function.

Note:

Motor speed and load conditions can make it necessary to install a dynamic braking option on the drive.

■ b2-18: Short Circuit Braking Current

No. (Hex.)	Name	Description	Default (Range)
b2-18 (0177)	Short Circuit Braking Current	<div style="display: flex; gap: 5px;"> V/f OLV OLV/PM AOLV/PM EZOLV </div> Sets the Short Circuit Braking Current as a percentage of the motor rated current.	100.0% (0.0 - 200.0%)

The Short Circuit Braking current cannot be higher than the drive rated current, although you can use *b2-18* to set a higher current level. The maximum rated current is 120% when the drive is set for Normal Duty (*C6-01* = 1 [*Normal Duty Rating*]). The maximum rated current is 150% when the drive is set for Heavy Duty (*C6-01* = 0 [*Heavy Duty Rating*]).

◆ b3: Speed Search

The Speed Search function detects the actual speed of a coasting motor, then restarts the motor before the motor stops. Use Speed Search in these conditions:

- To continue operation after momentary power loss
- To switch from commercial power supply to drive power
- To restart a coasting fan

For example, the drive output turns off and the motor coasts when there is a momentary loss of power. After you return power, the drive does Speed Search on the coasting motor, and restarts the motor from the detected speed.

When you use a PM motor, enable *b3-01* [*Speed Search at Start Selection*].

There are two types of Speed Search for induction motors: Current Detection and Speed Estimation. Use parameter *b3-24* [*Speed Search Method Selection*] to select the type of Speed Search.

Parameter settings are different for different types of Speed Search. Refer to [Table 2.20](#) for more information.

Table 2.20 Speed Search and Related Parameters

Parameter	Speed Estimation	Current Detection 2
	b3-24 = 1	b3-24 = 2
b3-01 [Speed Search at Start Selection]	x	x
b3-03 [Speed Search Deceleration Time]	-	x
b3-05 [Speed Search Delay Time]	x	x
b3-06 [Speed Estimation Current Level 1]	x	-
b3-07 [Speed Estimation Current Level 2]	x	-
b3-08 [Speed Estimation ACR P Gain]	x	-
b3-09 [Speed Estimation ACR I Time]	x	-
b3-10 [Speed Estimation Detection Gain]	x	-
b3-14 [Bi-directional Speed Search]	x	x
b3-17 [Speed Est Retry Current Level]	x	x
b3-18 [Speed Est Retry Detection Time]	x	x
b3-19 [Speed Search Restart Attempts]	x	x
b3-24 [Speed Search Method Selection]	x (1)	x (2)
b3-25 [Speed Search Wait Time]	x	x
b3-26 [Direction Determination Level]	x	-
b3-29 [Speed Search Back-EMF Threshold]	-	-

Parameter	Speed Estimation	Current Detection 2
	b3-24 = 1	b3-24 = 2
b3-31 [Spd Search Current Reference Lvl]	-	x
b3-32 [Spd Search Current Complete Lvl]	-	x
b3-33 [Speed Search during Uv Selection]	x	x
b3-54 [Search Time]	-	-
b3-55 [Current Increment Time]	-	-
b3-56 [InverseRotationSearch WaitTime]	-	x

Note:

- To use Speed Estimation Speed Search with V/f Control, do Rotational Auto-Tuning before you set the Speed Search function. If the wire length between the drive and motor changed since the last time you did Auto-Tuning, do Stationary Auto-Tuning for Line-to-Line Resistance process again.
- If $A1-02 = 5, 6$ [*PM Open Loop Vector, PM Advanced Open Loop Vector*] and the wiring distance between the motor and drive is long or if the motor is coasting at more than or equal to 120 Hz, do not use Speed Search to restart the motor. Use Short Circuit Braking.

■ Current Detection 2

Use this Speed Search function with induction motors. Set $b3-24 = 2$ [*Speed Search Method Selection = Current Detection 2*]. Current Detection Speed Search injects current into the motor to detect the speed of an induction motor. Speed Search increases the output voltage for the time set in $L2-04$ [*Powerloss V/f Recovery Ramp Time*], starting from the maximum output frequency or the frequency reference.

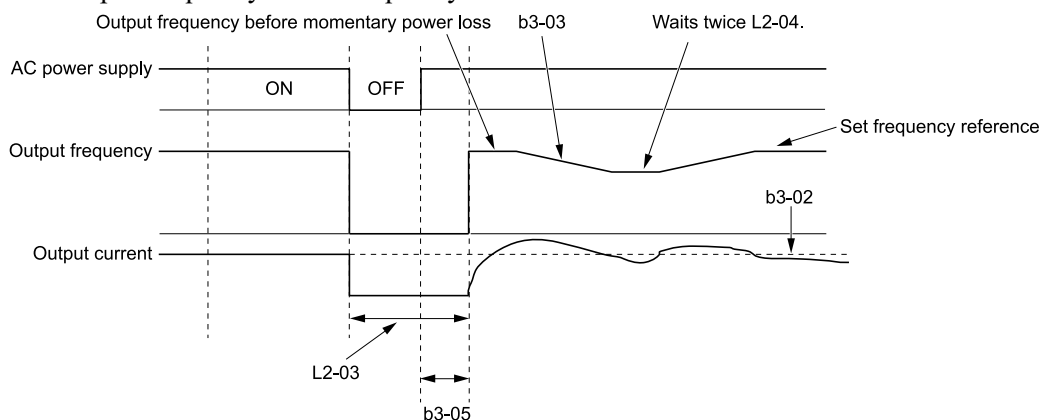

Figure 2.15 Current Detection 2 after Momentary Power Loss

Note:

After you restore power, the drive will not do Speed Search until the time set in $b3-05$ [*Speed Search Delay Time*] expires. This means that the drive will not always start Speed Search when the time set in $L2-03$ [*Minimum Baseblock Time*] expires.

If you enter the Run command at the same time as Speed Search, the drive will not do Speed Search until the time set in $L2-03$ expires. When the value set in $L2-03 < b3-05$, the drive will use the wait time set in $b3-05$.

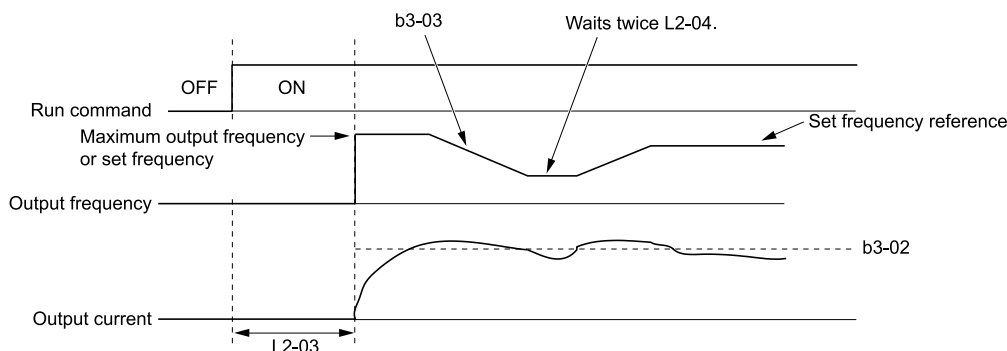

Figure 2.16 Speed Search Selection at Start (Current Detection Type)

WARNING! Sudden Movement Hazard. Do not do Current Detection Speed Search with light loads or a stopped motor. If you do Auto-Tuning in these conditions, the motor can suddenly accelerate and cause serious injury or death.

Note:

- You cannot use Current Detection Speed Search with PM motors.
- If the motor is rotating in reverse, you cannot do Speed Search.
- If the drive detects *oL1* [Motor Overload] during Current Detection Speed Search, decrease *b3-03*.
- If the drive detects *oC* [Overcurrent] or *ov* [Overvoltage] during Current Detection Speed Search after the drive recovers from a momentary power loss, increase *L2-03*.

■ Speed Estimation

Use this Speed Search function with induction motors. Set *b3-24* = 1 [Speed Search Method Selection = Speed Estimation]. This function uses less current and has a shorter search time than other functions. This function lets you do Speed Search when the motor is rotating in reverse. When you return power after a power loss, the motor will not suddenly accelerate.

Note:

You cannot do Speed Estimation Speed Search in these conditions:

- When You Operate More than One Motor with One Drive
- When you use a high-speed motor (120 Hz or higher)
- When you use a 1.5 kW or smaller motor.
- When the motor output is more than 1 frame size smaller than the drive capacity
- When there is a long wiring distance between the drive and motor

For these conditions, use Current Detection Speed Search.

Speed Estimation Speed Search uses these two steps to estimate the motor speed:

1. Residual Voltage Search

When there is a short baseblock time, the drive searches for residual voltage. The drive uses the residual voltage in the motor to estimate the motor speed and direction of rotation. The drive outputs the estimated motor speed as frequency, then uses the deceleration rate set in *L2-04* to increase the voltage. When the output voltage aligns with the V/f pattern, the drive accelerates or decelerates the motor to the frequency reference. If the drive cannot estimate the motor speed because of low residual voltage, it will automatically do Current Injection.

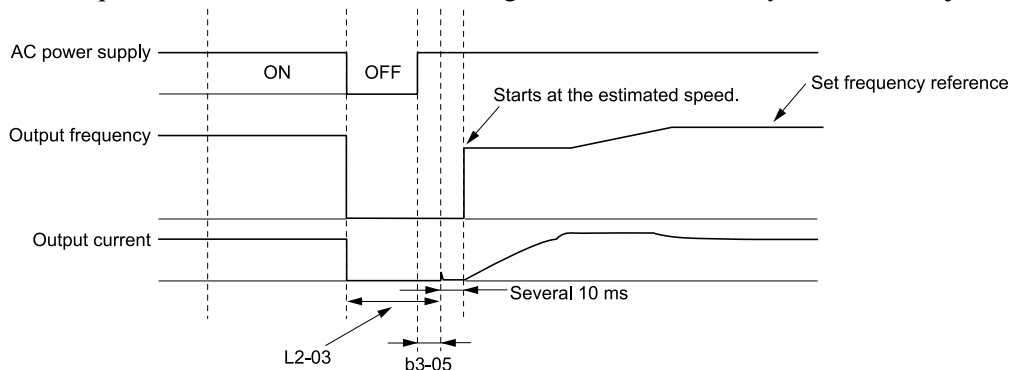

Figure 2.17 Speed Search after Baseblock

Note:

After you return power, the drive waits for the time set in *b3-05*. If power loss is longer than the time set in *L2-03*, the drive will start Speed Search when the time set in *b3-05* is expired after the power recovery.

2. Current Injection

If there is not sufficient residual voltage in the motor, the drive does Current Injection. The drive injects the quantity of DC current set in *b3-06* [Speed Estimation Current Level 1] into the motor windings to estimate the motor speed and direction of rotation. The drive outputs the estimated motor speed as frequency, then uses the deceleration rate set in *L2-04* to increase the voltage. When the output voltage aligns with the V/f pattern, the drive accelerates or decelerates the motor to the frequency reference.

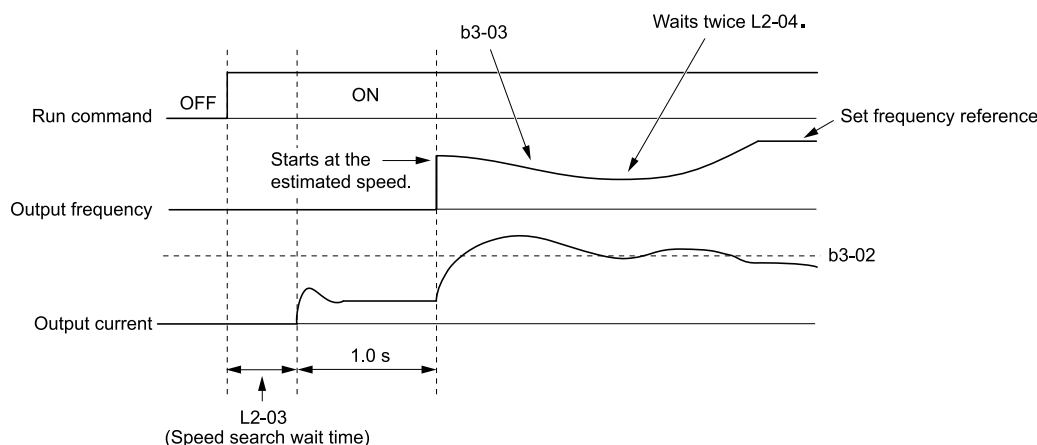

Figure 2.18 Speed Search Selection at Start

Note:

Set the lower limit of the delay time to *b3-05* for when Speed Search starts.

Speed Search and Operation Conditions

These conditions apply to Speed Search operation. When *A1-02 = 0, 2* [Control Method Selection = *V/f* Control, Open Loop Vector], set *b3-24* [Speed Search Method Selection] before you do Speed Search.

- Do Speed Search with each Run Command
The drive ignores a Speed Search command from the external terminals.
- Use an MFDI to do an External Speed Search Command
To use an MFDI to do Speed Search, input the Run command at the same time that terminal *Sx* set for Speed Search activates, or after Speed Search activates.
Set Speed Search to *H1-xx* to do the function externally. You cannot set external Speed Search 1 and 2 at the same time.

Table 2.21 Execute Speed Search via the Digital Input Terminals

H1-xx Setting	Name	Current Detection 2	Speed Estimation
61	Speed Search from <i>Fmax</i>	ON: Speed Search starts from <i>E1-04</i> [Maximum Output Frequency].	External Speed Search commands 1 and 2 work the same.
62	Speed Search from <i>Fref</i>	ON: Speed Search starts from the frequency reference immediately before you input the Speed Search command.	The drive estimates the motor speed, then starts Speed Search from the estimated speed.

- Do Speed Search with Each Auto Restart
Set *L5-01* [Number of Auto-Restart Attempts] = 1 or more. After an Auto Restart fault, the drive automatically does Speed Search.
- Do Speed Search after Momentary Power Loss
Set *L2-01 = 1, 2* [Power Loss Ride Through Select = Enabled for L2-02 Time, Enabled while CPU Power Active].
- Do Speed Search after You Clear the External Baseblock Command
When there is an active Run command and the output frequency is higher than the minimum frequency, you must clear the external baseblock command to do Speed Search.

b3-01: Speed Search at Start Selection

No. (Hex.)	Name	Description	Default (Range)
b3-01 (0191)	Speed Search at Start Selection	<input checked="" type="checkbox"/> <i>V/f</i> <input checked="" type="checkbox"/> <i>OLV</i> <input checked="" type="checkbox"/> <i>OLV/PM</i> <input checked="" type="checkbox"/> <i>AOLV/PM</i> <input checked="" type="checkbox"/> <i>EZOLV</i> Sets the Speed Search at Start function so the drive will do Speed Search with each Run command.	Determined by <i>A1-02</i> (0, 1)

0 : Disabled

Enter a Run command to start to operate the drive at the minimum output frequency.

When the Run command is enabled and the *Speed Search from Fmax or Fref* [*H1-xx = 61, 62*] is input from a multi-function input terminal, the drive will do Speed Search and start to operate the motor.

1 : Enabled

Enter the Run command to do Speed Search. The drive completes Speed Search, then starts to operate the motor.

■ b3-02: SpeedSearch Deactivation Current

No. (Hex.)	Name	Description	Default (Range)
b3-02 (0192)	SpeedSearch Deactivation Current	<div style="display: flex; justify-content: space-between; align-items: center;"> V/f OLV OLV/PM AOLV/PM EZOLV </div> <p>Sets the current level that stops Speed Search as a percentage of the drive rated output current. Usually it is not necessary to change this setting.</p>	Determined by A1-02 (0 - 200%)

If the drive cannot restart the motor, decrease this setting.

■ b3-03: Speed Search Deceleration Time

No. (Hex.)	Name	Description	Default (Range)
b3-03 (0193)	Speed Search Deceleration Time	<div style="display: flex; justify-content: space-between; align-items: center;"> V/f OLV OLV/PM AOLV/PM EZOLV </div> <p>Sets the deceleration time during Speed Search operation. Set the length of time to decelerate from the maximum output frequency to the minimum output frequency.</p>	2.0 s (0.1 - 10.0 s)

This is the output frequency deceleration time used by Current Detection Speed Search and by the Current Injection Method of Speed Estimation Speed Search.

Note:

- When $A1-02 = 8$ [Control Method Selection = EZOLV], this parameter takes effect only in Expert Mode.
- If the drive detects oLI [Motor Overload] during Current Detection Speed Search, decrease the value set in b3-03.

■ b3-04: V/f Gain during Speed Search

No. (Hex.)	Name	Description	Default (Range)
b3-04 (0194)	V/f Gain during Speed Search	<div style="display: flex; justify-content: space-between; align-items: center;"> V/f OLV OLV/PM AOLV/PM EZOLV </div> <p>Sets the ratio used to reduce the V/f during searches to reduce the output current during speed searches.</p>	Determined by o2-04 (10 - 100)

Use this formula to calculate the output voltage during Speed Search:

Output voltage during Speed Search = Configured V/f × b3-04

When the current detection search operates correctly, this configuration is not necessary.

■ b3-05: Speed Search Delay Time

No. (Hex.)	Name	Description	Default (Range)
b3-05 (0195)	Speed Search Delay Time	<div style="display: flex; justify-content: space-between; align-items: center;"> V/f OLV OLV/PM AOLV/PM EZOLV </div> <p>Sets the Speed Search delay time to activate a magnetic contactor installed between the drive and motor.</p>	0.2 s (0.0 - 100.0 s)

When you use a magnetic contactor between the drive and motor, you must close the contactor before the drive will do Speed Search. This parameter sets a delay time to activate the magnetic contactor.

■ b3-06: Speed Estimation Current Level 1

No. (Hex.)	Name	Description	Default (Range)
b3-06 (0196) Expert	Speed Estimation Current Level 1	<div style="display: flex; justify-content: space-between; align-items: center;"> V/f OLV OLV/PM AOLV/PM EZOLV </div> <p>Sets the level of current that flows to the motor during Speed Estimation Speed Search as a coefficient of the motor rated current. Usually it is not necessary to change this setting.</p>	Determined by o2-04 (0.0 - 2.0)

When the speed estimation value is the minimum output frequency, increase this setting. You can do this when the motor coasts at a high speed while the drive estimates the speed during Speed Estimation Speed Search. The limit of the output current during speed search is automatically the drive rated current.

Note:

- When the drive cannot accurately estimate the speed after you adjust this parameter, use Current Detection Speed Search.

■ b3-07: Speed Estimation Current Level 2

No. (Hex.)	Name	Description	Default (Range)
b3-07 (0197) Expert	Speed Estimation Current Level 2	<div style="display: flex; justify-content: space-between; align-items: center;"> V/f OLV OLV/PM AOLV/PM EZOLV </div> <p>Sets the level of current that flows to the motor during Speed Estimation Speed Search as a coefficient of E2-03 [Motor No-Load Current] or E4-03 [Motor 2 Rated No-Load Current]. Usually it is not necessary to change this setting.</p>	1.0 (0.0 - 3.0)

During Speed Estimation Speed Searches, when the speed estimation value aligns with the minimum output frequency, increase the setting value in 0.1-unit increments. The limit of the output current during speed search is automatically the drive rated current.

■ b3-08: Speed Estimation ACR P Gain

No. (Hex.)	Name	Description	Default (Range)
b3-08 (0198)	Speed Estimation ACR P Gain	<div style="display: flex; justify-content: space-between; align-items: center;"> V/f OLV OLV/PM AOLV/PM EZOLV </div> <p>Sets the proportional gain for the automatic current regulator during Speed Estimation Speed Search. Also adjusts speed search responsiveness. Usually it is not necessary to change this setting.</p>	Determined by A1-02 and o2-04 (0.00 - 6.00)

■ b3-09: Speed Estimation ACR I Time

No. (Hex.)	Name	Description	Default (Range)
b3-09 (0199)	Speed Estimation ACR I Time	<div style="display: flex; justify-content: space-between; align-items: center;"> V/f OLV OLV/PM AOLV/PM EZOLV </div> <p>Sets the integral time for the automatic current regulator during Speed Estimation Speed Search. Also adjusts speed search responsiveness. Usually it is not necessary to change this setting.</p>	Determined by A1-02 when A1-02 ≠ 5 20.0 when A1-02 = 5 (0.0 - 1000.0 ms)

■ b3-10: Speed Estimation Detection Gain

No. (Hex.)	Name	Description	Default (Range)
b3-10 (019A) Expert	Speed Estimation Detection Gain	<div style="display: flex; justify-content: space-between; align-items: center;"> V/f OLV OLV/PM AOLV/PM EZOLV </div> <p>Sets the gain to correct estimated frequencies from Speed Estimation Speed Search.</p>	1.05 (1.00 - 1.20)

If the drive detects *ov* [DC Bus Overvoltage] when you restart the motor, increase the setting value.

■ b3-14: Bi-directional Speed Search

No. (Hex.)	Name	Description	Default (Range)
b3-14 (019E)	Bi-directional Speed Search	<div style="display: flex; justify-content: space-between; align-items: center;"> V/f OLV OLV/PM AOLV/PM EZOLV </div> <p>Sets the direction of Speed Search to the direction of the frequency reference or in the motor rotation direction as detected by the drive.</p>	Determined by A1-02 and b3-24 (0, 1)

Note:

- When E9-01 = 0 [Motor Type Selection = Induction (IM)] and A1-02 = 0, 2, or 8 [Control Method Selection = V/f, OLV, or EZOLV], the default settings change when the setting of b3-24 [Speed Search Method Selection] changes.
 - b3-24 = 1 [Speed Estimation]: Refer to [Parameters that Change from the Default Settings with A1-02 \[Control Method Selection\] on page 124](#).
 - b3-24 = 2 [Current Detection 2]: 0

- When E9-01 = 1 or 2 [Permanent Magnet (PM), Synchronous Reluctance (SynRM)] and A1-02 = 0 or 8 [V/f, EZOLV], refer to [Parameters that Change from the Default Settings with A1-02 \[Control Method Selection\] on page 124](#).

When you set A1-02, b3-24, and E9-01, set b3-14.

0 : Disabled

The drive uses the frequency reference to detect the direction of motor rotation.

1 : Enabled

The drive detects the direction of motor rotation during Speed Search.

■ b3-17: Speed Est Retry Current Level

No. (Hex.)	Name	Description	Default (Range)
b3-17 (01F0) Expert	Speed Est Retry Current Level	<div style="display: flex; gap: 5px;"> V/f OLV OLV/PM AOLV/PM EZOLV </div> Sets the current level for the search retry function in Speed Estimation Speed Search as a percentage where drive rated current is a setting value of 100%.	150% (0 - 200%)

When a large quantity of current flows during Speed Estimation Speed Search, the drive temporarily stops operation to prevent overvoltage and overcurrent. When the current is at the level set in *b3-17*, the drive tries speed search again.

■ b3-18: Speed Est Retry Detection Time

No. (Hex.)	Name	Description	Default (Range)
b3-18 (01F1) Expert	Speed Est Retry Detection Time	<div style="display: flex; gap: 5px;"> V/f OLV OLV/PM AOLV/PM EZOLV </div> Sets the length of time that the drive will wait to retry Speed Estimation Speed Search when too much current flow stopped the Speed Search.	0.10 s (0.00 - 1.00 s)

When the current is more than the level set in *b3-17* [*Speed Est Retry Current Level*] during the time set in *b3-18*, the drive tries speed search again.

■ b3-19: Speed Search Restart Attempts

No. (Hex.)	Name	Description	Default (Range)
b3-19 (01F2)	Speed Search Restart Attempts	<div style="display: flex; gap: 5px;"> V/f OLV OLV/PM AOLV/PM EZOLV </div> Sets the number of times to restart Speed Search if Speed Search does not complete.	3 times (0 - 10 times)

If the drive does the number of Speed Search restarts set in this parameter, it will trigger an *SEr* [*Speed Search Retries Exceeded*] error.

■ b3-24: Speed Search Method Selection

No. (Hex.)	Name	Description	Default (Range)
b3-24 (01C0)	Speed Search Method Selection	<div style="display: flex; gap: 5px;"> V/f OLV OLV/PM AOLV/PM EZOLV </div> Sets the Speed Search method when you start the motor or when you restore power after a momentary power loss.	2 (1, 2)

Note:

- When *A1-02* = 8 [*Control Method Selection* = *EZOLV*], the default setting changes when the setting for *E9-01* [*Motor Type Selection*] and the drive model change.
 - E9-01* = 0 [Induction (IM)]
 - E9-01* = 1, 2 [Permanent Magnet (PM), Synchronous Reluctance (SynRM)]: 1
- When you set *A1-02* = 8 and *E9-01* = 1 or 2, set *b3-24* = 1. If *b3-24* = 2, the drive will detect *oPE08* [*Parameter Selection Error*].
- When you set *b3-24*, it will trigger the drive to initialize *b3-14* [*Bi-directional Speed Search*]. After you set *b3-24*, set *b3-14*.

Set *b3-01* = 1 [*Speed Search at Start Selection* = *Enabled*] to do Speed Search at start. Set *L2-01* = 1 [*Power Loss Ride Through Select* = *Enabled for L2-02 Time*] to do Speed Search after you restore power after a momentary power loss.

1 : Speed Estimation

The drive uses the residual voltage from a short baseblock time to estimate the motor speed.

If there is not sufficient residual voltage, then the drive will inject DC current into the motor to estimate the motor speed.

2 : Current Detection 2

The drive will inject DC current into the motor to estimate motor speed.

■ b3-25: Speed Search Wait Time

No. (Hex.)	Name	Description	Default (Range)
b3-25 (01C8) Expert	Speed Search Wait Time	<div style="display: flex; justify-content: space-between; align-items: center;"> V/f OLV OLV/PM AOLV/PM EZOLV </div> Sets the length of time the drive will wait to start the Speed Search Retry function.	0.5 s (0.0 - 30.0 s)

If the drive detects these faults during speed search, increase the setting value:

- *oC* [Overcurrent]
- *ov* [Overvoltage]
- *SEr* [Speed Search Retries Exceeded]

■ b3-26: Direction Determination Level

No. (Hex.)	Name	Description	Default (Range)
b3-26 (01C7) Expert	Direction Determination Level	<div style="display: flex; justify-content: space-between; align-items: center;"> V/f OLV OLV/PM AOLV/PM EZOLV </div> Sets the level to find the motor rotation direction. Increase the value if the drive cannot find the direction.	1000 (40 to 60000)

■ b3-29: Speed Search Back-EMF Threshold

No. (Hex.)	Name	Description	Default (Range)
b3-29 (077C) Expert	Speed Search Back-EMF Threshold	<div style="display: flex; justify-content: space-between; align-items: center;"> V/f OLV OLV/PM AOLV/PM EZOLV </div> Sets the induced voltage for motors that use Speed Search. The drive will start Speed Search when the motor induced voltage level is the same as the setting value. Usually it is not necessary to change this setting.	10% (0 - 10%)

To make adjustments, gradually decrease the setting value. If you decrease the setting value too much, speed search will not operate correctly.

■ b3-31: Spd Search Current Reference Lvl

No. (Hex.)	Name	Description	Default (Range)
b3-31 (0BC0) Expert	Spd Search Current Reference Lvl	<div style="display: flex; justify-content: space-between; align-items: center;"> V/f OLV OLV/PM AOLV/PM EZOLV </div> Sets the current level that decreases the output current during Current Detection Speed Search.	1.50 (1.50 - 3.50)

Set this parameter as a ratio of $E2-03$ [Motor No-Load Current]. The setting is a ratio with respect to 30% of the motor rated current when $E2-03 \leq E2-01$ [Motor Rated Current (FLA)] $\times 0.3$.

Note:

When $A1-02 = 8$ [Control Method Selection = EZOLV], the setting is a ratio with respect to $E9-06$ [Motor Rated Current (FLA)] $\times 0.5$.

■ b3-32: Spd Search Current Complete Lvl

No. (Hex.)	Name	Description	Default (Range)
b3-32 (0BC1) Expert	Spd Search Current Complete Lvl	<div style="display: flex; justify-content: space-between; align-items: center;"> V/f OLV OLV/PM AOLV/PM EZOLV </div> Sets the current level that completes Speed Search.	1.20 (0.00 - 1.49)

The Current Detection Speed Search gradually decreases the output frequency to search for the motor speed when the output current is equal to or less than Speed Search Current Complete Level.

Set this parameter as a ratio of $E2-03$ [Motor No-Load Current]. The setting is a ratio with respect to 30% of the motor rated current when $E2-03 \leq E2-01$ [Motor Rated Current (FLA)] $\times 0.3$.

Note:

When $A1-02 = 8$ [Control Method Selection = EZOLV], the setting is a ratio with respect to $E9-06$ [Motor Rated Current (FLA)] $\times 0.5$.

■ b3-33: Speed Search during Uv Selection

No. (Hex.)	Name	Description	Default (Range)
b3-33 (0B3F) Expert	Speed Search during Uv Selection	<div style="display: flex; justify-content: space-between; align-items: center;"> V/f OLV OLV/PM AOLV/PM EZOLV </div> Sets the function that starts Speed Search at start-up if the drive detects a Uv [Undervoltage] when it receives a Run command.	1 (0, 1)

Set these three parameters as shown to enable b3-33:

- L2-01 = 1, 2 [Power Loss Ride Through Select = Enabled for L2-02 Time, Enabled while CPU Power Active]
- b3-01 = 1 [Speed Search at Start Selection = Enabled]
- b1-03 = 1 [Stopping Method Selection = Coast to Stop]

0 : Disabled

1 : Enabled

■ b3-39: Regen Judgment Lv of Spd Search

No. (Hex.)	Name	Description	Default (Range)
b3-39 (1B8F) Expert	Regen Judgment Lv of Spd Search	<div style="display: flex; justify-content: space-between; align-items: center;"> V/f OLV OLV/PM AOLV/PM EZOLV </div> Sets the level to determine the regenerative state during speed search. Usually it is not necessary to change this setting.	15% (0 - 50%)

If the speed search is not completed after starting the speed search, increase the setting value in 5% increments after the drive stops.

If the drive detects ov [Overvoltage] during speed search, decrease the setting value in 5% increments after the drive stops.

■ b3-54: Search Time

No. (Hex.)	Name	Description	Default (Range)
b3-54 (3123)	Search Time	<div style="display: flex; justify-content: space-between; align-items: center;"> V/f OLV OLV/PM AOLV/PM EZOLV </div> Sets the length of time that the drive will run Speed Search.	400 ms (10 - 2000 ms)

If you set this parameter too low, Speed Search will not operate correctly.

If the drive detects oC [Overcurrent] immediately after Speed Search Starts:

- Increase the value of L2-03 [Minimum Baseblock Time] and decrease the motor speed you use to start Speed Search.
- Increases the setting value of b3-08 [Speed Estimation ACR P Gain].
- Increase the value of b3-54.

If the drive detects oC or ov [DC Bus Overvoltage] during Speed Search, increase the value of b3-08.

■ b3-55: Current Increment Time

No. (Hex.)	Name	Description	Default (Range)
b3-55 (3124) Expert	Current Increment Time	<div style="display: flex; justify-content: space-between; align-items: center;"> V/f OLV OLV/PM AOLV/PM EZOLV </div> Sets the length of time that the drive will increase the current from zero current to the setting value of b3-06 [Speed Estimation Current Level 1].	10 ms (10 - 2000 ms)

Gradually increase the setting value when a large quantity of current flows after speed search starts. If you set this value too high, speed search will not operate correctly.

■ b3-56: InverseRotationSearch WaitTime

No. (Hex.)	Name	Description	Default (Range)
b3-56 (3126)	InverseRotationSearch WaitTime	<div style="display: flex; justify-content: space-between; align-items: center;"> V/f OLV OLV/PM AOLV/PM EZOLV </div> <p>Sets the wait time until the drive starts inverse rotation search after it completes forward search when you do inverse rotation search during Current Detection Speed Search.</p>	Determined by o2-04 (0.1 - 5.0 s)

■ b3-61: Initial Pole Detection Gain

No. (Hex.)	Name	Description	Default (Range)
b3-61 (1B96) Expert	Initial Pole Detection Response Gain	<div style="display: flex; justify-content: space-between; align-items: center;"> V/f OLV OLV/PM AOLV/PM EZOLV </div> <p>Sets the responsiveness for initial motor magnetic pole calculation when $A1-02 = 6$ [Control Method Selection = AOLV/PM]. Set $b3-61 > 0.0$ for an ordinary IPM motor.</p>	5.0 (-20.0 - +20.0)

Used when $n8-35 = 1$ [Initial Pole Detection Method = High Frequency Injection]. Sets the responsiveness for initial motor magnetic pole calculation. Set this parameter to a positive value for an ordinary motor. When you use High Frequency injection Tuning, it will automatically set this parameter.

◆ b4: Timer Function

The drive uses timers to delay activating and deactivating MFDO terminals.

Timers prevent sensors and switches from making chattering noise.

There are two types of timers:

- Timers that set a delay for timer inputs and timer outputs. These timers delay activating and deactivating of the MFDI and MFDOs. To enable this function, set $H1-xx = 18$ [MFDI Function Selection = Timer Function], and set $H2-01$ to $H2-03 = 12$ [MFDO Function Selection = Timer Output].
- Timers that set a delay to activate and deactivate MFDO terminals. These timers delay activating and deactivating MFDO terminals. To enable this function, set delay times in parameters $b4-03$ to $b4-08$.

■ Timer Function Operation

- Timers that Set a Delay for Timer Inputs and Timer Outputs
Triggers timer output if the timer input is active for longer than the time set in $b4-01$ [Timer Function ON-Delay Time]. Triggers timer output late for the time set in $b4-02$ [Timer Function OFF-Delay Time]. Figure 2.19 shows an example of how the timer function works.

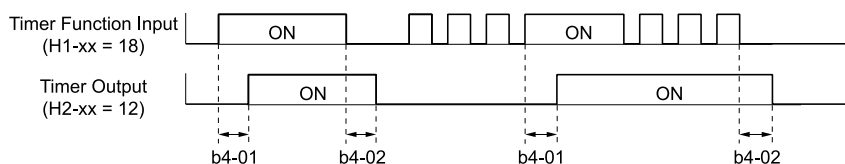

Figure 2.19 Example of Timer Function Operation

- Setting On/Off-delay Time for MFDO
Figure 2.20 uses $H2-01$ terminals to show an example of how the timer function works. Use $b4-03$ [Terminal M1-M2 ON-Delay Time] and $b4-04$ [Terminal M1-M2 OFF-Delay Time] to set this function.

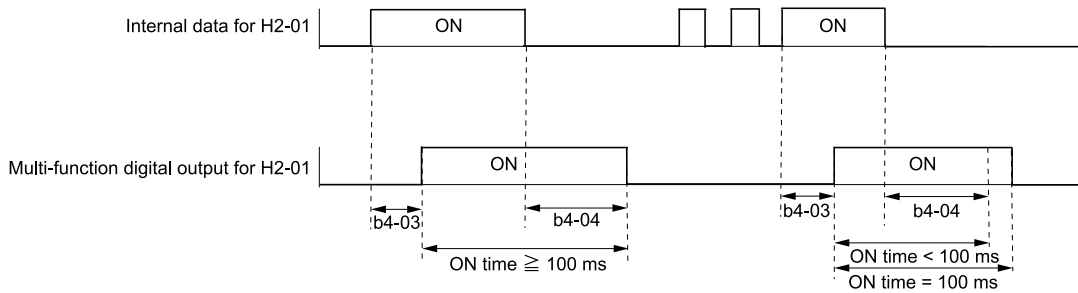

Figure 2.20 Example of How the Timer Function Works with H2-01 Terminals

Note:

When the terminal is triggered, it continues for a minimum of 100 ms. The on/off-delay time of MFDO terminal does not have an effect.

■ **b4-01: Timer Function ON-Delay Time**

No. (Hex.)	Name	Description	Default (Range)
b4-01 (01A3)	Timer Function ON-Delay Time	V/f OLV OLV/PM AOLV/PM EZOLV Sets the ON-delay time for the timer input.	0.0 s (0.0 - 3000.0 s)

■ **b4-02: Timer Function OFF-Delay Time**

No. (Hex.)	Name	Description	Default (Range)
b4-02 (01A4)	Timer Function OFF-Delay Time	V/f OLV OLV/PM AOLV/PM EZOLV Sets the OFF-delay time for the timer input.	0.0 s (0.0 - 3000.0 s)

■ **b4-03: Terminal M1-M2 ON-Delay Time**

No. (Hex.)	Name	Description	Default (Range)
b4-03 (0B30) Expert	Terminal M1-M2 ON-Delay Time	V/f OLV OLV/PM AOLV/PM EZOLV Sets the delay time to activate the contact after the function set in <i>H2-01</i> activates.	0 ms (0 - 65000 ms)

■ **b4-04: Terminal M1-M2 OFF-Delay Time**

No. (Hex.)	Name	Description	Default (Range)
b4-04 (0B31) Expert	Terminal M1-M2 OFF-Delay Time	V/f OLV OLV/PM AOLV/PM EZOLV Sets the delay time to deactivate the contact after the function set in <i>H2-01</i> deactivates.	0 ms (0 - 65000 ms)

■ **b4-05: Terminal M3-M4 ON-Delay Time**

No. (Hex.)	Name	Description	Default (Range)
b4-05 (0B32) Expert	Terminal M3-M4 ON-Delay Time	V/f OLV OLV/PM AOLV/PM EZOLV Sets the delay time to activate the contact after the function set in <i>H2-02</i> activates.	0 ms (0 - 65000 ms)

■ **b4-06: Terminal M3-M4 OFF-Delay Time**

No. (Hex.)	Name	Description	Default (Range)
b4-06 (0B33) Expert	Terminal M3-M4 OFF-Delay Time	V/f OLV OLV/PM AOLV/PM EZOLV Sets the delay time to deactivate the contact after the function set in <i>H2-02</i> deactivates.	0 ms (0 - 65000 ms)

■ b4-07: Terminal P2 ON-Delay Time

No. (Hex.)	Name	Description	Default (Range)
b4-07 (0B34) Expert	Terminal P2 ON-Delay Time	<div style="display: flex; gap: 5px;"> V/f OLV OLV/PM AOLV/PM EZOLV </div> Sets the delay time until the contact is turned ON after the function set with <i>H2-03</i> turns ON.	0 ms (0 - 65000 ms)

■ b4-08: Terminal P2 OFF-Delay Time

No. (Hex.)	Name	Description	Default (Range)
b4-08 (0B35) Expert	Terminal P2 OFF-Delay Time	<div style="display: flex; gap: 5px;"> V/f OLV OLV/PM AOLV/PM EZOLV </div> Sets the delay time to deactivate the contact after the function set in <i>H2-03</i> deactivates.	0 ms (0 - 65000 ms)

◆ b5: PID control

The drive has a PID control function. You can control drive output to adjust the proportional gain, integral time, and derivative time that has an effect on the bias between the target value and the feedback value to match the target value to the detected value. Use this function to adjust the drive output to accurately match the flow, pressure, and temperature in the application match the target value.

Use a combination of these controls to increase the performance:

- **P control**
P control has a proportional effect on the deviation. It outputs the product (the controlled output) proportional to the deviation. You cannot use only the offset from P control to get to zero deviation.
- **I control**
I control is the integral of the deviation. It uses an integral value of the deviation to output the product (the controlled output). I control helps align the feedback value and the target value. If you use only a proportional effect (P control), it will cause an offset. Use a proportional effect with integral control, and the offset will disappear over time.
- **D control**
D control is the derivative of the deviation. D control has an effect on drive output when there are sudden, large changes in the deviation or feedback value. It quickly returns drive output to the value before the sudden change. It multiplies a time constant by a derivative value of the deviation (slope of the deviation), and adds that result to PID input to calculate the deviation of the signal, then it corrects the deviation.

Note:

D control causes less stable operation because the noise changes the deviation signal. Use D control only when necessary.

■ PID Control Operation

Figure 2.21 shows PID control operation. The modified output (output frequency) changes when the drive uses PID control to keep the deviation (the difference between the target value and the feedback value) constant.

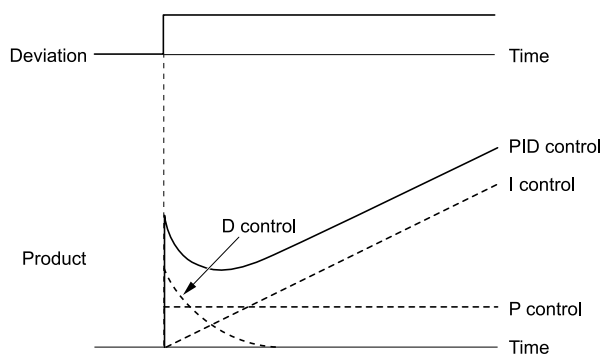

Figure 2.21 PID Control Operation

■ PID Control Applications

Table 2.22 shows applications for PID control.

Table 2.22 PID Control Applications

Application	Control Content	Sensors Used
Speed Control	<ul style="list-style-type: none"> The drive uses a feedback signal for the machine speed, and adjusts that speed to align with the target value. The drive uses speed data from other machinery as the target value to do synchronous control. The drive then adds that target value to the feedback from the machine it is operating to align its speed with the other machinery. 	Tacho generator
Pressure control	The drive uses feedback from the actual pressure to hold constant pressure.	Pressure sensor
Flow control	The drive uses feedback from the actual flow to hold constant flow.	Flow rate sensor
Temperature control	The drive uses feedback from the actual temperature to control a fan and hold constant temperature.	Thermocoupler, thermistor

■ Input Methods for the PID Setpoint

Use *b5-01 [PID Mode Setting]* to select how the PID setpoint is input to the drive.

One of the inputs in Table 2.23 will be the PID setpoint.

When the input in Table 2.23 is disabled, either the frequency reference set in *b1-01 [Frequency Reference Selection 1]* or *b1-15 [Frequency Reference Selection 2]* will be the PID setpoint.

Table 2.23 Input Methods for the PID Setpoint

Input Methods for the PID Setpoint	Setting Value
MFAI terminal A1	Set <i>H3-02 = C [Terminal A1 Function Selection = PID Setpoint]</i> .
MFAI terminal A2	Set <i>H3-10 [Terminal A2 Function Selection] = C</i> .
MEMOBUS/Modbus register 0006H	Sets MEMOBUS/Modbus register 000FH (Control Selection Setting) bit 1 to 1 (PID setpoint input). Enters the PID setpoint to MEMOBUS/Modbus register 0006H (PID Target, 0.01% units, signed).
Pulse train input terminal RP	Set <i>H6-01 = 2 [Terminal RP Pulse Train Function = PID Setpoint Value]</i> .
<i>b5-19 [PID Setpoint Value]</i>	Set <i>b5-18 = 1 [b5-19 PID Setpoint Selection = Enabled]</i> . Enters the PID setpoint to <i>b5-19</i> .

Note:

If you set two inputs for the PID setpoint, it will trigger operation error *oPE07 [Analog Input Selection Error]*.

■ Entering the PID Feedback Value

You can use two methods to input the PID feedback value to the drive. One method uses a single feedback signal for usual PID control. The other method uses two signals. The difference between those signals sets the deviation.

• Use a single feedback signal.

Use Table 2.24 to select how the feedback signal is input to the drive for PID control.

Table 2.24 PID Feedback Input Method

PID Feedback Input Method	Setting Value
MFAI terminal A1	Set <i>H3-02 = B [PID Feedback]</i> .
MFAI terminal A2	Set <i>H3-10 = B</i> .
Pulse train input terminal RP	Set <i>H6-01 = 1 [PID Feedback Value]</i> .

• Use two signals, and use the difference between those signals as the feedback signal.

The drive uses two feedback signals, and the difference between those signals becomes the deviation.

Use Table 2.25 to select how the second feedback value is input to the drive. The drive calculates the deviation of the second feedback value. Set *H3-02 or H3-10 = 16 [Terminal A1 or A2 Function Selection = Differential PID Feedback]* to enable the second feedback signal used to calculate the deviation.

Table 2.25 PID Differential Feedback Input Method

PID Differential Feedback Input Method	Setting Value
MFAI terminal A1	Set H3-02 = 16 [Differential PID Feedback].
MFAI terminal A2	Set H3-10 = 16.

Note:

If you set H3-02 and H3-10 = 16, it will trigger oPE07 [Analog Input Selection Error].

■ PID Control Block Diagram

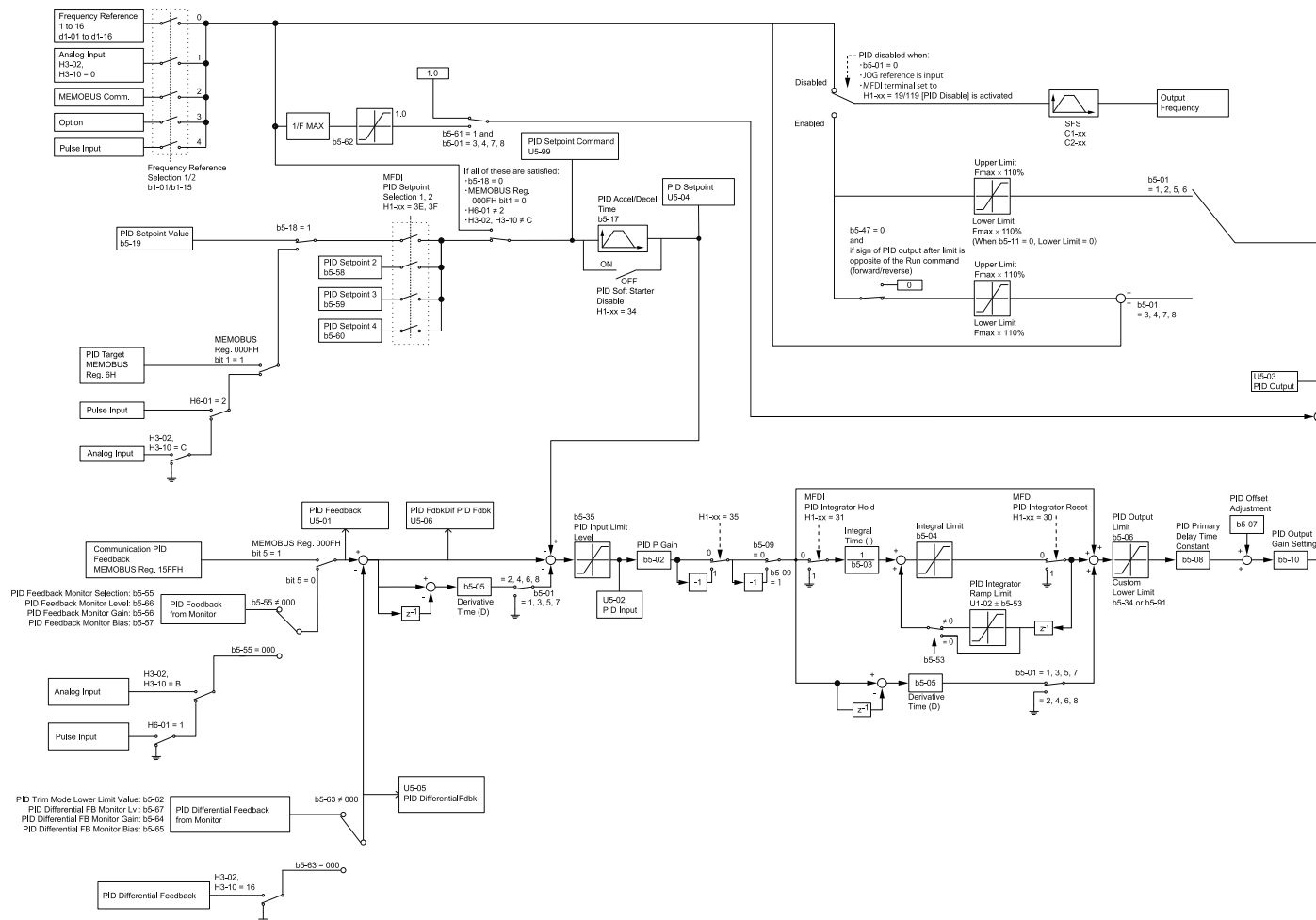

Figure 2.22 PID Control Block Diagram

■ PID Feedback Loss Detection

The PID feedback loss detection function detects broken sensors and defective wiring between the drive and sensors. Use the PID feedback loss detection function when you use PID control. If the feedback signal is too low, the motor can suddenly accelerate to the maximum output frequency. This function prevents such risks to the load.

The drive uses two methods to detect feedback loss:

- *PID Feedback Loss [FbL]*
Set these parameters for the PID feedback loss detection function.
The drive detects feedback loss when the feedback value is less than the value in b5-13 for longer than the time in b5-14.
 - b5-12 [Feedback Loss Detection Select]
 - b5-13 [PID Feedback Loss Detection Lvl]
 - b5-14 [PID Feedback Loss Detection Time]

Parameter Details

• *Excessive PID Feedback [FbH]*

Set these parameters to set how the drive detects a feedback level that is too high.

The drive detects too much PID feedback when the feedback value is more than the value in *b5-36* for longer than the time in *b5-37*.

- *b5-12 [Feedback Loss Detection Select]*
- *b5-36 [PID High Feedback Detection Lvl]*
- *b5-37 [PID High Feedback Detection Time]*

Figure 2.23 shows the operation principle when the feedback value is too low, and the drive detects feedback loss. The operation is the same when the drive detects too much feedback.

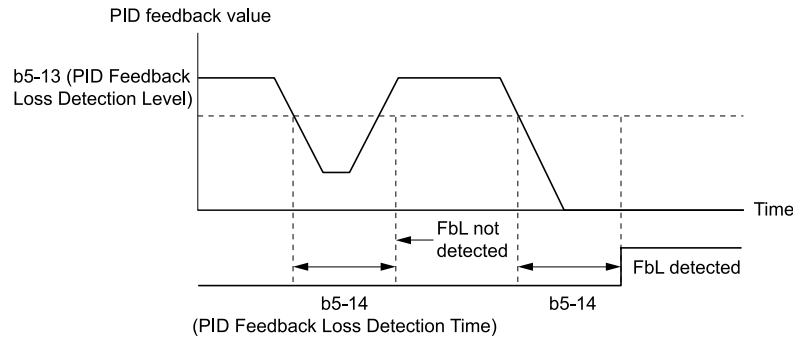

Figure 2.23 Time Chart for PID Feedback Loss Detection Time

■ **PID Sleep**

PID sleep stops drive operation when the PID output or the frequency reference is less than *b5-15 [PID Sleep Function Start Level]*. This function shuts off drive output after the motor decelerates to the set frequency.

The drive will automatically restart the motor when the PID output or the frequency reference is more than the *b5-15* value for the time set in *b5-16 [PID Sleep Delay Time]*.

Figure 2.24 shows the PID Sleep function.

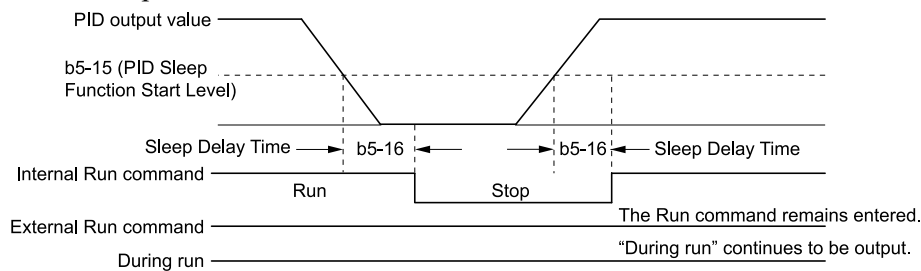

Figure 2.24 PID Sleep Time Chart

Note:

- The PID Sleep function is enabled when PID control is disabled.
- When the PID Sleep function is triggered, the drive will stop the motor as specified by *b1-03 [Stopping Method Selection]*.

■ **Fine-Tuning PID**

Fine-tune the following parameter settings to have PID control eliminate problems with overshoot and oscillation.

- *b5-02 [Proportional Gain (P)]*
- *b5-03 [Integral Time (I)]*
- *b5-05 [Derivative Time (D)]*
- *b5-08 [PID Primary Delay Time Constant]*

Purpose	Procedure	Results
Prevent overshoot.	<ul style="list-style-type: none"> Set <i>b5-05 [Derivative Time (D)]</i> to a smaller value. Set <i>b5-03 [Integral Time (I)]</i> to a larger value. 	<p>Response</p> <p>Time</p>
Quickly stabilize control.	<ul style="list-style-type: none"> Set <i>b5-05 [Derivative Time (D)]</i> to a larger value. Set <i>b5-03 [Integral Time (I)]</i> to a smaller value. 	<p>Response</p> <p>Time</p>
Prevent long-cycle oscillations.	Set <i>b5-03 [Integral Time (I)]</i> to a larger value.	<p>Response</p> <p>Time</p>
Prevent short-cycle oscillations.	<ul style="list-style-type: none"> Set <i>b5-05 [Derivative Time (D)]</i> to a smaller value. If you set <i>b5-05 = 0.00 [Derivative Time (D) = disabling D control]</i> and it does not stop oscillation, then set <i>b5-02 [Proportional Gain (P)]</i> to a smaller value or set <i>b5-08 [PID Primary Delay Time Constant]</i> to a larger value. 	<p>Response</p> <p>Time</p>

■ EZ Sleep/Wake-up Functionality

Set *b5-89 = 1 [Sleep Method Selection = EZ Sleep/Wake-up]* to enable the EZ Sleep/Wake-up function.

Note:

- When *b5-89 = 0 [Sleep Mode Selection = Standard]*, the EZ Sleep function and related parameters are disabled. Parameter *b5-91 [EZ Sleep Minimum Speed]* is not included in this rule.
- Set *b5-89 = 1* to disable *b5-15 [PID Sleep Function Start Level]*.

2.3 b: Application

Setting Parameter	Description
<i>b5-90</i> [EZ Sleep Unit]	This parameter sets the unit of measure for <i>b5-92</i> [EZ Sleep Level]. When <i>b5-90</i> = 0 [0.1Hz units], the setting range of <i>b5-91</i> [EZ Sleep Minimum Speed] is 0.0 to 590.0 Hz. When <i>b5-90</i> = 1 [rev/min], the setting range is 0 to 35400 min ⁻¹ (r/min). Note: When you change <i>b5-90</i> , the value of <i>b5-92</i> is not automatically updated.
<i>b5-91</i> [EZ Sleep Minimum Speed]	Sets the output lower limit level for the PID control as Hz units or min ⁻¹ (r/min) units. When you use <i>b5-91</i> , set <i>b5-34</i> = 0.0 [PID Output Lower Limit Level = 0.0 (disabled)]. When you set the lower limit for PID output as a percentage of the Maximum Output Frequency, refer to page 191. The <i>b5-89</i> setting does not have an effect.
<i>b5-92</i> [EZ Sleep Level]	When the output frequency or motor speed is less than the value of <i>b5-92</i> for longer than the value of <i>b5-93</i> [EZ Sleep Time], the drive does to sleep.
<i>b5-95</i> = 0 [EZ Sleep Wake-up Mode = Absolute]	When the PID feedback is less than the value of <i>b5-94</i> [EZ Sleep Wake-up Level] for longer than the time set in <i>b5-96</i> [EZ Sleep Wake-up Time], the drive restarts operation from sleep.
<i>b5-95</i> = 1 [EZ Sleep Wake-up Mode = Setpoint Delta]	The drive resumes operation from the sleep state when the PID feedback has dropped below the value defined as the PID setpoint value minus <i>b5-94</i> continuously for the time configured with <i>b5-96</i> .

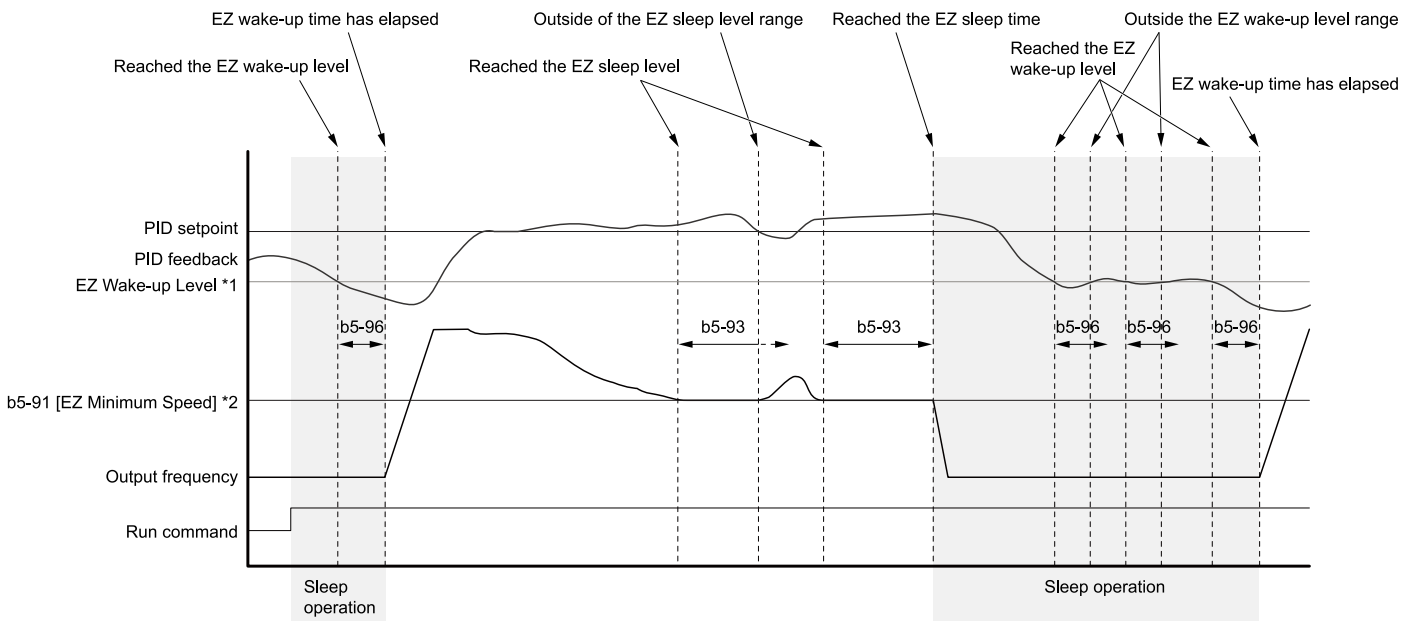

Figure 2.25 EZ Sleep/Wake-up Operation: PID Output is Normal and *b5-92* = 0.0 Hz

*1 The values of *b5-94* and *b5-95* set operation.

*2 In the example, *b5-92* is at the default setting of 0.0 Hz. Parameter *b5-91* is the EZ sleep level.

■ b5-01: PID Mode Setting

No. (Hex.)	Name	Description	Default (Range)
b5-01 (01A5)	PID Mode Setting	<input type="checkbox"/> V/f <input type="checkbox"/> OLV <input type="checkbox"/> OLV/PM <input type="checkbox"/> AOLV/PM <input type="checkbox"/> EZOLV Sets the type of PID control.	0 (0 - 8)

0 : Disabled

1 : Standard

Enables PID control. The drive does D control on the difference between the feedback value and the PID setpoint output through *U5-02* [PID Input].

2 : Standard (D on feedback)

Enables PID control. The drive does D control on the feedback output through *U5-06* [PID FdbkDif PID Fdbk].

3 : Fref + PID Trim

Enables PID control. The drive adds the frequency reference to the PID output. The drive does D control on the difference between the feedback value and the PID setpoint output through *U5-02* [PID Input].

4 : Fref + PID Trim (D on feedback)

Enables PID control. The drive adds the frequency reference to the PID output. The drive does D control on the feedback output through *U5-06 [PID FdbkDif PID Fdbk]*.

5 : Same as 7series & prior, b5-01=1

6 : Same as 7series & prior, b5-01=2

7 : Same as 7series & prior, b5-01=3

8 : Same as 7series & prior, b5-01=4

Note:

Use settings 5 to 8 instead of settings 1 to 4 when the drive is a replacement for Varispeed F7.

■ b5-02: Proportional Gain (P)

No. (Hex.)	Name	Description	Default (Range)
b5-02 (01A6) RUN	Proportional Gain (P)	V/f OLV OLV/PM AOLV/PM EZOLV Sets the proportional gain (P) that is applied to PID input.	1.00 (0.00 - 25.00)

Larger values decrease errors, but can cause oscillations. Smaller values let too much offset between the setpoint and feedback.

Set *b5-02 = 0.00* to disable P control.

■ b5-03: Integral Time (I)

No. (Hex.)	Name	Description	Default (Range)
b5-03 (01A7) RUN	Integral Time (I)	V/f OLV OLV/PM AOLV/PM EZOLV Sets the integral time (I) that is applied to PID input.	1.0 s (0.0 - 360.0 s)

Set a short integral time in *b5-03* to remove the offset more quickly. If the integral time is too short, overshoot or oscillation can occur.

Set *b5-03 = 0.00* to disable I control.

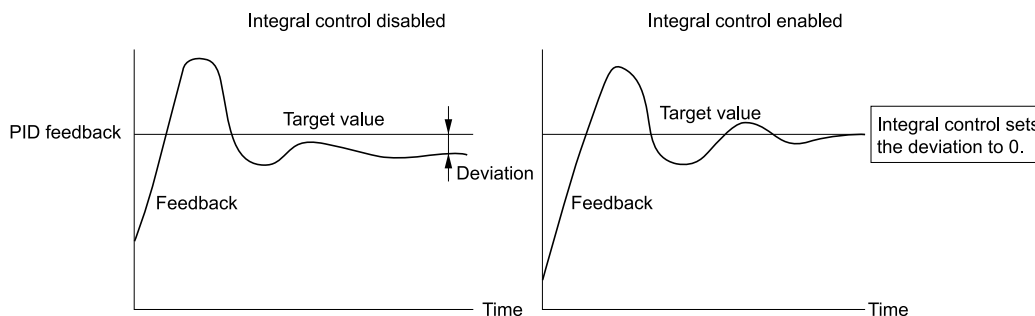

Figure 2.26 Integral Time and Deviation

■ b5-04: Integral Limit

No. (Hex.)	Name	Description	Default (Range)
b5-04 (01A8) RUN	Integral Limit	V/f OLV OLV/PM AOLV/PM EZOLV Sets the upper limit for integral control (I) as a percentage of the Maximum Output Frequency.	100.0% (0.0 - 100.0%)

Applications with loads that quickly change will cause the output of the PID function to oscillate. Set this parameter to a low value to prevent oscillation, mechanical loss, and motor speed loss.

■ b5-05: Derivative Time (D)

No. (Hex.)	Name	Description	Default (Range)
b5-05 (01A9) RUN	Derivative Time (D)	<div style="display: flex; gap: 5px;"> V/f OLV OLV/PM AOLV/PM EZOLV </div> Sets the derivative time (D) for PID control. This parameter adjusts system responsiveness.	0.00 s (0.00 - 10.00 s)

When you increase the time setting, it will increase controller responsiveness, but it can also cause vibration. When you decrease the time setting, it will suppress overshoot and decrease controller responsiveness.

Set $b5-05 = 0.00$ to disable D control.

■ b5-06: PID Output Limit

No. (Hex.)	Name	Description	Default (Range)
b5-06 (01AA) RUN	PID Output Limit	<div style="display: flex; gap: 5px;"> V/f OLV OLV/PM AOLV/PM EZOLV </div> Sets the maximum possible output from the PID controller as a percentage of the Maximum Output Frequency.	100.0% (0.0 - 100.0%)

■ b5-07: PID Offset Adjustment

No. (Hex.)	Name	Description	Default (Range)
b5-07 (01AB) RUN	PID Offset Adjustment	<div style="display: flex; gap: 5px;"> V/f OLV OLV/PM AOLV/PM EZOLV </div> Sets the offset for the PID control output as a percentage of the Maximum Output Frequency.	0.0% (-100.0 - +100.0%)

■ b5-08: PID Primary Delay Time Constant

No. (Hex.)	Name	Description	Default (Range)
b5-08 (01AC) RUN Expert	PID Primary Delay Time Constant	<div style="display: flex; gap: 5px;"> V/f OLV OLV/PM AOLV/PM EZOLV </div> Sets the primary delay time constant for the PID control output. Usually it is not necessary to change this setting.	0.00 s (0.00 - 10.00 s)

Prevents resonance if there is a large quantity of mechanical friction or if rigidity is unsatisfactory. Set the value larger than the resonant frequency cycle. A value that is too large will decrease drive responsiveness.

■ b5-09: PID Output Level Selection

No. (Hex.)	Name	Description	Default (Range)
b5-09 (01AD)	PID Output Level Selection	<div style="display: flex; gap: 5px;"> V/f OLV OLV/PM AOLV/PM EZOLV </div> Sets the polarity of the PID output.	0 (0, 1)

Use this parameter in applications that decrease the drive output frequency when you increase the PID setpoint.

0 : Normal Output (Direct Acting)

A positive PID input increases the PID output (direct acting).

1 : Reverse Output (Reverse Acting)

A positive PID input decreases the PID output (reverse acting).

■ b5-10: PID Output Gain Setting

No. (Hex.)	Name	Description	Default (Range)
b5-10 (01AE) RUN	PID Output Gain Setting	<div style="display: flex; gap: 5px;"> V/f OLV OLV/PM AOLV/PM EZOLV </div> Sets the amount of gain to apply to the PID output.	1.00 (0.00 - 25.00)

Applies a gain to the PID output and can help when $b5-01 = 3$ or 4 [*PID Mode Setting = Fref + PID Trim, Fref + PID Trim (D on feedback)*].

■ b5-11: PID Output Reverse Selection

No. (Hex.)	Name	Description	Default (Range)
b5-11 (01AF)	PID Output Reverse Selection	<input type="checkbox"/> V/f <input type="checkbox"/> OLV <input type="checkbox"/> OLV/PM <input type="checkbox"/> AOLV/PM <input type="checkbox"/> EZOLV Sets the function that enables and disables reverse motor rotation for negative PID control output.	0 (0, 1)

This parameter is disabled when $b5-01 = 3, 4$ [*PID Mode Setting = Fref + PID Trim, Fref + PID Trim (D on feedback)*]. There is no limit for PID output (PID output can be positive or negative). Operates the same as setting “1: Enabled: Negative lower limit”.

0 : Lower Limit is Zero

When PID output is negative, PID output is limited to 0 and drive output is shut off.

1 : Negative Output Accepted

When the PID output is negative, the motor will rotate in reverse. When $b1-04 = 1$ [*Reverse Operation Selection = Reverse Disabled*], the lower limit is 0.

■ b5-12: Feedback Loss Detection Select

No. (Hex.)	Name	Description	Default (Range)
b5-12 (01B0)	Feedback Loss Detection Select	<input type="checkbox"/> V/f <input type="checkbox"/> OLV <input type="checkbox"/> OLV/PM <input type="checkbox"/> AOLV/PM <input type="checkbox"/> EZOLV Sets the drive response to PID feedback loss/excess. Sets drive operation after the drive detects PID feedback loss/excess.	0 (0 - 5)

0 : Digital Out Only, Always Detect

The MFDO terminal set for *PID Feedback Low* or *PID Feedback High* [$H2-01$ to $H2-03 = 3E, 3F$] activates. When the drive detects feedback loss/excess, the keypad will not show an alarm and the drive will continue operation.

When the feedback signal is less than the level set in $b5-13$ [*PID Feedback Loss Detection Lvl*] for longer than the time set in $b5-14$ [*PID Feedback Loss Detection Time*], the MFDO terminal set for *PID Feedback Low* activates.

When the feedback signal is more than the level set in $b5-36$ [*PID High Feedback Detection Lvl*] for longer than the time set in $b5-37$ [*PID High Feedback Detection Time*] the MFDO terminal set for *PID Feedback High* activates.

When the feedback value is not in the detection range, the drive resets the MFDO.

1 : Alarm + Digital Out, Always Det

The drive detects *FbL* [*PID Feedback Loss*] and *FbH* [*Excessive PID Feedback*]. The MFDO terminal set for *PID Feedback Low* or *PID Feedback High* [$H2-01$ to $H2-03 = 3E, 3F$] activates. The output terminal set for *Alarm* [$H2-01$ to $H2-03 = 10$] activates and the drive continues operation.

When the feedback signal is less than the level set in $b5-13$ for longer than the time set in $b5-14$, the MFDO terminal set for *PID Feedback Low* activates.

When the feedback signal is more than the level set in $b5-36$ for longer than the time set in $b5-37$, the MFDO terminal set for *PID Feedback High* activates.

When the feedback value is not in the detection range, the drive resets the MFDO.

2 : Fault + Digital Out, Always Det

The drive detects *FbL* and *FbH*. MFDO terminal MA-MC turns ON, MB-MC turns OFF, and the motor coasts to stop.

When the feedback signal is less than the level set in $b5-13$ for the time set in $b5-14$, the drive detects *FbL*.

When the feedback signal is more than the level set in $b5-36$ for the time set in $b5-37$, the drive detects *FbH*.

3 : Digital Out Only, @PID Enable

The MFDO terminal set for *PID Feedback Low* or *PID Feedback High* activates. The keypad will not show an alarm. The drive continues operation.

When the MFDI terminal set to *PID Disable* [$H1-xx = 19$] activates, the drive disables fault detection.

4 : Alarm + Digital Out, @PID Enable

2.3 b: Application

The drive detects *FbL* and *FbH*. The MFDO terminal set for *PID Feedback Low* or *PID Feedback High* activates. The output terminal set for *Alarm [H2-01 to H2-03 = 10]* activates and the drive continues operation.

When the MFDI terminal set to *PID Disable [H1-xx = 19]* activates, the drive disables fault detection.

5 : Fault + Digital Out, @PID Enable

The drive detects *FbL* and *FbH*. MFDO terminal MA-MC turns ON, MB-MC turns OFF, and the drive coasts to stop.

When the MFDI terminal set to *PID Disable [H1-xx = 19]* activates, the drive disables fault detection.

■ b5-13: PID Feedback Loss Detection Lvl

No. (Hex.)	Name	Description	Default (Range)
b5-13 (01B1)	PID Feedback Loss Detection Lvl	<input type="checkbox"/> V/f <input type="checkbox"/> OLV <input type="checkbox"/> OLV/PM <input type="checkbox"/> AOLV/PM <input type="checkbox"/> EZOLV Sets the level that triggers <i>PID Feedback Loss [FbL]</i> detection as a percentage of the Maximum Output Frequency.	0% (0 - 100%)

The drive detects *PID Feedback Loss [FbL]* when the feedback signal decreases to less than the level set in *b5-13* for longer than the time set in *b5-14 [PID Feedback Loss Detection Time]*.

■ b5-14: PID Feedback Loss Detection Time

No. (Hex.)	Name	Description	Default (Range)
b5-14 (01B2)	PID Feedback Loss Detection Time	<input type="checkbox"/> V/f <input type="checkbox"/> OLV <input type="checkbox"/> OLV/PM <input type="checkbox"/> AOLV/PM <input type="checkbox"/> EZOLV Sets the length of time that PID Feedback must be less than <i>b5-13 [PID Feedback Loss Detection Lvl]</i> to detect <i>PID Feedback Loss [FbL]</i> .	1.0 s (0.0 - 25.5 s)

■ b5-15: PID Sleep Function Start Level

No. (Hex.)	Name	Description	Default (Range)
b5-15 (01B3)	PID Sleep Function Start Level	<input type="checkbox"/> V/f <input type="checkbox"/> OLV <input type="checkbox"/> OLV/PM <input type="checkbox"/> AOLV/PM <input type="checkbox"/> EZOLV Sets the output level that triggers the PID Sleep function.	Determined by A1-02 (0.0 - 590.0)

The drive goes into Sleep mode when the PID output or frequency reference is less than *b5-15* for longer than the time set to *b5-16 [PID Sleep Delay Time]*. The drive continues operation when the PID output or frequency reference is more than *b5-15* for longer than the time set to *b5-16*.

■ b5-16: PID Sleep Delay Time

No. (Hex.)	Name	Description	Default (Range)
b5-16 (01B4)	PID Sleep Delay Time	<input type="checkbox"/> V/f <input type="checkbox"/> OLV <input type="checkbox"/> OLV/PM <input type="checkbox"/> AOLV/PM <input type="checkbox"/> EZOLV Sets a delay time to start or stop the PID Sleep function.	0.0 s (0.0 - 25.5 s)

■ b5-17: PID Accel/Decel Time

No. (Hex.)	Name	Description	Default (Range)
b5-17 (01B5) RUN	PID Accel/Decel Time	<input type="checkbox"/> V/f <input type="checkbox"/> OLV <input type="checkbox"/> OLV/PM <input type="checkbox"/> AOLV/PM <input type="checkbox"/> EZOLV Raises or lowers the PID setpoint using the acceleration and deceleration times set to the drive. This is a soft-starter for the PID setpoint.	0.0 s (0.0 - 6000.0 s)

The drive usually uses the acceleration and deceleration times set in *C1-xx [Accel and Decel Times]*, but when PID control is enabled, the drive applies *C1-xx* after PID output. If you frequently change the PID setpoint, the drive responsiveness decreases. When resonance with PID control causes hunting, overshoot, or undershoot, set *b5-17* for longer acceleration and deceleration times.

Decrease *C1-xx* until hunting stops, then use *b5-17* to check the acceleration and deceleration. To enable and disable the setting in *b5-17* through an MFDI terminal, set *PID Soft Starter Disable [H1-xx = 34]*.

■ b5-18: b5-19 PID Setpoint Selection

No. (Hex.)	Name	Description	Default (Range)
b5-18 (01DC)	b5-19 PID Setpoint Selection	V/f OLV OLV/PM AOLV/PM EZOLV Sets the function that enables and disables <i>b5-19 [PID Setpoint Value]</i> .	0 (0, 1)

0 : Disabled

The drive does not use the value set in *b5-19* as the PID setpoint.

1 : Enabled

The drive uses the value set in *b5-19* as the PID setpoint.

■ b5-19: PID Setpoint Value

No. (Hex.)	Name	Description	Default (Range)
b5-19 (01DD) RUN	PID Setpoint Value	V/f OLV OLV/PM AOLV/PM EZOLV Sets the PID setpoint when <i>b5-18 = 1 [b5-19 PID Setpoint Selection = Enabled]</i> .	0.00% (0.00 - 100.00%)

■ b5-20: PID Unit Selection

No. (Hex.)	Name	Description	Default (Range)
b5-20 (01E2)	PID Unit Selection	V/f OLV OLV/PM AOLV/PM EZOLV Sets the number of digits to set and show the PID setpoint.	1 (0 - 3)

Set the units for these parameters and monitors:

- b5-19 [PID Setpoint Value]
- b5-58 [PID Setpoint2]
- b5-59 [PID Setpoint3]
- b5-60 [PID Setpoint4]
- U5-01 [PID Feedback]
- U5-04 [PID Setpoint]
- U5-99 [PID Setpoint Command]

0 : 0.01Hz units

The drive uses 0.01 Hz units.

1 : 0.01% units

The drive uses 0.01% units. Set the value as a percentage of *E1-04 [Maximum Output Frequency]*.

2 : rev/min

The drive uses 1 rev/min unit. Set *E2-04, E4-04, or E5-04 [Motor Pole Count]*.

3 : User Units

The drive uses the units set in *b5-38 [PID User Unit Display Scaling]* and *b5-39 [PID User Unit Display Digits]* to show the PID setpoint in *U5-01, U5-04, U5-06 [PID Feedback, PID Setpoint, PID Fdbk-Diff PID Fdbk]*.

■ b5-34: PID Output Lower Limit Level

No. (Hex.)	Name	Description	Default (Range)
b5-34 (019F) RUN	PID Output Lower Limit Level	V/f OLV OLV/PM AOLV/PM EZOLV Sets the lower limit level for the PID control as a percentage of <i>E1-04 [Maximum Output Frequency]</i> .	0.0% (-100.0 - +100.0%)

Use a lower limit to keep PID control output from dropping below a fixed level.

When you use *b5-34*, set *b5-91 = 0 [EZ Sleep Minimum Speed = 0 (Disabled)]*.

2.3 b: Application

When you set the output lower limit level in Hz or min⁻¹ (r/min), refer to [b5-91: EZ Sleep Minimum Speed on page 196](#).

Set this parameter to 0.0% to disable this function.

■ b5-35: PID Input Limit Level

No. (Hex.)	Name	Description	Default (Range)
b5-35 (01A0) RUN	PID Input Limit Level	V/f OLV OLV/PM AOLV/PM EZOLV Sets the output upper limit for the PID control as a percentage of the Maximum Output Frequency.	1000.0% (0.0 - 1000.0%)

A large input value for PID control makes a high output. The drive applies this limit to the negative and positive domains.

■ b5-36: PID High Feedback Detection Lvl

No. (Hex.)	Name	Description	Default (Range)
b5-36 (01A1)	PID High Feedback Detection Lvl	V/f OLV OLV/PM AOLV/PM EZOLV Sets the level that triggers <i>Excessive PID Feedback [FbH]</i> as a percentage of the Maximum Output Frequency.	100% (0 - 100%)

When the feedback signal increases to more than the level set in *b5-36* for the time set in *b5-37* [*PID High Feedback Detection Time*], the drive will detect *Excessive PID Feedback [FbH]*.

■ b5-37: PID High Feedback Detection Time

No. (Hex.)	Name	Description	Default (Range)
b5-37 (01A2)	PID High Feedback Detection Time	V/f OLV OLV/PM AOLV/PM EZOLV Sets the length of time that the PID feedback signal must be more than the level set in <i>b5-36</i> [<i>PID Feedback High Detection Lvl</i>] to cause <i>Excessive PID Feedback [FbH]</i> .	1.0 s (0.0 - 25.5 s)

■ b5-38: PID User Unit Display Scaling

No. (Hex.)	Name	Description	Default (Range)
b5-38 (01FE)	PID User Unit Display Scaling	V/f OLV OLV/PM AOLV/PM EZOLV Sets the value that the drive sets or shows as the PID setpoint when at the maximum output frequency.	Determined by b5-20 (1 - 60000)

The drive uses this parameter and *b5-39* [*PID Setpoint Display Digits*] together.

When *b5-20* = 3 [*PID Unit Selection = User Units*], the drive applies user-set PID setpoint and display units to these parameters and monitors:

- b5-19 [PID Setpoint Value]
- b5-58 [PID Setpoint2]
- b5-59 [PID Setpoint3]
- b5-60 [PID Setpoint4]
- U5-01 [PID Feedback]
- U5-04 [PID Setpoint]
- U5-99 [PID Setpoint Command]

■ b5-39: PID User Unit Display Digits

No. (Hex.)	Name	Description	Default (Range)
b5-39 (01FF)	PID User Unit Display Digits	V/f OLV OLV/PM AOLV/PM EZOLV Sets the number of digits to set and show the PID setpoint.	Determined by b5-20 (0 - 3)

The drive uses this parameter and *b5-38* [*PID Setpoint User Display*] together.

When $b5-20 = 3$ [*PID Unit Selection = User Units*], the drive applies user-set PID setpoint and display units to these parameters and monitors:

- b5-19 [PID Setpoint Value]
- b5-58 [PID Setpoint2]
- b5-59 [PID Setpoint3]
- b5-60 [PID Setpoint4]
- U5-01 [PID Feedback]
- U5-04 [PID Setpoint]
- U5-99 [PID Setpoint Command]

0 : No Decimal Places (XXXXX)

1 : One Decimal Places (XXXX.X)

2 : Two Decimal Places (XXX.XX)

3 : Three Decimal Places (XX.XXX)

■ b5-40: Frequency Reference Monitor @PID

No. (Hex.)	Name	Description	Default (Range)
b5-40 (017F)	Frequency Reference Monitor @PID	<input type="checkbox"/> V/f <input type="checkbox"/> OLV <input type="checkbox"/> OLV/PM <input type="checkbox"/> AOLV/PM <input type="checkbox"/> EZOLV Sets the contents for monitor <i>UI-01</i> [<i>Frequency Reference</i>] in PID control.	0 (0, 1)

0 : U1-01 Includes PID Output

Monitor *UI-01* shows the frequency reference that was increased or decreased by the PID output.

1 : U1-01 Excludes PID Output

Monitor *UI-01* shows the actual frequency reference.

■ b5-47: PID Trim Mode Output Reverse Sel

No. (Hex.)	Name	Description	Default (Range)
b5-47 (017D)	PID Trim Mode Output Reverse Sel	<input type="checkbox"/> V/f <input type="checkbox"/> OLV <input type="checkbox"/> OLV/PM <input type="checkbox"/> AOLV/PM <input type="checkbox"/> EZOLV Sets reverse motor rotation when the PID control output is negative.	1 (0, 1)

This parameter is enabled when $b5-01 = 3$ or 4 [*PID Mode Setting = Fref + PID Trim, Fref + PID Trim (D on feedback)*].

0 : Lower Limit is Zero

When PID output is negative, PID output is limited to 0 and drive output is shut off.

1 : Negative Output Accepted

When the PID output is negative, the motor will rotate in reverse.

■ b5-53: PID Integrator Ramp Limit

No. (Hex.)	Name	Description	Default (Range)
b5-53 (0B8F) RUN	PID Integrator Ramp Limit	<input type="checkbox"/> V/f <input type="checkbox"/> OLV <input type="checkbox"/> OLV/PM <input type="checkbox"/> AOLV/PM <input type="checkbox"/> EZOLV Sets the responsiveness of PID control when the PID feedback changes quickly.	0.0 Hz (0.0 - 10.0 Hz)

Note:

- This parameter is disabled when set to 0.0 Hz.
- When $b5-53 > 0.0$ Hz and the drive enables the integrator ramp limit, the PID integrator value limit is the range set by the output frequency $\pm b5-53$.
- When the PID feedback changes quickly, gradually decrease the value of this parameter in increments of 0.1 Hz to decrease the speed of the response of PID control.

■ b5-55: PID Feedback Monitor Selection

No. (Hex.)	Name	Description	Default (Range)
b5-55 (0BE1)	PID Feedback Monitor Selection	V/f OLV OLV/PM AOLV/PM EZOLV Sets the monitor (<i>Ux-xx</i>) used as the PID Feedback. Set the <i>x-xx</i> part of the <i>Ux-xx</i> [Monitor].	000 (000 - 999)

Note:

- You cannot select *parameter U5-xx*.
- This parameter is disabled when set to 000.

■ b5-56: PID Feedback Monitor Gain

No. (Hex.)	Name	Description	Default (Range)
b5-56 (0BE2)	PID Feedback Monitor Gain	V/f OLV OLV/PM AOLV/PM EZOLV Sets the gain for the monitor set in <i>b5-55</i> [PID Feedback Monitor Selection].	1.00 (0.00 - 10.00)

■ b5-57: PID Feedback Monitor Bias

No. (Hex.)	Name	Description	Default (Range)
b5-57 (11DD)	PID Feedback Monitor Bias	V/f OLV OLV/PM AOLV/PM EZOLV Sets the bias for the monitor specified in <i>b5-55</i> [PID Feedback Monitor Selection].	0.00 (-10.00 - +10.00)

■ b5-58 to b5-60: PID Setpoints 2 to 4

No. (Hex.)	Name	Description	Default (Range)
b5-58 to b5-60: (1182 - 1184) RUN	PID Setpoints 2 to 4	V/f OLV OLV/PM AOLV/PM EZOLV Sets the PID setpoint when <i>H1-xx = 3E</i> or <i>3F</i> [MFDI Function Selection = PID Setpoint Selection 1/2]. This value is a percentage of the maximum output frequency.	0.00% (0.00 - 100.00%)

Table 2.26 shows how the different MFDI *H1-xx* values (*3E* and *3F*) have an effect on the PID setpoint value.

Table 2.26 Switching of MFDI and PID Setpoint Value

H1-xx = 3E	H1-xx = 3F	PID Setpoint Value
OFF	OFF	No switch
ON	OFF	b5-58 [PID Setpoint2]
OFF	ON	b5-59 [PID Setpoint3]
ON	ON	b5-60 [PID Setpoint4]

■ b5-61: PID Trim Mode Lower Limit Sel

No. (Hex.)	Name	Description	Default (Range)
b5-61 (119A)	PID Trim Mode Lower Limit Sel	V/f OLV OLV/PM AOLV/PM EZOLV Sets the function that adjusts the PID output in relation to the frequency reference.	0 (0, 1)

0 : Disabled

Does not adjust the PID output with the frequency reference.

1 : Enabled

Adjusts the PID output in relation to the frequency reference. The setting value of *b5-62* [PID Trim Mode Lower Limit Value] sets the lower limit of the post-adjustment value. The maximum output frequency sets the upper limit.

Note:

- Set $b5-01 = 3, 4, 7, \text{ or } 8$ to enable this parameter.
- When $b5-61 = 1$, you can use this formula to adjust PID output proportional to the frequency reference:

$$U5-03 = U5-03 \times \left| \frac{Fref}{Fmax} \right|^{*1}$$

$U5-03$ [PID Output], $Fref$ [Frequency Reference], and $Fmax$ [Maximum Output Frequency]

*1 Lower limit = $b5-62$, Upper limit = Maximum output frequency

■ b5-62: PID Trim Mode Lower Limit Value

No. (Hex.)	Name	Description	Default (Range)
b5-62 (119B)	PID Trim Mode Lower Limit Value	<input type="checkbox"/> V/f <input type="checkbox"/> OLV <input type="checkbox"/> OLV/PM <input type="checkbox"/> AOLV/PM <input type="checkbox"/> EZOLV Sets the PID Trim Mode Lower Limit Value as a percentage of the maximum output frequency.	0.00% (0.00 - 100.00%)

Note:

Set $b5-01 = 3, 4, 7, \text{ or } 8$ to enable this parameter.

■ b5-63: PID Differential FB Monitor Sel

No. (Hex.)	Name	Description	Default (Range)
b5-63 (119C)	PID Differential FB Monitor Sel	<input type="checkbox"/> V/f <input type="checkbox"/> OLV <input type="checkbox"/> OLV/PM <input type="checkbox"/> AOLV/PM <input type="checkbox"/> EZOLV Selects the monitor ($Ux-xx$) used as the PID Differential Feedback. Set the $x-xx$ part of the $Ux-xx$ [Monitor].	000 (000 - 999)

Note:

- You cannot select *parameter* $U5-xx$.
- This parameter is disabled when set to 000.

■ b5-64: PID Differential FB Monitor Gain

No. (Hex.)	Name	Description	Default (Range)
b5-64 (119D)	PID Differential FB Monitor Gain	<input type="checkbox"/> V/f <input type="checkbox"/> OLV <input type="checkbox"/> OLV/PM <input type="checkbox"/> AOLV/PM <input type="checkbox"/> EZOLV Sets the gain for the monitor specified in $b5-63$ [PID Differential FB Monitor Sel].	1.00 (0.00 - 10.00)

■ b5-65: PID Differential FB Monitor Bias

No. (Hex.)	Name	Description	Default (Range)
b5-65 (119F)	PID Differential FB Monitor Bias	<input type="checkbox"/> V/f <input type="checkbox"/> OLV <input type="checkbox"/> OLV/PM <input type="checkbox"/> AOLV/PM <input type="checkbox"/> EZOLV Sets the bias for the monitor specified in $b5-63$ [PID Differential FB Monitor Sel].	0.00 (-10.00 - +10.00)

■ b5-66: PID Feedback Monitor Level

No. (Hex.)	Name	Description	Default (Range)
b5-66 (11DE)	PID Feedback Monitor Level	<input type="checkbox"/> V/f <input type="checkbox"/> OLV <input type="checkbox"/> OLV/PM <input type="checkbox"/> AOLV/PM <input type="checkbox"/> EZOLV Sets the signal level for the monitor specified in $b5-55$ [PID Feedback Monitor Selection].	0 (0, 1)

0 : Absolute

1 : Bi-directional (+/-)

■ b5-67: PID Differential FB Monitor Lvl

No. (Hex.)	Name	Description	Default (Range)
b5-67 (11DF)	PID Differential FB Monitor Lvl	<input type="checkbox"/> V/f <input type="checkbox"/> OLV <input type="checkbox"/> OLV/PM <input type="checkbox"/> AOLV/PM <input type="checkbox"/> EZOLV Sets the signal level for the monitor specified in $b5-55$ [PID Differential FB Monitor Sel].	0 (0, 1)

0 : Absolute**1 : Bi-directional (+/-)****■ b5-89: Sleep Method Selection**

No. (Hex.)	Name	Description	Default (Range)
b5-89 (0B89) RUN	Sleep Method Selection	<input type="checkbox"/> V/f <input type="checkbox"/> OLV <input type="checkbox"/> OLV/PM <input type="checkbox"/> AOLV/PM <input type="checkbox"/> EZOLV Sets sleep and wake up operation when using PID.	0 (0, 1)

0 : Standard**1 : EZ Sleep/Wake-up****■ b5-90: EZ Sleep Unit**

No. (Hex.)	Name	Description	Default (Range)
b5-90 (0B90)	EZ Sleep Unit	<input type="checkbox"/> V/f <input type="checkbox"/> OLV <input type="checkbox"/> OLV/PM <input type="checkbox"/> AOLV/PM <input type="checkbox"/> EZOLV Sets the measurement units for b5-91 [EZ Sleep Minimum Speed] and b5-92 [EZ Sleep Level].	0 (0, 1)

0 : 0.1Hz units**1 : rev/min****■ b5-91: EZ Sleep Minimum Speed**

No. (Hex.)	Name	Description	Default (Range)
b5-91 (0B91) RUN	EZ Sleep Minimum Speed	<input type="checkbox"/> V/f <input type="checkbox"/> OLV <input type="checkbox"/> OLV/PM <input type="checkbox"/> AOLV/PM <input type="checkbox"/> EZOLV Sets the output lower limit level for the PID control as Hz units or min ⁻¹ (r/min) units.	0.0 Hz or 0 min ⁻¹ (r/min) (0.0 to 590.0 Hz or 0 to 35400 min ⁻¹ (r/min))

When you use b5-91, set b5-34 = 0.0 [PID Output Lower Limit Level = 0.0 (disabled)].

When you set the lower limit for PID output as a percentage of the Maximum Output Frequency, refer to page [b5-34: PID Output Lower Limit Level on page 191](#).

Note:

The value of b5-90 [EZ Sleep Unit] sets the units. When b5-90 changes, this parameter does not automatically update. Set this parameter again after you change b5-90.

■ b5-92: EZ Sleep Level

No. (Hex.)	Name	Description	Default (Range)
b5-92 (0B92) RUN	EZ Sleep Level	<input type="checkbox"/> V/f <input type="checkbox"/> OLV <input type="checkbox"/> OLV/PM <input type="checkbox"/> AOLV/PM <input type="checkbox"/> EZOLV Sets the value that the output frequency or motor speed must be less than for longer than b5-93 [EZ Sleep Time] to enter Sleep Mode.	0.0 Hz or 0 min ⁻¹ (r/min) (0.0 to 590.0 Hz or 0 to 35400 min ⁻¹ (r/min))

Note:

When b5-90 [EZ Sleep Unit] changes, this parameter does not automatically update. Set this parameter again after you change b5-90.

■ b5-93: EZ Sleep Time

No. (Hex.)	Name	Description	Default (Range)
b5-93 (0B93) RUN	EZ Sleep Time	<input type="checkbox"/> V/f <input type="checkbox"/> OLV <input type="checkbox"/> OLV/PM <input type="checkbox"/> AOLV/PM <input type="checkbox"/> EZOLV Sets the length of time that the output frequency or motor speed must be less than b5-92 [EZ Sleep Level] to enter Sleep Mode.	5.0 s (0.0 - 1000.0 s)

■ b5-94: EZ Sleep Wake-up Level

No. (Hex.)	Name	Description	Default (Range)
b5-94 (0B94) RUN	EZ Sleep Wake-up Level	<div style="display: flex; gap: 5px;"> V/f OLV OLV/PM AOLV/PM EZOLV </div> Sets the level at which the drive resumes operation when exiting Sleep Mode.	0.00% (0.00 - 600.00%)

Note:

The values of *b5-20* [PID Unit Selection], *b5-38* [PID User Unit Display Scaling], and *b5-39* [PID User Unit Display Digits] set the units. When *b5-20*, *b5-38*, and *b5-39* change, this parameter does not automatically update. Set this parameter again after you change *b5-20*, *b5-38*, and *b5-39* are changed.

- When *b5-95* = 0 [EZ Sleep Wake-up Mode = Absolute]:
When *b5-09* = 0 [PID Output Level Selection = Normal Output (Direct Acting)], and the PID Feedback [H3-xx = B] is less than the value of *b5-94* for a time longer than the value of *b5-96* [EZ Sleep Wake-up Time], the drive will exit sleep and start operation again. When *b5-09* = 1 [Reverse Output (Reverse Acting)], and the PID feedback is more than setting value of *b5-94* for a time longer than the setting value of *b5-96*, the drive will exit sleep and start operation again.
- When *b5-95* = 1 [Setpoint Delta]:
When *b5-09* = 0, and the PID feedback is less than the value of "PID setpoint value - *b5-94*" for a time longer than the value of *b5-96*, the drive will exit sleep and start operation again. When *b5-09* = 1, and the PID feedback is more than the value of "PID setpoint value + *b5-94*" for a time longer than the setting value of *b5-96*, the drive will exit sleep and start operation again.

■ b5-95: EZ Sleep Wake-up Mode

No. (Hex.)	Name	Description	Default (Range)
b5-95 (0B95)	EZ Sleep Wake-up Mode	<div style="display: flex; gap: 5px;"> V/f OLV OLV/PM AOLV/PM EZOLV </div> Sets the wake-up mode to use when exiting Sleep Mode.	0 (0, 1)

0 : Absolute

1 : Setpoint Delta

■ b5-96: EZ Sleep Wake-up Time

No. (Hex.)	Name	Description	Default (Range)
b5-96 (0B96) RUN	EZ Sleep Wake-up Time	<div style="display: flex; gap: 5px;"> V/f OLV OLV/PM AOLV/PM EZOLV </div> Sets the EZ Wake-up time.	1.0 s (0.0 - 1000.0 s)

When the PID feedback is less than the value of *b5-94* [EZ Sleep Wake-up Level] continuously for the time set in *b5-96*, the drive will exit sleep and start operation again.

◆ b6: Dwell Function

The Dwell function momentarily holds the output frequency at start and stop.

This prevents motor speed loss when you start and stop heavy loads. The Dwell function is also enabled when backlash on the machine side causes sudden movement at the start of acceleration and deceleration.

At the start of acceleration, the drive uses the output frequency and acceleration time set for the Dwell function to automatically operate at low speed to minimize the effects of backlash. Then, the drive can accelerate again. The Dwell function operates the same for deceleration.

For conveyor applications, the Dwell function also lets the drive interlock the output frequency and a delay time for the holding brake on the load side.

The Dwell function momentarily stops during acceleration to prevent a PM motor from stepping out. [Figure 2.27](#) shows how the Dwell function works.

Note:

When you use the Dwell function at stop, set *b1-03* = 0 [Stopping Method Selection = Ramp to Stop].

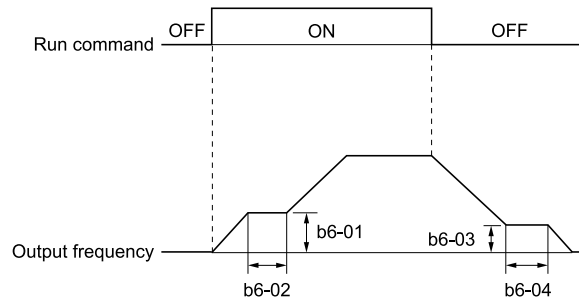

Figure 2.27 Time Chart for the Dwell Function at Start/Stop

■ **b6-01: Dwell Reference at Start**

No. (Hex.)	Name	Description	Default (Range)
b6-01 (01B6)	Dwell Reference at Start	V/f OLV OLV/PM AOLV/PM EZOLV Sets the output frequency that the drive will hold momentarily when the motor starts.	0.0 (Determined by A1-02)

When the drive accelerates to the output frequency set in *b6-01*, it holds that frequency for the time set in *b6-02* [Dwell Time at Start], and starts to accelerate again.

■ **b6-02: Dwell Time at Start**

No. (Hex.)	Name	Description	Default (Range)
b6-02 (01B7)	Dwell Time at Start	V/f OLV OLV/PM AOLV/PM EZOLV Sets the length of time that the drive will hold the output frequency when the motor starts.	0.0 s (0.0 - 10.0 s)

■ **b6-03: Dwell Reference at Stop**

No. (Hex.)	Name	Description	Default (Range)
b6-03 (01B8)	Dwell Reference at Stop	V/f OLV OLV/PM AOLV/PM EZOLV Sets the output frequency that the drive will hold momentarily when ramping to stop the motor.	0.0 (Determined by A1-02)

When the drive decelerates to the output frequency set in *b6-03*, it holds that frequency for the time set in *b6-04* [Dwell Time at Stop] and starts to decelerate again.

■ **b6-04: Dwell Time at Stop**

No. (Hex.)	Name	Description	Default (Range)
b6-04 (01B9)	Dwell Time at Stop	V/f OLV OLV/PM AOLV/PM EZOLV Sets the length of time for the drive to hold the output frequency when ramping to stop the motor.	0.0 s (0.0 - 10.0 s)

◆ **b8: Energy Saving**

Energy-saving control improves overall system operating efficiency by operating the motor at its most efficient level. Set *b8-01* and these parameters according to the control method and the motor.

- When you use V/f Control, set parameters *b8-04* to *b8-06*.
- When you use vector control with an induction motor, set parameters *b8-02* and *b8-03*.
- When you use a PM motor, set parameters *b8-16* and *b8-17*.

Note:

- Energy-saving control is not appropriate for applications with sudden changes in the load, or applications driving heavy loads such as a traverse car application.
- Energy-saving control maximizes operation based on precise motor data set to the drive. Make sure that you do Auto-Tuning and enter the correct information about the motor before you use the Energy-saving control.

■ b8-01: Energy Saving Control Selection

No. (Hex.)	Name	Description	Default (Range)
b8-01 (01CC)	Energy Saving Control Selection	<div style="display: flex; justify-content: space-between; align-items: center;"> V/f OLV OLV/PM AOLV/PM EZOLV </div> Sets the Energy-saving control function.	0 (0 - 2)

0 : Disabled

1 : Enabled

2 : Automatic Optimization

Note:

When $A1-02 = 6$ [Control Method Selection = AOLV/PM], you can only select setting 2 in Expert Mode.

■ b8-02: Energy Saving Gain

No. (Hex.)	Name	Description	Default (Range)
b8-02 (01CD) RUN Expert	Energy Saving Gain	<div style="display: flex; justify-content: space-between; align-items: center;"> V/f OLV OLV/PM AOLV/PM EZOLV </div> Sets the gain for Energy-saving control.	Determined by A1-02 (0.0 - 10.0)

Increase the setting value to increase energy saving. If the setting value is too large, the motor will stall.

■ b8-03: Energy Saving Filter Time

No. (Hex.)	Name	Description	Default (Range)
b8-03 (01CE) RUN Expert	Energy Saving Filter Time	<div style="display: flex; justify-content: space-between; align-items: center;"> V/f OLV OLV/PM AOLV/PM EZOLV </div> Sets the responsiveness for Energy-saving control.	Determined by A1-02 , C6-01 and o2-04 (0.00 - 10.00 s)

Decrease the setting value to increase responsiveness. If the setting value is too low, operation will not be stable.

■ b8-04: Energy Saving Coefficient Value

No. (Hex.)	Name	Description	Default (Range)
b8-04 (01CF) Expert	Energy Saving Coefficient Value	<div style="display: flex; justify-content: space-between; align-items: center;"> V/f OLV OLV/PM AOLV/PM EZOLV </div> Sets the Energy-saving control coefficient to maintain maximum motor efficiency. The default setting is for Yaskawa motors.	Determined by C6-01, E2-11, and o2-04 (0.00 - 655.00)

When you use a motor from a different manufacturer, increase the setting value in 5% increments to find the minimum value for $U1-08$ [Output Power] at light loads.

When you decrease the setting value, it decreases the output voltage and decreases power consumption. If the setting value is too low, the motor will stall.

Note:

When you do Rotational Auto-Tuning, the drive will automatically set the energy-saving coefficient.

■ b8-05: Power Detection Filter Time

No. (Hex.)	Name	Description	Default (Range)
b8-05 (01D0) Expert	Power Detection Filter Time	<div style="display: flex; justify-content: space-between; align-items: center;"> V/f OLV OLV/PM AOLV/PM EZOLV </div> Sets the time constant to measure output power.	20 ms (0 - 2000 ms)

Decrease the setting value to increase responsiveness to load changes. If you set the value too low during operation at light loads, motor speed is not stable.

■ b8-06: Search Operation Voltage Limit

No. (Hex.)	Name	Description	Default (Range)
b8-06 (01D1) Expert	Search Operation Voltage Limit	<div style="display: flex; gap: 5px;"> V/f OLV OLV/PM AOLV/PM EZOLV </div> Sets the voltage limit for Search Operation as a percentage of the motor rated voltage.	0% (0 - 100%)

The Search Operation changes the output voltage in small increments to find a setpoint at which the drive can use minimum power to operate.

Set this parameter to 0 to disable Search Operation. This will not disable Energy-saving control.

If the setting value is too low, the motor will stall when loads suddenly increase.

■ b8-16: PM E-Save Coefficient Ki

No. (Hex.)	Name	Description	Default (Range)
b8-16 (01F8) Expert	PM E-Save Coefficient Ki	<div style="display: flex; gap: 5px;"> V/f OLV OLV/PM AOLV/PM EZOLV </div> Sets torque linearity. This parameter uses the Ki value from the motor nameplate. Usually it is not necessary to change this setting.	1.00 (0.00 - 3.00)

When $b8-16 = 1.00$ (default), the drive will automatically calculate and control the energy-saving coefficient. If the motor nameplate has a description for “Ki”, set this parameter to the Ki value.

Do this procedure to prevent oscillation when you set $b8-01 = 1$ [Energy Saving Control Selection = Enabled].

1. Check U5-21 [Energy Save Coeff Ki] and make sure that it aligns with the Ki value on the motor nameplate.
2. If the numbers are different, set $b8-16$ to the Ki value on the motor nameplate.

■ b8-17: PM E-Save Coefficient Kt

No. (Hex.)	Name	Description	Default (Range)
b8-17 (01F9) Expert	PM E-Save Coefficient Kt	<div style="display: flex; gap: 5px;"> V/f OLV OLV/PM AOLV/PM EZOLV </div> Sets torque linearity. This parameter uses the Kt value from the motor nameplate. Usually it is not necessary to change this setting.	1.00 (0.00 - 3.00)

When $E5-01 = 1xxx$ [PM Motor Code Selection = Yaskawa SSR1 series IPM motor], the drive automatically calculates the energy-saving coefficient Kt and uses that value to control operation.

Do this procedure to prevent oscillation when you set $b8-01 = 1$ [Energy Saving Control Selection = Enabled].

1. Check U5-22 [Energy Save Coeff Kt] and make sure that it aligns with the Kt value on the motor nameplate.
2. If the numbers are different, set $b8-17$ to the Kt value on the motor nameplate.

■ b8-18: E-Save d-axis Current FilterTime

No. (Hex.)	Name	Description	Default (Range)
b8-18 (01FA) Expert	E-Save d-axis Current FilterTime	<div style="display: flex; gap: 5px;"> V/f OLV OLV/PM AOLV/PM EZOLV </div> Sets the d-axis current reference filter time constant.	0.100 s (0.000 - 5.000 s)

■ b8-19: E-Save Search Frequency

No. (Hex.)	Name	Description	Default (Range)
b8-19 (0B40) Expert	E-Save Search Frequency	<div style="display: flex; gap: 5px;"> V/f OLV OLV/PM AOLV/PM EZOLV </div> Sets the frequency of Energy-saving control search operations. Usually it is not necessary to change this setting.	Determined by A1-02 (10 - 300 Hz)

Note:

- If low inertia causes vibration in the machine, increase the setting value in 10 Hz increments and check the response. If $A1-02 = 8$ [Control Method Selection = EZOLV], increase the setting value in 1 Hz increments.
- To make the motor more efficient, decrease the setting value in 1 Hz increments until the point immediately before machine vibration starts to occur.

■ b8-20: E-Save Search Width

No. (Hex.)	Name	Description	Default (Range)
b8-20 (0B41) Expert	E-Save Search Width	<div style="display: flex; justify-content: space-between; align-items: center;"> V/f OLV OLV/PM AOLV/PM EZOLV </div> Sets the amplitude of Energy-saving control search operations.	1.0 degrees (0.1 - 5.0 degrees)

An increase in the value can make the operational efficiency better. However, if the load inertia is small, it may be necessary to adjust the value to prevent machine vibration.

Note:

- If low inertia causes vibration in the machine, decrease the setting value in 1.0-degree increments and check the response.
- To make the motor more efficient, increase the setting value in 1.0-degree increments until the point immediately before machine vibration starts to occur.

■ b8-21: PM E-Save Search Gain

No. (Hex.)	Name	Description	Default (Range)
b8-21 (0B42) Expert	PM E-Save Search Gain	<div style="display: flex; justify-content: space-between; align-items: center;"> V/f OLV OLV/PM AOLV/PM EZOLV </div> Sets the gain of Energy-saving control search operations.	0.3Hz (0.1 - 20.0 Hz)

When you decrease the value of *C5-01* [ASR Proportional Gain 1], also decrease the value of *b8-21* to keep the correct ratio.

■ b8-22: PM E-Save Search LPF Cutoff Freq

No. (Hex.)	Name	Description	Default (Range)
b8-22 (0B43) Expert	PM E-Save Search LPF Cutoff Freq	<div style="display: flex; justify-content: space-between; align-items: center;"> V/f OLV OLV/PM AOLV/PM EZOLV </div> Sets the frequency of the filter used to extract the high-efficiency phase from search operations. Usually it is not necessary to change this setting.	10.0 Hz (1.0 - 30.0 Hz)

■ b8-23: PM E-Save Search Limit

No. (Hex.)	Name	Description	Default (Range)
b8-23 (0B44) Expert	PM E-Save Search Limit	<div style="display: flex; justify-content: space-between; align-items: center;"> V/f OLV OLV/PM AOLV/PM EZOLV </div> Sets the search operations output limit. Usually it is not necessary to change this setting.	15.0 degrees (0.0 - 30.0 degrees)

When the motor characteristics are correct, increase this value to make the motor more efficient.

■ b8-24: PM E-Save High Freq ACR Gain

No. (Hex.)	Name	Description	Default (Range)
b8-24 (0B45) Expert	PM E-Save High Freq ACR Gain	<div style="display: flex; justify-content: space-between; align-items: center;"> V/f OLV OLV/PM AOLV/PM EZOLV </div> Sets the gain for high-frequency current control.	200.0 Hz (100.0 - 1000.0 Hz)

Note:

If the drive detects *oC* [Overcurrent], decrease the value.

■ b8-25: PM E-Save Search Start Level

No. (Hex.)	Name	Description	Default (Range)
b8-25 (0B46) Expert	PM E-Save Search Start Level	<div style="display: flex; justify-content: space-between; align-items: center;"> V/f OLV OLV/PM AOLV/PM EZOLV </div> Sets the start level for search operations.	10.0% (0.0 - 100.0%)

Note:

If there is vibration in the machine, increase the value.

■ b8-26: PM E-Save Power Setpoint

No. (Hex.)	Name	Description	Default (Range)
b8-26 (0B47) Expert	PM E-Save Power Setpoint	<div style="display: flex; justify-content: space-between; align-items: center;"> V/f OLV OLV/PM AOLV/PM EZOLV </div> Sets a value to increase torque accuracy.	0.0% (-10.0 - +10.0%)

■ b8-28: Over Excitation Action Selection

No. (Hex.)	Name	Description	Default (Range)
b8-28 (0B8B) Expert	Over Excitation Action Selection	<div style="display: flex; justify-content: space-between; align-items: center;"> V/f OLV OLV/PM AOLV/PM EZOLV </div> Sets the function for excitation operation.	0 (0, 1)

When operation is not stable at low speeds, set this parameter to 1 to enable the function.

0 : Disabled

1 : Enabled

■ b8-29: Energy Saving Priority Selection

No. (Hex.)	Name	Description	Default (Range)
b8-29 (0B8C)	Energy Saving Priority Selection	<div style="display: flex; justify-content: space-between; align-items: center;"> V/f OLV OLV/PM AOLV/PM EZOLV </div> Sets the priority of drive response between changes to the load or Energy-saving control. Enable this to prioritize energy-saving control. Disable this to prioritize tracking related to fast load changes, and prevent motor stall.	0 (0, 1)

Enable this parameter when there are small changes in the load. It is possible that the motor cannot respond correctly to changes in the load.

0 : Priority: Drive Response

1 : Priority: Energy Savings

2.4 C: Tuning

C parameters adjust drive operation, including:

- Acceleration Time
- Deceleration Time
- Slip Compensation
- Torque Compensation
- Carrier Frequency

◆ C1: Accel & Decel Time

You can set four different acceleration and deceleration time pairs in the drive. When you activate and deactivate H1-xx = 7, 16, 1A [MFDI Function Select = Accel/Decel Time Selection 1, Motor 2 Selection, Accel/Decel Time Selection 2], you can switch acceleration and deceleration times during run.

Acceleration time parameters always set the time to accelerate from 0 Hz to *E1-04* [Maximum Output Frequency]. Deceleration time parameters always set the time to decelerate from *E1-04* to 0 Hz.

C1-01 [Acceleration Time 1] and *C1-02* [Deceleration Time 1] are the default active accel/decel settings.

Parameter	Range
C1-01 [Acceleration Time 1]	0.0 to 6000.0 s
C1-02 [Deceleration Time 1]	
C1-03 [Acceleration Time 2]	
C1-04 [Deceleration Time 2]	
C1-05 [Acceleration Time 3]	
C1-06 [Deceleration Time 3]	
C1-07 [Acceleration Time 4]	
C1-08 [Deceleration Time 4]	

Note:

The setting range for acceleration and deceleration times is 0.00 to 600.00 s when *C1-10* = 0 [Accel/Decel Time Setting Units = 0.01 s (0.00 to 600.00 s)].

■ Use MFDIs to Switch Acceleration Times

Table 2.27 shows the different acceleration and deceleration times.

Table 2.27 Accel/Decel Times and Active Parameters

H1-xx = 7 [Accel/Decel Time Selection 1]	H1-xx = 1A [Accel/Decel Time Selection 2]	Active Parameter	
		Acceleration Time	Deceleration Time
OFF	OFF	C1-01 [Acceleration Time 1]	C1-02 [Deceleration Time 1]
ON	OFF	C1-03 [Acceleration Time 2]	C1-04 [Deceleration Time 2]
OFF	ON	C1-05 [Acceleration Time 3]	C1-06 [Deceleration Time 3]
ON	ON	C1-07 [Acceleration Time 4]	C1-08 [Deceleration Time 4]

Figure 2.28 shows an operation example to change acceleration and deceleration times. It is necessary to set *b1-03* = 0 [Stopping Method Selection = Ramp to Stop] for this example.

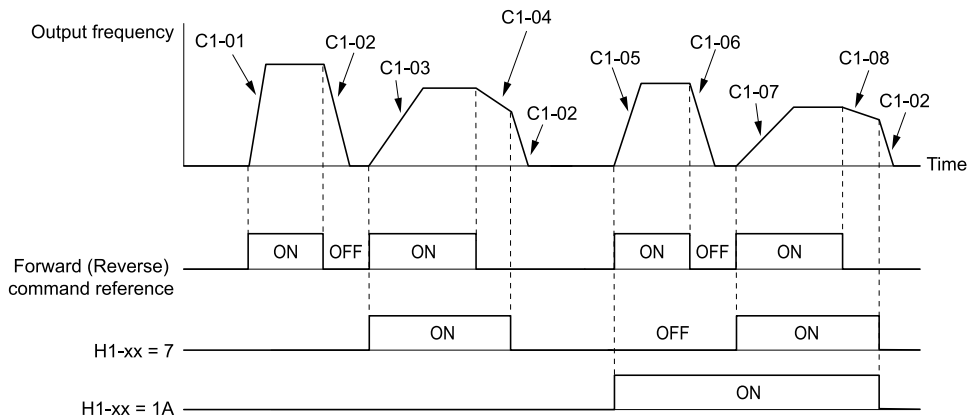

Figure 2.28 Timing Diagram of Acceleration and Deceleration Times

■ Use Motor Selection to Switch Acceleration and Deceleration Times

When you set $H1-xx = 16$ [MFDI Function Selection = Motor 2 Selection], you can activate and deactivate the input terminal to switch between motor 1 and motor 2.

Note:

You cannot use the Motor 2 Selection function with PM motors.

Table 2.28 shows the possible acceleration and deceleration time combinations when you use the Motor 2 Selection function.

Table 2.28 Motor Selection and Acceleration and Deceleration Times

H1-xx = 7 [Accel/Decel Time Selection 1]	H1-xx = 16 [Motor 2 Selection]			
	Motor 2 Selection: OFF		Motor 2 Selection: ON	
	Acceleration Time	Deceleration Time	Acceleration Time	Deceleration Time
OFF	C1-01	C1-02	C1-05	C1-06
ON	C1-03	C1-04	C1-07	C1-08

■ Use Output Frequency Level to Switch Acceleration and Deceleration Times

The drive can use output frequency to automatically switch between different acceleration and deceleration times. When the output frequency = $C1-11$ [Accel/Decel Time Switchover Freq], the drive automatically switches the acceleration and deceleration times. Set $C1-11 = 0.0$ Hz to disable this function.

Note:

- Acceleration and deceleration times set to MFDIs are more important than the automatic switch using the frequency level set in $C1-11$. For example, if you set the switchover frequency to $C1-11$, the drive will not automatically switch acceleration and deceleration times when the MFDI terminal set for Accel/Decel Time Selection 1 [$H1-xx = 7$] is activated.
- If Motor 2 Selection [$H1-xx = 16$] is activated, the drive will set the acceleration/deceleration time to $C1-05$ and $C1-06$ for motor 2 when the output frequency is more than the frequency level set in $C1-11$.

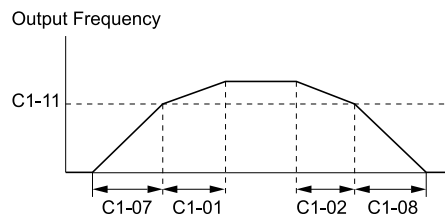

When the output frequency $\geq C1-11$, drive uses Accel/Decel Time 1 (C1-01, C1-02)
 When the output frequency $< C1-11$, drive uses Accel/Decel Time 4 (C1-07, C1-08)

Figure 2.29 Accel/Decel Time Switching Frequency

■ C1-01: Acceleration Time 1

No. (Hex.)	Name	Description	Default (Range)
C1-01 (0200) RUN	Acceleration Time 1	V/f OLV OLV/PM AOLV/PM EZOLV Sets the length of time to accelerate from zero to maximum output frequency.	10.0 s (0.0 - 6000.0 s)

Note:

When $C1-10 = 0$ [Accel/Decel Time Setting Units = 0.01 s (0.00 to 600.00 s)], the setting range is 0.00 to 600.00 s.

■ C1-02: Deceleration Time 1

No. (Hex.)	Name	Description	Default (Range)
C1-02 (0201) RUN	Deceleration Time 1	V/f OLV OLV/PM AOLV/PM EZOLV Sets the length of time to decelerate from maximum output frequency to zero.	10.0 s (0.0 - 6000.0 s)

Note:

When $C1-10 = 0$ [Accel/Decel Time Setting Units = 0.01 s (0.00 to 600.00 s)], the setting range is 0.00 to 600.00 s.

■ C1-03: Acceleration Time 2

No. (Hex.)	Name	Description	Default (Range)
C1-03 (0202) RUN	Acceleration Time 2	V/f OLV OLV/PM AOLV/PM EZOLV Sets the length of time to accelerate from zero to maximum output frequency.	10.0 s (0.0 - 6000.0 s)

Note:

When $C1-10 = 0$ [Accel/Decel Time Setting Units = 0.01 s (0.00 to 600.00 s)], the setting range is 0.00 to 600.00 s.

■ C1-04: Deceleration Time 2

No. (Hex.)	Name	Description	Default (Range)
C1-04 (0203) RUN	Deceleration Time 2	V/f OLV OLV/PM AOLV/PM EZOLV Sets the length of time to decelerate from maximum output frequency to zero.	10.0 s (0.0 - 6000.0 s)

Note:

When $C1-10 = 0$ [Accel/Decel Time Setting Units = 0.01 s (0.00 to 600.00 s)], the setting range is 0.00 to 600.00 s.

■ C1-05: Acceleration Time 3

No. (Hex.)	Name	Description	Default (Range)
C1-05 (0204) RUN	Acceleration Time 3	V/f OLV OLV/PM AOLV/PM EZOLV Sets the length of time to accelerate from zero to maximum output frequency.	10.0 s (0.0 - 6000.0 s)

Note:

When $C1-10 = 0$ [Accel/Decel Time Setting Units = 0.01 s (0.00 to 600.00 s)], the setting range is 0.00 to 600.00 s.

■ C1-06: Deceleration Time 3

No. (Hex.)	Name	Description	Default (Range)
C1-06 (0205) RUN	Deceleration Time 3	V/f OLV OLV/PM AOLV/PM EZOLV Sets the length of time to decelerate from maximum output frequency to zero.	10.0 s (0.0 - 6000.0 s)

Note:

When $C1-10 = 0$ [Accel/Decel Time Setting Units = 0.01 s (0.00 to 600.00 s)], the setting range is 0.00 to 600.00 s.

■ C1-07: Acceleration Time 4

No. (Hex.)	Name	Description	Default (Range)
C1-07 (0206) RUN	Acceleration Time 4	<div style="display: flex; gap: 5px;"> V/f OLV OLV/PM AOLV/PM EZOLV </div> Sets the length of time to accelerate from zero to maximum output frequency.	10.0 s (0.0 - 6000.0 s)

Note:

When $C1-10 = 0$ [Accel/Decel Time Setting Units = 0.01 s (0.00 to 600.00 s)], the setting range is 0.00 to 600.00 s.

■ C1-08: Deceleration Time 4

No. (Hex.)	Name	Description	Default (Range)
C1-08 (0207) RUN	Deceleration Time 4	<div style="display: flex; gap: 5px;"> V/f OLV OLV/PM AOLV/PM EZOLV </div> Sets the length of time to decelerate from maximum output frequency to zero.	10.0 s (0.0 - 6000.0 s)

Note:

When $C1-10 = 0$ [Accel/Decel Time Setting Units = 0.01 s (0.00 to 600.00 s)], the setting range is 0.00 to 600.00 s.

■ C1-09: Fast Stop Time

No. (Hex.)	Name	Description	Default (Range)
C1-09 (0208) RUN	Fast Stop Time	<div style="display: flex; gap: 5px;"> V/f OLV OLV/PM AOLV/PM EZOLV </div> Sets the length of time that the drive will decelerate to zero for a Fast Stop.	10.0 s (0.0 - 6000.0 s)

Note:

- When $C1-10 = 0$ [Accel/Decel Time Setting Units = 0.01 s (0.00 to 600.00 s)], the setting range is 0.00 to 600.00 s.
- When $L2-29 = 0$ [Kinetic Energy Backup Method = Single Drive KEB Ride-Thru 1] and you do KEB Auto-Tuning, the drive will automatically set $C1-09$. If you must not change the Fast Stop time, do not do KEB Auto-Tuning.

The Fast Stop function will be triggered in the following circumstances.

- The Fast Stop operation will be triggered by the input of the Fast Stop command via the multi-function digital input terminal.
- The Fast Stop operation is will be triggered when by the input of the Fast Stop command is input via the multi-function digital input terminal.

Set $H1-xx = 15, 17$ [MFDI Function Select = Fast Stop (N.O.), Fast Stop (N.C.)].

When the Fast Stop command is input, the Fast Stop operation will be triggered at the deceleration time set to $C1-09$. The drive cannot be restarted after initiating a Fast Stop operation until deceleration is complete. Complete deceleration and cycle the Run command to clear the Fast Stop input.

The terminal set for $H2-xx = 4C$ [MFDO Function Select = During Fast Stop] will be ON during Fast Stop.

Note:

Decelerating too quickly can cause an *ov* [Overvoltage] fault that shuts off the drive while the motor to coasts to a stop. Set a Fast Stop time in $C1-09$ that prevents motor coasting and makes sure that the motor stops quickly and safely.

■ C1-10: Accel/Decel Time Setting Units

No. (Hex.)	Name	Description	Default (Range)
C1-10 (0209)	Accel/Decel Time Setting Units	<div style="display: flex; gap: 5px;"> V/f OLV OLV/PM AOLV/PM EZOLV </div> Sets the setting units for $C1-01$ to $C1-08$ [Accel/Decel Times 1 to 4], $C1-09$ [Fast Stop Time], $L2-06$ [Kinetic Energy Backup Decel Time], and $L2-07$ [Kinetic Energy Backup Accel Time].	1 (0, 1)

0 : 0.01 s (0.00 to 600.00 s)

Sets acceleration and deceleration times in 0.01 s units. The setting range is 0.0 to 6000.0 s.

If one of these parameters is set to 1000.0 s or longer, you cannot set $C1-10 = 0$:

- $C1-01$ to $C1-09$

- L2-06
- L2-07

When one of those parameters is set to a value between 600.1 s and 1000.0 s, you can set $C1-10 = 0$, but the time will change to 600.00 s.

1 : 0.1 s (0.0 to 6000.0 s)

Sets acceleration and deceleration times in 0.1 s units. The setting range is 0.0 to 6000.0 s.

■ C1-11: Accel/Decel Time Switchover Freq

No. (Hex.)	Name	Description	Default (Range)
C1-11 (020A)	Accel/Decel Time Switching Frequency	V/f OLV OLV/PM AOLV/PM EZOLV Sets the frequency at which the drive will automatically change acceleration and deceleration times.	Determined by A1-02 (0.0 - 590.0 Hz)

When the output frequency is at the $C1-11$ value, the drive automatically switches the acceleration and deceleration times. Set this parameter to 0.0 to disable this function.

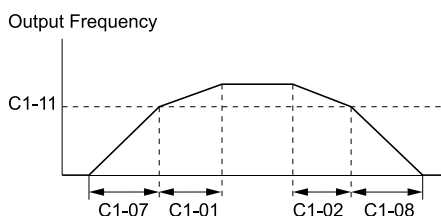

When the output frequency $\geq C1-11$, drive uses Accel/Decel Time 1 (C1-01, C1-02)
When the output frequency $< C1-11$, drive uses Accel/Decel Time 4 (C1-07, C1-08)

Figure 2.30 Accel/Decel Time Switchover Freq

Table 2.29 lists the possible combinations of acceleration and deceleration time switchover frequencies and the acceleration times for the Motor 2 Selection function.

Table 2.29 Motor and Acceleration and Deceleration Time Combination

C1-11	Motor 1		Motor 2	
	Acceleration Time	Deceleration Time	Acceleration Time	Deceleration Time
Less than the setting value	C1-07 [Acceleration Time 4]	C1-08 [Deceleration Time 4]	C1-07 [Acceleration Time 4]	C1-08 [Deceleration Time 4]
Equal to or more than the setting value	C1-01 [Acceleration Time 1]	C1-02 [Deceleration Time 1]	C1-05 [Acceleration Time 3]	C1-06 [Deceleration Time 3]

■ C1-14: Accel/Decel Rate Frequency

No. (Hex.)	Name	Description	Default (Range)
C1-14 (0264) RUN	Accel/Decel Rate Frequency	V/f OLV OLV/PM AOLV/PM EZOLV Sets the base frequency used to calculate acceleration and deceleration rates.	0.0 Hz (0.0 - 590.0 Hz)

The acceleration and deceleration rates set in $C1-01$ to $C1-09$ [Acceleration/Deceleration Times 1 to 4, Fast Stop Time] will change when the value of $C1-14$ changes.

- When $C1-14 = 0.0$ Hz
 - $C1-01$, $C1-03$, $C1-05$, $C1-07$ [Acceleration Times 1 to 4]: Time to accelerate from 0 Hz to $E1-04$ [Maximum Output Frequency]
 - $C1-02$, $C1-04$, $C1-06$, $C1-08$ [Deceleration Times 1 to 4], $C1-09$ [Fast Stop Time]: Time to decelerate from $E1-04$ to 0 Hz.

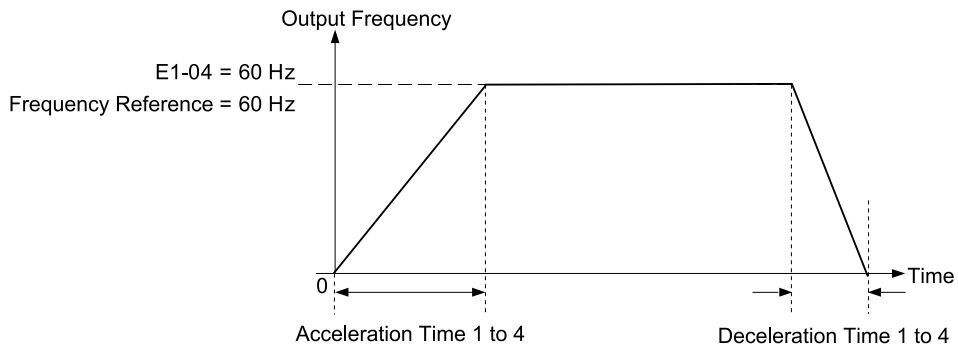

Figure 2.31 Example 1: Acceleration/Deceleration Rate (When C1-14 = 0 Hz, E1-04 = 60 Hz, and the Frequency Reference is 60 Hz)

- When $C1-14 \neq 0.0$ Hz
 - C1-01, C1-03, C1-05, C1-07: Time to accelerate from 0 Hz to C1-14
 - C1-02, C1-04, C1-06, C1-08, C1-09: Time to decelerate from C1-14 to 0 Hz

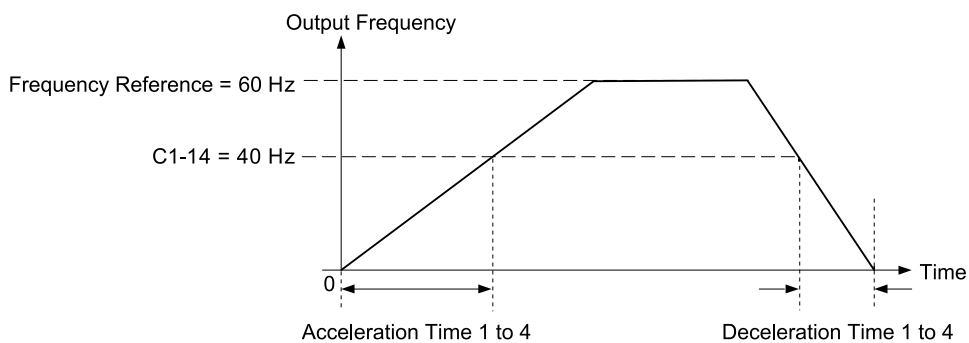

Figure 2.32 Example 2: Acceleration/Deceleration Rate (When C1-14 = 40 Hz, E1-04 = 60 Hz, and the Frequency Reference is 60 Hz)

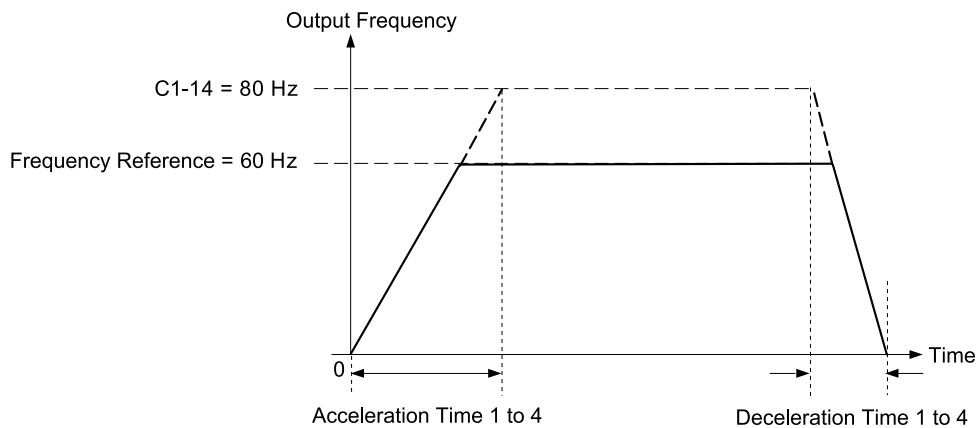

Figure 2.33 Example 3: Acceleration/Deceleration Rate (When C1-14 = 80 Hz, E1-04 = 60 Hz, and the Frequency Reference is 60 Hz)

Note:

- Figure 2.31 to Figure 2.33 show the accel/decel times when C2-01 to C2-04 [S-Curve Times @ Start/End of Accel/Decel] = 0.00 s.
- When L3-01 $\neq 0$ [Stall Prevention during Accel \neq Disabled], Stall Prevention could cause the acceleration time to be longer than the set value.
- When L3-04 $\neq 0$ [Stall Prevention during Decel \neq Disabled], Stall Prevention could cause the deceleration time to be longer than the set value.

◆ C2: S-Curve Characteristics

Use S-curve characteristics to smooth acceleration and deceleration and to minimize abrupt shock to the load. Set S-curve characteristic time during acceleration/deceleration at start and acceleration/deceleration at stop. The following figure explains how S-curves are applied.

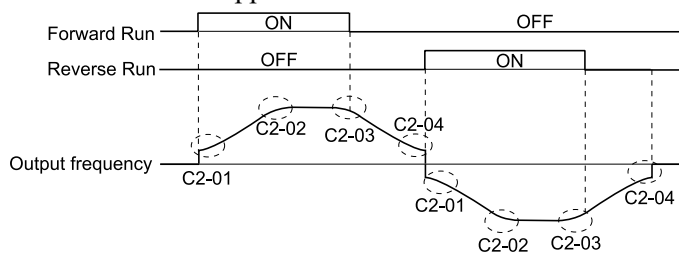

Figure 2.34 S-Curve Timing Diagram - Forward/Reverse Operation

Note:

- If *STPo* [Motor Step-Out Detected] occurs when starting a PM motor, try increasing the value set to *C2-01*.
- Setting the S-curve will increase the acceleration and deceleration times.

$$\text{Acceleration time} = \text{Selected acceleration time} + \frac{C2-01 + C2-02}{2}$$

$$\text{Deceleration time} = \text{Selected deceleration time} + \frac{C2-03 + C2-04}{2}$$

■ C2-01: S-Curve Time @ Start of Accel

No. (Hex.)	Name	Description	Default (Range)
C2-01 (020B)	S-Curve Time @ Start of Accel	<input type="checkbox"/> V/f <input type="checkbox"/> OLV <input type="checkbox"/> OLV/PM <input type="checkbox"/> AOLV/PM <input type="checkbox"/> EZOLV Sets the S-curve acceleration time at start.	Determined by A1-02 (0.00 - 10.00 s)

■ C2-02: S-Curve Time @ End of Accel

No. (Hex.)	Name	Description	Default (Range)
C2-02 (020C)	S-Curve Time @ End of Accel	<input type="checkbox"/> V/f <input type="checkbox"/> OLV <input type="checkbox"/> OLV/PM <input type="checkbox"/> AOLV/PM <input type="checkbox"/> EZOLV Sets the S-curve acceleration time at completion.	0.20 s (0.00 - 10.00 s)

■ C2-03: S-Curve Time @ Start of Decel

No. (Hex.)	Name	Description	Default (Range)
C2-03 (020D)	S-Curve Time @ Start of Decel	<input type="checkbox"/> V/f <input type="checkbox"/> OLV <input type="checkbox"/> OLV/PM <input type="checkbox"/> AOLV/PM <input type="checkbox"/> EZOLV Sets the S-curve deceleration time at start.	0.20 s (0.00 - 10.00 s)

■ C2-04: S-Curve Time @ End of Decel

No. (Hex.)	Name	Description	Default (Range)
C2-04 (020E)	S-Curve Time @ End of Decel	<input type="checkbox"/> V/f <input type="checkbox"/> OLV <input type="checkbox"/> OLV/PM <input type="checkbox"/> AOLV/PM <input type="checkbox"/> EZOLV Sets the S-curve deceleration time at completion.	0.00 s (0.00 - 10.00 s)

◆ C3: Slip Compensation

The Slip Compensation function improves the speed accuracy of an induction motor. As loads on induction motors increase, motor slip increases and motor speed decreases. By adjusting the output frequency in accordance with the motor load, it compensates the slip and makes the motor speed equal to the frequency reference.

■ C3-01: Slip Compensation Gain

No. (Hex.)	Name	Description	Default (Range)
C3-01 (020F) RUN	Slip Compensation Gain	<div style="display: flex; gap: 5px;"> V/f OLV OLV/PM AOLV/PM EZOLV </div> Sets the gain for the slip compensation function. Usually it is not necessary to change this setting.	Determined by A1-02 (0.0 - 2.5)

Note:

Correctly set these parameters before changing the slip compensation gain:

- E2-01 [Motor Rated Current (FLA)]
- E2-02 [Motor Rated Slip]
- E2-03 [Motor No-Load Current]

Adjust this parameter as follows if necessary:

- If the motor speed is slower than the frequency reference, increase this parameter in 0.1-unit increments.
- If the motor speed is slower than the frequency reference value, decrease this parameter value in 0.1-unit increments.

■ C3-02: Slip Compensation Delay Time

No. (Hex.)	Name	Description	Default (Range)
C3-02 (0210) RUN	Slip Compensation Delay Time	<div style="display: flex; gap: 5px;"> V/f OLV OLV/PM AOLV/PM EZOLV </div> Sets the slip compensation delay time when speed is unstable or when the slip compensation response is too slow. Usually it is not necessary to change this setting.	Determined by A1-02 (0 - 10000 ms)

Use these settings to adjust this parameter as necessary:

- When the speed is not stable, increase the setting.
- When the slip compensation response is too slow, decrease the setting.

■ C3-03: Slip Compensation Limit

No. (Hex.)	Name	Description	Default (Range)
C3-03 (0211)	Slip Compensation Limit	<div style="display: flex; gap: 5px;"> V/f OLV OLV/PM AOLV/PM EZOLV </div> Sets the upper limit for the slip compensation function as a percentage of the motor rated slip.	200% (0 - 250%)

If you increase the value of C3-01 [Slip Compensation Gain] and the motor speed is slow, use this parameter. The drive uses this parameter when the slip is at the upper limit of slip compensation. Make sure that you measure the motor speed when you increase this parameter value. Set this parameter to make the frequency reference and the slip compensation limit less than the permitted range of the machine.

The slip compensation limit is constant in the constant torque range (frequency reference \leq E1-06 [Base Frequency]). In the constant output range where the frequency reference $>$ E1-06, the slip compensation limit increases with the C3-03 value and the output frequency as shown in Figure 2.35.

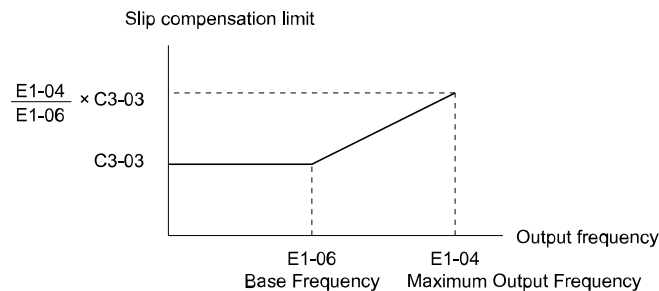

Figure 2.35 Slip Compensation Limit

■ C3-04: Slip Compensation at Regen

No. (Hex.)	Name	Description	Default (Range)
C3-04 (0212)	Slip Compensation at Regen	<div style="display: flex; justify-content: space-between; align-items: center;"> V/f OLV OLV/PM AOLV/PM EZOLV </div> Sets the slip compensation function during regeneration.	0 (0 - 2)

If you apply a regenerative load when the slip compensation function during regeneration is active, the quantity of regeneration can increase immediately. In this condition, it is necessary to use a dynamic braking option (braking resistor or braking resistor unit).

0 : Disabled

The drive will not do Slip compensation during regeneration.

The load and operation status (regenerative operation) can cause the motor speed to be higher or lower than the frequency reference.

1 : Enabled Above 6Hz

Slip compensation function is enabled during regeneration. Slip compensation is disabled at output frequencies of 6 Hz or less.

2 : Enabled Above Defined Range

The drive uses *E2-02 [Motor Rated Slip]* to automatically calculate the frequency range where it will disable slip compensation function during regenerative operation.

Slip compensation is enabled at frequencies as low as 2 Hz.

■ C3-05: Output Voltage Limit Selection

No. (Hex.)	Name	Description	Default (Range)
C3-05 (0213)	Output Voltage Limit Selection	<div style="display: flex; justify-content: space-between; align-items: center;"> V/f OLV OLV/PM AOLV/PM EZOLV </div> Sets the automatic reduction of motor magnetic flux when the output voltage is saturated.	0 (0, 1)

The drive will decrease flux and increase current to compensate torque when voltage is saturated. Make sure that the drive has sufficient output current capacity before you enable this parameter. When this parameter = 1 [Enabled], the output current will increase by 10% at a maximum (at rated load) before it is enabled.

Enable this parameter to increase speed precision when you move heavy loads at high speeds in these conditions:

- Power supply voltage is low
- Motor rated voltage is high

Do not enable this parameter in these conditions:

- Operating a motor in the middle speed range or low speed range
- Power supply voltage is a minimum of 10% more than the motor rated voltage

When you enable this parameter, if the power supply voltage is much less than the motor rated voltage, torque control will not be accurate.

0 : Disabled

1 : Enabled

■ C3-16: Vout Modulation Limit Start Lvl

No. (Hex.)	Name	Description	Default (Range)
C3-16 (0261) Expert	Vout Modulation Limit Start Lvl	<div style="display: flex; justify-content: space-between; align-items: center;"> V/f OLV OLV/PM AOLV/PM EZOLV </div> Sets the modulation factor that starts the output voltage limit operation when <i>C3-05 = 1 [Output Voltage Limit Selection = Enabled]</i> .	90.0% (70.0 - 90.0%)

■ C3-17: Vout Modulation Limit Max Level

No. (Hex.)	Name	Description	Default (Range)
C3-17 (0262) Expert	Vout Modulation Limit Max Level	<div style="display: flex; justify-content: space-between; align-items: center;"> V/f OLV OLV/PM AOLV/PM EZOLV </div> Sets the modulation factor used with C3-18 [Output Voltage Limit Level] for the output voltage limit operation when C3-05 = 1 [Output Voltage Limit Selection = Enabled].	100.0% (85.0 - 100.0%)

■ C3-18: Output Voltage Limit Level

No. (Hex.)	Name	Description	Default (Range)
C3-18 (0263) Expert	Output Voltage Limit Level	<div style="display: flex; justify-content: space-between; align-items: center;"> V/f OLV OLV/PM AOLV/PM EZOLV </div> Sets the maximum drop width of the voltage reference when C3-05 = 1 [Output Voltage Limit Selection = Enabled].	90.0% (50.0 - 100.0%)

■ C3-21: Motor 2 Slip Compensation Gain

No. (Hex.)	Name	Description	Default (Range)
C3-21 (033E) RUN	Motor 2 Slip Compensation Gain	<div style="display: flex; justify-content: space-between; align-items: center;"> V/f OLV OLV/PM AOLV/PM EZOLV </div> Sets the gain for the motor 2 slip compensation function. Usually it is not necessary to change this setting.	Determined by E3-01 (0.0 - 2.5)

Note:

Correctly set these parameters before you change the slip compensation gain:

- E4-01 [Motor 2 Rated Current]
- E4-02 [Motor 2 Rated Slip]
- E4-03 [Motor 2 Rated No-Load Current]

Adjust this parameter as follows if necessary:

- If the motor speed is slower than the frequency reference, increase C3-01 in 0.1-unit increments.
- If the motor speed is faster than the frequency reference, decrease C3-01 in 0.1-unit increments.

■ C3-22: Motor 2 Slip Comp Delay Time

No. (Hex.)	Name	Description	Default (Range)
C3-22 (0241) RUN	Motor 2 Slip Comp Delay Time	<div style="display: flex; justify-content: space-between; align-items: center;"> V/f OLV OLV/PM AOLV/PM EZOLV </div> Sets the slip compensation delay time for motor 2 when speed is unstable or when the slip compensation response is too slow. Usually it is not necessary to change this setting.	Determined by E3-01 (0 - 10000 ms)

Use these settings to adjust this parameter as necessary:

- When the speed is not stable, increase the setting.
- When the slip compensation response is too slow, decrease the setting.

■ C3-23: Motor 2 Slip Compensation Limit

No. (Hex.)	Name	Description	Default (Range)
C3-23 (0242)	Motor 2 Slip Compensation Limit	<div style="display: flex; justify-content: space-between; align-items: center;"> V/f OLV OLV/PM AOLV/PM EZOLV </div> Sets the upper limit for the slip compensation function as a percentage of the motor 2 rated slip.	200% (0 - 250%)

If you increase the value of C3-21 [Motor 2 Slip Compensation Gain] and the motor speed is slow, use this parameter. The drive uses this parameter when the slip is at the upper limit of slip compensation. Make sure that you measure the motor speed when you increase this parameter value. Set this parameter to make the frequency reference and the slip compensation limit less than the permitted range of the machine.

The slip compensation limit is constant in the constant torque range (frequency reference \leq E3-06 [Motor 2 Base Frequency]). In the constant power range where the frequency reference $>$ E3-06, the slip compensation limit increases with the C3-23 value and the output frequency as shown in Figure 2.36.

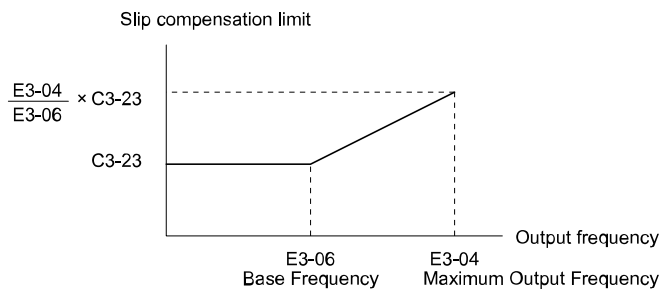

Figure 2.36 Motor 2 Slip Compensation Limit

■ C3-24: Motor 2 Slip Comp during Regen

No. (Hex.)	Name	Description	Default (Range)
C3-24 (0243)	Motor 2 Slip Comp during Regen	<input type="radio"/> V/f <input type="radio"/> OLV <input type="radio"/> OLV/PM <input type="radio"/> AOLV/PM <input type="radio"/> EZOLV Sets the slip compensation during regenerative operation function for motor 2.	0 (0 - 2)

If you apply a regenerative load when the slip compensation function during regeneration is active, the quantity of regeneration can increase immediately. In this condition, it is necessary to use a dynamic braking option (braking resistor or braking resistor unit).

0 : Disabled

The drive will not do Slip compensation during regeneration.

The load and operation status (regenerative operation) can cause the motor speed to be higher or lower than the frequency reference.

1 : Enabled Above 6Hz

Slip compensation function is enabled during regeneration. Slip compensation is disabled at output frequencies of 6 Hz or less.

2 : Enabled Above Defined Range

The drive uses *E2-02 [Motor Rated Slip]* to automatically calculate the frequency range where it will disable slip compensation function during regenerative operation.

Slip compensation is enabled at frequencies as low as 2 Hz.

■ C3-29: Slip Compensation Gain @ Low Spd

No. (Hex.)	Name	Description	Default (Range)
C3-29 (1B5D) Expert	Slip Compensation Gain @ Low Spd	<input type="radio"/> V/f <input type="radio"/> OLV <input type="radio"/> OLV/PM <input type="radio"/> AOLV/PM <input type="radio"/> EZOLV Sets the gain for the slip compensation function in the low speed range. Usually it is not necessary to change this setting.	0.0 (0.0 - 2.5)

Adjust this parameter as follows if necessary:

- If the motor speed is slower than the frequency reference, increase the setting value in 0.1 unit increments.
- If the motor speed is faster than the frequency reference, decrease the setting value in 0.1 unit increments.

◆ C4: Torque Compensation

Torque compensation is a function that increases voltage to increase output torque as compensation for insufficient torque production at start-up or low-speed operation.

Voltage drops due to motor winding resistance cause torque generating voltage to decrease, which causes insufficient torque. If the main circuit cable connecting the drive and motor is long, this can also cause insufficient torque due to voltage drops.

Note:

Set the motor parameters and V/f pattern properly before setting *C4 parameters*.

■ C4-01: Torque Compensation Gain

No. (Hex.)	Name	Description	Default (Range)
C4-01 (0215) RUN	Torque Compensation Gain	<div style="display: flex; justify-content: space-between; align-items: center;"> V/f OLV OLV/PM AOLV/PM EZOLV </div> Sets the gain for the torque compensation function. Use this parameter value for motor 1 when operating multiple motors.	Determined by A1-02 (0.00 - 2.50)

For these control methods and states, adjust the setting value.

A1-02 [Control Method Selection]	Status	Adjustment
0 [V/f Control] 8 [EZ Vector Control]	Torque is not sufficient during low-speed operation of 10 Hz or less.	Increase the setting in 0.05-unit increments.
	There is vibration in the motor or the motor hunts when operating the drive with a light load.	Decrease the setting in 0.05-unit decrements.
	The cable length between the drive and motor is too long.	Increase the setting in 0.05-unit increments.

Note:

- Adjust *C4-01* to make sure that output current is not more than the drive rated current while the drive operates at low speed.
- When *A1-02* = 2 [*Open Loop Vector*], do not change this parameter under normal conditions. Torque accuracy will decrease.
- When *A1-02* = 5 [*PM Open Loop Vector*], do not change this parameter under normal conditions. Setting this value too high can cause overcompensation and motor oscillation.
- When *A1-02* = 8 [*EZ Vector Control*], you cannot change this parameter during drive run.

■ C4-02: Torque Compensation Delay Time

No. (Hex.)	Name	Description	Default (Range)
C4-02 (0216) RUN	Torque Compensation Delay Time	<div style="display: flex; justify-content: space-between; align-items: center;"> V/f OLV OLV/PM AOLV/PM EZOLV </div> Sets the torque compensation delay time. Usually it is not necessary to change this setting.	Determined by A1-02 (0 - 60000 ms)

Note:

When *A1-02* = 5, 8 [*Control Method Selection* = *OLV/PM*, *EZOLV*], you cannot change the setting while the drive is running.

Set this parameter in these conditions:

- If there is vibration in the motor, increase the setting.
- If the motor speed or motor torque response is too slow, decrease the setting.

■ C4-03: Torque Compensation @ FWD Start

No. (Hex.)	Name	Description	Default (Range)
C4-03 (0217)	Torque Compensation @ FWD Start	<div style="display: flex; justify-content: space-between; align-items: center;"> V/f OLV OLV/PM AOLV/PM EZOLV </div> Set the amount of torque reference for forward start as a percentage of the motor rated torque.	0.0% (0.0 - 200.0%)

The torque compensation function is performed using the time constant set in *C4-05* [*Torque Compensation Time*]. This is available only when you start the motor with the forward command. Set this parameter to 0.0 to disable this function.

■ C4-04: Torque Compensation @ REV Start

No. (Hex.)	Name	Description	Default (Range)
C4-04 (0218)	Torque Compensation @ REV Start	<div style="display: flex; justify-content: space-between; align-items: center;"> V/f OLV OLV/PM AOLV/PM EZOLV </div> Sets the amount of torque reference for reverse start as a percentage of the motor rated torque.	0.0% (-200.0 - 0.0%)

The drive uses the time constant set in *C4-05* [*Torque Compensation Time*] to do the torque compensation function. This is available only when you start the motor with the reverse Run command.

■ C4-05: Torque Compensation Time

No. (Hex.)	Name	Description	Default (Range)
C4-05 (0219)	Torque Compensation Time	<div style="display: flex; justify-content: space-between; align-items: center;"> V/f OLV OLV/PM AOLV/PM EZOLV </div> Sets the starting torque constant to use with C4-03 and C4-04 [Torque Compensation @ FWD/REV Start].	10 ms (0 - 200 ms)

■ C4-06: Motor 2 Torque Comp Delay Time

No. (Hex.)	Name	Description	Default (Range)
C4-06 (021A)	Motor 2 Torque Comp Delay Time	<div style="display: flex; justify-content: space-between; align-items: center;"> V/f OLV OLV/PM AOLV/PM EZOLV </div> Sets the value if <i>ov</i> [Overvoltage] occurs with sudden changes in the load, at the end of acceleration, or at the start of deceleration.	150 ms (0 - 10000 ms)

Sets the time constant used during Speed Search or during regenerative operation when *ov* occurs.

Adjust this parameter in the following circumstances.

- Gradually reduce the setting in 10 ms increments and check the performance to improve motor torque speed response when *ov* occurs.

Note:

- Ensure that $C4-06 \geq C4-02$ [Torque Compensation Delay Time].
- Increase the setting value of $n2-03$ [Automatic Freq Regulator Time 2] proportional to C4-06.

■ C4-07: Motor 2 Torque Compensation Gain

No. (Hex.)	Name	Description	Default (Range)
C4-07 (0341) RUN	Motor 2 Torque Compensation Gain	<div style="display: flex; justify-content: space-between; align-items: center;"> V/f OLV OLV/PM AOLV/PM EZOLV </div> Sets the gain for motor 2 torque compensation function when using the Motor Switch function.	1.00 (0.00 - 2.50)

In V/f Control, adjust the value in 0.05-unit increments for these conditions:

- When torque is not sufficient during low-speed operation of 10 Hz or less, increase the setting value
- When there is vibration in the motor or when the motor hunts when operating the drive with a light load, decrease the setting value
- When you use a long motor cable, increase the setting value.

Note:

- Adjust C4-07 to make sure that the output current is not more than the drive rated current during low-speed operation.
- When $A1-02 = 2$ [Control Method Selection = OLV], usually it is not necessary to change the setting. Torque accuracy will decrease.

■ C4-23: Current Control Gain

No. (Hex.)	Name	Description	Default (Range)
C4-23 (1583) Expert	Current Control Gain	<div style="display: flex; justify-content: space-between; align-items: center;"> V/f OLV OLV/PM AOLV/PM EZOLV </div> Sets the Current control gain. Usually it is not necessary to change this parameter.	1.00 (0.50 - 2.50)

◆ C5: Auto Speed Regulator (ASR)

The ASR adjusts the torque reference to decrease the difference between frequency reference and motor speed.

A1-02 [Control Method Selection]	Targets of Adjustment
<ul style="list-style-type: none"> • 6: PM Advanced Open Loop Vector (AOLV/PM) • 8: EZ Vector Control (EZOLV) 	Torque Reference

Figure 2.37 is a speed control block diagram of each control method.

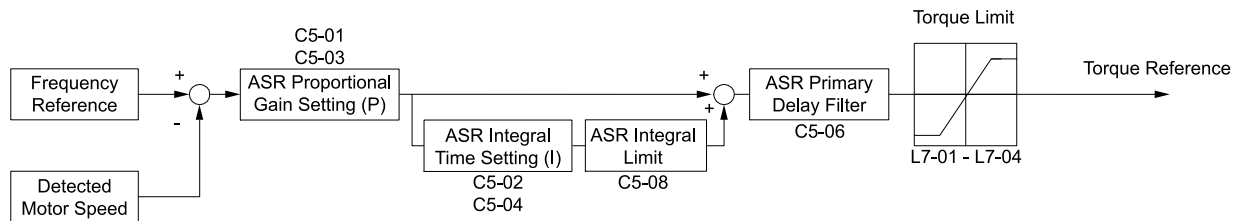

Figure 2.37 Speed Control Block Diagram for AOLV/PM and EZOLV

Note:

The detected speed is the speed estimation value when configured such that $A1-02 = 6$ or 8 [Control Method Selection = AOLV/PM or EZOLV].

■ Before You Adjust ASR Parameters

- Do Auto-Tuning and set up all motor data correctly.
- Always make adjustments with the load connected to the motor.
- Use analog output signals to monitor $U1-16$ [SFS Output Frequency] and $U1-05$ [Motor Speed] when you adjust the ASR.

■ ASR Adjustment Procedure for AOLV/PM and EZOLV

Do this procedure to adjust ASR parameters:

1. Run the motor at zero speed or low speed and increase $C5-01$ [ASR Proportional Gain 1] until immediately before vibration starts to occur.
2. Run the motor at zero speed or low speed and decrease $C5-02$ [ASR Integral Time 1] until immediately before vibration starts to occur.
3. Check for oscillation when you run the motor at maximum speed.
4. If oscillation occurs, increase $C5-02$ and decrease $C5-01$.
When there is no oscillation, the adjustment procedure is complete.
5. Set the low-speed gain. Run the motor at zero speed or low speed and increase $C5-03$ [ASR Proportional Gain 2] until immediately before vibration starts to occur.

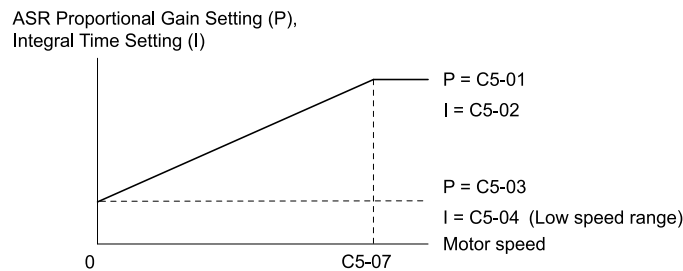

Figure 2.38 Low-speed/High-speed Gain Settings

6. Set the low-speed integral time. Run the motor at zero speed or low speed and decrease $C5-04$ [ASR Integral Time 2] until immediately before vibration starts to occur.
7. Set $C5-07$ [ASR Gain Switchover Frequency].
8. Check for oscillation when you run the motor at speeds more than the setting in $C5-07$.

Note:

- If overshooting occurs when acceleration ends, decrease the value set in $C5-01$ and increase the value set in $C5-02$.
- If undershoot occurs at stop, decrease $C5-03$ and increase $C5-04$.

■ Use MFDI Switch for Proportional Gain

You can use the input terminals set for ASR Gain ($C5-03$) Select [$HI-xx = 77$] to switch the proportional gains set with $C5-01$ and $C5-03$. When the configured input terminal is deactivated, the proportional gain set for $C5-01$ is selected. When the terminal is activated, the proportional gain set for $C5-03$ is selected. The proportional gain changes linearly over the time set in $C5-02$ [ASR Integral Time 1]. The signals from this MFDI are more important than $C5-07$ [ASR Gain Switchover Frequency].

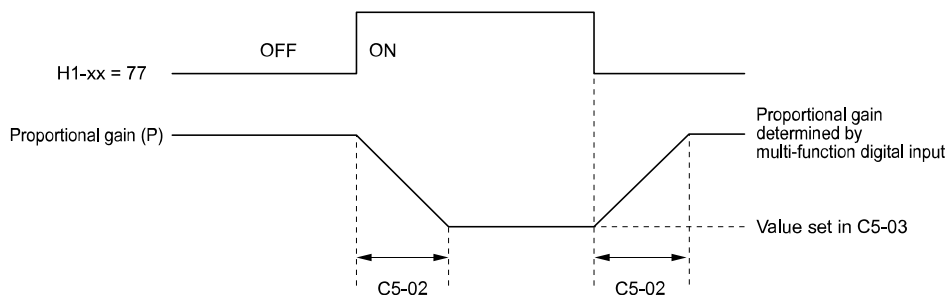

Figure 2.39 Proportional Gain through Multi-function Digital Input Switch

■ Speed Waveform Monitoring Method

To make small adjustments of ASR parameters, monitor the speed waveforms when you make the adjustments. Table 2.30 shows example settings of parameters to monitor speed waveforms.

Table 2.30 Example Settings of MFAO Terminals to Monitor Speed Waveforms

No.	Name	Setting Value	Description
H4-01	Terminal AM Analog Output Select	116	Lets you use terminal AM to monitor U1-16 [SFS Output Frequency].
H4-02	Terminal AM Analog Output Gain	100.0%	
H4-03	Terminal AM Analog Output Bias	0.0%	
H4-07	Terminal AM Signal Level Select	0	Lets you monitor in a 0 V to 10 V range.

Based on this setting, MFAO terminal AM outputs the output frequency after SFS in a 0 V to 10 V (0% to 100%) range. The MFAO common is terminal AC:

Yaskawa recommends that you monitor the output frequency after SFS and the motor speed for delays in response and differences in reference values.

■ Adjust ASR Parameters

Use Table 2.31 to adjust ASR. The table lists parameters for motor 1. You can make the same changes to motor 2 parameters when you run a second motor.

Note:

When adjusting the proportional gain and integral time, adjust the proportional gain first.

Table 2.31 ASR Response and Possible Solutions

Problem		Possible Solutions
Speed response is slow.		<ul style="list-style-type: none"> • Increase C5-01/C5-03 [ASR Proportional Gain]. • Decrease C5-02/C5-04 [ASR Integral Time].
Overshoot or undershoot occurs at the end of acceleration or deceleration.		<ul style="list-style-type: none"> • Decrease C5-01/C5-03. • Increase C5-02/C5-04.

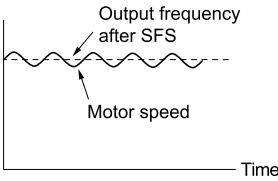
Problem		Possible Solutions
Vibration and oscillation occur at constant speed.		<ul style="list-style-type: none"> Decrease C5-01/C5-03. Increase C5-02/C5-04. Increase C5-06 [ASR Delay Time].
Oscillation at low speed and response is too slow at high speed. Oscillation at high speed and response is too slow at low speed.	-	When A1-02 = 6 [Control Method Selection = AOLV/PM], use C5-01 to C5-04 to set the best ASR settings for high and low speed. Use C5-07 [ASR Gain Switchover Frequency] to switch the ASR proportional gain and ASR integral time as specified by the output frequency.

■ C5-01: ASR Proportional Gain 1

No. (Hex.)	Name	Description	Default (Range)
C5-01 (021B) RUN	ASR Proportional Gain 1	<input checked="" type="radio"/> V/f <input type="radio"/> OLV <input type="radio"/> OLV/PM <input type="radio"/> AOLV/PM <input type="radio"/> EZOLV Sets the gain to adjust ASR response.	Determined by A1-02 (0.00 - 300.00)

A higher gain provides a higher speed response. Usually, the gain increases with larger loads. Too much gain will cause vibration.

Note:

- When A1-02 = 0 [Control Method Selection = V/f], set H6-01 = 3 [Terminal RP Pulse Train Function = Speed Feedback (V/F Control)] to enable this parameter.
- The drive usually sets Motor 1 ASR with C5-01 and C5-02 [ASR Integral Time 1]. When you set H1-xx = 77 [MFDI Function Select = ASR Gain Switch], you can switch between C5-01 and C5-03 [ASR Proportional Gain 2]. You can also use C5-01 as an alternative to C5-03 and C5-02 as an alternative to C5-04 when the speed is less than or equal to the frequency set in C5-07 [ASR Gain Switchover Frequency].
- The drive automatically adjusts C5-01 in ASR Tuning.

■ C5-02: ASR Integral Time 1

No. (Hex.)	Name	Description	Default (Range)
C5-02 (021C) RUN	ASR Integral Time 1	<input checked="" type="radio"/> V/f <input type="radio"/> OLV <input type="radio"/> OLV/PM <input type="radio"/> AOLV/PM <input type="radio"/> EZOLV Sets the ASR integral time.	Determined by A1-02 (0.000 - 60.000 s)

When you increase the integral time, the responsiveness will decrease. An integral time that is too short can cause oscillation.

Note:

When A1-02 = 0 [Control Method Selection = V/f], set H6-01 = 3 [Terminal RP Pulse Train Function = Speed Feedback (V/F Control)] to enable this parameter.

■ C5-03: ASR Proportional Gain 2

No. (Hex.)	Name	Description	Default (Range)
C5-03 (021D) RUN	ASR Proportional Gain 2	<input checked="" type="radio"/> V/f <input type="radio"/> OLV <input type="radio"/> OLV/PM <input type="radio"/> AOLV/PM <input type="radio"/> EZOLV Sets the gain to adjust ASR response.	Determined by A1-02 (0.00 - 300.00)

A higher gain provides a higher speed response. Usually, the gain increases with larger loads. Too much gain will cause vibration.

Note:

When A1-02 = 0 [Control Method Selection = V/f], set H6-01 = 3 [Terminal RP Pulse Train Function = Speed Feedback (V/F Control)] to enable this parameter.

■ C5-04: ASR Integral Time 2

No. (Hex.)	Name	Description	Default (Range)
C5-04 (021E) RUN	ASR Integral Time 2	<div style="display: flex; justify-content: space-between; align-items: center;"> V/f OLV OLV/PM AOLV/PM EZOLV </div> Sets the ASR integral time.	Determined by A1-02 (0.000 - 60.000 s)

When you increase the integral time, the responsiveness will decrease. An integral time that is too short can cause oscillation.

Note:

When A1-02 = 0 [Control Method Selection = V/f], set H6-01 = 3 [Terminal RP Pulse Train Function = Speed Feedback (V/F Control)] to enable this parameter.

■ C5-05: ASR Limit

No. (Hex.)	Name	Description	Default (Range)
C5-05 (021F)	ASR Limit	<div style="display: flex; justify-content: space-between; align-items: center;"> V/f OLV OLV/PM AOLV/PM EZOLV </div> Sets the ASR output limit where E1-04 [Maximum Output Frequency] is 100%.	5.0% (0.0 - 20.0%)

If the motor rated slip is high, it is necessary to increase the setting for correct motor speed control. Use U6-04 [ASR Output] to make sure that ASR is operating at the limit set in this parameter. When ASR is operating at the limit, correctly set the encoder (PG) signal before you make changes to C5-05.

Note:

When A1-02 = 0 [Control Method Selection = V/f], set H6-01 = 3 [Terminal RP Pulse Train Function = Speed Feedback (V/F Control)] to enable this parameter.

■ C5-06: ASR Delay Time

No. (Hex.)	Name	Description	Default (Range)
C5-06 (0220)	ASR Delay Time	<div style="display: flex; justify-content: space-between; align-items: center;"> V/f OLV OLV/PM AOLV/PM EZOLV </div> Sets the filter time constant of the torque reference output from the speed loop. Usually it is not necessary to change this setting.	Determined by A1-02 (0.000 - 0.500 s)

If you have a load with low rigidity or if oscillation is a problem, decrease C5-01 in 2-unit decrements or decrease C5-06 in 0.001-unit decrements.

■ C5-07: ASR Gain Switchover Frequency

No. (Hex.)	Name	Description	Default (Range)
C5-07 (0221)	ASR Gain Switchover Frequency	<div style="display: flex; justify-content: space-between; align-items: center;"> V/f OLV OLV/PM AOLV/PM EZOLV </div> Sets the frequency where the drive will switch between these parameters: C5-01 and C5-03 [ASR Proportional Gain 1/2] C5-02 and C5-04 [ASR Integral Time 1/2]	Determined by A1-02 (Determined by A1-02)

Switching the proportional gain and integral time in the low or high speed range can help operation become stable. A good switching point is 80% of the frequency where oscillation occurs or at 80% of the maximum output frequency.

Note:

An MFDI set for H1-xx = 77 [MFDI Function Selection = ASR Gain (C5-03) Select] will have priority over the ASR gain switching frequency.

■ C5-08: ASR Integral Limit

No. (Hex.)	Name	Description	Default (Range)
C5-08 (0222)	ASR Integral Limit	<div style="display: flex; justify-content: space-between; align-items: center;"> V/f OLV OLV/PM AOLV/PM EZOLV </div> Set the upper limit of the ASR integral amount as a percentage of the rated load.	400% (0 - 400%)

■ C5-12: Integral Operation @ Accel/Decel

No. (Hex.)	Name	Description	Default (Range)
C5-12 (0386)	Integral Operation @ Accel/Decel	<input checked="" type="checkbox"/> V/f <input type="checkbox"/> OLV <input type="checkbox"/> OLV/PM <input type="checkbox"/> AOLV/PM <input type="checkbox"/> EZOLV Sets ASR integral operation during acceleration and deceleration.	0 (0, 1)

Set this parameter to *1* to keep the motor speed near the frequency reference during operation and acceleration/ deceleration.

Note:

- When $A1-02 = 0$ [Control Method Selection = V/f], set $H6-01 = 3$ [Terminal RP Pulse Train Function = Speed Feedback (V/F Control)] to enable this parameter.
- If you enable integral control, overshoot or undershoot can occur when acceleration or deceleration complete. If there are problems with overshooting and undershooting, set this parameter to *0*.

0 : Disabled

The drive will not enable integral operation during acceleration or deceleration. The drive always enables integral operation during constant speed.

1 : Enabled

Integral operation is always enabled.

■ C5-29: Speed Control Response

No. (Hex.)	Name	Description	Default (Range)
C5-29 (0B18) Expert	Speed Control Response	<input checked="" type="checkbox"/> V/f <input type="checkbox"/> OLV <input type="checkbox"/> OLV/PM <input type="checkbox"/> AOLV/PM <input type="checkbox"/> EZOLV Sets the level of speed control responsiveness. Usually it is not necessary to change this setting.	1 (0, 1)

If a high level of speed control responsiveness is necessary, set $C5-29 = 1$, then adjust the speed control (ASR) parameter.

0 : Standard

1 : High Performance 1

■ C5-39: ASR Primary Delay Time Const 2

No. (Hex.)	Name	Description	Default (Range)
C5-39 (030D)	ASR Primary Delay Time Const 2	<input type="checkbox"/> V/f <input type="checkbox"/> OLV <input type="checkbox"/> OLV/PM <input checked="" type="checkbox"/> AOLV/PM <input type="checkbox"/> EZOLV Sets the filter time constant used when the torque reference is output from ASR. Usually it is not necessary to change this parameter.	0.000 s (0.000 - 0.500 s)

If you have a load with low rigidity or if oscillation is a problem, increase this setting in 0.01 unit increments.

◆ C6: Duty & Carrier Frequency

C6 parameters are used to set the selection of drive duty rating, selection of carrier frequency, and upper and lower limits of carrier frequencies.

■ C6-01: Normal / Heavy Duty Selection

No. (Hex.)	Name	Description	Default (Range)
C6-01 (0223)	Normal / Heavy Duty Selection	<input checked="" type="checkbox"/> V/f <input type="checkbox"/> OLV <input type="checkbox"/> OLV/PM <input type="checkbox"/> AOLV/PM <input type="checkbox"/> EZOLV Sets the drive duty rating.	1 (0, 1)

0 : Heavy Duty Rating

The overload tolerance is 150% of the rated output current for 60 seconds.

1 : Normal Duty Rating

The overload tolerance is 110% of the rated output current for 60 seconds.

There are two types of load ratings for this product depending on the load characteristics of the application: Heavy Duty Rating (HD) and Normal Duty Rating (ND).

The drive rated output current, overload tolerance, and acceleration stall prevention level change when the duty rating changes. Set the drive to agree with the duty rating of the selected drive capacity. In HD, the tolerance is 150% overload for 60 seconds. In ND, the tolerance is 110% overload for 60 seconds. The rated output current for ND drives is higher than the rated output current for HD drives.

Table 2.32 Differences between Heavy Duty Rating and Normal Duty Rating

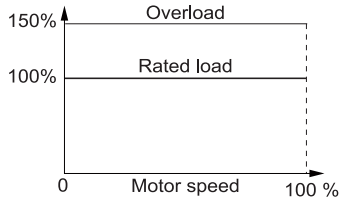
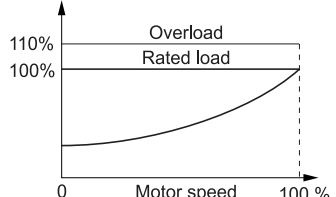
Item	Heavy Duty Rating (HD)	Normal Duty Rating (ND)
C6-01 Setting	0	1
Load Characteristics		
Application	<p>A high overload tolerance is necessary during start up, acceleration, deceleration, and equivalent conditions.</p> <ul style="list-style-type: none"> • Extruder • Conveyor • Constant torque or high overload capacity are necessary. 	<p>Overload tolerance is not necessary.</p> <ul style="list-style-type: none"> • Fan • Pump • Blower
Overload Tolerance	150% - 60 seconds	110% - 60 seconds
Stall Prevent Level during Accel	150%	120%
Stall Prevent Level during Run	150%	120%
Carrier Frequency	2 kHz	2 kHz Swing-PWM

Note:

- Set the stall prevention level during acceleration with *L3-02* and the stall prevention level during run with *L3-06*.
- Changing *C6-01* also changes the maximum capacity of applicable drive motors. The drive automatically changes the setting values *E2-xx* and *E4-xx* to applicable values. The drive also automatically changes these parameters that depend on motor output:
 - b8-04 [Energy Saving Coefficient Value]
 - L2-03 [Minimum Baseblock Time]
 - L3-24 [Motor Accel Time @ Rated Torque]
 - n5-02 [Motor Inertia Acceleration Time]

■ C6-02: Carrier Frequency Selection

No. (Hex.)	Name	Description	Default (Range)
C6-02 (0224)	Carrier Frequency Selection	 Sets the carrier frequency for the transistors in the drive.	Determined by A1-02, C6-01, and o2-04 (Determined by A1-02)

Changes to the switching frequency will decrease audible noise and decrease leakage current.

Note:

Increasing the carrier frequency to more than the default setting will automatically decrease the drive current rating.

1 : 2.0 kHz

2 : 5.0 kHz (AOLV/PM: 4.0 kHz)

3 : 8.0 kHz (AOLV/PM: 6.0 kHz)

4 : 10.0 kHz (AOLV/PM: 8.0 kHz)

5 : 12.5 kHz (AOLV/PM: 10.0 kHz)

6 : 15.0 kHz (AOLV/PM: 12.0 kHz)

7 : Swing PWM4 (Audible Sound 1)

8 : Swing PWM4 (Audible Sound 2)

9 : Swing PWM4 (Audible Sound 3)

A : Swing PWM4 (Audible Sound 4)

B : Leakage Current Rejection PWM

Set this when the wiring distance between the drive and motor is long and there is a fault in the current monitor or the drive detects and alarm because of the effect of a leakage current.

The carrier frequency is equivalent to 2.0 kHz.

F : User Defined (C6-03 to C6-05)

Use C6-03 to C6-05 to set detailed setting values.

Note:

- The setting range changes when the A1-02 [Control Method Selection] value changes:
 -5, 8 [OLV/PM, EZOLV]: You can set C6-02 = 1 to 6, B, and F.
 -6 [AOLV/PM]: You can set C6-02 = 1 to 6.
- The carrier frequency for Swing PWM 1 is equivalent to 2.0 kHz. Swing PWM applies a special PWM pattern to decrease the audible noise.

Table 2.33 Guidelines for Carrier Frequency Parameter Setup

Symptom	Remedy
Speed and torque are not stable at low speed.	Decrease the carrier frequency.
Speed and torque are not stable at low speed.	Decrease the carrier frequency.
Too much leakage current from the drive.	Decrease the carrier frequency.
Wiring between the drive and motor is too long.	Decrease the carrier frequency. Note: If the motor cable is too long, it can be necessary to decrease the carrier frequency. Refer to Table 2.34 for the wiring distance and decrease the carrier frequency.
Audible motor noise is too loud.	Increase the carrier frequency. Use Swing PWM. Note: The default carrier frequency in ND is C6-02 = 7 [Swing PWM1 (Audible Sound 1)], with a 2 kHz base. You can increase the carrier frequency in Normal Duty mode, but this will decrease the drive rated current.

Table 2.34 Wiring Distance

Wiring Distance	50 m (164 ft) Maximum	100 m (328 ft) Maximum	More than 100 m (328 ft)
C6-02 [Carrier Frequency Selection]	1 to F (up to 15 kHz)	1 to 2 (up to 5 kHz), 7	1 (up to 2 kHz), 7

Note:

- If the length of the wire between the drive and an induction motor is longer than 100 m (328 ft), set A1-02 = 0 [V/f].
- The maximum wiring cable length between the drive and a PM motor is 100 m (328 ft).
- If the cable length between the drive and the motor is too long when A1-02 = 6, set A1-02 = 5.

■ C6-03: Carrier Frequency Upper Limit

No. (Hex.)	Name	Description	Default (Range)
C6-03 (0225)	Carrier Frequency Upper Limit	V/f OLV OLV/PM AOLV/PM EZOLV Sets the upper limit of the carrier frequency. Set C6-02 = F [Carrier Frequency Selection = User Defined (C6-03 to C6-05)] to set this parameter.	Determined by C6-02 (1.0 - 15.0 kHz)

Setting a Fixed User-Defined Carrier Frequency

When you cannot use C6-02 to set a carrier frequency between set selectable values, you can set the value in C6-03. The carrier frequency will be fixed to the value set to C6-03.

When A1-02 = 0 [Control Method Selection = V/f], set C6-03 = C6-04 [Carrier Frequency Lower Limit] to fix the carrier frequency.

Setting a Variable Carrier Frequency to Agree with the Output Frequency

When A1-02 = 0, set C6-03, C6-04, and C6-05 [Carrier Freq Proportional Gain] as shown in Figure 2.40 to make the carrier frequency change linearly with the output frequency.

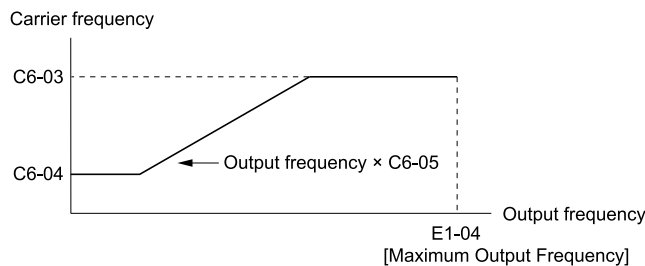

Figure 2.40 Setting a Variable Carrier Frequency to Agree with the Output Frequency

Note:

- When $C6-05 \leq 7$, the drive disables $C6-04$. The carrier frequency is fixed to the value set to $C6-03$.
- The drive detects *oPE11* [Carrier Frequency Setting Error] when these conditions are correct at the same time:
 - $C6-05 \geq 6$
 - $C6-04 \geq C6-03$
- When $A1-02 = 0, 2, 5, 8$ [Control Method Selection = *v/f*, *OLV*, *OLV/PM*, *EZOLV*], in the area where the output frequency is more than $C6-03$ and $C6-12$, the carrier frequency = output frequency $\times 12$, and it will change with the output frequency.

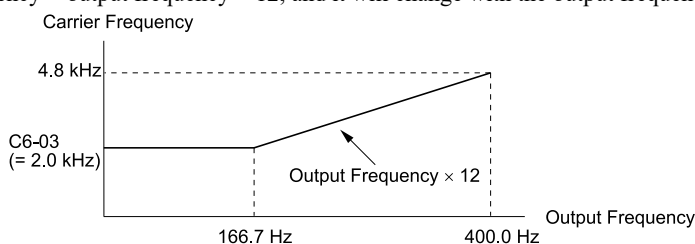

Figure 2.41 Carrier Frequency when $C6-03 = 2.0$ kHz, $E1-04 = 400.0$ Hz

■ C6-04: Carrier Frequency Lower Limit

No. (Hex.)	Name	Description	Default (Range)
C6-04 (0226)	Carrier Frequency Lower Limit	<input checked="" type="radio"/> <i>v/f</i> <input type="radio"/> <i>OLV</i> <input type="radio"/> <i>OLV/PM</i> <input type="radio"/> <i>AOLV/PM</i> <input type="radio"/> <i>EZOLV</i> Sets the lower limit of the carrier frequency. Set $C6-02 = F$ [Carrier Frequency Selection = User Defined ($C6-03$ to $C6-05$)] to set this parameter.	Determined by $C6-02$ (1.0 - 15.0 kHz)

Set $C6-03$ [Carrier Frequency Upper Limit], $C6-04$, and $C6-05$ [Carrier Freq Proportional Gain] to make the carrier frequency change linearly with the output frequency.

Note:

- The drive detects *oPE11* [Carrier Frequency Setting Error] when these conditions are correct at the same time:
- $C6-04 \geq C6-03$
 - $C6-05 \geq 6$

■ C6-05: Carrier Freq Proportional Gain

No. (Hex.)	Name	Description	Default (Range)
C6-05 (0227)	Carrier Freq Proportional Gain	<input checked="" type="radio"/> <i>v/f</i> <input type="radio"/> <i>OLV</i> <input type="radio"/> <i>OLV/PM</i> <input type="radio"/> <i>AOLV/PM</i> <input type="radio"/> <i>EZOLV</i> Sets the proportional gain for the carrier frequency. Set $C6-02 = F$ [Carrier Frequency Selection = User Defined ($C6-03$ to $C6-05$)] to set this parameter.	Determined by $C6-02$ (0 - 99)

Set $C6-03$ [Carrier Frequency Upper Limit], $C6-04$ [Carrier Frequency Lower Limit], and $C6-05$ to make the carrier frequency change linearly with the output frequency.

■ C6-09: Carrier Freq at Rotational Tune

No. (Hex.)	Name	Description	Default (Range)
C6-09 (022B)	Carrier Freq at Rotational Tune	<input type="radio"/> <i>v/f</i> <input checked="" type="radio"/> <i>OLV</i> <input type="radio"/> <i>OLV/PM</i> <input type="radio"/> <i>AOLV/PM</i> <input type="radio"/> <i>EZOLV</i> Sets the Auto-Tuning carrier frequency. Usually it is not necessary to change this setting.	0 (0, 1)

2.4 C: Tuning

If $C6-09 = 0$ and you do Auto-Tuning on a high frequency motor or low impedance motor, it can cause oC [Overcurrent]. To prevent oC , increase the carrier frequency value, set $C6-09 = 1$, then do Auto-Tuning.

The procedure to set the carrier frequency when the $A1-02$ [Control Method Selection] setting changes.

- When $A1-02 = 2$ [OLV], set $C6-02 = F$ [Carrier Frequency Selection = User Defined (C6-03 to C6-05)] and then increase the value set to $C6-03$ [Carrier Frequency Upper Limit].
- When $A1-02 = 5$ or 6 [OLV/PM or AOLV/PM], use $C6-02$ to increase the carrier frequency.

0 : 5 kHz

Note:

When $A1-02 = 5$ or 6 , the carrier frequency is 2 kHz.

1 : Use C6-03

Note:

When $A1-02 = 5$ or 6 , the carrier frequency is the value set to $C6-02$.

2.5 d: References

d parameters [References] set the frequency reference input method and dead band range. They also set torque control, field weakening, and field forcing functions.

WARNING! Sudden Movement Hazard. Use fast stop circuits to safely and quickly stop the drive. After you wire the fast stop circuits, you must check their operation. Test the operation of the fast stop function before you use the drive. If you do not test the fast stop circuit before you operate the drive, it can cause serious injury or death.

◆ d1: Frequency Reference

Figure 2.42 shows the frequency reference input method, command source selection method, and priority descriptions.

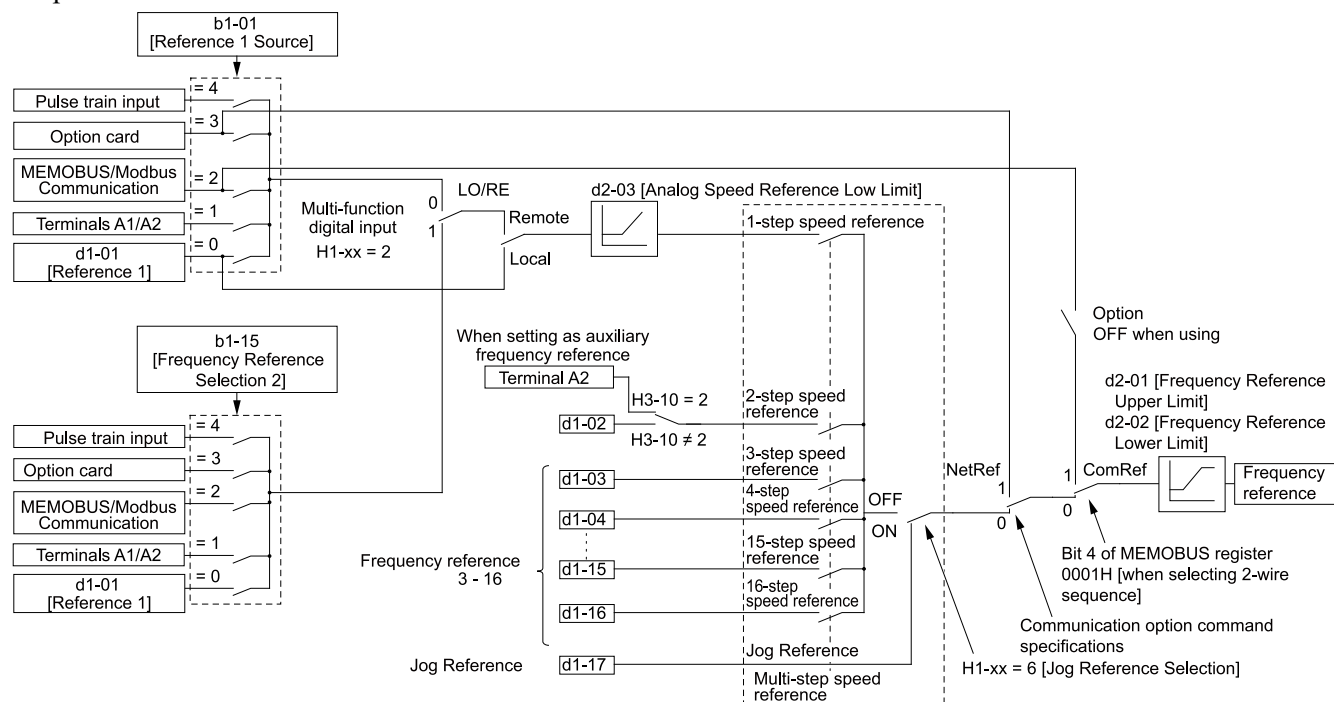

Figure 2.42 Frequency Reference Setting Hierarchy

■ Multi-Step Speed Operation

The drive has a multi-step speed operation function that can set many frequency references in advance. Set frequency references in *d1-xx* parameters. You can select the set frequency references with MFDI signals from an external source. Activate and deactivate the digital input to select the frequency reference to change the motor speed in steps. You can use the 16-step frequency reference and one Jog Frequency Reference (JOG command) to switch the speed to the maximum 17-step speeds.

Note:

- The Jog Frequency Reference (JOG command) overrides all other frequency references.
- You can use the MFDI to switch the frequency reference when the motor is running. The drive will apply the enabled acceleration and deceleration times.
- The default settings for Multi-Step Speed Reference 1 (master frequency reference) and Multi-Step Speed Reference 2 (auxiliary frequency reference) are the analog frequency reference. Also, voltage command input terminal A1 and current input terminal A2 for Multi-Step Speed Reference 1 (master frequency reference) are added internally by default. The drive uses Multi-Step Speed Reference 1 when the signal is connected to an analog input terminal.

■ Setting Procedures for Multi-step Speed Operation

Use an Analog Input as Reference 1 and 2

This section gives information about the procedures to set these examples:

- Multi-Step Speed 6 (6 types of frequency references)

2.5 d: References

- When you set the voltage input of analog inputs from terminals A1 and A2 to 0 V to 10 V (Lower Limit at 0)

Procedure	Configuration Parameter	Task Contents
1	Reference 1	1. Sets $b1-01 = 1$ [Frequency Reference Selection 1 = Analog Input]. 2. Sets $H3-02 = 0$ [Terminal A1 Function Selection = Frequency Reference]. 3. Sets $H3-01 = 0$ [Terminal A1 Signal Level Select = 0 V to 10 V (Lower Limit at 0)].
2	Reference 2	1. Sets $H3-10 = 2$ [Terminal A2 Function Selection = Auxiliary Frequency Reference 1]. 2. Sets $H3-09 = 0$ [Terminal A2 Signal Level Select = 0 V to 10 V (Lower Limit at 0)].
3	Signal type of analog input	Set DIP switch S1 on the control circuit board to the V-side (voltage) to set terminal A2 only for voltage input. Note: Set this before you energize the drive.
4	Reference 3	Sets the value of $d1-03$ [Reference 3].
5	Reference 4	Sets the value of $d1-04$ [Reference 4].
6	Reference 5	Sets the value of $d1-05$ [Reference 5].
7	Jog Reference	Sets $d1-17$ [Jog Reference] to the jog speed.
8	External digital input (3 inputs)	Set the Multi-Step Speed Reference 1 to 3 [$H1-xx = 3, 4, 5$] to one of the MFDI terminals S1 to S7.
9	JOG command	Set the Jog Reference Selection [$H1-xx = 6$] to one of the MFDI terminals S1 to S7.

Use the Maximum 17-Step Speed with All Digital Inputs

This section is the procedure to set the 17-step speeds (17 types of frequency references) without an analog input.

Procedure	Configuration Parameter	Task Contents
1	Analog reference	1. Sets $H3-02 = F$ [Terminal A1 Function Selection = Not Used], and disables the analog reference. 2. Sets $H3-10 = F$ [Terminal A2 Function Selection = Not Used], and disables the analog reference.
2	Reference 2 to 16	Sets the values of $d1-02$ to $d1-16$ [Reference 2 to 16].
3	Jog Reference	Sets $d1-17$ [Jog Reference] to the jog speed.
4	External digital input (4 inputs)	Set Multi-Step Speed Reference 1 to 4 [$H1-xx = 3, 4, 5, 32$] to one of the MFDI terminals S1 to S7.
5	JOG command	Set the Jog Reference Selection [$H1-xx = 6$] to one of the MFDI terminals S1 to S7.

Multi-step Speed Operation Combinations

Refer to [Table 2.35](#) and [Figure 2.43](#) for information about multi-step speed reference combinations. The selected frequency reference changes when the combination of digital input signals from an external source changes.

Table 2.35 Multi-step Speed Reference and MFDI Terminal Combinations

Related Parameters	Multi-Step Speed Reference 1 $H1-xx = 3$	Multi-Step Speed Reference 2 $H1-xx = 4$	Multi-Step Speed Reference 3 $H1-xx = 5$	Multi-Step Speed Reference 4 $H1-xx = 32$	Jog Reference $H1-xx = 6$
Reference 1 (set in $b1-01$)	OFF	OFF	OFF	OFF	OFF
Reference 2 ($d1-02$ or terminals A1, A2)	ON	OFF	OFF	OFF	OFF
Reference 3 ($d1-03$ or terminals A1, A2)	OFF	ON	OFF	OFF	OFF
Reference 4 ($d1-04$)	ON	ON	OFF	OFF	OFF
Reference 5 ($d1-05$)	OFF	OFF	ON	OFF	OFF
Reference 6 ($d1-06$)	ON	OFF	ON	OFF	OFF
Reference 7 ($d1-07$)	OFF	ON	ON	OFF	OFF
Reference 8 ($d1-08$)	ON	ON	ON	OFF	OFF
Reference 9 ($d1-09$)	OFF	OFF	OFF	ON	OFF
Reference 10 ($d1-10$)	ON	OFF	OFF	ON	OFF
Reference 11 ($d1-11$)	OFF	ON	OFF	ON	OFF
Reference 12 ($d1-12$)	ON	ON	OFF	ON	OFF
Reference 13 ($d1-13$)	OFF	OFF	ON	ON	OFF

Related Parameters	Multi-Step Speed Reference 1 H1-xx = 3	Multi-Step Speed Reference 2 H1-xx = 4	Multi-Step Speed Reference 3 H1-xx = 5	Multi-Step Speed Reference 4 H1-xx = 32	Jog Reference H1-xx = 6
Reference 14 (d1-14)	ON	OFF	ON	ON	OFF
Reference 15 (d1-15)	OFF	ON	ON	ON	OFF
Reference 16 (d1-16)	ON	ON	ON	ON	OFF
Jog Reference (d1-17) *1	-	-	-	-	ON

*1 The Jog Frequency Reference (JOG command) overrides all other frequency references.

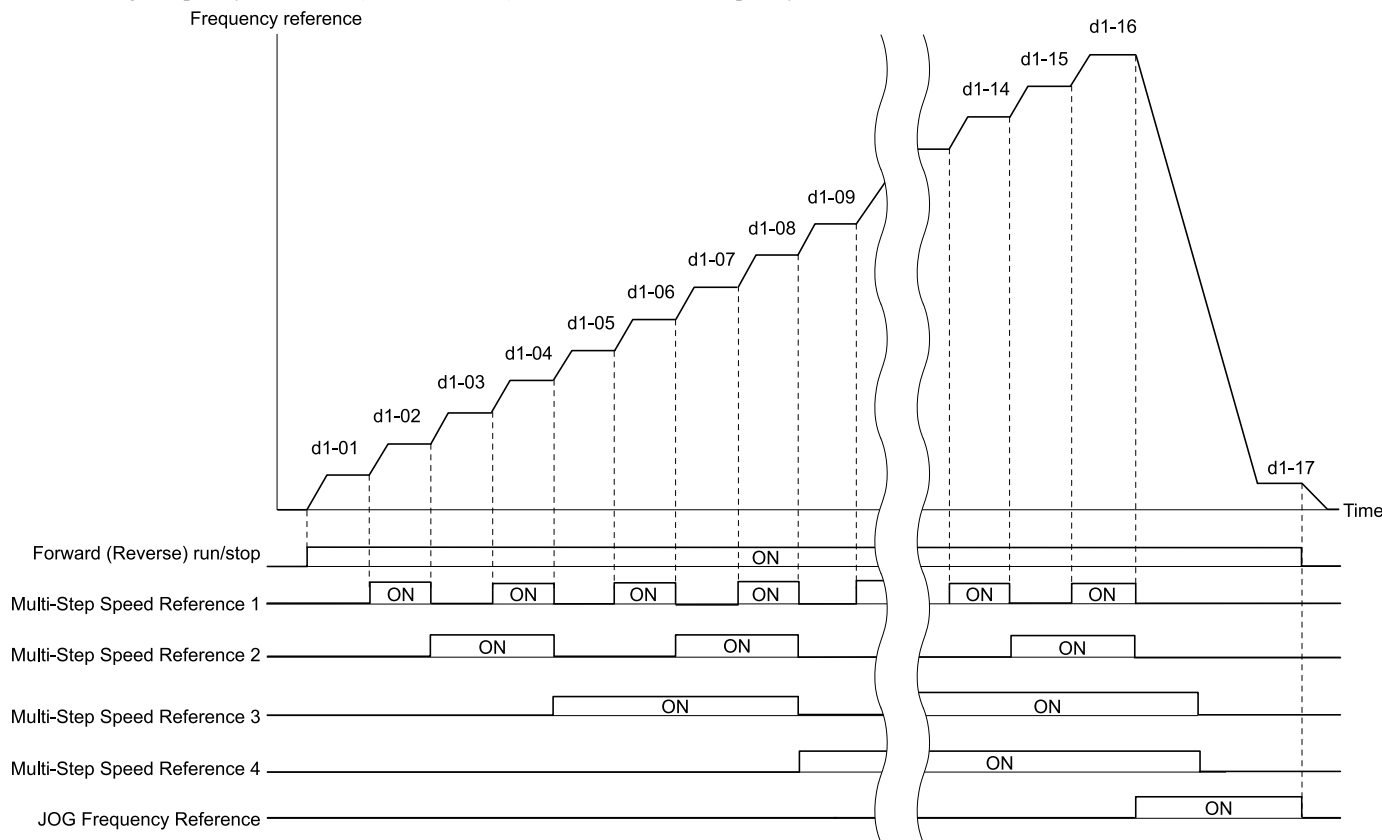

Figure 2.43 Time Chart for Multi-step Speed Reference/JOG Reference

■ d1-01: Reference 1

No. (Hex.)	Name	Description	Default (Range)
d1-01 (0280) RUN	Reference 1	V/f OLV OLV/PM AOLV/PM EZOLV Sets the frequency reference in the units from o1-03 [Frequency Display Unit Selection].	0.00 Hz (0.00 - 590.00 Hz)

Note:

- The upper limit value changes when the E1-04 [Maximum Output Frequency] and d2-01 [Frequency Reference Upper Limit] values change. Calculate the upper limit value with this formula:

$$\text{Upper limit value} = (E1-04) \times (d2-01) / 100$$
- When A1-02 = 6 [Control Method Selection = AOLV/PM], the drive sets o1-03 = 1 [0.01% (100% = E1-04)].
- To set d1-01 to 1-step speed parameter in a multi-step speed operation, set b1-01 = 0 [Frequency Reference Selection 1 = Keypad].

■ d1-02: Reference 2

No. (Hex.)	Name	Description	Default (Range)
d1-02 (0281) RUN	Reference 2	<div style="display: flex; gap: 5px;"> V/f OLV OLV/PM AOLV/PM EZOLV </div> Sets the frequency reference in the units from o1-03 [Frequency Display Unit Selection].	0.00 Hz (0.00 - 590.00 Hz)

Note:

- The upper limit value changes when the E1-04 [Maximum Output Frequency] and d2-01 [Frequency Reference Upper Limit] values change.
- When A1-02 = 6 [Control Method Selection = AOLV/PM], the drive sets o1-03 = 1 [0.01% (100% = E1-04)].
- To set d1-02 to Multi-Step Speed 2, set H3-02 and 3-10 ≠ 2 [MFAI Function Select ≠ Auxiliary Frequency Reference 1].

■ d1-03: Reference 3

No. (Hex.)	Name	Description	Default (Range)
d1-03 (0282) RUN	Reference 3	<div style="display: flex; gap: 5px;"> V/f OLV OLV/PM AOLV/PM EZOLV </div> Sets the frequency reference in the units from o1-03 [Frequency Display Unit Selection].	0.00 Hz (0.00 - 590.00 Hz)

Note:

- The upper limit value changes when the E1-04 [Maximum Output Frequency] and d2-01 [Frequency Reference Upper Limit] values change.
- When A1-02 = 6 [Control Method Selection = AOLV/PM], the drive sets o1-03 = 1 [0.01% (100% = E1-04)].
- To set d1-03 to Multi-Step Speed 3, set H3-02 and H3-10 ≠ 3 [MFAI Function Select ≠ Auxiliary Frequency Reference 2].

■ d1-04: Reference 4

No. (Hex.)	Name	Description	Default (Range)
d1-04 (0283) RUN	Reference 4	<div style="display: flex; gap: 5px;"> V/f OLV OLV/PM AOLV/PM EZOLV </div> Sets the frequency reference in the units from o1-03 [Frequency Display Unit Selection].	0.00 Hz (0.00 - 590.00 Hz)

Note:

- The upper limit value changes when the E1-04 [Maximum Output Frequency] and d2-01 [Frequency Reference Upper Limit] values change.
- When A1-02 = 6 [Control Method Selection = AOLV/PM], the drive sets o1-03 = 1 [0.01% (100% = E1-04)].
- This parameter sets the frequency reference of Multi-Step Speed 4.

■ d1-05: Reference 5

No. (Hex.)	Name	Description	Default (Range)
d1-05 (0284) RUN	Reference 5	<div style="display: flex; gap: 5px;"> V/f OLV OLV/PM AOLV/PM EZOLV </div> Sets the frequency reference in the units from o1-03 [Frequency Display Unit Selection].	0.00 Hz (0.00 - 590.00 Hz)

Note:

- The upper limit value changes when the E1-04 [Maximum Output Frequency] and d2-01 [Frequency Reference Upper Limit] values change.
- When A1-02 = 6 [Control Method Selection = AOLV/PM], the drive sets o1-03 = 1 [0.01% (100% = E1-04)].
- This parameter sets the frequency reference of Multi-Step Speed 5.

■ d1-06: Reference 6

No. (Hex.)	Name	Description	Default (Range)
d1-06 (0285) RUN	Reference 6	<div style="display: flex; gap: 5px;"> V/f OLV OLV/PM AOLV/PM EZOLV </div> Sets the frequency reference in the units from o1-03 [Frequency Display Unit Selection].	0.00 Hz (0.00 - 590.00 Hz)

Note:

- The upper limit value changes when the *E1-04 [Maximum Output Frequency]* and *d2-01 [Frequency Reference Upper Limit]* values change.
- When *A1-02 = 6 [Control Method Selection = AOLV/PM]*, the drive sets *o1-03 = 1 [0.01% (100% = E1-04)]*.
- This parameter sets the frequency reference of Multi-Step Speed 6.

■ d1-07: Reference 7

No. (Hex.)	Name	Description	Default (Range)
d1-07 (0286) RUN	Reference 7	<div style="display: flex; justify-content: space-between; align-items: center;"> V/f OLV OLV/PM AOLV/PM EZOLV </div> Sets the frequency reference in the units from <i>o1-03 [Frequency Display Unit Selection]</i> .	0.00 Hz (0.00 - 590.00 Hz)

Note:

- The upper limit value changes when the *E1-04 [Maximum Output Frequency]* and *d2-01 [Frequency Reference Upper Limit]* values change.
- When *A1-02 = 6 [Control Method Selection = AOLV/PM]*, the drive sets *o1-03 = 1 [0.01% (100% = E1-04)]*.
- This parameter sets the frequency reference of Multi-Step Speed 7.

■ d1-08: Reference 8

No. (Hex.)	Name	Description	Default (Range)
d1-08 (0287) RUN	Reference 8	<div style="display: flex; justify-content: space-between; align-items: center;"> V/f OLV OLV/PM AOLV/PM EZOLV </div> Sets the frequency reference in the units from <i>o1-03 [Frequency Display Unit Selection]</i> .	0.00 Hz (0.00 - 590.00 Hz)

Note:

- The upper limit value changes when the *E1-04 [Maximum Output Frequency]* and *d2-01 [Frequency Reference Upper Limit]* values change.
- When *A1-02 = 6 [Control Method Selection = AOLV/PM]*, the drive sets *o1-03 = 1 [0.01% (100% = E1-04)]*.
- This parameter sets the frequency reference of Multi-Step Speed 8.

■ d1-09: Reference 9

No. (Hex.)	Name	Description	Default (Range)
d1-09 (0288) RUN	Reference 9	<div style="display: flex; justify-content: space-between; align-items: center;"> V/f OLV OLV/PM AOLV/PM EZOLV </div> Sets the frequency reference in the units from <i>o1-03 [Frequency Display Unit Selection]</i> .	0.00 Hz (0.00 - 590.00 Hz)

Note:

- The upper limit value changes when the *E1-04 [Maximum Output Frequency]* and *d2-01 [Frequency Reference Upper Limit]* values change.
- When *A1-02 = 6 [Control Method Selection = AOLV/PM]*, the drive sets *o1-03 = 1 [0.01% (100% = E1-04)]*.
- This parameter sets the frequency reference of Multi-Step Speed 9.

■ d1-10: Reference 10

No. (Hex.)	Name	Description	Default (Range)
d1-10 (028B) RUN	Reference 10	<div style="display: flex; justify-content: space-between; align-items: center;"> V/f OLV OLV/PM AOLV/PM EZOLV </div> Sets the frequency reference in the units from <i>o1-03 [Frequency Display Unit Selection]</i> .	0.00 Hz (0.00 - 590.00 Hz)

Note:

- The upper limit value changes when the *E1-04 [Maximum Output Frequency]* and *d2-01 [Frequency Reference Upper Limit]* values change.
- When *A1-02 = 6 [Control Method Selection = AOLV/PM]*, the drive sets *o1-03 = 1 [0.01% (100% = E1-04)]*.
- This parameter sets the frequency reference of Multi-Step Speed 10.

■ d1-11: Reference 11

No. (Hex.)	Name	Description	Default (Range)
d1-11 (028C) RUN	Reference 11	<div style="display: flex; justify-content: space-between; align-items: center;"> V/f OLV OLV/PM AOLV/PM EZOLV </div> Sets the frequency reference in the units from <i>o1-03</i> [Frequency Display Unit Selection].	0.00 Hz (0.00 - 590.00 Hz)

Note:

- The upper limit value changes when the *E1-04* [Maximum Output Frequency] and *d2-01* [Frequency Reference Upper Limit] values change.
- When *A1-02* = 6 [Control Method Selection = AOLV/PM], the drive sets *o1-03* = 1 [0.01% (100% = *E1-04*)].
- This parameter sets the frequency reference of Multi-Step Speed 11.

■ d1-12: Reference 12

No. (Hex.)	Name	Description	Default (Range)
d1-12 (028D) RUN	Reference 12	<div style="display: flex; justify-content: space-between; align-items: center;"> V/f OLV OLV/PM AOLV/PM EZOLV </div> Sets the frequency reference in the units from <i>o1-03</i> [Frequency Display Unit Selection].	0.00 Hz (0.00 - 590.00 Hz)

Note:

- The upper limit value changes when the *E1-04* [Maximum Output Frequency] and *d2-01* [Frequency Reference Upper Limit] values change.
- When *A1-02* = 6 [Control Method Selection = AOLV/PM], the drive sets *o1-03* = 1 [0.01% (100% = *E1-04*)].
- This parameter sets the frequency reference of Multi-Step Speed 12.

■ d1-13: Reference 13

No. (Hex.)	Name	Description	Default (Range)
d1-13 (028E) RUN	Reference 13	<div style="display: flex; justify-content: space-between; align-items: center;"> V/f OLV OLV/PM AOLV/PM EZOLV </div> Sets the frequency reference in the units from <i>o1-03</i> [Frequency Display Unit Selection].	0.00 Hz (0.00 - 590.00 Hz)

Note:

- The upper limit value changes when the *E1-04* [Maximum Output Frequency] and *d2-01* [Frequency Reference Upper Limit] values change.
- When *A1-02* = 6 [Control Method Selection = AOLV/PM], the drive sets *o1-03* = 1 [0.01% (100% = *E1-04*)].
- This parameter sets the frequency reference of Multi-Step Speed 13.

■ d1-14: Reference 14

No. (Hex.)	Name	Description	Default (Range)
d1-14 (028F) RUN	Reference 14	<div style="display: flex; justify-content: space-between; align-items: center;"> V/f OLV OLV/PM AOLV/PM EZOLV </div> Sets the frequency reference in the units from <i>o1-03</i> [Frequency Display Unit Selection].	0.00 Hz (0.00 - 590.00 Hz)

Note:

- The upper limit value changes when the *E1-04* [Maximum Output Frequency] and *d2-01* [Frequency Reference Upper Limit] values change.
- When *A1-02* = 6 [Control Method Selection = AOLV/PM], the drive sets *o1-03* = 1 [0.01% (100% = *E1-04*)].
- This parameter sets the frequency reference of Multi-Step Speed 14.

■ d1-15: Reference 15

No. (Hex.)	Name	Description	Default (Range)
d1-15 (0290) RUN	Reference 15	<div style="display: flex; justify-content: space-between; align-items: center;"> V/f OLV OLV/PM AOLV/PM EZOLV </div> Sets the frequency reference in the units from <i>o1-03</i> [Frequency Display Unit Selection].	0.00 Hz (0.00 - 590.00 Hz)

Note:

- The upper limit value changes when the *E1-04* [Maximum Output Frequency] and *d2-01* [Frequency Reference Upper Limit] values change.
- When *A1-02* = 6 [Control Method Selection = AOLV/PM], the drive sets *o1-03* = 1 [0.01% (100% = *E1-04*)].
- This parameter sets the frequency reference of Multi-Step Speed 15.

■ d1-16: Reference 16

No. (Hex.)	Name	Description	Default (Range)
d1-16 (0291) RUN	Reference 16	<div style="display: flex; justify-content: space-between; align-items: center;"> V/f OLV OLV/PM AOLV/PM EZOLV </div> Sets the frequency reference in the units from <i>o1-03</i> [Frequency Display Unit Selection].	0.00 Hz (0.00 - 590.00 Hz)

Note:

- The upper limit value changes when the *E1-04* [Maximum Output Frequency] and *d2-01* [Frequency Reference Upper Limit] values change.
- When *A1-02* = 6 [Control Method Selection = AOLV/PM], the drive sets *o1-03* = 1 [0.01% (100% = *E1-04*)].
- This parameter sets the frequency reference of Multi-Step Speed 16.

■ d1-17: Jog Reference

No. (Hex.)	Name	Description	Default (Range)
d1-17 (0292) RUN	Jog Reference	<div style="display: flex; justify-content: space-between; align-items: center;"> V/f OLV OLV/PM AOLV/PM EZOLV </div> Sets the Jog frequency reference in the units from <i>o1-03</i> [Frequency Display Unit Selection]. Set <i>H1-xx</i> = 6 [MFDI Function Select = Jog Reference Selection] to use the Jog frequency reference.	6.00 Hz (0.00 - 590.00 Hz)

Note:

- The upper limit value changes when the *E1-04* [Maximum Output Frequency] and *d2-01* [Frequency Reference Upper Limit] values change.
- When *A1-02* = 6 [Control Method Selection = AOLV/PM], the drive sets *o1-03* = 1 [0.01% (100% = *E1-04*)].

◆ d2: Reference Limits

d2 parameters set the upper and lower frequency limits to control the motor speed. Apply these parameters to for example, run the motor at low-speed due to mechanical strength concerns, or if the motor should not be run at low speed because of lubrication issues with the gears and bearings.

The upper frequency limit is set in *d2-01* [Frequency Reference Upper Limit] and the lower limit is set in *d2-02* [Frequency Reference Lower Limit].

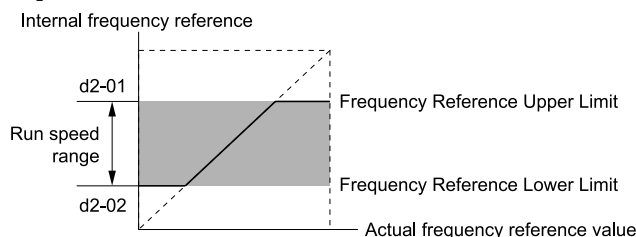

Figure 2.44 Upper and Lower Frequency Limits

■ d2-01: Frequency Reference Upper Limit

No. (Hex.)	Name	Description	Default (Range)
d2-01 (0289)	Frequency Reference Upper Limit	<div style="display: flex; justify-content: space-between; align-items: center;"> V/f OLV OLV/PM AOLV/PM EZOLV </div> Sets maximum limit for all frequency references. The maximum output frequency is 100%.	100.0% (0.0 - 110.0%)

When the frequency reference is more than the value set in *d2-01* the drive will continue to operate at the value set in *d2-01*.

■ d2-02: Frequency Reference Lower Limit

No. (Hex.)	Name	Description	Default (Range)
d2-02 (028A)	Frequency Reference Lower Limit	V/f OLV OLV/PM AOLV/PM EZOLV Sets minimum limit for all frequency references. The maximum output frequency is 100%.	0.0% (0.0 - 110.0%)

When the frequency reference is less than the value set in *d2-02*, the drive will continue to operate at the value set in *d2-02*. The motor will accelerate to the *d2-02* value after the drive receives a Run command and a lower frequency reference than *d2-02* has been entered.

■ d2-03: Analog Frequency Ref Lower Limit

No. (Hex.)	Name	Description	Default (Range)
d2-03 (0293)	Analog Frequency Ref Lower Limit	V/f OLV OLV/PM AOLV/PM EZOLV Sets the lower limit for the master frequency reference (the first frequency of the multi-step speed reference) as a percentage. The maximum output frequency is 100%.	0.0% (0.0 - 110.0%)

This parameter does not change the lower limit of Jog reference, frequency reference for multi-step speed operation, or the auxiliary frequency reference.

The drive operates at the value set in *d2-03* when the frequency reference decreases to less than the value set in *d2-03*.

Note:

When lower limits are set to parameters *d2-02* [Frequency Reference Lower Limit] and *d2-03*, the drive uses the larger value as the lower limit.

◆ d3: Jump Frequency

The Jump frequency is a function that sets the dead band to a specified frequency band. If a machine that operated at constant speed is operated with variable speed, it can make resonance. To operate the machine without resonance from the natural frequency of the machinery mechanical system, use a frequency band jump.

You can program the drive to have three different Jump frequencies. Set *d3-01* [Jump Frequency 1] to *d3-03* [Jump Frequency 3] to the center value for the frequency to avoid and set *d3-04* [Jump Frequency Width] to be 1/2 of the total band to avoid.

When you input a frequency reference that is the same as or near the Jump frequency width, the frequency reference changes automatically.

The drive accelerates or decelerates the motor smoothly until the frequency reference is not in the range of the Jump frequency band. The drive will use the active accel/decel time to go through the specified dead band range. If the frequency reference is not in the range of the Jump frequency band, switch to constant speed operation.

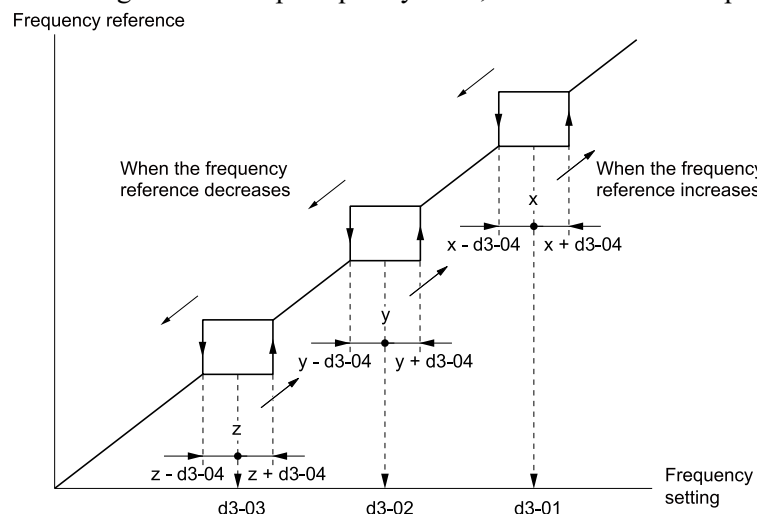

Figure 2.45 Jump Frequency

Note:

- When you set Jump Frequencies 1 to 3, make sure that the parameters do not overlap. The drive will not indicate this condition.
- When the drive is in the range of the Jump frequency, the frequency reference changes automatically. When the drive jumps frequencies, the output frequency changes smoothly as specified by the values set in *C1-01 [Acceleration Time 1]* and *C1-02 [Deceleration Time 1]*.

■ d3-01: Jump Frequency 1

No. (Hex.)	Name	Description	Default (Range)
d3-01 (0294)	Jump Frequency 1	<div style="display: flex; gap: 5px;"> V/f OLV OLV/PM AOLV/PM EZOLV </div> Sets the median value of the frequency band that the drive will avoid.	0.0 Hz (Determined by A1-02)

Note:

Set this parameter to 0.0 Hz to disable the Jump frequency.

■ d3-02: Jump Frequency 2

No. (Hex.)	Name	Description	Default (Range)
d3-02 (0295)	Jump Frequency 2	<div style="display: flex; gap: 5px;"> V/f OLV OLV/PM AOLV/PM EZOLV </div> Sets the median value of the frequency band that the drive will avoid.	0.0 Hz (Determined by A1-02)

Note:

Set this parameter to 0.0 Hz to disable the Jump frequency.

■ d3-03: Jump Frequency 3

No. (Hex.)	Name	Description	Default (Range)
d3-03 (0296)	Jump Frequency 3	<div style="display: flex; gap: 5px;"> V/f OLV OLV/PM AOLV/PM EZOLV </div> Sets the median value of the frequency band that the drive will avoid.	0.0 Hz (Determined by A1-02)

Note:

Set this parameter to 0.0 Hz to disable the Jump frequency.

■ d3-04: Jump Frequency Width

No. (Hex.)	Name	Description	Default (Range)
d3-04 (0297)	Jump Frequency Width	<div style="display: flex; gap: 5px;"> V/f OLV OLV/PM AOLV/PM EZOLV </div> Sets the width of the frequency band that the drive will avoid.	1.0 Hz (Determined by A1-02)

◆ d4: Frequency Ref Up/Down & Hold

The *d4 parameters* set the Frequency Reference Hold function and Up/Down and Up/Down 2 commands.

- Frequency Reference Hold Function Command: This acceleration/deceleration ramp hold command uses an MFDI to momentarily stop the acceleration/deceleration of the motor, and continues to operate the motor at the output frequency at which the command reference was input. Turn OFF the acceleration/deceleration ramp hold command to continue acceleration/deceleration.
- Up/Down command: The Up/Down command is a function to activate and deactivate an MFDI to increase and decrease the frequency reference. The Up/Down command overrides frequency references from the analog input terminal, pulse train input terminal, and keypad.
- Up/Down 2 command: The Up/Down 2 command is a function that adds a set bias value to the frequency reference to accelerate or decelerate. The Up/Down 2 command activates and deactivates the MFDI to add a bias value.

■ d4-01: Freq Reference Hold Selection

No. (Hex.)	Name	Description	Default (Range)
d4-01 (0298)	Freq Reference Hold Selection	<div style="display: flex; gap: 5px;"> V/f OLV OLV/PM AOLV/PM EZOLV </div> Sets the function that saves the frequency reference or the frequency bias (Up/Down 2) after a Stop command or when de-energizing the drive.	0 (0, 1)

Set *HI-xx* [MFDI Function Selection] to one of these values to enable this parameter:

- *A* [Accel/Decel Ramp Hold]
- *10/11* [Up/Down Command]
- *75/76* [Up/Down 2 Command]

0 : Disabled

- Acceleration/Deceleration Ramp Hold
When you enter a Stop command or de-energize the drive, the hold value is reset to 0 Hz. The drive will use the active frequency reference when it restarts.
- Up/Down Command
When you enter a Stop command or de-energize the drive, the frequency reference value is reset to 0 Hz. The drive will start from 0 Hz when it restarts.
- Up/Down 2 Command
When you enter the Stop command or 5 s after you release the Up/Down 2 command, the drive does not save the frequency bias. The Up/Down 2 function will start with a bias of 0% when the drive restarts.

1 : Enabled

- Acceleration/Deceleration Ramp Hold
When you clear the Run command or de-energize the drive, it will save the last hold value. The drive will use the saved value as the frequency reference when it restarts.

Note:

When you energize the drive, continuously enable the MFDI terminal set for *Accel/Decel Ramp Hold* [*HI-xx = A*]. If the digital input does not activate, the drive will clear the hold value and set it to 0 Hz.

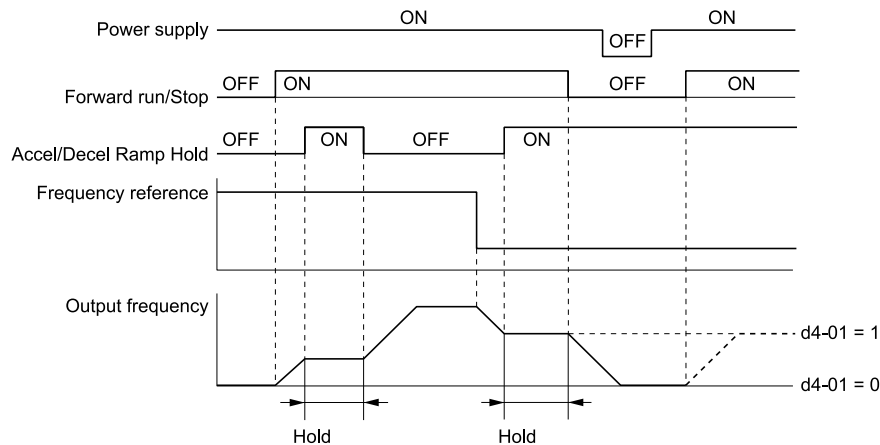

Figure 2.46 Frequency Reference Hold with Accel/Decel Hold Function

- Up/Down Command
When you clear the Run command or de-energize the drive, it will save the frequency reference value. The drive will use the saved value as the frequency reference when it restarts.
- Up/Down 2 Command with Frequency Reference from Keypad
When a Run command is active and you release the Up/Down 2 command for longer than 5 s, the drive adds the Up/Down 2 bias value to the frequency reference and sets it to 0. The drive saves the frequency reference value to which the bias value was added. The drive will use the new value as the frequency reference when it restarts.

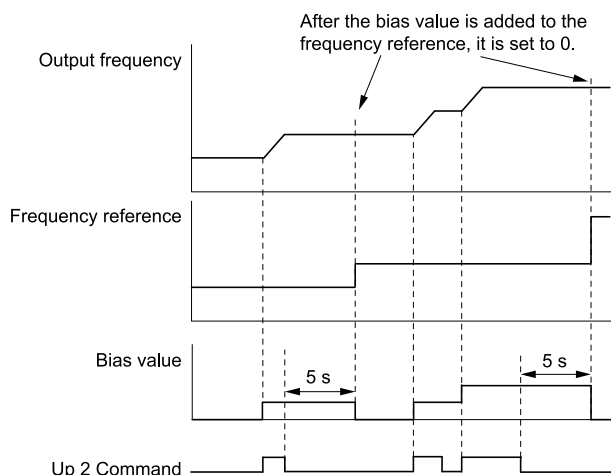

Figure 2.47 Up/Down 2 Example with Reference from Keypad and d4-01 = 1

- Up/Down 2 Command with Frequency Reference from Input Sources Other Than the Keypad
When a Run command is active and you release the Up/Down 2 command for longer than 5 s, the drive will save the bias value in *d4-06* [*Frequency Ref Bias (Up/Down 2)*]. The drive saves the frequency reference + *d4-06* as a frequency reference value. The drive will use the new value as the frequency reference when it restarts.

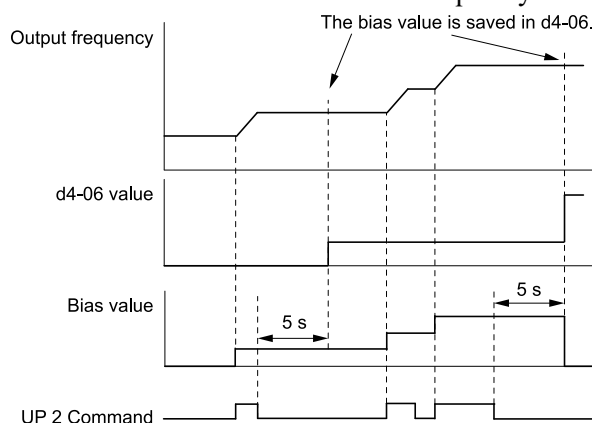

Figure 2.48 Up/Down 2 Example with Other Reference than Keypad and d4-01 = 1

Note:

To use the combination of the frequency reference hold function and the Up/Down 2 function, configure the Up/Down 2 upper limit [*d4-08*] and lower limit [*d4-09*] correctly.

Remove the Saved Frequency Reference Value

The procedure to remove the saved frequency reference value is different for different functions. Use these methods to remove the value:

- Release the input programmed for *Accel/Decel Ramp Hold* [*HI-xx = A*].
- Set an Up or Down command while no Run command is active.
- Use the Up/Down 2 Command to set *d4-06* = 0.0 or set *d4-06* = 0.0 during stop.

■ d4-03: Up/Down 2 Bias Step Frequency

No. (Hex.)	Name	Description	Default (Range)
d4-03 (02AA) RUN	Up/Down 2 Bias Step Frequency	V/f OLV OLV/PM AOLV/PM EZOLV Sets the bias that the Up/Down 2 function adds to or subtracts from the frequency reference.	0.00 Hz (0.00 - 99.99 Hz)

The operation is different for different setting values:

- **Setting d4-03 = 0.00 Hz**

When the *Up/Down 2 Command* [$H1-xx = 75, 76$] is active, the drive uses the accel/decel times set in $d4-04$ [*Up/Down 2 Ramp Selection*] to increase or decrease the bias value.

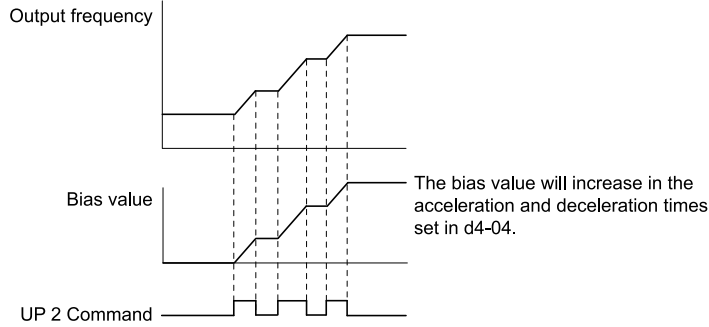

Figure 2.49 Up/Down 2 Bias when $d4-03 = 0.00$ Hz

• **Setting $d4-03 \neq 0.00$ Hz**

When the *Up/Down 2 Command* [$H1-xx = 75, 76$] is active, the drive increases or decreases the bias in steps for the value set in $d4-03$. The drive uses the acceleration and deceleration times set in $d4-04$.

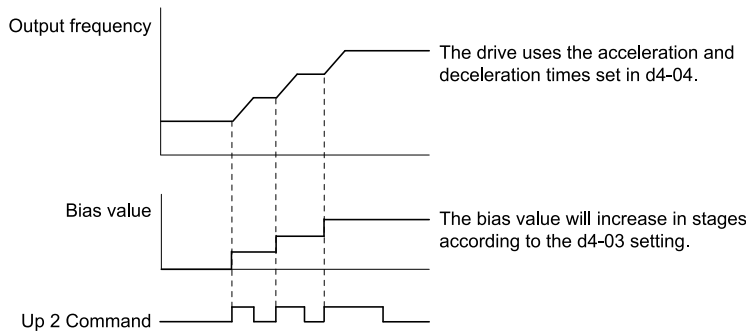

Figure 2.50 Up/Down 2 Bias when $d4-03 \neq 0.00$ Hz

■ **d4-04: Up/Down 2 Ramp Selection**

No. (Hex.)	Name	Description	Default (Range)
d4-04 (02AB) RUN	Up/Down 2 Ramp Selection	<input type="radio"/> V/f <input type="radio"/> OLV <input type="radio"/> OLV/IPM <input type="radio"/> AOL/IPM <input type="radio"/> EZOLV Sets the acceleration and deceleration times for the Up/Down 2 function to apply the bias to the frequency reference.	0 (0, 1)

0 : Use Selected Accel/Decel Time

Use the active acceleration and deceleration times to increase or decrease the bias.

1 : Use Accel/Decel Time 4

Use $C1-07$ [*Acceleration Time 4*] and $C1-08$ [*Deceleration Time 4*] to increase or decrease the bias.

■ **d4-05: Up/Down 2 Bias Mode Selection**

No. (Hex.)	Name	Description	Default (Range)
d4-05 (02AC) RUN	Up/Down 2 Bias Mode Selection	<input type="radio"/> V/f <input type="radio"/> OLV <input type="radio"/> OLV/IPM <input type="radio"/> AOL/IPM <input type="radio"/> EZOLV Sets the function that saves the bias value to the drive when you open or close the two <i>Up/Down 2 Commands</i> [$H1-xx = 75, 76$]. Set $d4-03$ [<i>Up/Down 2 Bias Step Frequency</i>] = 0.00 before you set this parameter.	0 (0, 1)

0 : Hold when Neither Up/Down Closed

When the two MFDI terminals set for *Up/Down 2 Command* [$H1-xx = 75, 76$] activate or deactivate, the drive will hold the bias value.

1 : Reset when Neither / Both Closed

When the two MFDI terminals set for *Up/Down 2 Command* [$H1-xx = 75, 76$] activate or deactivate, the drive will reset the bias value to 0. The drive will use the acceleration and deceleration times set in *d4-04* [*Up/Down 2 Ramp Selection*] to accelerate and decelerate the motor to the selected output frequency.

■ d4-06: Frequency Ref Bias (Up/Down 2)

No. (Hex.)	Name	Description	Default (Range)
d4-06 (02AD)	Frequency Ref Bias (Up/Down 2)	V/f OLV OLV/PM AOLV/PM EZOLV Saves the bias value from the Up/Down 2 Command where the Maximum Output Frequency is 100%.	0.0% (-99.9 - +100.0%)

The Up/Down 2 function setting changes the function of *d4-06*:

Note:

When the keypad sets the frequency reference, you do not usually use parameter *d4-06*.

- When $d4-01 = 0$ [*Freq Reference Hold Selection = Disabled*] and a source other than the keypad sets the frequency reference, the drive adds the value set in *d4-06* to the frequency reference. If the value set in *d4-06* is a negative number, the drive will subtract it from frequency reference.
- When $d4-01 = 1$ [*Enabled*] and a source other than the keypad sets the frequency reference, the drive will store the bias value adjusted with the Up/Down 2 command in *d4-06* 5 seconds after you release the Up/Down 2 command. The drive adds or subtracts the value set in *d4-06* to the frequency reference.

Conditions that Reset or Disable d4-06

The drive resets and disables the bias value in these conditions:

- $d4-01 = 0$ and the Run command was cleared.
- $H1-xx = 75, 76$ [*MFDI Function Select = Up/Down 2 Command*] is not set.
- The frequency reference source was changed.
This includes switching LOCAL/REMOTE and multi-step speed reference.
- A digital input changed the frequency reference value.
- $d4-03$ [*Up/Down 2 Bias Step Frequency*] = 0 and $d4-05 = 1$ [*Up/Down 2 Bias Mode Selection = Reset when Neither / Both Closed*], and the two MFDI terminals set for *Up/Down 2 Command* [$H1-xx = 75/76$] are activated or deactivated.
- The value of *E1-04* [*Maximum Output Frequency*] was changed.

■ d4-07: Analog Freq Ref Fluctuate Limit

No. (Hex.)	Name	Description	Default (Range)
d4-07 (02AE) RUN	Analog Freq Ref Fluctuate Limit	V/f OLV OLV/PM AOLV/PM EZOLV If the frequency reference changes for more than the level set to this parameter, then the bias value will be held. The value is set as a percentage of the Maximum Output Frequency.	1.0% (0.1 - 100.0%)

Handles frequency reference changes while *Up/Down 2 Command* [$H1-xx = 75, 76$] is activated. When the frequency reference changes for more than the level set in *d4-07*, the drive will hold the bias value, and the drive will accelerate or decelerate to the frequency reference. When the drive is at the frequency reference, it releases the bias hold and the bias follows the Up/Down 2 input commands.

This parameter is applicable only when an analog or pulse input sets the frequency reference.

■ d4-08: Up/Down 2 Bias Upper Limit

No. (Hex.)	Name	Description	Default (Range)
d4-08 (02AF) RUN	Up/Down 2 Bias Upper Limit	V/f OLV OLV/PM AOLV/PM EZOLV Sets the upper limit of the Up/Down 2 bias as a percentage of the Maximum Output Frequency.	100.0% (0.0 - 100.0%)

The drive saves the set bias upper limit in *d4-06* [*Frequency Ref Bias (Up/Down 2)*]. Set *d4-08* an applicable value before you use the Up/Down 2 function.

Note:

When $d4-01 = 1$ [*Freq Reference Hold Selection = Enabled*] and $b1-01 = 0$ [*Frequency Reference Selection 1 = Keypad*], the drive will add the bias value to the frequency reference when it does not receive an Up/Down 2 command for 5 s. Then the drive will reset the value to 0 at which time you can increase the bias to the limit set in $d4-08$ again.

■ d4-09: Up/Down 2 Bias Lower Limit

No. (Hex.)	Name	Description	Default (Range)
d4-09 (02B0) RUN	Up/Down 2 Bias Lower Limit	V/f OLV OLV/PM AOLV/PM EZOLV Sets the lower limit of the Up/Down 2 bias as a percentage of the Maximum Output Frequency.	0.0% (-99.9 - 0.0%)

The drive saves the set bias lower limit in $d4-06$ [*Frequency Ref Bias (Up/Down 2)*]. Set $d4-09$ to an applicable value before you use the Up/Down 2 function.

Note:

When $d4-01 = 1$ [*Freq Reference Hold Selection = Enabled*] and $b1-01 = 0$ [*Frequency Reference Selection 1 = Keypad*], the drive will add the bias value to the frequency reference when it does not receive an Up/Down 2 command for 5 s. Then the drive will reset the value to 0.

If you increase the bias with the Up 2 command and $d4-09 = 0$, you cannot use a Down 2 command to decrease the frequency reference. To decrease speed in this condition, set a negative lower limit in $d4-09$.

■ d4-10: Up/Down Freq Lower Limit Select

No. (Hex.)	Name	Description	Default (Range)
d4-10 (02B6)	Up/Down Freq Lower Limit Select	V/f OLV OLV/PM AOLV/PM EZOLV Sets the lower frequency limit for the Up/Down function.	0 (0, 1)

0 : Greater of d2-02 or Analog

The higher value between $d2-02$ [*Frequency Reference Lower Limit*] and an analog input programmed for *Frequency Reference* [$H3-02, H3-10 = 0$] sets the lower frequency reference limit.

Note:

When you use *External Reference 1/2 Selection* [$H1-xx = 2$] to switch between the Up/Down function and an analog input as the reference source, the analog value becomes the lower reference limit when the Up/Down command is active. Set $d4-10 = 1$ to isolate the Up/Down function and the analog input value.

1 : d2-02

You can only use $d2-02$ to set the lower limit of the frequency reference.

◆ d6: Field Weakening /Forcing

$d6$ parameters set the field weakening and field forcing functions.

The field weakening function decreases the energy consumption of the motor. It decreases the output voltage of the drive to a set level. The function decreases the motor excitation current inversely proportional to speed in a constant output range, and does not let the induced voltage of the motor become more than the power supply voltage. To enable this function, set *Field Weakening* [$H1-xx = 63$] ON.

Note:

Use the Field Weakening function in constant light-load applications. To control the energy consumption of the motor for other load conditions, use the $b8$ parameters [*Energy Saving*].

The Field Forcing function adjusts the delaying influence of the motor time constant when the drive changes the excitation current reference and it also increases motor responsiveness. This function uses a high motor excitation current reference for drive start-up only to help develop actual motor excitation current. Enable the Field Forcing function to increase motor responsiveness.

Note:

You cannot use Field Forcing during DC Injection Braking.

■ d6-01: Field Weakening Level

No. (Hex.)	Name	Description	Default (Range)
d6-01 (02A0)	Field Weakening Level	<div style="display: flex; gap: 5px;"> V/f OLV OLV/PM AOLV/PM EZOLV </div> Sets the drive output voltage as a percentage of <i>E1-05 [Maximum Output Voltage]</i> when <i>H1-xx = 63 [Field Weakening]</i> is activated.	80% (0 - 100%)

■ d6-02: Field Weakening Frequency Limit

No. (Hex.)	Name	Description	Default (Range)
d6-02 (02A1)	Field Weakening Frequency Limit	<div style="display: flex; gap: 5px;"> V/f OLV OLV/PM AOLV/PM EZOLV </div> Sets the minimum output frequency to start field weakening.	0.0 Hz (0.0 - 590.0 Hz)

Make sure that these two conditions are correct to enable the Field Weakening command:

- The output frequency \geq *d6-02*.
- There is a speed agreement status.

■ d6-03: Field Forcing Selection

No. (Hex.)	Name	Description	Default (Range)
d6-03 (02A2)	Field Forcing Selection	<div style="display: flex; gap: 5px;"> V/f OLV OLV/PM AOLV/PM EZOLV </div> Sets the field forcing function.	0 (0, 1)

0 : Disabled

1 : Enabled

■ d6-06: Field Forcing Limit

No. (Hex.)	Name	Description	Default (Range)
d6-06 (02A5)	Field Forcing Limit	<div style="display: flex; gap: 5px;"> V/f OLV OLV/PM AOLV/PM EZOLV </div> Sets the limit value for field forcing to increase the motor excitation current reference as a percentage of <i>E2-03 [Motor No-Load Current]</i> . Usually it is not necessary to change this setting.	400% (100 - 400%)

Note:

You cannot use Field Forcing during DC Injection Braking.

◆ d7: Offset Frequency

The drive will use 3 digital signal inputs to add or subtract the set frequency (offset frequency) to/from the frequency reference and correct the speed. The drive uses the terminal set in *H1-xx = 44 to 46 [MFDI Function Selection = Add Offset Frequency 1 (d7-01) to Add Offset Frequency 3 (d7-03)]* to set the offset frequency. When you close more than one input at the same time, the drive adds the selected offset values together.

Figure 2.51 shows the Offset frequency function:

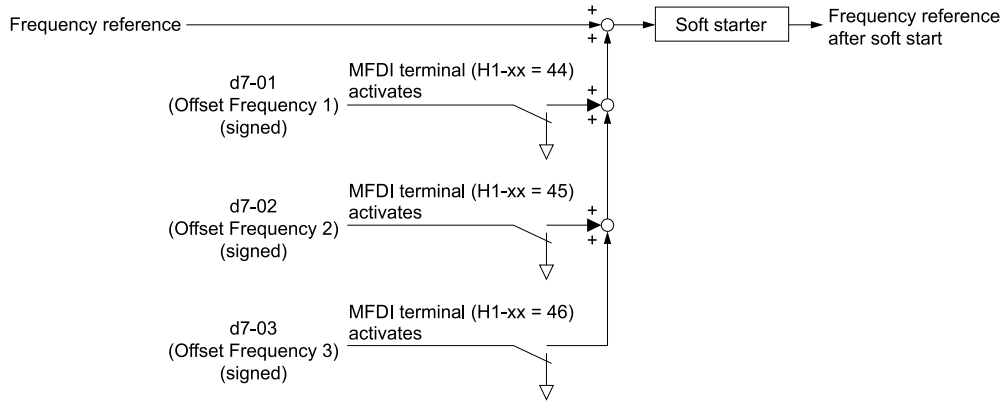

Figure 2.51 Offset Frequency Operation

■ d7-01: Offset Frequency 1

No. (Hex.)	Name	Description	Default (Range)
d7-01 (02B2) RUN	Offset Frequency 1	V/f OLV OLV/PM AOLV/PM EZOLV Uses H1-xx = 44 [MFDI Function Select = Add Offset Frequency 1 (d7-01)] as a percentage of the Maximum Output Frequency to add or subtract the set frequency to/from the frequency reference.	0.0% (-100.0 - +100.0%)

■ d7-02: Offset Frequency 2

No. (Hex.)	Name	Description	Default (Range)
d7-02 (02B3) RUN	Offset Frequency 2	V/f OLV OLV/PM AOLV/PM EZOLV Uses H1-xx = 45 [MFDI Function Select = Add Offset Frequency 2 (d7-02)] as a percentage of the Maximum Output Frequency to add or subtract the set frequency to/from the frequency reference.	0.0% (-100.0 - +100.0%)

■ d7-03: Offset Frequency 3

No. (Hex.)	Name	Description	Default (Range)
d7-03 (02B4) RUN	Offset Frequency 3	V/f OLV OLV/PM AOLV/PM EZOLV Uses H1-xx = 46 [MFDI Function Select = Add Offset Frequency 3 (d7-03)] as a percentage of the Maximum Output Frequency to add or subtract the set frequency to/from the frequency reference.	0.0% (-100.0 - +100.0%)

2.6 E: Motor Parameters

E parameters cover drive input voltage, V/f pattern, and motor parameters.

◆ E1: V/f Pattern for Motor 1

E1 parameters set the drive input voltage and motor V/f characteristics. To switch drive operation from one motor to another motor, set the V/f characteristics for motor 1.

■ V/f Pattern Settings

The drive uses a V/f pattern to adjust the output voltage relative to the frequency reference.

This product has been preconfigured with 15 voltage/frequency (V/f) patterns. Use *E1-03 [V/f Pattern Selection]* to select the V/f pattern that is appropriate for the application.

Additionally, one custom V/f pattern is available. Set *E1-03 = F [Custom]* and then manually set parameters *E1-04* to *E1-10*.

Table 2.36 Predefined V/f Patterns

Setting Value	Specification	Characteristic	Application
0	Const Trq, 50Hz base, 50Hz max	Constant torque	For general purpose applications. This pattern is used when the load torque is constant without any rotation speed such as that used for linear conveyor systems.
1	Const Trq, 60Hz base, 60Hz max		
2	Const Trq, 50Hz base, 60Hz max		
3	Const Trq, 60Hz base, 72Hz max		
4	VT, 50Hz, 65% Vmid reduction	Derated Torque characteristics	This pattern is used for torque loads proportional to 2 or 3 times the rotation speed, such as is the case with fans and pumps.
5	VT, 50Hz, 50% Vmid reduction		
6	VT, 60Hz, 65% Vmid reduction		
7	VT, 60Hz, 50% Vmid reduction		
8	High Trq, 50 Hz, 25% Vmin boost	High starting torque	This pattern is used when strong torque is required during startup.
9	High Trq, 50 Hz, 65% Vmin boost		
A	High Trq, 60 Hz, 25% Vmin boost		
B	High Trq, 60 Hz, 65% Vmin boost		
C	High Freq, 60Hz base, 90Hz max	Constant output	This pattern is used to rotate motors at greater than 60 Hz. Output voltage is constant when operating at greater than 60 Hz.
D	High Freq, 60Hz base, 120Hz max		
E	High Freq, 60Hz base, 180Hz max		
F	Custom	Constant torque	Enables a custom V/f pattern by changing <i>E1-04</i> to <i>E1-13 [V/f Pattern for Motor 1]</i> . The default settings for <i>E1-04</i> to <i>E1-13</i> are the same as <i>Setting Value 1 [Const Trq, 60Hz base, 60Hz max]</i> .

Note:

When you manually set V/f patterns, note these items:

- To set linear V/f characteristics at frequencies lower than E1-06 [Base Frequency], set E1-07 = E1-09 [Mid Point A Frequency = Minimum Output Frequency]. In this application, the drive ignores E1-08 [Mid Point A Voltage].
- Set the five frequencies as specified by these rules: Incorrect settings will cause oPE10 [V/f Data Setting Error].
 $E1-09 \leq E1-07 < E1-06 \leq E1-11 \leq E1-04$ [Minimum Output Frequency \leq Mid Point A Frequency $<$ Base Frequency \leq Mid Point B Frequency \leq Maximum Output Frequency]
- Setting E1-11 = 0 [Mid Point B Frequency = 0 Hz] disables E1-12 [Mid Point B Voltage]. Ensure that the four frequencies are set according to the following rules;
 $E1-09 \leq E1-07 < E1-06 \leq E1-04$
- When you use A1-03 [Initialize Parameters] to initialize the drive, it will not reset E1-03.

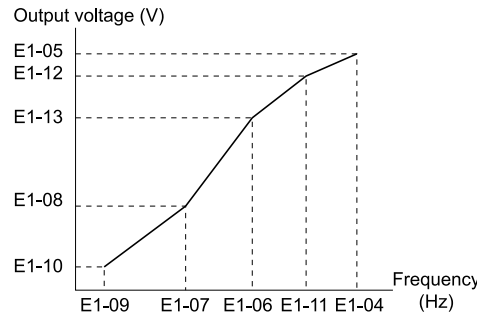

Figure 2.52 V/f Pattern

■ **E1-01: Input AC Supply Voltage**

No. (Hex.)	Name	Description	Default (Range)
E1-01 (0300)	Input AC Supply Voltage	V/f OLV OLV/PM AOLV/PM EZOLV Sets the drive input voltage.	200 V Class: 240 V, 400 V Class: 480 V (200 V Class: 155 to 255 V, 400 V Class: 310 to 510 V)

NOTICE: Damage to Equipment. Set E1-01 [Input AC Supply Voltage] to align with the drive input voltage (not motor voltage). If this parameter is incorrect, the protective functions of the drive will not operate correctly and it can cause damage to the drive.

Values Related to the Drive Input Voltage

The value set in E1-01 is the base value that the drive uses for the motor protective functions in Table 2.37. With a 400 V class drive, the detection level changes for some motor protective functions.

Table 2.37 Values Related to the Drive Input Voltage

Voltage	E1-01 Setting	Approximate Values				
		ov Detection Level	BTR Operation Level (rr Detection Level)*1	L2-05 [Undervoltage Detection Lvl (Uv1)]	L2-11 [KEB DC Bus Voltage Setpoint]	L3-17 [DC Bus Regulation Level]
200 V Class	All settings	410 V	394 V	190 V	260 V	375 V
400 V Class	Setting value \geq 400 V	820 V	788 V	380 V	500 V	750 V
	Setting value $<$ 400 V	820 V	788 V	350 V	460 V	750 V

*1 This is the protection function enabled in drives with built-in braking transistors. These values show the level that will trigger the built-in braking transistor. Refer to "YASKAWA AC Drive Series Option Braking Unit and Braking Resistor Unit Installation Manual (TOBPC72060001)" for more information.

■ **E1-03: V/f Pattern Selection**

No. (Hex.)	Name	Description	Default (Range)
E1-03 (0302)	V/f Pattern Selection	V/f OLV OLV/PM AOLV/PM EZOLV Sets the V/f pattern for the drive and motor. You can use one of the preset patterns or you can make a custom pattern.	F (Determined by A1-02)

Note:

- When $A1-02 = 2$ [Control Method Selection = OLV], settings 0 to E are not available.
- Set the correct V/f pattern for the application and operation area. An incorrect V/f pattern can decrease motor torque and increase current from overexcitation.
- Parameter $A1-03$ [Initialize Parameters] will not reset the value of $E1-03$.

0 : Const Trq, 50Hz base, 50Hz max

Use this constant torque pattern for general applications. This pattern is used when the load torque is constant without any rotation speed such as that used for linear conveyor systems.

Note:

The voltage values in the figures are for 200 V class drives. Multiply the values by 2 for 400 V class drives.

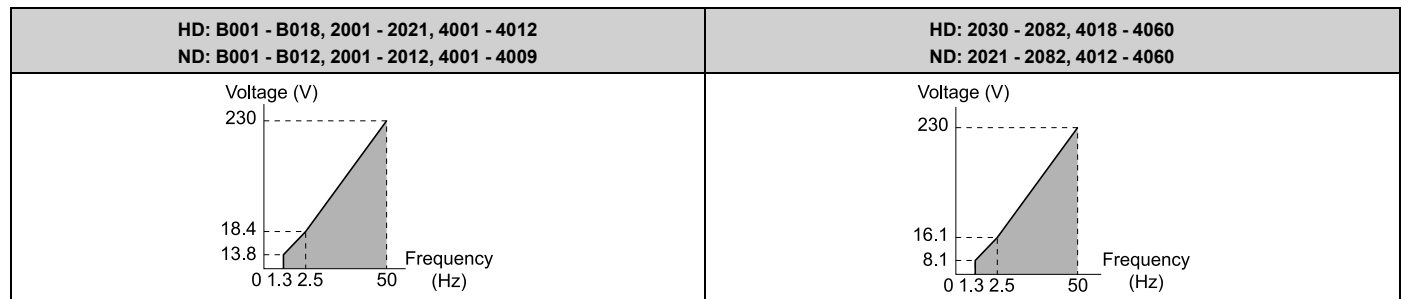
**1 : Const Trq, 60Hz base, 50Hz max**

Use this constant torque pattern for general applications. This pattern is used when the load torque is constant without any rotation speed such as that used for linear conveyor systems.

Note:

The voltage values in the figures are for 200 V class drives. Multiply the values by 2 for 400 V class drives.

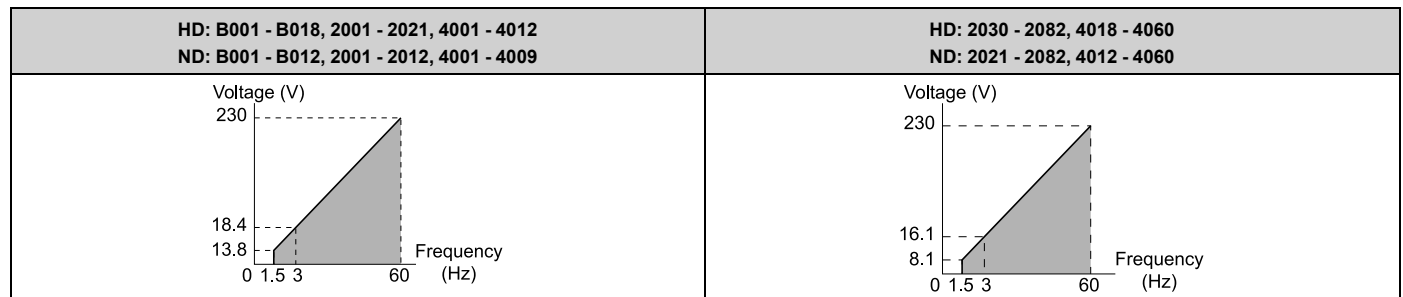
**2 : Const Trq, 50Hz base, 60Hz max**

Use this constant torque pattern for general applications. This pattern is used when the load torque is constant without any rotation speed such as that used for linear conveyor systems.

Note:

The voltage values in the figures are for 200 V class drives. Multiply the values by 2 for 400 V class drives.

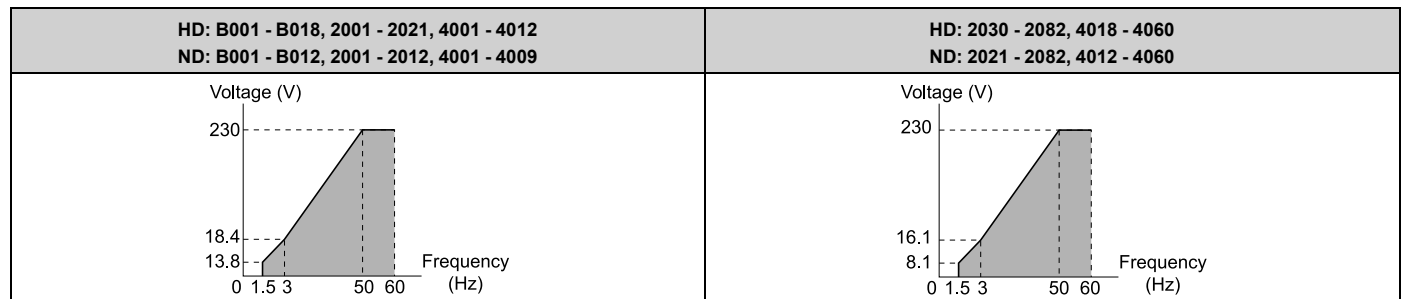
**3 : Const Trq, 60Hz base, 72Hz max**

Use this constant torque pattern for general applications. This pattern is used when the load torque is constant without any rotation speed such as that used for linear conveyor systems.

2.6 E: Motor Parameters

Note:

The voltage values in the figures are for 200 V class drives. Multiply the values by 2 for 400 V class drives.

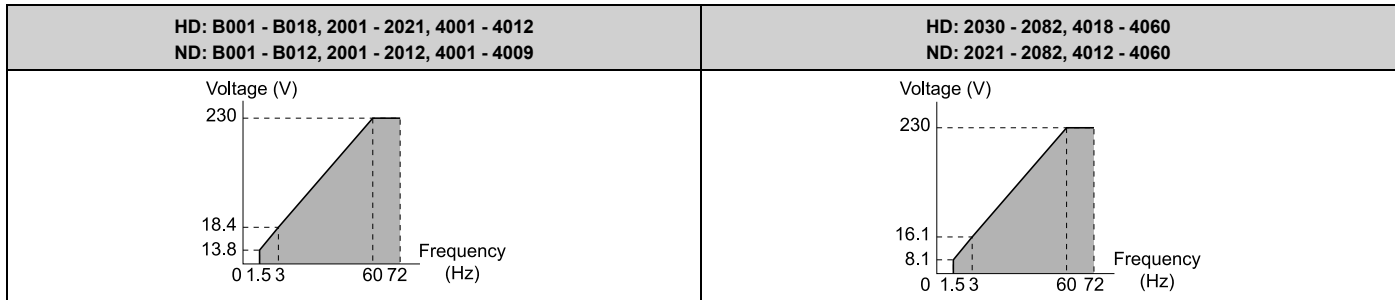

4 : VT, 50Hz, 65% Vmid reduction

Use this derated torque pattern for torque loads proportional to three times the rotation speed. For example, fans and pumps.

Note:

The voltage values in the figures are for 200 V class drives. Multiply the values by 2 for 400 V class drives.

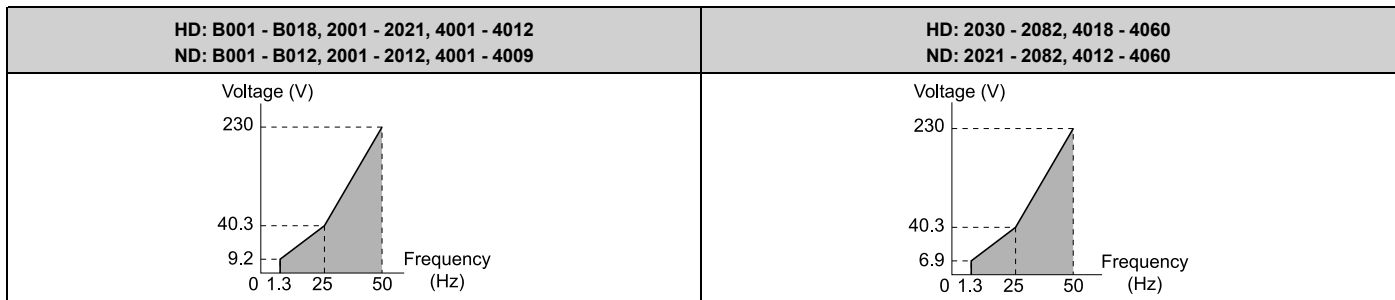

5 : VT, 50Hz, 50% Vmid reduction

Use this derated torque pattern for torque loads proportional to two times the rotation speed. For example, fans and pumps.

Note:

The voltage values in the figures are for 200 V class drives. Multiply the values by 2 for 400 V class drives.

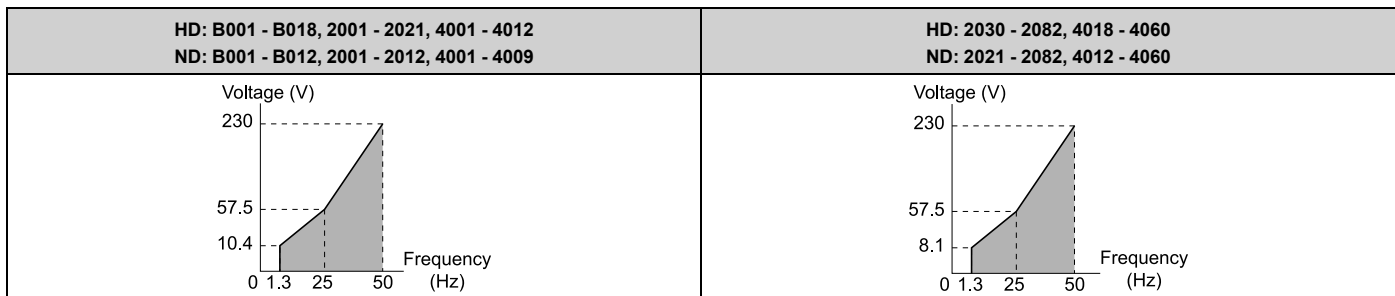

6 : VT, 60Hz, 65% Vmid reduction

Use this derated torque pattern for torque loads proportional to three times the rotation speed. For example, fans and pumps.

Note:

The voltage values in the figures are for 200 V class drives. Multiply the values by 2 for 400 V class drives.

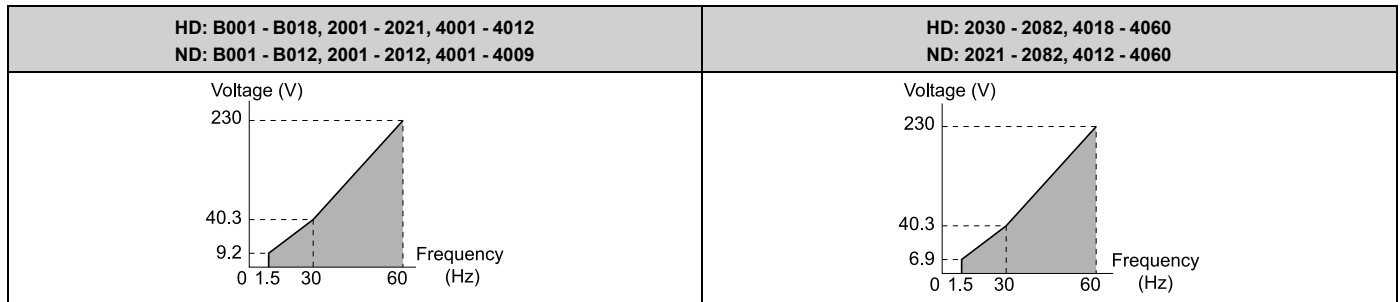

7 : VT, 60Hz, 50% Vmid reduction

Use this derated torque pattern for torque loads proportional to two times the rotation speed. For example, fans and pumps.

Note:

The voltage values in the figures are for 200 V class drives. Multiply the values by 2 for 400 V class drives.

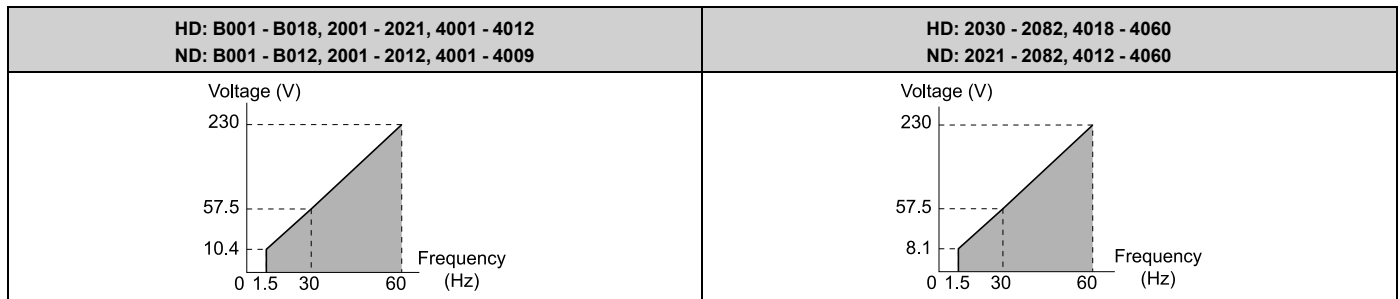

8 : High Trq, 50 Hz, 25% Vmin Boost

Use this pattern when moderate torque is necessary during start up.

Select this pattern only in these conditions:

- The wiring distance between the drive and motor is 150 m (492.1 ft) minimum
- There is an AC reactor connected to the drive output.

Note:

The voltage values in the figures are for 200 V class drives. Multiply the values by 2 for 400 V class drives.

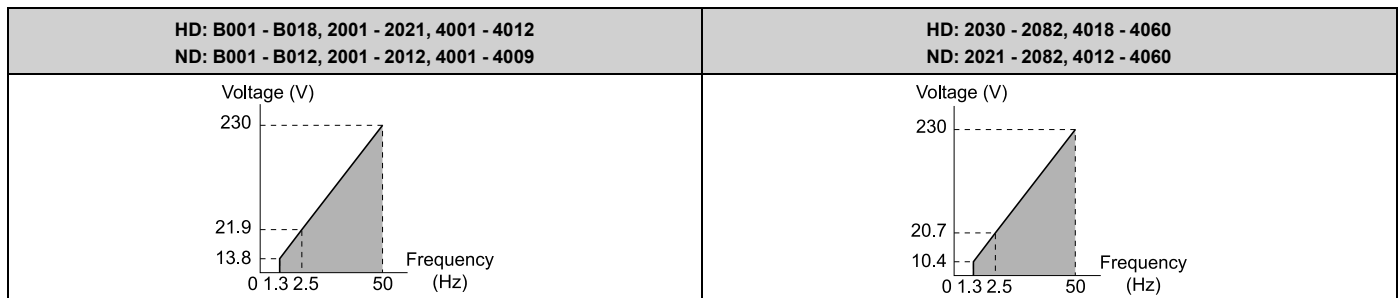

9 : High Trq, 50 Hz, 65% Vmin Boost

Use this pattern when high torque is necessary during start up.

Select this pattern only in these conditions:

- The wiring distance between the drive and motor is 150 m (492.1 ft) minimum
- There is an AC reactor connected to the drive output.

Note:

The voltage values in the figures are for 200 V class drives. Multiply the values by 2 for 400 V class drives.

2.6 E: Motor Parameters

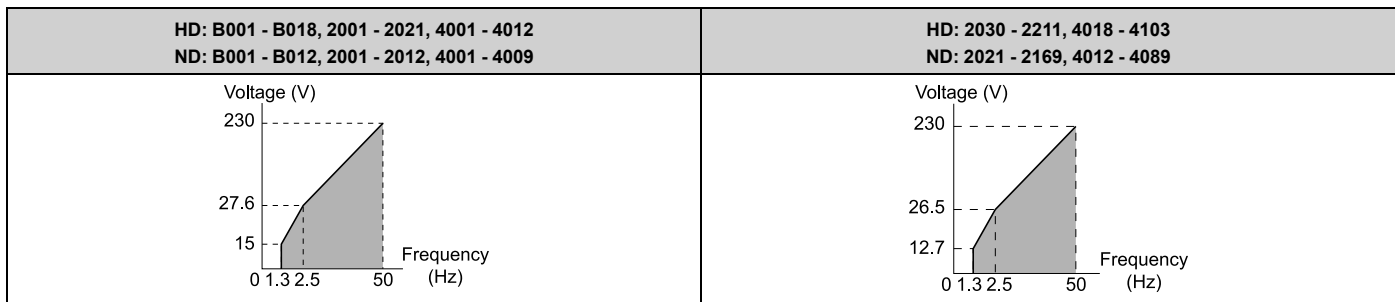

A : High Trq, 60 Hz, 25% Vmin Boost

Use this pattern when moderate torque is necessary during start up.

Select this pattern only in these conditions:

- The wiring distance between the drive and motor is 150 m (492.1 ft) minimum
- There is an AC reactor connected to the drive output.

Note:

The voltage values in the figures are for 200 V class drives. Multiply the values by 2 for 400 V class drives.

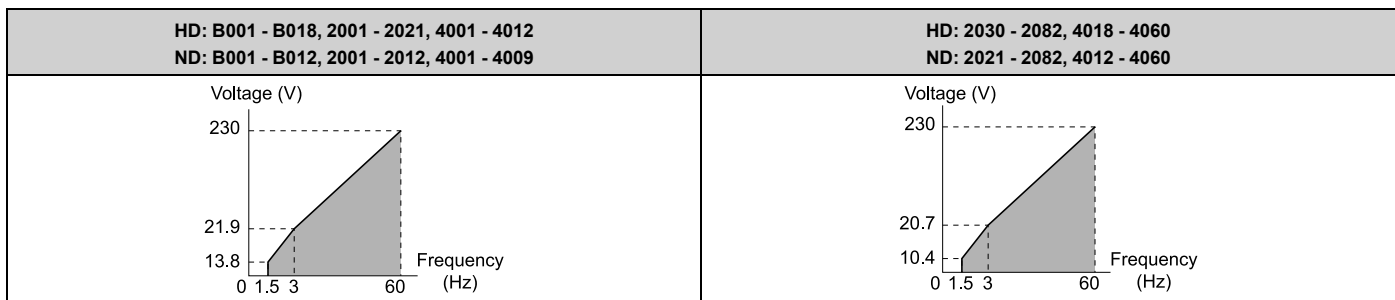

B : High Trq, 60 Hz, 65% Vmin Boost

Use this pattern when high torque is necessary during start up.

Select this pattern only in these conditions:

- The wiring distance between the drive and motor is 150 m (492.1 ft) minimum
- There is an AC reactor connected to the drive output.

Note:

The voltage values in the figures are for 200 V class drives. Multiply the values by 2 for 400 V class drives.

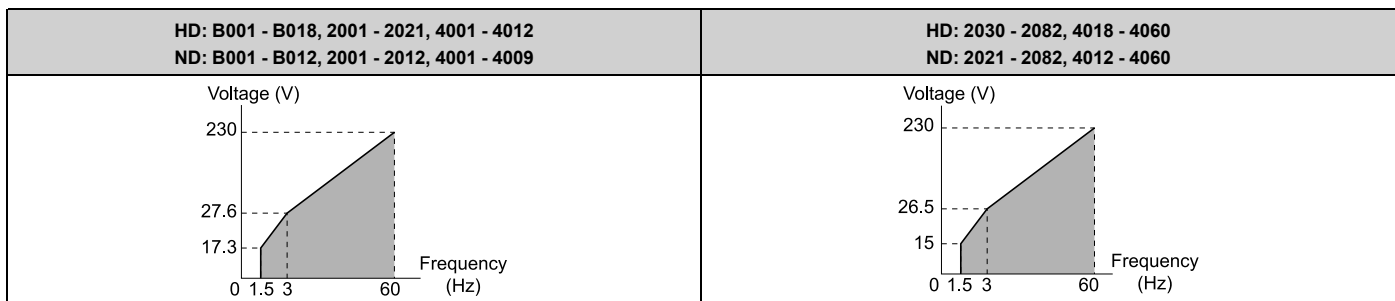

C : Const Trq, 60Hz base, 90Hz max

Use this constant output pattern to rotate motors at more than 60 Hz. Output voltage is constant when you operate at more than 60 Hz.

Note:

The voltage values in the figures are for 200 V class drives. Multiply the values by 2 for 400 V class drives.

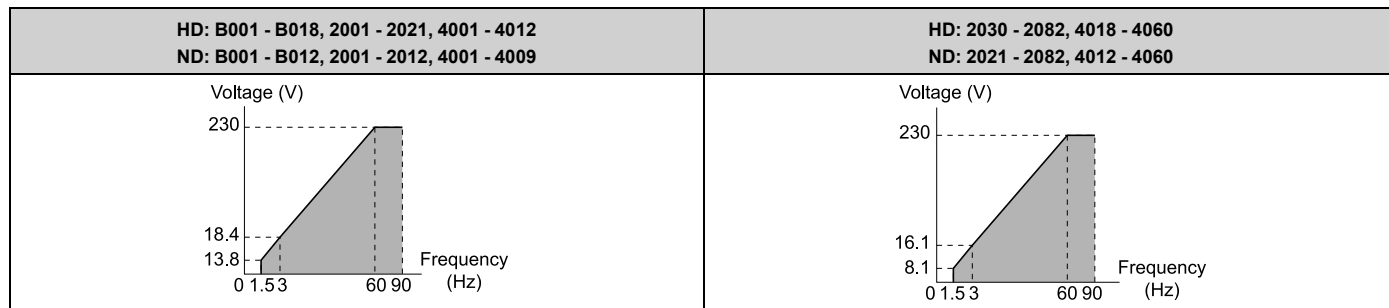

D : Const Trq, 60Hz base, 120Hz max

Use this constant output pattern to rotate motors at more than 60 Hz. Output voltage is constant when you operate at more than 60 Hz.

Note:

The voltage values in the figures are for 200 V class drives. Multiply the values by 2 for 400 V class drives.

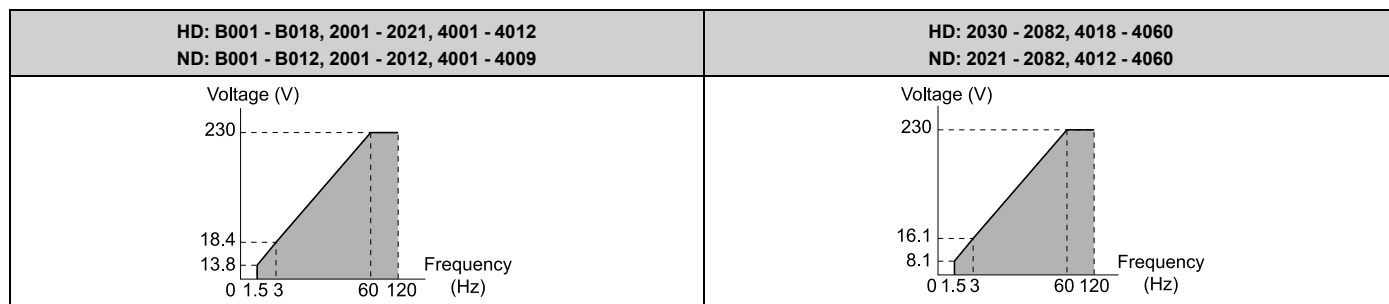

E : Const Trq, 60Hz base, 180Hz max

Use this constant output pattern to rotate motors at more than 60 Hz. Output voltage is constant when you operate at more than 60 Hz.

Note:

The voltage values in the figures are for 200 V class drives. Multiply the values by 2 for 400 V class drives.

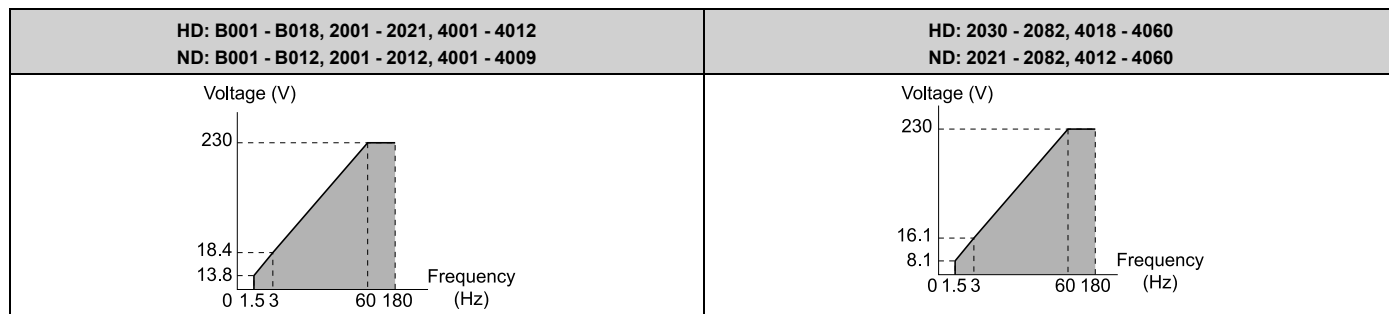

F : Custom

Set E1-04 to E1-13 [V/f Pattern for Motor 1] to set the values for this custom pattern.

The default settings are the same as Setting Value 1 [Const Trq, 60Hz base, 60Hz max].

E1-04: Maximum Output Frequency

No. (Hex.)	Name	Description	Default (Range)
E1-04 (0303)	Maximum Output Frequency	V/f OLV OLV/PM AOLV/PM EZOLV <p style="margin-top: 5px; font-size: small;">Sets the maximum output frequency for the V/f pattern.</p>	Determined by A1-02 and E5-01 (Determined by A1-02 and E5-01)

Parameter Details

■ E1-05: Maximum Output Voltage

No. (Hex.)	Name	Description	Default (Range)
E1-05 (0304)	Maximum Output Voltage	<div style="display: flex; gap: 5px;"> V/f OLV OLV/PM AOLV/PM EZOLV </div> Sets the maximum output voltage for the V/f pattern.	200 V Class: 230.0 V, 400 V: 460.0 V (200 V Class: 0.0 - 255.0 V, 400 V Class: 0.0 - 510.0 V)

■ E1-06: Base Frequency

No. (Hex.)	Name	Description	Default (Range)
E1-06 (0305)	Base Frequency	<div style="display: flex; gap: 5px;"> V/f OLV OLV/PM AOLV/PM EZOLV </div> Sets the base frequency for the V/f pattern.	Determined by A1-02 and E5-01 (0.0 - E1-04)

■ E1-07: Mid Point A Frequency

No. (Hex.)	Name	Description	Default (Range)
E1-07 (0306)	Mid Point A Frequency	<div style="display: flex; gap: 5px;"> V/f OLV OLV/PM AOLV/PM EZOLV </div> Sets a middle output frequency for the V/f pattern.	Determined by A1-02 (0.0 - E1-04)

■ E1-08: Mid Point A Voltage

No. (Hex.)	Name	Description	Default (Range)
E1-08 (0307)	Mid Point A Voltage	<div style="display: flex; gap: 5px;"> V/f OLV OLV/PM AOLV/PM EZOLV </div> Sets a middle output voltage for the V/f pattern.	Determined by A1-02, C6-01 and o2-04 (200 V Class: 0.0 - 255.0 V, 400 V Class: 0.0 - 510.0 V)

Note:

Default setting is determined by A1-02 [Control Method Selection], C6-01 [Normal / Heavy Duty Selection], and o2-04 [Drive Model Selection].

■ E1-09: Minimum Output Frequency

No. (Hex.)	Name	Description	Default (Range)
E1-09 (0308)	Minimum Output Frequency	<div style="display: flex; gap: 5px;"> V/f OLV OLV/PM AOLV/PM EZOLV </div> Sets the minimum output frequency for the V/f pattern.	Determined by A1-02 and E5-01 (Determined by A1-02, E1-04, and E5-01)

■ E1-10: Minimum Output Voltage

No. (Hex.)	Name	Description	Default (Range)
E1-10 (0309)	Minimum Output Voltage	<div style="display: flex; gap: 5px;"> V/f OLV OLV/PM AOLV/PM EZOLV </div> Sets the minimum output voltage for the V/f pattern.	Determined by A1-02 (200 V Class: 0.0 to 255.0 V, 400 V Class: 0.0 to 510.0 V)

■ E1-11: Mid Point B Frequency

No. (Hex.)	Name	Description	Default (Range)
E1-11 (030A) Expert	Mid Point B Frequency	<div style="display: flex; gap: 5px;"> V/f OLV OLV/PM AOLV/PM EZOLV </div> Sets a middle output frequency for the V/f pattern.	0.0 Hz (0.0 - E1-04)

Note:

Set this parameter to 0.0 to disable the function.

■ E1-12: Mid Point B Voltage

No. (Hex.)	Name	Description	Default (Range)
E1-12 (030B) Expert	Mid Point B Voltage	<div style="display: flex; gap: 5px;"> V/f OLV OLV/PM AOLV/PM EZOLV </div> Sets a middle point voltage for the V/f pattern.	0.0 V (200 V Class: 0.0 to 255.0 V, 400 V Class: 0.0 to 510.0 V)

Note:

Set this parameter to 0.0 to disable the function.

■ E1-13: Base Voltage

No. (Hex.)	Name	Description	Default (Range)
E1-13 (030C) Expert	Base Voltage	<div style="display: flex; gap: 5px;"> V/f OLV OLV/PM AOLV/PM EZOLV </div> Sets the base voltage for the V/f pattern.	0.0 V (200 V Class: 0.0 - 255.0 V, 400 V Class: 0.0 - 510.0 V)

Note:

- After Auto-Tuning, the value of E1-13 = E1-05 [Maximum Output Voltage].
- When E1-13 = 0.0, use the value of E1-05 to control the voltage.

■ E1-21: No-Load Voltage Adjustment

No. (Hex.)	Name	Description	Default (Range)
E1-21 (1568)	No-Load Voltage Adjustment	<div style="display: flex; gap: 5px;"> V/f OLV OLV/PM AOLV/PM EZOLV </div> Sets the type of Auto-Tuning. Considers T1-13[PM Motor Rated Voltage] FLA] to be 100%.	85.0% (0.0 - 100.0%)

Note:

The default setting is different for different models.

- 85.0%: B001 - B018, 2001 - 2056, 4001 - 4031
- 90.0%: 2070, 2082, 4038 - 4060

◆ E2: Motor Parameters

E2 parameters [Motor Parameters] are used to set induction motor data. To switch drive operation from one motor to another motor, configure the first motor (motor 1).

If Auto-Tuning cannot be performed, set the E2 parameters manually. Performing Auto-Tuning automatically sets the E2 parameters to the optimal values.

Note:

If A1-02 [Control Method Selection] is set to the following control modes, the keypad does not display E2-xx.

- 5 [PM Open Loop Vector]
- 6 [PM Advanced Open Loop Vector]
- 8 [EZ Vector Control]

■ E2-01: Motor Rated Current (FLA)

No. (Hex.)	Name	Description	Default (Range)
E2-01 (030E)	Motor Rated Current (FLA)	<div style="display: flex; gap: 5px;"> V/f OLV OLV/PM AOLV/PM EZOLV </div> Sets the motor rated current in amps.	Determined by o2-04, C6-01 (10% to 200% of the drive rated current)

Note:

- If E2-01 < E2-03 [Motor No-Load Current], the drive will detect oPE02 [Parameter Range Setting Error].
- When the drive model changes, the display units for this parameter also change.
 - 0.01 A: B001 to B018, 2001 to 2042, 4001 to 4023
 - 0.1 A: 2056 to 2082, 4031 to 4060

2.6 E: Motor Parameters

The value set for *E2-01* becomes the reference value for motor protection and the torque limit. Enter the motor rated current written on the motor nameplate. Auto-Tuning the drive will automatically set *E2-01* to the value input for *T1-04* [*Motor Rated Current*].

■ E2-02: Motor Rated Slip

No. (Hex.)	Name	Description	Default (Range)
E2-02 (030F)	Motor Rated Slip	<div style="display: flex; gap: 5px;"> V/f OLV OLV/PM AOLV/PM EZOLV </div> Sets motor rated slip.	Determined by o2-04, C6-01 (0.000 - 20.000 Hz)

This parameter value becomes the base slip compensation value. The drive automatically sets this parameter during Auto-Tuning. When you cannot do Auto-Tuning, calculate the motor rated slip with the information on the motor nameplate and this formula:

$$E2-02 = f - (n \times p) / 120$$

- f: Motor rated frequency (Hz)
- n: Rated motor speed (min^{-1} (r/min))
- p: Number of motor poles

■ E2-03: Motor No-Load Current

No. (Hex.)	Name	Description	Default (Range)
E2-03 (0310)	Motor No-Load Current	<div style="display: flex; gap: 5px;"> V/f OLV OLV/PM AOLV/PM EZOLV </div> Sets the no-load current for the motor in amps when operating at the rated frequency and the no-load voltage.	Determined by o2-04, C6-01 (0 to E2-01)

Note:

When the drive model changes, the display units for this parameter also change.

- 0.01 A: B001 - B018, 2001 - 2042, 4001 - 4023
- 0.1 A: 2056 - 2082, 4031 - 4060

The drive automatically sets this parameter during Auto-Tuning. When you cannot do Auto-Tuning, you can also use the motor no-load current on the motor test report to enter this value manually. Get the test report from the motor manufacturer.

Note:

The default setting of the no-load current is for a 4-pole motor recommended by Yaskawa.

■ E2-04: Motor Pole Count

No. (Hex.)	Name	Description	Default (Range)
E2-04 (0311)	Motor Pole Count	<div style="display: flex; gap: 5px;"> V/f OLV OLV/PM AOLV/PM EZOLV </div> Sets the number of motor poles.	4 (2 - 120)

Note:

- When *A1-02* = 0 [*Control Method Selection* = *V/f*], the maximum value is 120.
- When *A1-02* = 2 [*OLV*], the maximum value is 48.

Auto-Tuning automatically sets this parameter to the value of [Number of Motor Poles].

■ E2-05: Motor Line-to-Line Resistance

No. (Hex.)	Name	Description	Default (Range)
E2-05 (0312)	Motor Line-to-Line Resistance	<div style="display: flex; gap: 5px;"> V/f OLV OLV/PM AOLV/PM EZOLV </div> Sets the line-to-line resistance for the motor stator windings.	Determined by o2-04, C6-01 (0.000 - 65.000 Ω)

Note:

This value is the motor line-to-line resistance. Do not set this parameter with the resistance per phase.

Auto-Tuning automatically sets this parameter. If you cannot do Auto-Tuning, use the test report from the motor manufacturer to configure the settings. Use one of these formulas to calculate the motor line-to-line resistance:

- E-type insulation: [the resistance value (Ω) shown on the test report at 75 °C] \times 0.822
- B-type insulation: [the resistance value (Ω) shown on the test report at 75 °C] \times 0.822
- F-type insulation: [the resistance value (Ω) shown on the test report at 115 °C] \times 0.728

■ E2-06: Motor Leakage Inductance

No. (Hex.)	Name	Description	Default (Range)
E2-06 (0313)	Motor Leakage Inductance	<div style="display: flex; justify-content: space-between; align-items: center;"> V/f OLV OLV/PM AOLV/PM EZOLV </div> Sets the voltage drop from motor leakage inductance when the motor is operating at the rated frequency and rated current. This value is a percentage of Motor Rated Voltage.	Determined by o2-04, C6-01 (0.0 - 60.0%)

The drive automatically sets this parameter during Auto-Tuning.

Note:

The motor nameplate does not usually show the quantity of voltage drop. If you do not know the value of the motor leakage inductance, contact the motor manufacturer to receive a copy of the motor test report.

■ E2-07: Motor Saturation Coefficient 1

No. (Hex.)	Name	Description	Default (Range)
E2-07 (0314)	Motor Saturation Coefficient 1	<div style="display: flex; justify-content: space-between; align-items: center;"> V/f OLV OLV/PM AOLV/PM EZOLV </div> Sets the motor iron-core saturation coefficient at 50% of the magnetic flux.	0.50 (0.00 - 0.50)

The drive uses this coefficient when it operates with constant output. The drive uses this coefficient when it operates the motor in the constant output range.

■ E2-08: Motor Saturation Coefficient 2

No. (Hex.)	Name	Description	Default (Range)
E2-08 (0315)	Motor Saturation Coefficient 2	<div style="display: flex; justify-content: space-between; align-items: center;"> V/f OLV OLV/PM AOLV/PM EZOLV </div> Sets the motor iron-core saturation coefficient at 75% of the magnetic flux.	0.75 (E2-07 - 0.75)

The drive uses this coefficient when it operates with constant output. The drive uses this coefficient when it operates the motor in the constant output range.

■ E2-09: Motor Mechanical Loss

No. (Hex.)	Name	Description	Default (Range)
E2-09 (0316) Expert	Motor Mechanical Loss	<div style="display: flex; justify-content: space-between; align-items: center;"> V/f OLV OLV/PM AOLV/PM EZOLV </div> Sets the mechanical loss of the motor. It is set as a percentage of E2-11 [Motor Rated Power]. Usually it is not necessary to change this setting.	0.0% (0.0 - 10.0%)

Adjust this parameter in these conditions. The drive adds the configured mechanical loss to the torque reference value as a torque compensation value:

- There is a large quantity of torque loss from motor bearing friction.
- There is a large quantity of torque loss in fans and pumps.

■ E2-10: Motor Iron Loss

No. (Hex.)	Name	Description	Default (Range)
E2-10 (0317)	Motor Iron Loss	<div style="display: flex; justify-content: space-between; align-items: center;"> V/f OLV OLV/PM AOLV/PM EZOLV </div> Sets the motor iron loss.	Determined by o2-04, C6-01 (0 - 65535 W)

■ E2-11: Motor Rated Power

No. (Hex.)	Name	Description	Default (Range)
E2-11 (0318)	Motor Rated Power	<input checked="" type="radio"/> V/f <input type="radio"/> OLV <input type="radio"/> OLV/PM <input type="radio"/> AOLV/PM <input type="radio"/> EZOLV Sets the motor rated output in the units from 01-58 [Motor Power Unit Selection].	Determined by 02-04, C6-01 (0.00 - 650.00)

The drive automatically sets this parameter to the value input for “Motor Rated Power” during Auto-Tuning.

◆ E3: V/f Pattern for Motor 2

E3 parameters [V/f Pattern for Motor 2] set the control mode and V/f pattern used for motor 2.

Note:

V/f preset patterns equivalent to those set with E1-03 [V/f Pattern Selection] are not available for E3 parameters. Use E3-04 [Motor 2 Maximum Output Frequency] to E3-10 [Motor 2 Minimum Output Voltage] to manually set the V/f pattern.

■ Notes on Manually Setting V/f Patterns

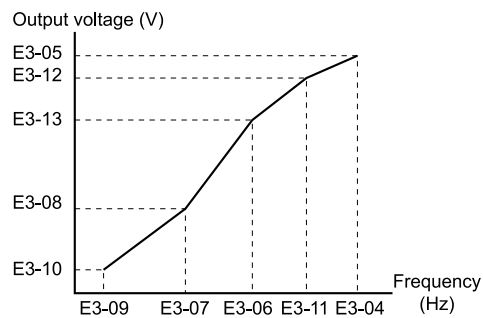

Figure 2.53 Motor 2 V/f Pattern Diagram

- To configure a linear V/f pattern at frequencies lower than E3-06 [Motor 2 Base Frequency], set E3-07 = E3-09 [Motor 2 Mid Point A Frequency = Motor 2 Minimum Output Frequency]. In this application, the drive ignores E1-08 [Mid Point A Voltage].
- Set the five frequencies as specified by these rules:
 $E3-09 \leq E3-07 < E3-06 \leq E3-11 \leq E3-04$ [Motor 2 Minimum Output Frequency ≤ Motor 2 Mid Point A Frequency < Motor 2 Base Frequency ≤ Motor 2 Mid Point B Frequency ≤ Motor 2 Maximum Output Frequency]
Incorrect settings will trigger oPE10 [V/f Data Setting Error].
- If E3-11 = 0.0 Hz, the drive will ignore the V/f pattern settings.
- When you use A1-03 [Initialize Parameters] to initialize the drive, the drive will reset the manually set values for E3-04 to E3-13 [Motor 2 Base Voltage] to default values.

■ E3-01: Motor 2 Control Mode Selection

No. (Hex.)	Name	Description	Default (Range)
E3-01 (0319)	Motor 2 Control Mode Selection	<input checked="" type="radio"/> V/f <input type="radio"/> OLV <input type="radio"/> OLV/PM <input type="radio"/> AOLV/PM <input type="radio"/> EZOLV Sets the control method for motor 2.	0 (0, 2)

Note:

- When you change this setting, the drive will set all parameters that are dependent on E3-01 to their default settings.
- Parameter L1-01 [Motor Overload (oL1) Protection] sets the protection operation of oL1 [Motor Overload] the same as Motor 1.
- When you use parameter A1-03 [Initialize Parameters] to initialize the drive, this parameter is not reset.

0 : V/f Control

2 : Open Loop Vector

■ E3-04: Motor 2 Maximum Output Frequency

No. (Hex.)	Name	Description	Default (Range)
E3-04 (031A)	Motor 2 Maximum Output Frequency	<input type="checkbox"/> V/f <input checked="" type="checkbox"/> OLV <input type="checkbox"/> OLV/PM <input type="checkbox"/> AOLV/PM <input type="checkbox"/> EZOLV Set the maximum output frequency for the motor 2 V/f pattern.	Determined by E3-01 (40.0 - 590.0 Hz)

■ E3-05: Motor 2 Maximum Output Voltage

No. (Hex.)	Name	Description	Default (Range)
E3-05 (031B)	Motor 2 Maximum Output Voltage	<input type="checkbox"/> V/f <input checked="" type="checkbox"/> OLV <input type="checkbox"/> OLV/PM <input type="checkbox"/> AOLV/PM <input type="checkbox"/> EZOLV Sets the maximum output voltage for the motor 2 V/f pattern.	Determined by E3-01 (200 V Class: 0.0 - 255.0 V, 400 V Class: 0.0 - 510.0 V)

■ E3-06: Motor 2 Base Frequency

No. (Hex.)	Name	Description	Default (Range)
E3-06 (031C)	Motor 2 Base Frequency	<input type="checkbox"/> V/f <input checked="" type="checkbox"/> OLV <input type="checkbox"/> OLV/PM <input type="checkbox"/> AOLV/PM <input type="checkbox"/> EZOLV Sets the base frequency for the motor 2 V/f pattern.	Determined by E3-01 (0.0 - E3-04)

■ E3-07: Motor 2 Mid Point A Frequency

No. (Hex.)	Name	Description	Default (Range)
E3-07 (031D)	Motor 2 Mid Point A Frequency	<input type="checkbox"/> V/f <input checked="" type="checkbox"/> OLV <input type="checkbox"/> OLV/PM <input type="checkbox"/> AOLV/PM <input type="checkbox"/> EZOLV Sets a middle output frequency for the motor 2 V/f pattern.	Determined by E3-01 (0.0 - E3-04)

■ E3-08: Motor 2 Mid Point A Voltage

No. (Hex.)	Name	Description	Default (Range)
E3-08 (031E)	Motor 2 Mid Point A Voltage	<input type="checkbox"/> V/f <input checked="" type="checkbox"/> OLV <input type="checkbox"/> OLV/PM <input type="checkbox"/> AOLV/PM <input type="checkbox"/> EZOLV Sets a middle output voltage for the motor 2 V/f pattern.	Determined by E3-01 (200 V Class: 0.0 - 255.0 V, 400 V Class: 0.0 - 510.0 V)

■ E3-09: Motor 2 Minimum Output Frequency

No. (Hex.)	Name	Description	Default (Range)
E3-09 (031F)	Motor 2 Minimum Output Frequency	<input type="checkbox"/> V/f <input checked="" type="checkbox"/> OLV <input type="checkbox"/> OLV/PM <input type="checkbox"/> AOLV/PM <input type="checkbox"/> EZOLV Sets the minimum output frequency for the motor 2 V/f pattern.	Determined by E3-01 (0.0 - E3-04)

■ E3-10: Motor 2 Minimum Output Voltage

No. (Hex.)	Name	Description	Default (Range)
E3-10 (0320)	Motor 2 Minimum Output Voltage	<input type="checkbox"/> V/f <input checked="" type="checkbox"/> OLV <input type="checkbox"/> OLV/PM <input type="checkbox"/> AOLV/PM <input type="checkbox"/> EZOLV Sets the minimum output voltage for the motor 2 V/f pattern.	Determined by E3-01 (200 V Class: 0.0 - 255.0 V, 400 V Class: 0.0 - 510.0 V)

■ E3-11: Motor 2 Mid Point B Frequency

No. (Hex.)	Name	Description	Default (Range)
E3-11 (0345) Expert	Motor 2 Mid Point B Frequency	<input type="checkbox"/> V/f <input checked="" type="checkbox"/> OLV <input type="checkbox"/> OLV/PM <input type="checkbox"/> AOLV/PM <input type="checkbox"/> EZOLV Sets a middle output frequency for the motor 2 V/f pattern. Set this parameter to adjust the V/f pattern for the constant output range. Usually it is not necessary to change this parameter.	0.0 Hz (0.0 - E3-04)

Note:

- Set this parameter to 0.0 to disable the function.
- When you initialize the drive, this parameter is reset to the default value.

■ E3-12: Motor 2 Mid Point B Voltage

No. (Hex.)	Name	Description	Default (Range)
E3-12 (0346) Expert	Motor 2 Mid Point B Voltage	<div style="display: flex; gap: 5px;"> V/f OLV OLV/PM AOLV/PM EZOLV </div> Sets a middle output voltage for the motor 2 V/f pattern. Set this parameter to adjust the V/f pattern for the constant output range. Usually it is not necessary to change this parameter.	0.0 V (200 V Class: 0.0 to 255.0 V, 400 V Class: 0.0 to 510.0 V)

Note:

- Set this parameter to 0.0 to disable the function.
- When you initialize the drive, this parameter is reset to the default value.
- The setting value changes automatically when you do Auto-Tuning (rotational and stationary 1 or 2).

■ E3-13: Motor 2 Base Voltage

No. (Hex.)	Name	Description	Default (Range)
E3-13 (0347) Expert	Motor 2 Base Voltage	<div style="display: flex; gap: 5px;"> V/f OLV OLV/PM AOLV/PM EZOLV </div> Sets the base voltage for the motor 2 V/f pattern. Set this parameter to adjust the V/f pattern for the constant output range. Usually it is not necessary to change this parameter.	0.0 V (200 V Class: 0.0 to 255.0 V, 400 V Class: 0.0 to 510.0 V)

Note:

- When you initialize the drive, this parameter is reset to the default value.
- The setting value changes automatically when you do Auto-Tuning (rotational and stationary 1 or 2).

◆ E4: Motor 2 Parameters

E4 parameters [Motor 2 Parameters] set induction motor data. To switch drive operation from one motor to a different motor, configure motor 2.

Auto-Tuning automatically sets the *E4 parameters* to the best values for the application. If you cannot do Auto-Tuning, set the *E4 parameters* manually.

Note:

E3-xx and *E4-xx* are available when *H1-xx = 16* [*MFDI Function Select = Motor 2 Selection*].

■ E4-01: Motor 2 Rated Current

No. (Hex.)	Name	Description	Default (Range)
E4-01 (0321)	Motor 2 Rated Current	<div style="display: flex; gap: 5px;"> V/f OLV OLV/PM AOLV/PM EZOLV </div> Sets the motor rated current for motor 2 in amps.	Determined by o2-04, C6-01 (10% to 200% of the drive rated current)

Note:

- If $E4-01 \leq E4-03$ [*Motor 2 Rated No-Load Current*], the drive will detect oPE02 [*Parameter Range Setting Error*].
- When the drive model changes, the display units for this parameter also change.
 - 0.01 A: B001 - B018, 2001 - 2042, 4001 - 4023
 - 0.1 A: 2056 - 2082, 4031 - 4060

The value set for *E4-01* becomes the reference value for motor protection, the torque limit, and torque control. Enter the motor rated current written on the motor nameplate. Auto-Tuning automatically sets the value of *E4-01* to the value input for [Motor Rated Current].

■ E4-02: Motor 2 Rated Slip

No. (Hex.)	Name	Description	Default (Range)
E4-02 (0322)	Motor 2 Rated Slip	<div style="display: flex; gap: 5px;"> V/f OLV OLV/PM AOLV/PM EZOLV </div> Sets the motor rated slip for motor 2.	Determined by o2-04, C6-01 (0.000 - 20.000 Hz)

The value set in *E4-02* becomes the base slip compensation value. The drive sets this parameter during Rotational Auto-Tuning and Stationary Auto-Tuning. If you cannot do Auto-Tuning, use the information written on the motor nameplate and this formula to calculate the motor rated slip:

$$E4-02 = f - (n \times p) / 120$$

- f: Motor rated frequency (Hz)
- n: Rated motor speed (min^{-1} (r/min))
- p: Number of motor poles

■ E4-03: Motor 2 Rated No-Load Current

No. (Hex.)	Name	Description	Default (Range)
E4-03 (0323)	Motor 2 Rated No-Load Current	<div style="display: flex; justify-content: space-between; font-size: small;"> V/f OLV OLV/PM AOLV/PM EZOLV </div> Sets the no-load current for motor 2 in amps when operating at the rated frequency and the no-load voltage.	Determined by o2-04, C6-01 (0 to E4-01)

Note:

When the drive model changes, the display units for this parameter also change.

- 0.01 A: B001 - B018, 2001 - 2042, 4001 - 4023
- 0.1 A: 2056 - 2082, 4031 - 4060

You can also manually enter the motor no-load current shown on the motor test report to *E4-03*. Contact the motor manufacturer for the motor test report.

Note:

The default setting of the no-load current is for a 4-pole motor recommended by Yaskawa.

■ E4-04: Motor 2 Motor Poles

No. (Hex.)	Name	Description	Default (Range)
E4-04 (0324)	Motor 2 Motor Poles	<div style="display: flex; justify-content: space-between; font-size: small;"> V/f OLV OLV/PM AOLV/PM EZOLV </div> Sets the number of poles for motor 2.	4 (2 - 120)

Auto-Tuning automatically sets *E4-04* to the value input for [Number of Motor Poles].

■ E4-05: Motor 2 Line-to-Line Resistance

No. (Hex.)	Name	Description	Default (Range)
E4-05 (0325)	Motor 2 Line-to-Line Resistance	<div style="display: flex; justify-content: space-between; font-size: small;"> V/f OLV OLV/PM AOLV/PM EZOLV </div> Sets the line-to-line resistance for the motor 2 stator windings.	Determined by o2-04, C6-01 (0.000 - 65.000 Ω)

Note:

This value is the line-to-line resistance for motor 2. Do not set this parameter with the resistance per phase.

Auto-Tuning automatically sets this parameter. If you cannot do Auto-Tuning, use the test report from the motor manufacturer to configure the settings. To calculate the motor line-to-line resistance, use the information shown on the motor nameplate with one of these formulas:

- E-type insulation: [the resistance value (Ω) shown on the test report at 75 °C] × 0.822
- B-type insulation: [the resistance value (Ω) shown on the test report at 75 °C] × 0.822
- F-type insulation: [the resistance value (Ω) shown on the test report at 115 °C] × 0.728

■ E4-06: Motor 2 Leakage Inductance

No. (Hex.)	Name	Description	Default (Range)
E4-06 (0326)	Motor 2 Leakage Inductance	<div style="display: flex; justify-content: space-between; font-size: small;"> V/f OLV OLV/PM AOLV/PM EZOLV </div> Sets the voltage drop from motor 2 leakage inductance as a percentage of Motor Rated Voltage when motor 2 operates at the rated frequency and rated current.	Determined by o2-04, C6-01 (0.0 - 60.0%)

The drive sets this parameter during Rotational Auto-Tuning and Stationary Auto-Tuning.

Note:

You cannot usually find the quantity of voltage drop on the motor nameplate. If you do not know the value of the motor 2 leakage inductance, get the test report from the motor manufacturer.

■ E4-07: Motor 2 Saturation Coefficient 1

No. (Hex.)	Name	Description	Default (Range)
E4-07 (0343)	Motor 2 Saturation Coefficient 1	<div style="display: flex; justify-content: space-between; align-items: center;"> V/f OLV OLV/PM AOLV/PM EZOLV </div> Sets the motor 2 iron-core saturation coefficient at 50% of the magnetic flux.	0.50 (0.00 - 0.50)

The drive sets this parameter during Rotational Auto-Tuning. The drive uses this value when it operates the motor in the constant output range.

■ E4-08: Motor 2 Saturation Coefficient 2

No. (Hex.)	Name	Description	Default (Range)
E4-08 (0344)	Motor 2 Saturation Coefficient 2	<div style="display: flex; justify-content: space-between; align-items: center;"> V/f OLV OLV/PM AOLV/PM EZOLV </div> Sets the motor 2 iron-core saturation coefficient at 75% of the magnetic flux.	0.75 (E4-07 - 0.75)

The drive sets this parameter during Rotational Auto-Tuning. The drive uses this value when it operates the motor in the constant output range.

■ E4-09: Motor 2 Mechanical Loss

No. (Hex.)	Name	Description	Default (Range)
E4-09 (033F) Expert	Motor 2 Mechanical Loss	<div style="display: flex; justify-content: space-between; align-items: center;"> V/f OLV OLV/PM AOLV/PM EZOLV </div> Sets the mechanical loss of motor 2. It is set as a percentage of <i>E4-11 [Motor 2 Rated Power]</i> . Usually it is not necessary to change this setting.	0.0% (0.0 - 10.0%)

Adjust this parameter in these conditions. The drive adds the configured mechanical loss to the torque reference value as a torque compensation value:

- There is a large quantity of torque loss from motor bearing friction.
- There is a large quantity of torque loss in fans and pumps.

■ E4-10: Motor 2 Iron Loss

No. (Hex.)	Name	Description	Default (Range)
E4-10 (0340)	Motor 2 Iron Loss	<div style="display: flex; justify-content: space-between; align-items: center;"> V/f OLV OLV/PM AOLV/PM EZOLV </div> Sets the motor iron loss for motor 2.	Determined by o2-04, C6-01 (0 - 65535 W)

■ E4-11: Motor 2 Rated Power

No. (Hex.)	Name	Description	Default (Range)
E4-11 (0327)	Motor 2 Rated Power	<div style="display: flex; justify-content: space-between; align-items: center;"> V/f OLV OLV/PM AOLV/PM EZOLV </div> Sets the motor rated power in the units from <i>o1-58 [Motor Power Unit Selection]</i> .	Determined by o2-04, C6-01 (0.00 - 650.00 HP)

Auto-Tuning automatically sets this parameter to the value input for [Motor Rated Power].

◆ E5: PM Motor Settings

E5 parameters are used to set PM motor data.

Set *E5-01* to the motor code when using PM motors recommended by Yaskawa. *E5* and other related motor parameters will be automatically set to the optimal values.

Perform Auto-Tuning for all other PM motors. If information from motor nameplates or test reports is available, the *E5 parameters* can be manually entered.

Note:

- The keypad shows *E5-xx* only when *A1-02 = 5, 6 [Control Method Selection = OLV/PM, AOLV/PM]*.
- *E5-xx parameters* are not reset when the drive is initialized using parameter *A1-03 [Initialize Parameters]*.

■ E5-01: PM Motor Code Selection

No. (Hex.)	Name	Description	Default (Range)
E5-01 (0329)	PM Motor Code Selection	<div style="display: flex; justify-content: space-between; border: 1px solid black; padding: 2px;"> V/f OLV OLV/PM AOLV/PM EZOLV </div> <p>Sets the motor code for Yaskawa PM motors. The drive uses the motor code to automatically set some parameters to their correct settings.</p>	FFFF (0000 - FFFF)

Note:

- If the drive hunts or shows an alarm after you enter a motor code, use the keypad to enter the value shown on the nameplate to *E5-xx*.
- When you use a PM motor other than a Yaskawa SMRD, SMRA, or SSR1 series, set *E5-01* = FFFF.

Figure 2.54 gives information about the motor code setting digits.

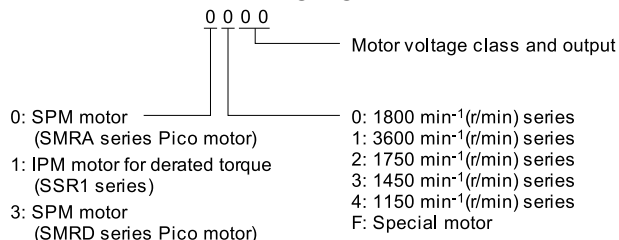

Figure 2.54 PM Motor Code

■ E5-02: PM Motor Rated Power

No. (Hex.)	Name	Description	Default (Range)
E5-02 (032A)	PM Motor Rated Power	<div style="display: flex; justify-content: space-between; border: 1px solid black; padding: 2px;"> V/f OLV OLV/PM AOLV/PM EZOLV </div> <p>Sets the PM motor rated output in the units from <i>o1-58</i> [Motor Power Unit Selection].</p>	Determined by <i>o2-04</i> , <i>C6-01</i> (0.10 - 30.00 kW)

These Auto-Tuning methods will automatically set this parameter:

- PM Motor Parameter Settings
- PM Stationary Auto-Tuning
- PM Rotational Auto-Tuning

■ E5-03: Motor Rated Current (FLA)

No. (Hex.)	Name	Description	Default (Range)
E5-03 (032B)	Motor Rated Current (FLA)	<div style="display: flex; justify-content: space-between; border: 1px solid black; padding: 2px;"> V/f OLV OLV/PM AOLV/PM EZOLV </div> <p>Sets the PM motor rated current (FLA).</p>	Determined by <i>o2-04</i> , <i>C6-01</i> (10% to 200% of the drive rated current)

Note:

When the drive model changes, the display units for this parameter also change.

- 0.01 A: B001 - B018, 2001 - 2042, 4001 - 4023
- 0.1 A: 2056 - 2082, 4031 - 4060

The drive automatically sets *E5-03* to the value input for *T2-06* [PM Motor Rated Current] after you do these types of Auto-Tuning:

- PM Motor Parameter Settings
- PM Stationary Auto-Tuning
- PM Stationary Tuning for Stator Resistance
- PM Rotational Auto-Tuning

■ E5-04: PM Motor Pole Count

No. (Hex.)	Name	Description	Default (Range)
E5-04 (032C)	PM Motor Pole Count	<div style="display: flex; justify-content: space-between; border: 1px solid black; padding: 2px;"> V/f OLV OLV/PM AOLV/PM EZOLV </div> <p>Sets the number of PM motor poles.</p>	4 (2 - 120)

2.6 E: Motor Parameters

These types of Auto-Tuning will automatically set this parameter to the value of [Number of Motor Poles]:

- Manual Entry w/ Motor Data Sheet
- PM Stationary Auto-Tuning
- Rotational (Ld, Lq, R, back-EMF)

■ E5-05: PM Motor Resistance (ohms/phase)

No. (Hex.)	Name	Description	Default (Range)
E5-05 (032D)	PM Motor Resistance (ohms/phase)	<div style="display: flex; justify-content: space-between; align-items: center;"> V/f OLV OLV/PM AOLV/PM EZOLV </div> Sets the resistance per phase of a PM motor. Set 50% of the line-to-line resistance.	0.100 Ω (0.000 - 65.000 Ω)

PM motor Auto-Tuning automatically sets this parameter to the value of [PM Motor Stator Resistance].

Note:

Do not change the setting calculated by Auto-Tuning unless it is necessary.

■ E5-06: PM d-axis Inductance (mH/phase)

No. (Hex.)	Name	Description	Default (Range)
E5-06 (032E)	PM d-axis Inductance (mH/phase)	<div style="display: flex; justify-content: space-between; align-items: center;"> V/f OLV OLV/PM AOLV/PM EZOLV </div> Sets the PM motor d-axis inductance.	1.00 mH (0.00 - 300.00 mH)

PM motor Auto-Tuning automatically sets this parameter to the value of [PM Motor d-Axis Inductance].

Note:

Do not change the setting calculated by Auto-Tuning unless it is necessary.

■ E5-07: PM q-axis Inductance (mH/phase)

No. (Hex.)	Name	Description	Default (Range)
E5-07 (032F)	PM q-axis Inductance (mH/phase)	<div style="display: flex; justify-content: space-between; align-items: center;"> V/f OLV OLV/PM AOLV/PM EZOLV </div> Sets the PM motor q-axis inductance.	1.00 mH (0.00 - 600.00 mH)

PM motor Auto-Tuning automatically sets this parameter to the value of [PM Motor q-Axis Inductance].

Note:

Do not change the setting calculated by Auto-Tuning unless it is necessary.

■ E5-09: PM Back-EMF Vpeak (mV/(rad/s))

No. (Hex.)	Name	Description	Default (Range)
E5-09 (0331)	PM Back-EMF Vpeak (mV/(rad/s))	<div style="display: flex; justify-content: space-between; align-items: center;"> V/f OLV OLV/PM AOLV/PM EZOLV </div> Sets the peak value of PM motor induced voltage.	0.0 mV/(rad/sec) (0.0 - 2000.0 mV/(rad/s))

Set this parameter when you use an IPM motor (SSR1-Series).

PM motor Auto-Tuning automatically sets this parameter to the value of [Back-EMF Voltage Constant (Ke)].

When $E5-01 = FFFF$, only set $E5-09$ or $E5-24$ [PM Back-EMF L-L V_{rms} (mV/rpm)] as the induced voltage constant.

Note:

When you set this parameter, also set $E5-24 = 0.0$. The drive will detect $oPE08$ [Parameter Selection Error] in these conditions:

- $E5-09 = 0.0$ and $E5-24 = 0.0$
- $E5-09 \neq 0.0$ and $E5-24 \neq 0.0$

■ E5-24: PM Back-EMF L-L Vrms (mV/rpm)

No. (Hex.)	Name	Description	Default (Range)
E5-24 (0353)	PM Back-EMF L-L Vrms (mV/rpm)	<div style="display: flex; justify-content: space-between; border-bottom: 1px solid black; margin-bottom: 5px;"> V/f OLV OLV/PM AOLV/PM EZOLV </div> Sets the RMS value for PM motor line voltage.	200 V Class: 100.0 mV/min ⁻¹ 400 V Class: 200.0 mV/min ⁻¹ (0.0 - 6500.0 mV/min ⁻¹)

Set this parameter when you use an SPM motor (SMRD-Series).

PM motor Auto-Tuning automatically sets this parameter to the value of [Back-EMF Voltage Constant (K_e)].

When *E5-01* = FFFF, only set *E5-09* [PM Back-EMF Vpeak (mV/(rad/s))] or *E5-24* as the induced voltage constant.

Note:

When you set this parameter, also set *E5-09* = 0.0. The drive will detect *oPE08* [Parameter Selection Error] in these conditions:

- *E5-09* = 0.0 and *E5-24* = 0.0
- *E5-09* ≠ 0.0 and *E5-24* ≠ 0.0

■ E5-25: Polarity Estimation Timeout

No. (Hex.)	Name	Description	Default (Range)
E5-25 (035E) Expert	Polarity Estimation Timeout	<div style="display: flex; justify-content: space-between; border-bottom: 1px solid black; margin-bottom: 5px;"> V/f OLV OLV/PM AOLV/PM EZOLV </div> Sets the function that switches polarity for initial polarity estimation. Usually it is not necessary to change this setting.	0 (0, 1)

When “Sd = 1” is shown on the motor nameplate or test report for Yaskawa motors, set this parameter to 1.

0 : Disabled

1 : Enabled

◆ E9: Motor Setting

E9 parameters are used to configure induction motors, PM motors, and SynRM motors. Configure these parameters only for derating torque applications in which a high level of responsiveness and accurate speed control are not required.

E9 parameters are automatically configured with values input by the Auto-Tuning process for motor parameter settings. *E9 parameters* can be manually configured when the EZ Tuning process cannot be performed.

■ E9-01: Motor Type Selection

No. (Hex.)	Name	Description	Default (Range)
E9-01 (11E4)	Motor Type Selection	<div style="display: flex; justify-content: space-between; border-bottom: 1px solid black; margin-bottom: 5px;"> V/f OLV OLV/PM AOLV/PM EZOLV </div> Sets the type of motor.	0 (0 - 2)

EZ Tuning automatically sets this parameter to the value of [Motor Type Selection].

0 : Induction (IM)

1 : Permanent Magnet (PM)

2 : Synchronous Reluctance (SynRM)

■ E9-02: Maximum Speed

No. (Hex.)	Name	Description	Default (Range)
E9-02 (11E5)	Maximum Speed	<div style="display: flex; justify-content: space-between; border-bottom: 1px solid black; margin-bottom: 5px;"> V/f OLV OLV/PM AOLV/PM EZOLV </div> Sets the maximum speed of the motor.	Determined by E9-01 (40.0 - 120.0 Hz)

Note:

The unit of measure changes when the setting of *o1-04* [V/f Pattern Display Unit].

2.6 E: Motor Parameters

EZ Tuning automatically sets this parameter to the value of [Motor Max Revolutions].

■ E9-03: Rated Speed

No. (Hex.)	Name	Description	Default (Range)
E9-03 (11E6)	Rated Speed	<div style="display: flex; justify-content: space-between; align-items: center;"> V/f OLV OLV/PM AOLV/PM EZOLV </div> Sets the rated rotation speed of the motor.	Determined by E9-01 (100 - 7200 min ⁻¹)

EZ Tuning automatically sets this parameter to the value of [Rated Speed].

Note:

Set *E9-01* = 0 [Motor Type Selection = Induction (IM)] before you set this parameter.

■ E9-04: Base Frequency

No. (Hex.)	Name	Description	Default (Range)
E9-04 (11E7)	Base Frequency	<div style="display: flex; justify-content: space-between; align-items: center;"> V/f OLV OLV/PM AOLV/PM EZOLV </div> Sets the rated frequency of the motor.	Determined by E9-01 (40.0 - 120.0 Hz)

Note:

The unit of measure changes when the setting of *o1-04* [V/f Pattern Display Unit].

EZ Tuning automatically sets this parameter to the value of [Base Frequency].

■ E9-05: Base Voltage

No. (Hex.)	Name	Description	Default (Range)
E9-05 (11E8)	Motor Rated Voltage	<div style="display: flex; justify-content: space-between; align-items: center;"> V/f OLV OLV/PM AOLV/PM EZOLV </div> Sets the rated voltage of the motor.	200 V Class: 230.0 V, 400 V Class: 460.0 V (200 V Class: 0.0 - 255.0 V, 400 V Class: 0.0 - 510.0 V)

EZ Tuning automatically sets this parameter to the value of [Base Voltage].

■ E9-06: Motor Rated Current (FLA)

No. (Hex.)	Name	Description	Default (Range)
E9-06 (11E9)	Motor Rated Current (FLA)	<div style="display: flex; justify-content: space-between; align-items: center;"> V/f OLV OLV/PM AOLV/PM EZOLV </div> Sets the motor rated current in amps.	Determined by E9-01 and o2-04 (10% to 200% of the drive rated current)

Note:

When the drive model changes, the display units for this parameter also change.

- 0.01 A: B001 to B018, 2001 to 2042, 4001 to 4023
- 0.1 A: 2056 to 2082, 4031 to 4060

The setting value of *E9-06* is the reference value for motor protection. Enter the motor rated current written on the motor nameplate. Auto-Tuning the drive will automatically set *E9-06* to the value input for *T4-07* [Motor Rated Current].

■ E9-07: Motor Rated Power

No. (Hex.)	Name	Description	Default (Range)
E9-07 (11EA)	Motor Rated Power	<div style="display: flex; justify-content: space-between; align-items: center;"> V/f OLV OLV/PM AOLV/PM EZOLV </div> Sets the motor rated output in the units from <i>o1-58</i> [Motor Power Unit Selection].	Determined by E9-02 and o2-04 (0.00 - 650.00 kW)

Auto-Tuning automatically sets this parameter to the value of [Motor Rated Power (kW)].

■ E9-08: Motor Pole Count

No. (Hex.)	Name	Description	Default (Range)
E9-08 (11EB)	Motor Pole Count	V/f OLV OLV/PM AOLV/PM EZOLV Sets the number of motor poles.	4 (2 to 120)

Auto-Tuning automatically sets this parameter to the value of [Number of Motor Poles].

■ E9-09: Motor Rated Slip

No. (Hex.)	Name	Description	Default (Range)
E9-09 (11EC)	Motor Rated Slip	V/f OLV OLV/PM AOLV/PM EZOLV Sets the motor rated slip.	0.000 Hz (0.000 - 20.000 Hz)

The setting value of this parameter is the slip compensation reference value.

The drive uses the setting values of *E9-03*, *E9-04*, and *E9-08* to calculate this parameter. When Motor Rated Slip = 0, Auto-Tuning automatically sets this parameter to the value of [Motor Rated Slip].

Note:

Set *E9-01* = 0 [Motor Type Selection = Induction (IM)] before you set this parameter.

■ E9-10: Motor Line-to-Line Resistance

No. (Hex.)	Name	Description	Default (Range)
E9-10 (11ED)	Motor Line-to-Line Resistance	V/f OLV OLV/PM AOLV/PM EZOLV Sets the line-to-line resistance for the motor stator windings.	Determined by o2-04 (0.000 - 65.000 Ω)

Note:

This value is the motor line-to-line resistance. Do not set this parameter with the resistance per phase.

Stationary Auto-Tuning automatically sets this parameter. If you cannot do Stationary Auto-Tuning, use the test report from the motor manufacturer. Use one of these formulas to calculate the motor line-to-line resistance:

- E-type insulation: [the resistance value (Ω) shown on the test report at 75 °C] × 0.822
- B-type insulation: [the resistance value (Ω) shown on the test report at 75 °C] × 0.822
- F-type insulation: [the resistance value (Ω) shown on the test report at 115 °C] × 0.728

2.7 F: Options

F parameters are used to set option cards, which function as interfaces for encoders, analog I/O, digital I/O, and fieldbus communication.

◆ F1: Fault Detection in PG Speed Control

F1 parameters set the fault detection function in Speed Feedback (V/F Control). When $A1-02 = 0$ [Control Method Selection = V/f], set $H6-01 = 3$ [Terminal RP Pulse Train Function = Speed Feedback (V/F Control)] to enable this function. For speed feedback, connect the single-channel pulse signal from the PG encoder to pulse train input terminal RP. Use the Slip Compensation signal to improve the accuracy of Speed Control. This function is available for Motor 1.

WARNING! Sudden Movement Hazard. Do test runs and examine the drive to make sure that the command references are correct. If you set the command reference incorrectly, it can cause damage to the drive or serious injury or death.

WARNING! Sudden Movement Hazard. Make sure that the host controller circuitry has correct safety design that will let you keep control of the motor if the drive loses speed feedback. If you do not have control of the motor, it can cause serious injury or death.

■ F1-02: Encoder Signal Loss Detect Sel

No. (Hex.)	Name	Description	Default (Range)
F1-02 (0381)	Encoder Signal Loss Detect Sel	<div style="display: flex; gap: 5px;"> V/f OLV OLV/PM AOLV/PM EZOLV </div> Sets the method to stop the motor or let the motor continue operating when the drive detects <i>PGo</i> [Encoder (PG) Feedback Loss].	1 (0 - 4)

If the drive does not detect output pulses from the encoder for the time set in $F1-14$ [Encoder Open-Circuit Detect Time], it will trigger *PGo*.

Note:

- When $A1-02 = 0$ [Control Method Selection = V/f], set $H6-01 = 3$ [Terminal RP Pulse Train Function = Speed Feedback (V/F Control)] to enable this parameter.
- Motor speed and load conditions can cause *ov* [Overvoltage] and *oC* [Overcurrent] faults.

0 : Ramp to Stop

The drive ramps the motor to stop in the deceleration time. The output terminal set for *Fault* [$H2-01$ to $H2-03 = E$] activates.

1 : Coast to Stop

The output turns off and the motor coasts to stop. The output terminal set for *Fault* [$H2-01$ to $H2-03 = E$] activates.

2 : Fast Stop (Use C1-09)

The drive stops the motor in the deceleration time set in $C1-09$ [Fast Stop Time]. The output terminal set for *Fault* [$H2-01$ to $H2-03 = E$] activates.

3 : Alarm Only

The keypad shows *PGo* and the drive continues operation. Only use this setting in special conditions to prevent damage to the motor and machinery. The output terminal set to *Alarm* [$H2-01$ to $H2-03 = 10$] activates.

4 : No Alarm Display

The drive continues operation and does not show *PGo* on the keypad. Only use this setting in special conditions to prevent damage to the motor and machinery.

■ F1-03: Overspeed Detection Selection

No. (Hex.)	Name	Description	Default (Range)
F1-03 (0382)	Overspeed Detection Selection	<div style="display: flex; gap: 5px;"> V/f OLV OLV/PM AOLV/PM EZOLV </div> Sets the method to stop the motor or let the motor continue to operate when the drive detects <i>oS</i> [Overspeed].	1 (0 - 3)

When the motor speed is more than the value set in $F1-08$ [Overspeed Detection Level] for longer than the time set in $F1-09$ [Overspeed Detection Delay Time] it will trigger *oS*.

0 : Ramp to Stop

The drive ramps the motor to stop in the deceleration time. The output terminal set for *Fault* [H2-01 to H2-03 = E] activates.

1 : Coast to Stop

The output turns off and the motor coasts to stop. The output terminal set for *Fault* [H2-01 to H2-03 = E] activates.

2 : Fast Stop (Use C1-09)

The drive stops the motor in the deceleration time set in *C1-09* [Fast Stop Time]. The output terminal set for *Fault* [H2-01 to H2-03 = E] activates.

3 : Alarm Only

The keypad shows *oS* and the drive continues operation. Only use this setting in special conditions to prevent damage to the motor and machinery. The output terminal set to *Alarm* [H2-01 to H2-03 = 10] activates.

Note:

- When *A1-02* = 0 [Control Method Selection = V/f], set *H6-01* = 3 [Terminal RP Pulse Train Function = Speed Feedback (V/F Control)] to enable this parameter.
- When *A1-02* = 6 [Control Method Selection = AOLV/PM], the drive will automatically set *F1-03* = 1 [Coast to Stop]. You cannot change this value.

■ F1-04: Speed Deviation Detection Select

No. (Hex.)	Name	Description	Default (Range)
F1-04 (0383)	Speed Deviation Detection Select	<div style="display: flex; gap: 5px;"> V/f OLV OLV/PM AOLV/PM EZOLV </div> Sets the method to stop the motor or let the motor continue to operate when the drive detects <i>dEv</i> [Speed Deviation].	3 (0 - 3)

When the difference between the frequency reference and the motor speed is more than the value set in *F1-10* [Speed Deviation Detection Level] for longer than the time set in *F1-11* [Speed Deviation Detect DelayTime], it will trigger *dEv*.

Note:

When *A1-02* = 0 [Control Method Selection = V/f], set *H6-01* = 3 [Terminal RP Pulse Train Function = Speed Feedback (V/F Control)] to enable this parameter.

0 : Ramp to Stop

The drive ramps the motor to stop in the deceleration time. The output terminal set for *Fault* [H2-01 to H2-03 = E] activates.

1 : Coast to Stop

The output turns off and the motor coasts to stop. The output terminal set for *Fault* [H2-01 to H2-03 = E] activates.

2 : Fast Stop (Use C1-09)

The drive stops the motor in the deceleration time set in *C1-09* [Fast Stop Time]. The output terminal set for *Fault* [H2-01 to H2-03 = E] activates.

3 : Alarm Only

The keypad shows *dEv* and the drive continues operation. Only use this setting in special conditions to prevent damage to the motor and machinery. The output terminal set to *Alarm* [H2-01 to H2-03 = 10] activates.

■ F1-08: Overspeed Detection Level

No. (Hex.)	Name	Description	Default (Range)
F1-08 (0387)	Overspeed Detection Level	<div style="display: flex; gap: 5px;"> V/f OLV OLV/PM AOLV/PM EZOLV </div> Sets the detection level of <i>oS</i> [Overspeed] as a percentage when the maximum output frequency is 100%.	115% (0 - 120%)

When the motor speed is more than the value set in *F1-08* for longer than the time set in *F1-09* [Overspeed Detection Delay Time], the drive will detect *oS*.

Note:

When *A1-02* = 0 [Control Method Selection = V/f], set *H6-01* = 3 [Terminal RP Pulse Train Function = Speed Feedback (V/F Control)] to enable this parameter.

■ F1-09: Overspeed Detection Delay Time

No. (Hex.)	Name	Description	Default (Range)
F1-09 (0388)	Overspeed Detection Delay Time	<div style="display: flex; gap: 5px;"> V/f OLV OLV/PM AOLV/PM EZOLV </div> Sets the length of time that the speed feedback must be more than the <i>F1-08</i> level to cause <i>oS</i> [Overspeed].	Determined by A1-02 (0.0 - 2.0 s)

When the motor speed is more than the value set in *F1-08* [Overspeed Detection Level] for longer than the time set in *F1-09*, the drive will detect *oS*.

Note:

When *A1-02* = 0 [Control Method Selection = V/f], set *H6-01* = 3 [Terminal RP Pulse Train Function = Speed Feedback (V/F Control)] to enable this parameter.

■ F1-10: Speed Deviation Detection Level

No. (Hex.)	Name	Description	Default (Range)
F1-10 (0389)	Speed Deviation Detection Level	<div style="display: flex; gap: 5px;"> V/f OLV OLV/PM AOLV/PM EZOLV </div> Sets the detection level of <i>dEv</i> [Speed Deviation] as a percentage when the maximum output frequency is 100%.	10% (0 - 50%)

When the speed deviation between the frequency reference and the actual motor speed is more than the value set in *F1-10* for longer than the time set in *F1-11* [Speed Deviation Detect DelayTime], the drive will detect *dEv*.

Note:

When *A1-02* = 0 [Control Method Selection = V/f], set *H6-01* = 3 [Terminal RP Pulse Train Function = Speed Feedback (V/F Control)] to enable this parameter.

■ F1-11: Speed Deviation Detect DelayTime

No. (Hex.)	Name	Description	Default (Range)
F1-11 (038A)	Speed Deviation Detect DelayTime	<div style="display: flex; gap: 5px;"> V/f OLV OLV/PM AOLV/PM EZOLV </div> Sets the length of time that the difference between the frequency reference and speed feedback must be more than the level in <i>F1-10</i> to cause <i>dEv</i> [Speed Deviation].	0.5 s (0.0 - 10.0 s)

When the speed deviation between the frequency reference and the actual motor speed is more than the value set in *F1-10* [Speed Deviation Detection Level] for longer than the time set in *F1-11*, the drive will detect *dEv*.

Note:

When *A1-02* = 0 [Control Method Selection = V/f], set *H6-01* = 3 [Terminal RP Pulse Train Function = Speed Feedback (V/F Control)] to enable this parameter.

■ F1-14: Encoder Open-Circuit Detect Time

No. (Hex.)	Name	Description	Default (Range)
F1-14 (038D)	Encoder Open-Circuit Detect Time	<div style="display: flex; gap: 5px;"> V/f OLV OLV/PM AOLV/PM EZOLV </div> Sets the length of time that the drive must not receive a pulse signal to cause <i>PGo</i> [Encoder (PG) Feedback Loss].	2.0 s (0.0 - 10.0 s)

If the drive does not detect output pulses from the encoder for the time set in *F1-14*, it will trigger *PGo*.

Note:

- When *A1-02* = 0 [Control Method Selection = V/f], set *H6-01* = 3 [Terminal RP Pulse Train Function = Speed Feedback (V/F Control)] to enable this parameter.
- Motor speed and load conditions can cause *ov* [Overvoltage] and *oC* [Overcurrent] faults.

◆ F6, F7: Communication Options

F6 and *F7* parameters are used to set the basic communication settings and method of fault detection for the communication option card. The communication option card parameters include common option card parameters and communication protocol-specific parameters.

The following table lists the parameters that need to be set for each communication option card.

Refer to the technical manual for each communication option card for more information on installing, wiring, and configuring the details needed before starting communication.

WARNING! Sudden Movement Hazard. Do test runs and examine the drive to make sure that the command references are correct. If you set the command reference incorrectly, it can cause damage to the drive or serious injury or death.

Table 2.38 Correspondence Between Communication Protocols and Parameters (SI-C3, SI-T3, SI-ET3, SI-P3, SI-S3, and SI-ES3)

Parameter	CC-Link SI-C3	MECHATROLINK-II SI-T3	MECHATROLINK-III SI-ET3	PROFIBUS-DP SI-P3	CANopen SI-S3	EtherCAT SI-ES3
F6-01 to F6-03	x	x	x	x	x	x
F6-04	x	-	-	-	-	-
F6-06 to F6-08	x	x	x	x	x	x
F6-10, F6-11	x	-	-	-	-	-
F6-14	x	x	x	x	x	x
F6-16	x	x	x	x	x	x
F6-20, F6-21	-	x	x	-	-	-
F6-22	-	x	-	-	-	-
F6-23 to F6-26	-	x	x	-	-	-
F6-30 to F6-32	-	-	-	x	-	-
F6-35, F6-36	-	-	-	-	x	-
F6-50 to F6-71	-	-	-	-	-	-
F7-01 to F7-15	-	-	-	-	-	-
F7-16	-	-	-	-	-	-
F7-17 to F7-42	-	-	-	-	-	-
F7-60 to F7-79	-	-	-	x	-	-

Table 2.39 Relation Between Communication Protocols and Parameters (SI-B3, SI-N3, SI-W3, SI-EM3, SI-EP3, and SI-EN3)

Parameter	DeviceNet SI-N3	LonWorks SI-W3	Modbus TCP/IP SI-EM3	PROFINET SI-EP3	EtherNet/IP SI-EN3
F6-01 to F6-03	x	x	x	x	x
F6-04	-	-	-	-	-
F6-06 to F6-08	x	x	x	x	x
F6-10, F6-11	-	-	-	-	-
F6-14	x	x	x	x	x
F6-16	x	x	x	x	x
F6-20, F6-21	-	-	-	-	-
F6-22	-	-	-	-	-
F6-23 to F6-26	-	-	-	-	-
F6-30 to F6-32	-	-	-	-	-
F6-35, F6-36	-	-	-	-	-
F6-50 to F6-71	x	-	-	-	-
F7-01 to F7-15	-	-	x	x	x
F7-16	-	-	x	-	-
F7-17 to F7-42	-	-	-	x	x
F7-60 to F7-79	-	-	-	-	-

■ Gateway Mode

Note:

When you use Gateway Mode, do not install the communication option in slave drives. If you install a communication option in a slave drive, the drive commands and responses will not synchronize.

In gateway mode, you can use one communication option to communicate with more than one drive.

You can use one communication option to connect a maximum of five drives to the field bus communications. Refer to [Figure 2.55](#) for more information.

When you install a communication option on the master drive, you can use the RS-485 communication terminals to transmit data to slave drives that do not have a communication option.

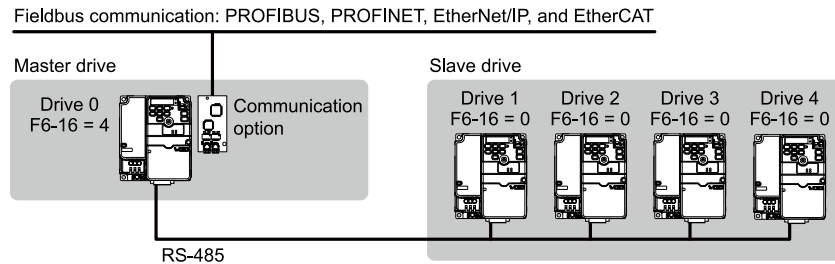

Figure 2.55 Connection Examples in Gateway Mode

Table 2.40 Specification

Item	Specification
Applicable options	All options that support the MEMOBUS access function (for example, PROFIBUS-DP, PROFINET, EtherNet/IP, EtherCAT)
Compatible Products	Drives that can set F6-16 [Gateway Mode] *1
Number of connected drives	Maximum: 5 units
Communication specifications	MEMOBUS/Modbus (RTUmode) communications
Commands/responses	The controller can send this data to each drive (Drive 0 to Drive 4): <ul style="list-style-type: none"> • Control commands: Run commands and frequency references • Control responses: Output frequency and drive status (during run, faults) • Read and write parameters • Read monitors
Synchronous control	Not supported

*1 Gateway Mode is not available with Yaskawa 1000-series drives or previous series drives.

Note:

- The communication speed in gateway mode is slower than the speed in fieldbus communications. Make sure that the speed is acceptable for your system.
- Response speed with the communication option is slower than with point-to-point communications.
- Set H5-03 [Communication Parity Selection] to the same value on the master drive and slave drives.

WARNING! Injury to Personnel. Separately prepare safety protection equipment and systems, for example fast stop switches. If the motor does not stop correctly from the disconnection of communications cable or electrical interference, it can cause serious injury.

Setting Gateway Mode

Table 2.41 shows sample settings to connect 4 slave drives:

Table 2.41 Sample Settings for Using Gateway Mode

	F6-16 [Gateway Mode]	H5-01 [Drive Node Address] *1	H5-02 [Communication Speed Selection] H5-03 [Communication Parity Selection]	H5-06 [Drive Transmit Wait Time]	H5-09 [CE Detection Time]	b1-01 [Frequency Reference Selection 1]	b1-02 [Run Command Selection 1]
Drive 0 (Master Drive)	1 - 4 *2	1F (Default)	*5	5 ms (Default) *6	≥ 2.0 s *7	3 [Option PCB]	3 [Option PCB]
Drive 1 (Slave Drive)	0	01 *3 *4	*5	5 ms (Default) *6	≥ 0.9 s *7	2 [Memobus/Modbus Communications] *8	2 [Memobus/Modbus Communications] *8

	F6-16 [Gateway Mode]	H5-01 [Drive Node Address] *1	H5-02 [Communication Speed Selection] H5-03 [Communication Parity Selection]	H5-06 [Drive Transmit Wait Time]	H5-09 [CE Detection Time]	b1-01 [Frequency Reference Selection 1]	b1-02 [Run Command Selection 1]
Drive 2 (Slave Drive)	0	02 *3 *4	*5	5 ms (Default) *6	≥ 0.9 s *7	2 [Memobus/Modbus Communications] *8	2 [Memobus/Modbus Communications] *8
Drive 3 (Slave Drive)	0	03 *3 *4	*5	5 ms (Default) *6	≥ 0.9 s *7	2 [Memobus/Modbus Communications] *8	2 [Memobus/Modbus Communications] *8
Drive 4 (Slave Drive)	0	04 *3 *4	*5	5 ms (Default) *6	≥ 0.9 s *7	2 [Memobus/Modbus Communications] *8	2 [Memobus/Modbus Communications] *8

*1 Re-energize the drive to apply the new settings.

*2 Specify the number of slave drives you will connect.

*3 Setting 0 will not let the drive respond to MEMOBUS/Modbus communications.

*4 Set a slave address that is different from other slave devices.

*5 Enter the same value that you use for the master drive.

*6 To correctly detect the response timeout, do not change the value of H5-06 from the default value.

*7 Set H5-09 ≥ 0.9 . When H5-09 < 0.9 , the drive will detect CE [Modbus Communication Error] before it detects a response timeout.

*8 On each slave drive, set b1-01 [Frequency Reference Selection 1] and b1-02 [Run Command Selection 1] to 2 [Memobus/Modbus Communications].

An Overview of Gateway Mode

When in gateway mode, the drive will operate as shown in Table 2.42.

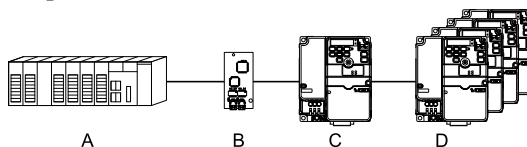

A - Controller

B - Communication option

C - Master Drive (Drive 0)

D - Slave Drives (Drives 1 to 4)

Table 2.42 Operation in Gateway Mode

Controller to Communication Option	Communication Option to Master Drive (Drive 0)	Master Drive (Drive 0) to Slave Drives (Drives 1 to 4)
<ul style="list-style-type: none"> The controller and card communicate in the format of each field bus communications protocol. Drive 0 sends commands and monitors through normal field bus communications. The special registers of Drive 0 use read and write to send commands to and monitor Drives 1 to 4. 	Field bus communication data is written to and read from the special registers of Drive 0.	<ul style="list-style-type: none"> Uses MEMOBUS communications. Drive 0 sends data from its special registers to Drives 1 to 4.

Note:

Energize the slave drive before you energize the master drive. If you energize the master drive first, the drive detects CE [Modbus Communication Error].

Operations at the Time of Communication Error

Communication Error	Error Codes	Operation
From controller to communication option	bUS	<ul style="list-style-type: none"> Master drive Detects <i>bUS</i> [Option Communication Error] and operates as specified by <i>F6-01</i> [Communication Error Selection]. Slave drive Detects <i>CE</i> [Modbus Communication Error] and operates as specified by <i>H5-04</i> [Communication Error Stop Method]. <p>Note:</p> <ul style="list-style-type: none"> After error detection, each drive can continue the operation specified by the last received command if the <i>F6-01</i> and <i>H5-04</i> settings agree. Because the controller cannot stop the operation, you must supply a stopping method, for example an emergency stop switch. If you set <i>H5-05</i> = 0 [Comm Fault Detection Selection = Disabled], the drive will not detect <i>CE</i>. The <i>H5-04</i> setting does not have an effect.
From communication option to master drive	oFAxx	<ul style="list-style-type: none"> Master drive Detects <i>oFAxx</i> and coasts to stop. Slave drive Detects <i>hLCE</i> [High Level Communication Errors] and coasts to stop.
From master drive to slave drive	CE	<p>The master drive stops communicating with the slave drive in these conditions: Reset the fault to restart communication.</p> <p>The slave drive detects <i>CE</i> after <i>H5-09</i> [CE Detection Time] is expired. Then it operates in as specified with <i>H5-04</i> [Communication Error Stop Method].</p> <ul style="list-style-type: none"> A message error occurred in the send data from the slave drive 10 consecutive times. Response from the slave drive timed out 10 consecutive times.

Gateway Special Register Specification

Table 2.43 Command Data

Register No. (Hex.)	Description	
15C5	Command source update	
	This flag enables command updates.	
	bit 0	Drive 1 Update Command Enabled
	bit 1	Drive 2 Update Command Enabled
	bit 2	Drive 3 Update Command Enabled
	bit 3	Drive 4 Update Command Enabled
	bit 4	Update Register Access Command Enabled
bit 5 - F	Reserved	
15C6	Run Command (Drive 1)	
	bit 0	H5-12 = 0: FWD/Stop 0 = Stop 1 = Forward run
		H5-12 = 1: Run/Stop 0 = Stop 1 = Run
	bit 1	H5-12 = 0: REV/Stop 0 = Stop 1 = Reverse run
		H5-12 = 1: FWD/REV 0 = Forward run 1 = Reverse run
	bit 2	External fault
	bit 3	Fault Reset
	bit 4	ComRef
	bit 5	ComCtrl
bit 6 - F	Reserved	
15C7	Frequency Reference (Drive 1)	The unit of measure changes when <i>o1-03</i> changes.
15C8	Run Command (Drive 2)	Refer to "15C6: Run Command (Drive 1)" for more information.
15C9	Frequency Reference (Drive 2)	The unit of measure changes when <i>o1-03</i> changes.
15CA	Run Command (Drive 3)	Refer to "15C6: Run Command (Drive 1)" for more information.

Register No. (Hex.)	Description	
15CB	Frequency Reference (Drive 3)	
	The unit of measure changes when <i>o1-03</i> changes.	
15CC	Run Command (Drive 4)	
	Refer to "15C6: Run Command (Drive 1)" for more information.	
15CD	Frequency Reference (Drive 4)	
	The unit of measure changes when <i>o1-03</i> changes.	
15CE	Slave Address for Reg. Access + Read/Write	
	bit 0	Slave address
	bit 1	0: Broadcast Messages (MEMOBUS)
	bit 2	1: Drive 1
	bit 3	2: Drive 2
bit 4	3: Drive 3	
bit 5	4: Drive 4	
bit 6	5: Broadcast Messages (run command and frequency reference)	
bit 7	0: Read, 1: Write	
bit 8 - F	Reserved	
15CF	Register number	
15D0	Data (write register)	

Table 2.44 Monitor Data

Register No. (Hex.)	Description	
15E7	Drive Status (Drive 1)	
	bit 0	During Run
	bit 1	During Reverse Run
	bit 2	Drive ready
	bit 3	Fault
	bit 4	Frequency Reference Setting Fault
	bit 5	No response from slave
	bit 6	Communication Error
	bit 7	No response from slave 10 consecutive attempts.
	bit 8	Communication fault occurred 10 consecutive times.
	bit 9	Receive broadcast command while drive is running
	bit A	Communication error with master drive
	bit B - D	Reserved
	bit E	ComRef status
bit F	ComCtrl status	
15E8	Output frequency or frequency reference (Drive Status Bit 1: ON) (Drive 1) Drive Status Bit 4 = 0 [Output Frequency] Drive Status Bit 4 = 1 [Frequency Reference]	The unit of measure changes when <i>o1-03</i> changes. Outputs when: • Normal operation: Output frequency • Drive detects Frequency Reference Setting Fault: Frequency reference when the error occurs Clears the value when the drive detects a communication error or communication stops.
15E9	Drive Status (Drive 2)	
	Refer to "15E7: Drive Status (Drive 1)" for more information.	
15EA	Output frequency or frequency reference (Drive Status Bit 4: ON) (Drive 2)	The unit of measure changes when <i>o1-03</i> changes. Outputs when: • Normal operation: Output frequency • Drive detects Frequency Reference Setting Fault: Frequency reference when the error occurs Clears the value when the drive detects a communication error or communication stops.
15EB	Drive Status (Drive 3)	
	Refer to "15E7: Drive Status (Drive 1)" for more information.	

2.7 F: Options

Register No. (Hex.)	Description	
15EC	Output frequency or frequency reference (Drive Status Bit 4: ON) (Drive 3)	The unit of measure changes when <i>o1-03</i> changes. Outputs when: <ul style="list-style-type: none"> • Normal operation: Output frequency • Drive detects Frequency Reference Setting Fault: Frequency reference when the error occurs Clears the value when the drive detects a communication error or communication stops.
15ED	Drive Status (Drive 4)	Refer to "15E7: Drive Status (Drive 1)" for more information.
15EE	Output frequency or frequency reference (Drive Status Bit 4: ON) (Drive 4)	The unit of measure changes when <i>o1-03</i> changes. Outputs when: <ul style="list-style-type: none"> • Normal operation: Output frequency • Drive detects Frequency Reference Setting Fault: Frequency reference when the error occurs Clears the value when the drive detects a communication error or communication stops.
15EF	Slave Address for Reg. Access + During MEMOBUS process & ErrCode	
	bit 0 bit 1 bit 2 bit 3 bit 4 bit 5 bit 6 bit 7	00H: MEMOBUS/Modbus Communication Complete 02H: Register number not registered 21H: Upper/Lower Limit Fault 22H: Write Mode Error 23H: Write performed during <i>U_v</i> 24H: Write performed while writing parameter settings FFH: During MEMOBUS/Modbus Communication
	bit 8 bit 9 bit A	Slave address 0: Broadcast Messages (MEMOBUS) 1: Drive 1 2: Drive 2 3: Drive 3 4: Drive 4 5: Broadcast Messages (run command and frequency reference)
	bit B - F	Reserved
15F0	Register number	
15F1	Data (write register)	

■ F6-01: Communication Error Selection

No. (Hex.)	Name	Description	Default (Range)
F6-01 (03A2)	Communication Error Selection	<div style="display: flex; gap: 5px;"> V/f OLV OLV/PM AOLV/PM EZOLV </div> Sets the method to stop the motor or let the motor continue operating when the drive detects <i>bUS</i> [Option Communication Error].	1 (0 - 5)

0 : Ramp to Stop

The drive ramps the motor to stop in the deceleration time. The output terminal set for *Fault* [H2-01 to H2-03 = E] activates.

1 : Coast to Stop

The output turns off and the motor coasts to stop. The output terminal set for *Fault* [H2-01 to H2-03 = E] activates.

2 : Fast Stop (Use C1-09)

The drive stops the motor in the deceleration time set in *C1-09* [Fast Stop Time]. The output terminal set for *Fault* [H2-01 to H2-03 = E] activates.

3 : Alarm Only

The keypad shows *bUS* and the drive continues operation at the current frequency reference.

Note:

Separately prepare safety protection equipment and systems, for example fast stop switches.

The output terminal set to *Alarm* [H2-01 to H2-03 = 10] activates.

4 : Alarm (Run at d1-04)

The keypad shows *bUS* and the drive continues operation at the speed set in *d1-04* [Reference 4].

Note:

Separately prepare safety protection equipment and systems, for example fast stop switches.

5 : Alarm - Ramp Stop

The drive stops the motor during the deceleration time set in *C1-02* [Deceleration Time 1].

After you remove the *bUS* alarm, the motor will accelerate to the previous frequency reference.

■ F6-02: Comm External Fault (EF0) Detect

No. (Hex.)	Name	Description	Default (Range)
F6-02 (03A3)	Comm External Fault (EF0) Detect	<input type="checkbox"/> V/f <input type="checkbox"/> OLV <input type="checkbox"/> OLV/PM <input type="checkbox"/> AOLV/PM <input type="checkbox"/> EZOLV Sets the conditions at which <i>EF0</i> [Option Card External Fault] is detected.	0 (0, 1)

0 : Always Detected

1 : Detected during RUN Only

■ F6-03: Comm External Fault (EF0) Select

No. (Hex.)	Name	Description	Default (Range)
F6-03 (03A4)	Comm External Fault (EF0) Select	<input type="checkbox"/> V/f <input type="checkbox"/> OLV <input type="checkbox"/> OLV/PM <input type="checkbox"/> AOLV/PM <input type="checkbox"/> EZOLV Sets the method to stop the motor or let the motor continue operating when the drive detects <i>EF0</i> [Option Card External Fault].	1 (0 - 3)

0 : Ramp to Stop

The drive ramps the motor to stop in the deceleration time. The output terminal set for *Fault* [H2-01 to H2-03 = E] activates.

1 : Coast to Stop

The output turns off and the motor coasts to stop. The output terminal set for *Fault* [H2-01 to H2-03 = E] activates.

2 : Fast Stop (Use C1-09)

The drive stops the motor in the deceleration time set in *C1-09* [Fast Stop Time]. The output terminal set for *Fault* [H2-01 to H2-03 = E] activates.

3 : Alarm Only

The keypad shows *EF0* and the drive continues operation.

Note:

Separately prepare safety protection equipment and systems, for example fast stop switches.

The output terminal set to *Alarm* [H2-01 to H2-03 = 10] activates.

■ F6-04: bUS Error Detection Time

No. (Hex.)	Name	Description	Default (Range)
F6-04 (03A5)	bUS Error Detection Time	<input type="checkbox"/> V/f <input type="checkbox"/> OLV <input type="checkbox"/> OLV/PM <input type="checkbox"/> AOLV/PM <input type="checkbox"/> EZOLV Sets the delay time for the drive to detect <i>bUS</i> [Option Communication Error].	2.0 s (0.0 - 12.0 s)

Note:

When you install a CC-Link option (SI-C3) to the drive, the setting value changes to 0.0 s.

■ F6-06: Torque Reference/Limit by Comm

No. (Hex.)	Name	Description	Default (Range)
F6-06 (03A7)	Torque Reference/Limit by Comm	<input type="checkbox"/> V/f <input type="checkbox"/> OLV <input type="checkbox"/> OLV/PM <input type="checkbox"/> AOLV/PM <input type="checkbox"/> EZOLV Sets the function that enables and disables the torque reference and torque limit received from the communication option.	0 (0, 1)

0 : Disabled

1 : Enabled**■ F6-07: Multi-Step Ref @ NetRef/ComRef**

No. (Hex.)	Name	Description	Default (Range)
F6-07 (03A8)	Multi-Step Ref @ NetRef/ComRef	<div style="display: flex; gap: 5px;"> V/f OLV OLV/IPM AOLV/IPM EZOLV </div> <p>Sets the function that enables and disables the multi-step speed reference when the frequency reference source is NetRef or ComRef (communication option card or MEMOBUS/Modbus communications).</p>	1 (0, 1)

0 : Disable Multi-Step References

When NetRef or ComRef are the frequency reference source, the multi-step speed reference (2-step speed to 16-step speed references) and the Jog Frequency Reference (JOG command) are disabled.

1 : Enable Multi-Step References

When NetRef or ComRef are the frequency reference source, the multi-step speed reference (2-step speed through 16-step speed references) and the Jog Frequency Reference (JOG command) are enabled, and you can change the frequency reference.

■ F6-08: Comm Parameter Reset @Initialize

No. (Hex.)	Name	Description	Default (Range)
F6-08 (036A)	Comm Parameter Reset @Initialize	<div style="display: flex; gap: 5px;"> V/f OLV OLV/IPM AOLV/IPM EZOLV </div> <p>Sets the function to initialize F6-xx and F7-xx parameters when the drive is initialized with A1-03 [Initialize Parameters].</p>	0 (0, 1)

0 : No Reset - Parameters Retained**1 : Reset Back to Factory Default****Note:**

When you use A1-03 to initialize the drive, this setting will not change.

■ F6-10: CC-Link Node Address

No. (Hex.)	Name	Description	Default (Range)
F6-10 (03B6)	CC-Link Node Address	<div style="display: flex; gap: 5px;"> V/f OLV OLV/IPM AOLV/IPM EZOLV </div> <p>Sets the node address for CC-Link communication. Restart the drive after you change the parameter setting.</p>	0 (0 - 64)

Note:

Be sure to set a node address that is different than all other node addresses. Do not set this parameter to 0. Incorrect parameter settings will cause AEr [Station Address Setting Error] errors and the L.ERR LED on the option will come on.

When the only drive is connected, you can connect a maximum of 42 nodes. Follow these rules to connect devices that are not drives:

- $\{(1 \times a) + (2 \times b) + (3 \times c) + (4 \times d)\} \leq 64$
(a: number of units that occupies 1 node, b: number of units that occupies 2 nodes, c: number of units that occupies 3 nodes, d: number of units that occupies 4 nodes)
- $\{(16 \times A) + (54 \times B) + (88 \times C)\} \leq 2304$
(A: number of remote I/O nodes (64 max.), B: number of remote device nodes (42 max.), C: number of local nodes (26 max.))

■ F6-11: CC-Link Communication Speed

No. (Hex.)	Name	Description	Default (Range)
F6-11 (03B7)	CC-Link Communication Speed	<div style="display: flex; gap: 5px;"> V/f OLV OLV/IPM AOLV/IPM EZOLV </div> <p>Sets the communication speed for CC-Link communication. Restart the drive after you change the parameter setting.</p>	0 (0 - 4)

0 : 156 kbps

- 1 : 625 kbps
- 2 : 2.5 Mbps
- 3 : 5 Mbps
- 4 : 10 Mbps

■ F6-14: BUS Error Auto Reset

No. (Hex.)	Name	Description	Default (Range)
F6-14 (03BB)	BUS Error Auto Reset	<input type="checkbox"/> V/f <input type="checkbox"/> OLV <input type="checkbox"/> OLV/PM <input type="checkbox"/> AOLV/PM <input type="checkbox"/> EZOLV Sets the automatic reset function for <i>bUS</i> [Option Communication Errors].	0 (0, 1)

- 0 : Disable
- 1 : Enabled

■ F6-15: Comm. Option Parameters Reload

No. (Hex.)	Name	Description	Default (Range)
F6-15 (0B5B)	Comm. Option Parameters Reload	<input type="checkbox"/> V/f <input type="checkbox"/> OLV <input type="checkbox"/> OLV/PM <input type="checkbox"/> AOLV/PM <input type="checkbox"/> EZOLV Sets the update method when you change <i>F6-xx</i> , <i>F7-xx</i> [Communication Options].	0 (0 - 2)

Note:

- Set *F6-15* = 0, 1 to reload *F6-xx*, *F7-xx*.
- Set *F6-15* = 0, 1 to reset the display on the keypad to 0.

0 : Reload at Next Power Cycle

Restart the drive to update parameters.

1 : Reload Now

The changed parameters are updated without restarting the drive.

2 : Cancel Reload Request

Cancels *CyPo* [Cycle Power to Accept Changes].

■ F6-16: Gateway Mode

No. (Hex.)	Name	Description	Default (Range)
F6-16 (0B8A)	Gateway Mode	<input type="checkbox"/> V/f <input type="checkbox"/> OLV <input type="checkbox"/> OLV/PM <input type="checkbox"/> AOLV/PM <input type="checkbox"/> EZOLV Sets the gateway mode operation and the number of connected slave drives.	0 (0 to 4)

- 0 : Disabled
- 1 : Enabled: 1 Slave Drives
- 2 : Enabled: 2 Slave Drives
- 3 : Enabled: 3 Slave Drives
- 4 : Enabled: 4 Slave Drives

■ F6-20: MECHATROLINK Station Address

No. (Hex.)	Name	Description	Default (Range)
F6-20 (036B)	MECHATROLINK Station Address	<input type="checkbox"/> V/f <input type="checkbox"/> OLV <input type="checkbox"/> OLV/PM <input type="checkbox"/> AOLV/PM <input type="checkbox"/> EZOLV Sets the station address for MECHATROLINK communication. Change the parameter then cycle power on the drive.	0021h (MECHATROLINK-II: 0020h - 003Fh, MECHATROLINK-III: 0003h - 00EFh)

2.7 F: Options

Note:

- The setting range changes if using MECHATROLINK-II or MECHATROLINK-III:
 - MECHATROLINK-II (SI-T3) range: 20 to 3F
 - MECHATROLINK-III (SI-ET3) range: 03 to EF
- Be sure to set a node address that is different than all other node addresses. Incorrect parameter settings will cause *AEr* [Station Address Setting Error] errors and the L.ERR LED on the option will come on.
- The drive detects *AEr* errors when the station address is 20 or 3F.

■ F6-21: MECHATROLINK Frame Size

No. (Hex.)	Name	Description	Default (Range)
F6-21 (036C)	MECHATROLINK Frame Size	V/f OLV OLV/PM AOLV/PM EZOLV Sets the frame size for MECHATROLINK communication. Restart the drive after you change the parameter setting.	0 (0, 1)

0 : 32byte (M-2) / 64byte (M-3)

1 : 17byte (M-2) / 32byte (M-3)

■ F6-22: MECHATROLINK Link Speed

No. (Hex.)	Name	Description	Default (Range)
F6-22 (036D)	MECHATROLINK Link Speed	V/f OLV OLV/PM AOLV/PM EZOLV Sets the communications speed for MECHATROLINK-II. Restart the drive after you change the parameter setting.	0 (0, 1)

Note:

This parameter is only available with the MECHATROLINK-II option.

0 : 10 Mbps

1 : 4 Mbps

■ F6-23: MECHATROLINK Monitor Select (E)

No. (Hex.)	Name	Description	Default (Range)
F6-23 (036E)	MECHATROLINK Monitor Select (E)	V/f OLV OLV/PM AOLV/PM EZOLV Sets the MEMOBUS register used for the monitor functions of INV_CTL (drive operation control command) and INV_I/O (drive I/O control command). Restart the drive after you change the parameter setting.	0000h (0000h - FFFFh)

To enable the MEMOBUS register set in *F6-23*, set SEL_MON2/1 to 0EH or set SEL_MON3/4 and SEL_MON 5/6 to 0EH. Bytes of the response data enable the MEMOBUS register content that was set in *F6-23*.

■ F6-24: MECHATROLINK Monitor Select (F)

No. (Hex.)	Name	Description	Default (Range)
F6-24 (036F)	MECHATROLINK Monitor Select (F)	V/f OLV OLV/PM AOLV/PM EZOLV Sets the MEMOBUS register used for the monitor functions of INV_CTL (drive operation control command) and INV_I/O (drive I/O control command). Restart the drive after you change the parameter setting.	0000h (0000h - FFFFh)

To enable the MEMOBUS register set in *F6-24*, set SEL_MON2/1 to 0FH or set SEL_MON3/4 and SEL_MON 5/6 to 0FH. Bytes of the response data enable the MEMOBUS register content that was set *F6-24*.

■ F6-25: MECHATROLINK Watchdog Error Sel

No. (Hex.)	Name	Description	Default (Range)
F6-25 (03C9)	MECHATROLINK Watchdog Error Sel	V/f OLV OLV/PM AOLV/PM EZOLV Sets the method to stop the motor or let the motor continue operating when the drive detects <i>E5</i> [MECHATROLINK Watchdog Timer Err].	1 (0 - 3)

0 : Ramp to Stop

The drive ramps the motor to stop in the deceleration time. The output terminal set for *Fault [H2-01 to H2-03 = E]* activates.

1 : Coast to Stop

The output turns off and the motor coasts to stop. The output terminal set for *Fault [H2-01 to H2-03 = E]* activates.

2 : Fast Stop (Use C1-09)

The drive stops the motor in the deceleration time set in *C1-09 [Fast Stop Time]*. The output terminal set for *Fault [H2-01 to H2-03 = E]* activates.

3 : Alarm Only

The keypad shows *E5*, and the drive continues to operate.

Note:

Separately prepare safety protection equipment and systems, for example fast stop switches.

The output terminal set to *Alarm [H2-01 to H2-03 = 10]* activates.

■ F6-26: MECHATROLINK Allowable No of Err

No. (Hex.)	Name	Description	Default (Range)
F6-26 (03CA)	MECHATROLINK Allowable No of Err	<input type="checkbox"/> V/f <input type="checkbox"/> OLV <input type="checkbox"/> OLV/PM <input type="checkbox"/> AOLV/PM <input type="checkbox"/> EZOLV Sets the number of times that the option must detect a <i>bUS</i> alarm to cause a <i>bUS [Option Communication Error]</i> .	2 (2 - 10 times)

■ F6-30: PROFIBUS-DP Node Address

No. (Hex.)	Name	Description	Default (Range)
F6-30 (03CB)	PROFIBUS-DP Node Address	<input type="checkbox"/> V/f <input type="checkbox"/> OLV <input type="checkbox"/> OLV/PM <input type="checkbox"/> AOLV/PM <input type="checkbox"/> EZOLV Sets the node address for PROFIBUS-DP communication. Restart the drive after you change the parameter setting.	0 (0 - 125)

Note:

- Be sure to set a node address that is different than all other node addresses.
- Node addresses 0, 1, and 2 are usually reserved for control, maintenance, and device self-diagnosis.

■ F6-31: PROFIBUS-DP Clear Mode Selection

No. (Hex.)	Name	Description	Default (Range)
F6-31 (03CC)	PROFIBUS-DP Clear Mode Selection	<input type="checkbox"/> V/f <input type="checkbox"/> OLV <input type="checkbox"/> OLV/PM <input type="checkbox"/> AOLV/PM <input type="checkbox"/> EZOLV Sets what the drive will do after it receives the Clear Mode command.	0 (0, 1)

0 : Reset

Resets drive settings, for example frequency reference and I/O settings.

1 : Hold Previous State

The drive keeps the same status as before it received the command.

■ F6-32: PROFIBUS-DP Data Format Select

No. (Hex.)	Name	Description	Default (Range)
F6-32 (03CD)	PROFIBUS-DP Data Format Select	<input type="checkbox"/> V/f <input type="checkbox"/> OLV <input type="checkbox"/> OLV/PM <input type="checkbox"/> AOLV/PM <input type="checkbox"/> EZOLV Sets the data format of PROFIBUS-DP communication. Restart the drive after you change the parameter setting.	0 (0 - 5)

Note:

The *H5-11 [Comm ENTER Command Mode]* setting makes the RAM enter command necessary or not necessary to write parameters over network communication. When *F6-32 = 0, 1, or 2*, the *H5-11* setting does not have an effect. The RAM enter command is always necessary to write parameters.

0 : PPO Type

1 : Conventional

2 : PPO (bit0)

This function operates when bit 0 and bit 4 in the register STW have values of 1 (operate). Refer to the PROFIBUS-DP communication manual for more information.

3 : PPO (Enter)**4 : Conventional (Enter)****5 : PPO (bit0, Enter)**

This function operates when bit 0 and bit 4 in the register STW have values of 1 (operate). Refer to the PROFIBUS-DP communication manual for more information.

■ F6-35: CANopen Node ID Selection

No. (Hex.)	Name	Description	Default (Range)
F6-35 (03D0)	CANopen Node ID Selection	<input type="checkbox"/> V/f <input type="checkbox"/> OLV <input type="checkbox"/> OLV/PM <input type="checkbox"/> AOLV/PM <input type="checkbox"/> EZOLV Sets the node address for CANopen communication. Restart the drive after you change the parameter setting.	0 (0 - 126)

Note:

Be sure to set an address that is different than all other node addresses. Do not set this parameter to 0. Incorrect parameter settings will cause *AEr [Station Address Setting Error]* errors and the L.ERR LED on the option will come on.

■ F6-36: CANopen Communication Speed

No. (Hex.)	Name	Description	Default (Range)
F6-36 (03D1)	CANopen Communication Speed	<input type="checkbox"/> V/f <input type="checkbox"/> OLV <input type="checkbox"/> OLV/PM <input type="checkbox"/> AOLV/PM <input type="checkbox"/> EZOLV Sets the CANopen communications speed. Restart the drive after you change the parameter setting.	6 (0 - 8)

0 : Auto-detection

The drive detects the network communication speed and automatically adjusts the communications speed.

1 : 10 kbps**2 : 20 kbps****3 : 50 kbps****4 : 125 kbps****5 : 250 kbps****6 : 500 kbps****7 : 800 kbps****8 : 1 Mbps****■ F6-50: DeviceNet MAC Address**

No. (Hex.)	Name	Description	Default (Range)
F6-50 (03C1)	DeviceNet MAC Address	<input type="checkbox"/> V/f <input type="checkbox"/> OLV <input type="checkbox"/> OLV/PM <input type="checkbox"/> AOLV/PM <input type="checkbox"/> EZOLV Sets the MAC address for DeviceNet communication. Restart the drive after you change the parameter setting.	64 (0 - 64)

Note:

Be sure to set a MAC address that is different than all other node addresses. Do not set this parameter to 0. Incorrect parameter settings will cause *AEr [Station Address Setting Error]* errors and the MS LED on the option will flash.

■ F6-51: DeviceNet Baud Rate

No. (Hex.)	Name	Description	Default (Range)
F6-51 (03C2)	DeviceNet Baud Rate	<input type="checkbox"/> V/f <input type="checkbox"/> OLV <input type="checkbox"/> OLV/PM <input type="checkbox"/> AOLV/PM <input type="checkbox"/> EZOLV Sets the DeviceNet communications speed. Restart the drive after you change the parameter setting.	4 (0 - 4)

0 : 125 kbps

1 : 250 kbps

2 : 500 kbps

3 : Adjustable from Network

The controller sets the communications speed.

4 : Detect Automatically

The drive detects the network communication speed and automatically adjusts the communications speed.

■ F6-52: DeviceNet PCA Setting

No. (Hex.)	Name	Description	Default (Range)
F6-52 (03C3)	DeviceNet PCA Setting	<input type="checkbox"/> V/f <input type="checkbox"/> OLV <input type="checkbox"/> OLV/PM <input type="checkbox"/> AOLV/PM <input type="checkbox"/> EZOLV Sets the format of data that the DeviceNet communication master sends to the drive.	21 (0 - 255)

Note:

If F6-52 [DeviceNet PCA Setting] and F6-53 [DeviceNet PPA Setting] are not correct, the value is reset to default.

■ F6-53: DeviceNet PPA Setting

No. (Hex.)	Name	Description	Default (Range)
F6-53 (03C4)	DeviceNet PPA Setting	<input type="checkbox"/> V/f <input type="checkbox"/> OLV <input type="checkbox"/> OLV/PM <input type="checkbox"/> AOLV/PM <input type="checkbox"/> EZOLV Sets the format of data that the drive sends to the DeviceNet communication master.	71 (0 - 255)

Note:

If F6-52 [DeviceNet PCA Setting] and F6-53 [DeviceNet PPA Setting] are not correct, the value is reset to default.

■ F6-54: DeviceNet Idle Fault Detection

No. (Hex.)	Name	Description	Default (Range)
F6-54 (03C5)	DeviceNet Idle Fault Detection	<input type="checkbox"/> V/f <input type="checkbox"/> OLV <input type="checkbox"/> OLV/PM <input type="checkbox"/> AOLV/PM <input type="checkbox"/> EZOLV Sets the function to detect <i>EF0</i> [Option Card External Fault] when the drive does not receive data from the DeviceNet master.	0 (0 - 4)

0 : Enabled

1 : Disabled, No Fault Detection

This will not trigger *EF0*.

2 : Vendor Specific

3 : RUN Forward

4 : RUN Reverse

■ F6-55: DeviceNet Baud Rate Monitor

No. (Hex.)	Name	Description	Default (Range)
F6-55 (03C6)	DeviceNet Baud Rate Monitor	<input type="checkbox"/> V/f <input type="checkbox"/> OLV <input type="checkbox"/> OLV/PM <input type="checkbox"/> AOLV/PM <input type="checkbox"/> EZOLV Sets the function to see the actual DeviceNet communications speed using the keypad. This parameter functions as a monitor only.	0 (0 - 2)

0 : 125 kbps

1 : 250 kbps

2 : 500 kbps

■ F6-56: DeviceNet Speed Scaling

No. (Hex.)	Name	Description	Default (Range)
F6-56 (03D7)	DeviceNet Speed Scaling	<input type="checkbox"/> V/f <input type="checkbox"/> OLV <input type="checkbox"/> OLV/PM <input type="checkbox"/> AOLV/PM <input type="checkbox"/> EZOLV Sets the speed scale for DeviceNet communication.	0 (-15 - +15)

■ F6-57: DeviceNet Current Scaling

No. (Hex.)	Name	Description	Default (Range)
F6-57 (03D8)	DeviceNet Current Scaling	<input type="checkbox"/> V/f <input type="checkbox"/> OLV <input type="checkbox"/> OLV/IPM <input type="checkbox"/> AOLV/IPM <input type="checkbox"/> EZOLV Sets the current scale of the DeviceNet communication master.	0 (-15 - +15)

■ F6-58: DeviceNet Torque Scaling

No. (Hex.)	Name	Description	Default (Range)
F6-58 (03D9)	DeviceNet Torque Scaling	<input type="checkbox"/> V/f <input type="checkbox"/> OLV <input type="checkbox"/> OLV/IPM <input type="checkbox"/> AOLV/IPM <input type="checkbox"/> EZOLV Sets the torque scale of the DeviceNet communication master.	0 (-15 - +15)

■ F6-59: DeviceNet Power Scaling

No. (Hex.)	Name	Description	Default (Range)
F6-59 (03DA)	DeviceNet Power Scaling	<input type="checkbox"/> V/f <input type="checkbox"/> OLV <input type="checkbox"/> OLV/IPM <input type="checkbox"/> AOLV/IPM <input type="checkbox"/> EZOLV Sets the power scale of the DeviceNet communication master.	0 (-15 - +15)

■ F6-60: DeviceNet Voltage Scaling

No. (Hex.)	Name	Description	Default (Range)
F6-60 (03DB)	DeviceNet Voltage Scaling	<input type="checkbox"/> V/f <input type="checkbox"/> OLV <input type="checkbox"/> OLV/IPM <input type="checkbox"/> AOLV/IPM <input type="checkbox"/> EZOLV Sets the voltage scale of the DeviceNet communication master.	0 (-15 - +15)

■ F6-61: DeviceNet Time Scaling

No. (Hex.)	Name	Description	Default (Range)
F6-61 (03DC)	DeviceNet Time Scaling	<input type="checkbox"/> V/f <input type="checkbox"/> OLV <input type="checkbox"/> OLV/IPM <input type="checkbox"/> AOLV/IPM <input type="checkbox"/> EZOLV Sets the time scale of the DeviceNet communication master.	0 (-15 - +15)

■ F6-62: DeviceNet Heartbeat Interval

No. (Hex.)	Name	Description	Default (Range)
F6-62 (03DD)	DeviceNet Heartbeat Interval	<input type="checkbox"/> V/f <input type="checkbox"/> OLV <input type="checkbox"/> OLV/IPM <input type="checkbox"/> AOLV/IPM <input type="checkbox"/> EZOLV Sets the heartbeat for DeviceNet communication. Set this parameter to 0 to disable the heartbeat function.	0 (0 - 10)

■ F6-63: DeviceNet Network MAC ID

No. (Hex.)	Name	Description	Default (Range)
F6-63 (03DE)	DeviceNet Network MAC ID	<input type="checkbox"/> V/f <input type="checkbox"/> OLV <input type="checkbox"/> OLV/IPM <input type="checkbox"/> AOLV/IPM <input type="checkbox"/> EZOLV Sets the function to see the actual DeviceNet MAC address using the keypad. This parameter functions as a monitor only.	63 (0 - 63)

■ F6-64 to F6-67: Dynamic Out Assembly 109 Param1 to 4

No. (Hex.)	Name	Description	Default (Range)
F6-64 to F6-67 (03DF - 03E2)	Dynamic Out Assembly 109 Param 1 to 4	<input type="checkbox"/> V/f <input type="checkbox"/> OLV <input type="checkbox"/> OLV/IPM <input type="checkbox"/> AOLV/IPM <input type="checkbox"/> EZOLV Sets Configurable Outputs 1 to 4 written to the MEMOBUS register.	0000H (0000H - FFFFH)

■ F6-68 to F6-71: Dynamic In Assembly 159 Param 1 to 4

No. (Hex.)	Name	Description	Default (Range)
F6-68 to F6-71 (03E3, 03E4, 03C7, and 03C8)	Dynamic In Assembly 159 Param 1 to 4	V/f OLV OLV/PM AOLV/PM EZOLV Sets Configurable Inputs 1 to 4 read from the MEMOBUS register.	0000H (0000H - FFFFH)

■ F6-72: PowerLink Node Address

No. (Hex.)	Name	Description	Default (Range)
F6-72 (081B)	PowerLink Node Address	V/f OLV OLV/PM AOLV/PM EZOLV Sets the node ID for PowerLink communication.	0 (0 - 255)

■ F7-01: IP Address 1

No. (Hex.)	Name	Description	Default (Range)
F7-01 (03E5)	IP Address 1	V/f OLV OLV/PM AOLV/PM EZOLV Sets the first octet of the IP Address for the device that is connecting to the network. Restart the drive after you change this parameter.	192 (0 - 255)

Note:

When $F7-13 = 0$ [Address Mode at Startup = Static]:

- Use parameters $F7-01$ to $F7-04$ [IP Address 1 to 4] to set the IP Address. Be sure to set a different IP address for each drive on the network.
- Also set parameters $F7-05$ to $F7-12$ [Subnet Mask 1 to 4, Gateway Address 1 to 4].

■ F7-02: IP Address 2

No. (Hex.)	Name	Description	Default (Range)
F7-02 (03E6)	IP Address 2	V/f OLV OLV/PM AOLV/PM EZOLV Sets the second octet of the IP Address for the device that is connecting to the network. Restart the drive after you change this parameter.	168 (0 - 255)

Note:

When $F7-13 = 0$ [Address Mode at Startup = Static]:

- Use parameters $F7-01$ to $F7-04$ [IP Address 1 to 4] to set the IP Address. Be sure to set a different IP address for each drive on the network.
- Also set parameters $F7-05$ to $F7-12$ [Subnet Mask 1 to 4, Gateway Address 1 to 4].

■ F7-03: IP Address 3

No. (Hex.)	Name	Description	Default (Range)
F7-03 (03E7)	IP Address 3	V/f OLV OLV/PM AOLV/PM EZOLV Sets the third octet of the IP Address for the device that is connecting to the network. Restart the drive after you change this parameter.	1 (0 - 255)

Note:

When $F7-13 = 0$ [Address Mode at Startup = Static]:

- Use parameters $F7-01$ to $F7-04$ [IP Address 1 to 4] to set the IP Address. Be sure to set a different IP address for each drive on the network.
- Also set parameters $F7-05$ to $F7-12$ [Subnet Mask 1 to 4, Gateway Address 1 to 4].

■ F7-04: IP Address 4

No. (Hex.)	Name	Description	Default (Range)
F7-04 (03E8)	IP Address 4	V/f OLV OLV/PM AOLV/PM EZOLV Sets the fourth octet of the IP Address for the device that is connecting to the network. Restart the drive after you change this parameter.	20 (0 - 255)

Note:

When $F7-13 = 0$ [Address Mode at Startup = Static]:

- Use parameters $F7-01$ to $F7-04$ [IP Address 1 to 4] to set the IP Address. Be sure to set a different IP address for each drive on the network.
- Also set parameters $F7-05$ to $F7-12$ [Subnet Mask 1 to 4, Gateway Address 1 to 4].

■ F7-05: Subnet Mask 1

No. (Hex.)	Name	Description	Default (Range)
F7-05 (03E9)	Subnet Mask 1	<div style="display: flex; gap: 5px;"> V/f OLV OLV/IPM AOLV/IPM EZOLV </div> Sets the first octet of the subnet mask of the connected network.	255 (0 - 255)

Note:

Set this parameter when $F7-13 = 0$ [Address Mode at Startup = Static].

■ F7-06: Subnet Mask 2

No. (Hex.)	Name	Description	Default (Range)
F7-06 (03EA)	Subnet Mask 2	<div style="display: flex; gap: 5px;"> V/f OLV OLV/IPM AOLV/IPM EZOLV </div> Sets the second octet of the subnet mask of the connected network.	255 (0 - 255)

Note:

Set this parameter when $F7-13 = 0$ [Address Mode at Startup = Static].

■ F7-07: Subnet Mask 3

No. (Hex.)	Name	Description	Default (Range)
F7-07 (03EB)	Subnet Mask 3	<div style="display: flex; gap: 5px;"> V/f OLV OLV/IPM AOLV/IPM EZOLV </div> Sets the third octet of the subnet mask of the connected network.	255 (0 - 255)

Note:

Set this parameter when $F7-13 = 0$ [Address Mode at Startup = Static].

■ F7-08: Subnet Mask 4

No. (Hex.)	Name	Description	Default (Range)
F7-08 (03EC)	Subnet Mask 4	<div style="display: flex; gap: 5px;"> V/f OLV OLV/IPM AOLV/IPM EZOLV </div> Sets the fourth octet of the subnet mask of the connected network.	0 (0 - 255)

Note:

Set this parameter when $F7-13 = 0$ [Address Mode at Startup = Static].

■ F7-09: Gateway Address 1

No. (Hex.)	Name	Description	Default (Range)
F7-09 (03ED)	Gateway Address 1	<div style="display: flex; gap: 5px;"> V/f OLV OLV/IPM AOLV/IPM EZOLV </div> Sets the first octet of the gateway address of the connected network.	192 (0 - 255)

Note:

Set this parameter when $F7-13 = 0$ [Address Mode at Startup = Static].

■ F7-10: Gateway Address 2

No. (Hex.)	Name	Description	Default (Range)
F7-10 (03EE)	Gateway Address 2	<div style="display: flex; gap: 5px;"> V/f OLV OLV/IPM AOLV/IPM EZOLV </div> Sets the second octet of the gateway address of the connected network.	168 (0 - 255)

Note:

Set this parameter when $F7-13 = 0$ [Address Mode at Startup = Static].

■ F7-11: Gateway Address 3

No. (Hex.)	Name	Description	Default (Range)
F7-11 (03EF)	Gateway Address 3	V/f OLV OLV/PM AOLV/PM EZOLV Sets the third octet of the gateway address of the connected network.	1 (0 - 255)

Note:

Set this parameter when $F7-13 = 0$ [Address Mode at Startup = Static].

■ F7-12: Gateway Address 4

No. (Hex.)	Name	Description	Default (Range)
F7-12 (03F0)	Gateway Address 4	V/f OLV OLV/PM AOLV/PM EZOLV Sets the fourth octet of the gateway address of the connected network.	1 (0 - 255)

Note:

Set this parameter when $F7-13 = 0$ [Address Mode at Startup = Static].

■ F7-13: Address Mode at Startup

No. (Hex.)	Name	Description	Default (Range)
F7-13 (03F1)	Address Mode at Startup	V/f OLV OLV/PM AOLV/PM EZOLV Sets the method to set option card IP addresses.	2 (0 - 2)

0 : Static

1 : BOOTP

2 : DHCP

Note:

• The following setting values are available when using the PROFINET communication option card (SI-EP3).

–0: Static

–2: DCP

• When $F7-13 = 0$, set parameters $F7-01$ to $F7-12$ [IP Address 1 to Gateway Address 4] to set the IP Address. Be sure to set a different IP address for each drive on the network.

■ F7-14: Duplex Mode Selection

No. (Hex.)	Name	Description	Default (Range)
F7-14 (03F2)	Duplex Mode Selection	V/f OLV OLV/PM AOLV/PM EZOLV Sets the duplex mode setting method.	1 (0 - 8)

0 : Half/Half

1 : Auto/Auto

2 : Full/Full

3 : Half/Auto

Port 1 is set to “Half” and port 2 is set to “Auto”.

4 : Half/Full

Port 1 is set to “Half” and port 2 is set to “Full”.

5 : Auto/Half

Port 1 is set to “Auto” and port 2 is set to “Half”.

6 : Auto/Full

Port 1 is set to “Auto” and port 2 is set to “Full”.

7 : Full/Half

Port 1 is set to “Full” and port 2 is set to “Half”.

8 : Full/Auto

Port 1 is set to “Full” and port 2 is set to “Auto”.

■ F7-15: Communication Speed Selection

No. (Hex.)	Name	Description	Default (Range)
F7-15 (03F3)	Communication Speed Selection	<input type="checkbox"/> V/f <input type="checkbox"/> OLV <input type="checkbox"/> OLV/PM <input type="checkbox"/> AOLV/PM <input type="checkbox"/> EZOLV Sets the communications speed.	10 (10, 100 - 102)

10 : 10/10 Mbps**100 : 100/100 Mbps****101 : 10/100 Mbps****102 : 100/10 Mbps****Note:**

Set this parameter when *F7-14 = 0* or *2* [*Duplex Mode Selection = Half/Half or Full/Full*].

■ F7-16: Timeout Value

No. (Hex.)	Name	Description	Default (Range)
F7-16 (03F4)	Timeout Value	<input type="checkbox"/> V/f <input type="checkbox"/> OLV <input type="checkbox"/> OLV/PM <input type="checkbox"/> AOLV/PM <input type="checkbox"/> EZOLV Sets the detection time for a communications timeout.	0.0 s (0.0 - 30.0 s)

Note:

Set this parameter to 0.0 to disable the connection timeout function.

■ F7-17: EtherNet/IP Speed Scaling Factor

No. (Hex.)	Name	Description	Default (Range)
F7-17 (03F5)	EtherNet/IP Speed Scaling Factor	<input type="checkbox"/> V/f <input type="checkbox"/> OLV <input type="checkbox"/> OLV/PM <input type="checkbox"/> AOLV/PM <input type="checkbox"/> EZOLV Sets the scaling factor for the speed monitor in the EtherNet/IP Class ID 2AH Object.	0 (-15 - +15)

■ F7-18: EtherNet/IP Current Scale Factor

No. (Hex.)	Name	Description	Default (Range)
F7-18 (03F6)	EtherNet/IP Current Scale Factor	<input type="checkbox"/> V/f <input type="checkbox"/> OLV <input type="checkbox"/> OLV/PM <input type="checkbox"/> AOLV/PM <input type="checkbox"/> EZOLV Sets the scaling factor for the output current monitor in the EtherNet/IP Class ID 2AH Object.	0 (-15 - +15)

■ F7-19: EtherNet/IP Torque Scale Factor

No. (Hex.)	Name	Description	Default (Range)
F7-19 (03F7)	EtherNet/IP Torque Scale Factor	<input type="checkbox"/> V/f <input type="checkbox"/> OLV <input type="checkbox"/> OLV/PM <input type="checkbox"/> AOLV/PM <input type="checkbox"/> EZOLV Sets the scaling factor for the torque monitor in the EtherNet/IP Class ID 2AH Object.	0 (-15 - +15)

■ F7-20: EtherNet/IP Power Scaling Factor

No. (Hex.)	Name	Description	Default (Range)
F7-20 (03F8)	EtherNet/IP Power Scaling Factor	<input type="checkbox"/> V/f <input type="checkbox"/> OLV <input type="checkbox"/> OLV/PM <input type="checkbox"/> AOLV/PM <input type="checkbox"/> EZOLV Sets the scaling factor for the power monitor in the EtherNet/IP Class ID 2AH Object.	0 (-15 - +15)

■ F7-21: EtherNet/IP Voltage Scale Factor

No. (Hex.)	Name	Description	Default (Range)
F7-21 (03F9)	EtherNet/IP Voltage Scale Factor	<input type="checkbox"/> V/f <input type="checkbox"/> OLV <input type="checkbox"/> OLV/PM <input type="checkbox"/> AOLV/PM <input type="checkbox"/> EZOLV Sets the scaling factor for the voltage monitor in the EtherNet/IP Class ID 2AH Object.	0 (-15 - +15)

■ F7-22: EtherNet/IP Time Scaling

No. (Hex.)	Name	Description	Default (Range)
F7-22 (03FA)	EtherNet/IP Time Scaling	V/f OLV OLV/PM AOLV/PM EZOLV Sets the scaling factor for the time monitor in the EtherNet/IP Class ID 2AH Object.	0 (-15 - +15)

■ F7-23 to F7-32: Dynamic Out Param 1 to 10 for CommCard

No. (Hex.)	Name	Description	Default (Range)
F7-23 to F7-27 (03FB - 03FF) F7-28 to F7-32 (0370 - 0374)	Dynamic Out Param 1 to 10 for CommCard	V/f OLV OLV/PM AOLV/PM EZOLV When you use an Ethernet/IP option, sets Output Assembly 116. The drive writes the values from Output Assembly 116 to the MEMOBUS/Modbus address register that is stored for each parameter. The drive will not write the values from Output Assembly 116 to the registers when the MEMOBUS/Modbus address is 0. When you use a ProfiNet option, set <i>F7-23</i> to <i>F7-27</i> to configurable Output 1-5.	0

■ F7-33 to F7-42: Dynamic In Param 1 to 10 for CommCard

No. (Hex.)	Name	Description	Default (Range)
F7-33 to F7-42 (0375 - 037E)	Dynamic In Param 1 to 10 for CommCard	V/f OLV OLV/PM AOLV/PM EZOLV When you use an Ethernet/IP option, sets Input Assembly 166. The drive sends the values from the MEMOBUS/Modbus address registers stored for each parameter to Input Assembly 166. The drive returns the default register value for the option card when the MEMOBUS/Modbus address is 0 and the value sent to Input Assembly 166 is not defined. When you use a ProfiNet option, set <i>F7-33</i> to <i>F7-37</i> to configurable inputs 1-5.	0

■ F7-60: PZD1 Write (Control Word)

No. (Hex.)	Name	Description	Default (Range)
F7-60 (0780)	PZD1 Write (Control Word)	V/f OLV OLV/PM AOLV/PM EZOLV When you use a Profibus option, set the MEMOBUS/Modbus address for PZD1 (PPO output). PZD1 (PPO output) functions as the STW when <i>F7-60</i> = 0 to 2.	0

■ F7-61: PZD2 Write (Frequency Reference)

No. (Hex.)	Name	Description	Default (Range)
F7-61 (0781)	PZD2 Write (Frequency Reference)	V/f OLV OLV/PM AOLV/PM EZOLV When you use a Profibus option, sets the MEMOBUS/Modbus address for PZD2 (PPO output). PZD2 (PPO output) functions as the HSW when <i>F7-61</i> = 0 to 2.	0

■ F7-62: PZD3 Write

No. (Hex.)	Name	Description	Default (Range)
F7-62 (0782)	PZD3 Write	V/f OLV OLV/PM AOLV/PM EZOLV When you use a Profibus option, sets the MEMOBUS/Modbus address for PZD3 (PPO output). A value of 0, 1, or 2 will disable the PZD3 (PPO output) write operation to the MEMOBUS/Modbus register.	0

■ F7-63: PZD4 Write

No. (Hex.)	Name	Description	Default (Range)
F7-63 (0783)	PZD4 Write	V/f OLV OLV/PM AOLV/PM EZOLV When you use a Profibus option, sets the MEMOBUS/Modbus address for PZD4 (PPO output). A value of 0, 1, or 2 will disable the PZD4 (PPO output) write operation to the MEMOBUS/Modbus register.	0

■ F7-64: PZD5 Write

No. (Hex.)	Name	Description	Default (Range)
F7-64 (0784)	PZD5 Write	<p>V/f OLV OLV/PM AOLV/PM EZOLV</p> <p>When you use a Profibus option, sets the MEMOBUS/Modbus address for PZD5 (PPO output). A value of 0, 1, or 2 will disable the PZD5 (PPO output) write operation to the MEMOBUS/Modbus register.</p>	0

■ F7-65: PZD6 Write

No. (Hex.)	Name	Description	Default (Range)
F7-65 (0785)	PZD6 Write	<p>V/f OLV OLV/PM AOLV/PM EZOLV</p> <p>When you use a Profibus option, sets the MEMOBUS/Modbus address for PZD6 (PPO output). A value of 0, 1, or 2 will disable the PZD6 (PPO output) write operation to the MEMOBUS/Modbus register.</p>	0

■ F7-66: PZD7 Write

No. (Hex.)	Name	Description	Default (Range)
F7-66 (0786)	PZD7 Write	<p>V/f OLV OLV/PM AOLV/PM EZOLV</p> <p>When you use a Profibus option, sets the MEMOBUS/Modbus address for PZD7 (PPO output). A value of 0, 1, or 2 will disable the PZD7 (PPO output) write operation to the MEMOBUS/Modbus register.</p>	0

■ F7-67: PZD8 Write

No. (Hex.)	Name	Description	Default (Range)
F7-67 (0787)	PZD8 Write	<p>V/f OLV OLV/PM AOLV/PM EZOLV</p> <p>When you use a Profibus option, sets the MEMOBUS/Modbus address for PZD8 (PPO output). A value of 0, 1, or 2 will disable the PZD8 (PPO output) write operation to the MEMOBUS/Modbus register.</p>	0

■ F7-68: PZD9 Write

No. (Hex.)	Name	Description	Default (Range)
F7-68 (0788)	PZD9 Write	<p>V/f OLV OLV/PM AOLV/PM EZOLV</p> <p>When you use a Profibus option, sets the MEMOBUS/Modbus address for PZD9 (PPO output). A value of 0, 1, or 2 will disable the PZD9 (PPO output) write operation to the MEMOBUS/Modbus register.</p>	0

■ F7-69: PZD10 Write

No. (Hex.)	Name	Description	Default (Range)
F7-69 (0789)	PZD10 Write	<p>V/f OLV OLV/PM AOLV/PM EZOLV</p> <p>When you use a Profibus option, sets the MEMOBUS/Modbus address for PZD10 (PPO output). A value of 0, 1, or 2 will disable the PZD10 (PPO output) write operation to the MEMOBUS/Modbus register.</p>	0

■ F7-70: PZD1 Read (Status Word)

No. (Hex.)	Name	Description	Default (Range)
F7-70 (078A)	PZD1 Read (Status Word)	<p>V/f OLV OLV/PM AOLV/PM EZOLV</p> <p>When you use a Profibus option, sets the MEMOBUS/Modbus address for PZD1 (PPO input). PZD1 (PPO input) functions as the ZSW when $F7-70 = 0$.</p>	0

■ F7-71: PZD2 Read (Output Frequency)

No. (Hex.)	Name	Description	Default (Range)
F7-71 (078B)	PZD2 Read (Output Frequency)	<p>V/f OLV OLV/PM AOLV/PM EZOLV</p> <p>When you use a Profibus option, sets the MEMOBUS/Modbus address for PZD2 (PPO input). PZD2 (PPO input) functions as the HIW when <i>F7-71 = 0</i>.</p>	0

■ F7-72: PZD3 Read

No. (Hex.)	Name	Description	Default (Range)
F7-72 (078C)	PZD3 Read	<p>V/f OLV OLV/PM AOLV/PM EZOLV</p> <p>When you use a Profibus option, sets the MEMOBUS/Modbus address for PZD3 (PPO input). A value of 0 will disable the PZD3 (PPO input) load operation from the MEMOBUS/Modbus register.</p>	0

■ F7-73: PZD4 Read

No. (Hex.)	Name	Description	Default (Range)
F7-73 (078D)	PZD4 Read	<p>V/f OLV OLV/PM AOLV/PM EZOLV</p> <p>When you use a Profibus option, sets the MEMOBUS/Modbus address for PZD4 (PPO input). A value of 0 will disable the PZD4 (PPO input) load operation from the MEMOBUS/Modbus register.</p>	0

■ F7-74: PZD5 Read

No. (Hex.)	Name	Description	Default (Range)
F7-74 (078E)	PZD5 Read	<p>V/f OLV OLV/PM AOLV/PM EZOLV</p> <p>When you use a Profibus option, sets the MEMOBUS/Modbus address for PZD5 (PPO input). A value of 0 will disable the PZD5 (PPO input) load operation from the MEMOBUS/Modbus register.</p>	0

■ F7-75: PZD6 Read

No. (Hex.)	Name	Description	Default (Range)
F7-75 (078F)	PZD6 Read	<p>V/f OLV OLV/PM AOLV/PM EZOLV</p> <p>When you use a Profibus option, sets the MEMOBUS/Modbus address for PZD6 (PPO input). A value of 0 will disable the PZD6 (PPO input) load operation from the MEMOBUS/Modbus register.</p>	0

■ F7-76: PZD7 Read

No. (Hex.)	Name	Description	Default (Range)
F7-76 (0790)	PZD7 Read	<p>V/f OLV OLV/PM AOLV/PM EZOLV</p> <p>When you use a Profibus option, sets the MEMOBUS/Modbus address for PZD7 (PPO input). A value of 0 will disable the PZD7 (PPO input) load operation from the MEMOBUS/Modbus register.</p>	0

■ F7-77: PZD8 Read

No. (Hex.)	Name	Description	Default (Range)
F7-77 (0791)	PZD8 Read	<p>V/f OLV OLV/PM AOLV/PM EZOLV</p> <p>When you use a Profibus option, sets the MEMOBUS/Modbus address for PZD8 (PPO input). A value of 0 will disable the PZD8 (PPO input) load operation from the MEMOBUS/Modbus register.</p>	0

■ F7-78: PZD9 Read

No. (Hex.)	Name	Description	Default (Range)
F7-78 (0792)	PZD9 Read	<p>V/f OLV OLV/PM AOLV/PM EZOLV</p> <p>When you use a Profibus option, sets the MEMOBUS/Modbus address for PZD9 (PPO input). A value of 0 will disable the PZD9 (PPO input) load operation from the MEMOBUS/Modbus register.</p>	0

■ F7-79: PZD10 Read

No. (Hex.)	Name	Description	Default (Range)
F7-79 (0793)	PZD10 Read	V/f OLV OLV/PM AOLV/PM EZOLV When you use a Profibus option, sets the MEMOBUS/Modbus address for PZD10 (PPO input). A value of 0 will disable the PZD10 (PPO input) load operation from the MEMOBUS/Modbus register.	0

2.8 H: Terminal Function Selection

H parameters set functions for external input and output terminals.

◆ H1: Digital Inputs

H1 Parameters set the MFDI terminal functions.

■ H1-01 to H1-07 Terminal S1 to S7 Function Selection

The drive has 7 MFDI terminals. Refer to [Table 2.45](#) for drive default settings and functions.

Table 2.45 MFDI Default Settings and Functions

No.	Name	Default	Function
H1-01	Terminal S1 Function Selection	40 (F) <i>*I</i>	Forward RUN (2-Wire)
H1-02	Terminal S2 Function Selection	41 (F) <i>*I</i>	Reverse RUN (2-Wire)
H1-03	Terminal S3 Function Selection	24	External Fault (NO-Always-Coast)
H1-04	Terminal S4 Function Selection	14	Fault Reset
H1-05	Terminal S5 Function Selection	3 (0) <i>*I</i>	Multi-Step Speed Reference 1
H1-06	Terminal S6 Function Selection	4 (3) <i>*I</i>	Multi-Step Speed Reference 2
H1-07	Terminal S7 Function Selection	6 (4) <i>*I</i>	Jog Reference Selection

*1 The value in parentheses identifies the default setting when you set $A1-03 = 3330$ [Initialize Parameters = 3-Wire Initialization]. Refer to the [Table 2.46](#) and use *H1-xx* [MFDI Function Select] to set the function.

Table 2.46 MFDI Setting Values

Setting Value	Function	Ref.	Setting Value	Function	Ref.
0 <i>*I</i>	3-Wire Sequence	291	17 <i>*I</i>	Fast Stop (N.C.)	298
1	LOCAL/REMOTE Selection	292	18	Timer Function	299
2	External Reference 1/2 Selection	292	19	PID Disable	299
3	Multi-Step Speed Reference 1	292	1A	Accel/Decel Time Selection 2	299
4	Multi-Step Speed Reference 2	292	1B <i>*2</i>	Programming Lockout	299
5	Multi-Step Speed Reference 3	293	1E	Reference Sample Hold	299
6	Jog Reference Selection	293	20 to 2F <i>*I</i>	External Fault	300
7	Accel/Decel Time Selection 1	293	30	PID Integrator Reset	301
8 <i>*I</i>	Baseblock Command (N.O.)	293	31	PID Integrator Hold	301
9 <i>*I</i>	Baseblock Command (N.C.)	293	32	Multi-Step Speed Reference 4	301
A	Accel/Decel Ramp Hold	294	34	PID Soft Starter Disable	301
B	Overheat Alarm (oH2)	294	35	PID Input (Error) Invert	302
C	Analog Terminal Enable Selection	294	3E	PID Setpoint Selection 1	302
E	ASR Integral Reset	294	3F	PID Setpoint Selection 2	302
F	Through Mode	294	40 <i>*I</i>	Forward RUN (2-Wire)	302
10	Up Command	294	41 <i>*I</i>	Reverse RUN (2-Wire)	302
11	Down Command	296	42 <i>*I</i>	Run Command (2-Wire Sequence 2)	303
12 <i>*I</i>	Forward Jog	297	43 <i>*I</i>	FWD/REV (2-Wire Sequence 2)	303
13 <i>*I</i>	Reverse Jog	297	44	Add Offset Frequency 1 (d7-03)	303
14	Fault Reset	297	45	Add Offset Frequency 2 (d7-03)	303
15 <i>*I</i>	Fast Stop (N.O.)	297	46	Add Offset Frequency 3 (d7-03)	303
16	Motor 2 Selection	298	47	Node Setup (CANopen)	304

2.8 H: Terminal Function Selection

Setting Value	Function	Ref.
60	DC Injection Braking Command	304
61	Speed Search from Fmax	304
62	Speed Search from Fref	304
63	Field Weakening	305
65 */	KEB Ride-Thru 1 Activate (N.C.)	305
66 */	KEB Ride-Thru 1 Activate (N.O.)	305
67	Communications Test Mode	305
68	High Slip Braking (HSB) Activate	305
6A	Drive Enable	306
75	Up 2 Command	306
76	Down 2 Command	307
77	ASR Gain (C5-03) Select	307

Setting Value	Function	Ref.
78	Analog TorqueRef Polarity Invert	307
7A */	KEB Ride-Thru 2 Activate (N.C.)	308
7B */	KEB Ride-Thru 2 Activate (N.O.)	308
7C */	Short Circuit Braking (N.O.)	308
7D */	Short Circuit Braking (N.C.)	308
7E	Reverse Rotation Identifier	309
90 to 96 */	DWEZ Digital Inputs 1 to 7	309
9F	DWEZ Disable	309
101 - 19F	Inverse Inputs of 1 to 9F Sets the function of the selected MFDI to operate inversely. To select the function for inverse input, enter two digits 01 to 9F for the "xx" in "1xx".	309

*1 Inverse input is not available.

*2 You cannot use H7-01 to H7-04 [Virtual Multi-Function Input 1 to 4] to set this.

■ H1-01: Terminal S1 Function Selection

No. (Hex.)	Name	Description	Default (Range)
H1-01 (0438)	Terminal S1 Function Selection	<input type="checkbox"/> V/f <input type="checkbox"/> OLV <input type="checkbox"/> OLV/PM <input type="checkbox"/> AOLV/PM <input type="checkbox"/> EZOLV Sets the function for MFDI terminal S1.	40 (1 - 1FF)

Note:

The default setting is *F* when you initialize the drive for *3-Wire Initialization* [A1-03 = 3330].

■ H1-02: Terminal S2 Function Selection

No. (Hex.)	Name	Description	Default (Range)
H1-02 (0439)	Terminal S2 Function Selection	<input type="checkbox"/> V/f <input type="checkbox"/> OLV <input type="checkbox"/> OLV/PM <input type="checkbox"/> AOLV/PM <input type="checkbox"/> EZOLV Sets the function for MFDI terminal S2.	41 (1 - 1FF)

Note:

The default setting is *F* when you initialize the drive for *3-Wire Initialization* [A1-03 = 3330].

■ H1-03: Terminal S3 Function Selection

No. (Hex.)	Name	Description	Default (Range)
H1-03 (0400)	Terminal S3 Function Selection	<input type="checkbox"/> V/f <input type="checkbox"/> OLV <input type="checkbox"/> OLV/PM <input type="checkbox"/> AOLV/PM <input type="checkbox"/> EZOLV Sets the function for MFDI terminal S3.	24 (0 - 1FF)

■ H1-04: Terminal S4 Function Selection

No. (Hex.)	Name	Description	Default (Range)
H1-04 (0401)	Terminal S4 Function Selection	<input type="checkbox"/> V/f <input type="checkbox"/> OLV <input type="checkbox"/> OLV/PM <input type="checkbox"/> AOLV/PM <input type="checkbox"/> EZOLV Sets the function for MFDI terminal S4.	14 (0 - 1FF)

■ H1-05: Terminal S5 Function Selection

No. (Hex.)	Name	Description	Default (Range)
H1-05 (0402)	Terminal S5 Function Selection	<input type="checkbox"/> V/f <input type="checkbox"/> OLV <input type="checkbox"/> OLV/PM <input type="checkbox"/> AOLV/PM <input type="checkbox"/> EZOLV Sets the function for MFDI terminal S5.	3 (0 - 1FF)

Note:

The default setting is 0 when the drive is initialized for *3-Wire Initialization* [A1-03 = 3330].

■ H1-06: Terminal S6 Function Selection

No. (Hex.)	Name	Description	Default (Range)
H1-06 (0403)	Terminal S6 Function Selection	V/f OLV OLV/PM AOLV/PM EZOLV Sets the function for MFDI terminal S6.	4 (0 - 1FF)

Note:

The default setting is 3 when the drive is initialized for *3-Wire Initialization* [A1-03 = 3330].

■ H1-07: Terminal S7 Function Selection

No. (Hex.)	Name	Description	Default (Range)
H1-07 (0404)	Terminal S7 Function Selection	V/f OLV OLV/PM AOLV/PM EZOLV Sets the function for MFDI terminal S7.	6 (0 - 1FF)

Note:

The default setting is 4 when the drive is initialized for *3-Wire Initialization* [A1-03 = 3330].

■ H1-21: Terminal S1 Function Select 2

No. (Hex.)	Name	Description	Default (Range)
H1-21 (0B70)	Terminal S1 Function Selection 2	V/f OLV OLV/PM AOLV/PM EZOLV Sets the second function for MFDI terminal S1.	F (1 - 19F)

When MFDI terminal S1 activates, it will operate the function set to *H1-01* [Terminal S1 Function Selection] and the function set to *H1-21* at the same time.

When the setting value is *F*, the function is disabled.

■ H1-22: Terminal S2 Function Select 2

No. (Hex.)	Name	Description	Default (Range)
H1-22 (0B71)	Terminal S2 Function Select 2	V/f OLV OLV/PM AOLV/PM EZOLV Sets the second function for MFDI terminal S2.	F (1 - 19F)

When MFDI terminal S2 activates, it will operate the function set to *H1-02* [Terminal S2 Function Selection] and the function set to *H1-22* at the same time.

When the setting value is *F*, the function is disabled.

■ H1-23: Terminal S3 Function Select 2

No. (Hex.)	Name	Description	Default (Range)
H1-23 (0B72)	Terminal S3 Function Selection 2	V/f OLV OLV/PM AOLV/PM EZOLV Sets the second function for MFDI terminal S3.	F (1 - 19F)

When MFDI terminal S3 activates, it will operate the function set to *H1-03* [Terminal S3 Function Selection] and the function set to *H1-23* at the same time.

When the setting value is *F*, the function is disabled.

■ H1-24: Terminal S4 Function Selection 2

No. (Hex.)	Name	Description	Default (Range)
H1-24 (0B73)	Terminal S4 Function Selection 2	V/f OLV OLV/PM AOLV/PM EZOLV Sets the second function for MFDI terminal S4.	F (1 - 19F)

2.8 H: Terminal Function Selection

When MFDI terminal S4 activates, it will operate the function set to *H1-04* [Terminal S4 Function Selection] and the function set to *H1-24* at the same time.

When the setting value is *F*, the function is disabled.

■ H1-25: Terminal S5 Function Select 2

No. (Hex.)	Name	Description	Default (Range)
H1-25 (0B74)	Terminal S5 Function Selection 2	<div style="display: flex; gap: 5px;"> V/f OLV OLV/PM AOLV/PM EZOLV </div> Sets the second function for MFDI terminal S5.	F (1 - 19F)

When MFDI terminal S5 activates, it will operate the function set to *H1-05* [Terminal S5 Function Selection] and the function set to *H1-25* at the same time.

When the setting value is *F*, the function is disabled.

■ H1-26: Terminal S6 Function Select 2

No. (Hex.)	Name	Description	Default (Range)
H1-26 (0B75)	Terminal S6 Function Selection 2	<div style="display: flex; gap: 5px;"> V/f OLV OLV/PM AOLV/PM EZOLV </div> Sets the second function for MFDI terminal S6.	F (1 - 19F)

When MFDI terminal S6 activates, it will operate the function set to *H1-06* [Terminal S6 Function Selection] and the function set to *H1-26* at the same time.

When the setting value is *F*, the function is disabled.

■ H1-27: Terminal S7 Function Select 2

No. (Hex.)	Name	Description	Default (Range)
H1-27 (0B76)	Terminal S7 Function Selection 2	<div style="display: flex; gap: 5px;"> V/f OLV OLV/PM AOLV/PM EZOLV </div> Sets the second function for MFDI terminal S7.	F (1 - 19F)

When MFDI terminal S7 activates, it will operate the function set to *H1-07* [Terminal S7 Function Selection] and the function set to *H1-27* at the same time.

When the setting value is *F*, the function is disabled.

■ MEMOBUS/Modbus MFDI 1 to 3 Function Selection

You can set the function for the MFDI to MEMOBUS register *bit 0 to 2* of [15C0(Hex.)]. Use *H1-40 to H1-42* [Extend MFDI Function Selection] to select the bit function for each bit.

Note:

- Refer to [MFDI Setting Values on page 291](#) for more information about MFDI setting values.
- You cannot set values *0* [3-Wire Sequence] and *20 to 2F* [External Fault] for *H1-40 to H1-42*.
- When you will not use *H1-40 to H1-42*, set them to *F* [Through Mode].

■ H1-40: Mbus Reg 15C0h bit0 Input Func

No. (Hex.)	Name	Description	Default (Range)
H1-40 (0B54)	Mbus Reg 15C0h bit0 Input Func	<div style="display: flex; gap: 5px;"> V/f OLV OLV/PM AOLV/PM EZOLV </div> Sets MFDI function to set to <i>bit 0</i> of the MEMOBUS register <i>15C0</i> (Hex.).	F (1 - 19F)

■ H1-41: Mbus Reg 15C0h bit1 Input Func

No. (Hex.)	Name	Description	Default (Range)
H1-41 (0B55)	Mbus Reg 15C0h bit1 Input Func	<div style="display: flex; gap: 5px;"> V/f OLV OLV/PM AOLV/PM EZOLV </div> Sets MFDI function to set to <i>bit 1</i> of the MEMOBUS register <i>15C0</i> (Hex.).	F (1 - 19F)

■ H1-42: Mbus Reg 15C0h bit2 Input Func

No. (Hex.)	Name	Description	Default (Range)
H1-42 (0B56)	Mbus Reg 15C0h bit2 Input Func	V/f OLV OLV/PM AOLV/PM EZOLV Sets MFDI function to set to bit 2 of the MEMOBUS register 15C0 (Hex.).	F (1 - 19F)

◆ MFDI Setting Values

Selects a function set with H1-01 to H1-42.

■ 0: 3-Wire Sequence

Setting Value	Function	Description
0	3-Wire Sequence	V/f OLV OLV/PM AOLV/PM EZOLV Sets the direction of motor rotation for 3-wire sequence.

If the 3-wire sequence is set to a terminal that is not MFDI terminals S1 and S2, these terminals will be the input terminals for Forward run/Reverse run command. The drive will automatically set terminal S1 to Run command (RUN) and terminal S2 to Stop command (STOP).

When terminal S1 (Run command) activates for 1 ms minimum, the drive rotates the motor. When terminal S2 (Stop command) deactivates, the drive stops. When terminal Sx that is set in 3-wire sequence deactivates, the drive operates in the forward direction, and when it activates, the drive operates in the reverse direction.

WARNING! Sudden Movement Hazard. Set the MFDI parameters before you close control circuit switches. Incorrect Run/Stop circuit sequence settings can cause serious injury or death from moving equipment.

WARNING! Sudden Movement Hazard. When you use a 3-Wire sequence, set A1-03 = 3330 [Initialize Parameters = 3-Wire Initialization] and make sure that b1-17 = 0 [Run Command at Power Up = Disregard Existing RUN Command] (default). If you do not correctly set the drive parameters for 3-Wire operation before you energize the drive, the motor can suddenly rotate when you energize the drive.

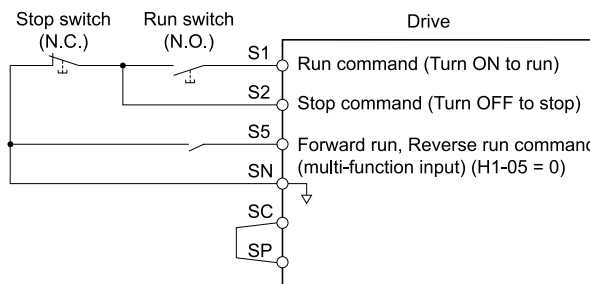

Figure 2.56 3-Wire Sequence Wiring Example

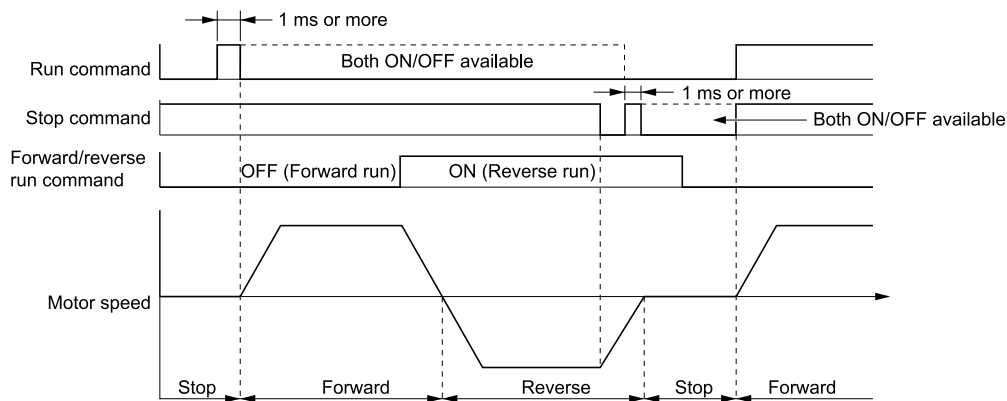



Figure 2.57 3-Wire Sequence Time Chart





2.8 H: Terminal Function Selection

Note:



- To input the Run command, activate the terminal for 1 ms minimum.
- The default setting for *b1-17 [Run Command at Power Up]* is 0 [Disregard existing RUN command]. If you enable the Run command on an

energized drive, the protective function activates and the  flashes quickly. When the application will let an energized drive Run, set *b1-17 = 1 [Accept Existing RUN Command]*.

■ 1: LOCAL/REMOTE Selection

Setting Value	Function	Description
1	LOCAL/REMOTE Selection	     Sets drive control for the keypad (LOCAL) or an external source (REMOTE).

Note:

- When the MFDI terminal sets the LOCAL/REMOTE selection,  on the keypad is disabled.
- When LOCAL Mode is selected, the green light for  comes on.
- When the Run command is ON, you cannot switch between LOCAL Mode and REMOTE Mode.





ON : LOCAL

The keypad is the Frequency reference source and Run command source.

OFF : REMOTE

The frequency reference and Run command settings are set in *b1-01, b1-02 [Frequency Reference Selection 1/2]* or *b1-15, b1-16 [Run Command Selection 1/2]*.

■ 2: External Reference 1/2 Selection

Setting Value	Function	Description
2	External Reference 1/2 Selection	     Sets the drive to use Run command source 1/2 or Reference command source 1/2 when in REMOTE Mode.

Note:

The ability to switch the Run command source and frequency reference source depends on the setting of *b1-07 [LOCAL/REMOTE Run Selection]*.





Table 2.47 Ability to Switch the Run Command Source and Frequency Reference Source when Inputting the Run Command

<i>b1-07</i>	Run command source	Frequency reference source
0 [Disregard Existing RUN Command] (Default)	No	Yes
1 [Accept Existing RUN Command]	Yes	Yes

ON : *b1-15 [Frequency Reference Selection 2], b1-16 [Run Command Selection 2]*

OFF : *b1-01 [Frequency Reference Selection 1], b1-02 [Run Command Selection 1]*





■ 3: Multi-Step Speed Reference 1

Setting Value	Function	Description
3	Multi-Step Speed Reference 1	     Uses speed references <i>d1-01 to d1-16</i> to set a multi-step speed reference.

Note:

Refer to [Setting Procedures for Multi-step Speed Operation on page 225](#) for more information.

■ 4: Multi-Step Speed Reference 2

Setting Value	Function	Description
4	Multi-Step Speed Reference 2	     Uses speed references <i>d1-01 to d1-16</i> to set a multi-step speed reference.

Note:

Refer to [Setting Procedures for Multi-step Speed Operation on page 225](#) for more information.

■ 5: Multi-Step Speed Reference 3

Setting Value	Function	Description
5	Multi-Step Speed Reference 3	V/f OLV OLV/PM AOLV/PM EZOLV Uses speed references <i>d1-01</i> to <i>d1-16</i> to set a multi-step speed reference.

Note:

Refer to [Setting Procedures for Multi-step Speed Operation on page 225](#) for more information.

■ 6: Jog Reference Selection

Setting Value	Function	Description
6	Jog Reference Selection	V/f OLV OLV/PM AOLV/PM EZOLV Sets the drive to use the JOG Frequency Reference (JOG command) set in <i>d1-17</i> . The JOG Frequency Reference (JOG command) overrides <i>Frequency References 1 to 16 (d1-01 to d1-16)</i> .

■ 7: Accel/Decel Time Selection 1

Setting Value	Function	Description
7	Accel/Decel Time Selection 1	V/f OLV OLV/PM AOLV/PM EZOLV Sets the drive to use <i>Acceleration/Deceleration Time 1 [C1-01, C1-02]</i> or <i>Acceleration/Deceleration Time 2 [C1-03, C1-04]</i> .

Note:

Refer to [C1: Accel & Decel Time on page 203](#) for more information.

■ 8: Baseblock Command (N.O.)

Setting Value	Function	Description
8	Baseblock Command (N.O.)	V/f OLV OLV/PM AOLV/PM EZOLV Sets the command that stops drive output and coasts the motor to stop when the input is ON.

WARNING! Incorrect Operation. Yaskawa recommends that you use *H1-xx = 9 [Baseblock Command (N.C.)]*. If a circuit error occurs in the MFDI, the drive cannot stop the output when the terminal set to *H1-xx = 8 [Baseblock Command (N.O.)]* turns ON.

The keypad flashes *bb [Baseblock]*. If you cancel the baseblock command when the Run command is active, the drive will restart the motor and use the speed search function.

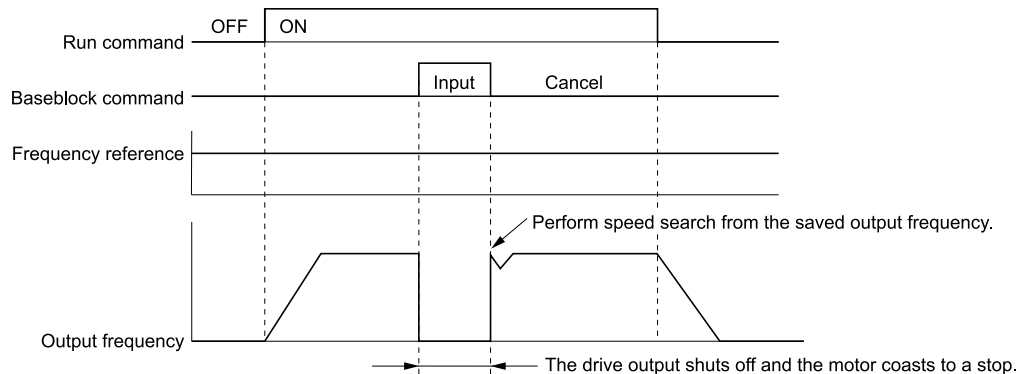

Figure 2.58 Baseblock Command Time Chart

ON : Baseblock (drive output stop)

OFF : Normal operation

■ 9: Baseblock Command (N.C.)

Setting Value	Function	Description
9	Baseblock Command (N.C.)	V/f OLV OLV/PM AOLV/PM EZOLV Sets the command that stops drive output and coasts the motor to stop when the input terminal is OFF.

The keypad flashes *bb [Baseblock]*. If you cancel the baseblock command when the Run command is active, the drive will restart the motor and use the speed search function.

ON : Normal operation

OFF : Baseblock (drive output stop)**■ A: Accel/Decel Ramp Hold**

Setting Value	Function	Description
A	Accel/Decel Ramp Hold	<div style="display: flex; justify-content: space-between; align-items: center;"> V/f OLV OLV/IPM AOLV/IPM EZOLV </div> <p>Momentarily pauses motor acceleration and deceleration when the terminal is turned ON, retains the output frequency that was stored in the drive at the time of the pause, and restarts motor operation.</p>

If the terminal is deactivated, the drive restarts acceleration and deceleration.

When the acceleration/deceleration ramp hold terminal is activated and $d4-01 = 1$ [*Freq Reference Retention Select = Enabled*], the drive will store the output frequency in memory. While the acceleration/deceleration ramp hold command is activated, the drive will always restart the motor at this output frequency.

Note:

Refer to [d4-01: Freq Reference Hold Selection on page 233](#) for more information.

■ B: Overheat Alarm (oH2)

Setting Value	Function	Description
B	Overheat Alarm (oH2)	<div style="display: flex; justify-content: space-between; align-items: center;"> V/f OLV OLV/IPM AOLV/IPM EZOLV </div> <p>Sets the drive to show an oH2 [<i>External Overheat (HI-XX=B)</i>] alarm when the input terminal is ON. The alarm does not have an effect on drive operation.</p>

■ C: Analog Terminal Enable Selection

Setting Value	Function	Description
C	Analog Terminal Enable Selection	<div style="display: flex; justify-content: space-between; align-items: center;"> V/f OLV OLV/IPM AOLV/IPM EZOLV </div> <p>Sets the command that enables or disables the terminals selected in H3-14 [<i>Analog Input Terminal Enable Sel</i>].</p>

ON : Terminal selected with [H3-14](#) is enabled

OFF : Terminal selected with [H3-14](#) is disabled

■ E: ASR Integral Reset

Setting Value	Function	Description
E	ASR Integral Reset	<div style="display: flex; justify-content: space-between; align-items: center;"> V/f OLV OLV/IPM AOLV/IPM EZOLV </div> <p>Sets the command to reset the integral value and use PI control or P control for the speed control loop.</p>

ON : P control

OFF : PI control

■ F: Not Used

Setting Value	Function	Description
F	Not Used	<div style="display: flex; justify-content: space-between; align-items: center;"> V/f OLV OLV/IPM AOLV/IPM EZOLV </div> <p>Use this setting for unused terminals or to use terminals in through mode.</p>

Through Mode uses the signal input to the terminal as a digital input for the upper sequence through a communication option or MEMOBUS/Modbus communications. This input signal does not have an effect on drive operation.

■ 10: Up Command

Setting Value	Function	Description
10	Up Command	<div style="display: flex; justify-content: space-between; align-items: center;"> V/f OLV OLV/IPM AOLV/IPM EZOLV </div> <p>Sets the command to use a push button switch to increase the drive frequency reference. You must also set Setting 11 [<i>Down Command</i>].</p>

ON : Increases the frequency reference.

OFF : Holds the current frequency reference.

Note:

- If you set only the Up command or only the Down command, the drive will detect *oPE03 [Multi-Function Input Setting Err]*.
- If you set two or more of these functions at the same time, the drive will detect *oPE03*:
 - Up/Down command
 - Accel/Decel Ramp Hold
 - Reference Sample Hold
 - Offset Frequency 1, 2, 3 addition
 - Up/Down 2 Command
- The Up/Down command does not function in these conditions:
 - b1-01 = 2, 3 [Frequency Reference Selection 1 = Memobus/Modbus Communications, Option PCB]*
 - b1-02 ≠ 1 [Run Command Selection 1 ≠ Control Circuit Terminal]*
 - Drive is in LOCAL mode
 - Set to *b1-15 [Frequency Reference Selection 2]* by use of *H1-xx = 2 [MFDI Function Select = External Reference 1/2 Selection]*

When you enter the UP command, the frequency reference increases.

The Up and Down commands have priority over all other frequency references. When you enable the Up/Down command, the drive will ignore these frequency references:

- Frequency reference from Keypad [*b1-01 = 0*]
- Frequency reference from Analog Input [*b1-01 = 1*]
- Frequency reference from Pulse Train Input [*b1-01 = 4*]

Table 2.48 shows the Up and Down commands with their operation.

Table 2.48 Up Command and Down Command

Command status		Drive operation
Up command (10)	Down command (11)	
OFF	OFF	Keeps the current frequency reference.
ON	OFF	Increases the frequency reference.
OFF	ON	Decreases the frequency reference.
ON	ON	Keeps the current frequency reference.

Combine Frequency Reference Hold Functions and Up/Down Commands

- When you clear the Run command or when *d4-01 = 0 [Freq Reference Hold Selection = Disabled]*, and you restart the drive, the Up/Down command resets to 0.
- When *d4-01 = 1 [Enabled]*, the drive saves the frequency reference set during the Up/Down command. When you cycle the Run command or restart the drive, the drive saves the frequency reference value and restarts the motor at this frequency value. After you clear the Run command, activate the terminal set for the Up command or Down command to set the saved reference value to 0.

Note:

Refer to *d4-01: Freq Reference Hold Selection on page 233* for more information.

Combine Upper/Lower Limits of the Frequency Reference and the Up/Down Commands

Set the upper limit value of the frequency reference to *d2-01 [Frequency Reference Upper Limit]*.

Use an analog input or *d2-02 [Frequency Reference Lower Limit]* to set the lower limit value of the frequency reference. The configurable values change when the setting for *d4-10 [Up/Down Freq Lower Limit Select]* changes. When you input a Run command, these are the lower limits of the frequency reference:

- When the lower limit of the frequency reference is set only for *d2-02*, the drive accelerates the motor to the lower limit value of the frequency reference at the same time that you input the Run command.
- When the lower limit of the frequency reference is set only for analog input, the drive accelerates the motor to the lower limit value of the frequency reference when the Run command, and Up command or Down command for the drive is enabled. When only the Run command is enabled, the motor does not start.
- When these conditions occur, the drive accelerates the motor to the *d2-02* setting value when the Run command is input. When the motor accelerates to the setting value of *d2-02*, if the Up/Down command is enabled, the motor accelerates to the lower limit value of the analog input.
 - The lower limit value of the frequency reference is set for the analog input and *d2-02*

– The lower limit value of the analog input is higher than the setting value of *d2-02*

Note:

Refer to *d4-01: Freq Reference Hold Selection on page 233* for more information.

Figure 2.59 shows an example of how Up/Down command operates. In this example, the lower limit value of the frequency reference is set in *d2-02*. Figure 2.59 shows the time chart when Freq Reference Retention Select [*d4-01*] is enabled and disabled.

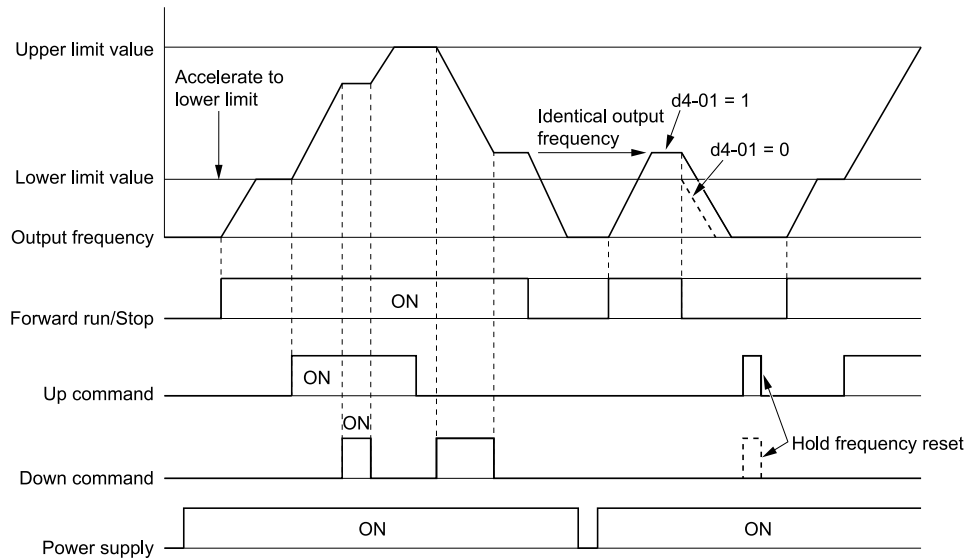

Figure 2.59 Up/Down Command Time Chart

■ 11: Down Command

Setting Value	Function	Description
11	Down Command	<div style="display: flex; gap: 5px;"> V/f OLV OLV/PM AOLV/PM EZOLV </div> <p>Sets the command to use a push button switch to decrease the drive frequency reference. You must also set <i>Setting 10 [Up Command]</i>.</p>

ON : Decreases the frequency reference.

OFF : Holds the current frequency reference.

Note:

- If you set only the Up command or only the Down command, the drive will detect *oPE03 [Multi-Function Input Setting Err]*.
- If you set two or more of these functions at the same time, the drive will detect *oPE03*:
 - Up/Down command
 - Accel/Decel Ramp Hold
 - Reference Sample Hold
 - Offset Frequency 1, 2, 3 addition
 - Up/Down 2 Command
- The Up/Down command does not function in these conditions:
 - *b1-01 = 2, 3 [Frequency Reference Selection 1 = Memobus/Modbus Communications, Option PCB]*
 - *b1-02 ≠ 1 [Run Command Selection 1 ≠ Control Circuit Terminal]*
 - Drive is in LOCAL mode
 - Set to *b1-15 [Frequency Reference Selection 2]* by use of *H1-xx = 2 [MFDI Function Select = External Reference 1/2 Selection]*

When you enter the UP command, the frequency reference increases. When you enter the Down command, the frequency reference decreases.

The Up and Down commands have priority over all other frequency references. When you enable the Up/Down command, the drive will ignore these frequency references:

- Frequency reference from Keypad [*b1-01 = 0*]
- Frequency reference from Analog Input [*b1-01 = 1*]
- Frequency reference from Pulse Train Input [*b1-01 = 4*]

12: Forward Jog

Setting Value	Function	Description
12	Forward Jog	<div style="display: flex; gap: 5px;"> V/f OLV OLV/PM AOLV/PM EZOLV </div> Sets the command to operate the motor in the forward direction at the Jog Frequency set in <i>d1-17</i> [Jog Reference].

Note:

- It is not necessary to input the Run command.
- The Forward JOG command has priority over all other frequency references.
- When the Forward JOG and Reverse JOG commands are activated at the same time for 500 ms or longer, the drive will ramp to stop.

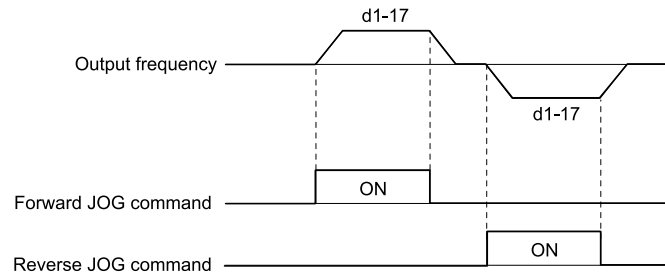

Figure 2.60 JOG Operation Pattern

13: Reverse Jog

Setting Value	Function	Description
13	Reverse Jog	<div style="display: flex; gap: 5px;"> V/f OLV OLV/PM AOLV/PM EZOLV </div> Sets the command to operate the motor in the reverse direction at the Jog Frequency set in <i>d1-17</i> [Jog Reference].

Note:

- It is not necessary to input the Run command.
- The Reverse JOG command has priority over all other frequency references.
- When the Forward JOG and Reverse JOG commands are activated at the same time for 500 ms or longer, the drive will ramp to stop.

14: Fault Reset

Setting Value	Function	Description
14	Fault Reset	<div style="display: flex; gap: 5px;"> V/f OLV OLV/PM AOLV/PM EZOLV </div> Sets the command to reset the current fault when the Run command is inactive.

If the drive detects a fault, the drive will activate the fault relay output, turn off the output, and the motor will coast to stop.

If the drive detects a fault for which you can set the stopping method, apply the appropriate Stopping Method. Then push  (RESET) on the keypad to turn the Run command OFF, or activate the fault reset terminal to reset the fault.

Note:

The drive ignores the fault reset command when the Run command is active. Remove the Run command before trying to reset a fault.

15: Fast Stop (N.O.)

Setting Value	Function	Description
15	Fast Stop (N.O.)	<div style="display: flex; gap: 5px;"> V/f OLV OLV/PM AOLV/PM EZOLV </div> Sets the command to ramp to stop in the deceleration time set in <i>C1-09</i> [Fast Stop Time] when the input terminal is ON while the drive is operating.

WARNING! Incorrect Operation. Yaskawa recommends that you use *H1-xx = 17* [Fast Stop (N.C.)]. If a circuit error occurs in the MFDI, the drive cannot stop the output when the terminal set to *H1-xx = 15* [Fast Stop (N.O.)] turns ON.

If you cancel the fast stop input, the drive will not restart the motor until you meet these conditions:

- Fully stop the motor
- Cancel the Run command
- Cancel the fast stop command

Note:

- To use the N.C. switch to input the fast stop command, set $H1-xx = 17$ [Fast Stop (N.C.)].
- Refer to *C1-09: Fast Stop Time on page 206* for more information.
- Set *C1-09 [Fast Stop Time]* to a correct deceleration time. If the deceleration time is too short, it can cause an overvoltage fault, which will not stop the motor from coasting.

■ 16: Motor 2 Selection

Setting Value	Function	Description
16	Motor 2 Selection	<div style="display: flex; gap: 5px;"> V/f OLV OLV/PM AOLV/PM EZOLV </div> <p>Sets the command for the drive to operate motor 1 or motor 2. Stop the motors before switching.</p>

You can use an external input to switch operation between two induction motors. The drive will save the control methods, V/f patterns, and motor parameters for the two motors.

ON : Operate motor 2

OFF : Operate motor 1

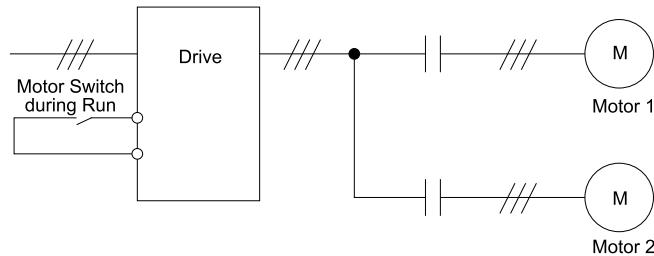

When you select motor 2, the drive will switch to motor 2 parameters.

Table 2.49 Parameters that Switch between Motor 1 and Motor 2

Parameter	Motor 2 Selection	
	OFF (Motor 1)	ON (Motor 2)
C1-xx [Accel & Decel Time]	C1-01 to C1-04	C1-05 to C1-08
C3-xx [Slip Compensation]	C3-01 to C3-04	C3-21 to C3-24
C4-xx [Torque Compensation]	C4-01	C4-07
C5-xx [Automatic Speed Regulator (ASR)]	C5-01 to C5-08, C5-12	-
E1-xx, E3-xx [V/f Patterns] E2-xx, E4-xx [Motor Parameters]	E1-xx, E2-xx	E3-xx, E4-xx

Note:

- When you use 2 motors, the drive applies the protective function set in *L1-01 [Motor Overload Protection Select]* to motor 1 and motor 2.
- You cannot switch between motors 1 and 2 during run. If you try to switch motors when they are running, it will cause a *rUn* error.
- You must wait 200 ms minimum to input a Run command.

■ 17: Fast Stop (N.C.)

Setting Value	Function	Description
17	Fast Stop (N.C.)	<div style="display: flex; gap: 5px;"> V/f OLV OLV/PM AOLV/PM EZOLV </div> <p>Sets the command to ramp to stop in the deceleration time set in <i>C1-09 [Fast Stop Time]</i> when the input terminal is ON while the drive is operating.</p>

If you cancel the fast stop input, the drive will not restart the motor until you meet these conditions:

- Fully stop the motor
- Cancel the Run command
- Cancel the fast stop command

Note:

- To use the N.O. switch to input the fast stop command, set 15 (Fast Stop (N.O.)).
- Refer to *C1-09: Fast Stop Time on page 206* for more information.
- Set *C1-09 [Fast Stop Time]* to a correct deceleration time. If the deceleration time is too short, it can cause an overvoltage fault and failure to stop the motor from coasting.

Figure 2.61 shows an example of how fast stop operates.

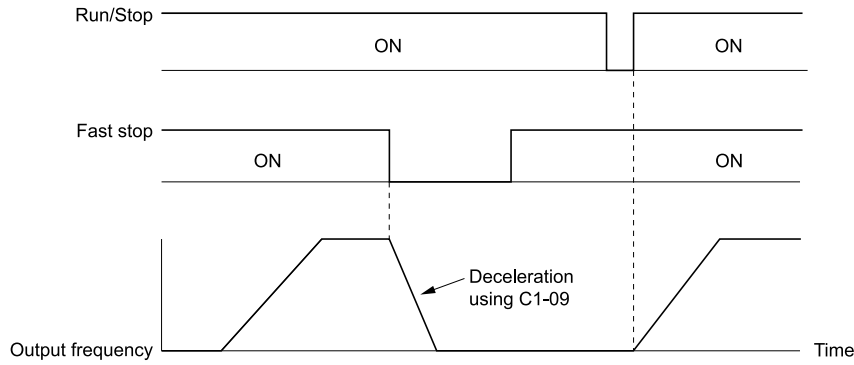

Figure 2.61 Fast Stop Time Chart

18: Timer Function

Setting Value	Function	Description
18	Timer Function	<input type="checkbox"/> V/f <input type="checkbox"/> OLV <input type="checkbox"/> OLV/PM <input type="checkbox"/> AOLV/PM <input type="checkbox"/> EZOLV Sets the command to start the timer function. Use this setting with <i>Timer Output</i> [H2-xx = 12].

Note:

Refer to [b4: Timer Function on page 179](#) for more information.

19: PID Disable

Setting Value	Function	Description
19	PID Disable	<input type="checkbox"/> V/f <input type="checkbox"/> OLV <input type="checkbox"/> OLV/PM <input type="checkbox"/> AOLV/PM <input type="checkbox"/> EZOLV Sets the command to disable PID control when <i>b5-01 = 1 to 8</i> [PID Mode Setting = Enabled].

ON : PID control disabled

OFF : PID control enabled

1A: Accel/Decel Time Selection 2

Setting Value	Function	Description
1 A	Accel/Decel Time Selection 2	<input type="checkbox"/> V/f <input type="checkbox"/> OLV <input type="checkbox"/> OLV/PM <input type="checkbox"/> AOLV/PM <input type="checkbox"/> EZOLV Set this function and <i>H1-xx = 7</i> [Accel/Decel Time Selection 1] together. Sets the drive to use <i>Acceleration/Deceleration Time 3</i> [C1-05, C1-06] or <i>Acceleration/Deceleration Time 4</i> [C1-07, C1-08].

Note:

Refer to [C1: Accel & Decel Time on page 203](#) for more information.

1B: Programming Lockout

Setting Value	Function	Description
1B	Programming Lockout	<input type="checkbox"/> V/f <input type="checkbox"/> OLV <input type="checkbox"/> OLV/PM <input type="checkbox"/> AOLV/PM <input type="checkbox"/> EZOLV Sets the command to prevent parameter changes when the terminal is OFF.

You can continue to view parameter setting values when the terminal is OFF [Parameter Write Prohibit].

ON : Programming Lockout

OFF : Parameter Write Prohibit

1E: Reference Sample Hold

Setting Value	Function	Description
1E	Reference Sample Hold	<input type="checkbox"/> V/f <input type="checkbox"/> OLV <input type="checkbox"/> OLV/PM <input type="checkbox"/> AOLV/PM <input type="checkbox"/> EZOLV Sets the command to sample the frequency reference at terminal A1 or A2, and hold the frequency reference at that frequency.

When the terminal is active for 100 ms, this function reads a sample of the analog frequency reference and holds that sample. When you input the sample/hold command again, the function again reads a sample of the analog frequency

reference and holds that sample. When you turn off the power, the drive erases the saved analog frequency and resets the frequency reference to 0.

Figure 2.62 shows an example of how the function operates.

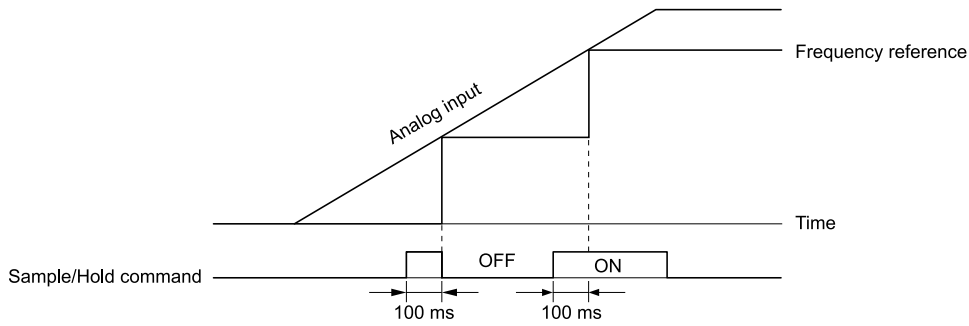

Figure 2.62 Reference Sample Hold

You cannot set the Reference Sample Hold function at the same time as these functions:

- H1-xx = A [Accel/Decel Ramp Hold]
- H1-xx = 10, 11 [Up Command, Down Command]
- H1-xx = 44 to 46 [Add Offset Frequency 1 to 3]
- H1-xx = 75, 76 [Up 2 Command, Down 2 Command]

If you set them at the same time, the drive will detect oPE03 [Multi-Function Input Setting Err].

■ 20 to 2F: External Fault

Setting Value	Function	Description
20 to 2F	External Fault	<div style="display: flex; gap: 5px;"> V/f OLV OLV/PM AOLV/PM EZOLV </div> Sets a command to stop the drive when a failure or fault occurs on an external device.

WARNING! Incorrect Operation. Yaskawa recommends that you use H1-xx = 21, 23, 25, 27, 29, 2B, 2D, 2F [External Fault (N.C.)]. If a circuit error occurs in the MFDI, the drive cannot stop the output when the terminal set to H1-xx = 20, 22, 24, 26, 28, 2A, 2C, 2E [External Fault (N.O.)] turns ON.

If an external fault is input to the drive, the keypad will show EFx [External Fault (Terminal Sx)], where x is the number of the terminal (terminal Sx) to which the external fault signal is assigned. For example, when an external fault signal is input to terminal S3, the keypad will show EF3 [External Fault (Terminal S3)].

Use these conditions to select the value to set in H1-xx:

- Signal input method from peripheral devices
- External fault detection method
- Motor stopping method (operation after external fault detection)

Table 2.50 shows the relation between the conditions and the value set to H1-xx.

Table 2.50 Stopping Methods for External Fault

Setting	Signal Input Method from Peripheral Devices *1		External Fault Detection Method *2		Stopping Method			
	N.O.	N.C.	Always Detected	Detected during RUN Only	Ramp to Stop (Fault)	Coast to Stop (Fault)	Fast Stop (Fault)	Continuous Operation (Alarm Only)
20	x	-	x	-	x	-	-	-
21	-	x	x	-	x	-	-	-
22	x	-	-	x	x	-	-	-
23	-	x	-	x	x	-	-	-
24	x	-	x	-	-	x	-	-
25	-	x	x	-	-	x	-	-
26	x	-	-	x	-	x	-	-
27	-	x	-	x	-	x	-	-

Setting	Signal Input Method from Peripheral Devices ^{*1}		External Fault Detection Method ^{*2}		Stopping Method			
	N.O.	N.C.	Always Detected	Detected during RUN Only	Ramp to Stop (Fault)	Coast to Stop (Fault)	Fast Stop (Fault)	Continuous Operation (Alarm Only)
28	x	-	x	-	-	-	x	-
29	-	x	x	-	-	-	x	-
2A	x	-	-	x	-	-	x	-
2B	-	x	-	x	-	-	x	-
2C	x	-	x	-	-	-	-	x
2D	-	x	x	-	-	-	-	x
2E	x	-	-	x	-	-	-	x
2F	-	x	-	x	-	-	-	x

*1 Set the terminal to N.O. (detects external fault when switched ON) or N.C. (detects external fault when switched OFF).

*2 Set the drive to always detect each fault or to detect only during run.

30: PID Integrator Reset

Setting Value	Function	Description
30	PID Integrator Reset	<div style="display: flex; gap: 5px;"> V/f OLV OLV/PM AOLV/PM EZOLV </div> Sets the command to reset and hold the PID control integral to 0 when the terminal is ON.

Note:

Refer to [b5: PID control on page 181](#) for more information.

31: PID Integrator Hold

Setting Value	Function	Description
31	PID Integrator Hold	<div style="display: flex; gap: 5px;"> V/f OLV OLV/PM AOLV/PM EZOLV </div> Sets the command to hold the integral value of the PID control while the terminal is activated.

When you turn off the input terminal, PID control restarts the integral.

Note:

Refer to [b5: PID control on page 181](#) for more information.

32: Multi-Step Speed Reference 4

Setting Value	Function	Description
32	Multi-Step Speed Reference ⁴	<div style="display: flex; gap: 5px;"> V/f OLV OLV/PM AOLV/PM EZOLV </div> Uses speed references <i>d1-01</i> to <i>d1-16</i> to set a multi-step speed reference.

Note:

Refer to [Setting Procedures for Multi-step Speed Operation on page 225](#) for more information.

34: PID Soft Starter Disable

Setting Value	Function	Description
34	PID Soft Starter Disable	<div style="display: flex; gap: 5px;"> V/f OLV OLV/PM AOLV/PM EZOLV </div> Sets the PID soft starter function.

ON : Disable

Disables *b5-17* [PID Accel/Decel Time].

OFF : Enabled

Enables *b5-17* [PID Accel/Decel Time].

Note:

Refer to [b5: PID control on page 181](#) for more information.

■ 35: PID Input (Error) Invert

Setting Value	Function	Description
35	PID Input (Error) Invert	<div style="display: flex; justify-content: space-between; align-items: center;"> V/f OLV OLV/PM AOLV/PM EZOLV </div> <p>Sets the command to turn the terminal ON and OFF to switch the PID input level (polarity).</p>

Note:

Refer to [b5: PID control on page 181](#) for more information.

■ 3E: PID Setpoint Selection 1

Setting Value	Function	Description
3E	PID Setpoint Selection 1	<div style="display: flex; justify-content: space-between; align-items: center;"> V/f OLV OLV/PM AOLV/PM EZOLV </div> <p>Set this function and $H1-xx = 3F$ [PID Setpoint Selection 2] together. Sets the function to switch the PID setpoint to $b5-58$ to $b5-60$ [PID Setpoint 2 to 4].</p>

Refer to [b5-58 to b5-60: PID Setpoints 2 to 4 on page 194](#) for more information.

■ 3F: PID Setpoint Selection 2

Setting Value	Function	Description
3F	PID Setpoint Selection 2	<div style="display: flex; justify-content: space-between; align-items: center;"> V/f OLV OLV/PM AOLV/PM EZOLV </div> <p>Set this function and $H1-xx = 3E$ [PID Setpoint Selection 1] at the same time. Sets the function to switch the PID setpoint to $b5-58$ to $b5-60$ [PID Setpoint 2 to 4].</p>

Refer to [b5-58 to b5-60: PID Setpoints 2 to 4 on page 194](#) for more information.

■ 40: Forward RUN (2-Wire)

Setting Value	Function	Description
40	Forward RUN (2-Wire)	<div style="display: flex; justify-content: space-between; align-items: center;"> V/f OLV OLV/PM AOLV/PM EZOLV </div> <p>Sets the Forward Run command for 2-wire sequence 1. Set this function and $H1-xx = 41$ [Reverse RUN (2-Wire)] together.</p>

ON : Forward Run

OFF : Stop

Note:

- If you turn ON the Forward Run command terminal and the Reverse Run command terminal, it will cause an *EF [FWD/REV Run Command Input Error]* alarm and the motor will ramp to stop.
- Initialize the drive with a 2-wire sequence to set the Forward Run command to terminal S1.
- This function will not operate at the same time as $H1-xx = 42, 43$ [Run Command (2-Wire Sequence 2), FWD/REV (2-Wire Sequence 2)].

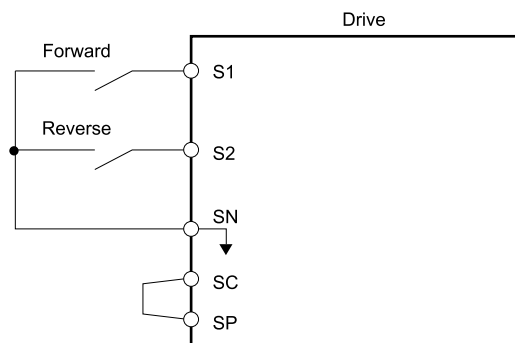

Figure 2.63 2-Wire Sequence Wiring Example

■ 41: Reverse RUN (2-Wire)

Setting Value	Function	Description
41	Reverse RUN (2-Wire)	<div style="display: flex; justify-content: space-between; align-items: center;"> V/f OLV OLV/PM AOLV/PM EZOLV </div> <p>Sets the Forward Run command for 2-wire sequence 1. Set this function and $H1-xx = 40$ [Forward RUN (2-Wire)] together.</p>

ON : Reverse Run

OFF : Stop**Note:**

- If you turn ON the Forward Run command terminal and the Reverse Run command terminal, it will cause an *EF [FWD/REV Run Command Input Error]* alarm and the motor will ramp to stop.
- Initialize the drive with a 2-wire sequence to set the Reverse Run command to terminal S2.
- This function will not operate at the same time as $H1-xx = 42, 43$ [*Run Command (2-Wire Sequence 2), FWD/REV (2-Wire Sequence 2)*].

■ 42: Run Command (2-Wire Sequence 2)

Setting Value	Function	Description
42	Run Command (2-Wire Sequence 2)	V/f OLV OLV/PM AOLV/PM EZOLV Sets the Run command for 2-wire sequence 2. Set this function and $H1-xx = 43$ [<i>FWD/REV (2-Wire Sequence 2)</i>] together.

ON : Run**OFF : Stop****Note:**

This function will not operate at the same time as $H1-xx = 40, 41$ [*Forward RUN (2-Wire), Reverse RUN (2-Wire)*].

■ 43: FWD/REV (2-Wire Sequence 2)

Setting Value	Function	Description
43	FWD/REV (2-Wire Sequence 2)	V/f OLV OLV/PM AOLV/PM EZOLV Sets the direction of motor rotation for 2-wire sequence 2. Set this function and $H1-xx = 42$ [<i>Run Command (2-Wire Sequence 2)</i>] together.

ON : Reverse Run**OFF : Forward Run****Note:**

- You must input the Run command to rotate the motor.
- This function will not operate at the same time as $H1-xx = 40, 41$ [*Forward RUN (2-Wire), Reverse RUN (2-Wire)*].

■ 44: Add Offset Frequency 1 (d7-01)

Setting Value	Function	Description
44	Add Offset Frequency 1 (d7-01)	V/f OLV OLV/PM AOLV/PM EZOLV Sets the function to add the offset frequency set in $d7-01$ [<i>Offset Frequency 1</i>] to the frequency reference when the terminal activates.

Note:

Refer to [d7: Offset Frequency on page 239](#) for more information.

■ 45: Add Offset Frequency 2 (d7-02)

Setting Value	Function	Description
45	Add Offset Frequency 2 (d7-02)	V/f OLV OLV/PM AOLV/PM EZOLV Sets the function to add the offset frequency set in $d7-02$ [<i>Offset Frequency 2</i>] to the frequency reference when the terminal activates.

Note:

Refer to [d7: Offset Frequency on page 239](#) for more information.

■ 46: Add Offset Frequency 3 (d7-03)

Setting Value	Function	Description
46	Add Offset Frequency 3 (d7-03)	V/f OLV OLV/PM AOLV/PM EZOLV Sets the function to add the offset frequency set in $d7-03$ [<i>Offset Frequency 3</i>] to the frequency reference when the terminal activates.

Note:

Refer to [d7: Offset Frequency on page 239](#) for more information.

■ 47: Node Setup (CANopen)

Setting Value	Function	Description
47	Node Setup (CANopen)	<div style="display: flex; gap: 5px;"> V/f OLV OLV/IPM AOLV/IPM EZOLV </div> Sets the function in CANopen communications to start the Node Setup function to set the drive node address from the host controller.

■ 60: DC Injection Braking Command

Setting Value	Function	Description
60	DC Injection Braking Command	<div style="display: flex; gap: 5px;"> V/f OLV OLV/IPM AOLV/IPM EZOLV </div> Sets the command to use DC Injection Braking to stop the motor.

If you input the Run command or JOG command, it will cancel DC Injection Braking.

Figure 2.64 shows the time chart of the DC Injection Braking function.

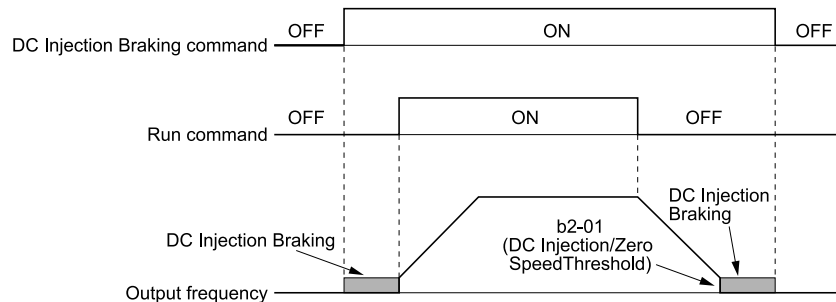

Figure 2.64 DC Injection Braking Time Chart

Note:

- When $A1-02 = 8$ [Control Method Selection = EZOLV], this function is available with a PM motor.
- Refer to [b2: DC Injection Braking and Short Circuit Braking on page 167](#) for more information.

■ 61: Speed Search from Fmax

Setting Value	Function	Description
61	Speed Search from Fmax	<div style="display: flex; gap: 5px;"> V/f OLV OLV/IPM AOLV/IPM EZOLV </div> Sets the function to use an external reference to start speed search although $b3-01 = 0$ [Speed Search Selection at Start = Disabled] to not allow speed search at start.

When the terminal is activated for $b3-24 = 2$ [Speed Search Method Selection = Current Detection 2], the drive starts speed search from the maximum output frequency.

Note:

- The drive will detect $oPE03$ [Multi-Function Input Setting Err] if you set $H1-xx = 61$ and $H1-xx = 62$ at the same time.
- Refer to [b3: Speed Search on page 170](#) for more information.

■ 62: Speed Search from Fref

Setting Value	Function	Description
62	Speed Search from Fref	<div style="display: flex; gap: 5px;"> V/f OLV OLV/IPM AOLV/IPM EZOLV </div> Sets the function to use an external reference to start speed search although $b3-01 = 0$ [Speed Search Selection at Start = Disabled] to not allow speed search at start.

When the terminal is activated for $b3-24 = 2$ [Speed Search Method Selection = Current Detection 2], the drive starts speed search from the frequency reference.

Note:

- The drive will detect $oPE03$ [Multi-Function Input Setting Err] if you set $H1-xx = 61$ and $H1-xx = 62$ at the same time.
- Refer to [b3: Speed Search on page 170](#) for more information.

63: Field Weakening

Setting Value	Function	Description
63	Field Weakening	<div style="display: flex; justify-content: space-between; align-items: center;"> V/f OLV OLV/PM AOLV/PM EZOLV </div> <p>Sets the function to send the Field Weakening Level and Field Weakening Frequency Limit commands set in <i>d6-01 [Field Weakening Level]</i> and <i>d6-02 [Field Weakening Frequency Limit]</i> when the input terminal is activated.</p>

Note:

Refer to [d6: Field Weakening /Forcing on page 238](#) for more information.

65: KEB Ride-Thru 1 Activate (N.C.)

Setting Value	Function	Description
65	KEB Ride-Thru 1 Activate (N.C.)	<div style="display: flex; justify-content: space-between; align-items: center;"> V/f OLV OLV/PM AOLV/PM EZOLV </div> <p>Sets operation of the KEB1 function through the KEB Ride-Thru 1 (N.C.).</p>

ON : Normal operation

OFF : Deceleration during momentary power loss

When you enable KEB Ride-Thru 1, set *L2-29 [KEB Method Selection]*. The drive operates with the selected KEB method.

Note:

- If you set *KEB Ride-Thru 1 [H1-xx = 65, 66]* and *KEB Ride-Thru 2 [H1-xx = 7A, 7B]* at the same time, the drive will detect *oPE03 [Multi-Function Input Setting Err]*.
- Refer to [KEB Ride-Thru Function on page 364](#) for more information.

66: KEB Ride-Thru 1 Activate (N.O.)

Setting Value	Function	Description
66	KEB Ride-Thru 1 Activate (N.O.)	<div style="display: flex; justify-content: space-between; align-items: center;"> V/f OLV OLV/PM AOLV/PM EZOLV </div> <p>Sets operation of the KEB1 function through the KEB Ride-Thru 1 (N.O.).</p>

ON : Deceleration during momentary power loss

OFF : Normal operation

When you enable KEB Ride-Thru 1, set *L2-29 [Kinetic Energy Backup Method]*. The drive operates with the selected KEB method.

Note:

- If you set *KEB Ride-Thru 1 [H1-xx = 65, 66]* and *KEB Ride-Thru 2 [H1-xx = 7A, 7B]* at the same time, the drive will detect *oPE03 [Multi-Function Input Setting Err]*.
- Refer to [KEB Ride-Thru Function on page 364](#) for more information.

67: Communications Test Mode

Setting Value	Function	Description
67	Communications Test Mode	<div style="display: flex; justify-content: space-between; align-items: center;"> V/f OLV OLV/PM AOLV/PM EZOLV </div> <p>Set the function for the drive to self-test RS-485 serial communications operation.</p>

The Self-Diagnostics function connects the transmission terminal of the control terminal block to the reception terminal. The function transmits the data that the drive sent to make sure that the drive can communicate correctly.

68: High Slip Braking (HSB) Activate

Setting Value	Function	Description
68	High Slip Braking (HSB) Activate	<div style="display: flex; justify-content: space-between; align-items: center;"> V/f OLV OLV/PM AOLV/PM EZOLV </div> <p>Sets the command to use high-slip braking to stop the motor.</p>

Note:

- When you restart the drive after you use high-slip braking, make sure that the drive fully stops the motor, then clear the high-slip braking input.
- Refer to [High Slip Braking \(HSB\) on page 407](#) for more information.

■ **6A: Drive Enable**

Setting Value	Function	Description
6 A	Drive Enable	<div style="display: flex; justify-content: space-between; align-items: center;"> V/f OLV OLV/PM AOLV/PM EZOLV </div> <p>Sets the function to show <i>dnE [Drive Disabled]</i> on the keypad and ignore Run commands when the terminal is OFF.</p>

If you input the Run command before you turn ON the Drive Enable terminal, you must input the Run command again to operate the drive. When you deactivate the terminal set for Drive Enable while the drive is operating, the drive will use the stopping method set in *b1-03 [Stopping Method Selection]* to stop the motor.

ON : Run command is accepted.

OFF : Run command is disabled. When the drive is running, it stops according to *b1-03* setting.

■ **75: Up 2 Command**

Setting Value	Function	Description
75	Up 2 Command	<div style="display: flex; justify-content: space-between; align-items: center;"> V/f OLV OLV/PM AOLV/PM EZOLV </div> <p>Sets the function to increase the frequency reference bias value to accelerate the motor when the terminal is activated. Set this function and <i>H1-xx = 76 [Down 2 Command]</i> together.</p>

When you activate the terminal set for Up2 Command, the bias will increase. When you activate the terminal set for Down 2 Command, the bias will decrease. When you activate or deactivate the two commands, the drive will hold the frequency reference. [Table 2.51](#) gives information about the relation between operation of the Up/Down 2 Command and *d4-01*, *d4-03*, and *4-05*.

Note:

- When you use this function, set the optimal bias limit values with *d4-08* and *d4-09 [Up/Down 2 Bias Upper Limit/Lower Limit]*.
- Refer to [d4: Frequency Ref Up/Down & Hold on page 233](#) for more information.

Table 2.51 Up 2 Command, Down 2 Command

Function	Frequency Reference Source	d4-03	d4-05	d4-01	Operation	Storing the Frequency Reference or Frequency Bias
1	Multi-step speed reference	0.00	0	0	• When the Up 2 Command is active, the drive accelerates the motor (increases the bias value).	Not stored.
2				1	• When the Down 2 Command is active, the drive decelerates the motor (decreases the bias value)	When the bias value and frequency reference are constant for 5 seconds after the frequency reference hold starts, the drive will add the bias value to the enabled frequency reference, then reset.
3				-	• When the Up 2 Command and Down 2 Command are active or not active, the drive holds the output frequency. (holds the bias value).	
4	Multi-step speed reference	> 0	-	0	• When the frequency changes, it will reset the bias.	Not stored.
5				1	• For all other statuses, the drive will follow the frequency reference.	When the bias value and frequency reference are constant for 5 seconds after the frequency reference hold starts, the drive will add the bias value to the enabled frequency reference, then reset.
					• When the Up 2 Command is active, the drive accelerates the motor.	
					• When the Down 2 Command is active, the drive decelerates the motor.	
					• For all other statuses, the drive will follow the frequency reference.	
					• When the Up 2 Command is active, the drive accelerates the motor to "Frequency Reference + <i>d4-03</i> " (the bias value will increase to the value set in <i>d4-03</i>)	
					• When the Down 2 Command is active, the drive decelerates the motor to "Frequency Reference - <i>d4-03</i> " (the bias value will decrease to the value set in <i>d4-03</i>).	
					• When the Up 2 Command and Down 2 Command are active or not active, the drive holds the output frequency. (holds the bias value).	
					• When the frequency changes, it will reset the bias.	
					• For all other statuses, the drive will follow the frequency reference.	

Function	Frequency Reference Source	d4-03	d4-05	d4-01	Operation	Storing the Frequency Reference or Frequency Bias
6	Others (Analog input, transmission)	0	0	0	<ul style="list-style-type: none"> When the Up 2 Command is active, the drive accelerates the motor (increases the bias value). When the Down 2 Command is active, the drive decelerates the motor (decreases the bias value) When the Up 2 Command and Down 2 Command are active or not active, the drive holds the output frequency (holds the bias value). During acceleration or deceleration, when the frequency reference increases or decreases more than <i>d4-07</i>, the drive holds the bias value until the output frequency and the actual frequency reference agree (speed agreement). 	Not stored.
7				1		When the bias value is constant for 5 seconds after the frequency reference hold starts, the drive will store the bias value in <i>d4-06</i> . You cannot rewrite the frequency reference is not possible. The drive will store only the bias value.
8	Others (Analog input, transmission)	0	1	-	<ul style="list-style-type: none"> When the Up 2 Command is active, the drive accelerates the motor (increases the bias value). When the Down 2 Command is active, the drive decelerates the motor (decreases the bias value) For all other statuses, the drive will follow the frequency reference. 	Not stored.
9				0		Not stored.
10		> 0	-	1	<ul style="list-style-type: none"> When the Up 2 Command is active, the drive accelerates the motor to "Frequency Reference + <i>d4-03</i>" (the bias value will increase to the value set in <i>d4-03</i>) When the Down 2 Command is active, the drive decelerates the motor to "Frequency Reference - <i>d4-03</i>" (the bias value will decrease to the value set in <i>d4-03</i>). During acceleration or deceleration, when the frequency reference increases or decreases more than <i>d4-07</i>, the drive holds the bias value until the output frequency and the actual frequency reference agree (speed agreement). 	When the bias value is constant for 5 seconds after the frequency reference hold starts, the drive will store the bias value in <i>d4-06</i> . You cannot rewrite the frequency reference is not possible. The drive will store only the bias value.

76: Down 2 Command

Setting Value	Function	Description
76	Down 2 Command	<div style="display: flex; gap: 5px;"> V/f OLV OLV/PM AOLV/PM EZOLV </div> <p>Sets the function to decrease the frequency reference bias value to decelerate the motor when the terminal is activated. Set this function and <i>H1-xx = 75 [Up 2 Command]</i> together.</p>

When you activate the terminal set for Up2 Command, the bias will increase. When you activate the terminal set for Down 2 Command, the bias will decrease. When you activate or deactivate the two commands, the drive will hold the frequency reference.

Note:

- When you use this function, set the optimal bias limit values with *d4-08* and *d4-09 [Up/Down 2 Bias Upper Limit/Lower Limit]*.
- Refer to [d4: Frequency Ref Up/Down & Hold on page 233](#) for more information.

77: ASR Gain (C5-03) Select

Setting Value	Function	Description
77	ASR Gain (C5-03) Select	<div style="display: flex; gap: 5px;"> V/f OLV OLV/PM AOLV/PM EZOLV </div> <p>Sets the function to switch the ASR proportional gain to <i>C5-01 [ASR Proportional Gain 1]</i> or <i>C5-03 [ASR Proportional Gain 2]</i>.</p>

ON : C5-03

Switches the proportional gain to *C5-03 [ASR Proportional Gain 2]*.

OFF : C5-01

Switches the proportional gain to *C5-01 [ASR Proportional Gain 1]*.

Note:

Refer to [C5: Auto Speed Regulator \(ASR\) on page 215](#) for more information.

78: Analog TorqueRef Polarity Invert

Setting Value	Function	Description
78	Analog TorqueRef Polarity Invert	<div style="display: flex; gap: 5px;"> V/f OLV OLV/PM AOLV/PM EZOLV </div> <p>Sets the rotation direction of the external torque reference.</p>

ON : External torque reference reverse direction

OFF : External torque reference forward direction**■ 7A: KEB Ride-Thru 2 Activate (N.C.)**

Setting Value	Function	Description
7A	KEB Ride-Thru 2 Activate (N.C.)	<input type="checkbox"/> V/f <input type="checkbox"/> OLV <input checked="" type="checkbox"/> OLV/PM <input type="checkbox"/> AOLV/PM <input type="checkbox"/> EZOLV Sets operation of the KEB2 function through the KEB Ride-Thru 2 (N.C.).

ON : Normal operation**OFF : Deceleration during momentary power loss**

When KEB Ride-Thru 2 is input, the drive will use Single Drive KEB Ride-Thru 2 for KEB operation. The *L2-29 [KEB Method Selection]* setting will not have an effect.

Note:

- If you set *KEB Ride-Thru 1 [H1-xx = 65, 66]* and *KEB Ride-Thru 2 [H1-xx = 7A, 7B]* at the same time, the drive will detect *oPE03 [Multi-Function Input Setting Err]*.
- Refer to [KEB Ride-Thru Function on page 364](#) for more information.

■ 7B: KEB Ride-Thru 2 Activate (N.O.)

Setting Value	Function	Description
7B	KEB Ride-Thru 2 Activate (N.O.)	<input type="checkbox"/> V/f <input type="checkbox"/> OLV <input checked="" type="checkbox"/> OLV/PM <input type="checkbox"/> AOLV/PM <input type="checkbox"/> EZOLV Sets operation of the KEB2 function through the KEB Ride-Thru 2 (N.O.).

ON : Deceleration during momentary power loss**OFF : Normal operation**

When KEB Ride-Thru 2 is input, the drive will use Single Drive KEB Ride-Thru 2 for KEB operation. The *L2-29 [KEB Method Selection]* setting will not have an effect.

Note:

- If you set *KEB Ride-Thru 1 [H1-xx = 65, 66]* and *KEB Ride-Thru 2 [H1-xx = 7A, 7B]* at the same time, the drive will detect *oPE03 [Multi-Function Input Setting Err]*.
- Refer to [KEB Ride-Thru Function on page 364](#) for more information.

■ 7C: Short Circuit Braking (N.O.)

Setting Value	Function	Description
7C	Short Circuit Braking (N.O.)	<input type="checkbox"/> V/f <input type="checkbox"/> OLV <input checked="" type="checkbox"/> OLV/PM <input type="checkbox"/> AOLV/PM <input type="checkbox"/> EZOLV Sets operation of Short Circuit Braking (N.O.).

WARNING! Incorrect Operation. Yaskawa recommends that you use *H1-xx = 7D [Short Circuit Braking (N.C.)]*. If a circuit error occurs in the MFDI, the motor can take longer than expected to stop when the terminal set to *H1-xx = 7C [Short Circuit Braking (N.O.)]* turns ON.

The drive will short circuit the three phases of a PM motor to cause braking torque in the spinning motor.

Note:

- When *A1-02 = 8 [Control Method Selection = EZOLV]*, this function is available only when you use a PM motor.
- Refer to [b2: DC Injection Braking and Short Circuit Braking on page 167](#) for more information.

ON : Short Circuit Braking is enabled.**OFF : Normal operation****■ 7D: Short Circuit Braking (N.C.)**

Setting Value	Function	Description
7D	Short Circuit Braking (N.C.)	<input type="checkbox"/> V/f <input type="checkbox"/> OLV <input checked="" type="checkbox"/> OLV/PM <input type="checkbox"/> AOLV/PM <input type="checkbox"/> EZOLV Sets operation of Short Circuit Braking (N.C.).

The drive will short circuit the three phases of a PM motor to cause braking torque in the spinning motor.

Note:

- When *A1-02 = 8 [Control Method Selection = EZOLV]*, this function is available only when you use a PM motor.
- Refer to [b2: DC Injection Braking and Short Circuit Braking on page 167](#) for more information.

ON : Normal operation

OFF : Short Circuit Braking is enabled.

■ 7E: Reverse Rotation Identifier

Setting Value	Function	Description
7E	Reverse Rotation Identifier	<div style="display: flex; gap: 5px;"> V/f OLV OLV/PM AOLV/PM EZOLV </div> Sets the motor rotation direction when you use Simple Closed Loop V/f Control method.

ON : Reverse run

The drive knows that the motor is rotating in the reverse direction.

OFF : Forward run

The drive knows that the motor is rotating in the forward direction.

■ 90 to 96: DWEZ Digital Inputs 1 to 7

Setting Value	Function	Description
90 - 96	DWEZ Digital Inputs 1 to 7	<div style="display: flex; gap: 5px;"> V/f OLV OLV/PM AOLV/PM EZOLV </div> Sets digital inputs used with DriveWorksEZ. Refer to the DriveWorksEZ online manual for more information.

Note:

You cannot set values 90 to 96 for inverse output.

■ 9F: DWEZ Disable

Setting Value	Function	Description
9F	DWEZ Disable	<div style="display: flex; gap: 5px;"> V/f OLV OLV/PM AOLV/PM EZOLV </div> Sets operation of the DriveWorksEZ program saved in the drive.

Note:

Set $A1-07 = 2$ [DriveWorksEZ Function Selection = Enabled/Disabled wDigital Input] to use this function.

ON : Disabled

OFF : Enabled

■ 101 to 19F: Inverse Input of 1 to 9F

Setting Value	Function	Description
101 to 19F	Inverse Input of 1 to 9F	Sets the function of the selected MFDI to operate inversely. To select the function, enter "1xx", where the "xx" is the function setting value.

For example, to use the inverse input of E [ASR Integral Reset], set $H1-xx = 10E$.

Note:

You cannot use inverse input for all functions. Refer to [Table 2.46](#) for more information.

◆ H2: Digital Outputs

$H2$ parameters set the MFDO terminal functions.

■ H2-01 to H2-03 Terminal MA/MB-MC, P1-C1, P2-C2 Function Selection

The drive has four MFDO terminals. [Table 2.52](#) shows the default function settings for the terminals.

Table 2.52 MFDO Terminals Default Function Settings

No.	Name	Default	Function
H2-01	Term MA/MB-MC Function Selection (Contact)	E	Fault
H2-02	Term P1-C1 Function Selection	0	During Run
H2-03	Term P2-C2 Function Selection	2	Speed Agree 1

Refer to [Table 2.53](#) to set $H2-xx$ [MFDO Function Select].

Table 2.53 MFDO Setting Values

Setting Value	Function	Reference	Setting Value	Function	Reference
0	During Run	319	20	Drive Overheat Pre-Alarm (oH)	327
1	Zero Speed	319	21	Safe Torque OFF	327
2	Speed Agree 1	319	22	Mechanical Weakening Detection	327
3	User-Set Speed Agree 1	320	2F	Maintenance Notification	327
4	Frequency Detection 1	320	30	During Torque Limit	328
5	Frequency Detection 2	321	37	During Frequency Output	328
6	Drive Ready	321	38	Drive Enabled	328
7	DC Bus Undervoltage	322	39	Watt Hour Pulse Output	328
8	During Baseblock (N.O.)	322	3C	LOCAL Control Selected	329
9	Frequency Reference from Keypad	322	3D	During Speed Search	329
A	Run Command Source	322	3E	PID Feedback Low	329
B	Torque Detection 1 (N.O.)	322	3F	PID Feedback High	329
C	Frequency Reference Loss	322	4A	During KEB Ride-Thru	329
D	Braking Resistor Fault	323	4B	During Short Circuit Braking	329
E	Fault	323	4C	During Fast Stop	330
F *1	Not Used	323	4D	oH Pre-Alarm Time Limit	330
10	Alarm	323	4E	Braking Transistor Fault (rr)	330
11	Fault Reset Command Active	323	4F	Braking Resistor Overheat (rH)	330
12	Timer Output	323	61	Pole Position Detection Complete	330
13	Speed Agree 2	323	62	Modbus Reg 1 Status Satisfied	330
14	User-Set Speed Agree 2	324	63	Modbus Reg 2 Status Satisfied	330
15	Frequency Detection 3	324	66	Comparator1	330
16	Frequency Detection 4	325	67	Comparator2	331
17	Torque Detection 1 (N.C.)	325	69	External Power 24V Supply	331
18	Torque Detection 2 (N.O.)	325	6A	Data Logger Error	332
19	Torque Detection 2 (N.C.)	326	90 to 92	DWEZ Digital Output 1 to 3	332
1A	During Reverse	326	100 to 192	Inverse output of 0 to 92 Sets an inverse output of the function for the MFDO. Put a 1 at the front of the function setting to set inverse output. For example, set 138 for inverse output of 38 [Drive Enabled].	332
1B	During Baseblock (N.C.)	326			
1C	Motor 2 Selection	326			
1E	Executing Auto-Restart	327			
1F	Motor Overload Alarm (oL1)	327			

*1 Inverse output is not available.

Extended MFDO1 to MFDO3 Function Selection

You can set MFDO functions to bit 0 to bit 2 [MEMOBUS MFDO1 to 3] of MEMOBUS register 15E0 (Hex.). Use H2-40 to H2-42 [Mbus Reg 15E0h bit0 to bit2 Output Func] to select the function.

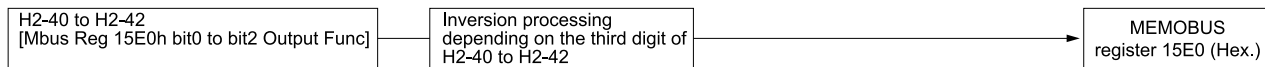

Figure 2.65 Functional Block Diagram of MEMOBUS Multi-function Output

Table 2.54 MEMOBUS MFDO Registers

Register number (Hex.)	Name	
15E0	bit0	MEMOBUS MFDO 1
	bit1	MEMOBUS MFDO 2
	bit2	MEMOBUS MFDO 3

Note:

- Refer to *MFDO Setting Values on page 318* for more information about MFDO setting values.
- When you do not set functions to H2-40 to H2-42, set them to F.

Output of Logical Operation Results of MFDO

This enables the logical operation results of two MFDOs to be output to one MFDO terminal.

Use H2-60, H2-63, and H2-66 [Term MA,MB,MC Secondary Function, Terminal P1 Secondary Function, and Terminal P2 Secondary Function] to set the function of the output signal for which you will perform logical operations.

Use H2-61, H2-64, and H2-67 [Term MA,MB,MC Logical Operation, Terminal P1 Logical Operation, and Terminal P2 Logical Operation] to set the logical operation.

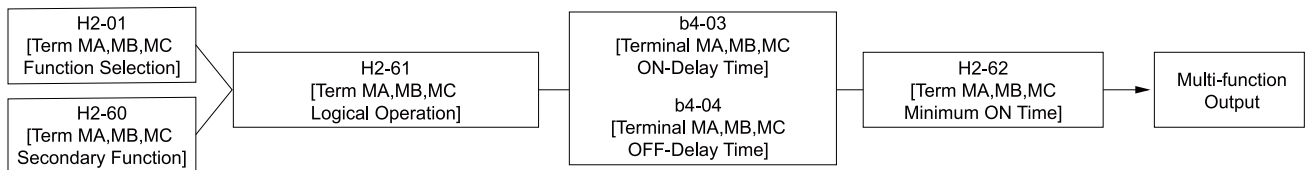

Figure 2.66 Functional Block Diagram of Logical Operation Output for MFDO 1

Table 2.55 MFDO Logical Operation Table

Logical Operation Selection	Logical Operation Expression	Logical Operation Notation
H2-61, H2-64, H2-67		
0	A=B=1	
1	A=1 or B=1	
2	A=0 or B=0	
3	A=B=0	
4	A=B	A=B
5	A != B	
6	AND (A, B̄)	
7	OR (A, B̄)	
8	-	On

Note:

- If you use the function to output logical calculation results, you cannot set H2-01 to H2-03 = 1xx [Inverse Output of xx]. If you do, the drive will detect oPE33 [Digital Output Selection Error].
- When you do not use H2-60, H2-63, and H2-66, set them to F. The through mode function is not supported.

◆ H2 MFDO Parameters

■ H2-01: Term MA/MB-MC Function Selection

No. (Hex.)	Name	Description	Default (Range)
H2-01 (040B)	Term MA/MB-MC Function Selection	V/f OLV OLV/PM AOLV/PM EZOLV Sets the function set for MFDO terminal MA-MC or MB-MC.	E (0 - 1FF)

Note:

Set this parameter to *F* when the terminal is not being used or to use the terminal in through mode.

■ H2-02: Term P1-C1 Function Selection

No. (Hex.)	Name	Description	Default (Range)
H2-02 (040C)	Term P1-C1 Function Selection	V/f OLV OLV/PM AOLV/PM EZOLV Sets the function for MFDO terminal P1-C1.	0 (0 - 1FF)

Note:

Set this parameter to *F* when the terminal is not being used or to use the terminal in through mode.

■ H2-03: Term P2-C2 Function Selection

No. (Hex.)	Name	Description	Default (Range)
H2-03 (040D)	Term P2-C2 Function Selection	V/f OLV OLV/PM AOLV/PM EZOLV Sets the function for MFDO terminal P2-C2.	2 (0 - 1FF)

Note:

Set this parameter to *F* when the terminal is not being used or to use the terminal in through mode.

■ H2-06: Watt Hour Output Unit Selection

No. (Hex.)	Name	Description	Default (Range)
H2-06 (0437)	Watt Hour Output Unit Selection	V/f OLV OLV/PM AOLV/PM EZOLV Sets the unit for the output signal when H2-01 to H2-03 = 39 [MFDO Function Selection = Watt Hour Pulse Output].	0 (0 - 4)

This output is input to the Watt hour meter or PLC through a 200 ms pulse signal. The drive triggers a 200 ms pulse each time the kWh data is at the value set in H2-06. This parameter sets the kWh unit for each pulse output.

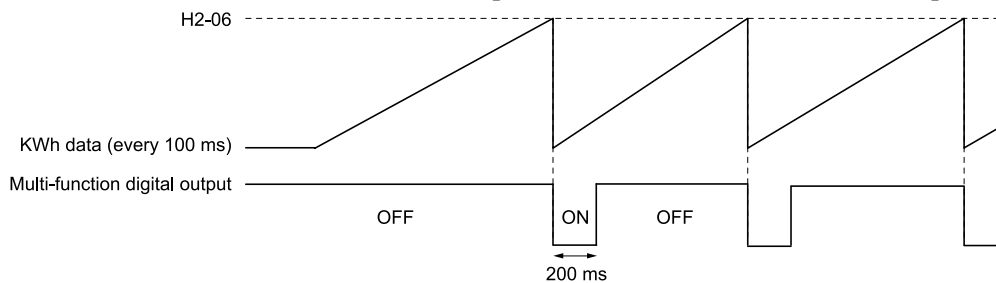

Figure 2.67 Example MFDO when Configured for Watt Hours

Note:

- When the power value is a negative value (regenerative state), the drive does not count Watt hours.
- When the control power supply to the drive is operating, the drive will keep the Watt hours. If a momentary power loss causes the drive to lose control power, the Watt hour count will reset.

0 : 0.1 kWh units

1 : 1 kWh units

2 : 10 kWh units

3 : 100 kWh units

4 : 1000 kWh units

■ H2-07: Modbus Register 1 Address Select

No. (Hex.)	Name	Description	Default (Range)
H2-07 (0B3A)	Modbus Register 1 Address Select	<input type="checkbox"/> V/f <input type="checkbox"/> OLV <input type="checkbox"/> OLV/PM <input type="checkbox"/> AOLV/PM <input type="checkbox"/> EZOLV Sets the address of the MEMOBUS/Modbus register output to the MFDO terminal.	0001 (0001 - 1FFF)

Sets the address of the register that is output to *Modbus Reg 1 Status Satisfied* [H2-01 to H2-03 = 62] and uses the bit in H2-08 [Modbus Register 1 Bit Select].

■ H2-08: Modbus Register 1 Bit Select

No. (Hex.)	Name	Description	Default (Range)
H2-08 (0B3B)	Modbus Register 1 Bit Select	<input type="checkbox"/> V/f <input type="checkbox"/> OLV <input type="checkbox"/> OLV/PM <input type="checkbox"/> AOLV/PM <input type="checkbox"/> EZOLV Sets the bit of the MEMOBUS/Modbus register output to the MFDO terminal.	0000 (0000 - FFFF)

Sets the bit of the register that is output to *Modbus Reg 1 Status Satisfied* [H2-01 to H2-03 = 62] and uses the address in H2-07 [Modbus Register 1 Address Select].

■ H2-09: Modbus Register 2 Address Select

No. (Hex.)	Name	Description	Default (Range)
H2-09 (0B3C)	Modbus Register 2 Address Select	<input type="checkbox"/> V/f <input type="checkbox"/> OLV <input type="checkbox"/> OLV/PM <input type="checkbox"/> AOLV/PM <input type="checkbox"/> EZOLV Sets the address of the MEMOBUS/Modbus register output to the MFDO terminal.	0001 (0001 - 1FFF)

Sets the address of the register that is output to *Modbus Reg 2 Status Satisfied* [H2-01 to H2-03 = 63] and uses the bit in H2-10 [Modbus Register 2 Bit Select].

■ H2-10: Modbus Register 2 Bit Select

No. (Hex.)	Name	Description	Default (Range)
H2-10 (0B3D)	Modbus Register 2 Bit Select	<input type="checkbox"/> V/f <input type="checkbox"/> OLV <input type="checkbox"/> OLV/PM <input type="checkbox"/> AOLV/PM <input type="checkbox"/> EZOLV Sets the bit of the MEMOBUS/Modbus register output to the MFDO terminal.	0000 (0000 - FFFF)

Sets the bit of the register that is output to *Modbus Reg 2 Status Satisfied* [H2-01 to H2-03 = 63] and uses the address in H2-09 [Modbus Register 2 Address Select].

■ H2-20: Comparator 1 Monitor Selection

No. (Hex.)	Name	Description	Default (Range)
H2-20 (1540)	Comparator 1 Monitor Selection	<input type="checkbox"/> V/f <input type="checkbox"/> OLV <input type="checkbox"/> OLV/PM <input type="checkbox"/> AOLV/PM <input type="checkbox"/> EZOLV Sets the monitor number for comparator 1. Set the x-xx part of the Ux-xx [Monitor]. For example, set H2-20 = 102 to monitor U1-02 [Output Frequency].	102 (000 - 999)

Note:

- For information on the comparator function, refer to [66: Comparator1 on page 330](#) and [67: Comparator2 on page 331](#).
- The configurable monitor changes when the control method changes.

■ H2-21: Comparator 1 Lower Limit

No. (Hex.)	Name	Description	Default (Range)
H2-21 (1541)	Comparator 1 Lower Limit	<input type="checkbox"/> V/f <input type="checkbox"/> OLV <input type="checkbox"/> OLV/PM <input type="checkbox"/> AOLV/PM <input type="checkbox"/> EZOLV Sets the lower limit detection level for comparator 1 when the full scale analog output for the monitor selected in H2-20 [Comparator 1 Monitor Selection] is the 100% value.	0.0% (0.0 - 300.0%)

Note:

For information on the comparator function, refer to [66: Comparator1 on page 330](#) and [67: Comparator2 on page 331](#).

■ H2-22: Comparator 1 Upper Limit

No. (Hex.)	Name	Description	Default (Range)
H2-22 (1542)	Comparator 1 Upper Limit	<div style="display: flex; gap: 5px;"> V/f OLV OLV/IPM AOLV/IPM EZOLV </div> <p>Sets the upper limit detection level for comparator 1 when the full scale analog output for the monitor selected in H2-20 [Comparator 1 Monitor Selection] is the 100% value.</p>	0.0% (0.0 - 300.0%)

Note:

For information on the comparator function, refer to [66: Comparator1 on page 330](#) and [67: Comparator2 on page 331](#).

■ H2-23: Comparator 1 Hysteresis

No. (Hex.)	Name	Description	Default (Range)
H2-23 (1543)	Comparator 1 Hysteresis	<div style="display: flex; gap: 5px;"> V/f OLV OLV/IPM AOLV/IPM EZOLV </div> <p>Sets the hysteresis level for comparator 1 as a percentage of the full scale analog output for the monitor selected in H2-20 [Comparator 1 Monitor Selection].</p>	0.0% (0.0 - 10.0%)

Note:

For information on the comparator function, refer to [66: Comparator1 on page 330](#) and [67: Comparator2 on page 331](#).

■ H2-24: Comparator 1 On-Delay Time

No. (Hex.)	Name	Description	Default (Range)
H2-24 (1544)	Comparator 1 On-Delay Time	<div style="display: flex; gap: 5px;"> V/f OLV OLV/IPM AOLV/IPM EZOLV </div> <p>Sets the on-delay time for comparator 1.</p>	0.0 s (0.0 - 600.0 s)

Note:

For information on the comparator function, refer to [66: Comparator1 on page 330](#) and [67: Comparator2 on page 331](#).

■ H2-25: Comparator 1 Off-Delay Time

No. (Hex.)	Name	Description	Default (Range)
H2-25 (1545)	Comparator 1 Off-Delay Time	<div style="display: flex; gap: 5px;"> V/f OLV OLV/IPM AOLV/IPM EZOLV </div> <p>Sets the off-delay time for comparator 1.</p>	0.0 s (0.0 - 600.0 s)

Note:

For information on the comparator function, refer to [66: Comparator1 on page 330](#) and [67: Comparator2 on page 331](#).

■ H2-26: Comparator 2 Monitor Selection

No. (Hex.)	Name	Description	Default (Range)
H2-26 (1546)	Comparator 2 Monitor Selection	<div style="display: flex; gap: 5px;"> V/f OLV OLV/IPM AOLV/IPM EZOLV </div> <p>Sets the monitor number for comparator 2. Set the x-xx part of the Ux-xx [Monitor]. For example, set H2-26 = 103 to monitor U1-03 [Output Current].</p>	103 (000 - 999)

Note:

- The configurable monitor changes when the control method changes.
- When you use the terminal in through mode, set this parameter to 000 or 031. You can set the terminal output level from the PLC through MEMOBUS/Modbus communications or the communication option.
- For information on the comparator function, refer to [66: Comparator1 on page 330](#) and [67: Comparator2 on page 331](#).

■ H2-27: Comparator 2 Lower Limit

No. (Hex.)	Name	Description	Default (Range)
H2-27 (1547)	Comparator 2 Lower Limit	<div style="display: flex; gap: 5px;"> V/f OLV OLV/IPM AOLV/IPM EZOLV </div> <p>Sets the lower limit detection level for comparator 2 as a percentage of the full scale analog output for the monitor selected in H2-26 [Comparator 2 Monitor Selection].</p>	0.0% (0.0 - 300.0%)

Note:

For information on the comparator function, refer to [66: Comparator1 on page 330](#) and [67: Comparator2 on page 331](#).

■ H2-28: Comparator 2 Upper Limit

No. (Hex.)	Name	Description	Default (Range)
H2-28 (1548)	Comparator 2 Upper Limit	V/f OLV OLV/PM AOLV/PM EZOLV Sets the upper limit detection level for comparator 2 as a percentage of the full scale analog output for the monitor selected in H2-26 [Comparator 2 Monitor Selection].	0.0% (0.0 - 300.0%)

Note:

For information on the comparator function, refer to [66: Comparator1 on page 330](#) and [67: Comparator2 on page 331](#).

■ H2-29: Comparator 2 Hysteresis

No. (Hex.)	Name	Description	Default (Range)
H2-29 (1549)	Comparator 2 Hysteresis	V/f OLV OLV/PM AOLV/PM EZOLV Sets the hysteresis level for comparator 2 as a percentage of the full scale analog output for the monitor selected in H2-26 [Comparator 2 Monitor Selection].	0.0% (0.0 - 10.0%)

Note:

For information on the comparator function, refer to [66: Comparator1 on page 330](#) and [67: Comparator2 on page 331](#).

■ H2-30: Comparator 2 On-Delay Time

No. (Hex.)	Name	Description	Default (Range)
H2-30 (154A)	Comparator 2 On-Delay Time	V/f OLV OLV/PM AOLV/PM EZOLV Sets the on-delay time for comparator 2.	0.0 s (0.0 - 600.0 s)

Note:

For information on the comparator function, refer to [66: Comparator1 on page 330](#) and [67: Comparator2 on page 331](#).

■ H2-31: Comparator 2 Off-Delay Time

No. (Hex.)	Name	Description	Default (Range)
H2-31 (154B)	Comparator 2 Off-Delay Time	V/f OLV OLV/PM AOLV/PM EZOLV Sets the off-delay time for comparator 2.	0.0 s (0.0 - 600.0 s)

Note:

For information on the comparator function, refer to [66: Comparator1 on page 330](#) and [67: Comparator2 on page 331](#).

■ H2-32: Comparator 1 Filter Time

No. (Hex.)	Name	Description	Default (Range)
H2-32 (159A)	Comparator 1 Filter Time	V/f OLV OLV/PM AOLV/PM EZOLV Sets the time constant that is applied to the primary delay filter used for the analog output of the monitor selected with H2-20 [Comparator 1 Monitor Selection].	0.0s (0.0 - 10.0 s)

Note:

For information on the comparator function, refer to [66: Comparator1 on page 330](#) and [67: Comparator2 on page 331](#).

■ H2-33: Comparator1 Protection Selection

No. (Hex.)	Name	Description	Default (Range)
H2-33 (159B)	Comparator1 Protection Selection	V/f OLV OLV/PM AOLV/PM EZOLV Sets drive operation when it detects CPI [Comparator1 Limit Fault].	4 (0 - 4)

0 : Ramp to Stop

2.8 H: Terminal Function Selection

The drive ramps the motor to stop in the deceleration time. The output terminal set for *Fault [H2-01 to H2-03 = E]* activates.

1 : Coast to Stop

The output turns off and the motor coasts to stop. The output terminal set for *Fault [H2-01 to H2-03 = E]* activates.

2 : Fast Stop (Use C1-09)

The drive stops the motor in the deceleration time set in *C1-09 [Fast Stop Time]*. The output terminal set for *Fault [H2-01 to H2-03 = E]* activates.

3 : Alarm Only

The keypad shows *CP1* and the drive continues operation at the current frequency reference.

Note:

The output terminal set to *Alarm [H2-01 to H2-03 = 10]* activates.

4 : Digital Output Only

■ H2-34: Comparator 2 Filter Time

No. (Hex.)	Name	Description	Default (Range)
H2-34 (159C)	Comparator 2 Filter Time	 Sets the time constant that is applied to the primary delay filter used for the analog output of the monitor selected with <i>H2-26 [Comparator 2 Monitor Selection]</i> .	0.0s (0.0 - 10.0 s)

■ H2-35: Comparator2 Protection Selection

No. (Hex.)	Name	Description	Default (Range)
H2-35 (159D)	Comparator2 Protection Selection	 Sets drive operation when it detects <i>CP2 [Comparator2 Limit Fault]</i> .	4 (0 - 4)

0 : Ramp to Stop

The drive ramps the motor to stop in the deceleration time. The output terminal set for *Fault [H2-01 to H2-03 = E]* activates.

1 : Coast to Stop

The output turns off and the motor coasts to stop. The output terminal set for *Fault [H2-01 to H2-03 = E]* activates.

2 : Fast Stop (Use C1-09)

The drive stops the motor in the deceleration time set in *C1-09 [Fast Stop Time]*. The output terminal set for *Fault [H2-01 to H2-03 = E]* activates.

3 : Alarm Only

The keypad shows *CP2* and the drive continues operation at the current frequency reference.

Note:

The output terminal set to *Alarm [H2-01 to H2-03 = 10]* activates.

4 : Digital Output Only

■ H2-36: Comparator 1 Ineffective Time

No. (Hex.)	Name	Description	Default (Range)
H2-36 (159E)	Comparator 1 Ineffective Time	 Sets the length of time that <i>CP1 [Comparator1 Limit Fault]</i> is disabled.	0.0 s (0.0 - 1000.0 s)

Note:

- After you enter a Run command and wait for the time set in this parameter, the drive will monitor operation and make sure that it is in the Comparator 1 range until you enter the Stop command.
- When *CP1* detection is disabled, the drive will activate the output terminal set for *Comparator 1 [H2-xx = 66]*.

■ H2-37: Comparator 2 Ineffective Time

No. (Hex.)	Name	Description	Default (Range)
H2-37 (159F)	Comparator 2 Ineffective Time	<div style="display: flex; gap: 5px;"> V/f OLV OLV/PM AOLV/PM EZOLV </div> Sets the length of time that CP2 [Comparator2 Limit Fault] is disabled.	0.0 s (0.0 - 1000.0 s)

Note:

- After you enter a Run command and wait for the time set in this parameter, the drive will monitor operation and make sure that it is in the Comparator 2 range until you enter the Stop command.
- When CP2 detection is disabled, the drive will activate the output terminal set for *Comparator 2* [H2-xx = 67].

■ H2-40: Mbus Reg 15E0h bit0 Output Func

No. (Hex.)	Name	Description	Default (Range)
H2-40 (0B58)	Mbus Reg 15E0h bit0 Output Func	<div style="display: flex; gap: 5px;"> V/f OLV OLV/PM AOLV/PM EZOLV </div> Sets the MFDO for bit 0 of MEMOBUS register 15E0 (Hex.).	F (0 - 1FF)

■ H2-41: Mbus Reg 15E0h bit1 Output Func

No. (Hex.)	Name	Description	Default (Range)
H2-41 (0B59)	Mbus Reg 15E0h bit1 Output Func	<div style="display: flex; gap: 5px;"> V/f OLV OLV/PM AOLV/PM EZOLV </div> Sets the MFDO for bit 1 of MEMOBUS register 15E0 (Hex.).	F (0 - 1FF)

■ H2-42: Mbus Reg 15E0h bit2 Output Func

No. (Hex.)	Name	Description	Default (Range)
H2-42 (0B5A)	Mbus Reg 15E0h bit2 Output Func	<div style="display: flex; gap: 5px;"> V/f OLV OLV/PM AOLV/PM EZOLV </div> Sets the MFDO for bit 2 of MEMOBUS register 15E0 (Hex.).	F (0 - 1FF)

■ H2-60: Term MA,MB,MC Secondary Function

No. (Hex.)	Name	Description	Default (Range)
H2-60 (1B46) Expert	Term MA,MB,MC Secondary Function	<div style="display: flex; gap: 5px;"> V/f OLV OLV/PM AOLV/PM EZOLV </div> Sets the second function for terminal MA/MB-MC. Outputs the logical calculation results of the terminals set to functions by H2-01 [Term MA,MB,MC Function Selection].	F (0 - FF)

■ H2-61: Term MA,MB,MC Logical Operation

No. (Hex.)	Name	Description	Default (Range)
H2-61 (1B47) Expert	Term MA,MB,MC Logical Operation	<div style="display: flex; gap: 5px;"> V/f OLV OLV/PM AOLV/PM EZOLV </div> Sets the logical operation for the functions set in H2-01 [Term MA,MB,MC Function Selection] and H2-60 [Term MA,MB,MC Secondary Function].	0 (0 - 8)

Note:

Refer to [Output of Logical Operation Results of MFDO on page 311](#) for more information about the relation between parameter settings and logical operations.

■ H2-62: Term MA,MB,MC Minimum ON Time

No. (Hex.)	Name	Description	Default (Range)
H2-62 (1B48) Expert	Term MA,MB,MC Minimum ON Time	<div style="display: flex; gap: 5px;"> V/f OLV OLV/PM AOLV/PM EZOLV </div> Sets the minimum ON time that the drive uses to output the logical calculation results from terminal MA/MB-MC.	0.1 s (0.0 - 25.0 s)

■ H2-63: Terminal P1 Secondary Function

No. (Hex.)	Name	Description	Default (Range)
H2-63 (1B49) Expert	Terminal P1 Secondary Function	<input type="checkbox"/> V/f <input type="checkbox"/> OLV <input type="checkbox"/> OLV/IPM <input type="checkbox"/> AOLV/IPM <input type="checkbox"/> EZOLV Sets the second function for terminal P1-C1. Outputs the logical calculation results of the terminals set to functions by H2-02 [Term P1 Function Selection].	F (0 - FF)

■ H2-64: Terminal P1 Logical Operation

No. (Hex.)	Name	Description	Default (Range)
H2-64 (1B4A) Expert	Terminal P1 Logical Operation	<input type="checkbox"/> V/f <input type="checkbox"/> OLV <input type="checkbox"/> OLV/IPM <input type="checkbox"/> AOLV/IPM <input type="checkbox"/> EZOLV Sets the logical operation for the functions set in H2-02 [Term P1 Function Selection] and H2-63 [Terminal P1 Secondary Function].	0 (0 - 8)

Note:

Refer to [Output of Logical Operation Results of MFDO on page 311](#) for more information about the relation between parameter settings and logical operations.

■ H2-65: Terminal P1 Minimum ON Time

No. (Hex.)	Name	Description	Default (Range)
H2-65 (1B4B) Expert	Terminal P1 Minimum ON Time	<input type="checkbox"/> V/f <input type="checkbox"/> OLV <input type="checkbox"/> OLV/IPM <input type="checkbox"/> AOLV/IPM <input type="checkbox"/> EZOLV Sets the minimum ON time used to output the logical calculation results from terminal P1-C1.	0.1 s (0.0 - 25.0 s)

■ H2-66: Terminal P2 Secondary Function

No. (Hex.)	Name	Description	Default (Range)
H2-66 (1B4C) Expert	Terminal P2 Secondary Function	<input type="checkbox"/> V/f <input type="checkbox"/> OLV <input type="checkbox"/> OLV/IPM <input type="checkbox"/> AOLV/IPM <input type="checkbox"/> EZOLV Sets the second function for terminal P2-C2. Outputs the logical calculation results of the terminals assigned to functions by H2-03 [Term P2 Function Selection].	F (0 - FF)

■ H2-67: Terminal P2 Logical Operation

No. (Hex.)	Name	Description	Default (Range)
H2-67 (1B4D) Expert	Terminal P2 Logical Operation	<input type="checkbox"/> V/f <input type="checkbox"/> OLV <input type="checkbox"/> OLV/IPM <input type="checkbox"/> AOLV/IPM <input type="checkbox"/> EZOLV Sets the logical operation for the functions set in H2-03 [Term P2 Function Selection] and H2-66 [Terminal P2 Secondary Function].	0 (0 - 8)

Note:

Refer to [Output of Logical Operation Results of MFDO on page 311](#) for more information about the relation between parameter settings and logical operations.

■ H2-68: Terminal P2 Minimum ON Time

No. (Hex.)	Name	Description	Default (Range)
H2-68 (1B4E) Expert	Terminal P2 Minimum ON Time	<input type="checkbox"/> V/f <input type="checkbox"/> OLV <input type="checkbox"/> OLV/IPM <input type="checkbox"/> AOLV/IPM <input type="checkbox"/> EZOLV Sets the minimum ON time used to output the logical calculation results from terminal P2-C2.	0.1 s (0.0 - 25.0 s)

◆ MFDO Setting Values

Selects the function configured to MFDO.

■ 0: During Run

Setting Value	Function	Description
0	During Run	<div style="display: flex; justify-content: space-between; align-items: center;"> V/f OLV OLV/PM AOLV/PM EZOLV </div> <p>The terminal activates when you input a Run command and when the drive is outputting voltage.</p>

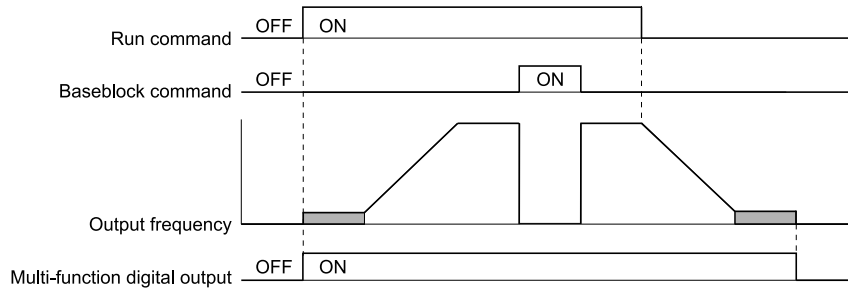

Figure 2.68 Drive Running Time Chart

ON : Drive is running

The drive is receiving a Run command or outputting voltage.

OFF : Drive is stopping

■ 1: Zero Speed

Setting Value	Function	Description
1	Zero Speed	<div style="display: flex; justify-content: space-between; align-items: center;"> V/f OLV OLV/PM AOLV/PM EZOLV </div> <p>The terminal activates when the output frequency is less than <i>E1-09</i> [Minimum Output Frequency] or <i>b2-01</i> [DC Injection/Zero SpeedThreshold].</p>

Note:

Parameter *A1-02* [Control Method Selection] selects which parameter is the reference.

A1-02 Setting	Control Method Selection	Parameter Used as the Reference
0	V/f	<i>E1-09</i>
2	OLV	<i>b2-01</i>
5	OLV/PM	<i>E1-09</i>
6	AOLV/PM	<i>E1-09</i>
8	EZOLV	<i>E1-09</i>

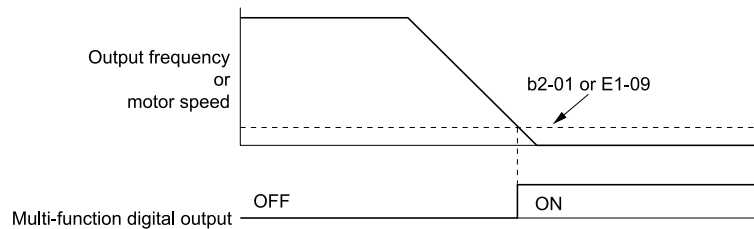

Figure 2.69 Zero Speed Time Chart

ON : Output frequency < value of *E1-09* or *b2-01*.

OFF : Output frequency ≥ value of *E1-09* or *b2-01*.

■ 2: Speed Agree 1

Setting Value	Function	Description
2	Speed Agree 1	<div style="display: flex; justify-content: space-between; align-items: center;"> V/f OLV OLV/PM AOLV/PM EZOLV </div> <p>The terminal activates when the output frequency is in the range of the frequency reference ± <i>L4-02</i> [Speed Agree Detection Width].</p>

Note:

The detection function operates in the two motor rotation directions.

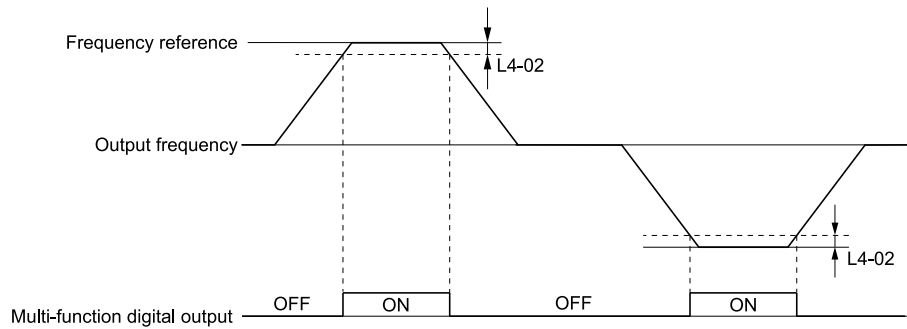

Figure 2.70 Speed Agree 1 Time Chart

ON : The output frequency is in the range of “frequency reference \pm L4-02”.

OFF : The output frequency does not align with the frequency reference although the drive is running.

3: User-Set Speed Agree 1

Setting Value	Function	Description
3	User-Set Speed Agree 1	<div style="display: flex; gap: 5px;"> V/f OLV OLV/IPM AOLV/IPM EZOLV </div> <p>The terminal activates when the output frequency is in the range of L4-01 [Speed Agree Detection Level] \pm L4-02 [Speed Agree Detection Width] and in the range of the frequency reference \pm L4-02.</p>

Note:

The detection function operates in the two motor rotation directions. The drive uses the L4-01 value as the forward/reverse detection level.

ON : The output frequency is in the range of “L4-01 \pm L4-02” and the range of frequency reference \pm L4-02.

OFF : The output frequency is not in the range of “L4-01 \pm L4-02” nor the range of frequency reference \pm L4-02.

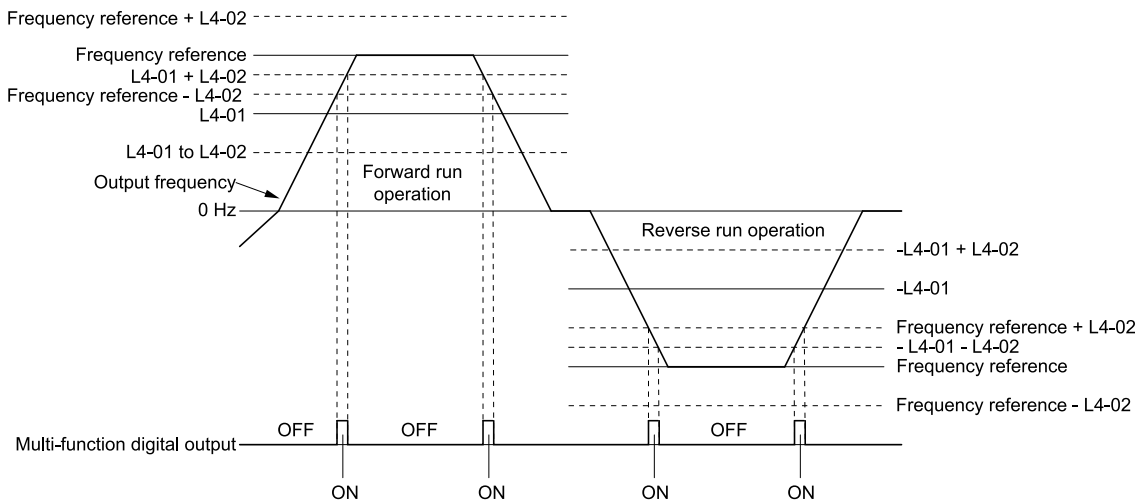

Figure 2.71 User-Defined Speed Agree 1 Time Chart

4: Frequency Detection 1

Setting Value	Function	Description
4	Frequency Detection 1	<div style="display: flex; gap: 5px;"> V/f OLV OLV/IPM AOLV/IPM EZOLV </div> <p>The terminal deactivates when the output frequency is higher than the value of L4-01 [Speed Agree Detection Level] + L4-02 [Speed Agree Detection Width]. After the terminal deactivates, the terminal stays deactivated until the output frequency = L4-01.</p>

Note:

The detection function operates in the two motor rotation directions. The drive uses the L4-01 value as the forward/reverse detection level.

ON : The output frequency is less than the value of $L4-01$ or does not exceed the value of $L4-01 + L4-02$.

OFF : The output frequency is higher than the value of $L4-01 + L4-02$.

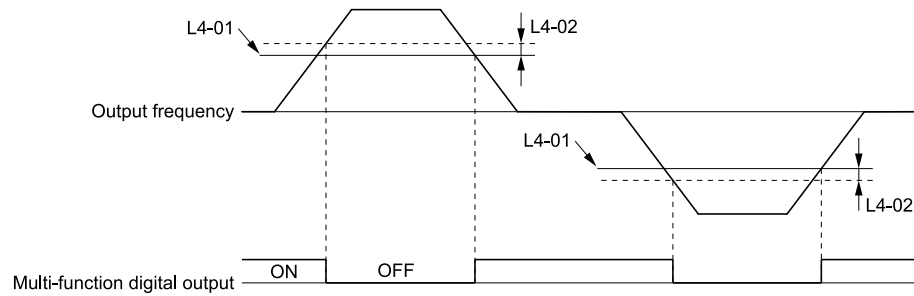

Figure 2.72 Frequency Detection 1 Time Chart

Note:

Figure 2.72 shows the result of the configuration when $L4-07 = 1$ [Speed Agree Detection Selection = Detection Always Enabled]. The default setting of $L4-07$ is 0 [No detection during baseblock]. When the speed agreement detection selection is “No Detection during Baseblock”, the terminal is deactivated when the drive output stops.

5: Frequency Detection 2

Setting Value	Function	Description
5	Frequency Detection 2	<p>V/f OLV OLV/PM AOLV/PM EZOLV</p> <p>The terminal activates when the output frequency is higher than the value of $L4-01$ [Speed Agree Detection Level]. After the terminal activates, the terminal stays activated until the output frequency is at the value of $L4-01 - L4-02$.</p>

Note:

The detection function operates in the two motor rotation directions. The drive uses the $L4-01$ value as the forward/reverse detection level.

ON : The output frequency is higher than the value of $L4-01$.

OFF : The output frequency is less than the value of “ $L4-01 - L4-02$,” or it is not more than the value of $L4-01$.

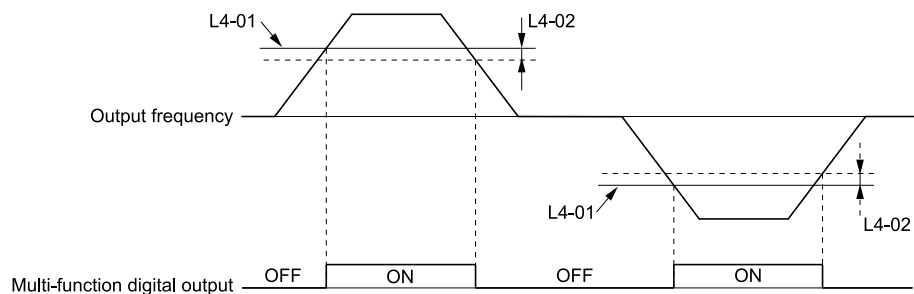

Figure 2.73 Frequency Detection 2 Time Chart

6: Drive Ready

Setting Value	Function	Description
6	Drive Ready	<p>V/f OLV OLV/PM AOLV/PM EZOLV</p> <p>The terminal activates when the drive is ready and running.</p>

The terminal deactivates in these conditions:

- When the power supply is OFF
- During a fault
- When there is problem with the control power supply
- When there is a parameter setting error and the drive cannot operate although there is a Run command
- When you enter a Run command and it immediately triggers an overvoltage or undervoltage fault because the drive has an overvoltage or undervoltage fault during stop
- When the drive is in Programming Mode and will not accept a Run command

- When the Safe Disable function is active

■ 7: DC Bus Undervoltage

Setting Value	Function	Description
7	DC Bus Undervoltage	<div style="display: flex; justify-content: space-between; align-items: center;"> V/f OLV OLV/IPM AOLV/IPM EZOLV </div> <p>The terminal activates when the DC bus voltage or control circuit power supply is at the voltage set in L2-05 [Undervoltage Detection Lvl (UvL)] or less. The terminal also activates when there is a fault with the DC bus voltage.</p>

ON : The DC bus voltage \leq L2-05

OFF : The DC bus voltage $>$ L2-05

■ 8: During Baseblock (N.O.)

Setting Value	Function	Description
8	During Baseblock (N.O.)	<div style="display: flex; justify-content: space-between; align-items: center;"> V/f OLV OLV/IPM AOLV/IPM EZOLV </div> <p>The terminal activates during baseblock. When the drive is in baseblock, the drive output transistor stops switching and does not make DC bus voltage.</p>

ON : During baseblock

OFF : The drive is not in baseblock.

■ 9: Frequency Reference from Keypad

Setting Value	Function	Description
9	Frequency Reference from Keypad	<div style="display: flex; justify-content: space-between; align-items: center;"> V/f OLV OLV/IPM AOLV/IPM EZOLV </div> <p>Shows the selected frequency reference source.</p>

ON : The keypad is the frequency reference source.

OFF : b1-01 or b1-15 [Frequency Reference Selection 1 or 2] is the frequency reference source.

■ A: Run Command from Keypad

Setting Value	Function	Description
A	Run Command Source	<div style="display: flex; justify-content: space-between; align-items: center;"> V/f OLV OLV/IPM AOLV/IPM EZOLV </div> <p>Shows the selected Run command source.</p>

ON : The keypad is the Run command source.

OFF : b1-02 or b1-16 [Run Command Selection 1 or 2] is the Run command source.

■ B: Torque Detection 1 (N.O.)

Setting Value	Function	Description
B	Torque Detection 1 (N.O.)	<div style="display: flex; justify-content: space-between; align-items: center;"> V/f OLV OLV/IPM AOLV/IPM EZOLV </div> <p>The terminal activates when the drive detects overtorque or undertorque.</p>

ON : The output current/torque $>$ L6-02 [Torque Detection Level 1], or the output current/torque $<$ L6-02 for longer than the time set in L6-03 [Torque Detection Time 1].

Note:

- When L6-01 \geq 5, the drive will detect when the output current/torque is less than L6-02 for longer than L6-03.
- Refer to [L6: Torque Detection on page 389](#) for more information.

■ C: Frequency Reference Loss

Setting Value	Function	Description
C	Frequency Reference Loss	<div style="display: flex; justify-content: space-between; align-items: center;"> V/f OLV OLV/IPM AOLV/IPM EZOLV </div> <p>The terminal activates when the drive detects a loss of frequency reference.</p>

Note:

Refer to [L4-05: Fref Loss Detection Selection on page 384](#) for more information.

■ D: Braking Resistor Fault

Setting Value	Function	Description
D	Braking Resistor Fault	<div style="display: flex; gap: 5px;"> V/f OLV OLV/PM AOLV/PM EZOLV </div> <p>The terminal activates when the mounting-type braking resistor is overheating or when there is a braking transistor fault.</p>

■ E: Fault

Setting Value	Function	Description
E	Fault	<div style="display: flex; gap: 5px;"> V/f OLV OLV/PM AOLV/PM EZOLV </div> <p>The terminal activates when the drive detects a fault.</p>

Note:

The terminal will not activate for *CPF00* and *CPF01* [Control Circuit Error] faults.

■ F: Not Used

Setting Value	Function	Description
F	Not Used	<div style="display: flex; gap: 5px;"> V/f OLV OLV/PM AOLV/PM EZOLV </div> <p>Use this setting for unused terminals or to use terminals in through mode. Also use this setting as the PLC contact output via MEMOBUS/Modbus or the communication option. This signal does not function if you do not configure signals from the PLC.</p>

■ 10: Alarm

Setting Value	Function	Description
10	Alarm	<div style="display: flex; gap: 5px;"> V/f OLV OLV/PM AOLV/PM EZOLV </div> <p>The terminal activates when the drive detects a minor fault.</p>

■ 11: Fault Reset Command Active

Setting Value	Function	Description
11	Fault Reset Command Active	<div style="display: flex; gap: 5px;"> V/f OLV OLV/PM AOLV/PM EZOLV </div> <p>The terminal activates when the drive receives the Reset command from the control circuit terminal, serial communications, or the communication option.</p>

■ 12: Timer Output

Setting Value	Function	Description
12	Timer Output	<div style="display: flex; gap: 5px;"> V/f OLV OLV/PM AOLV/PM EZOLV </div> <p>Sets the terminal as the timer output. Use this setting with the timer input set in <i>HI-xx = 18</i> [MFDI Function Selection = Timer Function].</p>

Note:

Refer to [Timer Function Operation on page 179](#) for more information.

■ 13: Speed Agree 2

Setting Value	Function	Description
13	Speed Agree 2	<div style="display: flex; gap: 5px;"> V/f OLV OLV/PM AOLV/PM EZOLV </div> <p>The terminal activates when the output frequency is in the range of the frequency reference $\pm L4-04$ [Speed Agree Detection Width (+/-)].</p>

Note:

The detection function operates in the two motor rotation directions.

ON : The output frequency is in the range of “frequency reference $\pm L4-04$ ”.

OFF : The output frequency is not in the range of “frequency reference $\pm L4-04$ ”.

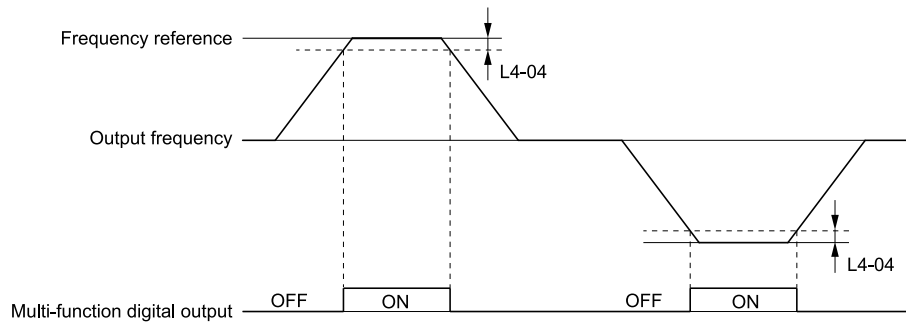

Figure 2.74 Speed Agree 2 Time Chart

■ 14: User-Set Speed Agree 2

Setting Value	Function	Description
14	User-Set Speed Agree 2	<p>V/f OLV OLV/PM AOLV/PM EZOLV</p> <p>The terminal activates when the output frequency is in the range of $L4-03$ [Speed Agree Detection Level(+/-)] $\pm L4-04$ [Speed Agree Detection Width(+/-)] and in the range of the frequency reference $\pm L4-04$.</p>

Note:

The detection level set with $L4-03$ is a signed value. The drive will only detect in one direction.

ON : The output frequency is in the range of “ $L4-03 \pm L4-04$ ” and the range of frequency reference $\pm L4-04$.

OFF : The output frequency is not in the range of “ $L4-03 \pm L4-04$ ” nor the range of frequency reference $\pm L4-04$.

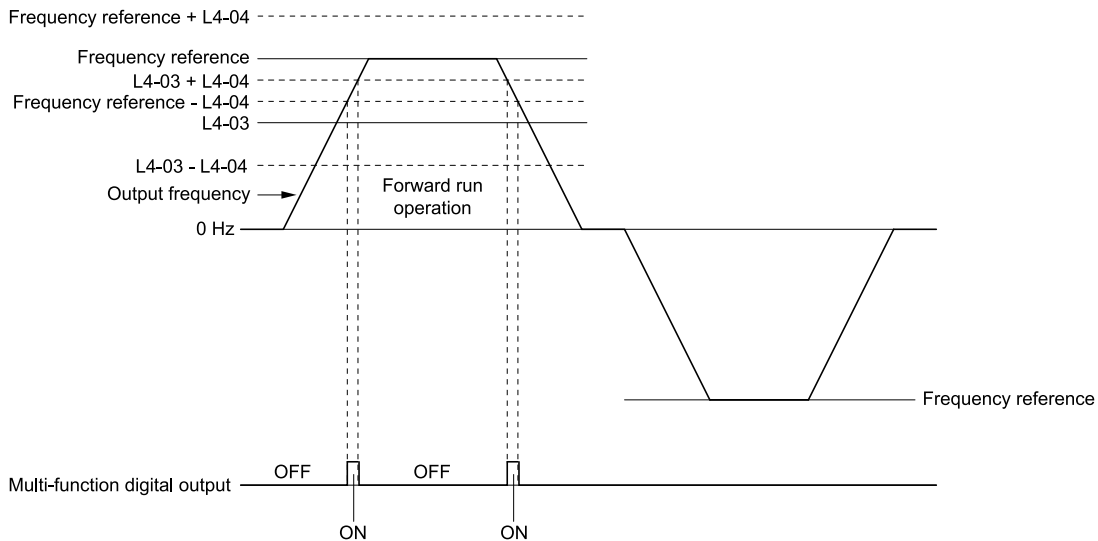

Figure 2.75 Example of User-set Speed Agree 2 (L4-03 Is Positive)

■ 15: Frequency Detection 3

Setting Value	Function	Description
15	Frequency Detection 3	<p>V/f OLV OLV/PM AOLV/PM EZOLV</p> <p>The terminal deactivates when the output frequency is more than “$L4-03$ [Speed Agree Detection Level(+/-)] + $L4-04$ [Speed Agree Detection Width(+/-)]”. After the terminal deactivates, the terminal stays deactivated until the output frequency is at the value of $L4-03$.</p>

Note:

The detection level set with $L4-03$ is a signed value. The drive will only detect in one direction.

ON : The output frequency is less than the value of $L4-03$ or it is not more than the value of $L4-03 + L4-04$.

OFF : The output frequency is higher than the value of $L4-03 + L4-04$.

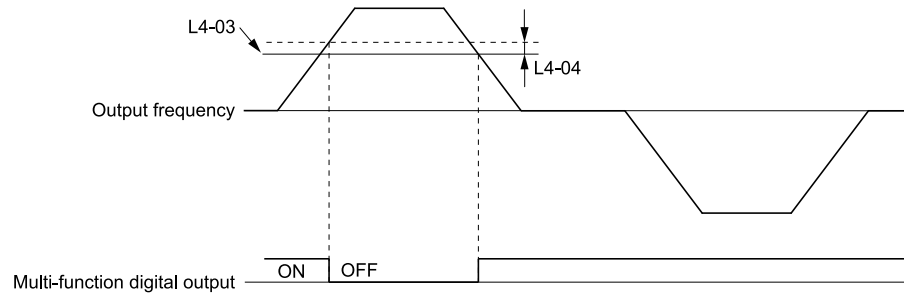

Figure 2.76 Example of Frequency Detection 3 (value of L4-03 Is Positive)

Note:

Figure 2.76 shows the result of the configuration when $L4-07 = 1$ [Speed Agree Detection Selection = Detection Always Enabled]. The default setting of $L4-07$ is 0 [No detection during baseblock]. When the speed agreement detection selection is “No Detection during Baseblock”, the terminal is deactivated when the drive output stops.

16: Frequency Detection 4

Setting Value	Function	Description
16	Frequency Detection 4	<input type="checkbox"/> V/f <input checked="" type="checkbox"/> OLV <input checked="" type="checkbox"/> OLV/PM <input checked="" type="checkbox"/> AOLV/PM <input checked="" type="checkbox"/> EZOLV The terminal activates when the output frequency is higher than the value of $L4-03$ [Speed Agree Detection Level(+/-)]. After the terminal activates, the terminal stays activated until the output frequency = $L4-03 - L4-04$.

Note:

The detection level set with $L4-03$ is a signed value. The drive will only detect in one direction.

ON : The output frequency is higher than the value of $L4-03$.

OFF : The output frequency is less than the value of “ $L4-03 - L4-04$,” or it is not more than the value of $L4-03$.

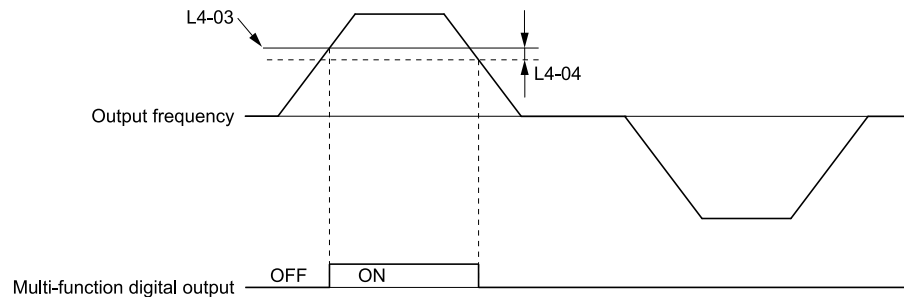

Figure 2.77 Example of Frequency Detection 4 (value of L4-03 Is Positive)

17: Torque Detection 1 (N.C.)

Setting Value	Function	Description
17	Torque Detection 1 (N.C.)	<input checked="" type="checkbox"/> V/f <input checked="" type="checkbox"/> OLV <input checked="" type="checkbox"/> OLV/PM <input checked="" type="checkbox"/> AOLV/PM <input checked="" type="checkbox"/> EZOLV The terminal deactivates when the drive detects overtorque or undertorque.

Use the $L6$ [Torque Detection] parameters to set torque detection.

OFF : The output current/torque > $L6-02$ [Torque Detection Level 1], or the output current/torque < $L6-02$ for longer than the time set in $L6-03$ [Torque Detection Time 1].

Note:

- When $L6-01 \geq 5$, the drive will detect when the output current/torque is less than $L6-02$ for longer than $L6-03$.
- Refer to [L6: Torque Detection on page 389](#) for more information.

18: Torque Detection 2 (N.O.)

Setting Value	Function	Description
18	Torque Detection 2 (N.O.)	<input checked="" type="checkbox"/> V/f <input checked="" type="checkbox"/> OLV <input checked="" type="checkbox"/> OLV/PM <input checked="" type="checkbox"/> AOLV/PM <input checked="" type="checkbox"/> EZOLV The terminal activates when the drive detects overtorque or undertorque.

Use the *L6 [Torque Detection]* parameters to set torque detection.

ON : The output current/torque > *L6-05 [Torque Detection Level 2]*, or the output current/torque < *L6-05* for longer than the time set in *L6-06 [Torque Detection Time 2]*.

Note:

- When *L6-04* ≥ 5, the drive will detect when the output current/torque is less than *L6-05* for longer than *L6-06*.
- Refer to *L6: Torque Detection on page 389* for more information.

■ **19: Torque Detection 2 (N.C.)**

Setting Value	Function	Description
19	Torque Detection 2 (N.C.)	V/f OLV OLV/IPM AOLV/IPM EZOLV The terminal deactivates when the drive detects overtorque or undertorque.

Use the *L6 [Torque Detection]* parameters to set torque detection.

OFF : The output current/torque > *L6-05 [Torque Detection Level 2]*, or the output current/torque < *L6-05* for longer than the time set in *L6-06 [Torque Detection Time 2]*.

Note:

- When *L6-04* ≥ 5, the drive will detect when the output current/torque is less than *L6-05* for longer than *L6-06*.
- Refer to *L6: Torque Detection on page 389* for more information.

■ **1A: During Reverse**

Setting Value	Function	Description
1A	During Reverse	V/f OLV OLV/IPM AOLV/IPM EZOLV The terminal activates when the motor operates in the reverse direction.

ON : The motor is operating in the reverse direction.

OFF : The motor is operating in the forward direction or the motor stopped.

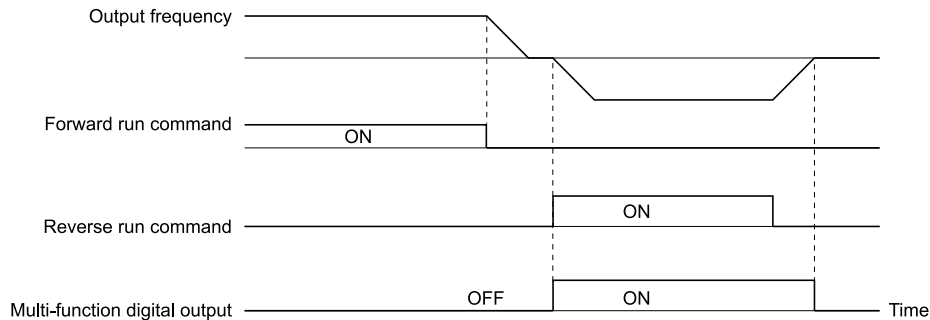

Figure 2.78 Reverse Operation Output Time Chart

■ **1B: During Baseblock (N.C.)**

Setting Value	Function	Description
1B	During Baseblock (N.C.)	V/f OLV OLV/IPM AOLV/IPM EZOLV The terminal deactivates during baseblock. When the drive is in baseblock, the drive output transistor stops switching and does not make DC bus voltage.

ON : The drive is not in baseblock.

OFF : During baseblock

■ **1C: Motor 2 Selected**

Setting Value	Function	Description
1C	Motor 2 Selected	V/f OLV OLV/IPM AOLV/IPM EZOLV The terminal activates when you select motor 2.

ON : Motor 2 Selected

OFF : Motor 1 Selected

■ 1E: Executing Auto-Restart

Setting Value	Function	Description
1E	Executing Auto-Restart	<div style="display: flex; justify-content: space-between; align-items: center;"> V/f OLV OLV/PM AOLV/PM EZOLV </div> <p>The terminal activates when the Auto Restart function is trying to restart after a fault.</p>

The terminal deactivates when the Auto Restart function automatically resets a fault. The terminal deactivates when the Auto Restart function detects the fault again because there were too many restart attempts as specified by *L5-01 [Number of Auto Restart Attempts]*.

Note:

Refer to [L5: Fault Restart on page 386](#) for more information.

■ 1F: Motor Overload Alarm (oL1)

Setting Value	Function	Description
1F	Motor Overload Alarm (oL1)	<div style="display: flex; justify-content: space-between; align-items: center;"> V/f OLV OLV/PM AOLV/PM EZOLV </div> <p>The terminal activates when the electronic thermal protection value of the motor overload protective function is a minimum of 90% of the detection level.</p>

Note:

Refer to [L1-01: Motor Overload \(oL1\) Protection on page 358](#) for more information.

■ 20: Drive Overheat Pre-Alarm (oH)

Setting Value	Function	Description
20	Drive Overheat Pre-Alarm (oH)	<div style="display: flex; justify-content: space-between; align-items: center;"> V/f OLV OLV/PM AOLV/PM EZOLV </div> <p>The terminal activates when the drive heatsink temperature is at the level set with <i>L8-02 [Overheat Alarm Level]</i>.</p>

Note:

Refer to [L8-02: Overheat Alarm Level on page 397](#) for more information.

■ 21: Safe Torque OFF

Setting Value	Function	Description
21	Safe Torque OFF	<div style="display: flex; justify-content: space-between; align-items: center;"> V/f OLV OLV/PM AOLV/PM EZOLV </div> <p>The terminal activates (safety stop state) when the safety circuit and safety diagnosis circuit are operating correctly and when terminals H1-HC and H2-HC are OFF (Open).</p>

Note:

EDM = External Device Monitor

ON : Safety stop state

Terminals H1-HC and H2-HC are OFF or released (safety stop state).

OFF : Safety circuit fault or RUN/READY

Terminal H1-HC or terminal H2-HC is OFF or released (safety circuit fault), or the two terminals are ON or short circuited (RUN/READY).

■ 22: Mechanical Weakening Detection

Setting Value	Function	Description
22	Mechanical Weakening Detection	<div style="display: flex; justify-content: space-between; align-items: center;"> V/f OLV OLV/PM AOLV/PM EZOLV </div> <p>The terminal activates when the drive detects mechanical weakening.</p>

Note:

Refer to [Mechanical Weakening Detection on page 390](#) for more information.

■ 2F: Maintenance Notification

Setting Value	Function	Description
2F	Maintenance Notification	<div style="display: flex; justify-content: space-between; align-items: center;"> V/f OLV OLV/PM AOLV/PM EZOLV </div> <p>The terminal activates when drive components are at their estimated maintenance period.</p>

Tells you about the maintenance period for these items:

- IGBT
- Cooling Fan
- Capacitor
- Soft charge bypass relay

■ 30: During Torque Limit

Setting Value	Function	Description
30	During Torque Limit	<div style="display: flex; gap: 5px;"> V/f OLV OLV/IPM AOLV/IPM EZOLV </div> <p>The terminal activates when the torque reference is the torque limit set with <i>L7 parameters</i> or <i>H3-02</i> or <i>H3-10</i> [<i>MFAI Function Selection</i>].</p>

Note:

Refer to [L7: Torque Limit on page 394](#) for more information.

■ 37: During Frequency Output

Setting Value	Function	Description
37	During Frequency Output	<div style="display: flex; gap: 5px;"> V/f OLV OLV/IPM AOLV/IPM EZOLV </div> <p>The terminal activates when the drive outputs frequency.</p>

ON : The drive is outputting frequency.

OFF : The drive is not outputting frequency.

Note:

The terminal deactivates in these conditions:

- During Stop
- During Baseblock
- During DC Injection Braking (initial excitation)
- During Short Circuit Braking
- Pole Position Detection Complete

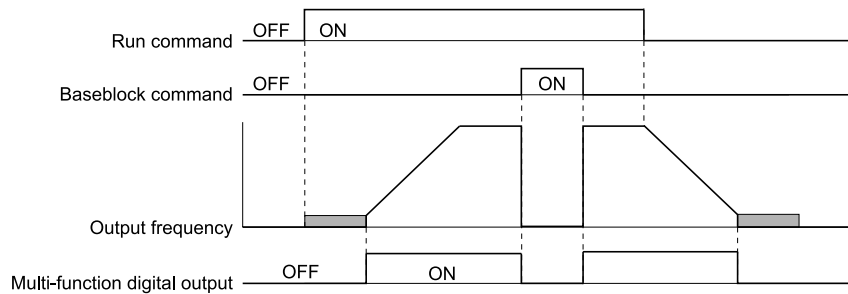

Figure 2.79 Active Frequency Output Time Chart

■ 38: Drive Enabled

Setting Value	Function	Description
38	Drive Enabled	<div style="display: flex; gap: 5px;"> V/f OLV OLV/IPM AOLV/IPM EZOLV </div> <p>This terminal activates when the <i>H1-xx = 6A</i> [<i>Drive Enable</i>] terminal activates.</p>

■ 39: Watt Hour Pulse Output

Setting Value	Function	Description
39	Watt Hour Pulse Output	<div style="display: flex; gap: 5px;"> V/f OLV OLV/IPM AOLV/IPM EZOLV </div> <p>Outputs the pulse that shows the watt hours.</p>

Note:

Refer to [H2-06: Watt Hour Output Unit Selection on page 312](#) for more information.

■ 3C: LOCAL Control Selected

Setting Value	Function	Description
3C	LOCAL Control Selected	<div style="display: flex; justify-content: space-between; align-items: center;"> V/f OLV OLV/PM AOLV/PM EZOLV </div> <p>The terminal activates when the Run command source or frequency reference source is LOCAL.</p>

ON : LOCAL

The keypad is the Run command source or the frequency reference source.

OFF : REMOTE

The Run command source or frequency reference source is an external source set with *b1-01 [Frequency Reference Selection 1]*, *b1-15 [Frequency Reference Selection 2]*, *b1-02 [Run Command Selection 1]*, or *b1-16 [Run Command Selection 2]*.

■ 3D: During Speed Search

Setting Value	Function	Description
3D	During Speed Search	<div style="display: flex; justify-content: space-between; align-items: center;"> V/f OLV OLV/PM AOLV/PM EZOLV </div> <p>The terminal activates when the drive is doing speed search.</p>

Note:

Refer to [b3: Speed Search on page 170](#) for more information.

■ 3E: PID Feedback Low

Setting Value	Function	Description
3E	PID Feedback Low	<div style="display: flex; justify-content: space-between; align-items: center;"> V/f OLV OLV/PM AOLV/PM EZOLV </div> <p>The terminal activates when the drive detects <i>FbL [PID Feedback Loss]</i>.</p>

The drive detects *FbL [PID Feedback Loss]* when the PID feedback value < *b5-13 [PID Feedback Loss Detection Lvl]* for longer than *b5-14 [PID Feedback Loss Detection Time]*.

Note:

Refer to [PID Feedback Loss Detection on page 183](#) for more information.

■ 3F: PID Feedback High

Setting Value	Function	Description
3F	PID Feedback High	<div style="display: flex; justify-content: space-between; align-items: center;"> V/f OLV OLV/PM AOLV/PM EZOLV </div> <p>The terminal activates when the drive detects <i>FbH [Excessive PID Feedback]</i>.</p>

The drive detects *FbH [Excessive PID Feedback]* when the PID feedback value > *b5-36 [PID High Feedback Detection Lvl]* for longer than *b5-37 [PID High Feedback Detection Time]*.

Note:

Refer to [PID Feedback Loss Detection on page 183](#) for more information.

■ 4A: During KEB Ride-Thru

Setting Value	Function	Description
4 A	During KEB Ride-Thru	<div style="display: flex; justify-content: space-between; align-items: center;"> V/f OLV OLV/PM AOLV/PM EZOLV </div> <p>The activates during KEB Ride-Thru.</p>

Note:

Refer to [KEB Ride-Thru Function on page 364](#) for more information.

■ 4B: During Short Circuit Braking

Setting Value	Function	Description
4B	During Short Circuit Braking	<div style="display: flex; justify-content: space-between; align-items: center;"> V/f OLV OLV/PM AOLV/PM EZOLV </div> <p>The terminal activates during Short Circuit Braking.</p>

2.8 H: Terminal Function Selection

Note:

- When $A1-02 = 8$ [Control Method Selection = EZOLV], this function is available only when you use a PM motor.
- Refer to [b2: DC Injection Braking and Short Circuit Braking on page 167](#) for more information.

■ 4C: During Fast Stop

Setting Value	Function	Description
4C	During Fast Stop	<div style="display: flex; gap: 5px;"> V/f OLV OLV/IPM AOLV/IPM EZOLV </div> <p>The terminal activates when the fast stop is in operation.</p>

■ 4D: oH Pre-Alarm Time Limit

Setting Value	Function	Description
4D	oH Pre-Alarm Time Limit	<div style="display: flex; gap: 5px;"> V/f OLV OLV/IPM AOLV/IPM EZOLV </div> <p>The terminal activates when $L8-03 = 4$ [Overheat Pre-Alarm Selection = Operate at Reduced Speed (L8-19)] and oH [Heatsink Overheat] does not clear after the drive decreases the frequency for 10 cycles.</p>

Note:

Refer to [L8-03: Overheat Pre-Alarm Selection on page 397](#) for more information.

■ 4E: Braking Transistor Fault (rr)

Setting Value	Function	Description
4E	Braking Transistor Fault (rr)	<div style="display: flex; gap: 5px;"> V/f OLV OLV/IPM AOLV/IPM EZOLV </div> <p>The terminal activates when the internal braking transistor overheats and the drive detects an rr [Dynamic Braking Transistor Fault] fault.</p>

■ 4F: Braking Resistor Overheat (rH)

Setting Value	Function	Description
4F	Braking Resistor Overheat (rH)	<div style="display: flex; gap: 5px;"> V/f OLV OLV/IPM AOLV/IPM EZOLV </div> <p>The terminal activates when the braking resistor overheats and the drive detects an rH [Braking Resistor Overheat] fault.</p>

The braking resistor overheats when the deceleration time is short and there is too much motor regeneration energy.

■ 61: Pole Position Detection Complete

Setting Value	Function	Description
61	Pole Position Detection Complete	<div style="display: flex; gap: 5px;"> V/f OLV OLV/IPM AOLV/IPM EZOLV </div> <p>The terminal activates when drive receives a Run command and the drive detects the motor magnetic pole position of the PM motor.</p>

■ 62: Modbus Reg 1 Status Satisfied

Setting Value	Function	Description
62	Modbus Reg 1 Status Satisfied	<div style="display: flex; gap: 5px;"> V/f OLV OLV/IPM AOLV/IPM EZOLV </div> <p>The terminal activates when the bit specified by H2-08 [Modbus Register 1 Bit Select] for the MEMOBUS register address set with H2-07 [Modbus Register 1 Address Select] activates.</p>

■ 63: Modbus Reg 2 Status Satisfied

Setting Value	Function	Description
63	Modbus Reg 2 Status Satisfied	<div style="display: flex; gap: 5px;"> V/f OLV OLV/IPM AOLV/IPM EZOLV </div> <p>The terminal activates when the bit specified by H2-10 [Modbus Register 2 Bit Select] for the MEMOBUS register address set with H2-09 [Modbus Register 2 Address Select] activates.</p>

■ 66: Comparator1

Setting Value	Function	Description
66	Comparator1	<div style="display: flex; gap: 5px;"> V/f OLV OLV/IPM AOLV/IPM EZOLV </div> <p>The terminal activates if the monitor value set with H2-20 [Comparator 1 Monitor Selection] is in range of the values of H2-21 [Comparator 1 Lower Limit] and H2-22 [Comparator 1 Upper Limit] for the time set in H2-24 [Comparator 1 On-Delay Time].</p>

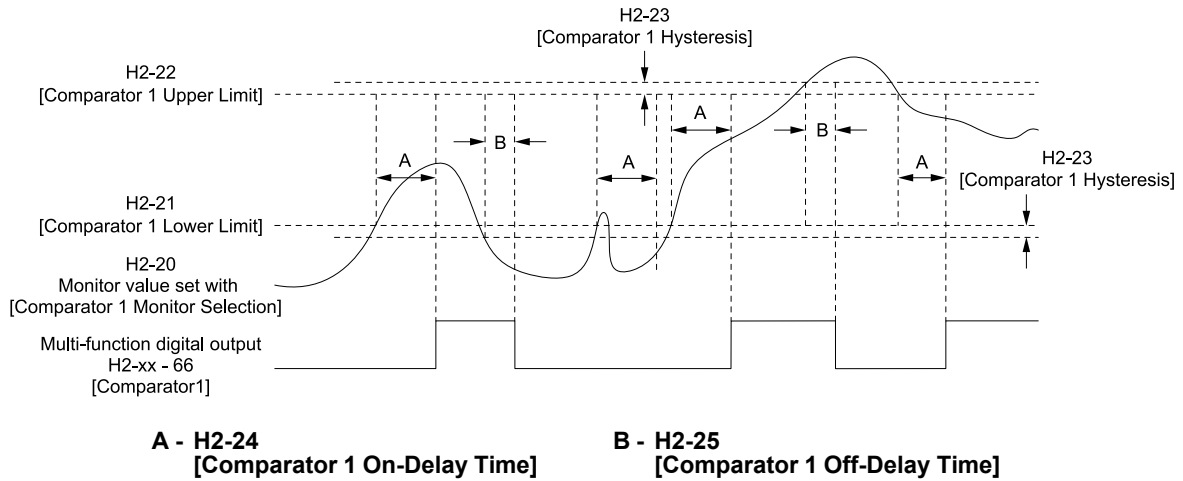

Figure 2.80 Comparator 1 Output Time Chart

Note:

The drive compares the monitors set with H2-20 as absolute values.

■ **67: Comparator2**

Setting Value	Function	Description
67	Comparator2	<p>V/f OLV OLV/PM AOLV/PM EZOLV</p> <p>The terminal activates if the monitor value set with H2-26 [Comparator 2 Monitor Selection] is not in the range of the values of H2-27 [Comparator 2 Lower Limit] and H2-28 [Comparator 2 Upper Limit] for the time set in H2-30 [Comparator 2 On-Delay Time].</p>

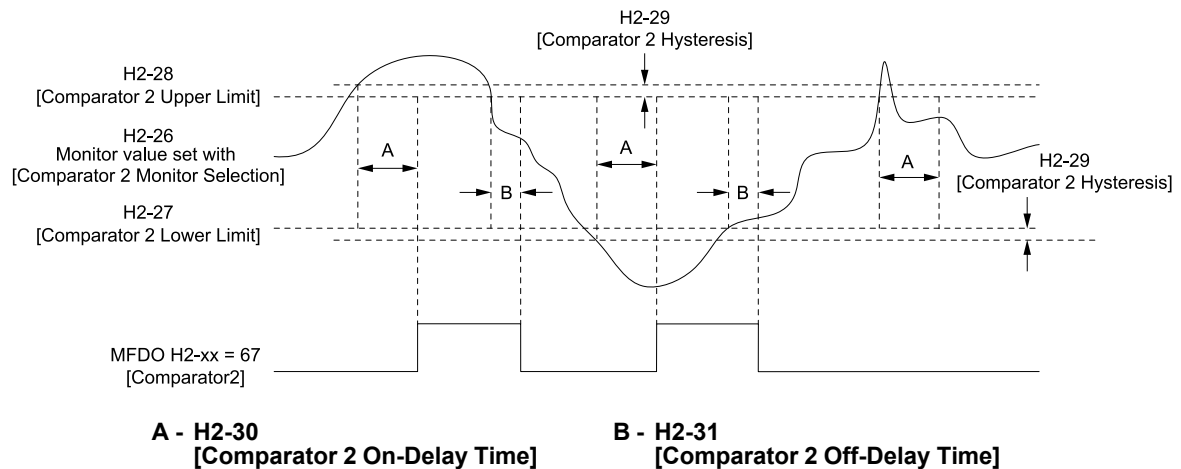

Figure 2.81 Comparator 2 Output Time Chart

Note:

The drive compares the monitors set with H2-26 as absolute values.

■ **69: External Power 24V Supply**

Setting Value	Function	Description
69	External Power 24V Supply	<p>V/f OLV OLV/PM AOLV/PM EZOLV</p> <p>The terminal activates when there is an external 24V power supply between terminals PS-AC.</p>

ON : The external 24V power supply is supplying power.

OFF : The external 24V power supply is not supplying power.

■ **6A: Data Logger Error**

Setting Value	Function	Description
6 A	Data Logger Error	<div style="display: flex; gap: 5px;"> V/f OLV OLV/PM AOLV/PM EZOLV </div> <p>The terminal activates when the drive detects a <i>LoG [Com Error / Abnormal SD card]</i>.</p>

■ **90 to 92: DWEZ Digital Output 1 to 3**

Setting Value	Function	Description
90 - 92	DWEZ Digital Output 1 to 3	<div style="display: flex; gap: 5px;"> V/f OLV OLV/PM AOLV/PM EZOLV </div> <p>Sets the DriveWorksEZ digital output. Refer to the DriveWorksEZ online manual for more information.</p>

■ **100 to 192: Inverse output of 0 to 92**

Setting Value	Function	Description
100 - 192	Inverse output of 0 to 92	<div style="display: flex; gap: 5px;"> V/f OLV OLV/PM AOLV/PM EZOLV </div> <p>Causes inverse output of the function for the selected MFDO. Uses the last two digits of <i>Ixx</i> to select which function to inversely output.</p>

For example, set $H2-xx = 10E$ for the inverse output of *E [Fault]*.

◆ **H3: Analog Inputs**

WARNING! *Sudden Movement Hazard. Do test runs and examine the drive to make sure that the command references are correct. If you set the command reference incorrectly, it can cause damage to the drive or serious injury or death.*

Drives have two analog input terminals: terminals A1 and A2. Use *H3 parameters* to set the functions to these analog input terminals and adjust signal levels.

Table 2.56 shows the functions that you can set to analog input terminals. Use *H3-02 and H3-10 [MFAI Function Select]* to set functions.

Table 2.56 Multi-Function Analog Input Terminal Settings

Setting Value	Function	Reference	Setting Value	Function	Reference
0	Frequency Reference	337	E	Motor Temperature (PTC Input)	340
1	Frequency Gain	337	F	Through Mode	340
2	Auxiliary Frequency Reference 1	338	10	Forward Torque Limit	340
3	Auxiliary Frequency Reference 2	338	11	Reverse Torque Limit	342
4	Output Voltage Bias	338	12	Regenerative Torque Limit	342
5	Accel/Decel Time Gain	338	13	Torque Reference / Torque Limit	342
6	DC Injection Braking Current	339	14	Torque Compensation	342
7	Torque Detection Level	339	15	General Torque Limit	342
8	Stall Prevent Level during Run	339	16	PID DifferentialFdbk	342
9	Output Frequency Lower Limit	339	1F	Through Mode	342
B	PID Feedback	340	30	DWEZ Analog Input 1	343
C	PID Setpoint	340	31	DWEZ Analog Input 2	343
D	Frequency Bias	340			

Note:

All analog input scaling uses gain and bias for adjustment. Set the gain and bias values correctly.

Example Analog Input Settings	Terminal A1 Setting	Frequency Reference
Frequency Reference When You Adjust the Gain Setting	<ul style="list-style-type: none"> H3-02 = 0 [Terminal A1 Function Selection = Frequency Reference] H3-03 = 200.0 [Terminal A1 Gain Setting = 200%] H3-04 = 0.0 [Terminal A1 Bias Setting = 0.0%] 	<ul style="list-style-type: none"> When you input a 10 V signal, the frequency reference will be 200%. When you input a 5 V signal, the frequency reference will be 100%. <p>When you input a 5 V or more signal, E1-04 [Maximum Output Frequency] will limit the drive output and the frequency reference will be 100%.</p> <div style="display: flex; justify-content: space-around;"> <div style="text-align: center;"> <p>H3-01 = 0</p> </div> <div style="text-align: center;"> <p>H3-01 = 4</p> </div> </div>
Frequency Reference When You Set the Bias to a Negative Number	<ul style="list-style-type: none"> H3-02 = 0 [Frequency Reference] H3-03 = 100.0 [100.0%] H3-04 = -25.0 [-25.0%] 	<ul style="list-style-type: none"> When you input a 0 V signal, the frequency reference will be -25%. When H3-01 = 0 [Terminal A1 Signal Level Select = 0 V to 10 V (Lower Limit at 0)] <ul style="list-style-type: none"> When you input a 0 V to 2 V signal, the frequency reference will be 0%. When you input a 2 V to 10 V signal, the frequency reference will be 0% to 100%. When H3-01 = 4 [-10 V to +10 V] <ul style="list-style-type: none"> When you input a 0 V to 2 V signal, it enables signals of positive and negative polarities and the motor rotates in reverse. <div style="display: flex; justify-content: space-around;"> <div style="text-align: center;"> <p>H3-01 = 0</p> </div> <div style="text-align: center;"> <p>H3-01 = 4</p> </div> </div>

MEMOBUS/Modbus MFAI 1 to 3 Function Selection

You can set the MFAI function to MEMOBUS/Modbus register 15C1 to 15C3 (Hex.) [Mbus Reg 15C1h through 15C3h Input Function]. Use H3-40 to H3-42 [Mbus Reg 15C1h through 15C3h Input Function] to set the function for each register and use H3-43 [Mbus Reg Inputs FilterTime Const] to set the input filter.

Table 2.57 MEMOBUS Multi-Function AI Command Register

Register number (Hex.)	Name	Range *1	Parameter
15C1	Mbus Reg 15C1h Input Function	-32767 to +32767	H3-40
15C2	Mbus Reg 15C2h Input Function	-32767 to +32767	H3-41
15C3	Mbus Reg 15C3h Input Function	-32767 to +32767	H3-42

*1 Set as 100% = 4096.

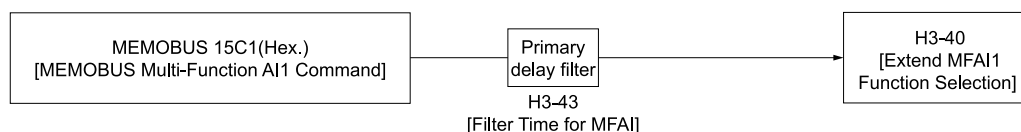

Figure 2.82 Functional Block Diagram for MEMOBUS Multi-Function AI Command 1

2.8 H: Terminal Function Selection

Note:

- Refer to [Multi-Function Analog Input Terminal Settings on page 337](#) for the analog input setting values.
- When you will not use the terminal, set *H3-40 to H3-42 = F*. Parameters *H3-40 to H3-42* do not support the through mode.
- You cannot use *H3-40 to H3-42* to set these MFAI functions:

H3-xx Setting Value	Function
0	Frequency Reference
1	Frequency Gain
2	Auxiliary Frequency Reference 1
3	Auxiliary Frequency Reference 2
30	DWEZ Analog Input 1
31	DWEZ Analog Input 2

◆ H3: MFAI Parameters

■ H3-01: Terminal A1 Signal Level Select

No. (Hex.)	Name	Description	Default (Range)
H3-01 (0410)	Terminal A1 Signal Level Select	<input type="radio"/> V/f <input type="radio"/> OLV <input type="radio"/> OLV/IPM <input type="radio"/> AOLV/IPM <input type="radio"/> EZOLV Sets the input signal level for MFAI terminal A1.	0 (0, 4)

0 : 0 to 10V (Lower Limit at 0)

The voltage signal is 0 Vdc to 10 Vdc. The minimum input level limit is 0%. The drive will read a negative input signal caused by gain and bias settings as 0%.

4 : -10 to +10V (Bipolar Reference)

The voltage signal is -10 Vdc to 10 Vdc. Signals of both positive and negative polarities are enabled. When this setting is used as the frequency reference, the motor runs reverse when the Forward run command is input, or runs forward when the Reverse run signal is input, while the signal is a negative number due to gain and bias.

■ H3-02: Terminal A1 Function Selection

No. (Hex.)	Name	Description	Default (Range)
H3-02 (0434)	Terminal A1 Function Selection	<input type="radio"/> V/f <input type="radio"/> OLV <input type="radio"/> OLV/IPM <input type="radio"/> AOLV/IPM <input type="radio"/> EZOLV Sets the function for MFAI terminal A1.	0 (0 - 32)

■ H3-03: Terminal A1 Gain Setting

No. (Hex.)	Name	Description	Default (Range)
H3-03 (0411) RUN	Terminal A1 Gain Setting	<input type="radio"/> V/f <input type="radio"/> OLV <input type="radio"/> OLV/IPM <input type="radio"/> AOLV/IPM <input type="radio"/> EZOLV Sets the gain of the analog signal input to MFAI terminal A1.	100.0% (-999.9 - +999.9%)

This parameter sets the quantity of reference for the function set for terminal A1 as a percentage when 10 V (or 20 mA) is input.

Use this parameter and *H3-04 [Terminal A1 Bias Setting]* to adjust the characteristics of the analog input signal to terminal A1.

■ H3-04: Terminal A1 Bias Setting

No. (Hex.)	Name	Description	Default (Range)
H3-04 (0412) RUN	Terminal A1 Bias Setting	<input type="radio"/> V/f <input type="radio"/> OLV <input type="radio"/> OLV/IPM <input type="radio"/> AOLV/IPM <input type="radio"/> EZOLV Sets the bias of the analog signal input to MFAI terminal A1.	0.0% (-999.9 - +999.9%)

This parameter sets the bias for the function set for terminal A1 as a percentage when 0 V (4 mA or 0 mA) is input. Use this parameter and *H3-03 [Terminal A1 Gain Setting]* to adjust the characteristics of the analog input signal to terminal A1.

■ H3-09: Terminal A2 Signal Level Select

No. (Hex.)	Name	Description	Default (Range)
H3-09 (0417)	Terminal A2 Signal Level Select	<input type="radio"/> V/f <input type="radio"/> OLV <input type="radio"/> OLV/PM <input type="radio"/> AOLV/PM <input type="radio"/> EZOLV Sets the input signal level for MFAI terminal A2.	2 (0, 2 - 4)

0 : 0-10V (LowLim=0)

The voltage signal is 0 Vdc to 10 Vdc. The minimum input level limit is 0%. The drive will read a negative input signal caused by gain and bias settings as 0%.

2 : 4 to 20 mA

The current signal is 4 mA to 20 mA. The minimum input level is limited to 0%, so that a negative input signal due to gain and bias settings will be read as 0%.

3 : 0 to 20 mA

The current signal is 0 mA to 20 mA. The minimum input level is limited to 0%, so that a negative input signal due to gain and bias settings will be read as 0%.

4 : -10 to +10V (Bipolar Reference)

The voltage signal is -10 Vdc to 10 Vdc. Signals of both positive and negative polarities are enabled. When this setting is used as the frequency reference, the motor runs reverse when the Forward run command is input, or runs forward when the Reverse run signal is input, while the signal is a negative number due to gain and bias.

Note:

When *H3-09 = 0, 4*, set DIP switch S1 to the V side (voltage). When *H3-09 = 2, 3*, set DIP switch S1 to the I side (current). The default setting is the I side (current).

■ H3-10: Terminal A2 Function Selection

No. (Hex.)	Name	Description	Default (Range)
H3-10 (0418)	Terminal A2 Function Selection	<input type="radio"/> V/f <input type="radio"/> OLV <input type="radio"/> OLV/PM <input type="radio"/> AOLV/PM <input type="radio"/> EZOLV Sets the function for MFAI terminal A2.	0 (0 - 32)

■ H3-11: Terminal A2 Gain Setting

No. (Hex.)	Name	Description	Default (Range)
H3-11 (0419) RUN	Terminal A2 Gain Setting	<input type="radio"/> V/f <input type="radio"/> OLV <input type="radio"/> OLV/PM <input type="radio"/> AOLV/PM <input type="radio"/> EZOLV Sets the gain of the analog signal input to MFAI terminal A2.	100.0% (-999.9 - +999.9%)

When 10 V (or 20 mA) is input, this parameter sets the reference quantity for the function set for terminal A2 as a percentage.

Use this parameter and *H3-12 [Terminal A2 Bias Setting]* to adjust the characteristics of the analog input signal to terminal A2.

■ H3-12: Terminal A2 Bias Setting

No. (Hex.)	Name	Description	Default (Range)
H3-12 (041A) RUN	Terminal A2 Bias Setting	<input type="radio"/> V/f <input type="radio"/> OLV <input type="radio"/> OLV/PM <input type="radio"/> AOLV/PM <input type="radio"/> EZOLV Sets the bias of the analog signal input to MFAI terminal A2.	0.0% (-999.9 - +999.9%)

When 0 V (4 mA or 0 mA) is input, this parameter sets the bias for the function set for terminal A2 as a percentage.

Use this parameter and *H3-11 [Terminal A2 Gain Setting]* to adjust the characteristics of the analog input signal to terminal A2.

■ H3-13: Analog Input FilterTime Constant

No. (Hex.)	Name	Description	Default (Range)
H3-13 (041B)	Analog Input FilterTime Constant	<div style="display: flex; gap: 5px;"> V/f OLV OLV/PM AOLV/PM EZOLV </div> Sets the time constant for primary delay filters on MFAI terminals.	0.03 s (0.00 - 2.00 s)

Apply the primary delay filter to the analog input to enable an analog input signal without the use of high-frequency noise components. An analog input filter prevents irregular drive control. Drive operation becomes more stable as the programmed time becomes longer, but it also becomes less responsive to quickly changing analog signals.

■ H3-14: Analog Input Terminal Enable Sel

No. (Hex.)	Name	Description	Default (Range)
H3-14 (041C)	Analog Input Terminal Enable Sel	<div style="display: flex; gap: 5px;"> V/f OLV OLV/PM AOLV/PM EZOLV </div> Sets the enabled terminal or terminals when $H1-xx = C$ [MFDI Function Select = Analog Terminal Enable Selection] is ON.	7 (1, 2, 7)

Input signals do not have an effect on terminals not set as targets.

1 : Terminal A1 only

2 : Terminal A2 only

7 : Terminals A1 and A2

Note:

- The ON/OFF operation of terminal Sx set in *Analog Terminal Input Selection [H1-xx = C]* has an effect on only the analog input terminal selected with *H3-14*.
- When $H1-xx \neq C$, the functions set to terminals A1 and A2 are always enabled.

■ H3-16: Terminal A1 Offset

No. (Hex.)	Name	Description	Default (Range)
H3-16 (02F0)	Terminal A1 Offset	<div style="display: flex; gap: 5px;"> V/f OLV OLV/PM AOLV/PM EZOLV </div> Sets the offset level for analog signals input to terminal A1. Usually it is not necessary to change this setting.	0 (-500 - +500)

Adds the offset value for the analog input value. For voltage input, this parameter will set the offset when a signal of 0 V is input.

■ H3-17: Terminal A2 Offset

No. (Hex.)	Name	Description	Default (Range)
H3-17 (02F1)	Terminal A2 Offset	<div style="display: flex; gap: 5px;"> V/f OLV OLV/PM AOLV/PM EZOLV </div> Sets the offset level for analog signals input to terminal A2. Usually it is not necessary to change this setting.	0 (-500 - +500)

Adds the offset value for the analog input value. For voltage input, this parameter will set the offset when a signal of 0 V is input. For current input, this parameter will set the offset when a signal of 4 mA [$H3-09 = 2$] or 0 mA [$H3-09 = 3$] is input.

■ H3-40: Mbus Reg 15C1h Input Function

No. (Hex.)	Name	Description	Default (Range)
H3-40 (0B5C)	Mbus Reg 15C1h Input Function	<div style="display: flex; gap: 5px;"> V/f OLV OLV/PM AOLV/PM EZOLV </div> Sets the MEMOBUS A11 function.	F (4 - 2F)

You can use the MFAI function from MEMOBUS/Modbus communications. Use this parameter to set the function. Sets the function for MEMOBUS/Modbus register 15C1h.

Refer to [H3: Analog Inputs on page 332](#) for the setting values.

■ H3-41: Mbus Reg 15C2h Input Function

No. (Hex.)	Name	Description	Default (Range)
H3-41 (0B5F)	Mbus Reg 15C2h Input Function	<input type="checkbox"/> V/f <input type="checkbox"/> OLV <input type="checkbox"/> OLV/PM <input type="checkbox"/> AOLV/PM <input type="checkbox"/> EZOLV Sets the MEMOBUS AI2 function.	F (4 - 2F)

You can use the MFAI function from MEMOBUS/Modbus communications. Use this parameter to set the function. Sets the function for MEMOBUS/Modbus register 15C2h.

Refer to [H3: Analog Inputs on page 332](#) for the setting values.

■ H3-42: Mbus Reg 15C3h Input Function

No. (Hex.)	Name	Description	Default (Range)
H3-42 (0B62)	Mbus Reg 15C3h Input Function	<input type="checkbox"/> V/f <input type="checkbox"/> OLV <input type="checkbox"/> OLV/PM <input type="checkbox"/> AOLV/PM <input type="checkbox"/> EZOLV Sets the MEMOBUS AI3 function.	F (4 - 2F)

You can use the MFAI function from MEMOBUS/Modbus communications. Use this parameter to set the function. Sets the function for MEMOBUS/Modbus register 15C3h.

Refer to [H3: Analog Inputs on page 332](#) for the setting values.

■ H3-43: Mbus Reg Inputs FilterTime Const

No. (Hex.)	Name	Description	Default (Range)
H3-43 (117F)	Mbus Reg Inputs FilterTime Const	<input type="checkbox"/> V/f <input type="checkbox"/> OLV <input type="checkbox"/> OLV/PM <input type="checkbox"/> AOLV/PM <input type="checkbox"/> EZOLV Sets the time constant to apply a primary delay filter to the MEMOBUS analog input register values.	0.00 s (0.00 - 2.00 s)

◆ Multi-Function Analog Input Terminal Settings

This section gives information about the functions set with *H3-02*, *H3-10*, and *H3-40* to *H3-42*.

■ 0: Frequency Reference

Setting Value	Function	Description
0	Frequency Reference	<input type="checkbox"/> V/f <input type="checkbox"/> OLV <input type="checkbox"/> OLV/PM <input type="checkbox"/> AOLV/PM <input type="checkbox"/> EZOLV The input value from the MFAI terminal set with this function becomes the master frequency reference.

- You can copy the configuration to more than one of the analog input terminals A1 and A2. When you set more than one analog input terminal with the master frequency reference, the sum value becomes the frequency bias.
- If you use this function to set the analog input value as the master frequency reference, set $b1-01 = 1$ [*Frequency Reference Selection 1 = Analog Input*]. This setting value is the default value for terminals A1 and A2.
- The frequency reference is the sum of the input values for terminals A1 and A2 when they are used at the same time. For example, when a 20% bias is input to terminal A2 while a frequency reference of 50% is input from terminal A1, the calculated frequency reference will be 70% of the maximum output frequency.

■ 1: Frequency Gain

Setting Value	Function	Description
1	Frequency Gain	<input type="checkbox"/> V/f <input type="checkbox"/> OLV <input type="checkbox"/> OLV/PM <input type="checkbox"/> AOLV/PM <input type="checkbox"/> EZOLV The drive multiplies the analog frequency reference with the input value from the MFAI set with this function.

Example: When you set frequency gain for terminal A2

- $H3-10 = 1$ [*Terminal A2 Function Selection = Frequency Gain*]
- A 50% frequency gain is input to terminal A2
- A frequency reference of 80% is input from terminal A1

The calculated frequency reference is 40% of the maximum output frequency.

■ 2: Auxiliary Frequency Reference 1

Setting Value	Function	Description
2	Auxiliary Frequency Reference 1	<div style="display: flex; justify-content: space-between; align-items: center;"> V/f OLV OLV/IPM AOLV/IPM EZOLV </div> <p>Sets Reference 2 through multi-step speed reference to enable the command reference (Auxiliary Frequency Reference 1) from the analog input terminal set here. This value is a percentage where the Maximum Output Frequency setting is a setting value of 100%.</p>

■ 3: Auxiliary Frequency Reference 2

Setting Value	Function	Description
3	Auxiliary Frequency Reference 2	<div style="display: flex; justify-content: space-between; align-items: center;"> V/f OLV OLV/IPM AOLV/IPM EZOLV </div> <p>Sets Reference 3 through multi-step speed reference to enable the command reference (Auxiliary Frequency Reference 2) from the analog input terminal set here. This value is a percentage where the Maximum Output Frequency setting is a setting value of 100%.</p>

■ 4: Output Voltage Bias

Setting Value	Function	Description
4	Output Voltage Bias	<div style="display: flex; justify-content: space-between; align-items: center;"> V/f OLV OLV/IPM AOLV/IPM EZOLV </div> <p>Set this parameter to input a bias signal to amplify the output voltage.</p>

The gain (%) for the MFAI terminals A1 and A2 is 100% of the voltage class standard, which is 200 V for 200 V class drives and 400 V for 400 V class drives. The bias (%) for MFAI terminals A1 and A2 is 100% of the voltage configured for *E1-05 [Maximum Output Voltage]*.

Note:

The gain for each terminal A1 and A2 is set independently with *H3-03 [Terminal A1 Gain Setting]* and *H3-11 [Terminal A2 Gain Setting]*. The bias for each terminal A1 and A2 is set independently with *H3-04 [Terminal A1 Bias Setting]* and *H3-12 [Terminal A2 Bias Setting]*.

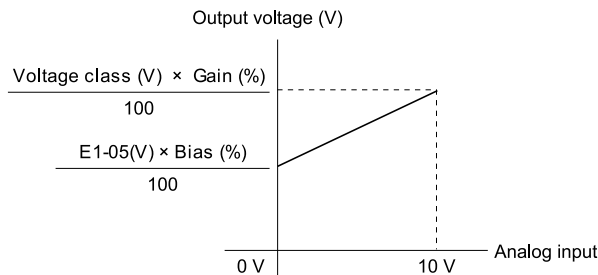

Figure 2.83 Output Voltage Bias through Analog Input

■ 5: Accel/Decel Time Gain

Setting Value	Function	Description
5	Accel/Decel Time Gain	<div style="display: flex; justify-content: space-between; align-items: center;"> V/f OLV OLV/IPM AOLV/IPM EZOLV </div> <p>Enters a signal to adjust the gain used for <i>C1-01 to C1-08 [Acceleration/Deceleration Times 1 to 4]</i> and <i>C1-09 [Fast Stop Time]</i> when the full scale analog signal (10 V or 20 mA) is 100%.</p>

When you enable *C1-01 [Acceleration Time 1]*, the acceleration time is:

$$\text{Acceleration Time 1} = \text{Setting value of } C1-01 \times \text{acceleration and deceleration time gain} / 100$$

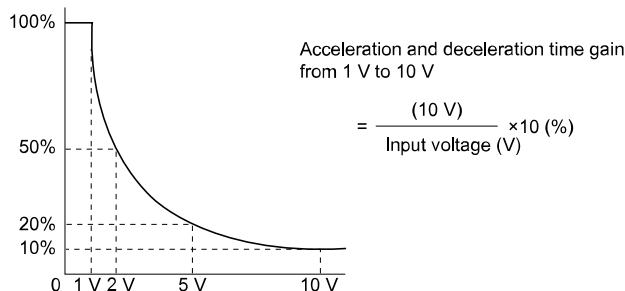

Figure 2.84 Acceleration/Deceleration Time Gain through Analog Input

6: DC Injection Braking Current

Setting Value	Function	Description
6	DC Injection Braking Current	<div style="display: flex; justify-content: space-between; align-items: center;"> V/f OLV OLV/PM AOLV/PM EZOLV </div> Enters a signal to adjust the current level used for DC Injection Braking when the drive rated output current is 100%.

Note:

When you set this function, it will disable the setting value of *b2-02 [DC Injection Braking Current]*.

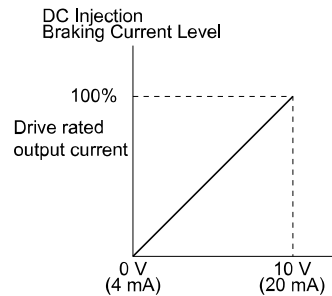

Figure 2.85 DC Injection Braking Current through Analog Input

7: Torque Detection Level

Setting Value	Function	Description
7	Torque Detection Level	<div style="display: flex; justify-content: space-between; align-items: center;"> V/f OLV OLV/PM AOLV/PM EZOLV </div> Enters a signal to adjust the overtorque/undertorque detection level.

When *A1-02 = 0, 5 [Control Method Selection = V/f, OLV/PM]*, the drive rated current is 100%. When *A1-02 = 2, 6, 8 [OLV, AOLV/PM, or EZOLV]*, the motor rated current is 100%.

Note:

Use this function with *L6-01 [Torque Detection Selection 1]*. This parameter functions as an alternative to *L6-02 [Torque Detection Level 1]*.

8: Stall Prevent Level during Run

Setting Value	Function	Description
8	Stall Prevent Level during Run	<div style="display: flex; justify-content: space-between; align-items: center;"> V/f OLV OLV/PM AOLV/PM EZOLV </div> Enters a signal to adjust the stall prevention level during run if the drive rated current is 100%.

Note:

The drive will use the smaller value of these values for Stall Prevent Level during Run:

- Multi-function analog input terminal analog input value
- *L3-06 [Stall Prevent Level during Run]*

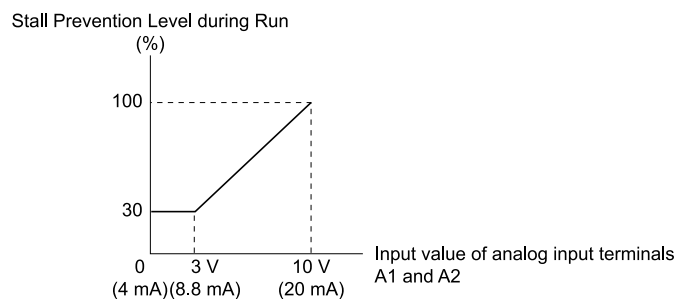

Figure 2.86 Stall Prevention Level during Run with Analog Input

9: Output Frequency Lower Limit

Setting Value	Function	Description
9	Output Frequency Lower Limit	<div style="display: flex; justify-content: space-between; align-items: center;"> V/f OLV OLV/PM AOLV/PM EZOLV </div> Enters a signal to adjust the output frequency lower limit level as a percentage of the maximum output frequency.

■ B: PID Feedback

Setting Value	Function	Description
B	PID Feedback	<div style="display: flex; justify-content: space-between; align-items: center;"> V/f OLV OLV/PM AOLV/PM EZOLV </div> Enter the PID feedback value as a percentage of the maximum output frequency.

When you use this function, set $b5-01 = 1$ to 8 [PID Mode Setting = Enabled].

■ C: PID Setpoint

Setting Value	Function	Description
C	PID Setpoint	<div style="display: flex; justify-content: space-between; align-items: center;"> V/f OLV OLV/PM AOLV/PM EZOLV </div> Enters the PID setpoint as a percentage of the maximum output frequency.

When you use this function, set $b5-01 = 1$ to 8 [PID Mode Setting = Enabled].

Note:

Configuring this function disables the frequency reference set with $b1-01$ [Frequency Reference Selection 1].

■ D: Frequency Bias

Setting Value	Function	Description
D	Frequency Bias	<div style="display: flex; justify-content: space-between; align-items: center;"> V/f OLV OLV/PM AOLV/PM EZOLV </div> Enters the bias value added to the frequency reference as a percentage of the maximum output frequency.

The drive adds the input value from the MFAI terminal set with this function to the frequency reference as the bias value.

Note:

When you select $d1-01$ to $d1-16$ or $d1-17$ [Reference 1 to 16 or JOG Frequency Reference] as the frequency reference, it will disable this function.

■ E: Motor Temperature (PTC Input)

Setting Value	Function	Description
E	Motor Temperature (PTC Input)	<div style="display: flex; justify-content: space-between; align-items: center;"> V/f OLV OLV/PM AOLV/PM EZOLV </div> Uses the motor Positive Temperature Coefficient (PTC) thermistor to prevent heat damage to the motor as a percentage of the current value when the 10 V analog signal is input.

- You can use the Positive Temperature Coefficient (PTC) thermistor as an auxiliary or alternative detection function for $oL1$ [Motor Overload] problems to help prevent heat damage to motors. If the PTC input signal is more than the overload alarm level, $oH3$ [Motor Overheat (PTC Input)] will flash on the keypad.
- When the drive detects $oH3$, the motor stops with the setting in $L1-03$. When the drive detects $oH4$, the motor stops with the setting in $L1-04$. When the drive incorrectly detects motor overheating problems, set $L1-05$.

■ F: Not Used

Setting Value	Function	Description
F	Not Used	<div style="display: flex; justify-content: space-between; align-items: center;"> V/f OLV OLV/PM AOLV/PM EZOLV </div> Use this setting for unused terminals or to use terminals in through mode.

When you set a terminal that is not in use to F, you can use the signal input to the terminal as PLC analog signal input through MEMOBUS/Modbus communications or the communication option. This input signal does not have an effect on drive operation. This functions the same as setting 1F (Through Mode).

■ 10: Forward Torque Limit

Setting Value	Function	Description
10	Forward Torque Limit	<div style="display: flex; justify-content: space-between; align-items: center;"> V/f OLV OLV/PM AOLV/PM EZOLV </div> Enters the forward torque limit if the motor rated torque is 100%.

WARNING! Sudden Movement Hazard. Set correct torque limits for applications, for example elevator applications. If you set torque limits incorrectly, motor torque that is not sufficient can cause damage to equipment and cause serious injury or death.

Torque Limit Configuration Method

Use one of these methods to set torque limits:

- Individually set the four torque limit quadrants using *L7-01 to L7-04 [Torque Limit]*.
- Use MFAI to individually set the four torque limit quadrants. Set *H3-02, H3-10 = 10, 11, 12 [MFAI Function Select = Forward/Reverse/Regenerative Torque Limit]*.
- Use MFAI to set all four torque limit quadrants together. Set *H3-02, H3-10 = 15 [General Torque Limit]*.
- Use a communication option to set all four torque limit quadrants together.

Figure 2.87 shows the configuration method for each quadrant.

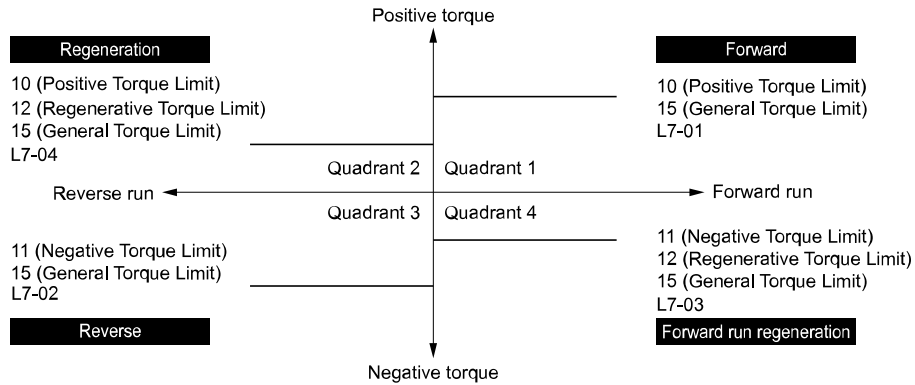

Figure 2.87 Torque Limits and Analog Input Setting Parameters

Note:

- When *L7-01 to L7-04* and analog inputs or communication option torque limits set torque limits for the same quadrant, the lower value is enabled. In this example of parameter settings, the torque limit for quadrant 1 is 130% and the torque limit for quadrants 2, 3, and 4 is 150%. Settings: *L7-01 = 130%, L7-02 to L7-04 = 200%*, and MFAI torque limit = 150%
- The drive output current limits maximum output torque. The torque limit is 150% of the rated output current for HD and to 120% of the rated output current for ND. The actual output torque is not more than the limits of the drive rated output current when you set the torque limit to a high value.

If you use drives in applications where the vertical axis can fall, make sure that you know these items:

- Correctly configure drives and motors.
- Correctly set parameters.
- You can change parameter values after you do Auto-Tuning.
- Use a system that will not let the vertical axis fall if the drive fails.

Figure 2.88 shows the relation between torque limits from parameters and torque limits from analog input.

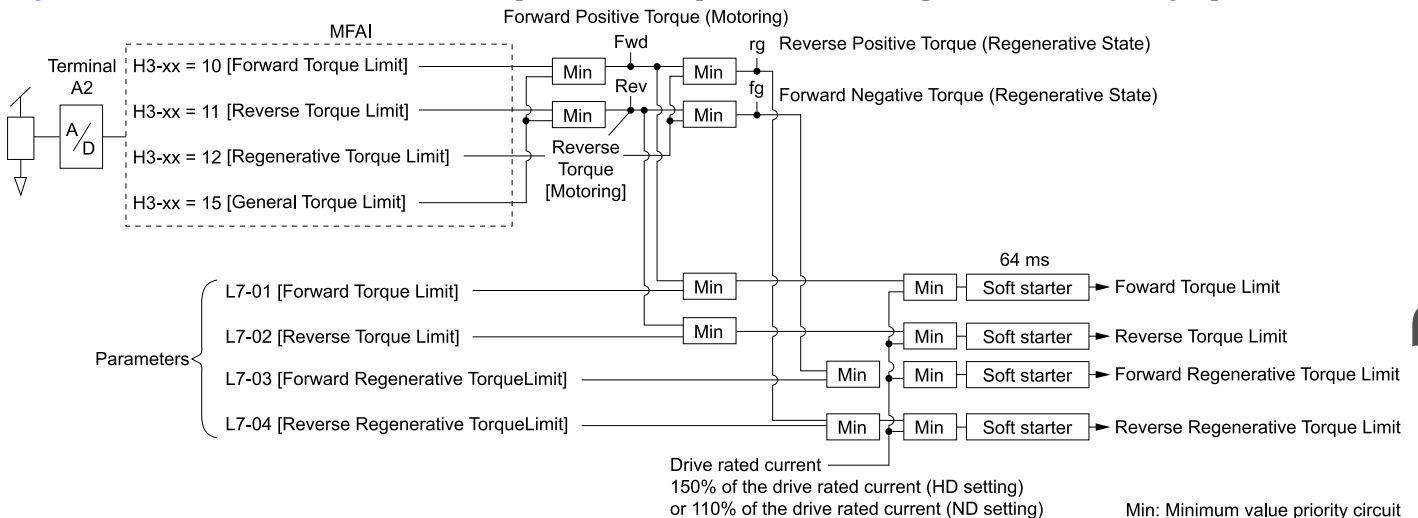

Figure 2.88 Torque Limits from Parameters and Analog Inputs

■ 11: Reverse Torque Limit

Setting Value	Function	Description
11	Reverse Torque Limit	<div style="display: flex; gap: 5px;"> V/f OLV OLV/IPM AOLV/IPM EZOLV </div> Enters the load torque limit if the motor rated torque is 100%.

Note:

When you use L7-01 to L7-04 and analog inputs to set torque limits for the same quadrant, it will enable the lower torque limit.

■ 12: Regenerative Torque Limit

Setting Value	Function	Description
12	Regenerative Torque Limit	<div style="display: flex; gap: 5px;"> V/f OLV OLV/IPM AOLV/IPM EZOLV </div> Enters the regenerative torque limit if the motor rated torque is 100%.

Note:

When you use L7-01 to L7-04 and analog inputs to set torque limits for the same quadrant, it will enable the lower torque limit.

■ 13: Torque Reference / Torque Limit

Setting Value	Function	Description
13	Torque Reference / Torque Limit	<div style="display: flex; gap: 5px;"> V/f OLV OLV/IPM AOLV/IPM EZOLV </div> Enters the torque reference if the motor rated torque is 100%. This setting is the torque limit for speed control.

Note:

When you use L7-01 to L7-04 and analog inputs to set torque limits for the same quadrant, it will enable the lower torque limit.

■ 14: Torque Compensation

Setting Value	Function	Description
14	Torque Compensation	<div style="display: flex; gap: 5px;"> V/f OLV OLV/IPM AOLV/IPM EZOLV </div> Enters the torque compensation value if the motor rated torque is 100%.

■ 15: General Torque Limit

Setting Value	Function	Description
15	General Torque Limit	<div style="display: flex; gap: 5px;"> V/f OLV OLV/IPM AOLV/IPM EZOLV </div> Enters the torque limit that is the same for all quadrants for forward, reverse, and regenerative operation if the motor rated torque is 100%.

■ 16: Differential PID Feedback

Setting Value	Function	Description
16	Differential PID Feedback	<div style="display: flex; gap: 5px;"> V/f OLV OLV/IPM AOLV/IPM EZOLV </div> Enters the PID differential feedback value if the full scale analog signal (10 V or 20 mA) is 100%.

The drive uses the deviation between the PID feedback and the differential feedback value signals to calculate the PID input.

■ 1F: Not Used

Setting Value	Function	Description
1F	Not Used	<div style="display: flex; gap: 5px;"> V/f OLV OLV/IPM AOLV/IPM EZOLV </div> Use this setting for unused terminals or to use terminals in through mode.

When you set a terminal that you do not use to 1F, you can use the signal that is input to that terminal as the PLC analog signal input from MEMOBUS/Modbus communications or the communication option. This input signal does not have an effect on drive operation. This signal functions the same as F (Through Mode).

■ 30: DWEZ Analog Input 1

Setting Value	Function	Description
30	DWEZ Analog Input 1	<div style="display: flex; justify-content: space-between; align-items: center;"> V/f OLV OLV/PM AOLV/PM EZOLV </div> Use with DriveWorksEZ. Refer to the DriveWorksEZ online manual for more information.

■ 31: DWEZ Analog Input 2

Setting Value	Function	Description
31	DWEZ Analog Input 2	<div style="display: flex; justify-content: space-between; align-items: center;"> V/f OLV OLV/PM AOLV/PM EZOLV </div> Use with DriveWorksEZ. Refer to the DriveWorksEZ online manual for more information.

◆ H4: Analog Outputs

H4 parameters set the drive analog monitors. These parameters select monitor parameters, adjust gain and bias, and select output signal levels.

■ Calibrate Meters Connected to MFAO Terminal AM

Use these parameters to calibrate meters connected to terminal AM:

- H4-02 [Terminal AM Analog Output Gain]
- H4-03 [Terminal AM Analog Output Bias]

Set these parameters where the output voltage of 10 V and output current of 20 mA are 100% of the signal level. Use jumper switch *S5* and parameter *H4-07 [Terminal AM Signal Level Select]* to set the voltage output and current output.

No.	Name	Range	Default
H4-02	Terminal AM Analog Output Gain	-999.9 - +999.9%	100.0%
H4-03	Terminal AM Analog Output Bias	-999.9 - +999.9%	0.0%
H4-07	Terminal AM Signal Level Select	0: 0 +10 VDC 2: 4-20 mA	0

Figure 2.89 and Figure 2.90 show the gain and bias.

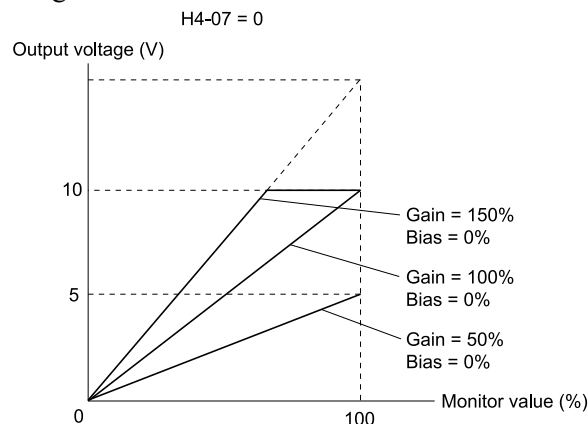

Figure 2.89 Analog Output Gain/Bias Configuration Example 1

For example, when the parameter value set to analog output is 0, and a 3 V signal is to be output to terminal AM, set *H4-03 [AM Analog Output Bias]* = 30%.

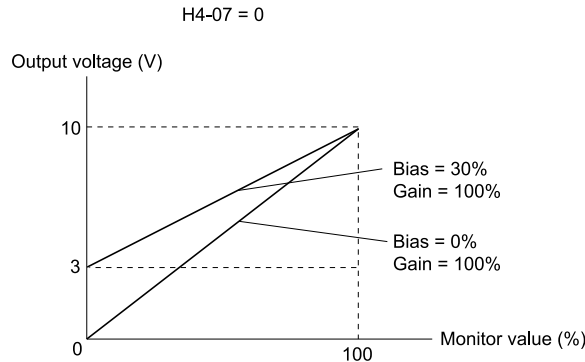

Figure 2.90 Analog Output Gain/Bias Configuration Example 2

Calibrate Terminal AM

Stop the drive to calibrate meters. Use this procedure to calibrate:

1. Show *H4-02 [Terminal AM Analog Output Gain]* on the keypad. Terminal AM outputs the analog signal when the monitor item that you set in *H4-01 [Terminal AM Analog Output Select]* is 100%.
2. Adjust *H4-02* while referencing the meter scale connected to terminal AM.
3. Show *H4-03 [Terminal AM Analog Output Bias]* on the keypad. The analog signal at the time when the monitor item selected with *H4-01* is 0% is output from terminal AM.
4. Adjust *H4-03* while referencing the meter scale connected to terminal AM.

■ H4-01: Terminal AM Analog Output Select

No. (Hex.)	Name	Description	Default (Range)
H4-01 (041D)	Terminal AM Analog Output Select	<input type="checkbox"/> V/f <input type="checkbox"/> OLV <input type="checkbox"/> OLV/PM <input type="checkbox"/> AOLV/PM <input type="checkbox"/> EZOLV Sets the monitoring number to be output from the MFAO terminal AM.	102 (000 - 999)

Set the *x-xx* part of the *Ux-xx [Monitor]*. For example, set *H4-01 = 102* to monitor *U1-02 [Output Frequency]*.

Note:

- You cannot use all of the monitors in all of the control methods.
- When you use the terminal in through mode, set this parameter to *000* or *031*. You can set the terminal AM output level from the PLC through MEMOBUS/Modbus communications or the communication option.

■ H4-02: Terminal AM Analog Output Gain

No. (Hex.)	Name	Description	Default (Range)
H4-02 (041E) RUN	Terminal AM Analog Output Gain	<input type="checkbox"/> V/f <input type="checkbox"/> OLV <input type="checkbox"/> OLV/PM <input type="checkbox"/> AOLV/PM <input type="checkbox"/> EZOLV Sets the gain of the monitor signal that is sent from MFAO terminal AM.	100.0% (-999.9 - +999.9%)

The analog signal output from the AM terminal is a maximum of 10 V (or 20 mA). Use *H4-07 [Terminal AM Signal Level Select]* to set the signal level.

■ H4-03: Terminal AM Analog Output Bias

No. (Hex.)	Name	Description	Default (Range)
H4-03 (041F) RUN	Terminal AM Analog Output Bias	<input type="checkbox"/> V/f <input type="checkbox"/> OLV <input type="checkbox"/> OLV/PM <input type="checkbox"/> AOLV/PM <input type="checkbox"/> EZOLV Sets the bias of the monitor signal that is sent from MFAO terminal AM.	0.0% (-999.9 - +999.9%)

The analog signal output from the AM terminal is a maximum of 10 V (or 20 mA). Use *H4-07 [Terminal AM Signal Level Select]* to set the signal level.

■ H4-07: Terminal AM Signal Level Select

No. (Hex.)	Name	Description	Default (Range)
H4-07 (0423)	Terminal AM Signal Level Select	<div style="display: flex; justify-content: space-between; align-items: center;"> V/f OLV OLV/PM AOLV/PM EZOLV </div> Sets the MFAO terminal AM output signal level.	0 (0, 2)

Note:

Set jumper S5 on the control circuit terminal block accordingly when changing these parameters.

0 : 0-10V

2 : 4 to 20 mA

■ H4-20: Analog Power Monitor 100% Level

No. (Hex.)	Name	Description	Default (Range)
H4-20 (0B53)	Analog Power Monitor 100% Level	<div style="display: flex; justify-content: space-between; align-items: center;"> V/f OLV OLV/PM AOLV/PM EZOLV </div> Sets the level at 10 V when U1-08 [Output Power] is set for analog output.	0.00 kW (0.00 - 650.00 kW)

Note:

• When H4-20 = 0.00 kW, the output power monitor 10 V level = motor rated power (kW). The setting changes when the A1-02 [Control Method Selection] value changes:

– A1-02 = 0 [V/f]: E2-11 [Motor Rated Power]

– A1-02 = 2 [OLV]: E2-11 [Motor Rated Power]

– A1-02 = 5, 6 [OLV/PM, AOLV/PM]: E5-02 [PM Motor Rated Power]

– A1-02 = 8 [EZOLV]: E9-07 [Motor Rated Power]

◆ H5: Memobus/Modbus Communication

H5 parameters configure the drive to use MEMOBUS/Modbus communications.

You can use the MEMOBUS/Modbus protocol over the RS-485 port (terminals D+ and D-) in the drive to use serial communication with programmable controllers (PLC).

■ H5-01: Drive Node Address

No. (Hex.)	Name	Description	Default (Range)
H5-01 (0425)	Drive Node Address	<div style="display: flex; justify-content: space-between; align-items: center;"> V/f OLV OLV/PM AOLV/PM EZOLV </div> Sets the communication slave address for drives.	1FH (0 - FFH)

Note:

- Re-energize the drive or set H5-20 = 1 [Communication Parameters Reload = Reload Now] after you change the parameter setting.
- Setting 0 will not let the drive respond to MEMOBUS/Modbus communications.

To enable the drive to communicate with the controller (master) over MEMOBUS/Modbus communications, you must set the drive with a slave address. Set H5-01 ≠ 0.

Set a node address that is different from the master and other slave devices.

■ H5-02: Communication Speed Selection

No. (Hex.)	Name	Description	Default (Range)
H5-02 (0426)	Communication Speed Selection	<div style="display: flex; justify-content: space-between; align-items: center;"> V/f OLV OLV/PM AOLV/PM EZOLV </div> Sets the communications speed for MEMOBUS/Modbus communications.	3 (0 - 8)

Note:

Re-energize the drive or set H5-20 = 1 [Communication Parameters Reload = Reload Now] after you change the parameter setting.

0 : 1200 bps

1 : 2400 bps

2 : 4800 bps

- 3 : 9600 bps
- 4 : 19.2 kbps
- 5 : 38.4 kbps
- 6 : 57.6 kbps
- 7 : 76.8 kbps
- 8 : 115.2 kbps

■ **H5-03: Communication Parity Selection**

No. (Hex.)	Name	Description	Default (Range)
H5-03 (0427)	Communication Parity Selection	<div style="display: flex; gap: 5px;"> V/f OLV OLV/PM AOLV/PM EZOLV </div> Sets the communications parity used for MEMOBUS/Modbus communications.	0 (0 - 2)

Note:

Re-energize the drive or set $H5-20 = 1$ [*Communication Parameters Reload = Reload Now*] after you change the parameter setting.

- 0 : No parity
- 1 : Even parity
- 2 : Odd parity

■ **H5-04: Communication Error Stop Method**

No. (Hex.)	Name	Description	Default (Range)
H5-04 (0428)	Communication Error Stop Method	<div style="display: flex; gap: 5px;"> V/f OLV OLV/PM AOLV/PM EZOLV </div> Sets the motor Stopping Method when the drive detects <i>CE</i> [<i>MEMOBUS/Modbus Communication Err</i>] issues.	3 (0 - 3)

0 : Ramp to Stop

The drive ramps the motor to stop in the deceleration time. The output terminal set for *Fault* [$H2-01$ to $H2-03 = E$] activates.

1 : Coast to Stop

The output turns off and the motor coasts to stop. The output terminal set for *Fault* [$H2-01$ to $H2-03 = E$] activates.

2 : Fast Stop (Use C1-09)

The drive stops the motor in the deceleration time set in $C1-09$ [*Fast Stop Time*]. The output terminal set for *Fault* [$H2-01$ to $H2-03 = E$] activates.

3 : Alarm Only

The keypad shows *CE* and the drive continues operation. The output terminal set for *Alarm* [$H2-01$ to $H2-03 = 10$] activates.

■ **H5-05: Comm Fault Detection Selection**

No. (Hex.)	Name	Description	Default (Range)
H5-05 (0429)	Comm Fault Detection Selection	<div style="display: flex; gap: 5px;"> V/f OLV OLV/PM AOLV/PM EZOLV </div> Sets the function that detects <i>CE</i> [<i>Modbus Communication Error</i>] issues during MEMOBUS/Modbus communications.	1 (0, 1)

If the drive does not receive data from the master during the time set in $H5-09$ [*CE Detection Time*], it will detect a *CE* error.

0 : Disabled

Does not detect *CE*. The drive continues operation.

1 : Enabled

Detects *CE*. If the drive detects *CE*, it will operate as specified by the setting of $H5-04$ [*Communication Error Stop Method*].

■ H5-06: Drive Transmit Wait Time

No. (Hex.)	Name	Description	Default (Range)
H5-06 (042A)	Drive Transmit Wait Time	V/f OLV OLV/PM AOLV/PM EZOLV Sets the time to wait to send a response message after the drive receives a command message from the master.	5 ms (0 - 65 ms)

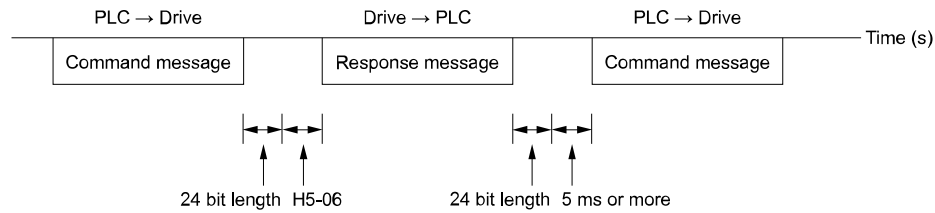

Figure 2.91 Drive Transmit Wait Time

■ H5-09: CE Detection Time

No. (Hex.)	Name	Description	Default (Range)
H5-09 (0435)	CE Detection Time	V/f OLV OLV/PM AOLV/PM EZOLV Sets the detection time for CE [Modbus Communication Error] issues when communication stops.	2.0 s (0.0 - 25.0 s)

■ H5-10: Modbus Register 0025H Unit Sel

No. (Hex.)	Name	Description	Default (Range)
H5-10 (0436)	Modbus Register 0025H Unit Sel	V/f OLV OLV/PM AOLV/PM EZOLV Sets the unit of measure used for the MEMOBUS/Modbus communications monitor register 0025H (output voltage reference monitor).	0 (0, 1)

0 : 0.1 V units

1 : 1 V units

■ H5-11: Comm ENTER Command Mode

No. (Hex.)	Name	Description	Default (Range)
H5-11 (043C) RUN	Comm ENTER Command Mode	V/f OLV OLV/PM AOLV/PM EZOLV Sets the function to make the Enter command necessary to change parameters through MEMOBUS/Modbus communications.	1 (0, 1)

0 : ENTER Command Required

Make all parameter changes then input the Enter command. You must use the Enter command to enable changes to parameters.

1 : ENTER Command Not Required

It is not necessary to input the Enter command to change parameters.

■ H5-12: Run Command Method Selection

No. (Hex.)	Name	Description	Default (Range)
H5-12 (043D)	Run Command Method Selection	V/f OLV OLV/PM AOLV/PM EZOLV Sets the input method for the Run command when $b1-02 = 2$ [Run Command Selection 1 = Memobus/Modbus Communications] or $b1-16 = 2$ [Run Command Selection 2 = Memobus/Modbus Communications].	0 (0, 1)

0 : FWD/Stop, REV/Stop

The drive uses bit 0 in command data 0001H of the MEMOBUS register in the motor forward Run command (bit 0 = 1) and the stop command (bit 0 = 0). The drive uses bit 1 in the motor reverse Run command (bit 1 = 1) and the stop command (bit 1 = 0).

1 : Run/Stop, FWD/REV

The drive uses bit 0 in command data 0001H of the MEMOBUS register in the motor Run command (bit 0 = 1) and the stop command (bit 0 = 0). The drive uses bit 1 in the direction of motor rotation command (Forward run (bit1 = 0) or Reverse run (bit 1 = 1)).

■ H5-17: ENTER command response @CPU BUSY

No. (Hex.)	Name	Description	Default (Range)
H5-17 (11A1) Expert	ENTER command response @CPU BUSY	V/f OLV OLV/PM AOLV/PM EZOLV Sets operation when the EEPROM write command is sent without EEPROM write available. Usually it is not necessary to change this setting.	0 (0, 1)

0 : Ignore Command(No ROM/RAM Write)**1 : Write to RAM Only****■ H5-18: Motor Speed Filter over Comms**

No. (Hex.)	Name	Description	Default (Range)
H5-18 (11A2)	Motor Speed Filter over Comms	V/f OLV OLV/PM AOLV/PM EZOLV Sets the filter time constant used when monitoring motor speed during MEMOBUS/Modbus communications or with a communication option.	0 ms (0 - 100 ms)

Sets the filter time constant when you monitor the output frequency or motor speed during MEMOBUS/Modbus communications or use of the communication option.

These are the MEMOBUS registers:

- 003EH (Output Frequency)
- 003FH (Output Frequency)
- 0044H (U1-05: Motor Speed)
- 00ACH (U1-05: Motor Speed)
- 00ADH (U1-05: Motor Speed)

■ H5-20: Communication Parameters Reload

No. (Hex.)	Name	Description	Default (Range)
H5-20 (0B57)	Communication Parameters Reload	V/f OLV OLV/PM AOLV/PM EZOLV Sets the function to immediately enable updated MEMOBUS/Modbus communications parameters.	0 (0, 1)

0 : Reload at Next Power Cycle**1 : Reload Now****Note:**

- The setting value automatically returns to H5-20 = 0 after you enable MEMOBUS/Modbus communications parameter changes.
- The setting values of these parameters are enabled:
 - H5-01 [Drive Node Address]
 - H5-02 [Communication Speed Selection]
 - H5-03 [Communication Parity Selection]
 - H5-06 [Drive Transmit Wait Time]

■ H5-22: Speed Search from MODBUS

No. (Hex.)	Name	Description	Default (Range)
H5-22 (11CF)	Speed Search from MODBUS	V/f OLV OLV/PM AOLV/PM EZOLV Enables the MEMOBUS/Modbus communication register Speed Search function (bit0 of 15DFH).	0 (0, 1)

0 : Disabled**1 : Enabled**

If you set $H5-22 = 1$ and $H1-xx = 62$ [Speed Search from Fref] at the same time, the drive will detect *oPE03* [Multi-Function Input Setting Err].

■ H5-25: Function 5A Register 1 Selection

No. (Hex.)	Name	Description	Default (Range)
H5-25 (1589) RUN	Function 5A Register 1 Selection	V/f OLV OLV/PM AOLV/PM EZOLV Returns the contents of the specified MEMOBUS/Modbus communications register when responding to the master device.	0044H (U1-05) (0000H - FFFFH)

■ H5-26: Function 5A Register 2 Selection

No. (Hex.)	Name	Description	Default (Range)
H5-26 (158A) RUN	Function 5A Register 2 Selection	V/f OLV OLV/PM AOLV/PM EZOLV Returns the contents of the specified MEMOBUS/Modbus communications register when responding to the master device.	0045H (U1-06) (0000H - FFFFH)

■ H5-27: Function 5A Register 3 Selection

No. (Hex.)	Name	Description	Default (Range)
H5-27 (158B) RUN	Function 5A Register 3 Selection	V/f OLV OLV/PM AOLV/PM EZOLV Returns the contents of the specified MEMOBUS/Modbus communications register when responding to the master device.	0042H (U1-03) (0000H - FFFFH)

■ H5-28: Function 5A Register 4 Selection

No. (Hex.)	Name	Description	Default (Range)
H5-28 (158C) RUN	Function 5A Register 4 Selection	V/f OLV OLV/PM AOLV/PM EZOLV Returns the contents of the specified MEMOBUS/Modbus communications register when responding to the master device.	0049H (U1-10) (0000H - FFFFH)

◆ H6: Pulse Train Input/Output

H6 parameters set the drive pulse train input and pulse train monitor. These parameters select input and monitor parameters and adjust the pulse train frequency.

A pulse train signal with a maximum single pulse of 32 kHz can be input to the drive input terminal RP. You can use the pulse train signal as the frequency reference, PID feedback value, and speed feedback for V/f Control mode.

A pulse train signal with a maximum frequency of 32 kHz can be output from the drive output terminal MP as the monitor value. Sinking mode and sourcing mode are supported.

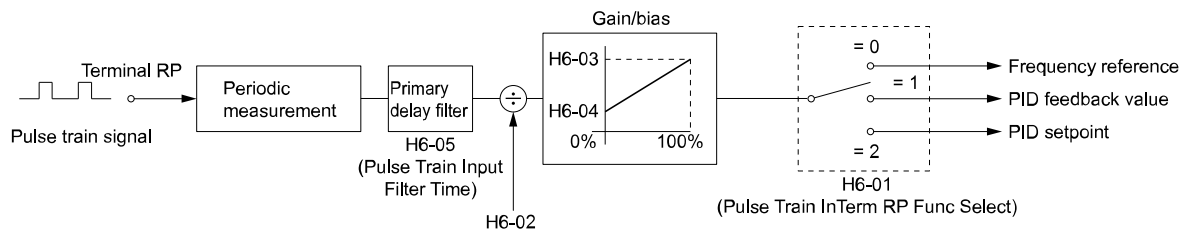

Figure 2.92 Pulse Train Input Block Diagram

■ H6-01: Terminal RP Pulse Train Function

No. (Hex.)	Name	Description	Default (Range)
H6-01 (042C)	Terminal RP Pulse Train Function	V/f OLV OLV/PM AOLV/PM EZOLV Sets the function for pulse train input terminal RP.	0 (0 - 3)

0 : Frequency Reference

When $b1-01 = 4$ [Frequency Reference Selection 1 = Pulse Train Input] or $b1-15 = 4$ [Frequency Reference Selection 2 = Pulse Train Input], the drive inputs the frequency reference received from terminal RP.

1 : PID Feedback Value

The drive inputs the PID control feedback value received from terminal RP.

2 : PID Setpoint Value

The drive inputs the PID control target value received from terminal RP.

3 : Speed Feedback (V/f Control)

Select V/f Control method to enable simple encoder feedback.

Use motor speed feedback for better speed control precision. The drive compares the frequency reference to the motor speed feedback received from the encoder, and uses the ASR function to compensate for motor slip. You cannot use input terminal RP used for the simple encoder to detect the direction of motor rotation. Use a different method to detect motor rotation.

Use these methods to detect the direction of motor rotation.

- Use MFDI
Set MFDI $H1-xx = 7E$ [Reverse Rotation Identifier]. When the configured terminal is activated, the motor operates in Reverse run. When the terminal is deactivated, the motor operates in Forward run.
Use an encoder that outputs 2-tracks (phase A, B) to detect the direction of motor rotation.
- Use the frequency reference
When you do not use the MFDI, the Forward/Reverse run command is the same as the direction of motor rotation.

Figure 2.93 shows speed control in Simple Closed Loop V/f Mode.

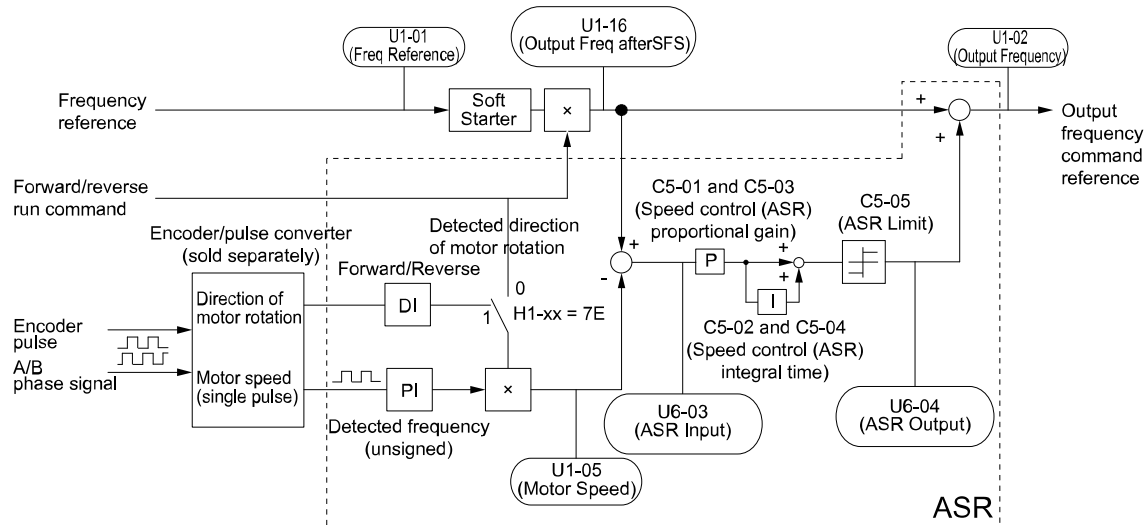

Figure 2.93 Simple Closed Loop Speed Control Block Diagram

Enable Simple Closed Loop V/f Mode

1. Connect the encoder output pulse wiring to terminal RP.
2. Set $A1-02 = 0$ [Control Method Selection = V/f Control].
3. Set $H6-01 = 3$.
4. Set $H6-02$ [Terminal RP Frequency Scaling] to the speed feedback (pulse train input signal) frequency at the time when the frequency reference is 100%.
Make sure that $H6-04$ [Terminal RP Function Bias] = 0% and $H6-03$ [Terminal RP Function Gain] = 100%.
5. Select the detection method for the direction of motor rotation.
When you use an MFDI, set $H1-xx = 7E$.
6. Set $C5$ parameters related to ASR gain and integral time to adjust responsiveness.

Note:

- Set $A1-02 = 0$ and $H6-01 = 3$ to show $C5$ parameters.
- You cannot use Simple Closed Loop V/f Mode with the Motor Switch function.

■ H6-02: Terminal RP Frequency Scaling

No. (Hex.)	Name	Description	Default (Range)
H6-02 (042D) RUN	Terminal RP Frequency Scaling	<p>V/f OLV OLV/PM AOLV/PM EZOLV</p> <p>Sets the frequency of the pulse train input signal used when the item selected with H6-01 [Terminal RP Pulse Train Function] is input at 100%.</p>	1440 Hz (100 - 32000 Hz)

■ H6-03: Terminal RP Function Gain

No. (Hex.)	Name	Description	Default (Range)
H6-03 (042E) RUN	Terminal RP Function Gain	<p>V/f OLV OLV/PM AOLV/PM EZOLV</p> <p>Sets the gain used when the function in H6-01 [Terminal RP Pulse Train Function] is input to terminal RP.</p>	100.0% (0.0 - 1000.0%)

■ H6-04: Terminal RP Function Bias

No. (Hex.)	Name	Description	Default (Range)
H6-04 (042F) RUN	Terminal RP Function Bias	<p>V/f OLV OLV/PM AOLV/PM EZOLV</p> <p>Sets the bias used when the function in H6-01 [Terminal RP Pulse Train Function] is input to terminal RP. Sets a value at the time when the pulse train is 0 Hz.</p>	0.0% (-100.0 - 100.0%)

■ H6-05: Terminal RP Filter Time

No. (Hex.)	Name	Description	Default (Range)
H6-05 (0430) RUN	Terminal RP Filter Time	<p>V/f OLV OLV/PM AOLV/PM EZOLV</p> <p>Sets the time constant for the pulse train input primary delay filters.</p>	0.10 s (0.00 - 2.00 s)

■ H6-06: Terminal MP Monitor Selection

No. (Hex.)	Name	Description	Default (Range)
H6-06 (0431) RUN	Terminal MP Monitor Selection	<p>V/f OLV OLV/PM AOLV/PM EZOLV</p> <p>Sets a function for pulse train monitor output terminal MP. Sets the "x-xx" part of the Ux-xx monitor.</p>	102 (000, 031, 101, 102, 105, 116, 501, 502, 801 - 809, 821 - 825, 831 - 839, 851 - 855)

Note:

To use in through mode or when terminal MP is not used, set this parameter to 000 or 031.

When you use the pulse train monitor, make sure that you connect peripheral devices as specified by these load conditions:

Incorrect connections can make the characteristics not sufficient or cause mechanical damage.

- Use the pulse train monitor as the sourcing output.

Output Voltage VRL(V)	Load Impedance (kΩ)
5 V or more	1.5 kΩ or more
8 V or more	4.0 kΩ or more
10 V or more	10 kΩ or more

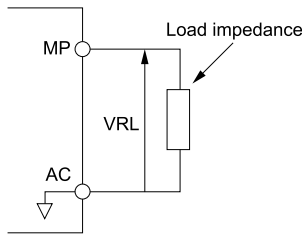

Figure 2.94 Circuit Diagram When Used as the Sourcing Output

- Use the pulse train monitor as the sinking input

External Power Supply (V)	12 VDC ± 10%, 15 VDC ± 10%
Sinking current (mA)	16 mA or less

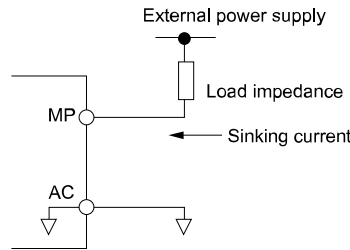

Figure 2.95 Circuit Diagram When Used as the Sinking Input

■ H6-07: Terminal MP Frequency Scaling

No. (Hex.)	Name	Description	Default (Range)
H6-07 (0432) RUN	Terminal MP Frequency Scaling	<input type="checkbox"/> V/f <input type="checkbox"/> OLV <input type="checkbox"/> OLV/PM <input type="checkbox"/> AOLV/PM <input type="checkbox"/> EZOLV Sets the frequency of the pulse train output signal used when the monitor set with H6-06 [Terminal MP Monitor Selection] is 100%.	1440 Hz (0 - 32000 Hz)

When H6-06 = 102 [Terminal MP Monitor Selection = Output Frequency] and H6-07 = 0, the pulse train output terminal MP outputs the same frequency as the drive output frequency.

■ H6-08: Terminal RP Minimum Frequency

No. (Hex.)	Name	Description	Default (Range)
H6-08 (043F)	Terminal RP Minimum Frequency	<input type="checkbox"/> V/f <input type="checkbox"/> OLV <input type="checkbox"/> OLV/PM <input type="checkbox"/> AOLV/PM <input type="checkbox"/> EZOLV Sets the minimum frequency of the pulse train signal that terminal RP can detect.	0.5 Hz (0.1 - 1000.0 Hz)

- When you input a pulse train frequency that is less than the value of H6-08, the pulse train input is 0.0 Hz.
- Set H6-01 = 0, 1, or 2 [Terminal RP Pulse Train Function = Frequency Reference, PID Feedback Value, or PID Setpoint Value] to enable this parameter.
- When H6-01 = 3 [Speed Feedback (V/F Control)], the drive applies the setting of F1-14 [Encoder Open-Circuit Detect Time] to the minimum frequency.

◆ H7: Virtual MFIO Selection

The virtual I/O function performs the following.

- Inputs the result of the output from the MFDO terminal to the MFDI terminal without external wiring.
- Inputs the result of the output from the MFAO terminal to the MFAI terminal without external wiring.

WARNING! Sudden Movement Hazard. Before you do a test run, make sure that the setting values for virtual input and output function parameters are correct. Virtual input and output functions can have different default settings and operation than wired input and output functions. Incorrect function settings can cause serious injury or death.

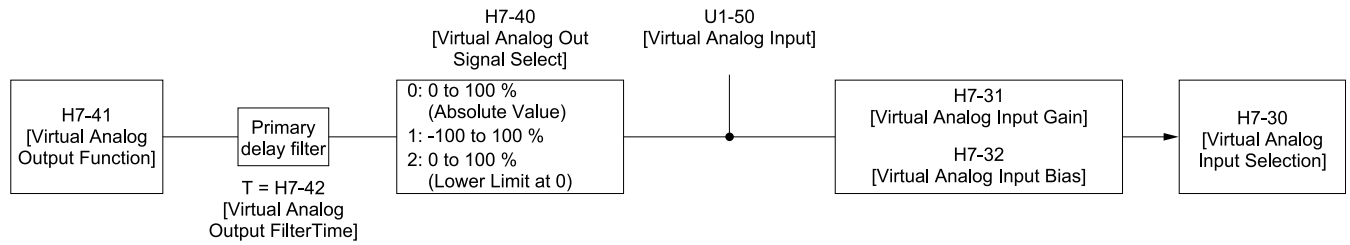

Figure 2.96 Virtual Analog I/O Functional Block Diagram

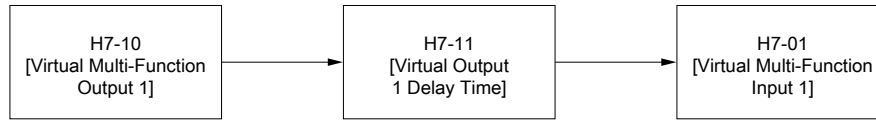

Figure 2.97 Virtual Digital I/O Functional Block Diagram

Note:

- Refer to *H1: Digital Inputs on page 287* for more information on the virtual digital input functions.
- Refer to *H2: Digital Outputs on page 309* for more information on the virtual digital output functions.
- Refer to *H3: Analog Inputs on page 332* for more information on the virtual analog input functions.
- Refer to *H4: Analog Outputs on page 343* for more information on the virtual analog output functions.
- You cannot set 0 [3-Wire Sequence] and 20 or 2F [External Fault] to H7-01 to H7-04 [Virtual Multi-Function Input 1 to 4].
- If you do not use virtual I/O, set H7-01 to H7-04 = F. This does not support the through mode.

■ **H7-00: Virtual MFIO selection**

No. (Hex.)	Name	Description	Default (Range)
H7-00 (116F) Expert	Virtual MFIO selection	<div style="display: flex; gap: 5px;"> V/f OLV OLV/PM AOLV/PM EZOLV </div> <p>Sets the function to enable and disable the virtual I/O function. Set this parameter to 1 to operate the virtual I/O function.</p>	0 (0, 1)

0 : Disabled

1 : Enabled

■ **H7-01: Virtual Multi-Function Input 1**

No. (Hex.)	Name	Description	Default (Range)
H7-01 (1185) Expert	Virtual Multi-Function Input 1	<div style="display: flex; gap: 5px;"> V/f OLV OLV/PM AOLV/PM EZOLV </div> <p>Sets the function that enters the virtual input set in H7-10 [Virtual Multi-Function Output 1].</p>	F (1 - 19F)

Note:

1B [Programming Lockout] and 11B [Inverse Input of 1B] are not available.

■ **H7-02: Virtual Multi-Function Input 2**

No. (Hex.)	Name	Description	Default (Range)
H7-02 (1186) Expert	Virtual Multi-Function Input 2	<div style="display: flex; gap: 5px;"> V/f OLV OLV/PM AOLV/PM EZOLV </div> <p>Sets the function that enters the virtual input set in H7-12 [Virtual Multi-Function Output 2].</p>	F (1 - 19F)

Note:

1B [Programming Lockout] and 11B [Inverse Input of 1B] are not available.

■ H7-03: Virtual Multi-Function Input 3

No. (Hex.)	Name	Description	Default (Range)
H7-03 (1187) Expert	Virtual Multi-Function Input 3	<input type="checkbox"/> V/f <input type="checkbox"/> OLV <input type="checkbox"/> OLV/PM <input type="checkbox"/> AOLV/PM <input type="checkbox"/> EZOLV Sets the function that enters the virtual input set in H7-14 [Virtual Multi-Function Output 3].	F (1 - 19F)

Note:

1B [Programming Lockout] and 11B [Inverse Input of 1B] are not available.

■ H7-04: Virtual Multi-Function Input 4

No. (Hex.)	Name	Description	Default (Range)
H7-04 (1188) Expert	Virtual Multi-Function Input 4	<input type="checkbox"/> V/f <input type="checkbox"/> OLV <input type="checkbox"/> OLV/PM <input type="checkbox"/> AOLV/PM <input type="checkbox"/> EZOLV Sets the function that enters the virtual input set in H7-16 [Virtual Multi-Function Output 4].	F (1 - 19F)

Note:

1B [Programming Lockout] and 11B [Inverse Input of 1B] are not available.

■ H7-10: Virtual Multi-Function Output 1

No. (Hex.)	Name	Description	Default (Range)
H7-10 (11A4) Expert	Virtual Multi-Function Output 1	<input type="checkbox"/> V/f <input type="checkbox"/> OLV <input type="checkbox"/> OLV/PM <input type="checkbox"/> AOLV/PM <input type="checkbox"/> EZOLV Sets the function for virtual digital output 1.	F (0 - 1A7)

■ H7-11: Virtual Output 1 Delay Time

No. (Hex.)	Name	Description	Default (Range)
H7-11 (11A5) Expert	Virtual Output 1 Delay Time	<input type="checkbox"/> V/f <input type="checkbox"/> OLV <input type="checkbox"/> OLV/PM <input type="checkbox"/> AOLV/PM <input type="checkbox"/> EZOLV Sets the minimum ON time for virtual digital output 1.	0.1 s (0.0 - 25.0 s)

■ H7-12: Virtual Multi-Function Output 2

No. (Hex.)	Name	Description	Default (Range)
H7-12 (11A6) Expert	Virtual Multi-Function Output 2	<input type="checkbox"/> V/f <input type="checkbox"/> OLV <input type="checkbox"/> OLV/PM <input type="checkbox"/> AOLV/PM <input type="checkbox"/> EZOLV Sets the function for virtual digital output 2.	F (0 - 1A7)

■ H7-13: Virtual Output 2 Delay Time

No. (Hex.)	Name	Description	Default (Range)
H7-13 (11A7) Expert	Virtual Output 2 Delay Time	<input type="checkbox"/> V/f <input type="checkbox"/> OLV <input type="checkbox"/> OLV/PM <input type="checkbox"/> AOLV/PM <input type="checkbox"/> EZOLV Sets the minimum ON time for virtual digital output 2.	0.1 s (0.0 - 25.0 s)

■ H7-14: Virtual Multi-Function Output 3

No. (Hex.)	Name	Description	Default (Range)
H7-14 (11A8) Expert	Virtual Multi-Function Output 3	<input type="checkbox"/> V/f <input type="checkbox"/> OLV <input type="checkbox"/> OLV/PM <input type="checkbox"/> AOLV/PM <input type="checkbox"/> EZOLV Sets the function for virtual digital output 3.	F (0 - 1A7)

■ H7-15: Virtual Output 3 Delay Time

No. (Hex.)	Name	Description	Default (Range)
H7-15 (11A9) Expert	Virtual Output 3 Delay Time	<div style="display: flex; gap: 5px;"> V/f OLV OLV/PM AOLV/PM EZOLV </div> Sets the minimum ON time for virtual digital output 3.	0.1 s (0.0 - 25.0 s)

■ H7-16: Virtual Multi-Function Output 4

No. (Hex.)	Name	Description	Default (Range)
H7-16 (11AA) Expert	Virtual Multi-Function Output 4	<div style="display: flex; gap: 5px;"> V/f OLV OLV/PM AOLV/PM EZOLV </div> Sets the function for virtual digital output 4.	F (0 - 1A7)

■ H7-17: Virtual Output 4 Delay Time

No. (Hex.)	Name	Description	Default (Range)
H7-17 (11AB) Expert	Virtual Output 4 Delay Time	<div style="display: flex; gap: 5px;"> V/f OLV OLV/PM AOLV/PM EZOLV </div> Sets the minimum ON time for virtual digital output 4.	0.1 s (0.0 - 25.0 s)

■ H7-30: Virtual Analog Input Selection

No. (Hex.)	Name	Description	Default (Range)
H7-30 (1177) Expert	Virtual Analog Input Selection	<div style="display: flex; gap: 5px;"> V/f OLV OLV/PM AOLV/PM EZOLV </div> Sets the virtual analog input function.	F (0 - 32)

■ H7-31: Virtual Analog Input Gain

No. (Hex.)	Name	Description	Default (Range)
H7-31 (1178) RUN Expert	Virtual Analog Input Gain	<div style="display: flex; gap: 5px;"> V/f OLV OLV/PM AOLV/PM EZOLV </div> Sets the virtual analog input gain.	100.0% (-999.9 - 999.9%)

■ H7-32: Virtual Analog Input Bias

No. (Hex.)	Name	Description	Default (Range)
H7-32 (1179) RUN Expert	Virtual Analog Input Bias	<div style="display: flex; gap: 5px;"> V/f OLV OLV/PM AOLV/PM EZOLV </div> Sets the virtual analog input bias.	0.0% (-999.9 - 999.9%)

■ H7-40: Virtual Analog Out Signal Select

No. (Hex.)	Name	Description	Default (Range)
H7-40 (1163)	Virtual Analog Out Signal Select	<div style="display: flex; gap: 5px;"> V/f OLV OLV/PM AOLV/PM EZOLV </div> Sets the signal level of the virtual analog output.	0 (0 - 2)

0 : 0 to 100% (Absolute Value)

1 : -100 to 100%

2 : 0 to 100% (Lower Limit at 0)

■ H7-41: Virtual Analog Output Function

No. (Hex.)	Name	Description	Default (Range)
H7-41 (1164)	Virtual Analog Output Function	<input type="checkbox"/> V/f <input type="checkbox"/> OLV <input type="checkbox"/> OLV/PM <input type="checkbox"/> AOLV/PM <input type="checkbox"/> EZOLV Sets the monitor to be output from the virtual analog output.	102 (0 - 999)

Set the $x-xx$ part of the $Ux-xx$ [Monitor]. For example, set $H7-41 = 102$ to monitor $U1-02$ [Output Frequency].

■ H7-42: Virtual Analog Output FilterTime

No. (Hex.)	Name	Description	Default (Range)
H7-42 (1165)	Virtual Analog Output FilterTime	<input type="checkbox"/> V/f <input type="checkbox"/> OLV <input type="checkbox"/> OLV/PM <input type="checkbox"/> AOLV/PM <input type="checkbox"/> EZOLV Sets the time constant for a primary filter of the virtual analog output.	0.00 s (0.00 - 2.00 s)

2.9 L: Protection Functions

L parameters set the following functions.

- Motor Overload Protection
- Operation During Momentary Power Loss
- Stall Prevention
- Speed Detection
- Auto Restart
- Detection of Overtorque/Undertorque
- Torque Limit
- Hardware Protection

◆ L1: Motor Protection

L1 parameters set the motor overload protection function.

■ Motor Protection Using Positive Temperature Coefficient (PTC) Thermistors

Connect the PTC thermistor input from the motor to analog input terminal on the drive.

The temperature resistance characteristics of three PTC thermistors in the motor stator winding protect the motor from overheating.

A PTC thermistor must have the characteristics shown in [Figure 2.98](#) for each motor phase.

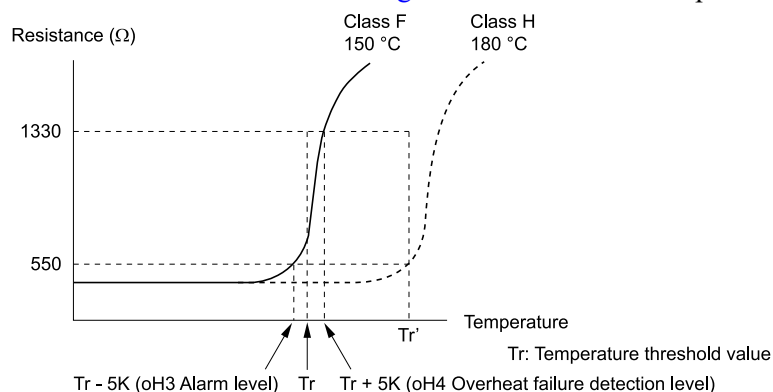

Figure 2.98 PTC Thermistor Temperature and Resistance

If the PTC input signal input to the drive is more than the overload alarm level, the drive detects *oH3* [*Motor Overheat (PTC Input)*]. The drive continues the operation set in *L1-03* [*Motor Thermistor oH Alarm Select*]. By default, the keypad shows *oH3* and the drive continues operation.

The overheat fault level triggers an *oH4* [*Motor Overheat Fault (PTC Input)*] fault, and outputs a fault signal. The drive outputs a fault signal and uses the stop method set in *L1-04* [*Motor Thermistor oH Fault Select*] to stop the motor.

Note:

PTC is an acronym for Positive Temperature Coefficient.

The following shows the configuration procedure when you use terminal A2.

1. Connect the PTC thermistor input from the motor to analog input terminal A2 on the drive.

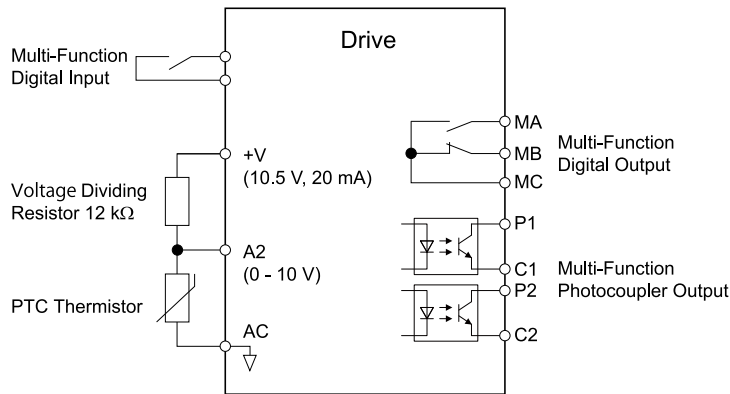

Figure 2.99 Connect Motor to PTC Thermistor Input

2. Set drive DIP switch S1 to V (voltage).

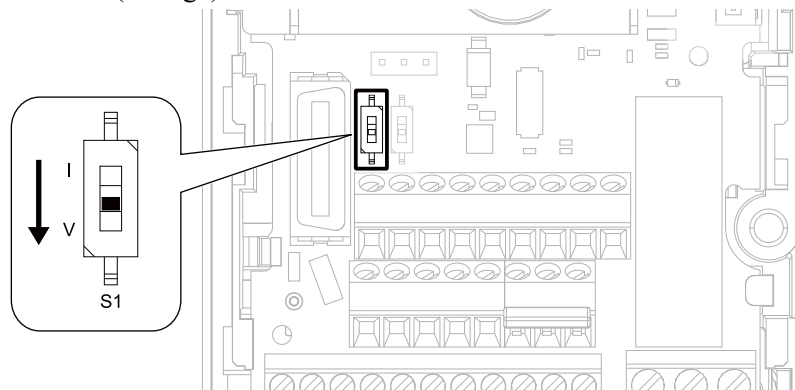

Figure 2.100 Settings for DIP Switches

3. Set these MFAI terminals:

- H3-09 = 0 [Terminal A2 Signal Level Select = 0-10V (LowLim=0)].
- H3-10 = E [Terminal A2 Function Selection = Motor Temperature (PTC input)].

4. Set these L1 parameters:

- L1-03 [Motor Thermistor oH Alarm Select]
- L1-04 [Motor Thermistor oH Fault Select]
- L1-05 [Motor Thermistor Filter Time]

■ **L1-01: Motor Overload (oL1) Protection**

No. (Hex.)	Name	Description	Default (Range)
L1-01 (0480)	Motor Overload (oL1) Protection	V/f OLV OLV/PM AOLV/PM EZOLV Sets the motor overload protection with electronic thermal protectors.	Determined by A1-02 (0 - 6)

This parameter enables and disables the motor overload protection with electronic thermal protectors.

The cooling capability of the motor changes when the speed control range of the motor changes. Use an electronic thermal protector that aligns with the permitted load characteristics of the motor to select motor protection.

The electronic thermal protector of the drive uses these items to calculate motor overload tolerance and supply overload protection for the motor:

- Output current
- Output frequency
- Motor thermal characteristics
- Time characteristics

If the drive detects motor overload, the drive will trigger an oL1 [Motor Overload] and stop drive output.

Set $H2-01 = 1F$ [Term MA/MB-MC Function Selection = Motor Overload Alarm (oL1)] to set a motor overload alarm. If the motor overload level is more than 90% of the oLI detection level, the output terminal activates and triggers an overload alarm.

0 : Disabled

Disable motor protection when motor overload protection is not necessary or when the drive is operating more than one motor.

Refer to [Figure 2.101](#) for an example of the circuit configuration to connect more than one motor to one drive.

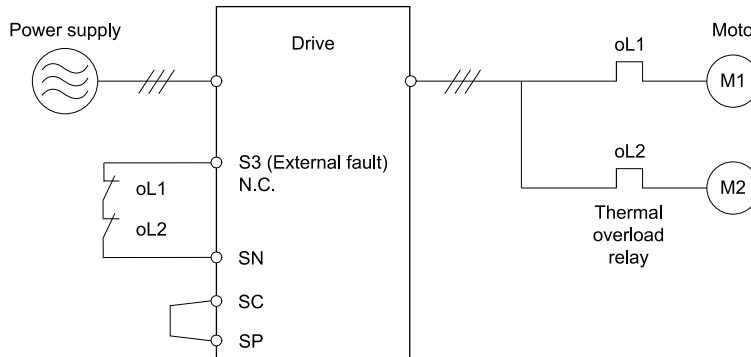

Figure 2.101 Protection Circuit Configuration to Connect More than One Motor to One Drive

NOTICE: When you connect more than one motor to one drive or when the motor amp rating is higher than the drive amp rating, set $L1-01 = 0$ [Motor Overload (oL1) Protection = Disabled] and install thermal overload relays for each motor. The electronic thermal protection of the drive will not function and it can cause damage to the motor.

1 : Variable Torque

Use this setting for general-purpose motors with a 60 Hz base frequency.

The overload tolerance decreases as motor speed decreases because the cooling fan speed decreases and the ability of the motor to cool decreases in the low speed range.

The overload tolerance characteristics of the motor change the trigger point for the electronic thermal protector. This provides motor overheat protection from low speed to high speed across the full speed range.

Load Tolerance	Cooling Capability	Overload Characteristics (at 100% motor load)
	<p>This motor is designed to operate with commercial line power. Operate at a 60 Hz base frequency to maximize the motor cooling ability.</p>	<p>If the motor operates at frequencies less than 60 Hz, the drive will detect oLI. The drive triggers a fault relay output and the motor coasts to stop.</p>

2 : Constant Torque 10:1 Speed Range

Use this setting for drive-dedicated motors with a speed range for constant torque of 1:10.

The speed control for this motor is 10% to 100% when at 100% load. Operating slower than 10% speed at 100% load will cause motor overload.

Parameter Details

2

2.9 L: Protection Functions

Load Tolerance	Cooling Capability	Overload Characteristics (at 100% motor load)
	<p>This motor is designed to withstand increased temperatures during continuous operation in the low speed range (10% base frequency).</p>	<p>The motor operates continuously at 10% to 100% base frequency. Operating slower than 10% speed at 100% load will cause motor overload.</p>

3 : Constant Torque 100:1 SpeedRange

Use this setting for vector motors with a speed range for constant torque of 1:100.

The speed control for this motor is 1% to 100% when at 100% load. Operating slower than 1% speed at 100% load will cause motor overload.

Load Tolerance	Cooling Capability	Overload Characteristics (at 100% motor load)
	<p>This motor is designed to withstand increased temperatures during continuous operation in the low speed range (1% base frequency).</p>	<p>The motor operates continuously at 1% to 100% base frequency. Operating slower than 1% speed at 100% load will cause motor overload.</p>

4 : PM Variable Torque

Use this setting for PM motors with derated torque characteristics.

The overload tolerance decreases as motor speed decreases because the cooling fan speed decreases and the ability of the motor to cool decreases in the low speed range.

The overload tolerance characteristics of the motor change the trigger point for the electronic thermal protector. This provides motor overheat protection from low speed to high speed across the full speed range.

Load Tolerance	Cooling Capability	Overload Characteristics (at 100% motor load)
	<p>This motor is designed to withstand increased temperatures during continuous operation at rated speed and rated torque.</p>	<p>If the motor operates continuously at lower speed than rated rotation speed at more than 100% torque, the drive will detect <i>oL1</i>. The drive triggers a fault relay output and the motor coasts to stop.</p>

5 : PM Constant Torque

Use this setting with a PM motor for constant torque that has a speed range for constant torque of 1:500.

The speed control for this motor is 0.2% to 100% when at 100% load. Operating slower than 0.2% speed at 100% load will cause motor overload.

Load Tolerance	Cooling Capability	Overload Characteristics (at 100% motor load)
	<p>This motor is designed to withstand increased temperatures during continuous operation in the low speed range (0.2% base frequency).</p>	<p>The motor operates continuously at 0.2% to 100% rated speed. Operating slower than 0.2% speed at 100% load will cause motor overload.</p>

6 : Variable Torque (50Hz)

Use this setting for general-purpose motors with a 50 Hz base frequency.

The overload tolerance decreases as motor speed decreases because the cooling fan speed decreases and the ability of the motor to cool decreases in the low speed range.

The overload tolerance characteristics of the motor change the trigger point for the electronic thermal protector. This provides motor overheat protection from low speed to high speed across the full speed range.

Load Tolerance	Cooling Capability	Overload Characteristics (at 100% motor load)
	<p>This motor is designed to operate with commercial line power. Operate at a 50 Hz base frequency to maximize the motor cooling ability.</p>	<p>If the motor operates at frequencies less than commercial line power, the drive will detect <i>oLl</i>. The drive triggers a fault relay output and the motor coasts to stop.</p>

■ L1-02: Motor Overload Protection Time

No. (Hex.)	Name	Description	Default (Range)
L1-02 (0481)	Motor Overload Protection Time	V/f OLV OLV/PM AOLV/PM EZOLV <p>Sets the operation time for the electronic thermal protector of the drive to prevent damage to the motor. Usually it is not necessary to change this setting.</p>	1.0 min (0.1 - 5.0 min)

Set the overload tolerance time to the length of time that the motor can operate at 150% load from continuous operation at 100% load.

When the motor operates at 150% load continuously for one minute after continuous operation at 100% load (hot start), the default setting triggers the electronic thermal protector.

Figure 2.102 shows an example of the electronic thermal protector operation time. Motor overload protection operates in the range between a cold start and a hot start.

This example shows a general-purpose motor operating at the base frequency with L1-02 set to 1.0 min.

- Cold start
Shows the motor protection operation time characteristics when the overload occurs immediately after starting operation from a complete stop.
- Hot start
Shows the motor protection operation time characteristics when overload occurs from continuous operation below the motor rated current.

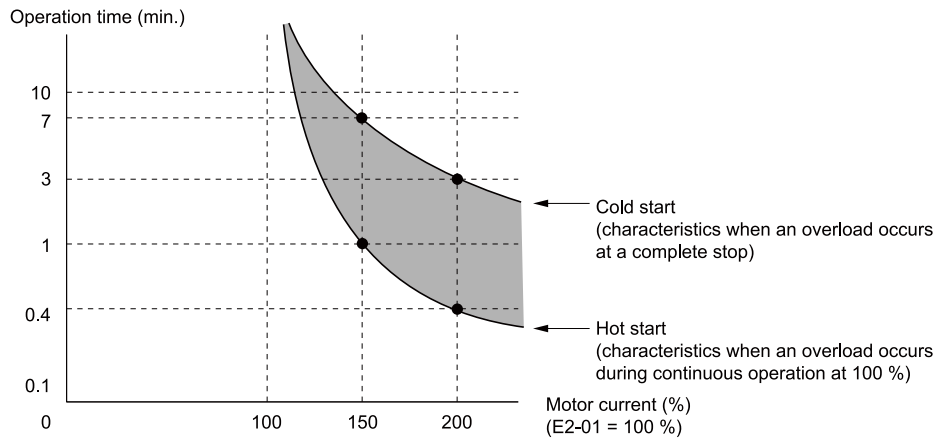

Figure 2.102 Protection Operation Time for a General-purpose Motor at Rated Output Frequency

■ L1-03: Motor Thermistor oH Alarm Select

No. (Hex.)	Name	Description	Default (Range)
L1-03 (0482)	Motor Thermistor oH Alarm Select	V/f OLV OLV/PM AOLV/PM EZOLV Sets drive operation when the PTC input signal entered into the drive is at the oH3 [Motor Overheat Alarm] detection level.	3 (0 - 3)

0 : Ramp to Stop

The drive ramps the motor to stop in the deceleration time. The output terminal set for *Fault* [H2-01 to H2-03 = E] activates.

1 : Coast to Stop

The output turns off and the motor coasts to stop. The output terminal set for *Fault* [H2-01 to H2-03 = E] activates.

2 : Fast Stop

The drive stops the motor in the deceleration time set in C1-09 [Fast Stop Time]. The output terminal set for *Fault* [H2-01 to H2-03 = E] activates.

3 : Alarm Only

The keypad shows oH3 and the drive continues operation. The output terminal set for *Alarm* [H2-01 to H2-03 = 10] activates.

■ L1-04: Motor Thermistor oH Fault Select

No. (Hex.)	Name	Description	Default (Range)
L1-04 (0483)	Motor Thermistor oH Fault Select	V/f OLV OLV/PM AOLV/PM EZOLV Sets the drive operation when the PTC input signal to the drive is at the oH4 [Motor Overheat Fault (PTC Input)] detection level.	1 (0 - 2)

0 : Ramp to Stop

The drive ramps the motor to stop in the deceleration time. The output terminal set for *Fault* [H2-01 to H2-03 = E] activates.

1 : Coast to Stop

The output turns off and the motor coasts to stop. The output terminal set for *Fault* [H2-01 to H2-03 = E] activates.

2 : Fast Stop

The drive stops the motor in the deceleration time set in C1-09 [Fast Stop Time]. The output terminal set for *Fault* [H2-01 to H2-03 = E] activates.

■ L1-05: Motor Thermistor Filter Time

No. (Hex.)	Name	Description	Default (Range)
L1-05 (0484)	Motor Thermistor Filter Time	<div style="display: flex; justify-content: space-between; align-items: center;"> V/f OLV OLV/PM AOLV/PM EZOLV </div> Sets the primary delay time constant for the PTC input signal entered to the drive. This parameter prevents accidental motor overheat faults.	0.20 s (0.00 - 10.00 s)

■ L1-08: oL1 Current Level

No. (Hex.)	Name	Description	Default (Range)
L1-08 (1103)	oL1 Current Level	<div style="display: flex; justify-content: space-between; align-items: center;"> V/f OLV OLV/PM AOLV/PM EZOLV </div> Sets the reference current for the motor 1 thermal overload detection. When the current level > 0.0 A, you cannot set this value < 10% of drive rated current.	0.0 A (0.0 A or 10% to 150% of the drive rated current)

When $L1-08 = 0.0 A$, the drive uses *E2-01 [Motor Rated Current (FLA)]* to detect the motor overload protection. In PM control mode, the drive uses *E5-03 [PM Motor Rated Current (FLA)]* to detect the motor overload protection. When $L1-08 \neq 0.0 A$, the set value is the reference for motor overload protection.

Note:

- Display is in these units:
 - 0.01 A: B001 to B018, 2001 to 2042, 4001 to 4023
 - 0.1 A: 2056 to 2082, 4031 to 4060
- When the current level > 0.0 A, you cannot set this value < 10% of drive rated current.

■ L1-09: oL1 Current Level for Motor 2

No. (Hex.)	Name	Description	Default (Range)
L1-09 (1104)	oL1 Current Level for Motor 2	<div style="display: flex; justify-content: space-between; align-items: center;"> V/f OLV OLV/PM AOLV/PM EZOLV </div> Sets the reference current for the motor 2 thermal overload detection. When the current level > 0.0 A, you cannot set this value < 10% of drive rated current.	0.0 A (0.0 A or 10 to 150% of the drive rated current)

When $L1-09 = 0.0 A$, the drive uses *E4-01 [Motor 2 Rated Current]* to detect the motor overload protection. When $L1-09 \neq 0.0 A$, the set value is the reference for motor overload protection.

Note:

- Display is in these units:
 - 0.01 A: B001 to B018, 2001 to 2042, 4001 to 4023
 - 0.1 A: 2056 to 2082, 4031 to 4060
- When the current level > 0.0 A, you cannot set this value < 10% of drive rated current.

■ L1-13: Motor Overload Memory Selection

No. (Hex.)	Name	Description	Default (Range)
L1-13 (046D)	Motor Overload Memory Selection	<div style="display: flex; justify-content: space-between; align-items: center;"> V/f OLV OLV/PM AOLV/PM EZOLV </div> Sets the function that keeps the current electronic thermal protector value when the drive stops receiving power.	1 (0, 1)

0 : Disabled

1 : Enabled

Sets if the drive will calculate the motor again when the drive is energized again.

■ L1-22: Leakage Current Filter Time1

No. (Hex.)	Name	Description	Default (Range)
L1-22 (0768) RUN	Leakage Current Filter Time1	<div style="display: flex; justify-content: space-between; align-items: center;"> V/f OLV OLV/PM AOLV/PM EZOLV </div> Sets the leakage current detection reduction filter time constant during constant speed run.	Determined by C6-02 (0.0 - 60.0 s)

Note:

You can set this parameter when $C6-02 = B$ [Carrier Frequency Selection = Leakage Current Detection Reduction Rate PWM].

If incorrect detection of alarms, for example *oL1* [Motor Overload], occur or errors occur in the values on the current monitor because of a leakage current, increase the setting value.

■ **L1-23: Leakage Current Filter Time2**

No. (Hex.)	Name	Description	Default (Range)
L1-23 (0769) RUN	Leakage Current Filter Time2	<div style="display: flex; gap: 5px;"> V/f OLV OLV/PM AOLV/PM EZOLV </div> Sets the leakage current detection reduction filter time constant during acceleration/deceleration.	Determined by C6-02 (0.0 - 60.0 s)

Note:

- You can set this parameter when $C6-02 = B$ [Carrier Frequency Selection = Leakage Current Detection Reduction Rate PWM].
- When the setting value increases, the current monitor will start up slowly. Examine the relevant sequence for problems.

If errors occur in the values on the current monitor during acceleration/deceleration, increase the setting value.

◆ **L2: Power Loss Ride Through**

L2 parameters set the drive operation during momentary power loss and the KEB Ride-Thru function method of operation.

■ **KEB Ride-Thru Function**

KEB is an acronym for Kinetic Energy Backup. If the drive detects a power loss or momentary power loss, it will quickly decelerate the motor. The drive uses regenerative energy from the motor to keep the main circuit operating. When you return power during motor deceleration, the drive returns operation to the status before the power loss. The KEB Ride-Thru function is different than other functions for continuous operation. If the drive detects momentary power loss, the motor will ramp to stop. It will not coast to stop. This function is applicable for applications in which it is necessary to prevent materials from running out, for example control for film and fiber lines.

The KEB Ride-Thru function has 4 methods of operation. Parameter *L2-29* [Kinetic Energy Backup Method] sets the method.

When you use the KEB Ride-Thru function with one drive, set $L2-29 = 0, 1$ [Single Drive KEB Ride-Thru 1, Single Drive KEB Ride-Thru 2].

If deceleration in coordination with more than one drive is necessary, for example textile machinery line systems, set $L2-29 = 2, 3$ [System KEB Ride-Thru 1, System KEB Ride-Thru 2].

Table 2.58 KEB Ride-Thru Function Operation Method

L2-29	Kinetic Energy Backup Method	Operation	Configuration Precautions
0	Single Drive KEB Ride-Thru 1	The drive uses regenerative energy from the motor to keep the DC bus voltage at the level set in <i>L2-11</i> [KEB DC Bus Voltage Setpoint] while it adjusts the rate of deceleration. The KEB operation continues while the drive adjusts the deceleration rate with the setting of <i>C1-09</i> [Fast Stop Time].	<ul style="list-style-type: none"> • Set <i>C1-09</i> correctly to prevent <i>Uv1</i> [DC Bus Undervoltage] and <i>ov</i> [Overvoltage]. • If the drive detects <i>Uv1</i> during the KEB operation, decrease the value set in <i>C1-09</i>. • If the drive detects <i>ov</i> during the KEB operation, increase the value set in <i>C1-09</i>.
1	Single Drive KEB Ride-Thru 2	The drive uses information about the inertia of the connected machinery to find the deceleration rate necessary to keep the DC bus voltage at the level set in parameter <i>L2-11</i> . The drive uses system inertia to calculate the deceleration time. You cannot adjust this value.	<ul style="list-style-type: none"> • If the drive detects <i>Uv1</i> during the KEB operation, increase the setting value of <i>L3-20</i> [DC Bus Voltage Adjustment Gain] and <i>L3-21</i> [OV/Suppression Accel/Decel P Gain]. • If the drive detects <i>ov</i> during the KEB operation, decrease the setting values of <i>L3-20</i> and <i>L3-21</i>.
2	System KEB Ride-Thru 1	The drive does not monitor the DC bus voltage. The drive decelerates at the KEB deceleration time set in <i>L2-06</i> . Use <i>L2-06</i> to set the time necessary to decelerate from the current frequency reference to 0 Hz. More than one drive can decelerate and keep a constant speed ratio between drives.	Use the dynamic braking option with System KEB Ride-Thru 1.
3	System KEB Ride-Thru 2	The drive uses the KEB deceleration time set in <i>L2-06</i> to decelerate and it also monitors the DC bus voltage. If the voltage level increases, the drive momentarily holds the frequency to prevent an <i>ov</i> before it continues to decelerate.	If you cannot use the dynamic braking option, use System KEB Ride-Thru 2.

■ KEB Ride Thru Start

When $L2-01 = 3, 4, 5$ [*Power Loss Ride Through Select = Kinetic Energy Backup: L2-02, Kinetic Energy Backup: CPU Power, Kinetic Energy Backup: DecelStop*], the drive starts the KEB operation immediately after it detects a momentary power loss. When one of these conditions occur, the drive will activate KEB Ride-Thru:

- KEB Ride-Thru 1 set for the MFDI terminal becomes enabled (terminal is deactivated when $HI-xx = 65$ or terminal is activated when $HI-xx = 66$).
The drive uses the mode selected $L2-29$ [*Kinetic Energy Backup Method*] to start KEB operation.
- KEB Ride-Thru 2 set for the MFDI terminal becomes enabled (terminal is deactivated when $HI-xx = 7A$ or terminal is activated when $HI-xx = 7B$).
The drive automatically starts Single KEB Ride-Thru 2 and it ignores the setting of $L2-29$.
- The DC bus voltage is less than the level set in $L2-05$ [*Undervoltage Detection Lvl (Uv1)*].
The KEB operation will start as specified in $L2-29$.

Note:

If you try to set KEB Ride-Thru 1 and 2 to the MFDI terminals at the same time, it will trigger $oPE03$ [*Multi-Function Input Setting Err*].

In this example, the drive detects that the DC bus voltage is less than the level set in $L2-05$ and starts the KEB operation. When you return power during KEB operation, the drive will continue KEB operation when the KEB Ride-Thru is input, although the time set in $L2-10$ [*Minimum KEB Time*] expired. The motor accelerates again after you cancel the KEB Ride-Thru.

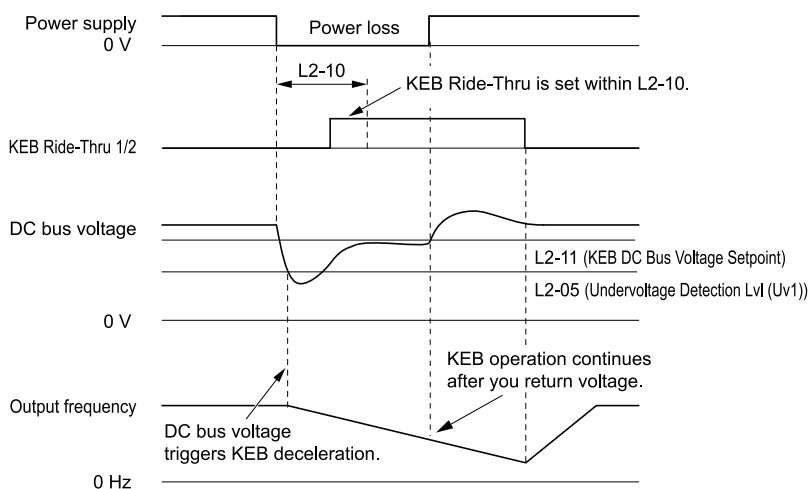

Figure 2.103 KEB Operation through KEB Ride-Thru Input

■ KEB Ride-Thru End Detection

Parameter $L2-01$ [*Power Loss Ride Through Select*] and a digital input programmed for KEB set the KEB function end detection.

Use the Momentary Power Loss Ride-Thru Time to Cancel KEB Operation

shows an example with this configuration:

- $L2-01 = 3$ [*Kinetic Energy Backup: L2-02*] is set.
- KEB Ride-Thru is not used.

The drive starts deceleration through KEB operation. When the time set in $L2-10$ [*Minimum KEB Time*] expires, the drive stops the KEB operation and then it accelerates the motor again until it is at the frequency reference value used before the power loss.

If you do not return the DC bus voltage in the time set in $L2-02$ [*Power Loss Ride Through Time*], the drive detects $Uv1$ [*DC Bus Undervoltage*] and the drive turns off its output.

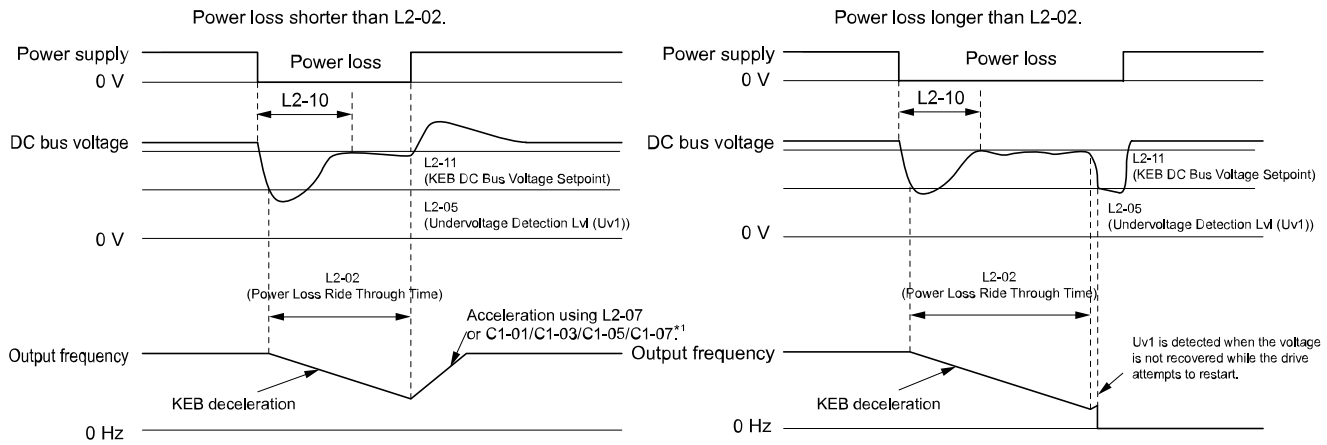

Figure 2.104 Cancel the KEB Operation after the Momentary Power Loss Ride-Thru Time Is Expired without KEB Ride-Thru

*1 When L2-07 = 0.00 [Kinetic Energy Backup Accel Time = 0.00 s], the drive accelerates again as specified by the applicable Acceleration Time [C1-01, C1-03, C1-05, C1-07], and usual operation continues.

Use the Momentary Power Loss Ride-Thru Time and KEB Ride-Thru to Cancel KEB Operation

shows an example with this configuration:

- L2-01 = 3.
- Use KEB Ride-Thru 1 [H1-xx = 65, 66] or KEB Ride-Thru 2 [H1-xx = 7A, 7B].

The drive starts deceleration through KEB operation. The drive decelerates for the time set in parameter L2-10, then it measures the DC bus voltage and the status of the digital input terminal set for KEB Ride-Thru. When the DC bus voltage is less than the level set in L2-11 [KEB DC Bus Voltage Setpoint], or if the KEB digital input is active, KEB deceleration continues. When the DC bus voltage is more than the level set in L2-11, the drive ends KEB operation. The drive accelerates the motor to the frequency reference value before the power loss, and usual operation continues. If the time set in L2-02 is expired, the drive detects Uv1. When you cancel the KEB Ride-Thru, the motor accelerates again, and usual operation continues.

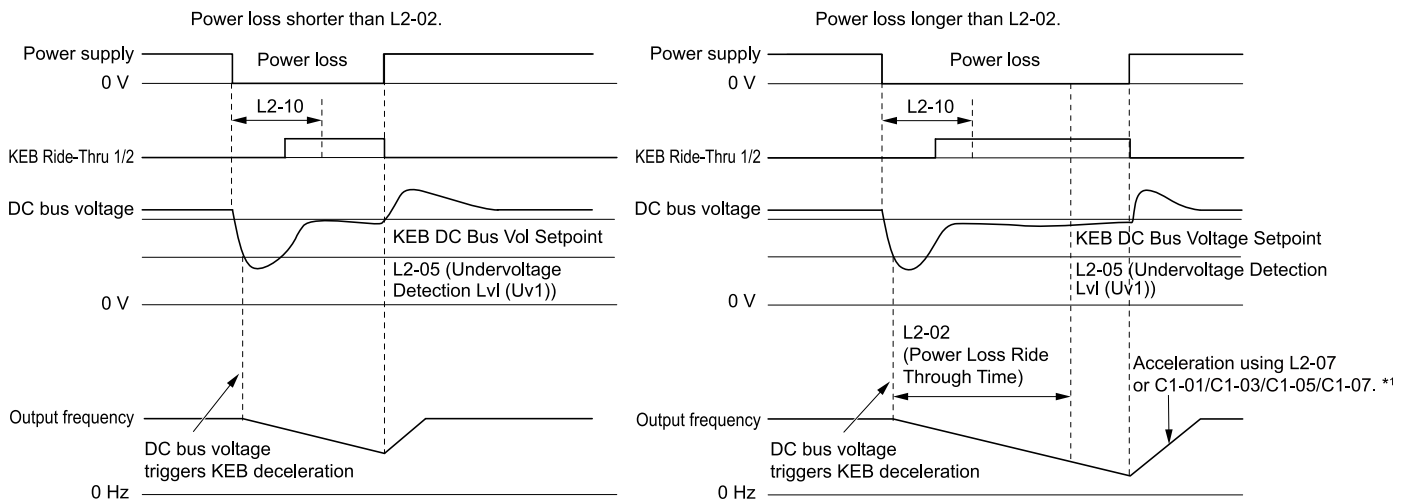

Figure 2.105 Use the Momentary Power Loss Ride-Thru Time and KEB Ride-Thru to Cancel KEB Operation

*1 When L2-07 = 0.00, the drive accelerates again as specified by the applicable Acceleration Time [C1-01, C1-03, C1-05, C1-07], and usual operation continues.

Cancel KEB Operation When Restoration of Power Occurs while the Control Power (Power Supply to the Control Board) is Maintained

shows an example with this configuration:

- L2-01 = 4 [Kinetic Energy Backup: CPU Power] is set.
- KEB Ride-Thru is not used.

The drive starts deceleration through KEB operation. The drive decelerates for the time set in parameter $L2-10$, and then measures the DC bus voltage level. When the DC bus voltage is lower than the level set in $L2-11$, the drive uses the KEB Ride-Thru function to continue deceleration. When the DC bus voltage is more than the level set in $L2-11$, usual operation continues. The drive accelerates the motor to the frequency reference value before the power loss, and usual operation continues.

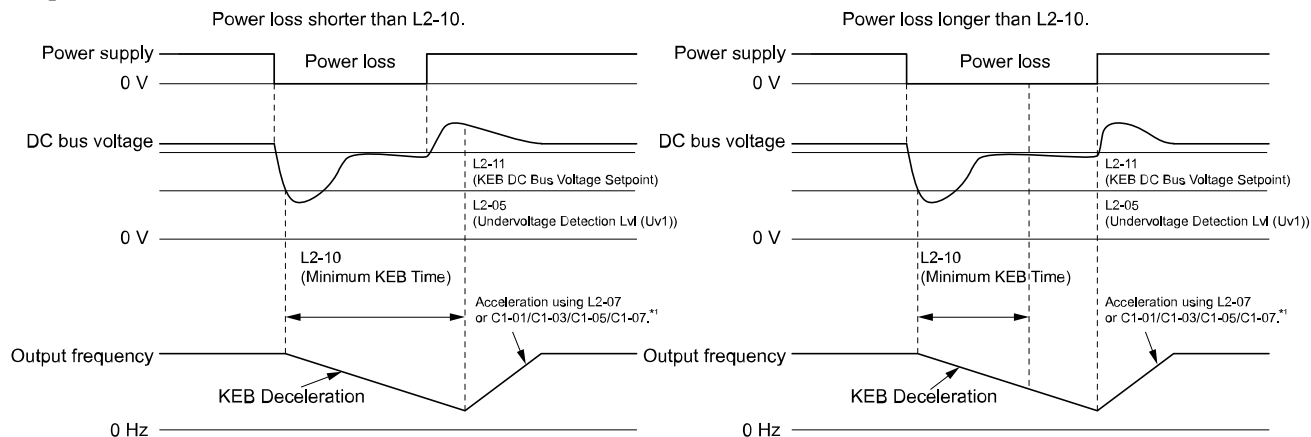

Figure 2.106 Cancel KEB Operation without Using the KEB Ride-Thru if Restoration of Power Occurs while the Control Power (Power Supply to the Control Board) is Maintained

*1 When $L2-07 = 0.00$ s, the drive accelerates again as specified by the applicable *Acceleration Time* [$C1-01$, $C1-03$, $C1-05$, $C1-07$], and usual operation continues.

Use the KEB Ride-Thru to Cancel KEB Operation when Restoration of Power Occurs while the Control Power (Power Supply to the Control Board) is Maintained

shows an example with this configuration:

- $L2-01 = 4$.
- Use *KEB Ride-Thru 1* [$H1-xx = 65, 66$] or *KEB Ride-Thru 2* [$H1-xx = 7A, 7B$].

The drive starts deceleration through KEB operation. When the motor decelerates for the time set in $L2-10$, the drive measures the DC bus voltage and the status of the digital input set for KEB Ride-Thru. When the DC bus voltage is less than the level set in $L2-11$, or if the digital input set to KEB Ride-Thru is active, deceleration continues. When the DC bus voltage is more than the level set in $L2-11$, the drive ends KEB operation. The drive accelerates the motor to the frequency reference value before the power loss, and usual operation continues. When the KEB Ride-Thru continues to be input after the time set in $L2-02$ is expired, the drive uses the KEB Ride-Thru function to continue to decelerate. When you cancel the KEB Ride-Thru, the motor accelerates again, and usual operation continues.

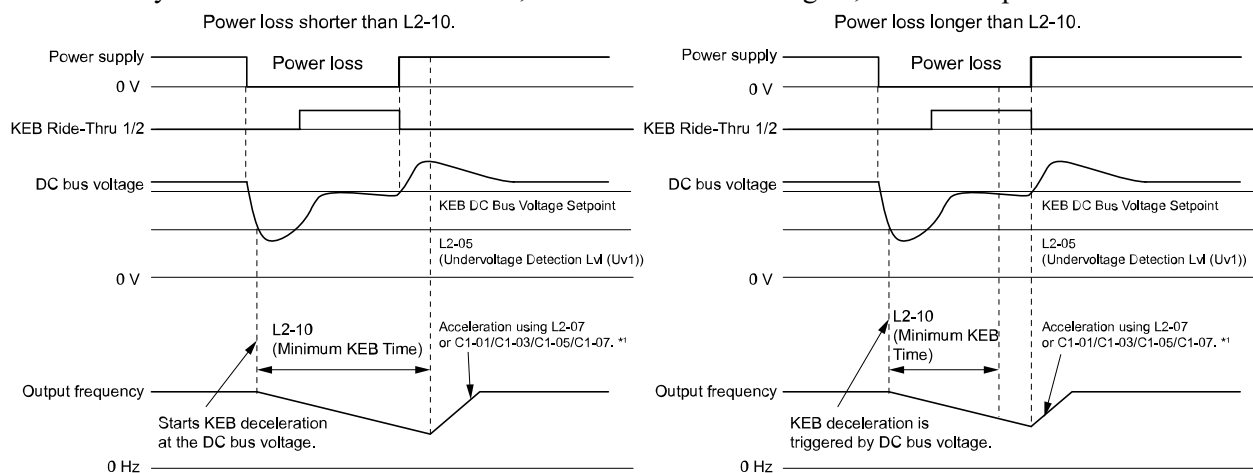

Figure 2.107 Use the KEB Ride-Thru to Cancel KEB Operation when Restoration of Power Occurs while the Control Power (Power Supply to the Control Board) is Maintained

*1 When $L2-07 = 0.00$ s, the drive accelerates again as specified by the applicable *Acceleration Time* [$C1-01$, $C1-03$, $C1-05$, $C1-07$], and usual operation continues.

KEB Operation when L2-01 = 5 [Kinetic Energy Backup: DecelStop]

The drive starts deceleration through KEB operation. If you do not input the Run command, the motor cannot restart. The drive will continue to decelerate until the motor comes to the minimum output frequency or a complete stop. If you return power during deceleration, the drive continues to decelerate.

KEB Operation Wiring Example

Figure 2.108 shows an example that uses an undervoltage relay to trigger the KEB Ride-Thru at power loss. When a power loss occurs, the undervoltage relay triggers *KEB Ride-Thru* [H1-06 = 65, 66, 7A, 7B] at terminal S6.

Note:

- Set the drive to activate the Run command while the KEB function is operating. If you turn off the Run command, the drive will not accelerate back to speed when you return power.
- When you set L2-29 = 2 [Kinetic Energy Backup Method = System KEB Ride-Thru 1], install a dynamic braking option.

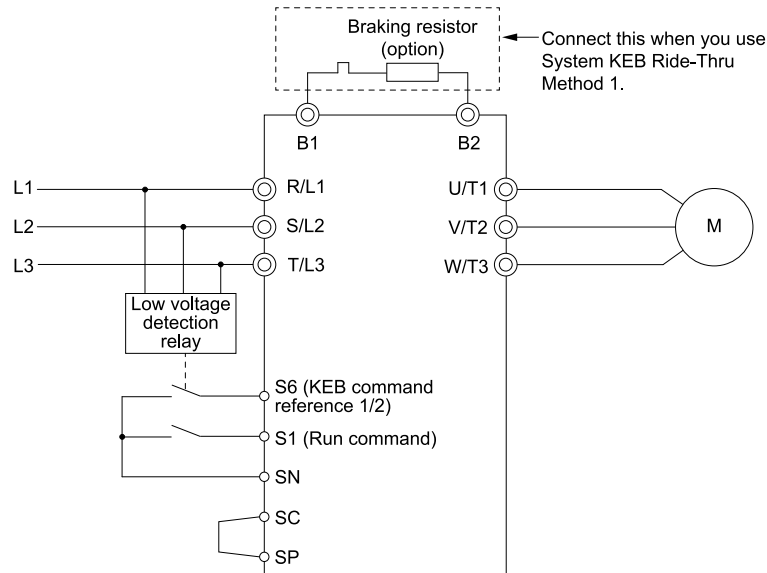

Figure 2.108 KEB Function Wiring Example

Parameters for KEB Ride-Thru

Table 2.59 shows the parameters that adjust the KEB Ride-Thru function. Parameter settings are different for the different KEB methods set in L2-29 [KEB Energy Backup Method].

Table 2.59 Parameters for KEB Ride-Thru

No.	Name	Configuring Settings	L2-29 [Kinetic Energy Backup Method]			
			0	1	2	3
C1-09	Fast Stop Time	<ul style="list-style-type: none"> • If <i>ov</i> [Overvoltage] occurs during KEB deceleration, increase the setting value. • If <i>Uv1</i> [DC Bus Undervoltage] occurs during KEB deceleration, decrease the setting value. 	x *1	-	-	-
C2-03	S-Curve Time @ Start of Decel	<ul style="list-style-type: none"> • If <i>ov</i> occurs immediately after you start KEB deceleration, increase the setting value. • If <i>Uv1</i> occurs immediately after you start operation, decrease the setting value. 	x	-	x	x
L2-05	Undervoltage Detection Lvl (Uv1)	If <i>Uv1</i> occurs immediately after you start KEB deceleration, increase the setting value to detect power loss more quickly.	x	x	x	x
L2-06	Kinetic Energy Backup Decel Time	<ul style="list-style-type: none"> • Does KEB Tuning. • If <i>ov</i> or <i>Uv1</i> occur during KEB deceleration after the KEB Tuning, set L2-06 in these conditions: <ul style="list-style-type: none"> – If <i>ov</i> occurs, increase the setting value – If <i>Uv1</i> occurs, decrease the setting value. 	-	-	x *2	x *2
L2-07	Kinetic Energy Backup Accel Time	Sets the acceleration time to return to the frequency reference value before a power loss, after you cancel the KEB operation. When L2-07 = 0, the drive uses the standard acceleration times set in C1-01, C1-03, C1-05, and C1-07 [Acceleration Time].	x	x	x	x

No.	Name	Configuring Settings	L2-29 [Kinetic Energy Backup Method]			
			0	1	2	3
L2-08	Frequency Gain at KEB Start	<ul style="list-style-type: none"> If <i>ov</i> occurs immediately after you start operation, decrease the setting value. If <i>Uv1</i> occurs immediately after you start KEB deceleration, increase the setting value. 	x	-	x	x
L2-10	Minimum KEB Time	<ul style="list-style-type: none"> With KEB Ride-Thru There is <i>Uv1</i> because you set a digital input for KEB Ride-Thru and the device that controls the input operated too slowly after power loss. Without KEB Ride-Thru If the DC bus voltage overshoots immediately after KEB Ride-Thru starts, increase L2-10 to longer than the overshoot. 	x	x	x	x
L2-11	KEB DC Bus Voltage Setpoint	<ul style="list-style-type: none"> Single Drive KEB Ride-Thru 2 Set to approximately 1.22 x input voltage. Single Drive KEB Ride-Thru 1, System KEB Ride-Thru 1, or System KEB Ride-Thru 2 Set to approximately 1.4 x input voltage. 	x	x	x	x
L3-20	DC Bus Voltage Adjustment Gain	<ul style="list-style-type: none"> If <i>ov</i> or <i>Uv1</i> occurs at the start of deceleration when you use KEB operation, increase this value in 0.1-unit increments. If there is torque ripple during deceleration when you use KEB Ride-Thru, decrease the value. 	-	x	-	-
L3-21	OVSuppression Accel/Decel P Gain	<p>If there is large speed or current ripple, decrease the value in 0.05 unit increments.</p> <p>Note: If the setting value is too low, then the drive will have unsatisfactory DC bus voltage control response. The drive can detect <i>ov</i> or <i>Uv1</i>.</p>	-	x	-	-
L3-24	Motor Accel Time @ Rated Torque	Set the motor acceleration time to the maximum frequency at the motor rated torque.	-	x	-	-
L3-25	Load Inertia Ratio	Sets the ratio between motor inertia and machine inertia.	-	x *3	-	-

*1 When $L2-29 = 0$ [KEB Energy Backup Method = Single Drive KEB Ride-Thru 1] and you do KEB Auto-Tuning, the drive will automatically set $C1-09$. If you must not change the Fast Stop time, do not do KEB Tuning.

*2 If you do KEB Tuning when $L2-29 = 1, 2, \text{ or } 3$ [KEB Energy Backup Method = Single Drive KEB Ride-Thru 2, System KEB Ride-Thru 1 or System KEB Ride-Thru 2], the drive will automatically set $L2-06$ [KEB Decel Time].

*3 The drive sets this value automatically when KEB Tuning completes correctly.

■ L2-01: Power Loss Ride Through Select

No. (Hex.)	Name	Description	Default (Range)
L2-01 (0485)	Power Loss Ride Through Select	<div style="display: flex; gap: 5px;"> V/f OLV OLV/PM AOLV/PM EZOLV </div> <p>Sets the drive operation after a momentary power loss.</p>	0 (0 - 5)

The drive detects momentary power loss when the drive DC bus voltage is less than the value set in $L2-05$ [Undervoltage Detection Lvl (*Uv1*)].

0 : Disabled

A momentary power loss triggers *Uv1* [DC Bus Undervoltage].

If you do not restore power in 15 ms, a *Uv1* is triggered and the drive shuts off the output. The motor coasts to stop.

1 : Enabled

This setting will enable for the time set in $L2-02$ [Power Loss Ride Through Time] or until the CPU is inactive. When the CPU is inactive, $b1-17$ [Run Command at Power Up] sets operation at power up.

When power returns in the time set in $L2-02$, the drive will restart. If power does not return in the time set in $L2-02$, the drive will detect *Uv1*.

The drive momentarily turns OFF its output after a power loss. If the power returns in the time set to $L2-02$, the drive will do Speed Search and try to continue operation.

If the DC bus voltage is less than or equal to the *Uv1* detection level for the time set in $L2-02$, the drive will detect *Uv1* and output a fault signal.

Note:

- The necessary time for the drive to restart after power returns is different for different drive capacities.
- The upper limit of the possible momentary power loss Ride-Thru time is different for different drive models.

2 : Enabled while CPU Power Active

This setting will enable for the time set in *L2-02 [Power Loss Ride Through Time]* or until the CPU is inactive. When the CPU is inactive, *b1-17 [Run Command at Power Up]* sets operation at power up.

When power returns and the drive control circuit has power, the drive will restart. This will not trigger *Uv1*.

When there is a momentary power loss, the drive output will turn OFF. If the power returns and the drive control circuit has power, the drive will do Speed Search and try to continue operation. This will not trigger a *Uv1*. This function lets the drive lose power for longer than when *L2-01 = 1*.

3 : Kinetic Energy Backup: L2-02

If power does not return in the time set in *L2-02*, the drive will detect *Uv1*.

If the drive detects momentary power loss, the drive will use regenerative energy from the motor and ramp to stop. When you return power in the time set in *L2-02*, the drive will accelerate to the frequency reference value that the drive used before the power loss. If you do not return power in the time set to *L2-02*, the drive will detect *Uv1* and the drive output will turn OFF. *L2-29 [Kinetic Energy Backup Method]* sets the type of KEB operation.

4 : Kinetic Energy Backup: CPU Power

When power returns and the drive control circuit has power, the drive will restart.

The drive decelerates using regenerative energy from the motor until the power returns and then restarts when a momentary power loss is detected. When power is restored during deceleration, the drive accelerates the motor again to the frequency reference value used before the power loss. If the motor comes to a stop before the power returns, the drive loses control power and the drive output shuts off. A *Uv1* is not triggered when power is restored while power to the CPU in the drive is maintained. *L2-29* sets the type of KEB operation.

5 : Kinetic Energy Backup: DecelStop

When power returns, the drive will continue to decelerate until the motor fully stops.

If the drive detects momentary power loss, the drive will use regenerative energy from the motor and ramp to stop. When you return power to the drive, the drive will continue to decelerate until the motor comes to a full stop. After you return power, the drive will ramp to stop in the set deceleration time. *L2-29* sets the type of KEB operation.

Note:

When you set *L2-01*, make sure that you know these items:

- You can use a Momentary Power Loss Unit on models 2001 to 2042 and 4001 to 4023 for a longer momentary power loss ride through time. A Momentary Power Loss Unit makes it possible to continue operation of the drive after a maximum of 2 seconds of power loss.
- When you set *L2-01 = 1 to 4*, keep the magnetic contactor on the drive input side ON and keep the control signal while the drive does KEB operation.
- When *L2-01 = 1 to 5*, *Uv [DC Bus Undervoltage]* will flash on the keypad while the drive is attempting to recover from a momentary power loss. The drive will not output a fault signal at this time.
- When you use a magnetic contactor between the motor and the drive, keep the magnetic contactor closed while the drive does KEB operation or tries to restart with Speed Search.
- Keep the Run command active during KEB operation. The drive cannot accelerate back to the frequency reference when the power returns.
- When *L2-01 = 3 to 5*, if the control power supply voltage is less than the CPU operation level during KEB Ride-Thru, it will trigger *Uv1*.

■ L2-02: Power Loss Ride Through Time

No. (Hex.)	Name	Description	Default (Range)
L2-02 (0486)	Power Loss Ride Through Time	<div style="display: flex; gap: 5px;"> V/f OLV OLV/PM AOLV/PM EZOLV </div> <p>Sets the length of time that the drive will wait before it tries to restart if the DC bus voltage is less than <i>L2-05 [Undervoltage Detection Lvl (Uv1)]</i> after a momentary power loss.</p>	Determined by o2-04, C6-01 (0.0 - 25.5 s)

This function is applicable when *L2-01 = 1, 3 [Power Loss Ride Through Select = Enabled, Kinetic Energy Backup: L2-02]*.

After a power loss, if these conditions are satisfied, the drive detects *Uv1 [DC Bus Undervoltage]*, shuts off the output, and the motor coasts to stop:

- After the DC bus voltage decreases less than the level of *L2-05 [Undervoltage Detection Lvl (Uv1)]*, the time set in *L2-02* is expired.
- The drive does not detect a *Uv2 [Control Power Undervoltage]*.

Depending on use conditions, if the time set in *L2-02* is long, the drive may detect *Uv2* before *Uv1*. If this is a problem, decrease the time set in *L2-02* to prevent *Uv2*.

Note:

- The length of time that the drive can recover after a power loss changes when drive capacity changes.
- The upper limit of the possible momentary power loss Ride-Thru time changes when drive capacity changes.

■ L2-03: Minimum Baseblock Time

No. (Hex.)	Name	Description	Default (Range)
L2-03 (0487)	Minimum Baseblock Time	<div style="display: flex; justify-content: space-between; align-items: center;"> V/f OLV OLV/PM AOLV/PM EZOLV </div> Sets the minimum time to continue the drive output block (baseblock) after a baseblock.	Determined by o2-04, C6-01 (0.1 - 5.0 s)

Sets the length of time that the drive will wait for the residual voltage in the motor to dissipate in estimation to the secondary circuit time constant of the motor. If *oC* [Overcurrent] or *ov* [DC Bus Overvoltage] occur at the start of Speed Search, after power returns, or during DC Injection Braking, increase this setting.

■ L2-04: Powerloss V/f Recovery Ramp Time

No. (Hex.)	Name	Description	Default (Range)
L2-04 (0488)	Powerloss V/f Recovery Ramp Time	<div style="display: flex; justify-content: space-between; align-items: center;"> V/f OLV OLV/PM AOLV/PM EZOLV </div> Sets the time for the drive output voltage to go back to correct voltage after completing speed searches.	Determined by o2-04, C6-01 (0.0 - 5.0 s)

Sets the time for voltage to recover from 0 V to the value set in *E1-05* [Maximum Output Voltage].

■ L2-05: Undervoltage Detection Lvl (Uv1)

No. (Hex.)	Name	Description	Default (Range)
L2-05 (0489)	Undervoltage Detection Lvl (Uv1)	<div style="display: flex; justify-content: space-between; align-items: center;"> V/f OLV OLV/PM AOLV/PM EZOLV </div> Sets the voltage at which a <i>Uv1</i> [DC Bus Undervoltage] fault is triggered or at which the KEB function is activated. Usually it is not necessary to change this setting.	Determined by o2-04 and E1-01 (200 V Class: 150 - 210 V, 400 V Class: 300 - 420 V)

NOTICE: Damage to Equipment. When you set this parameter to a value lower than the default, you must install an AC reactor on the input side of the power supply. If you do not install an AC reactor, it will cause damage to the drive circuitry.

Note:

If the low voltage detection level is near the lower limit value of *L2-05*, the drive will detect *Uv1* during KEB Ride-Thru operation. Do not set the value too low when you use the KEB Ride-Thru function.

■ L2-06: Kinetic Energy Backup Decel Time

No. (Hex.)	Name	Description	Default (Range)
L2-06 (048A) Expert	Kinetic Energy Backup Decel Time	<div style="display: flex; justify-content: space-between; align-items: center;"> V/f OLV OLV/PM AOLV/PM EZOLV </div> Sets the deceleration time during KEB operation used to decrease the maximum output frequency to 0.	0.0 s (0.0 - 6000.0 s)

Set *L2-29* = 2 or 3 [Kinetic Energy Backup Method = System KEB Ride-Thru 1 or System KEB Ride-Thru 2] to enable this function. When *L2-29* = 1, 2, 3 [Kinetic Energy Backup Method = Single Drive KEB Ride-Thru 2, System KEB Ride-Thru 1, System KEB Ride-Thru 2] and you do KEB Auto-Tuning, the drive will automatically set this value.

Sets the deceleration time necessary to decelerate from the frequency reference to 0 Hz when the drive detects a momentary power loss. If a *Uv1* [DC Bus Undervoltage] fault occurs during KEB operation, decrease the deceleration time. If an *ov* [Overvoltage] fault occurs, increase the deceleration time.

- *L2-06* = 0

The drive automatically decreases *C1-09* [Fast Stop Time] to the base value to keep the DC bus voltage above the low voltage detection level. The drive ignores *L2-02* [Momentary Power Loss Ride-Thru Time] in this condition.

- *L2-06* ≠ 0

As shown in [Figure 2.109](#), the frequency reference decelerates to the KEB frequency level as specified by the deceleration rate set in *L2-06* and then returns to the initial frequency reference as specified by *C1-01* [Acceleration Time 1]. The drive uses the setting value of the KEB frequency rate as shown in the this formula to set the KEB frequency level:

$$\text{KEB frequency level} = \text{Output frequency before power loss} \times (1 - (L2-02) / (L2-06))$$

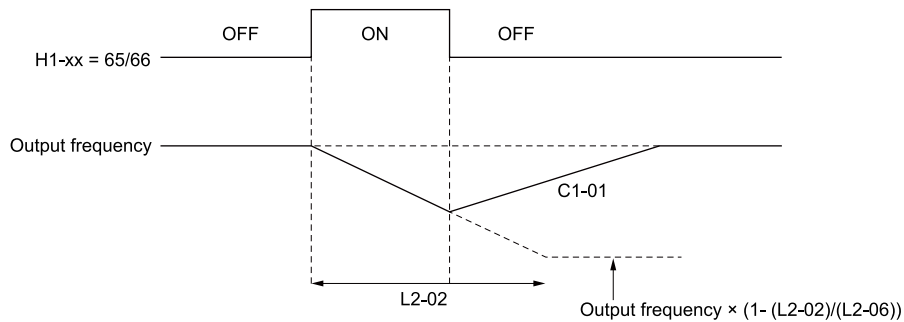

Figure 2.109 Kinetic Energy Backup Decel Time

■ **L2-07: Kinetic Energy Backup Accel Time**

No. (Hex.)	Name	Description	Default (Range)
L2-07 (048B) Expert	Kinetic Energy Backup Accel Time	<input type="checkbox"/> V/f <input type="checkbox"/> OLV <input type="checkbox"/> OLV/PM <input type="checkbox"/> AOLV/PM <input type="checkbox"/> EZOLV Sets the acceleration time to return the frequency to the frequency reference before a power loss after canceling KEB operation.	0.0 s (0.0 - 6000.0 s)

Set this parameter to 0.0 to disable the function. The drive uses the acceleration time in *C1-01*, *C1-03*, *C1-05*, and *C1-07* to accelerate again after KEB operation completes.

■ **L2-08: Frequency Gain at KEB Start**

No. (Hex.)	Name	Description	Default (Range)
L2-08 (048C) Expert	Frequency Gain at KEB Start	<input type="checkbox"/> V/f <input type="checkbox"/> OLV <input type="checkbox"/> OLV/PM <input type="checkbox"/> AOLV/PM <input type="checkbox"/> EZOLV Sets the quantity of output frequency reduction used when KEB operation starts as a percentage of the motor rated slip before starting KEB operation.	100% (0 - 300%)

Decreases the output frequency in steps to quickly set the motor to a regenerative condition. Use this formula to calculate the value:

$$\text{Output frequency reduction} = \text{Motor rated slip before KEB operation} \times (L2-08/100) \times 2$$

■ **L2-09: KEB Minimum Frequency Level**

No. (Hex.)	Name	Description	Default (Range)
L2-09 (048D) Expert	KEB Minimum Frequency Level	<input type="checkbox"/> V/f <input type="checkbox"/> OLV <input type="checkbox"/> OLV/PM <input type="checkbox"/> AOLV/PM <input type="checkbox"/> EZOLV Sets the quantity of output frequency reduction used as a percentage of <i>E2-02 [Motor Rated Slip]</i> when KEB operation starts.	20% (0 - 100%)

These conditions set the quantity of decrease:

- Motor rated slip × (L2-09/100)
- The larger value between the value calculated with L2-08 and the value calculated with L2-09

■ **L2-10: Minimum KEB Time**

No. (Hex.)	Name	Description	Default (Range)
L2-10 (048E) Expert	Minimum KEB Time	<input type="checkbox"/> V/f <input type="checkbox"/> OLV <input type="checkbox"/> OLV/PM <input type="checkbox"/> AOLV/PM <input type="checkbox"/> EZOLV Sets the minimum length of time to operate the KEB after the drive detects a momentary power loss.	50 ms (0 - 25500 ms)

When you return power while KEB is operating, the drive continues KEB operation until the time set in L2-10 is expired. When the DC bus voltage is less than the level of L2-05 [*Undervoltage Detection Lvl (Uv1)*] in one of these conditions, KEB operation continues until the time set in L2-10 is expired:

- L2-01 = 3 [*Power Loss Ride Through Select = Kinetic Energy Backup: L2-02*]

- $L2-01 = 4$ [Kinetic Energy Backup: CPU Power]
- $L2-01 = 5$ [Kinetic Energy Backup: DecelStop]
- KEB Ride-Thru 1/2 [H1-xx = 65, 66, 7A, or 7B] is input into the drive.

When you input KEB Ride-Thru, KEB operation continues after the time set in $L2-10$ is expired. When you cancel KEB Ride-Thru, the motor accelerates again. When you do not input KEB Ride-Thru during the time set in $L2-10$, the drive accelerates to the frequency reference that the drive had before power loss in the applicable acceleration time.

When $L2-01 = 3, 4, \text{ or } 5$, and the DC bus voltage is a minimum of the value of $L2-11$ [KEB DC Bus Voltage Setpoint], the drive accelerates again after the time set in $L2-10$ is expired. When the DC bus voltage is less than the $L2-11$ value, KEB operation continues after the time set in $L2-10$ is expired.

Note:

- When $L2-01 = 0, 1, \text{ or } 2$ [Disabled, Enabled for L2-02 Time, or Enabled while CPU Power Active], increase the value of $L2-10$. Set $L2-10$ to cancel KEB operation if the KEB Ride-Thru is not input.
- Setting $L2-10$ to 0 ms disables the function of $L2-10$.

■ L2-11: KEB DC Bus Voltage Setpoint

No. (Hex.)	Name	Description	Default (Range)
L2-11 (0461) Expert	KEB DC Bus Voltage Setpoint	<div style="display: flex; gap: 5px;"> V/f OLV OLV/PM AOLV/PM EZOLV </div> Sets the target value that controls the DC bus voltage to a constant level in Single Drive KEB Ride-Thru 2. Sets the DC bus voltage level that completes the KEB operation for all other KEB methods.	Determined by E1-01 (Determined by E1-01)

■ L2-29: Kinetic Energy Backup Method

No. (Hex.)	Name	Description	Default (Range)
L2-29 (0475) Expert	Kinetic Energy Backup Method	<div style="display: flex; gap: 5px;"> V/f OLV OLV/PM AOLV/PM EZOLV </div> Sets the KEB function operation mode.	0 (0 - 3)

Set $L2-01 = 3, 4, \text{ or } 5$ [Power Loss Ride Through Select = Kinetic Energy Backup: L2-02, Kinetic Energy Backup: CPU Power, or Kinetic Energy Backup: DecelStop] or KEB Ride-Thru 1/2 [H1-xx = 65, 66, 7A, or 7B], to enable the KEB function.

0 : Single Drive KEB Ride-Thru 1

The drive monitors the DC bus voltage and uses regenerative energy from the motor to hold the DC bus voltage at the level set in $L2-11$ [KEB DC Bus Voltage Setpoint].

The KEB operation continues and the deceleration rate changes as specified by $C1-09$ [Fast Stop Time].

Note:

- If the drive detects $Uv1$ [DC Bus Undervoltage] during KEB operation, decrease the value of $C1-09$.
- If the drive detects ov [Overvoltage] during KEB operation, increase the value of $C1-09$.

1 : Single Drive KEB Ride-Thru 2

The drive does KEB operation and automatically calculates the deceleration rate to make sure that the main circuit electrical energy and main current voltage from motor regenerative energy is equal to $L2-11$.

2 : System KEB Ride-Thru 1

The drive does not monitor the DC bus voltage and decelerates as specified by the KEB deceleration time set in $L2-06$.

Use $L2-06$ to set the time necessary to decelerate from the current frequency reference to 0 Hz. More than one drive can decelerate and keep a constant speed ratio between drives.

Note:

If you keep constant deceleration rates for more than one drive, it can trigger ov faults. Use the dynamic braking option with System KEB Ride-Thru 1.

3 : System KEB Ride-Thru 2

The drive uses the KEB deceleration time set in $L2-06$ to decelerate and it also monitors the DC bus voltage.

If the voltage level increases, the drive momentarily holds the frequency to prevent an *ov* before it continues to decelerate.

Note:

When you cannot use a dynamic braking option, use System KEB Ride-Thru.

■ L2-30: KEB Zero Speed Operation

No. (Hex.)	Name	Description	Default (Range)
L2-30 (045E) Expert	KEB Zero Speed Operation	<div style="display: flex; gap: 5px;"> V/f OLV OLV/PM AOLV/PM EZOLV </div> <p>Sets the operation when the output frequency decreases below the zero level (DC braking injection starting frequency) during KEB deceleration when $L2-01 = 3$ to 5 [<i>Power Loss Ride Through Select = Kinetic Energy Backup: L2-02, Kinetic Energy Backup: CPU Power, or Kinetic Energy Backup: DecelStop</i>].</p>	0 (0, 1)

0 : Baseblock

1 : DC/SC Braking

Does DC injection braking and short circuit braking as specified by $b2-04$ [*DC Inject Braking Time at Stop*] and $b2-13$ [*Short Circuit Brake Time @ Stop*].

■ L2-31: KEB Start Voltage Offset Level

No. (Hex.)	Name	Description	Default (Range)
L2-31 (045D) Expert	KEB Start Voltage Offset Level	<div style="display: flex; gap: 5px;"> V/f OLV OLV/PM AOLV/PM EZOLV </div> <p>Sets the KEB start voltage offset.</p>	Determined by A1-02 (200 V Class: 0 - 100 V, 400 V Class: 0 - 200 V)

The drive uses this formula to calculate the KEB start voltage:

$$\text{KEB start voltage} = L2-05 [\text{Undervoltage Detect Level (Uv1)}] + L2-31$$

◆ L3: Stall Prevention

L3 parameters set the Stall Prevention function and overvoltage suppression function.

■ Stall Prevention

If the load is too heavy or the acceleration and deceleration times are too short, the motor can slip too much because it cannot work at the same rate as the frequency reference. If the motor stalls during acceleration, current increases as the slip increases to cause an *oC* [*Overcurrent*], *oL2* [*Drive Overload*], or *oL1* [*Motor Overload*] and the drive will stop. If the motor stalls during deceleration, too much regenerative power will flow back into the DC bus capacitors, and cause the drive to detect an *ov* [*Overvoltage*] fault and stop.

The stall prevention function will let the motor get to the set speed without stalling and it is not necessary for you to change the acceleration or deceleration time settings. You can set a separate stall prevention functions for acceleration, operating at constant speeds, and deceleration.

■ Overvoltage Suppression Function

Decreases the regenerative torque limit and increases the output frequency when the DC bus voltage increases to prevent *ov*. This function can drive loads with cyclic regenerative operation, for example punch presses or other applications with repeated crank movements. When you use this function, set $L3-11 = 1$ [*Overvoltage Suppression Select = Enabled*].

The drive adjusts the regenerative torque limit and the output frequency during overvoltage suppression to make sure that the DC bus voltage is not more than the level set in $L3-17$ [*DC Bus Regulation Level*].

Set these parameters as necessary when you use the overvoltage suppression function:

- $L3-20$ [*DC Bus Voltage Adjustment Gain*]
- $L3-21$ [*OVSuppression Accel/Decel P Gain*]
- $L3-24$ [*Motor Accel Time @ Rated Torque*]
- $L3-25$ [*Load Inertia Ratio*]

Note:

- When overvoltage suppression is triggered, the motor speed is more than the frequency reference. Do not use overvoltage suppression for applications where the frequency reference and the motor speed must align.
- When you use a braking resistor, set $L3-11 = 0$ [Disabled].
- The overvoltage suppression function is enabled only when you operate immediately below the maximum frequency. Overvoltage suppression does not increase the output frequency to more than the maximum frequency. Make sure that the motor and machine specifications are correct for the application, then increase the maximum frequency.
- If there is a sudden increase to a regenerative load, ov can occur.

■ L3-01: Stall Prevention during Accel

No. (Hex.)	Name	Description	Default (Range)
L3-01 (048F)	Stall Prevention during Accel	<div style="display: flex; gap: 5px;"> V/f OLV OLV/PM AOLV/PM EZOLV </div> Sets the method of the Stall Prevention During Acceleration.	1 (0 - 3)

Note:

When $A1-02 = 5$ [Control Method Selection = OLV/PM], the setting range is 0 and 1.

Stall prevention during acceleration prevents the stalling and stopping of motors when the drive detects oC [Overcurrent], $oL2$ [Drive Overloaded], or $oL1$ [Motor Overload] when you apply a large load during acceleration or when you set sudden acceleration times related to load inertia.

0 : Disable

The Stall Prevention function does not operate during acceleration, and acceleration occurs for the set acceleration time. If the acceleration time is too short, the motor does not fully accelerate during the set time, which causes the drive to detect $oL1$ or $oL2$ and the motor to stop.

1 : Enabled

Enables the Stall Prevention During Acceleration function. Operation is different for different control methods.

• V/f Control, Open Loop Vector Control, or EZ Open Loop Vector Control

When the output current is more than $L3-02$ [Stall Prevent Level during Accel], the drive stops acceleration. The drive stops deceleration when the output current is less than $L3-02 - 15\%$. The Stall Prevention function level automatically decreases for constant output ranges.

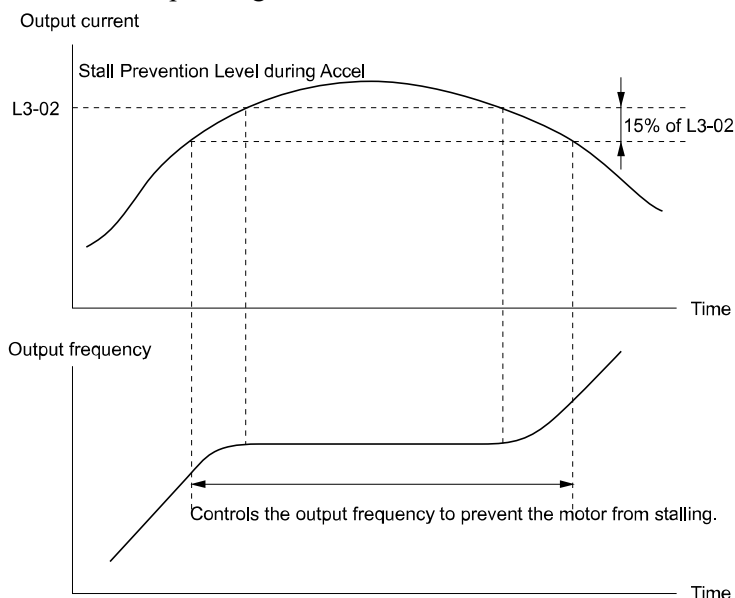

Figure 2.110 Stall Prevention During Acceleration when Using Induction Motors

• Open Loop Vector Control for PM

When the output current is more than $L3-02$, the drive stops acceleration. When the time set in $L3-27$ [Stall Prevention Detection Time] is expired and the output current = $L3-02$, the drive will start deceleration as specified by the value set in $L3-22$ [PM Stall Prevention Decel Time]. The drive starts acceleration again when the output current is less than $L3-02 - 15\%$. When the time set in $L3-27$ is expired, the drive starts acceleration again.

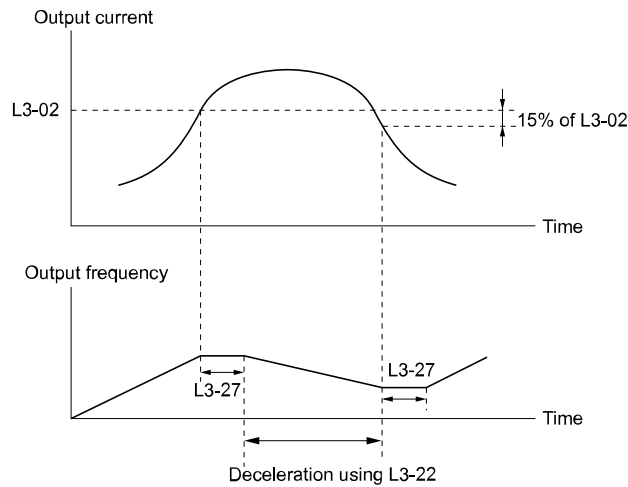

Figure 2.111 Stall Prevention During Acceleration Function in OLV/PM

2 : Intelligent (Ignore Accel Ramp)

The drive ignores the acceleration time setting and the drive starts to accelerate in the minimum length of time. The drive automatically adjusts the acceleration rate to make sure that the output current is not more than *L3-02*.

3 : Current Limit Acceleration

This function uses the *L3-02* value to limit the output current and automatically adjust the acceleration rate. When the load (output current) increases to more than the current limit level during acceleration, the drive automatically adjusts the acceleration rate.

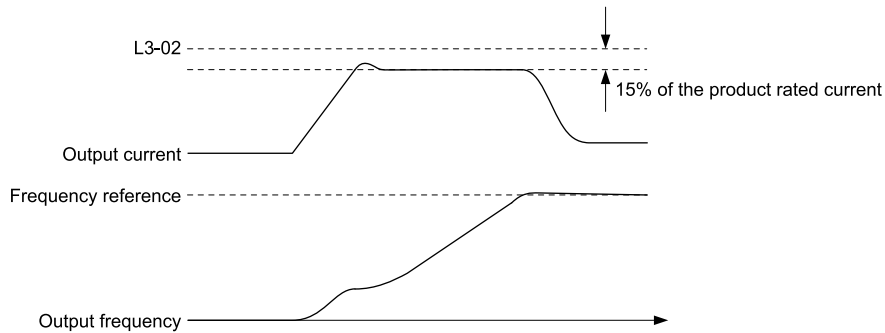

Figure 2.112 Current Limit Acceleration

■ L3-02: Stall Prevent Level during Accel

No. (Hex.)	Name	Description	Default (Range)
L3-02 (0490)	Stall Prevent Level during Accel	<input type="checkbox"/> V/f <input type="checkbox"/> OLV <input checked="" type="checkbox"/> OLV/PM <input type="checkbox"/> AOLV/PM <input type="checkbox"/> EZOLV Sets the output current level at which the Stall Prevention function operates during acceleration where the drive rated output current is 100%.	Determined by C6-01 (0 - 150%)

Note:

- If you use a motor that is small compared to the drive and the motor stalls, decrease the setting value.
- When you operate the motor in the constant power range, set *L3-03* [Stall Prevent Limit during Accel].
- The upper limit to the setting range changes when the setting for *C6-01* [Normal / Heavy Duty Selection] changes.
 -150% when *C6-01* = 0 [Heavy Duty Rating]
 -120% when *C6-01* = 1 [Normal Duty Rating]

■ L3-03: Stall Prevent Limit during Accel

No. (Hex.)	Name	Description	Default (Range)
L3-03 (0491)	Stall Prevent Limit during Accel	<input type="checkbox"/> V/f <input type="checkbox"/> OLV <input checked="" type="checkbox"/> OLV/PM <input type="checkbox"/> AOLV/PM <input type="checkbox"/> EZOLV Sets the lower limit for the stall prevention level used in the constant output range as a percentage of the drive rated output current.	50% (0 - 100%)

The stall prevention level set in *L3-02 [Stall Prevent Level during Accel]* is automatically reduced when the motor is running within the constant output range. Parameter *L3-03* is the limit value used to prevent the stall prevention level during constant output ranges to fall below the minimum required level.

Note:

The function to automatically reduce the stall prevention level does not operate when *L3-01 = 3 [Stall Prevention during Accel = Current Limit Method]*.

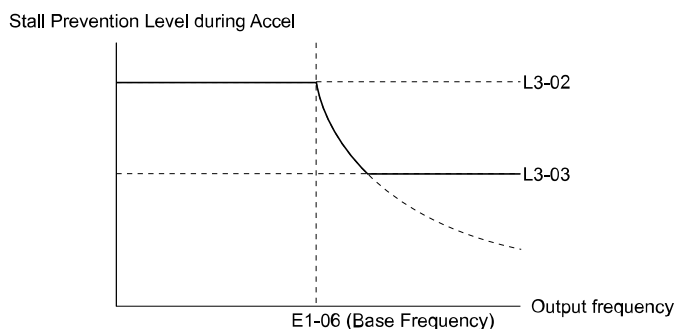

Figure 2.113 Stall Prevent Level during Accel/Limit

■ L3-04: Stall Prevention during Decel

No. (Hex.)	Name	Description	Default (Range)
L3-04 (0492)	Stall Prevention during Decel	<input type="checkbox"/> V/f <input type="checkbox"/> OLV <input type="checkbox"/> OLV/PM <input type="checkbox"/> AOLV/PM <input type="checkbox"/> EZOLV Sets the method that the drive will use to prevent overvoltage faults when decelerating.	1 (Determined by A1-02)

Note:

- To connect a dynamic braking option (braking resistor or braking resistor unit) to the drive, set this parameter to *0* or *3*. Parameter settings *1*, *2*, *4*, *5*, and *7* will enable Stall Prevention function during deceleration, and the dynamic braking option will not function.
- The setting range changes when the *A1-02 [Control Method Selection]* value changes:
 - When *A1-02 = 5 [OLV/PM]*, the setting range is *0* to *2*.
 - When *A1-02 = 6* or *8 [AOLV/PM or EZOLV]*, the setting range is *0* or *1*.

Stall Prevention during deceleration controls the deceleration as specified by the DC bus voltage and does not let high inertia or fast deceleration cause *ov [Overvoltage]* faults.

0 : Disabled

The drive decelerates as specified by the deceleration time. If the deceleration time is too short, the drive can detect an *ov* fault.

Note:

If an *ov* fault occurs, connect a dynamic braking option to the drive. If an *ov* fault occurs when you connect a dynamic braking option and *A1-02 = 0* or *2 [Control Method Selection = V/f or OLV]* and *L3-04 = 0*, set *L3-04 = 3*.

1 : General Purpose

The drive decelerates as specified by the deceleration time. When the DC bus voltage is more than the Stall Prevention level, the drive stops deceleration until the DC bus voltage is less than the Stall Prevention Level. The drive then starts to decelerate at the set deceleration time. Frequent use of Stall Prevention will help prevent *ov* faults when the deceleration time is shorter than the drive can usually accept.

Note:

The Decel Stall Prevention function will increase the deceleration time to stop and the deceleration time will be longer than the setting. This function is not applicable for conveyor applications because the precision of the stop position is very important. As an alternative, use a dynamic braking option in these applications.

The input voltage setting of *E1-01 [Input AC Supply Voltage]* sets the DC bus voltage level for Stall Prevention.

Table 2.60 Stall Prevention Level during Deceleration

Drive Input Voltage	Stall Prevention Level during Deceleration
200 V Class	377 V
400 V Class	754 V

Figure 2.114 shows the Stall Prevention during deceleration function.

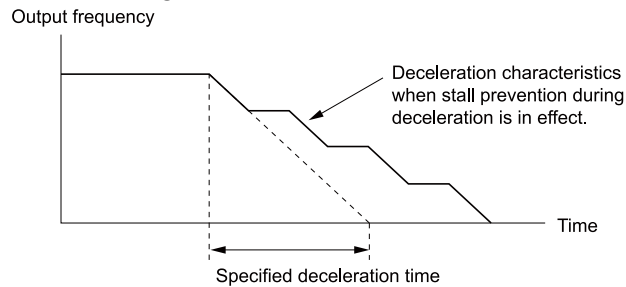

Figure 2.114 Stall Prevention Operation during Deceleration

2 : Intelligent (Ignore Decel Ramp)

The drive adjusts the deceleration rate to keep the DC bus voltage at the *L3-17 [DC Bus Regulation Level]* level. This makes the shortest possible deceleration time and will not let the motor stall. The drive ignores the selected deceleration time and the possible deceleration time cannot be less than 1/10 of the set deceleration time.

This function uses these parameters to adjust the deceleration rate:

- *L3-20 [DC Bus Voltage Adjustment Gain]*
- *L3-21 [OVSuppression Accel/Decel P Gain]*
- *L3-24 [Motor Accel Time @ Rated Torque]*
- *L3-25 [Load Inertia Ratio]*

Note:

The deceleration time is not constant. For applications where the precision of the stop position is very important, use a dynamic braking option and set *L3-04 = 0*. If an *ov* occurs, set *L3-04 = 3*.

3 : General Purpose w/ DB resistor

A braking resistor is necessary for this setting. The braking resistor and the drive work together for the Stall Prevention during deceleration function.

4 : Overexcitation/High Flux 1

Enables Overexcitation/High Flux and enables a shorter deceleration time than when *L3-04 = 0*.

Note:

- If the overexcitation time is long and you decelerate frequently, the drive can detect *oL1 [Motor Overload]* faults. If the drive detects *oL1*, decrease the deceleration time or install a braking resistor to the drive.
- The deceleration time during Overexcitation Deceleration changes when the motor characteristics and machine inertia change. Adjust the *n3-13 [OverexcitationBraking (OEB) Gain]* and *n3-23 [Overexcitation Braking Operation]* levels. Refer to [Overexcitation Deceleration on page 408](#) for more information.

5 : Overexcitation/High Flux 2

Enables Overexcitation/High Flux 2. This function decreases the possible deceleration time more than *Overexcitation/High Flux*.

The drive decreases motor speed and tries to keep the DC bus voltage at the *L3-17* level.

If the drive detects *oL1*, decrease the values set in *n3-13* and *n3-21*. If the drive detects *ov*, increase the values set in *C1-02*, *C1-04*, *C1-06*, and *C1-08 [Deceleration Times]*.

Note:

- During Overexcitation/High Flux 2, the drive disables Hunting Prevention in V/f Control and also disables Speed Control that uses torque limit in OLV Control.
- Refer to [Overexcitation Deceleration on page 408](#) for more information.

7 : Overexcitation/High Flux 3

If you set *L3-04 = 7 [Overexcitation Braking 3]*, the overexcitation increases compared with 4 [*Overexcitation/High Flux*]. This can decrease the deceleration time.

Note:

When *L3-04 = 7*, the overexcitation current increases as compared with 4. Motor load becomes larger, and it can cause *oL1 [Motor Overload]*. When you can use *L3-04 = 4* to operate the drive, set *L3-04 = 4*.

■ L3-05: Stall Prevention during RUN

No. (Hex.)	Name	Description	Default (Range)
L3-05 (0493)	Stall Prevention during RUN	<div style="display: flex; gap: 5px;"> V/f OLV OLV/PM AOLV/PM EZOLV </div> Sets the function to enable and disable Stall Prevention During Run.	2 (0 - Determined by A1-02)

Stall Prevention function during run prevents the motor from stalling by automatically reducing the speed when an *oL1* [Motor Overload] occurs while the motor is running at constant speed.

Note:

- An output frequency less than 6 Hz disables Stall Prevention during Run. The setting values of L3-05 and L3-06 [Stall Prevent Level during Run] do not have an effect.
- The setting range changes when the A1-02 [Control Method Selection] value changes:
 - A1-02 = 0, 5 [V/f, OLV/PM] : 0 to 2
 - A1-02 = 8 [EZOLV] : 0, 3

0 : No

The drive runs at the set frequency reference. A heavy load can cause the motor to stall and trip the drive with *oC* [Overcurrent] or *oL1*.

1 : Deceleration Time 1 (C1-02)

The drive will decelerate for the time set in C1-02 [Deceleration Time 1] when the current is more than the Stall Prevention level set in L3-06. When the current level is less than the “L3-06 setting value - 2%” for 100 ms, the drive accelerates again for the acceleration time applicable at that time until it is at the set frequency.

2 : Deceleration Time 2 (C1-04)

This setting functions the same as Setting 1 [Deceleration Time 1 (C1-02)]. When you enable the Stall Prevention function, the drive decelerates in the time set in C1-04 [Deceleration Time 2].

3 : Intelligent (Ignore Decel Ramp)

Enabled when A1-02 = 8 [EZOLV]. The drive operates with the largest possible output current to prevent motor stalling.

■ L3-06: Stall Prevent Level during Run

No. (Hex.)	Name	Description	Default (Range)
L3-06 (0494)	Stall Prevent Level during Run	<div style="display: flex; gap: 5px;"> V/f OLV OLV/PM AOLV/PM EZOLV </div> Sets the output current level at which the Stall Prevention function is enabled during run when the drive rated output current is 100%.	Determined by C6-01 (5 - 150%)

Note:

- This parameter is applicable when L3-05 = 1, 2 [Stall Prevention during RUN = Deceleration Time 1 (C1-02), Deceleration Time 2 (C1-04)].
- When L3-23 = 1 [Stall P Reduction at Constant HP = Automatic Reduction @ CHP Region], the drive will automatically decrease the level in the constant output range.
- The upper limit to the setting range changes when the setting for C6-01 [Normal / Heavy Duty Selection] changes.
 - 150% when C6-01 = 0 [Heavy Duty Rating]
 - 120% when C6-01 = 1 [Normal Duty Rating]

Use an Analog Input to Change the Stall Prevent Level during Run

When H3-xx = 8 [MFAI Function Select = Stall Prevent Level During Run], you can use the input gain and bias settings for terminals A1 and A2 to change the stall prevention level during run.

If you set the input level for terminals A1 and A2 [H3-xx = 8] and L3-06, the drive will use the smaller value for Stall Prevent Level during Run.

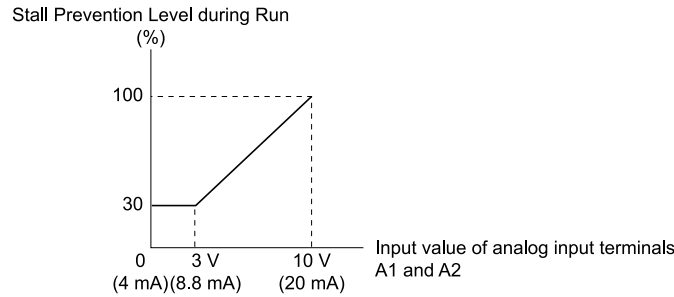

Figure 2.115 Stall Prevention Level during Run with Analog Input

■ L3-11: Overvoltage Suppression Select

No. (Hex.)	Name	Description	Default (Range)
L3-11 (04C7)	Overvoltage Suppression Select	<input type="checkbox"/> V/f <input type="checkbox"/> OLV <input type="checkbox"/> OLV/PM <input type="checkbox"/> AOLV/PM <input type="checkbox"/> EZOLV Sets the overvoltage suppression function.	0 (0, 1)

0 : Disabled

The drive does not adjust the regenerative torque limit or the output frequency. If you apply a regenerative load, the drive can detect an *ov* [Overvoltage] fault. Use this setting with a dynamic braking option.

1 : Enabled

When a regenerative load increases the DC bus voltage, the drive decreases the regenerative torque limit and increases the output frequency to prevent *ov*

■ L3-17: DC Bus Regulation Level

No. (Hex.)	Name	Description	Default (Range)
L3-17 (0462)	DC Bus Regulation Level	<input type="checkbox"/> V/f <input type="checkbox"/> OLV <input type="checkbox"/> OLV/PM <input type="checkbox"/> AOLV/PM <input type="checkbox"/> EZOLV Sets the target value for the DC bus voltage when the overvoltage suppression function and the Decel Stall Prevention function (Intelligent Stall Prevention) are active.	200 V Class: 375 V, 400 V Class: 750 V (200 V Class: 150 to 400 V, 400 V Class: 300 to 800 V)

Note:

This value is initialized when *E1-01* [Input AC Supply Voltage] is changed.

Sets this parameter for any of the following circumstances.

- *L3-11* = 1 [OV Suppression Function Select = Enabled].
- *L3-04* = 2 [Decel Stall Prevention Selection = Automatic Decel Reduction].

■ L3-20: DC Bus Voltage Adjustment Gain

No. (Hex.)	Name	Description	Default (Range)
L3-20 (0465) Expert	DC Bus Voltage Adjustment Gain	<input type="checkbox"/> V/f <input type="checkbox"/> OLV <input type="checkbox"/> OLV/PM <input type="checkbox"/> AOLV/PM <input type="checkbox"/> EZOLV Sets the proportional gain used to control the DC bus voltage.	Determined by A1-02 (0.00 - 5.00)

Set one of these parameters to enable L3-20:

- *L2-29* = 1 [Kinetic Energy Backup Method = Single Drive KEB Ride-Thru 2]
- *L3-04* = 2 [Stall Prevention during Decel = Intelligent (Ignore Decel Ramp)]
- *L3-11* = 1 [Overvoltage Suppression Select = Enabled]
- *H1-xx* = 7A or 7B [MFDI Function Selection = KEB Ride-Thru 2 Activate (N.O./N.C.)]

Note:

- If stall prevention during deceleration function causes *ov* [Overvoltage] and *Uv1* [DC Bus Undervoltage] faults when you start deceleration and $L2-29 = 1$, $H1-xx = 7A$ or $7B$, or $L3-04 = 2$, gradually increase this parameter in 0.1-unit increments. If the setting value is too high, it can cause large speed or current ripples.
- If sudden increases in the regenerative load cause *ov* faults and $L3-11 = 1$, gradually increase this parameter in 0.1-unit increments. If the setting value is too high, it can cause large speed or current ripples.

■ L3-21: OVSUPPRESSION ACCEL/DECCEL P GAIN

No. (Hex.)	Name	Description	Default (Range)
L3-21 (0466) Expert	OVSUPPRESSION ACCEL/DECCEL P Gain	<input type="checkbox"/> V/f <input type="checkbox"/> OLV <input checked="" type="checkbox"/> OLV/PM <input type="checkbox"/> AOLV/PM <input type="checkbox"/> EZOLV Sets the proportional gain to calculate acceleration and deceleration rates.	Determined by A1-02 (0.10 - 10.00)

Set one of these parameters to enable L3-20:

- $L2-29 = 1$ [Kinetic Energy Backup Method = Single Drive KEB Ride-Thru 2]
- $L3-04 = 2$ [Stall Prevention during Decel = Intelligent (Ignore Decel Ramp)]
- $L3-11 = 1$ [Overvoltage Suppression Select = Enabled]
- $H1-xx = 7A$ or $7B$ [MFDI Function Selection = KEB Ride-Thru 2 Activate (N.O./N.C.)]

Note:

- If stall prevention during deceleration function causes large speed or current ripples and $L2-29 = 1$, $H1-xx = 7A$ or $7B$, or $L3-04 = 2$, gradually decrease this parameter in 0.05-unit increments. If the drive detects *ov* [Overvoltage] or *oC* [Overcurrent], decrease L3-21. If you decrease the gain too much, it can cause a delay in control in the DC bus voltage or the deceleration time could be longer than the best deceleration time.
- If sudden increases in the regenerative load cause *ov* faults and $L3-11 = 1$, gradually increase this parameter in 0.1-unit increments. If there are large speed ripples, gradually decrease this parameter in 0.05-unit increments.

■ L3-22: PM STALL PREVENTION DECCEL TIME

No. (Hex.)	Name	Description	Default (Range)
L3-22 (04F9)	PM Stall Prevention Decel Time	<input type="checkbox"/> V/f <input type="checkbox"/> OLV <input checked="" type="checkbox"/> OLV/PM <input type="checkbox"/> AOLV/PM <input type="checkbox"/> EZOLV Sets the momentary deceleration time that the drive will use when it tries to accelerate a PM motor and detected motor stalls. This function is applicable when $L3-01 = 1$ [Stall Prevention during Accel = Enabled].	0.0 s (0.0 - 6000.0 s)

Set this parameter to 0.0 s to disable this function. The drive will decelerates in the deceleration time applicable at the time when a motor stall occurs.

■ L3-23: STALL P REDUCTION AT CONSTANT HP

No. (Hex.)	Name	Description	Default (Range)
L3-23 (04FD)	Stall P Reduction at Constant HP	<input type="checkbox"/> V/f <input type="checkbox"/> OLV <input checked="" type="checkbox"/> OLV/PM <input type="checkbox"/> AOLV/PM <input type="checkbox"/> EZOLV Sets the function to automatically decrease the Stall Prevention Level during Run for constant output ranges.	0 (0, 1)

0 : Use L3-06 for Entire Speed Range

The drive uses the level set in $L3-06$ [Stall Prevent Level during Run] through the full speed range.

1 : Automatic Reduction @ CHP Region

The drive decreases the Stall Prevention level during run in the constant power range. The lower limit is 40% of $L3-06$ value.

■ L3-24: MOTOR ACCEL TIME @ RATED TORQUE

No. (Hex.)	Name	Description	Default (Range)
L3-24 (046E) Expert	Motor Accel Time @ Rated Torque	<input type="checkbox"/> V/f <input type="checkbox"/> OLV <input checked="" type="checkbox"/> OLV/PM <input type="checkbox"/> AOLV/PM <input type="checkbox"/> EZOLV Sets the motor acceleration time to reach the maximum frequency at the motor rated torque for stopped single-drive motors.	Determined by o2-04, C6-01, E2-11, and E5-01 (0.001 - 10.000 s)

Set one of these parameters to enable L3-20:

2.9 L: Protection Functions

- L2-29 = 1 [Kinetic Energy Backup Method = Single Drive KEB Ride-Thru 2]
- L3-04 = 2 [Stall Prevention during Decel = Intelligent (Ignore Decel Ramp)]
- L3-11 = 1 [Overvoltage Suppression Select = Enabled]
- H1-xx = 7A or 7B [MFDI Function Select = KEB Ride-Thru 2 Activate (N.O./N.C.)]

Note:

When Auto-Tuning changes the value of E2-11 [Motor Rated Power (kW)], the drive will automatically set *this parameter* to the value for a Yaskawa standard motor (4 poles). When you use a PM motor, the drive uses the value in E5-01 [PM Motor Code Selection] to change L3-24.

■ L3-25: Load Inertia Ratio

No. (Hex.)	Name	Description	Default (Range)
L3-25 (046F) Expert	Load Inertia Ratio	<input checked="" type="checkbox"/> V/f <input type="checkbox"/> OLV <input type="checkbox"/> OLV/IPM <input type="checkbox"/> AOLV/IPM <input type="checkbox"/> EZOLV Sets the ratio between motor inertia and machine inertia.	1.0 (0.1 - 1000.0)

Set one of these parameters to enable L3-20:

- L2-29 = 1 [Kinetic Energy Backup Method = Single Drive KEB Ride-Thru 2]
- L3-04 = 2 [Stall Prevention during Decel = Intelligent (Ignore Decel Ramp)]
- L3-11 = 1 [Overvoltage Suppression Select = Enabled]
- H1-xx = 7A or 7B [MFDI Function Select = KEB Ride-Thru 2 Activate (N.O./N.C.)]

Note:

- If you set this value incorrectly when L2-29 = 1, H1-xx = 7A or 7B, or L3-11 = 1, it can cause large current ripples and ov [Overvoltage], Uv1 [DC Bus Undervoltage], or oC [Overcurrent] faults.
- KEB Tuning will automatically set this value.

■ L3-26: Additional DC Bus Capacitors

No. (Hex.)	Name	Description	Default (Range)
L3-26 (0455) Expert	Additional DC Bus Capacitors	<input checked="" type="checkbox"/> V/f <input type="checkbox"/> OLV <input type="checkbox"/> OLV/IPM <input type="checkbox"/> AOLV/IPM <input type="checkbox"/> EZOLV Sets the capacity for external main circuit capacitors. Usually it is not necessary to change this setting. Sets this parameter when you use the KEB Ride-Thru function.	0 μF (0 to 65000 μF)

■ L3-27: Stall Prevention Detection Time

No. (Hex.)	Name	Description	Default (Range)
L3-27 (0456)	Stall Prevention Detection Time	<input checked="" type="checkbox"/> V/f <input type="checkbox"/> OLV <input type="checkbox"/> OLV/IPM <input type="checkbox"/> AOLV/IPM <input type="checkbox"/> EZOLV Sets a delay time between reaching the Stall Prevention level and starting the Stall Prevention function.	60 ms (0 - 5000 ms)

■ L3-34: Torque Limit Delay Time

No. (Hex.)	Name	Description	Default (Range)
L3-34 (016F) Expert	Torque Limit Delay Time	<input type="checkbox"/> V/f <input type="checkbox"/> OLV <input type="checkbox"/> OLV/IPM <input checked="" type="checkbox"/> AOLV/IPM <input type="checkbox"/> EZOLV Sets the filter time constant that returns the torque limit to its initial value when KEB operation operates in Single Drive KEB Ride-Thru mode.	Determined by A1-02 (0.000 - 1.000 s)

When vibration occurs during operation of Single Drive KEB Ride-Thru 2, increase this parameter in 0.010-unit increments.

Note:

The Single Drive KEB Ride-Thru 2 mode operates when L2-29 = 1 [KEB Method Selection = Single Drive KEB Ride-Thru 2] and H1-xx = 7A or 7B [Terminal Sx Function Selection = KEB Ride-Thru 2 (N.C./N.O.)].

■ L3-35: Speed Agree Width for Auto Decel

No. (Hex.)	Name	Description	Default (Range)
L3-35 (0747) Expert	Speed Agree Width for Auto Decel	<input type="checkbox"/> V/f <input type="checkbox"/> OLV <input type="checkbox"/> OLV/PM <input type="checkbox"/> AOLV/PM <input type="checkbox"/> EZOLV Sets the width for speed agreement when L3-04 = 2 [Stall Prevention during Decel = Intelligent (Ignore Decel Ramp)]. Usually it is not necessary to change this setting.	0.00 Hz (0.00 - 1.00 Hz)

Set this parameter when hunting occurs while you use a frequency reference through an analog input.

■ L3-36: Current Suppression Gain@Accel

No. (Hex.)	Name	Description	Default (Range)
L3-36 (11D0)	Current Suppression Gain@Accel	<input type="checkbox"/> V/f <input type="checkbox"/> OLV <input type="checkbox"/> OLV/PM <input type="checkbox"/> AOLV/PM <input type="checkbox"/> EZOLV Sets the gain to suppress current and motor speed hunting during operation when L3-01 = 3 [Stall Prevention during Accel = Current Limit Method]. Usually it is not necessary to change this setting.	Determined by A1-02 (0.0 - 100.0)

If there is vibration in the output current during acceleration, increase the setting value.

Note:

Set L3-01 = 3 [Stall Prevention during Accel = Current Limit Method] to enable this function.

■ L3-37: Current Limit P Gain @Accel

No. (Hex.)	Name	Description	Default (Range)
L3-37 (11D1) Expert	Current Limit P Gain @Accel	<input type="checkbox"/> V/f <input type="checkbox"/> OLV <input type="checkbox"/> OLV/PM <input type="checkbox"/> AOLV/PM <input type="checkbox"/> EZOLV Suppresses current hunting during acceleration. Usually it is not necessary to change this setting.	5 ms (0 - 100 ms)

Note:

Set L3-01 = 3 [Stall Prevention during Accel = Current Limit Acceleration] to enable this function.

■ L3-38: Current Limit I Time @ Accel

No. (Hex.)	Name	Description	Default (Range)
L3-38 (11D2) Expert	Current Limit I Time @ Accel	<input type="checkbox"/> V/f <input type="checkbox"/> OLV <input type="checkbox"/> OLV/PM <input type="checkbox"/> AOLV/PM <input type="checkbox"/> EZOLV Suppresses current hunting and overshooting that occurs when the drive stalls during acceleration. Usually it is not necessary to change this setting.	10.0 (0.0 - 100.0)

Note:

Set L3-01 = 3 [Stall Prevention during Accel = Current Limit Method] to enable this function.

■ L3-39: Current Limit Filter Time@Accel

No. (Hex.)	Name	Description	Default (Range)
L3-39 (11D3)	Current Limit Filter Time@Accel	<input type="checkbox"/> V/f <input type="checkbox"/> OLV <input type="checkbox"/> OLV/PM <input type="checkbox"/> AOLV/PM <input type="checkbox"/> EZOLV Sets the time constant to adjust the acceleration rate when L3-01 = 3 [Stall Prevention during Accel = Current Limit Acceleration]. Usually it is not necessary to change this setting.	100.0 ms (1.0 - 1000.0 ms)

Note:

Set L3-01 = 3 [Stall Prevention during Accel = Current Limit Acceleration] to enable this function.

■ L3-40: Current Limit S-Curve @ Acc/Dec

No. (Hex.)	Name	Description	Default (Range)
L3-40 (11D4)	Current Limit S-Curve @ Acc/Dec	<input type="checkbox"/> V/f <input type="checkbox"/> OLV <input type="checkbox"/> OLV/PM <input type="checkbox"/> AOLV/PM <input type="checkbox"/> EZOLV Sets the function to enable and disable the best S-curve characteristic used for current-limited acceleration.	0 (0, 1)

Makes the best motor acceleration rate for start up. If you set this parameter to 1, it will make acceleration smoother, but it can also increase the acceleration time to be longer than the set time. If the drive detects *oC* [Overcurrent] faults immediately after acceleration starts, set this parameter.

0 : Disabled

1 : Enabled

Note:

Set L3-01 = 3 [Stall Prevention during Accel = Current Limit Acceleration] to enable this function.

◆ L4: Speed Detection

L4 parameters set the output of signals to the MFDO terminals, for example frequency agree and speed detection.

■ L4-01: Speed Agree Detection Level

No. (Hex.)	Name	Description	Default (Range)
L4-01 (0499)	Speed Agree Detection Level	<input type="checkbox"/> V/f <input type="checkbox"/> OLV <input type="checkbox"/> OLV/IPM <input type="checkbox"/> AOLV/IPM <input type="checkbox"/> EZOLV Sets the level to detect speed agree or motor speed.	Determined by A1-02 (Determined by A1-02)

Sets the level to detect speed agree or motor speed when H2-01 to H2-03 = 2, 3, 4, 5 [MFDO Function Selection = Speed Agree 1, User-set Speed Agree 1, Frequency Detection 1, Frequency Detection 2].

■ L4-02: Speed Agree Detection Width

No. (Hex.)	Name	Description	Default (Range)
L4-02 (049A)	Speed Agree Detection Width	<input type="checkbox"/> V/f <input type="checkbox"/> OLV <input type="checkbox"/> OLV/IPM <input type="checkbox"/> AOLV/IPM <input type="checkbox"/> EZOLV Sets the width to detect speed agree or motor speed.	Determined by A1-02 (Determined by A1-02)

Sets the width to detect speed agree or motor speed when H2-01 to H2-03 = 2, 3, 4, 5 [MFDO Function Selection = Speed Agree 1, User-set Speed Agree 1, Frequency Detection 1, Frequency Detection 2].

■ L4-03: Speed Agree Detection Level(+/-)

No. (Hex.)	Name	Description	Default (Range)
L4-03 (049B)	Speed Agree Detection Level(+/-)	<input type="checkbox"/> V/f <input type="checkbox"/> OLV <input type="checkbox"/> OLV/IPM <input type="checkbox"/> AOLV/IPM <input type="checkbox"/> EZOLV Sets the level to detect speed agree or motor speed.	Determined by A1-02 (Determined by A1-02)

Sets the level to detect speed agree or motor speed when H2-01 to H2-03 = 13, 14, 15, 16 [MFDO Function Selection = Speed Agree 2, User-set Speed Agree 2, Frequency Detection 3, Frequency Detection 4].

■ L4-04: Speed Agree Detection Width(+/-)

No. (Hex.)	Name	Description	Default (Range)
L4-04 (049C)	Speed Agree Detection Width(+/-)	<input type="checkbox"/> V/f <input type="checkbox"/> OLV <input type="checkbox"/> OLV/IPM <input type="checkbox"/> AOLV/IPM <input type="checkbox"/> EZOLV Sets the width to detect speed agree or motor speed.	Determined by A1-02 (Determined by A1-02)

Sets the width to detect speed agree or motor speed when H2-01 to H2-03 = 13, 14, 15, 16 [MFDO Function Selection = Speed Agree 2, User-set Speed Agree 2, Frequency Detection 3, Frequency Detection 4].

■ L4-05: Fref Loss Detection Selection

No. (Hex.)	Name	Description	Default (Range)
L4-05 (049D)	Fref Loss Detection Selection	<input type="checkbox"/> V/f <input type="checkbox"/> OLV <input type="checkbox"/> OLV/IPM <input type="checkbox"/> AOLV/IPM <input type="checkbox"/> EZOLV Sets the operation when the drive detects a loss of frequency reference.	0 (0, 1)

Enables the detection of a loss of an analog frequency reference when MFAI terminals (A1 and A2) input the frequency reference. Set $H2-01$ to $H2-03 = C$ [$MFDO$ Function Selection = Frequency Reference Loss] to enable this function.

If the frequency reference is less than 10% in 400 ms, the drive detects frequency reference loss.

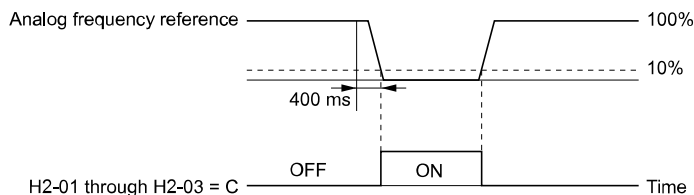

Figure 2.116 Detection of Frequency Reference Loss

0 : Stop

The drive follows the frequency reference and stops the motor.

1 : Run at (L4-06 x Last Reference)

The drive continues to operate at the frequency reference value set in $L4-06$ [$FreqReference$ at Reference Loss]. When you return the external frequency reference value, the drive continues to operate with the frequency reference.

■ L4-06: Frequency Reference @Loss of Ref

No. (Hex.)	Name	Description	Default (Range)
L4-06 (04C2)	Frequency Reference @Loss of Ref	<input type="radio"/> V/f <input checked="" type="radio"/> OLV <input type="radio"/> OLV/PM <input type="radio"/> AOLV/PM <input type="radio"/> EZOLV Sets the frequency reference as a percentage to continue drive operation after it detects a frequency reference loss. The value is a percentage of the frequency reference before the drive detected the loss.	80.0% (0.0 - 100.0%)

Set $L4-05 = 1$ [$FrefLoss$ Detection Selection = Run at (L4-06 x Last Reference)] to enable this parameter.

■ L4-07: Speed Agree Detection Selection

No. (Hex.)	Name	Description	Default (Range)
L4-07 (0470)	Speed Agree Detection Selection	<input type="radio"/> V/f <input checked="" type="radio"/> OLV <input type="radio"/> OLV/PM <input type="radio"/> AOLV/PM <input type="radio"/> EZOLV Sets the condition that activates speed detection.	0 (0, 1)

0 : No Detection during Baseblock

Detects the frequency while the drive is operating. When the drive turns off its output, it will not detect frequency.

1 : Detection Always Enabled

■ L4-08: Speed Agree Source Selection

No. (Hex.)	Name	Description	Default (Range)
L4-08 (047F)	Speed Agree Source Selection	<input type="radio"/> V/f <input checked="" type="radio"/> OLV <input type="radio"/> OLV/PM <input type="radio"/> AOLV/PM <input type="radio"/> EZOLV Sets the drive to use the soft starter output frequency or the motor speed (estimation value) for speed detection.	0 (0, 1)

0 : Softstarter Output (Reference)

1 : Motor Speed (Actual Speed)

The setting for $L4-08$ has an effect:

- When you set detection conditions for $oL3$ [$Overtorque$ 1], $oL3$ [$Overtorque$ Detection 1], $oL4$ [$Overtorque$ 2], and $oL4$ [$Overtorque$ Detection 2]:
 - $L6-01 = 1, 3, 5, 7$ [$Torque$ Detection Selection 1 = UL @ Speed Agree]
 - $L6-04 = 1, 3, 5, 7$ [$Torque$ Detection Selection 2 = UL @ Speed Agree]
- When you use speed agreement with DriveWorksEZ.
- When the MFDI terminals set for $H1-xx = 75, 76$ [$Up/Down$ 2 command] activate.

- When you set *H2-xx [MFDO Function Select]* to these functions:

Setting Value	Function
2	Speed Agree 1
3	User-Set Speed Agree 1
4	Frequency Detection 1
5	Frequency Detection 2

Setting Value	Function
13	Speed Agree 2
14	User-Set Speed Agree 2
15	Frequency Detection 3
16	Frequency Detection 4

- When you use these functions for MEMOBUS monitor data:

Register No.	Description
002CH	Drive Status 2
	bit2 Speed agreement 1: During agreement
	bit3 User-defined speed agreement 1: During agreement
	bit4 Frequency Detection 1 1: Output frequency ≤ L4-01
	bit5 Frequency Detection 2 1: Output frequency ≥ L4-01
004BH	U1-12 [Drive Status]
	bit4 1: During speed agreement

- When you use these functions for monitor parameters:

No. (Hex.)	Name	Description
U1-12 (004B)	Drive Status	bit 4: During speed agreement

◆ L5: Fault Restart

The Auto Restart function tries to keep machines operating when the drive detects a transient fault.

The drive can do a self-diagnostic check and continue the operation after a fault. If the cause of the fault goes away, the drive does speed search and restarts. It will not stop and the drive will not record a fault history. Use *L5-02 [Fault Contact at Restart Select]* to select the operation of fault relay signals during Auto Restart operation.

Sets if the drive will do Auto Restart and the number of times the drive will try to do Auto Restart in a set time. If the number of Auto Restart tries is more than the set value during the set time, drive output shuts off and operation stops. If this happens, remove the cause of the fault and manually restart the drive.

The drive can do Auto Restart when these faults occur:

Note:

You can disable Auto Restart for some faults if you must not restart the machine after the fault with parameters *L5-07* and *L5-08*.

Table 2.61 List of Faults during which Auto Restart is Available

Fault	Name	Parameters to Disable Auto Restart	Fault	Name	Parameters to Disable Auto Restart
GF	Ground Fault	L5-08	oL4	Overtorque Detection 2	L5-07
LF	Output Phase Loss	-	ov	Overvoltage	L5-08
oC	Overcurrent	-	PF	Input Phase Loss	-
oH1	Heatsink Overheat	L5-08	rH	Braking Resistor Overheat	-
oL1	Motor Overload	L5-07	rr	Dynamic Braking Transistor Fault	-
oL2	Drive Overload	L5-07	STPo	Motor Step-Out Detected	-
oL3	Overtorque Detection 1	L5-07	Uv1	DC Bus Undervoltage <i>*/</i>	L5-08

*1 *Uv1* is the target for the auto restart process when *L2-01 = 1, 2, 3, or 4* [*Power Loss Ride Through Select = Enabled for L2-02 Time, Enabled while CPU Power Active, Kinetic Energy Backup: L2-02, or Kinetic Energy Backup: CPU Power*].

■ L5-01: Number of Auto-Restart Attempts

No. (Hex.)	Name	Description	Default (Range)
L5-01 (049E)	Number of Auto-Restart Attempts	V/f OLV OLV/PM AOLV/PM EZOLV Sets the number of times that the drive will try to restart.	0 (0 - 10 times)

The drive resets the number of Auto Restart attempts to 0 in these conditions:

- The drive operates correctly for 10 minutes after a fault restart.
- When you manually clear a fault after the drive triggers protective functions.
- When you re-energize the drive.

■ L5-02: Fault Contact at Restart Select

No. (Hex.)	Name	Description	Default (Range)
L5-02 (049F)	Fault Contact at Restart Select	V/f OLV OLV/PM AOLV/PM EZOLV Sets the function that sends signals to the MFDO terminal set for <i>Fault [H2-xx = E]</i> while the drive is automatically restarting.	0 (0, 1)

0 : Active Only when Not Restarting

1 : Always Active

■ L5-04: Interval Method Restart Time

No. (Hex.)	Name	Description	Default (Range)
L5-04 (046C)	Interval Method Restart Time	V/f OLV OLV/PM AOLV/PM EZOLV Sets the time interval between each Auto Restart attempt. This function is enabled when <i>L5-05 = 1</i> [<i>Auto Restart Operation Selection = Use L5-04 Time</i>].	10.0 s (0.5 - 600.0 s)

■ L5-05: Auto-Restart Method

No. (Hex.)	Name	Description	Default (Range)
L5-05 (0467)	Auto-Restart Method	V/f OLV OLV/PM AOLV/PM EZOLV Sets the count method for the Auto Restart operation.	0 (0, 1)

0 : Continuous/Immediate Attempts

Counts the number of successful fault resets through Auto Restart.

When this value > *L5-01*, the drive will send a fault signal and fault code to the keypad and the motor will coast to stop.

1 : Interval/Attempt after L5-04 sec

Counts the number of all fault resets (successful and unsuccessful) through Auto Restart. The drive repeats the Auto Restart process in the intervals set in *L5-04* [*Interval Method Restart Time*].

When this value > *L5-01*, the drive will send a fault signal and fault code to the keypad and the motor will coast to stop.

■ L5-07: Fault Reset Enable Select Grp1

No. (Hex.)	Name	Description	Default (Range)
L5-07 (0B2A)	Fault Reset Enable Select Grp1	V/f OLV OLV/PM AOLV/PM EZOLV Use these 4 digits to set the Auto Restart function for <i>oL1</i> to <i>oL4</i> . From left to right, the digits set <i>oL1</i> , <i>oL2</i> , <i>oL3</i> , and <i>oL4</i> , in order.	1111 (0000 - 1111)

0000 : Disabled

0001 : Enabled (—/—/—/oL4)

- 0010 : Enabled (—/—/oL3/—)
- 0011 : Enabled (—/—/oL3/oL4)
- 0100 : Enabled (—/oL2/—/—)
- 0101 : Enabled (—/oL2/—/oL4)
- 0110 : Enabled (—/oL2/oL3/—)
- 0111 : Enabled (—/oL2/oL3/oL4)
- 1000 : Enabled (oL1/—/—/—)
- 1001 : Enabled (oL1/—/—/oL4)
- 1010 : Enabled (oL1/—/oL3/—)
- 1011 : Enabled (oL1/—/oL3/oL4)
- 1100 : Enabled (oL1/oL2/—/—)
- 1101 : Enabled (oL1/oL2/—/oL4)
- 1110 : Enabled (oL1/oL2/oL3/—)
- 1111 : Enabled (oL1/oL2/oL3/oL4)

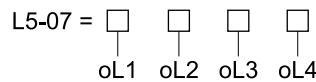

Figure 2.117 Setting Digits and Fault Code

■ L5-08: Fault Reset Enable Select Grp2

No. (Hex.)	Name	Description	Default (Range)
L5-08 (0B2B)	Fault Reset Enable Select Grp2	<div style="display: flex; justify-content: space-between; align-items: center;"> V/f OLV OLV/PM AOLV/PM EZOLV </div> <p>Use these 4 digits to set the Auto Restart function for <i>Uv1</i>, <i>ov</i>, <i>oH1</i>, and <i>GF</i>. From left to right, the digits set <i>Uv1</i>, <i>ov</i>, <i>oH1</i>, and <i>GF</i>, in order.</p>	1111 (0000 - 1111)

- 0000 : Disabled
- 0001 : Enabled (—/—/—/GF)
- 0010 : Enabled (—/—/oH1/—)
- 0011 : Enabled (—/—/oH1/GF)
- 0100 : Enabled (—/ov/—/—)
- 0101 : Enabled (—/ov/—/GF)
- 0110 : Enabled (—/ov/oH1/—)
- 0111 : Enabled (—/ov/oH1/GF)
- 1000 : Enabled (Uv1/—/—/—)
- 1001 : Enabled (Uv1/—/—/GF)
- 1010 : Enabled (Uv1/—/oH1/—)
- 1011 : Enabled (Uv1/—/oH1/GF)
- 1100 : Enabled (Uv1/ov/—/—)
- 1101 : Enabled (Uv1/ov/—/GF)
- 1110 : Enabled (Uv1/ov/oH1/—)
- 1111 : Enabled (Uv1/ov/oH1/GF)

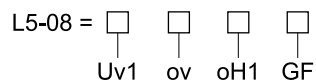

Figure 2.118 Setting Digits and Fault Code

◆ L6: Torque Detection

The overtorque/undertorque detection function prevents damage to machinery and loads.

Overtorque is when there is too much load on the machine. If the motor current or output torque is at the overtorque detection level for the overtorque detection time, the drive will output an alarm and turn off the output.

Undertorque is when a load suddenly decreases. When the motor current or output torque is at the undertorque detection level for the undertorque detection time, the drive will output an alarm and turn off the output.

You can use the undertorque detection function to detect these conditions, for example:

- Machine belt cuts
- Unusual operation of the electromagnetic contactor on the drive output side
- Clogged output side air filters in fans and blowers
- Damage to blade tips and broken string

Note:

If there is *oC* [Overcurrent] or *oL1* [Motor Overload], the drive can stop during overtorque conditions. Use torque detection to identify overload conditions before the drive detects *oC* or *oL1* and stops. Use this function to detect issues that occur in the application.

■ Parameter Settings

You can individually set the two overtorque/undertorque detection functions with the drive. Use the information in [Table 2.62](#) to set the parameters.

Table 2.62 Overtorque/Undertorque Detection Parameters

Configuration Parameter	Overtorque/Undertorque Detection 1	Overtorque/Undertorque Detection 2
MFDO Function Select	H2-01, H2-02, and H2-03 = B	H2-01, H2-02, and H2-03 = 18
• Terminal MA-MC	N.O.: Activated when detected	N.O.: Activated when detected
• Terminal P1-C1	H2-01, H2-02, and H2-03 = 17	H2-01, H2-02, and H2-03 = 19
• Terminal P2-C2	N.C.: Disactivated when detected	N.C.: Disactivated when detected
Detection conditions and selection of operation after detection	L6-01	L6-04
Detection Level	L6-02	L6-05
	Analog Input Terminal ^{*1} H3-xx = 7	-
Detection Time	L6-03	L6-06

*1 You can also use an analog input terminal to supply the torque detection level. To enable this function, set *H3-xx = 7* [MFAI Function Selection = Overtorque/Undertorque DetectLvl]. If both *L6-02* and *H3-xx = 7* are set, the analog input has priority and the setting of *L6-02* is disabled.

You cannot use Overtorque/Undertorque Detection 2 to set the detection level for the analog input terminals.

Note:

In V/f Control, the drive uses the current level (100% of the drive rated output current) to detect overtorque/undertorque. In vector control, the drive uses the motor torque (100% of the motor rated torque) to detect overtorque/undertorque. When you enable the mechanical weakening detection function, the overtorque/undertorque detection level for all control modes is the current level (100% of the drive rated output current).

■ Time Chart for Detection of Overtorque/Undertorque

Overtorque Detection Time Chart

When you use Overtorque/Undertorque Detection 1, the drive detects overtorque if the motor current or motor torque is at the detection level set in *L6-02* [Torque Detection Level 1] for the time set in *L6-03* [Torque Detection Time 1]. Parameter *L6-01* [Torque Detection Selection 1] sets the operation after detection.

When you use Overtorque/Undertorque Detection 2, set *L6-04* [Torque Detection Selection 2], *L6-05* [Torque Detection Level 2], and *L6-06* [Torque Detection Time 2].

Set the terminal that outputs the alarm in *H2-01* to *H2-03* [MFDO Function Select].

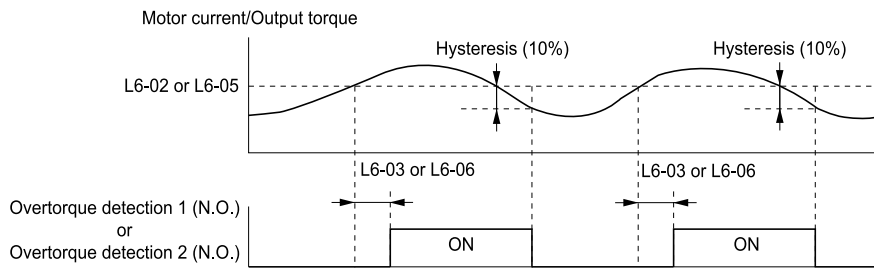

Figure 2.119 Overtorque Detection Time Chart

Note:

The drive applies a hysteresis of approximately 10% of the drive rated output current or the motor rated torque to the overtorque/undertorque detection function.

Undertorque Detection Time Chart

When you use Overtorque/Undertorque Detection 1, the drive detects undertorque if the motor current or motor torque is less than or equal to the detection level set in L6-02 for the time set in L6-03. Parameter L6-01 sets the operation after detection.

When you use Overtorque/Undertorque Detection 2, set the operation in L6-04, L6-05, and L6-06.

Set the terminal that outputs an alarm in H2-01 to H2-03.

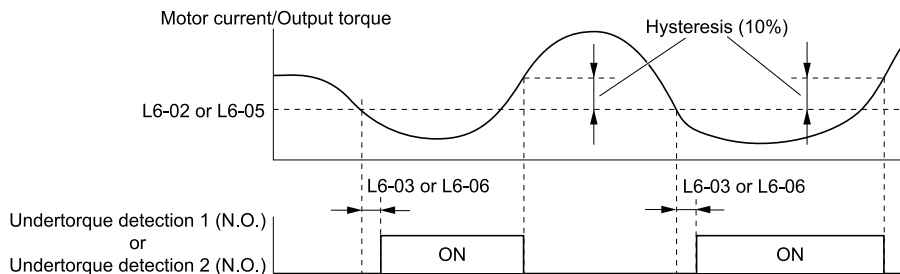

Figure 2.120 Undertorque Detection Time Chart

Note:

The drive applies a hysteresis of approximately 10% of the drive rated output current or the motor rated torque to the overtorque/undertorque detection function.

■ Mechanical Weakening Detection

The Mechanical Weakening Detection function detects the mechanical weakening of a machine that can cause overtorque or undertorque because of motor speed and total drive operation time.

The drive activates the function if the drive total operation time is longer than the time set in L6-11 [Mech Fatigue Hold Off Time]. You can use U4-01 [Cumulative Ope Time] to monitor the total operation time.

Parameter Settings

If overtorque or undertorque occur during the speed range set in L6-08 [Mechanical Fatigue Detect Select] and L6-09 [Mech Fatigue Detect Speed Level] for the length of time set in L6-10 [Mech Fatigue Detect Delay Time], the drive will detect Mechanical Weakening. The drive uses L6-01 to L6-03 [Torque Detection 1 Setting Parameter] to detect oL5 [Mechanical Weakening Detection 1] or UL5 [Mechanical Weakening Detection 2]. Parameter L6-08 sets the operation after detection.

Set the terminal that outputs the fault in H2-01 to H2-03 [MFDO Function Selection].

Table 2.63 Mechanical Weakening Detection Settings Parameters

Configuration Parameter	Mechanical Deterioration Detection
MFDO Function Select • Terminal MA-MC • Terminal P1-C1 • Terminal P2-C2	H2-01, H2-02, and H2-03 = 22
Operation Selection after Detection	L6-08

Configuration Parameter		Mechanical Deterioration Detection
Detection Start Time		L6-11
Speed Range	Detection Criteria	L6-08
	Detection Level	L6-09
	Detection Time	L6-10
Overtorque	Detection Criteria	L6-01
	Detection Level	L6-02
	Detection Time	L6-03

■ L6-01: Torque Detection Selection 1

No. (Hex.)	Name	Description	Default (Range)
L6-01 (04A1)	Torque Detection Selection 1	<div style="display: flex; gap: 5px;"> V/f OLV OLV/PM AOLV/PM EZOLV </div> <p>Sets torque detection conditions that will trigger an overtorque or undertorque response from the drive.</p>	0 (0 - 8)

The drive detects overtorque if the motor current or output torque is more than the level set in *L6-02 [Torque Detection Level 1]* for the length of time set in *L6-03 [Torque Detection Time 1]*. The drive detects undertorque if the motor current or output torque is less than the level set in *L6-02* for the length the time set in *L6-03*.

0 : Disabled

The drive will not detect overtorque or undertorque.

1 : oL @ Speed Agree - Alarm only

The drive detects overtorque when the output frequency aligns with the frequency reference. Detection does not occur during acceleration/deceleration. The drive outputs an *oL3 [Overtorque Detection 1]* and operation continues.

2 : oL @ RUN - Alarm only

When the Run command is enabled, the drive constantly detects overtorque. The drive outputs an *oL3* and operation continues.

3 : oL @ Speed Agree - Fault

The drive detects overtorque when the output frequency aligns with the frequency reference. Detection does not occur during acceleration/deceleration. The drive outputs an *oL3* and operation stops.

4 : oL @ RUN - Fault

When the Run command is enabled, the drive constantly detects overtorque. The drive outputs an *oL3* and operation stops.

5 : UL @ Speed Agree - Alarm only

The drive detects undertorque when the output frequency aligns with the frequency reference. Detection does not occur during acceleration/deceleration. The drive outputs a *UL3 [Undertorque Detection 1]* and operation continues.

6 : UL @ RUN - Alarm only

When the Run command is enabled, the drive constantly detects undertorque. The drive outputs a *UL3* and operation continues.

7 : UL @ Speed Agree - Fault

The drive detects undertorque when the output frequency aligns with the frequency reference. Detection does not occur during acceleration/deceleration. The drive outputs a *UL3* and operation stops.

8 : UL @ RUN - Fault

When the Run command is enabled, the drive constantly detects undertorque. The drive outputs a *UL3* and operation stops.

■ L6-02: Torque Detection Level 1

No. (Hex.)	Name	Description	Default (Range)
L6-02 (04A2)	Torque Detection Level 1	<div style="display: flex; gap: 5px;"> V/f OLV OLV/IPM AOLV/IPM EZOLV </div> Sets the detection level for Overtorque/Undertorque Detection 1. In V/f control, drive rated output current = 100% value. In vector control, motor rated torque = 100% value.	150% (0 - 300%)

Note:

- Set the torque detection level as a percentage of the drive rated output current in all control methods to set the mechanical weakening detection level.
- You can also use an analog input terminal to supply the torque detection level. To enable this function, set $H3-xx = 7$ [MFAI Function Select = Overtorque/Undertorque DetectLvl]. If you set L6-02 and $H3-x = 7$, the analog input is most important and the drive disables L6-02.

■ L6-03: Torque Detection Time 1

No. (Hex.)	Name	Description	Default (Range)
L6-03 (04A3)	Torque Detection Time 1	<div style="display: flex; gap: 5px;"> V/f OLV OLV/IPM AOLV/IPM EZOLV </div> Sets the detection time for Overtorque/Undertorque Detection 1.	0.1 s (0.0 - 10.0 s)

■ L6-04: Torque Detection Selection 2

No. (Hex.)	Name	Description	Default (Range)
L6-04 (04A4)	Torque Detection Selection 2	<div style="display: flex; gap: 5px;"> V/f OLV OLV/IPM AOLV/IPM EZOLV </div> Sets the speed range that detects overtorque and undertorque and the operation of drives (operation status) after detection.	0 (0 - 8)

The drive detects overtorque if the motor current or output torque is more than the level set in L6-05 [Torque Detection Level 2] for the length of time set in L6-06 [Torque Detection Time 2]. The drive detects undertorque if the motor current or output torque is less than the level set in L6-05 for the length the time set in L6-06.

0 : Disabled

The drive will not detect overtorque or undertorque.

1 : oL @ Speed Agree - Alarm only

The drive detects overtorque when the output frequency aligns with the frequency reference. Detection does not occur during acceleration/deceleration. The drive outputs an *oL4* [Overtorque Detection 2] and operation continues.

2 : oL @ RUN - Alarm only

When the Run command is enabled, the drive constantly detects overtorque. The drive outputs an *oL4* and operation continues.

3 : oL @ Speed Agree - Fault

The drive detects overtorque when the output frequency aligns with the frequency reference. Detection does not occur during acceleration/deceleration. The drive outputs an *oL4* [Overtorque Detection 2] and operation stops.

4 : oL @ RUN - Fault

When the Run command is enabled, the drive constantly detects overtorque. The drive outputs an *oL4* and operation stops.

5 : UL @ Speed Agree - Alarm only

The drive detects undertorque when the output frequency aligns with the frequency reference. Detection does not occur during acceleration/deceleration. The drive outputs a *UL4* [Undertorque Detection 2] and operation continues.

6 : UL @ RUN - Alarm only

When the Run command is enabled, the drive constantly detects undertorque. The drive outputs a *UL4* and operation continues.

7 : UL @ Speed Agree - Fault

The drive detects undertorque when the output frequency aligns with the frequency reference. Detection does not occur during acceleration/deceleration. The drive outputs a *UL4* and operation stops.

8 : UL @ RUN - Fault

When the Run command is enabled, the drive constantly detects undertorque. The drive outputs a *UL4* and operation stops

■ L6-05: Torque Detection Level 2

No. (Hex.)	Name	Description	Default (Range)
L6-05 (04A5)	Torque Detection Level 2	V/f OLV OLV/PM AOLV/PM EZOLV Sets the detection level for Overtorque/Undertorque Detection 2. In V/f control, drive rated output current = 100% value. In vector control, motor rated torque = 100% value.	150% (0 - 300%)

Note:

Overtorque/Undertorque Detection 2 cannot set the detection level for the analog input terminal.

■ L6-06: Torque Detection Time 2

No. (Hex.)	Name	Description	Default (Range)
L6-06 (04A6)	Torque Detection Time 2	V/f OLV OLV/PM AOLV/PM EZOLV Sets the detection time for Overtorque/Undertorque Detection 2.	0.1 s (0.0 - 10.0 s)

■ L6-07: Torque Detection Filter Time

No. (Hex.)	Name	Description	Default (Range)
L6-07 (04E5)	Torque Detection Filter Time	V/f OLV OLV/PM AOLV/PM EZOLV Sets the time constant for a primary filter to the torque reference or to the output current used to detect overtorque/undertorque.	0 ms (0 - 1000 ms)

■ L6-08: Mechanical Fatigue Detect Select

No. (Hex.)	Name	Description	Default (Range)
L6-08 (0468)	Mechanical Fatigue Detect Select	V/f OLV OLV/PM AOLV/PM EZOLV Sets the speed where the drive detects mechanical deterioration and how the drive operates (operation status) after detection.	0 (0 - 8)

The drive detects mechanical weakening through overtorque or undertorque as specified by the conditions set in *L6-08 to L6-11* [*Mechanical Deterioration Detection Settings Parameters*]. Set overtorque/undertorque detection conditions in *L6-01 to L6-03* [*Torque Detection 1 Settings Parameters*]. The drive disables the operation selection set in *L6-01* [*Torque Detection Selection 1*].

0 : Disabled

The drive does not detect mechanical weakening.

1 : oL5 @ Speed > L6-09 - Alarm

When the speed (signed) \geq *L6-09* [*Mech Fatigue Detect Speed Level*], the drive detects mechanical weakening. The drive will detect *oL5* [*Mechanical Weakening Detection 1*] and continue operation.

2 : oL5 @ |Speed| > L6-09 - Alarm

When the speed (absolute value) \geq *L6-09*, the drive detects mechanical weakening. The drive will detect *oL5* and continue operation.

3 : oL5 @ Speed > L6-09 - Fault

When the speed (signed) \geq *L6-09*, the drive detects mechanical weakening. The drive will detect *oL5* and stop operation.

4 : oL5 @ |Speed| > L6-09 - Fault

When the speed (absolute value) \geq *L6-09*, the drive detects mechanical weakening. The drive will detect *oL5* and stop operation.

5 : UL5 @ Speed < L6-09 - Alarm

When the speed (signed) \leq *L6-09*, the drive detects mechanical weakening. The drive will detect *UL5* [*Mechanical Weakening Detection 2*] and continue operation.

6 : UL5 @ |Speed| < L6-09 - Alarm

When the speed (absolute value) $\leq L6-09$, the drive detects mechanical weakening. The drive will detect *UL5* and continue operation.

7 : UL5 @ Speed < L6-09 - Fault

When the speed (signed) $\leq L6-09$, the drive detects mechanical weakening. The drive will detect *UL5* and stop operation.

8 : UL5 @ |Speed| < L6-09 - Fault

When the speed (absolute value) $\leq L6-09$, the drive detects mechanical weakening. The drive will detect *UL5* and stop operation.

■ L6-09: Mech Fatigue Detect Speed Level

No. (Hex.)	Name	Description	Default (Range)
L6-09 (0469)	Mech Fatigue Detect Speed Level	<div style="display: flex; gap: 5px;"> V/f OLV OLV/PM AOLV/PM EZOLV </div> Sets the speed level where the drive will operate the mechanical deterioration detection function, as a percentage of the Maximum Output Frequency.	110.0% (-110.0 - 110.0%)

Parameters *L6-01 to L6-03 [Torque Detection 1 Settings Parameters]* set the overtorque/undertorque detection conditions.

When *L6-08 = 2, 4, 6, 8 [Mechanical Fatigue Detect Select = Speed : unsigned]*, the setting value of *L6-09* is the absolute value. When *L6-09* is set to a negative number, the drive processes this value as a positive number.

■ L6-10: Mech Fatigue Detect Delay Time

No. (Hex.)	Name	Description	Default (Range)
L6-10 (046A)	Mech Fatigue Detect Delay Time	<div style="display: flex; gap: 5px;"> V/f OLV OLV/PM AOLV/PM EZOLV </div> Sets the time for mechanical deterioration detection.	0.1 s (0.0 - 10.0 s)

When the detection conditions set in *L6-08 [Mechanical Weakening Detect Ope]* continue for the time set in *L6-10*, the drive will detect mechanical weakening.

■ L6-11: Mech Fatigue Hold Off Time

No. (Hex.)	Name	Description	Default (Range)
L6-11 (046B)	Mech Fatigue Hold Off Time	<div style="display: flex; gap: 5px;"> V/f OLV OLV/PM AOLV/PM EZOLV </div> Sets the time that the drive will start mechanical deterioration detection triggered by the cumulative operation time of the drive.	0 h (0 - 65535 h)

When the total operation time of the drive is more than the value set in *L6-11*, the drive will detect mechanical weakening. Use *U4-01 [Cumulative Ope Time]* to monitor the drive total operation time.

◆ L7: Torque Limit

The torque limit function limits the internal torque reference for the drive to and keeps the torque from the motor constant. This function limits the torque applied to loads and regenerative torque to a value less than a set quantity. This function also prevents damage to machinery and increases the reliability of continuous operation. You can set torque limits individually for the four quadrants, which include torque direction (motoring/regeneration) and direction of motor rotation (forward/reverse). When the torque reference value is at the set torque limit, the MFDO terminal set for *During Torque Limit [H2-xx = 30]* activates.

Note:

- The drive output current limits maximum output torque. The drive limits torque to 150% of the rated output current for Heavy Duty Rating (HD) and to 110% of the rated output current for Normal Duty Rating (ND). The actual output torque is not more than the limits of the drive rated output current when you set the torque limit to a high value.
- When you use torque limits for lifting applications, do not lower the torque limit value too much. When the torque limit function is triggered, falls and rollbacks can occur because of sudden acceleration stops and stalls of the motor.

■ Configuring Settings

Use one of these methods to set torque limits:

- Individually set the four torque limit quadrants using L7-01 to L7-04 [Torque Limit].
- Use MFAI to individually set the four torque limit quadrants. Set H3-02, H3-10 = 10, 11, 12 [MFAI Function Select = Forward Torque Limit, Reverse Torque Limit, Regenerative Torque Limit].
- Use MFAI to set all four torque limit quadrants together. Set H3-02, H3-10 = 15 [General Torque Limit].
- Use a communication option to set all four torque limit quadrants together.

Figure 2.121 shows the configuration method for each quadrant.

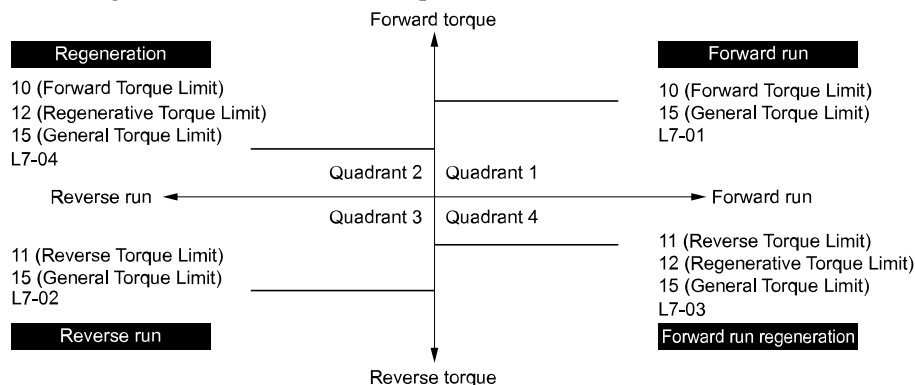

Figure 2.121 Torque Limits and Analog Input Setting Parameters

Note:

- When L7-01 to L7-04 and analog inputs or communication option torque limits set torque limits for the same quadrant, the drive enables the lowest value. In this example of parameter settings, the torque limit for quadrant 1 is 130% and the torque limit for quadrants 2, 3, and 4 is 150%. Settings: L7-01 = 130%, L7-02 to L7-04 = 200%, and MFAI torque limit = 150%
- The drive output current limits maximum output torque. The torque limit is 150% of the rated output current for HD and to 120% of the rated output current for ND. The actual output torque is not more than the limits of the drive rated output current when you set the torque limit to a high value.

■ L7-01: Forward Torque Limit

No. (Hex.)	Name	Description	Default (Range)
L7-01 (04A7) RUN	Forward Torque Limit	<input type="checkbox"/> V/f <input checked="" type="checkbox"/> OLV <input type="checkbox"/> OLV/PM <input type="checkbox"/> AOLV/PM <input type="checkbox"/> EZOLV Sets the torque limit value for forward motoring as a percentage, where motor rated torque is the 100% value.	200% (0 - 300%)

Note:

- The lower torque limit is enabled when you set the torque limit by the following method.
 - Set H3-02 or H3-10 = 10, 15 [MFAI Function Select = Forward Torque Limit, General Torque Limit].
 - Use a communication option to set the torque limits
- You must think about drive capacity when a large quantity of torque is necessary. If you set the value too high, the drive can detect oC [Overcurrent].
- If you set the value too low with large loads, the motor can stall.

■ L7-02: Reverse Torque Limit

No. (Hex.)	Name	Description	Default (Range)
L7-02 (04A8) RUN	Reverse Torque Limit	<input type="checkbox"/> V/f <input checked="" type="checkbox"/> OLV <input type="checkbox"/> OLV/PM <input type="checkbox"/> AOLV/PM <input type="checkbox"/> EZOLV Sets the torque limit value for reversed motoring as a percentage, where motor rated torque is the 100% value.	200% (0 - 300%)

Note:

- The lower torque limit is enabled when you set the torque limit by the following method.
 - Set H3-02 or H3-10 = 10, 15 [MFAI Function Select = Forward, Reverse/Regenerative Torque Limit].
 - Use a communication option to set the torque limits
- You must think about drive capacity when a large quantity of torque is necessary. If you set the value too high, the drive can detect *oC* [Overcurrent].
- If you set the value too low with large loads, the motor can stall.

■ L7-03: Forward Regenerative Trq Limit

No. (Hex.)	Name	Description	Default (Range)
L7-03 (04A9) RUN	Forward Regenerative Trq Limit	<div style="display: flex; gap: 5px;"> V/f OLV OLV/PM AOLV/PM EZOLV </div> Sets the torque limit value for forward regenerative conditions as a percentage of the motor rated torque.	200% (0 - 300%)

Note:

- The lower torque limit is enabled when you set the torque limit by the following method.
 - Set H3-02 or H3-10 = 10, 15 [MFAI Function Select = Forward, Reverse/Regenerative Torque Limit].
 - Use a communication option to set the torque limits
- You must think about drive capacity when a large quantity of torque is necessary. If you set the value too high, the drive can detect *oC* [Overcurrent].
- If you set the value too low with large loads, the motor can stall.

■ L7-04: Reverse Regenerative Trq Limit

No. (Hex.)	Name	Description	Default (Range)
L7-04 (04AA) RUN	Reverse Regenerative Trq Limit	<div style="display: flex; gap: 5px;"> V/f OLV OLV/PM AOLV/PM EZOLV </div> Sets the torque limit value for reversed regenerative conditions as a percentage of the motor rated torque.	200% (0 - 300%)

Note:

- Use this method to set the torque limit and enable the lower torque limit:
 - Set H3-02 or H3-10 = 10, 15 [MFAI Function Select = Forward, Reverse/Regenerative Torque Limit].
 - Use a communication option to set the torque limits
- You must think about drive capacity when a large quantity of torque is necessary. If you set the value too high, the drive can detect *oC* [Overcurrent].
- If you set the value too low with large loads, the motor can stall.

■ L7-06: Torque Limit Integral Time

No. (Hex.)	Name	Description	Default (Range)
L7-06 (04AC)	Torque Limit Integral Time	<div style="display: flex; gap: 5px;"> V/f OLV OLV/PM AOLV/PM EZOLV </div> Sets the integral time constant for the torque limit function.	200 ms (5 - 10000 ms)

Decrease the setting value to increase torque limit responsiveness when you use torque limits and L7-07 = 1 [Torque Limit during Accel/Decel = Proportional & Integral control].

If there is hunting when torque limits are active, increase the setting value.

■ L7-07: Torque Limit during Accel/Decel

No. (Hex.)	Name	Description	Default (Range)
L7-07 (04C9)	Torque Limit during Accel/Decel	<div style="display: flex; gap: 5px;"> V/f OLV OLV/PM AOLV/PM EZOLV </div> Sets the torque limit function during acceleration and deceleration.	0 (0, 1)

0 : Proportional only

The torque limit function works with proportional control during acceleration and deceleration, and switches to integral control at constant speed. Use this setting when quickly reaching the target speed is more important than the torque limit during speed changes.

1 : Proportional & Integral control

The torque limit function always uses integral control. Use this setting when a very accurate torque limit is necessary during speed changes, for example in winding machine applications.

If you make the torque limit the most important, it can:

- Increase the acceleration and deceleration times.
- Not let the motor speed reach the frequency reference value during run at constant speed.

■ L7-16: Torque Limit Process at Start

No. (Hex.)	Name	Description	Default (Range)
L7-16 (044D)	Torque Limit Process at Start	<input type="checkbox"/> V/f <input checked="" type="checkbox"/> OLV <input type="checkbox"/> OLV/PM <input type="checkbox"/> AOLV/PM <input type="checkbox"/> EZOLV Assigns a time filter to allow the torque limit to build at start.	1 (0, 1)

0 : Disabled

There is torque limit at start without a delay time.

Use this setting to maximize the response time when sudden acceleration or deceleration at start is necessary.

1 : Enabled

There is a delay time of 64 ms at start to build the torque limit.

◆ L8: Drive Protection

L8 parameters set protective functions that prevent faults such as overheating, phase loss, and ground faults.

■ L8-01: 3% ERF DB Resistor Protection

No. (Hex.)	Name	Description	Default (Range)
L8-01 (04AD)	3% ERF DB Resistor Protection	<input type="checkbox"/> V/f <input checked="" type="checkbox"/> OLV <input type="checkbox"/> OLV/PM <input type="checkbox"/> AOLV/PM <input type="checkbox"/> EZOLV Sets the function to enable braking resistor protection with a Yaskawa ERF series braking resistor (3% ED) installed on the heatsink.	0 (0, 1)

0 : No

Disables braking resistor protection. Use this setting for dynamic braking options that are not Yaskawa ERF series braking resistors.

1 : Yes

Enables protection for Yaskawa ERF series braking resistors.

Note:

Set L8-01 = 1 and H2-01 to H2-03 = D [MFDO Function Select = Braking Resistor Fault]. Use a sequence to turn OFF power with MFDO.

■ L8-02: Overheat Alarm Level

No. (Hex.)	Name	Description	Default (Range)
L8-02 (04AE)	Overheat Alarm Level	<input type="checkbox"/> V/f <input checked="" type="checkbox"/> OLV <input type="checkbox"/> OLV/PM <input type="checkbox"/> AOLV/PM <input type="checkbox"/> EZOLV Sets the oH detection level in temperature.	Determined by o2-04, C6-01 (50 - 150 °C)

If the heatsink temperature is more than the temperature set in this parameter, the drive detects an overheat pre-alarm. To enable this function, set one of H2-01 to H2-03 [MFDO Function Select] to 20 [Drive Overheat Pre-Alarm (oH)].

If the temperature increases to the overheat fault level, the drive will trigger an oH1 [Heatsink Overheat] fault and stop operation.

■ L8-03: Overheat Pre-Alarm Selection

No. (Hex.)	Name	Description	Default (Range)
L8-03 (04AF)	Overheat Pre-Alarm Selection	<input type="checkbox"/> V/f <input checked="" type="checkbox"/> OLV <input type="checkbox"/> OLV/PM <input type="checkbox"/> AOLV/PM <input type="checkbox"/> EZOLV Sets operation after the drive detects an oH alarm.	3 (0 - 4)

0 : Ramp to Stop

The drive ramps the motor to stop in the deceleration time. The output terminal set for *Fault* [H2-01 to H2-03 = E] activates.

1 : Coast to Stop

The output turns off and the motor coasts to stop. The output terminal set for *Fault* [H2-01 to H2-03 = E] activates.

2 : Fast Stop (Use C1-09)

The drive stops the motor in the deceleration time set in C1-09 [Fast Stop Time]. The output terminal set for *Fault* [H2-01 to H2-03 = E] activates.

3 : Alarm Only

The keypad shows *oH* and the drive continues operation. The output terminal set for *Alarm* [H2-01 to H2-03 = 10] activates.

4 : Operate at Reduced Speed (L8-19)

The drive decelerates to the level set in L8-19 [Freq Reduction @ *oH* Pre-Alarm] and continues operation. *oH* flashes on the keypad.

If the overheat pre-alarm is still ON after 10 s, the drive decelerates again. When the alarm is output, the drive decelerates each 10 seconds. If the drive decelerates 10 times and the alarm continues to be output, the output terminal set for *oH Pre-Alarm Reduction Limit* [H2-01 to H2-03 = 4D] activates. When the alarm is not output during deceleration, the drive accelerates until it is at the frequency reference that was applicable before the alarm was turned off. Figure 2.122 shows the output of the alarm and the drive operation at a decreased output frequency.

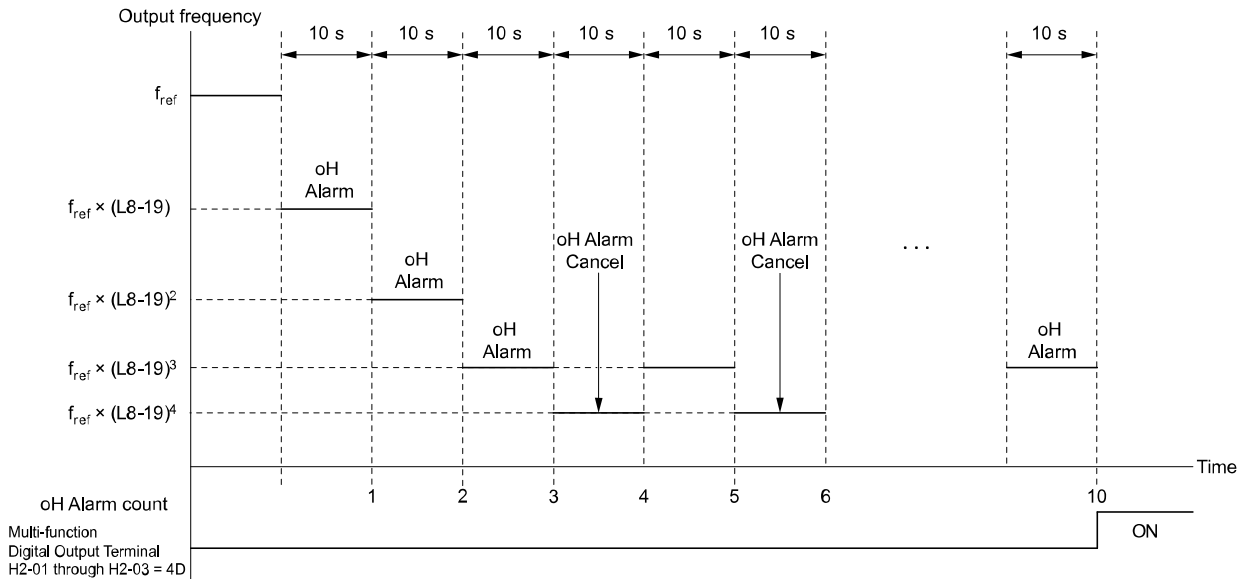

Figure 2.122 Drive Operation at a Decreased Output Frequency when the Overheat Alarm is Output

■ **L8-05: Input Phase Loss Protection Sel**

No. (Hex.)	Name	Description	Default (Range)
L8-05 (04B1)	Input Phase Loss Protection Sel	<input type="checkbox"/> V/f <input type="checkbox"/> OLV <input type="checkbox"/> OLV/PM <input type="checkbox"/> AOLV/PM <input type="checkbox"/> EZOLV Sets the function to enable and disable input phase loss detection.	Determined by o2-04 (Determined by o2-04)

0 : Disabled

1 : Enabled

The drive measures ripples in DC bus voltage to detect input phase loss.

The drive detects phase loss when power supply phase loss occurs or the main circuit capacitor becomes unusable, which causes *PF* [Input Phase Loss] to show on the keypad.

Disable the detection of the input power supply phase loss function in these conditions:

- During deceleration

- The run command is not input
- The output current is less than 30% of the drive rated current.

■ L8-07: Output Phase Loss Protection Sel

No. (Hex.)	Name	Description	Default (Range)
L8-07 (04B3)	Output Phase Loss Protection Sel	<input type="checkbox"/> V/f <input type="checkbox"/> OLV <input type="checkbox"/> OLV/PM <input type="checkbox"/> AOLV/PM <input type="checkbox"/> EZOLV Sets the function to enable and disable output phase loss detection. The drive starts output phase loss detection when the output current decreases to less than 5% of the drive rated current.	1 (0 - 2)

Note:

The drive can incorrectly start output phase loss detection in these conditions:

- The motor rated current is very small compared to the drive rating.
- The drive is operating a PM motor with a small load.

0 : Disabled

1 : Fault when one phase is lost

If the drive loses one output phase, it will trigger *LF [Output Phase Loss]*.

The output turns off and the motor coasts to stop.

2 : Fault when two phases are lost

If the drive loses more than one output phase, it will trigger *LF [Output Phase Loss]*.

The output turns off and the motor coasts to stop.

■ L8-09: Output Ground Fault Detection

No. (Hex.)	Name	Description	Default (Range)
L8-09 (04B5)	Output Ground Fault Detection	<input type="checkbox"/> V/f <input type="checkbox"/> OLV <input type="checkbox"/> OLV/PM <input type="checkbox"/> AOLV/PM <input type="checkbox"/> EZOLV Sets the function to enable and disable ground fault protection.	Determined by o2-04 (0, 1)

0 : Disabled

The drive will not detect ground faults.

1 : Enabled

If there is high leakage current or a ground short circuit in one or two output phases, the drive will detect *GF [Ground Fault]*.

Note:

If the ground path impedance is low, the drive can detect *oC [Overcurrent]*, *SC [Short Circuit/IGBT Failure]*, or *ov [Overvoltage]* instead of *GF*.

■ L8-10: Heatsink Fan Operation Selection

No. (Hex.)	Name	Description	Default (Range)
L8-10 (04B6)	Heatsink Fan Operation Selection	<input type="checkbox"/> V/f <input type="checkbox"/> OLV <input type="checkbox"/> OLV/PM <input type="checkbox"/> AOLV/PM <input type="checkbox"/> EZOLV Sets operation of the heatsink cooling fan.	0 (0 - 2)

0 : During Run, w/ L8-11 Off-Delay

The drive turns on the fan when a Run command is active.

When you release the Run command and the delay time set in *L8-11 [Heatsink Fan Off-Delay Time]* is expired, the fan stops. This setting extends the fan lifetime.

1 : Always On

The fan turns on when you supply power to the drive.

2 : Temperature-Dependent Fan Ctrl.

The fan turns on when the drive detects that the main circuit is overheating.

■ L8-11: Heatsink Fan Off-Delay Time

No. (Hex.)	Name	Description	Default (Range)
L8-11 (04B7)	Heatsink Fan Off-Delay Time	<div style="display: flex; gap: 5px;"> V/f OLV OLV/PM AOLV/PM EZOLV </div> Sets the length of time that the drive will wait before it stops the cooling fan after it cancels the Run command when $L8-10 = 0$ [Heatsink Fan Operation Selection = During Run, w/ L8-11 Off-Delay].	60 s (0 - 300 s)

■ L8-12: Ambient Temperature Setting

No. (Hex.)	Name	Description	Default (Range)
L8-12 (04B8)	Ambient Temperature Setting	<div style="display: flex; gap: 5px;"> V/f OLV OLV/PM AOLV/PM EZOLV </div> Sets the ambient temperature of the drive installation area.	40 °C (-10 °C - +60 °C)

Note:

The setting range changes when the L8-35 [Installation Method Selection] value changes:

- 0 [IP20/UL Open Type]: -10 °C to +60 °C
- 1 [Side-by-Side Mounting]: -10 °C to +50 °C
- 2 [IP20/UL Type 1]: -10 °C to +50 °C
- 3 [External Heatsink/Finless]: -10 °C to +50 °C

The drive automatically adjusts the drive rated current to the best value as specified by the set temperature. Set the ambient temperature of the area where you install the drive to a value that is more than the drive rating.

■ L8-15: Drive oL2 @ Low Speed Protection

No. (Hex.)	Name	Description	Default (Range)
L8-15 (04BB)	Drive oL2 @ Low Speed Protection	<div style="display: flex; gap: 5px;"> V/f OLV OLV/PM AOLV/PM EZOLV </div> Sets the function to decrease the drive overload level at which the drive will trigger oL2 [Drive Overload] during low speed operation (6 Hz or slower) to prevent damage to the main circuit transistors.	1 (0, 1)

Note:

Contact Yaskawa or your nearest sales representative before disabling this function at low speeds. If you frequently operate drives with high output current in low speed ranges, it can cause heat stress and decrease the life span of drive IGBTs.

0 : Disabled (No Additional Derate)

The drive does not decrease the overload protection level.

1 : Enabled (Reduced oL2 Level)

When the drive detects oL2 during low speed operation, it automatically decreases the overload detection level.

At zero speed, the drive derates the overload by 50%.

■ L8-18: Software Current Limit Selection

No. (Hex.)	Name	Description	Default (Range)
L8-18 (04BE)	Software Current Limit Selection	<div style="display: flex; gap: 5px;"> V/f OLV OLV/PM AOLV/PM EZOLV </div> Set the software current limit selection function to prevent damage to the main circuit transistor caused by too much current.	0 (0, 1)

0 : Disabled

When the output current is at the software current limit value, the drive does not restrict the output voltage.

Note:

The drive may detect an oC [Overcurrent] when loads are particularly heavy or the acceleration time is particularly short.

1 : Enabled

When the output current is at the software current limit value, the drive decreases output voltage to decrease output current.

When the output current decreases to the software current limit level, the drive starts usual operation.

■ L8-19: Freq Reduction @ oH Pre-Alarm

No. (Hex.)	Name	Description	Default (Range)
L8-19 (04BF)	Freq Reduction @ oH Pre-Alarm	<input type="checkbox"/> V/f <input type="checkbox"/> OLV <input checked="" type="checkbox"/> OLV/PM <input type="checkbox"/> AOLV/PM <input type="checkbox"/> EZOLV Sets the ratio at which the drive derates the frequency reference during an oH alarm.	0.8 (0.1 - 0.9)

When these two conditions are correct, this function is enabled:

- $L8-03 = 4$ [Overheat Pre-Alarm Ope Selection = Run@L8-19 Rate]
- oH alarm is output

■ L8-27: Overcurrent Detection Gain

No. (Hex.)	Name	Description	Default (Range)
L8-27 (04DD)	Overcurrent Detection Gain	<input type="checkbox"/> V/f <input type="checkbox"/> OLV <input checked="" type="checkbox"/> OLV/PM <input type="checkbox"/> AOLV/PM <input type="checkbox"/> EZOLV Sets the PM motor overcurrent detection level as a percentage of the motor rated current value.	300.0% (0.0 - 1000.0%)

Note:

- If the setting value for L8-27 is the same or almost the same as the setting value for L7-xx [Torque Limit], the drive can detect oC2 [Overcurrent2].
- Set $L8-27 = 0.0$ Hz to disable this function. Usually do not set $L8-27 = 0.0$.
- If the drive rated current is much higher than the motor rated current, PM motor magnets can demagnetize when current flows at the drive overcurrent detection level. When you set a low overcurrent detection level to prevent PM motor demagnetization, make sure that you adjust L8-27.

■ L8-29: Output Unbalance Detection Sel

No. (Hex.)	Name	Description	Default (Range)
L8-29 (04DF)	Output Unbalance Detection Sel	<input type="checkbox"/> V/f <input type="checkbox"/> OLV <input checked="" type="checkbox"/> OLV/PM <input type="checkbox"/> AOLV/PM <input type="checkbox"/> EZOLV Sets the function to detect LF2 [Output Current Imbalance].	1 (0, 1)

This function prevents damage to PM motors. Current unbalance can heat a PM motor and demagnetize the magnets. When the current is unbalanced, the drive will detect LF2 to stop the motor and prevent damage to the motor.

0 : Disabled

1 : Enabled

Note:

You must set $E9-01 = 1$ [Motor Type Selection = Permanent Magnet (PM)] and $A1-02 = 8$ [EZOLV] to show L8-29.

■ L8-31: LF2 Detection Time

No. (Hex.)	Name	Description	Default (Range)
L8-31 (04E1)	LF2 Detection Time	<input type="checkbox"/> V/f <input type="checkbox"/> OLV <input checked="" type="checkbox"/> OLV/PM <input type="checkbox"/> AOLV/PM <input type="checkbox"/> EZOLV Sets the LF2 [Output Current Imbalance] detection time.	3 (1 - 100)

When the output current is unbalanced for longer than the time set in L8-31, the drive detects LF2.

Note:

- Set $L8-29 = 1$ [Output Unbalance Detection Sel = Enabled] to enable L8-31.
- If the drive incorrectly detects LF2, increase L8-31 in 5-unit increments.
- The keypad shows L8-31 when $E9-01 = 1$ [Motor Type Selection = Permanent Magnet (PM)] in EZ Vector Control.

■ L8-35: Installation Method Selection

No. (Hex.)	Name	Description	Default (Range)
L8-35 (04EC)	Installation Method Selection	<input type="checkbox"/> V/f <input type="checkbox"/> OLV <input checked="" type="checkbox"/> OLV/PM <input type="checkbox"/> AOLV/PM <input type="checkbox"/> EZOLV Sets the type of drive installation.	0, 3 (0 - 3)

Note:

- Parameter *A1-03 [Initialize Parameters]* does not initialize this parameter.
- This parameter is set to the correct value when the drive is shipped. Change the value only in these conditions:
 - Side-by-Side installation
 - When you install a UL Type 1 kit on an IP20/UL Open Type drive to convert the drive to an IP20/UL Type 1 drive.
 - Mounting a standard drive with the heatsink outside the enclosure panel.
- Do not change the settings for finless-type drives.

The drive automatically adjusts the overload protection detection level to the best value for each setting value.

0 : IP20/UL Open Type

Use this setting to install IP20/UL Open Type drives.

Make sure that there is 30 mm (1.18 in) minimum of space between drives or between the drive and side of the enclosure panel.

1 : Side-by-Side Mounting

Use this setting to install more than one drive side-by-side.

Note:

You cannot install finless-type drives side-by-side.

2 : IP20/UL Type1

Use this setting to install IP20/UL Type 1 drives.

Note:

You cannot install an IP20/UL Type 1 Kit (optional) on a finless-type drive.

3 : External Heatsink/Finless

Use this setting when the heatsink (cooling fin) is outside the enclosure panel or when you install a finless-type drive.

■ L8-40: Carrier Freq Reduction Off-Delay

No. (Hex.)	Name	Description	Default (Range)
L8-40 (04F1)	Carrier Freq Reduction Off-Delay	<div style="display: flex; gap: 5px;"> V/f OLV OLV/PM AOLV/PM EZOLV </div> <p>Sets the length of time until the automatically reduced carrier frequency returns to the condition before the reduction.</p>	Determined by A1-02 (0.00 - 2.00 s)

Set *L8-40* $\neq 0.00$ to enable the carrier frequency reduction function during start-up. When operation starts, the drive automatically decreases the carrier frequency. When the time set in *L8-40* is expired, the carrier frequency returns to the value set in *C6-02 [Carrier Frequency Selection]*.

■ L8-41: High Current Alarm Selection

No. (Hex.)	Name	Description	Default (Range)
L8-41 (04F2)	High Current Alarm Selection	<div style="display: flex; gap: 5px;"> V/f OLV OLV/PM AOLV/PM EZOLV </div> <p>Sets the function to cause an <i>HCA [Current Alarm]</i> when the output current is more than 150% of the drive rated current.</p>	0 (0, 1)

0 : No

The drive will not detect *HCA*.

1 : Yes

If the output current is more than 150% of the drive rated current, the drive will detect *HCA*.

The MFDO terminal set for an *Alarm [H2-01 to H2-03 = 10]* activates.

■ L8-51: STPo I Detection Level

No. (Hex.)	Name	Description	Default (Range)
L8-51 (0471) Expert	STPo I Detection Level	<div style="display: flex; gap: 5px;"> V/f OLV OLV/PM AOLV/PM EZOLV </div> <p>Sets the <i>STPo [Motor Step-Out Detected]</i> detection level as a percentage of the motor rated current.</p>	0.0% (0.0 - 300.0%)

Note:

The detection level is automatically calculated when $L8-51 = 0$.

■ L8-52: STPo Integration Level

No. (Hex.)	Name	Description	Default (Range)
L8-52 (0472) Expert	STPo Integration Level	V/f OLV OLV/PM AOLV/PM EZOLV Sets the detection level for STPo [Motor Step-Out Detected] related to the ACR integral value.	1.0 (0.1 - 2.0)

■ L8-53: STPo Integration Time

No. (Hex.)	Name	Description	Default (Range)
L8-53 (0473) Expert	STPo Integration Time	V/f OLV OLV/PM AOLV/PM EZOLV Sets the length of time until the drive detects STPo after it is more than the value of L8-51 [STPo I Detection Level].	1.0 s (1.0 - 10.0 s)

■ L8-54: STPo Id Diff Detection

No. (Hex.)	Name	Description	Default (Range)
L8-54 (0474) Expert	STPo Id Diff Detection	V/f OLV OLV/PM AOLV/PM EZOLV Sets the Id deviation detection function for STPo [Motor Step-Out Detected].	1 (0, 1)

0 : Disabled

1 : Enabled

■ L8-55: Internal DB TransistorProtection

No. (Hex.)	Name	Description	Default (Range)
L8-55 (045F)	Internal DB TransistorProtection	V/f OLV OLV/PM AOLV/PM EZOLV Sets the protection function for the internal braking transistor.	1 (0, 1)

0 : Disable

Disables braking transistor protection.

Use this setting, if enabling the braking transistor can cause an rF [Braking Resistor Fault] in these conditions:

- With a regenerative converter, for example D1000.
- With a regenerative unit, for example R1000.
- When connecting braking resistor options to the drive, for example CDBR units.
- Without an internal braking transistor.

1 : Protection Enabled

Protects internal braking transistor when using a braking transistor or optional braking resistors.

■ L8-56: Stall P @ Accel Activation Time

No. (Hex.)	Name	Description	Default (Range)
L8-56 (047D) Expert	Stall P @ Accel Activation Time	V/f OLV OLV/PM AOLV/PM EZOLV Sets the length time that the acceleration stall prevention function can continue to operate before the drive detects an STPo [Motor Step-Out Detected].	5000 ms (100 - 5000 ms)

Note:

If this value is too small, it can cause incorrect detection of STPo. If this value is too large, the drive will not detect STPo.

■ L8-57: Stall Prevention Retry Counts

No. (Hex.)	Name	Description	Default (Range)
L8-57 (047E) Expert	Stall Prevention Retry Counts	<div style="display: flex; justify-content: space-between; align-items: center;"> V/f OLV OLV/PM AOLV/PM EZOLV </div> <p>Sets the number of times the acceleration stall prevention function can operate until speeds agree before the drive detects an <i>STPo</i> [Motor Step-Out Detected].</p>	10 (1 - 10 times)

Note:

If this value is too small, it can cause incorrect detection of *STPo*. If this value is too large, the drive will not detect *STPo*.

■ L8-90: STPo Detection Level (Low Speed)

No. (Hex.)	Name	Description	Default (Range)
L8-90 (0175) Expert	STPo Detection Level (Low Speed)	<div style="display: flex; justify-content: space-between; align-items: center;"> V/f OLV OLV/PM AOLV/PM EZOLV </div> <p>Sets the detection level that the control fault must be equal to or more than to cause an <i>STPo</i> [Motor Step-Out Detected].</p>	Determined by A1-02 (0 - 5000 times)

This function detects when PM motors are not synchronized.

The drive cannot detect when motors are not synchronized because the frequency reference is low during start up and the motor is locked. If fault detection is necessary in these conditions, set the control fault detection level to enable detection of desynchronization because of motor locking. Increase the setting in 5-unit increments.

■ L8-93: Low Speed Pull-out DetectionTime

No. (Hex.)	Name	Description	Default (Range)
L8-93 (073C) Expert	Low Speed Pull-out DetectionTime	<div style="display: flex; justify-content: space-between; align-items: center;"> V/f OLV OLV/PM AOLV/PM EZOLV </div> <p>Sets the length of time the drive will wait to start baseblock after detecting <i>LSo</i> [Low Speed Motor Step-Out].</p>	1.0 s (0.0 - 10.0 s)

Set this parameter to 0.0 to disable the function.

■ L8-94: Low Speed Pull-out Detect Level

No. (Hex.)	Name	Description	Default (Range)
L8-94 (073D) Expert	Low Speed Pull-out Detect Level	<div style="display: flex; justify-content: space-between; align-items: center;"> V/f OLV OLV/PM AOLV/PM EZOLV </div> <p>Sets the detection level for <i>LSo</i> [Low Speed Motor Step-Out] as a percentage of <i>E1-04</i> [Maximum Output Frequency].</p>	3% (0 - 10%)

■ L8-95: Low Speed Pull-out Amount

No. (Hex.)	Name	Description	Default (Range)
L8-95 (077F) Expert	Low Speed Pull-out Amount	<div style="display: flex; justify-content: space-between; align-items: center;"> V/f OLV OLV/PM AOLV/PM EZOLV </div> <p>Sets the average count of <i>LSo</i> [Low Speed Motor Step-Out] detections.</p>	10 (1 - 50 times)

2.10 n: Special Adjustment

n parameters set these functions:

- Function to prevent hunting
- High-slip braking
- Motor line-to-line resistance online tuning
- Fine-tune the parameters that adjust motor control

◆ n1: Hunting Prevention

The Hunting Prevention function will not let low inertia or operation with a light load cause hunting. Hunting frequently occurs when you have a high carrier frequency and an output frequency less than 30 Hz.

■ n1-01: Hunting Prevention Selection

No. (Hex.)	Name	Description	Default (Range)
n1-01 (0580)	Hunting Prevention Selection	<input checked="" type="radio"/> V/f <input type="radio"/> OLV <input type="radio"/> OLV/PM <input type="radio"/> AOLV/PM <input type="radio"/> EZOLV Sets the function to prevent hunting.	0 (0, 1)

Note:

When you replace a V1000-series drive with a GA500 drive, set $n1-01 = 1$ [Hunting Prevention Selection = Enabled].

When drive response is more important than the decrease of motor vibration, disable this function.

0 : Disable

1 : Enabled

■ n1-02: Hunting Prevention Gain Setting

No. (Hex.)	Name	Description	Default (Range)
n1-02 (0581) Expert	Hunting Prevention Gain Setting	<input checked="" type="radio"/> V/f <input type="radio"/> OLV <input type="radio"/> OLV/PM <input type="radio"/> AOLV/PM <input type="radio"/> EZOLV Sets the performance of the hunting prevention function. Usually it is not necessary to change this parameter.	1.00 (0.00 - 2.50)

Adjust this parameter in these conditions:

- When $n1-01 = 1$ [Hunting Prevention Selection = Enabled (Normal)], if oscillation occurs when you operate a motor with a light load, increase the setting value in 0.1-unit increments.
- When $n1-01 = 2$, if the motor stalls, decrease the setting value in 0.1-unit increments.

■ n1-03: Hunting Prevention Time Constant

No. (Hex.)	Name	Description	Default (Range)
n1-03 (0582) Expert	Hunting Prevention Time Constant	<input checked="" type="radio"/> V/f <input type="radio"/> OLV <input type="radio"/> OLV/PM <input type="radio"/> AOLV/PM <input type="radio"/> EZOLV Sets the primary delay time constant of the hunting prevention function. Usually it is not necessary to change this parameter.	Determined by o2-04 (0 - 500 ms)

Adjust this parameter in these conditions:

- Load inertia is large: Increase the setting value. If the setting value is too high, response will be slower. Also, there will be oscillation when the frequency is low.
- Oscillation occurs at low frequencies: Decrease the setting value.

■ n1-05: Hunting Prevent Gain in Reverse

No. (Hex.)	Name	Description	Default (Range)
n1-05 (0530) Expert	Hunting Prevent Gain in Reverse	<input checked="" type="radio"/> V/f <input type="radio"/> OLV <input type="radio"/> OLV/PM <input type="radio"/> AOLV/PM <input type="radio"/> EZOLV Sets the performance of the hunting prevention function. This parameter adjusts Reverse run. Usually it is not necessary to change this parameter.	0.00 (0.00 - 2.50)

Note:

When you set $n1-05 = 0$, the value set in $n1-02$ [Hunting Prevention Gain Setting] is effective when the motor rotates in reverse.

Adjust this parameter in these conditions:

- When $n1-01 = 1$ [Hunting Prevention Selection = Enabled (Normal)], if oscillation occurs when you operate a motor with a light load, increase the setting value in 0.1-unit increments.
- When $n1-01 = 2$, if the motor stalls, decrease the setting value in 0.1-unit increments.

■ **n1-13: DC Bus Stabilization Control**

No. (Hex.)	Name	Description	Default (Range)
n1-13 (1B59) Expert	DC Bus Stabilization Control	<div style="display: flex; gap: 5px;"> V/f OLV OLV/PM AOLV/PM EZOLV </div> Sets the oscillation suppression function for the DC bus voltage.	0 (0, 1)

0 : Disabled

1 : Enabled

Note:

If the DC bus voltage does not become stable with light loads and the drive detects *ov* [Overvoltage], set this parameter to 1.

■ **n1-14: DC Bus Stabilization Time**

No. (Hex.)	Name	Description	Default (Range)
n1-14 (1B5A) Expert	DC Bus Stabilization Time	<div style="display: flex; gap: 5px;"> V/f OLV OLV/PM AOLV/PM EZOLV </div> Adjusts the responsiveness of the oscillation suppression function for the DC bus voltage. Set $n1-13 = 1$ [DC Bus Stabilization Control = Enabled] to enable this parameter.	100.0 ms (50.0 - 500.0 ms)

Note:

Adjust this parameter in 100 ms increments.

◆ **n2: Auto Freq Regulator (AFR)**

The speed feedback detection reduction function (or AFR: Automatic Frequency Regulator) helps the speed become stable when you suddenly apply or remove a load.

Note:

Before you change $n2-xx$ parameters, do one of these procedures:

- Set the motor parameters and V/f pattern correctly.
- Do Rotational Auto-Tuning.

■ **n2-01: Automatic Freq Regulator Gain**

No. (Hex.)	Name	Description	Default (Range)
n2-01 (0584)	Automatic Freq Regulator Gain	<div style="display: flex; gap: 5px;"> V/f OLV OLV/PM AOLV/PM EZOLV </div> Sets the gain of the AFR function as a magnification value. Usually it is not necessary to change this setting.	1.00 (0.00 - 10.00)

Adjust this parameter in these conditions:

- If hunting or oscillation occurs with light loads, increase the setting value in 0.05-unit increments and examine the response.
- When torque is not sufficient with heavy loads or to make the torque or speed response better, decrease the setting value in 0.05-unit increments and examine the response.

■ n2-02: Automatic Freq Regulator Time 1

No. (Hex.)	Name	Description	Default (Range)
n2-02 (0585)	Automatic Freq Regulator Time 1	<div style="display: flex; justify-content: space-between; border-bottom: 1px solid black; margin-bottom: 5px;"> V/f OLV OLV/PM AOLV/PM EZOLV </div> Sets the time constant that sets the rate of change for the AFR function. Usually it is not necessary to change this setting.	50 ms (0 - 2000 ms)

Adjust this parameter in these conditions:

- If there is hunting or oscillation with a light load, increase the setting value in 50 ms increments and examine the response. If the load inertia is large, increase the setting value in 50 ms increments and examine the response.
- If torque is not sufficient with a heavy load or if you must increase torque or speed responsiveness, decrease the setting value in 10 ms increments and examine the response.

Note:

- Set $n2-02 \leq n2-03$ [Automatic Freq Regulator Time 2]. If $n2-02 > n2-03$, the drive will detect *oPE08* [Parameter Selection Error].
- When you change the value in $n2-02$, also change the value in $C4-02$ [Torque Compensation Delay Time] by the same ratio.

■ n2-03: Automatic Freq Regulator Time 2

No. (Hex.)	Name	Description	Default (Range)
n2-03 (0586)	Automatic Freq Regulator Time 2	<div style="display: flex; justify-content: space-between; border-bottom: 1px solid black; margin-bottom: 5px;"> V/f OLV OLV/PM AOLV/PM EZOLV </div> Sets the time constant that sets the speed difference of the AFR function. Use this parameter for speed searches or regeneration. Usually it is not necessary to change this setting.	750 ms (0 - 2000 ms)

Adjust this parameter in these conditions:

- If the drive detects *ov* [Overvoltage] when acceleration stops under high-inertia loads, increase the setting value in 50 ms increments.
If the drive detects *ov* when the load changes suddenly, increase the setting value in 50 ms increments.
- To increase the responsiveness of torque and speed, decrease the setting value in 10 ms increments and examine the response.

Note:

- Set $n2-02 \leq n2-03$ [Automatic Freq Regulator Time 2]. If $n2-02 > n2-03$, the drive will detect *oPE08* [Parameter Selection Error].
- When you change the value in $n2-03$, also change the value in $C4-06$ [Motor 2 Torque Comp Delay Time] by the same ratio.

◆ n3: High Slip Braking (HSB) and Overexcitation Braking

$n3$ parameters configure High Slip Braking and Overexcitation Deceleration.

■ High Slip Braking (HSB)

High slip braking quickly decelerates motors without braking resistors.

This lets you stop a motor more quickly than with the ramp to stop processes. This function is best for applications that do not frequently stop the motor, for example the fast stop function for high-inertia loads. Braking starts when the MFDD for *High Slip Braking (HSB) Activate* [$H1-xx = 68$] activates.

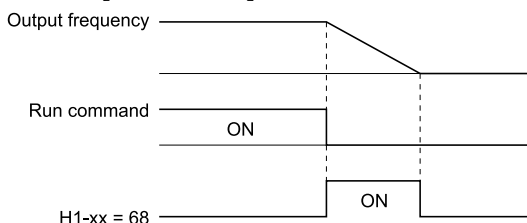

Figure 2.123 High Slip Braking Time Chart

An induction motor is necessary to use high slip braking. Set $A1-02 = 0$ [Control Method Selection = *V/f Control*] to enable high slip braking:

Principles of Operation

HSB increases motor slip by significantly decreasing the frequency supplied to the motor at the same time that deceleration starts. A large quantity of current flows through the motor to increase the motor loss, and the motor decelerates while the motor windings consume the regenerative energy.

The drive keeps the motor current at a constant level during deceleration to prevent overvoltage and do automatic braking and it also keeps a slip level that causes the maximum quantity of deceleration torque.

High Slip Braking Precautions

- Do not use the high slip braking function in these applications:
 - Frequent deceleration
 - Deceleration time differences
 - Continuous regenerative loads
 - It is necessary to accelerate again during deceleration
- Motor loss increases during high slip braking. Use this function when the duty time factor is 5% ED or less and the braking time is 90 seconds or less. The load inertia and motor characteristics have an effect on the braking time.
- The drive ignores the configured deceleration time during high slip braking. To stop motors in the configured deceleration time, set $L3-04 = 4$ [*Stall Prevention during Decel = Overexcitation/High Flux*].
- You cannot use high slip braking to decelerate deceleration at user-defined speeds. To decelerate at user-defined speeds, use the overexcitation deceleration function.
- You cannot accelerate the motor again during high slip braking until you fully stop the motor and input the Run command again.
- You cannot use high slip braking and the KEB Ride-Thru function at the same time. If you enable those two functions, the drive will detect *oPE03* [*Multi-Function Input Setting Err*].

■ Overexcitation Deceleration

Overexcitation deceleration quickly decelerates motors without braking resistors.

This lets you stop a motor more quickly than with the ramp to stop processes.

Overexcitation deceleration increases excitation current during deceleration to cause a large quantity of braking torque through motor overexcitation.

You can set the deceleration speed to adjust the deceleration time for overexcitation deceleration. Overexcitation deceleration lets you accelerate the motor again during deceleration. Enter the Run command during overexcitation deceleration to cancel overexcitation deceleration and accelerate the drive to the specified speed.

To enable this function, set $L3-04 = 4, 5$ [*Stall Prevention during Decel = Overexcitation/High Flux, Overexcitation/High Flux 2*].

When $L3-04 = 4$, the motor will decelerate for the *Deceleration Times* [*C1-02, C1-04, C1-06, or C1-08*]. If the drive detects *ov* [*Overvoltage*], increase the deceleration time.

When $L3-04 = 5$, the drive uses the value in *C1-02, C1-04, C1-06, or C1-08* to decelerate and it adjusts the deceleration rate to keep the DC bus voltage at the level set in $L3-17$ [*DC Bus Regulation Level*]. The load inertia and motor characteristics have an effect on the braking time.

Notes on Overexcitation Deceleration

- Do not use Overexcitation Deceleration with a braking resistor.
- Do not use Overexcitation Deceleration for these applications. Connect a braking resistor to the drive as an alternative to Overexcitation Deceleration.
 - Frequent sudden decelerations
 - Continuous regenerative loads
 - Low inertia machines
 - Machines that have no tolerance for torque ripples
- Motor loss increases during overexcitation deceleration. Use this function when the duty time factor is 5% ED or less and the braking time is 90 seconds or less. The load inertia and motor characteristics have an effect on the braking time.

- You can use overexcitation deceleration in OLV control, but this control method decreases the precision of torque control and braking efficiency. Use V/f control for the best results.
- The drive disables these functions during braking with Overexcitation Deceleration 2:
 - Hunting Prevention Function (V/f Control)
 - Torque Limit Speed Control (OLV Control)

■ n3-01: HSB Deceleration Frequency Width

No. (Hex.)	Name	Description	Default (Range)
n3-01 (0588) Expert	HSB Deceleration Frequency Width	<div style="display: flex; justify-content: space-between; align-items: center;"> V/f OLV OLV/PM AOLV/PM EZOLV </div> <p>Sets the amount by which the output frequency is to be lowered during high-slip braking, as a percentage of <i>E1-04 [Maximum Output Frequency]</i>, which represents the 100% value.</p>	5% (1 - 20%)

When you must detect *ov [DC Bus Overvoltage]* during high-slip braking, set this parameter to a large value.

■ n3-02: HSB Current Limit Level

No. (Hex.)	Name	Description	Default (Range)
n3-02 (0589) Expert	HSB Current Limit Level	<div style="display: flex; justify-content: space-between; align-items: center;"> V/f OLV OLV/PM AOLV/PM EZOLV </div> <p>Sets the maximum current output during high-slip braking as a percentage, where <i>E2-01 [Motor Rated Current (FLA)]</i> is 100%. Also set the current suppression to prevent exceeding drive overload tolerance.</p>	Determined by C6-01 (0 - 150%)

Note:

The upper limit to the setting range changes when the setting for *C6-01 [Normal / Heavy Duty Selection]* changes.

- 150% when *C6-01 = 0 [Heavy Duty Rating]*
- 120% when *C6-01 = 1 [Normal Duty Rating]*

When you decrease the setting value for current suppression, it will make the deceleration time longer.

- When you must detect *ov [DC Bus Overvoltage]* during high-slip braking, set this parameter to a low value.
- If the motor current increases during high-slip braking, decrease the setting value to prevent burn damage in the motor.
- The overload tolerance for the drive is 150% for Heavy Duty Rating (HD) and 110% for Normal Duty Rating (ND).

■ n3-03: HSB Dwell Time at Stop

No. (Hex.)	Name	Description	Default (Range)
n3-03 (058A) Expert	HSB Dwell Time at Stop	<div style="display: flex; justify-content: space-between; align-items: center;"> V/f OLV OLV/PM AOLV/PM EZOLV </div> <p>Sets the dwell time, a length of time when high-slip braking is ending and during which the motor speed decreases and runs at a stable speed. For a set length of time, the drive will hold the actual output frequency at the minimum output frequency set in <i>E1-09</i>.</p>	1.0 s (0.0 - 10.0 s)

If there is too much inertia or when the motor is coasting to a stop after high-slip braking is complete, increase the setting value. If the setting value is too low, machine inertia can cause the motor to rotate after high-slip braking is complete.

■ n3-04: HSB Overload Time

No. (Hex.)	Name	Description	Default (Range)
n3-04 (058B) Expert	HSB Overload Time	<div style="display: flex; justify-content: space-between; align-items: center;"> V/f OLV OLV/PM AOLV/PM EZOLV </div> <p>Sets the time used to detect <i>oL7 [High Slip Braking Overload]</i>, which occurs when the output frequency does not change during high-slip braking. Usually it is not necessary to change this parameter.</p>	40 s (30 - 1200 s)

If a force on the load side is rotating the motor or if there is too much load inertia connected to the motor, the drive will detect *oL7*.

The current flowing to the motor from the load can overheat the motor and cause burn damage to the motor. Set this parameter to prevent burn damage to the motor.

■ n3-13: OverexcitationBraking (OEB) Gain

No. (Hex.)	Name	Description	Default (Range)
n3-13 (0531)	OverexcitationBraking (OEB) Gain	<div style="display: flex; gap: 5px;"> V/f OLV OLV/PM AOLV/PM EZOLV </div> Sets the gain value that the drive multiplies by the V/f pattern output value during overexcitation deceleration to calculate the overexcitation level.	1.10 (1.00 - 1.40)

The V/f pattern output value goes back to its usual level after the motor stops or accelerates again to the frequency reference speed.

The best value of this parameter changes when the flux saturation characteristics of the motor change.

- Gradually increase the value of *n3-13* to 1.25 or 1.30 to increase the braking power of Overexcitation Deceleration. If the gain is too much, the motor can have flux saturation and cause a large quantity of current to flow.
- This can increase the deceleration time. Decrease the setting value if flux saturation causes overcurrent. If you increase the setting value, the drive can detect *oC* [Overcurrent], *oL1* [Motor Overload], and *oL2* [Drive Overload]. Decrease the value of *n3-21* [HSB Current Suppression Level] to prevent *oC* and *oL*.
- If you use overexcitation deceleration frequently or if you use overexcitation deceleration for an extended period of time, it can increase motor temperature. Decrease the setting value in these conditions.
- If *ov* [Overvoltage] occurs, increase the deceleration time.

■ n3-14: OEB High Frequency Injection

No. (Hex.)	Name	Description	Default (Range)
n3-14 (0532) Expert	OEB High Frequency Injection	<div style="display: flex; gap: 5px;"> V/f OLV OLV/PM AOLV/PM EZOLV </div> Sets the function that injects harmonic signals during overexcitation deceleration.	0 (0, 1)

Enable this parameter to set a shorter deceleration time.

Note:

- If you frequently use overexcitation deceleration on a motor, the motor loss will increase the risk of burn damage.
- When you set this parameter to 1, the motor can make a loud excitation sound during overexcitation deceleration. If the excitation sound is unwanted, set this parameter to 0 to disable the function.

0 : Disabled

1 : Enabled

The drive injects harmonic signals at the time of overexcitation deceleration. You can decrease the deceleration time because motor loss increases.

■ n3-21: HSB Current Suppression Level

No. (Hex.)	Name	Description	Default (Range)
n3-21 (0579)	HSB Current Suppression Level	<div style="display: flex; gap: 5px;"> V/f OLV OLV/PM AOLV/PM EZOLV </div> Sets the upper limit of the current that is suppressed at the time of overexcitation deceleration as a percentage of the drive rated current.	100% (0 - 150%)

If flux saturation during Overexcitation Deceleration makes the motor current become more than the value set in *n3-21*, the drive will automatically decrease the overexcitation gain. If *oC* [Overcurrent], *oL1* [Motor Overload], or *oL2* [Drive Overload] occur during overexcitation deceleration, decrease the setting value.

If repetitive or long overexcitation deceleration cause the motor to overheat, decrease the setting value.

■ n3-23: Overexcitation Braking Operation

No. (Hex.)	Name	Description	Default (Range)
n3-23 (057B)	Overexcitation Braking Operation	<div style="display: flex; gap: 5px;"> V/f OLV OLV/PM AOLV/PM EZOLV </div> Sets the direction of motor rotation where the drive will enable overexcitation.	0 (0 - 2)

0 : Disabled

1 : Enabled Only when Rotating FWD

2 : Enabled Only when Rotating REV

Note:

When $n3-23 = 1, 2$, the drive enables overexcitation only in the direction of motor rotation in which a regenerative load is applied. Increased motor loss can decrease *ov* [Overvoltage] faults.

◆ n5: Feed Forward Control

Feed forward control increases the responsiveness of acceleration and deceleration as specified by the speed reference.

Increase the values set in *C5-01* and *C5-03* [ASR Proportional Gain] to apply feed forward control to machines that have low rigidity and are possible to have hunting and vibration or to machines that have a large quantity of inertia. Refer to [Figure 2.124](#) for more information about parameters related to feed forward control.

Set *A1-02* = 6 [Control Method Selection = Advanced Open Loop Vector Control for PM] to enable feed forward control.

Note:

- You cannot use feed forward control to increase responsiveness in applications where you apply loads externally during run at constant speed.
- You cannot use feed forward control with motor 2.

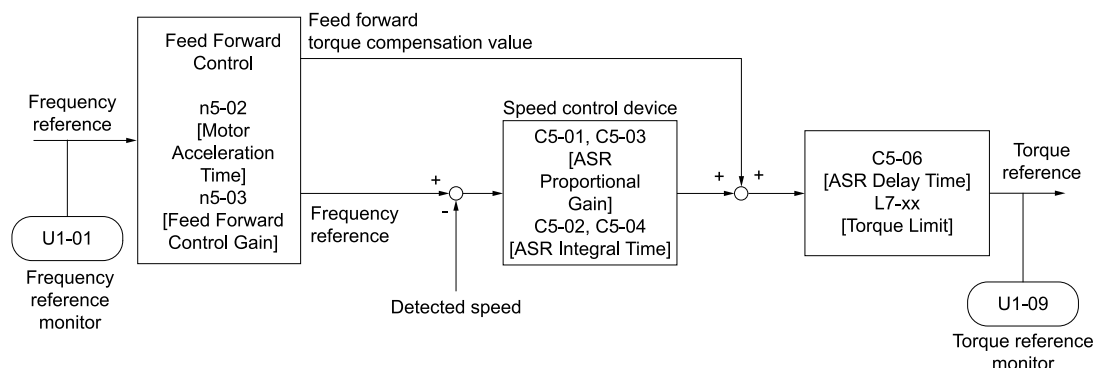

Figure 2.124 Configure Feed Forward Control

■ Before You Use Feed Forward Control

Do one of these procedures before you use feed forward control.

- Run Auto-Tuning to set motor parameters. When you cannot do Auto-Tuning, manually set motor parameters with the information on the motor nameplate or test reports. Set the *E2 parameters* for induction motors. Set the *E5 parameters* for PM motors.
- Set *C5 parameters* [Automatic Speed Regulator (ASR)] individually to adjust the speed control loop (ASR).
- If you can connect a motor to a machine and rotate it during Auto-Tuning, do Inertia Tuning. The drive automatically adjusts feed forward parameters during Inertia Tuning.
- If you cannot do Inertia Tuning, refer to [Figure 2.124](#) and set the parameters related to feed forward control individually.

■ n5-01: Feed Forward Control Selection

No. (Hex.)	Name	Description	Default (Range)
n5-01 (05B0)	Feed Forward Control Selection	<input type="radio"/> V/f <input type="radio"/> OLV <input type="radio"/> OLV/PM <input checked="" type="radio"/> AOLV/PM <input type="radio"/> EZOLV Sets the feed forward function.	0 (0, 1)

0 : Disabled

1 : Enabled

■ n5-02: Motor Inertia Acceleration Time

No. (Hex.)	Name	Description	Default (Range)
n5-02 (05B1)	Motor Inertia Acceleration Time	<div style="display: flex; justify-content: space-between; font-size: small;"> V/f OLV OLV/PM AOLV/PM EZOLV </div> Sets the length of time for the motor to accelerate from the stopped to the maximum frequency with a single motor at the rated torque. Inertia Tuning automatically sets the motor acceleration time.	Determined by C6-01, E5-01, and o2-04 (0.001 - 10.000 s)

If you cannot do Inertia Tuning, calculate the motor acceleration time as shown here or measure the motor acceleration time and set *n5-02* to this value.

Calculate the Motor Acceleration Time

Use this formula to find the motor acceleration time:

$$n5-02 = \frac{2\pi \cdot J_{\text{Motor}} \cdot n_{\text{rated}}}{60 \cdot T_{\text{rated}}}$$

- J_{Motor} = Moment of inertia of motor (kg m²)
- n_{rated} = Motor rated speed (min⁻¹, r/min)
- T_{rated} = Motor rated torque (N m)

You can also use this formula to find the motor acceleration time:

$$n5-02 = \frac{4\pi \cdot J_{\text{Motor}} \cdot f_{\text{rated}}}{P \cdot T_{\text{rated}}}$$

- f_{rated} = Motor rated frequency (Hz)
- P = Number of motor poles

Calculate the Motor Acceleration Time

Use this procedure to calculate the motor acceleration time:

1. Use *A1-02 [Control Method Selection]* to set the control method.
2. Disconnect the motor and load.
3. Run Auto-Tuning to set motor parameters.
When you cannot do Auto-Tuning, manually set motor parameters with the information on the motor nameplate or test reports. Set the *E2 parameters* for induction motors. Set the *E5 parameters* for PM motors.
4. Set *C5 parameters [Automatic Speed Regulator (ASR)]*.
5. Set *C1-01 [Acceleration Time 1] = 0*.
6. Set *L7-01 [Forward Torque Limit]* to 100%.
7. Set the frequency reference to the same value as the motor rated speed.
8. Measure the length of time for the motor to reach the rated speed.
Show *U1-05 [Motor Speed]* on the keypad and enter the Run command (forward run).
9. Stop the motor.
10. Set *n5-02* to the measured motor acceleration time value.

Reset all of the parameters that you changed to the previous setting values.

■ n5-03: Feed Forward Control Gain

No. (Hex.)	Name	Description	Default (Range)
n5-03 (05B2)	Feed Forward Control Gain	<div style="display: flex; justify-content: space-between; font-size: small;"> V/f OLV OLV/PM AOLV/PM EZOLV </div> Sets the ratio between load inertia and motor inertia. Inertia Tuning automatically sets the Feedforward Control Gain value.	1.00 (0.00 - 100.00)

When you cannot do Inertia Tuning, use this procedure to set *n5-03*:

Set *n5-02 [Motor Inertia Acceleration Time]*.

1. Connect the motor and load.
2. Set *C1-01 [Acceleration Time 1] = 0*.
3. Use *L7-01 to L7-04 [Torque Limit]* to set the expected test run torque limit levels.

4. Set the frequency reference as specified by the high speed range of the machine.
5. Measure the length of time for the motor to reach the command reference speed. Show *U1-05 [Motor Speed]* on the keypad and enter the Run command.
6. Stop the motor.
7. Replace the values in the this formula and set *n5-03* to the value of the formula.

$$n5-03 = \frac{t_{\text{accel}} \cdot T_{\text{Lim_Test}} \cdot f_{\text{rated}}}{n5-02 \cdot f_{\text{ref_Test}} \cdot 100} - 1$$

- t_{accel} = Acceleration time (s)
- f_{rated} = Motor rated frequency (Hz)
- $T_{\text{Lim_Test}}$ = Test run torque limit (%)
- $f_{\text{ref_Test}}$ = Test run frequency reference (Hz)

WARNING! Sudden Movement Hazard. Machinery can accelerate suddenly. Do not use this function with machinery that must not accelerate suddenly. Sudden starts can cause serious injury or death.

Reset all of the parameters that you changed to the previous setting values.

Note:

- If response to the speed reference is slow, increase the value set in *n5-03*.
- Increase the value set in *n5-03* when response to the speed reference is slow.
 - The speed is overshooting.
 - A negative torque reference is output when acceleration ends.

■ n5-04: Speed Response Frequency

No. (Hex.)	Name	Description	Default (Range)
n5-04 (05B3) RUN Expert	Speed Response Frequency	<div style="display: flex; justify-content: space-between; border: 1px solid gray; border-radius: 3px; padding: 2px;"> V/f OLV OLV/PM AOLV/PM EZOLV </div> Sets the response frequency for the speed reference. Usually it is not necessary to change this parameter.	Determined by A1-02 (0.00 - 500.00 Hz)

If you set *n5-03 [Feed Forward Control Gain]* too high, the motor speed will momentarily increase to more than the set frequency.

◆ n6: Online Tuning

n6 parameters are used to set the online tuning function for motor line-to-line resistance.

The Online Tuning for motor line-to-line resistance is used to prevent degradation of speed control accuracy due to motor temperature fluctuation and motor stalls due to insufficient torque.

■ n6-01: Online Tuning Selection

No. (Hex.)	Name	Description	Default (Range)
n6-01 (0570)	Online Tuning Selection	<div style="display: flex; justify-content: space-between; border: 1px solid gray; border-radius: 3px; padding: 2px;"> V/f OLV OLV/PM AOLV/PM EZOLV </div> Sets the type of motor data that Online Tuning uses for OLV control.	0 (0 - 2)

0 : Disabled

1 : Line-to-Line Resistance Tuning

The drive adjusts the motor line-to-line resistance during run. This procedure is applicable for speed values 6 Hz and less. It also adjusts the motor resistance value to increase the overload capacity in the low speed range.

2 : Voltage Correction Tuning

The drive adjusts the output voltage during run to increase overload tolerance and minimize the effects of high temperatures on speed precision.

Note:

Setting 2 is enabled only when *b8-01 = 0 [Energy Saving Control Selection = Disabled]*.

■ n6-05: Online Tuning Gain

No. (Hex.)	Name	Description	Default (Range)
n6-05 (05C7) Expert	Online Tuning Gain	<div style="display: flex; justify-content: space-between; border-bottom: 1px solid black; margin-bottom: 5px;"> V/f OLV OLV/PM AOLV/PM EZOLV </div> Sets the compensation gain when $n6-01 = 2$ [Online Tuning Selection = Voltage Correction Tuning]. Usually it is not necessary to change this parameter.	1.0 (0.1 - 50.0)

When you use a motor that has a large secondary circuit time constant, decrease the setting value.

If the drive detects *oL1* [Motor Overload], increase the setting value in 0.1-unit increments.

◆ n7: EZ Drive

The *n7 parameters* provide special adjustments for EZ Vector Control.

■ n7-01: Damping Gain for Low Frequency

No. (Hex.)	Name	Description	Default (Range)
n7-01 (3111) Expert	Damping Gain for Low Frequency	<div style="display: flex; justify-content: space-between; border-bottom: 1px solid black; margin-bottom: 5px;"> V/f OLV OLV/PM AOLV/PM EZOLV </div> Sets the oscillation suppression gain for the low speed range.	1.0 (0.1 - 10.0)

Note:

- If oscillation occurs in the low speed range, increase the acceleration time or increase the setting value in 0.5-unit increments.
- To get starting torque with the setting for *C4-01* [Torque Compensation Gain], decrease the setting value in 0.3-unit increments.

■ n7-05: Response Gain for Load Changes

No. (Hex.)	Name	Description	Default (Range)
n7-05 (3115) Expert	Response Gain for Load Changes	<div style="display: flex; justify-content: space-between; border-bottom: 1px solid black; margin-bottom: 5px;"> V/f OLV OLV/PM AOLV/PM EZOLV </div> Sets the response gain related to changes in the load.	50 (10 - 1000)

Note:

To make tracking related to load changes better, increase the setting value in 5-unit increments. If oscillation occurs during load changes, decrease the setting value in 5-unit increments.

■ n7-07: Speed Calculation Gain1

No. (Hex.)	Name	Description	Default (Range)
n7-07 (3117) Expert	Speed Calculation Gain1	<div style="display: flex; justify-content: space-between; border-bottom: 1px solid black; margin-bottom: 5px;"> V/f OLV OLV/PM AOLV/PM EZOLV </div> Sets the speed calculation gain during usual operation. Usually it is not necessary to change this setting.	15.0 (1.0 - 50.0)

■ n7-08: Speed Calculation Gain2

No. (Hex.)	Name	Description	Default (Range)
n7-08 (3118) Expert	Speed Calculation Gain2	<div style="display: flex; justify-content: space-between; border-bottom: 1px solid black; margin-bottom: 5px;"> V/f OLV OLV/PM AOLV/PM EZOLV </div> Sets the speed calculation gain during a speed search.	25.0 (1.0 - 50.0)

Note:

When you increase the setting value, you can do a speed search of a motor rotating at a high frequency. If the setting value is too high, the calculated speed will oscillate and a restart will fail. Decrease the setting value in these conditions.

■ n7-10: Pull-in Current Switching Speed

No. (Hex.)	Name	Description	Default (Range)
n7-10 (311A) Expert	Pull-in Current Switching Speed	<div style="display: flex; justify-content: space-between; align-items: center;"> V/f OLV OLV/PM AOLV/PM EZOLV </div> <p>Sets the speed range to operate with the pull-in current command. Drive rated frequency = 100% value. If there is a large quantity of oscillation when you operate in the low speed range, increase the setting value.</p>	10.0% (0.0 - 100.0%)

Note:

- When the drive accelerates, it enables these settings:
 - Motor speed \leq n7-10 + n7-11 [Drv Mode Switch Hysteresis Band]: n8-51 [Pull-in Current @ Acceleration]
 - Motor speed $>$ n7-10 + n7-11: b8-01 [Energy Saving Control Selection]
- When the drive decelerates, it enables these settings:
 - Motor speed \leq n7-10: n8-51 [Pull-in Current @ Acceleration]
 - Motor speed $>$ n7-10: b8-01 [Energy Saving Control Selection]
- If there is a large quantity of oscillation when you operate in the low speed range, increase the setting value.
- When it is most important to save energy in the low speed range, decrease the setting value.

■ n7-17: Resistance Temperature Correction

No. (Hex.)	Name	Description	Default (Range)
n7-17 (3122)	Resistance Temperature Correction	<div style="display: flex; justify-content: space-between; align-items: center;"> V/f OLV OLV/PM AOLV/PM EZOLV </div> <p>Sets the function to adjust for changes in the motor resistance value caused by changes in the temperature.</p>	1 (0 to 2)

0 : Invalid

1 : Valid (Only 1 time)

2 : Valid (Every time)

Note:

- For settings 1 and 2, the adjustment time can cause a delay before startup.
- For settings 1 and 2, the drive can set the line-to-line resistance value of E9-10 [Motor Line-to-Line Resistance].
- When the temperature will change at startup, use setting 2.
- To decrease the startup time, set this parameter to 0, then do line-to-line resistance tuning.
- If you will start from coasting, set this parameter to 0, then do line-to-line resistance tuning.

■ n7-19: Flux Error Compensation Gain

No. (Hex.)	Name	Description	Default (Range)
n7-19 (3128) Expert	Flux Error Compensation Gain	<div style="display: flex; justify-content: space-between; align-items: center;"> V/f OLV OLV/PM AOLV/PM EZOLV </div> <p>Sets the gain for magnetic flux compensation. Usually it is not necessary to change this setting.</p>	5000% (0 - 50000%)

◆ n8: PM Motor Control Tuning

n8 parameters are used to make adjustments when controlling PM motors.

■ n8-01: Pole Position Detection Current

No. (Hex.)	Name	Description	Default (Range)
n8-01 (0540)	Pole Position Detection Current	<div style="display: flex; justify-content: space-between; align-items: center;"> V/f OLV OLV/PM AOLV/PM EZOLV </div> <p>Sets the Initial Rotor Position Estimated Current as a percentage where E5-03 [PM Motor Rated Current (FLA)] = 100%. Usually it is not necessary to change this setting.</p>	50% (0 - 100%)

The drive uses the Initial Rotor Position Estimated Current to detect the initial position of rotors.

Use the "Si" value on the motor nameplate, if available.

Note:

When A1-02 = 7 [CLV/PM], this parameter takes effect only in Expert Mode.

■ n8-02: Pole Alignment Current Level

No. (Hex.)	Name	Description	Default (Range)
n8-02 (0541)	Pole Alignment Current Level	<div style="display: flex; justify-content: space-between; border-bottom: 1px solid black; margin-bottom: 5px;"> V/f OLV OLV/PM AOLV/PM EZOLV </div> Sets the current at the time of polar attraction as a percentage where <i>E5-03 [motor rated current]</i> is 100%. Usually it is not necessary to change this setting.	80% (0 - 150%)

The drive uses the polar pull-in current to attract the rotor after it detects the initial rotor position. When you increase the value of *n8-02*, the starting torque also increases.

- If the motor does not track correctly at the time of the polar attraction, increase the value in 10% increments.
- If the motor oscillates at the time of the polar attraction, decrease the value in 10% increments.

■ n8-11: Observer Calculation Gain 2

No. (Hex.)	Name	Description	Default (Range)
n8-11 (054A) Expert	Observer Calculation Gain 2	<div style="display: flex; justify-content: space-between; border-bottom: 1px solid black; margin-bottom: 5px;"> V/f OLV OLV/PM AOLV/PM EZOLV </div> Sets the gain for speed estimation. Usually it is not necessary to change this setting.	Determined by n8-72 (0.0 - 1000.0)

Note:

When *n8-72 = 0 [Speed Estimation Method Select = Method 1]*, the default value is 50.0. When *n8-72 = 1 [Method 2]*, the default value is 150.0.

■ n8-14: Polarity Compensation Gain 3

No. (Hex.)	Name	Description	Default (Range)
n8-14 (054D) Expert	Polarity Compensation Gain 3	<div style="display: flex; justify-content: space-between; border-bottom: 1px solid black; margin-bottom: 5px;"> V/f OLV OLV/PM AOLV/PM EZOLV </div> Sets the gain for speed estimation. Usually it is not necessary to change this setting.	1.000 (0.000 - 10.000)

■ n8-15: Polarity Compensation Gain 4

No. (Hex.)	Name	Description	Default (Range)
n8-15 (054E) Expert	Polarity Compensation Gain 4	<div style="display: flex; justify-content: space-between; border-bottom: 1px solid black; margin-bottom: 5px;"> V/f OLV OLV/PM AOLV/PM EZOLV </div> Sets the gain for speed estimation. Usually it is not necessary to change this setting.	0.500 (0.000 - 10.000)

■ n8-21: Motor Back-EMF (Ke) Gain

No. (Hex.)	Name	Description	Default (Range)
n8-21 (0554) Expert	Motor Back-EMF (Ke) Gain	<div style="display: flex; justify-content: space-between; border-bottom: 1px solid black; margin-bottom: 5px;"> V/f OLV OLV/PM AOLV/PM EZOLV </div> Sets the gain for speed estimation. Usually it is not necessary to change this setting.	0.90 (0.80 - 1.00)

■ n8-23: ACR q Gain @PoleEst

No. (Hex.)	Name	Description	Default (Range)
n8-23 (0556) Expert	ACR q Gain @PoleEst	<div style="display: flex; justify-content: space-between; border-bottom: 1px solid black; margin-bottom: 5px;"> V/f OLV OLV/PM AOLV/PM EZOLV </div> Sets the proportional gain for current regulator q-axis control when the drive estimates the initial pole. Usually it is not necessary to change this setting.	0 (0 - 2000)

■ n8-24: ACR q Integral Time @PoleEst

No. (Hex.)	Name	Description	Default (Range)
n8-24 (0557) Expert	ACR q Integral Time @PoleEst	V/f OLV OLV/PM AOLV/PM EZOLV Sets the integral time for current regulator q-axis control when the drive estimates the initial pole. Usually it is not necessary to change this setting.	0.0 ms (0.0 - 100.0 ms)

■ n8-25: ACR q Limit @PoleEst

No. (Hex.)	Name	Description	Default (Range)
n8-25 (0558) Expert	ACR q Limit @PoleEst	V/f OLV OLV/PM AOLV/PM EZOLV Sets the q-axis limit of the current regulator when the drive estimates the initial pole. Usually it is not necessary to change this setting.	0% (0 - 150%)

■ n8-26: ACR d Gain @PoleEst

No. (Hex.)	Name	Description	Default (Range)
n8-26 (0559) Expert	ACR d Gain @PoleEst	V/f OLV OLV/PM AOLV/PM EZOLV Sets the proportional gain for current regulator d-axis control when the drive estimates the initial pole. Usually it is not necessary to change this setting.	500 (0 - 2000)

■ n8-27: ACR d Integral Time @PoleEst

No. (Hex.)	Name	Description	Default (Range)
n8-27 (055A) Expert	ACR d Integral Time @PoleEst	V/f OLV OLV/PM AOLV/PM EZOLV Sets the integral time for current regulator d-axis control when the drive estimates the initial pole. Usually it is not necessary to change this setting.	0.0 ms (0.0 - 100.0 ms)

■ n8-28: ACR d Lim @PoleEst

No. (Hex.)	Name	Description	Default (Range)
n8-28 (055B) Expert	ACR d Lim @PoleEst	V/f OLV OLV/PM AOLV/PM EZOLV Sets the d-axis limit of the current regulator when the drive estimates the initial pole. Usually it is not necessary to change this setting.	100% (0 - 150%)

■ n8-35: Initial Pole Detection Method

No. (Hex.)	Name	Description	Default (Range)
n8-35 (0562)	Initial Pole Detection Method	V/f OLV OLV/PM AOLV/PM EZOLV Sets how the drive detects the position of the rotor when the motor starts.	Determined by A1-02 (0 - 2)

Note:

- When you use an SPM motor, set $n8-35 = 0$. When you use an IPM motor, set $n8-35 = 0$ to 2 .
- When you set $n8-35 = 1$, do High Frequency Injection Auto-Tuning.
- When you set $n8-35 = 0$ or 2 , always evaluate the drive with the equipment being used for the application. If the drive incorrectly detects the polarity, the motor can rotate in the direction opposite of the Run command.

0 : Pull-in

Starts the rotor with pull-in current.

1 : High Frequency Injection

Injects high frequency to detect the rotor position. This setting can cause a loud excitation sound when the motor starts.

Note:

When you set 1 , do High Frequency Injection Auto-Tuning.

2 : Pulse Injection

Inputs the pulse signal to the motor to detect the rotor position.

■ n8-36: HFI Frequency Level for L Tuning

No. (Hex.)	Name	Description	Default (Range)
n8-36 (0563)	HFI Frequency Level for L Tuning	<div style="display: flex; justify-content: space-between; align-items: center;"> V/f OLV OLV/IPM AOLV/IPM EZOLV </div> Sets the injection frequency for high frequency injection.	500 Hz (200 - 1000 Hz)

Note:

- Set $n8-35 = 1$ [Initial Pole Detection Method = High Frequency Injection] or $n8-57 = 1$ [HFI Overlap Selection = Enabled] to enable this parameter.
- The drive automatically calculates this value when High Frequency Injection Auto-Tuning completes successfully.

■ n8-37: HFI Voltage Amplitude Level

No. (Hex.)	Name	Description	Default (Range)
n8-37 (0564) Expert	HFI Voltage Amplitude Level	<div style="display: flex; justify-content: space-between; align-items: center;"> V/f OLV OLV/IPM AOLV/IPM EZOLV </div> Sets the high frequency injection amplitude as a percentage where 200 V = 100% for 200 V class drives and 400 V = 100% for a 400 V class drives. Usually it is not necessary to change this setting.	20.0% (0.0 - 50.0%)

Note:

- Set $n8-35 = 1$ [Initial Pole Detection Method = High Frequency Injection] or $n8-57 = 1$ [HFI Overlap Selection = Enabled] to enable this parameter.
- The drive automatically calculates this value when High Frequency Injection Auto-Tuning completes successfully.

■ n8-39: HFI LPF Cutoff Freq

No. (Hex.)	Name	Description	Default (Range)
n8-39 (0566)	HFI LPF Cutoff Freq	<div style="display: flex; justify-content: space-between; align-items: center;"> V/f OLV OLV/IPM AOLV/IPM EZOLV </div> Sets the low-pass filter shut-off frequency for high frequency injection.	250 Hz (0 - 1000 Hz)

Note:

- Set $n8-35 = 1$ [Initial Pole Detection Method = High Frequency Injection] or $n8-57 = 1$ [HFI Overlap Selection = Enabled] to enable this parameter.
- The drive automatically calculates this value when High Frequency Injection Auto-Tuning completes successfully.

■ n8-41: HFI P Gain

No. (Hex.)	Name	Description	Default (Range)
n8-41 (0568) Expert	HFI P Gain	<div style="display: flex; justify-content: space-between; align-items: center;"> V/f OLV OLV/IPM AOLV/IPM EZOLV </div> Sets the response gain for the high frequency injection speed estimation.	2.5 (-10.0 - +10.0)

Note:

- Set $n8-35 = 1$ [Initial Pole Detection Method = High Frequency Injection] or $n8-57 = 1$ [HFI Overlap Selection = Enabled] to enable this parameter.
- When $A1-02 = 6$ [Control Method Selection = AOLV/IPM] and you do High Frequency Injection Auto-Tuning, the drive automatically sets this parameter.
- Set $n8-41 > 0.0$ for IPM motors.

Set this parameter as follows.

- If there is oscillation or hunting, decrease the setting in units of 0.5.
- When it is necessary to track load changes, increase the setting in units of 0.5.

■ n8-42: HFI I Time

No. (Hex.)	Name	Description	Default (Range)
n8-42 (0569) Expert	HFI I Time	<div style="display: flex; justify-content: space-between; align-items: center;"> V/f OLV OLV/IPM AOLV/IPM EZOLV </div> Sets the integral time constant for the high frequency injection speed estimation. Usually it is not necessary to change this setting.	0.10 s (0.00 - 9.99 s)

Note:

Set $n8-35 = 1$ [Initial Pole Detection Method = High Frequency Injection] or $n8-57 = 1$ [HFI Overlap Selection = Enabled] to enable this parameter.

■ n8-45: Speed Feedback Detection Gain

No. (Hex.)	Name	Description	Default (Range)
n8-45 (0538)	Speed Feedback Detection Gain	V/f OLV OLV/PM AOLV/PM EZOLV Sets the internal speed feedback detection reduction unit gain as a magnification value. Usually it is not necessary to change this setting.	0.80 (0.00 - 10.00)

Adjust this parameter in these conditions:

- If vibration or hunting occur, increase the setting value in 0.05 unit increments.
- If the responsiveness of torque and speed is unsatisfactory, decrease the setting value 0.05 unit increments and examine the response.

■ n8-46: PM Phase Compensation Gain

No. (Hex.)	Name	Description	Default (Range)
n8-46 (0539) Expert	PM Phase Compensation Gain	V/f OLV OLV/PM AOLV/PM EZOLV Sets the gain to compensate for phase differences. Usually it is not necessary to change this setting.	0.3 (0.0 - 10.0)

If there is vibration in the motor, increase the value. When you must detect *oC* [Overcurrent] or *ov* [DC Bus Overvoltage], set this parameter to a low value.

■ n8-47: Pull-in Current Comp Filter Time

No. (Hex.)	Name	Description	Default (Range)
n8-47 (053A)	Pull-in Current Comp Filter Time	V/f OLV OLV/PM AOLV/PM EZOLV Sets the time constant the drive uses to align the pull-in current reference value with the actual current value. Usually it is not necessary to change this setting.	5.0 s (0.0 - 100.0 s)

Adjust this parameter in these conditions:

- If the time for the reference value of the pull-in current to align with the target value is too long, increase the setting value.
- If vibration or hunting occur, decrease the setting value in 0.2 unit increments.
- If the motor stalls during run at constant speed, decrease the setting value in 0.2 unit increments.

■ n8-48: Pull-in/Light Load Id Current

No. (Hex.)	Name	Description	Default (Range)
n8-48 (053B) RUN	Pull-in/Light Load Id Current	V/f OLV OLV/PM AOLV/PM EZOLV On the basis that parameter <i>E5-03</i> [Motor Rated Current (FLA)] is the 100% value, this parameter sets the d-axis current that flows to the motor during run at constant speed as a percentage.	30% (0 - 200%)

Adjust in the following situations.

- Slightly reduce this value if there is too much current when driving a light load at a constant speed.
- Increase the setting value in steps of 5% when hunting or vibration occurs during run at constant speed.
- Increase the setting value in steps of 5% if the motor stalls during run at constant speed.

■ n8-49: Heavy Load Id Current

No. (Hex.)	Name	Description	Default (Range)
n8-49 (053C) RUN Expert	Heavy Load Id Current	<div style="display: flex; justify-content: space-between; border-bottom: 1px solid black; margin-bottom: 5px;"> V/f OLV OLV/PM AOLV/PM EZOLV </div> Sets the d-axis current to that the drive will supply to the motor to run it at a constant speed with a heavy load. Considers <i>E5-03 [PM Motor Rated Current (FLA)]</i> to be 100%. Usually it is not necessary to change this setting.	Determined by E5-01 (-200.0 - +200.0%)

When you use an IPM motor, you can use the reluctance torque of the motor to make the motor more efficient and help conserve energy.

When you operate an SPN motor, set this parameter to 0.

Adjust in the following situations.

- If the load is large and motor rotation is not stable, decrease the setting value.
- When you change the *E5 parameters [PM Motor Settings]*, set *n8-49 = 0*, then adjust this parameter.

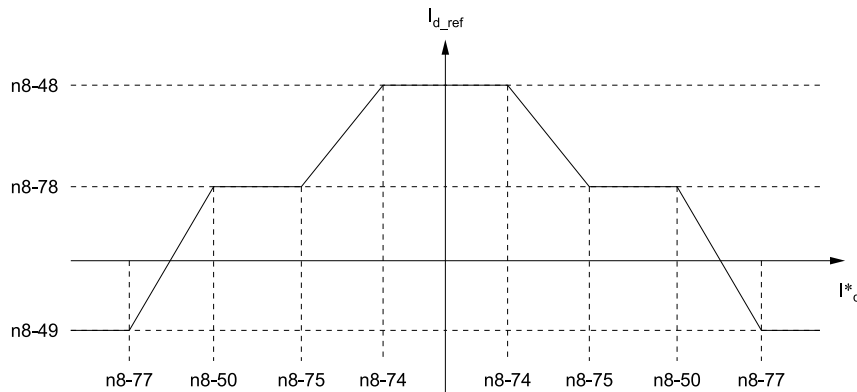

■ n8-50: Medium Load Iq Level (High)

No. (Hex.)	Name	Description	Default (Range)
n8-50 (053D) Expert	Medium Load Iq Level (High)	<div style="display: flex; justify-content: space-between; border-bottom: 1px solid black; margin-bottom: 5px;"> V/f OLV OLV/PM AOLV/PM EZOLV </div> Sets the load current level at which heavy load control starts where <i>E5-03 [Motor Rated Current (FLA)]</i> is 100%. Usually it is not necessary to change this setting.	80% (50 - 255)

■ n8-51: Pull-in Current @ Acceleration

No. (Hex.)	Name	Description	Default (Range)
n8-51 (053E)	Pull-in Current @ Acceleration	<div style="display: flex; justify-content: space-between; border-bottom: 1px solid black; margin-bottom: 5px;"> V/f OLV OLV/PM AOLV/PM EZOLV </div> Sets the pull-in current allowed to flow during acceleration/deceleration as a percentage of the motor rated current.	Determined by A1-02 (0 - 200%)

Adjust in the following situations.

- When the motor does not smoothly because of large loads, increase the setting value in 5% increments.
- If too much current flows during acceleration, decrease the setting value.

Note:

When *A1-02 = 8 [Control Method Selection = EZOLV]*, this parameter will always be in effect for speed ranges less than *n7-10 [Pull-in Current Switching Speed]*.

■ n8-54: Voltage Error Compensation Time

No. (Hex.)	Name	Description	Default (Range)
n8-54 (056D) Expert	Voltage Error Compensation Time	<div style="display: flex; justify-content: space-between; border-bottom: 1px solid black; margin-bottom: 5px;"> V/f OLV OLV/PM AOLV/PM EZOLV </div> Sets the time constant that the drive uses when adjusting for voltage errors.	1.00 s (0.00 - 10.00 s)

Adjust this parameter in these conditions:

- If oscillation occurs at the time of start up, increase the setting value.
- If hunting occurs when operating at low speed, increase the setting value.
- If fast changes in the load cause hunting, increase the setting value in 0.1-unit increments. If you cannot stop hunting, set *n8-51 [Pull-in Current @ Acceleration]* to 0% and set *n8-54* to 0.00 s, and disable compensation for voltage errors.

■ n8-55: Motor to Load Inertia Ratio

No. (Hex.)	Name	Description	Default (Range)
n8-55 (056E)	Motor to Load Inertia Ratio	<div style="display: flex; justify-content: space-between; align-items: center;"> V/f OLV OLV/PM AOLV/PM EZOLV </div> Sets the ratio between motor inertia and machine inertia.	0 (0 - 3)

Sets the ratio between motor inertia and machine inertia to adjust the ACR.

Adjust in the following situations.

- If torque and speed response are unsatisfactory, gradually increase the setting from 0.
- If the motor does not run smoothly, gradually increase the setting from 0.
- If the motor stalls during run at constant speed, gradually increase the setting from 0.
- If there is vibration or hunting, decrease the setting.

Note:

- If the value too low, the drive will detect *STPo [Motor Step-Out Detected]*.
- If you use one motor or more than motor at low inertia and the value is too high, there can be vibration in the motor.

0 : Below 1:10

Use this setting in these conditions:

- The ratio between the motor inertia and machine inertia is less than 1:10
- There are large current ripples

1 : Between 1:10 and 1:30

Use this setting in these conditions:

- The ratio between the motor inertia and machine inertia is approximately 1:10 to 1:30
- Parameter *n8-55 = 0* and the drive detects *STPo* because of an impact load or sudden acceleration/deceleration.

2 : Between 1:30 and 1:50

Use this setting in these conditions:

- The ratio between the motor inertia and machine inertia is approximately 1:30 to 1:50
- Parameter *n8-55 = 1* and the drive detects *STPo* because of an impact load or sudden acceleration/deceleration.

3 : Beyond 1:50

Adjust this parameter in these conditions:

- The ratio between the motor inertia and machine inertia is more than 1:50
- Parameter *n8-55 = 2* and the drive detects *STPo* because of an impact load or sudden acceleration/deceleration.

■ n8-56: PM High Performance Selection

No. (Hex.)	Name	Description	Default (Range)
n8-56 (056F) Expert	PM High Performance Selection	<div style="display: flex; justify-content: space-between; align-items: center;"> V/f OLV OLV/PM AOLV/PM EZOLV </div> Sets the high efficiency control method for IPM motors. Usually it is not necessary to change this setting.	1 (0 - 2)

0 : Disabled

1 : Enabled (Vd)

2 : Enabled (Vd & Vq)

■ n8-57: HFI Overlap Selection

No. (Hex.)	Name	Description	Default (Range)
n8-57 (0574)	HFI Overlap Selection	<div style="display: flex; justify-content: space-between; align-items: center;"> V/f OLV OLV/PM AOLV/PM EZOLV </div> Sets the function that detects motor speed with high frequency injection.	0 (0, 1)

Note:

- When you set $n8-57 = 1$, do High Frequency Injection Auto-Tuning.
- When there is high frequency injection, the motor will make an excitation sound.
- When you use Zero Speed Control, set $E1-09 = 0.0$ [Minimum Output Frequency = 0.0 Hz].

0 : Disabled

Use this setting with SPM motors. The speed control range is approximately 1:20.

When $n8-57 = 0$, you cannot set $E1-09$ [Minimum Output Frequency] $\leq 1/20$ of the value of $E1-06$ [Base Frequency].

1 : Enabled

The speed control range is 1:100. It gives sufficient speed detection at low speeds.

Note:

- It is not available with an SPM motor.
- The speed control range 1:100 is the momentary operation area. When you operate the motor continuously, make sure that the drive capacity and motor capacity are acceptable.

■ n8-62: Output Voltage Limit Level

No. (Hex.)	Name	Description	Default (Range)
n8-62 (057D) Expert	Output Voltage Limit Level	<div style="display: flex; justify-content: space-between; align-items: center;"> V/f OLV OLV/PM AOLV/PM EZOLV </div> Sets the output voltage limit to prevent saturation of the output voltage. Usually it is not necessary to change this parameter.	200 V Class: 200.0 V, 400 V: 400.0 V (200 V Class: 0.0 to 240.0 V, 400 V Class: 0.0 to 480.0 V)

Set this parameter lower than the input power supply voltage.

Note:

- When $A1-02 = 8$ [EZOLV], the default settings are:
–200 V class: 230.0 V
–400 V class: 460.0 V

■ n8-63: Output Voltage Limit P Gain

No. (Hex.)	Name	Description	Default (Range)
n8-63 (057E) Expert	Output Voltage Limit P Gain	<div style="display: flex; justify-content: space-between; align-items: center;"> V/f OLV OLV/PM AOLV/PM EZOLV </div> Sets the proportional gain for output voltage control. Usually it is not necessary to change this setting.	1.00 (0.00 - 100.00)

■ n8-64: Output Voltage Limit I Time

No. (Hex.)	Name	Description	Default (Range)
n8-64 (057F) Expert	Output Voltage Limit I Time	<div style="display: flex; justify-content: space-between; align-items: center;"> V/f OLV OLV/PM AOLV/PM EZOLV </div> Sets the integral time for output voltage control. Usually it is not necessary to change this setting.	0.040 s (0.000 - 5.000)

■ n8-65: Speed Fdbk Gain @ oV Suppression

No. (Hex.)	Name	Description	Default (Range)
n8-65 (065C) Expert	Speed Fdbk Gain @ oV Suppression	<div style="display: flex; justify-content: space-between; align-items: center;"> V/f OLV OLV/PM AOLV/PM EZOLV </div> Sets the gain of internal speed feedback detection suppression while the overvoltage suppression function is operating as a magnification value. Usually it is not necessary to change this parameter.	1.50 (0.00 - 10.00)

Adjust this parameter in these conditions:

- If there is resonance or hunting when you use the overvoltage suppression function, increase the setting value.
- If motor response is low when you use the overvoltage suppression function, decrease the setting value in 0.05-unit increments.

■ n8-69: Speed Observer Control P Gain

No. (Hex.)	Name	Description	Default (Range)
n8-69 (065D) Expert	Speed Observer Control P Gain	V/f OLV OLV/PM AOLV/PM EZOLV Usually it is not necessary to change this setting. Sets the Proportional gain that the drive uses for speed estimation.	1.00 (0.00 - 20.00)

■ n8-70: Speed Observer Control I Time

No. (Hex.)	Name	Description	Default (Range)
n8-70 (065E) Expert	Speed Observer Control I Time	V/f OLV OLV/PM AOLV/PM EZOLV Sets the speed estimator integral time constant. It is available when $n8-72 = 1$ [Speed Estimation Method Select = Method 2]. Usually it is not necessary to change this setting.	0.0 s (0.0 - 100.0)

■ n8-71: Speed Observer Control D Gain

No. (Hex.)	Name	Description	Default (Range)
n8-71 (065F) Expert	Speed Observer Control D Gain	V/f OLV OLV/PM AOLV/PM EZOLV Set the speed estimator differential gain. It is available when $n8-72 = 1$ [Speed Estimation Method Select = Method 2]. Usually it is not necessary to change this setting.	5.00 (0.00 - 50.00)

■ n8-72: Speed Estimation Method Select

No. (Hex.)	Name	Description	Default (Range)
n8-72 (0655) Expert	Speed Estimation Method Select	V/f OLV OLV/PM AOLV/PM EZOLV Selects the speed estimation method. Usually it is not necessary to change this setting.	1 (0, 1)

0 : Method 1

1 : Method 2

■ n8-73: Observer Mode Switch-Over Speed

No. (Hex.)	Name	Description	Default (Range)
n8-73 (0656) Expert	Observer Mode Switch-Over Speed	V/f OLV OLV/PM AOLV/PM EZOLV Sets the speed level for pull-in current control at motor start as a percentage of $E1-06$ [Base Frequency]. Usually it is not necessary to change this setting.	10% (0 - 100)

■ n8-74: Light Load Iq Level

No. (Hex.)	Name	Description	Default (Range)
n8-74 (05C3) Expert	Light Load Iq Level	V/f OLV OLV/PM AOLV/PM EZOLV Set $n8-48$ [Pull-in/Light Load Id Current] to the percentage of load current (q-axis current) that you will apply, where $E5-03$ [Motor Rated Current (FLA)] = a setting value of 100%.	30% (0 - 255%)

Note:

- If $n8-74 > n8-75$ [Medium Load Iq Level (low)], the drive will detect $oPE08$ [Parameter Selection Error].
- The change is linear between $n8-74$ and $n8-75$ and the level of the pull-in current from $n8-48$ to $n8-78$ [Medium Load Id Current].

■ n8-75: Medium Load Iq Level (low)

No. (Hex.)	Name	Description	Default (Range)
n8-75 (05C4) Expert	Medium Load Iq Level (low)	<div style="display: flex; justify-content: space-between; align-items: center;"> V/f OLV OLV/PM AOLV/PM EZOLV </div> Set n8-78 [Medium Load Id Current] to the percentage of load current (q-axis current) that you will apply, where E5-03 [Motor Rated Current (FLA)] = a setting value of 100%.	50% (0 - 255%)

Note:

- If n8-74 [Light Load Iq Level] > n8-75, the drive will detect oPE08 [Parameter Selection Error].
- The change is linear between n8-74 and n8-75 and the level of the pull-in current from n8-48 to n8-78 [Medium Load Id Current].

■ n8-76: Id Switching Filter Time

No. (Hex.)	Name	Description	Default (Range)
n8-76 (05CD) Expert	Id Switching Filter Time	<div style="display: flex; justify-content: space-between; align-items: center;"> V/f OLV OLV/PM AOLV/PM EZOLV </div> Sets the filter time constant for the d-axis current reference. Usually it is not necessary to change this setting.	200 ms (0 - 5000 ms)

■ n8-77: Heavy Load Iq Level

No. (Hex.)	Name	Description	Default (Range)
n8-77 (05CE) Expert	Heavy Load Iq Level	<div style="display: flex; justify-content: space-between; align-items: center;"> V/f OLV OLV/PM AOLV/PM EZOLV </div> Set n8-49 [Heavy Load Id Current] to the percentage of load current (q-axis current) that you will apply, where E5-03 [Motor Rated Current (FLA)] = a setting value of 100%.	90% (0 - 255%)

Note:

The change is linear between n8-75 [Medium Load Iq Level (low)] and n8-77 and the level of the pull-in current from n8-78 [Medium Load Id Current] to n8-49 [Heavy Load Id Current].

■ n8-78: Medium Load Id Current

No. (Hex.)	Name	Description	Default (Range)
n8-78 (05F4) RUN Expert	Medium Load Id Current	<div style="display: flex; justify-content: space-between; align-items: center;"> V/f OLV OLV/PM AOLV/PM EZOLV </div> Sets the level of the pull-in current as a percentage, where E5-03 [PM Motor Rated Current (FLA)] = 100%.	0% (0 - 255%)

■ n8-79: Pull-in Current @ Deceleration

No. (Hex.)	Name	Description	Default (Range)
n8-79 (05FE)	Pull-in Current @ Deceleration	<div style="display: flex; justify-content: space-between; align-items: center;"> V/f OLV OLV/PM AOLV/PM EZOLV </div> Sets the pull-in current that can flow during deceleration as a percentage of the E5-03 [PM Motor Rated Current (FLA)].	50% (0 - 200%)

If overcurrent occurs during deceleration, slowly decrease the setting in 5% increments.

Note:

When n8-79 = 0, the drive will use the value set in n8-51 [Pull-in Current @ Acceleration].

■ n8-84: Polarity Detection Current

No. (Hex.)	Name	Description	Default (Range)
n8-84 (02D3) Expert	Polarity Detection Current	<div style="display: flex; justify-content: space-between; align-items: center;"> V/f OLV OLV/PM AOLV/PM EZOLV </div> Sets the current that the drive uses to estimate the initial motor magnetic pole as a percentage where E5-03 [PM Motor Rated Current (FLA)] = 100%.	100% (0 - 150%)

WARNING! Sudden Movement Hazard. Make sure that the polarity is correct before you send a Run command. If the drive incorrectly detects the polarity, the drive can rotate in the direction opposite of the Run command and cause serious injury or death.

When you use a Yaskawa motor, check the motor nameplate for an "Si" value and set this parameter $\geq "Si \times 2"$. Consult the motor manufacturer for information about maximum setting values.

Find the Polarity of Magnetic Poles

When you start operation, the drive estimates the magnetic poles and finds the polarity of the magnetic poles.

Use *U6-57 [PolePolarityDeterVal]* to make sure that the magnetic pole estimate was correct.

When you do High Frequency Injection Auto-Tuning, the drive automatically sets *n8-84*.

■ n8-87: Output Voltage Limit Method

No. (Hex.)	Name	Description	Default (Range)
n8-87 (02DA)	Output Voltage Limit Method	V/f OLV OLV/PM AOLV/PM EZOLV Sets the method of output voltage limit. If there is vibration in the constant output range, set Feedforward Method. Usually it is not necessary to change this setting.	0 (0, 1)

0 : Feedback Method

1 : Feedforward Method

■ n8-88: Vout Limit Switching Level

No. (Hex.)	Name	Description	Default (Range)
n8-88 (02BD)	Vout Limit Switching Level	V/f OLV OLV/PM AOLV/PM EZOLV Sets the current level at which output voltage limit sequence selection occurs as a percentage where the motor rated current is 100%. Normally there is no need to change this setting.	400% (0 - 400%)

■ n8-89: Vout Limit Switching Hysteresis

No. (Hex.)	Name	Description	Default (Range)
n8-89 (02BE)	Vout Limit Switching Hysteresis	V/f OLV OLV/PM AOLV/PM EZOLV Sets the hysteresis width of the current level at which output voltage limit sequence selection occurs as a percentage where the motor rated current is 100%. Normally there is no need to change this setting.	3% (0 - 400%)

■ n8-90: Vout Limit Switching Speed

No. (Hex.)	Name	Description	Default (Range)
n8-90 (02BF)	Vout Limit Switching Speed	V/f OLV OLV/PM AOLV/PM EZOLV Sets the speed level at which output voltage limit sequence selection occurs as a percentage where the maximum output frequency is 100%. Usually it is not necessary to change this setting.	200% (0 - 200%)

■ n8-91: Id Limit at Voltage Saturation

No. (Hex.)	Name	Description	Default (Range)
n8-91 (02F7)	Id Limit at Voltage Saturation	V/f OLV OLV/PM AOLV/PM EZOLV Sets the limit value of feedback output voltage limit Id operation. Enabled when <i>n8-87 = 0 [Output Voltage Control Selection = Speed Feedback Form]</i> . Usually it is not necessary to change this setting.	-50% (-200 - 0%)

■ n8-94: Flux Position Estimation Method

No. (Hex.)	Name	Description	Default (Range)
n8-94 (012D) Expert	Flux Position Estimation Method	V/f OLV OLV/PM AOLV/PM EZOLV Sets the criteria that the drive uses to find changes in speed or load. Usually it is not necessary to change this setting.	1 (0, 1)

0 : Softstarter

1 : Speed Feedback

2.10 n: Special Adjustment

Set $n8-57 = 1$ [*HFI Overlap Selection = Enabled*] to enable this parameter. Increases the stability when the speed or load suddenly change, for example with rapid acceleration/deceleration or impact loads.

■ n8-95: Flux Position Est Filter Time

No. (Hex.)	Name	Description	Default (Range)
n8-95 (012E) Expert	Flux Position Est Filter Time	V/f OLV OLV/PM AOLV/PM EZOLV Sets the time constant of the filter used for the recognition criteria value for speed and load changes. Usually it is not necessary to change this setting.	30 ms (0 - 100 ms)

Note:

Enabled when $n8-94 = 1$ [*Flux Position Estimation Method = Speed Feedback*].

◆ nA: PM Motor Control Tuning

nA parameters make adjustments for controlling PM motors.

■ nA-01: Observer Calc Gain 3

No. (Hex.)	Name	Description	Default (Range)
nA-01 (3129) Expert	Observer Calc Gain 3	V/f OLV OLV/PM AOLV/PM EZOLV Sets the gain for speed estimation. Usually it is not necessary to change this setting.	30.0 (0.0 - 1000.0)

2.11 o: Keypad-Related Settings

o parameters set keypad functions.

Note:

You cannot use the optional LED keypad to set these parameters.

Table 2.64 Parameters You Cannot Set with the LED Keypad

No.	Name	No.	Name
o1-05	LCD Contrast Adjustment	o3-04	Select Backup/Restore Location
o1-24 to o1-35	Custom Monitor 1 to 12	o3-05	Select Items to Backup/Restore
o1-36	LCD Backlight Brightness	o3-06	Auto Parameter Backup Selection
o1-37	LCD Backlight ON/OFF Selection	o3-07	Auto Parameter Backup Interval
o1-38	LCD Backlight Off-Delay	o4-22	Time Format
o1-39	Show Initial Setup Screen	o4-23	Date Format
o1-40	Home Screen Display Selection	o4-24	bAT Detection Selection
o1-41 to o1-46	1st to 3rd Monitor Area Selections/Settings	o5-01	Log Start/Stop Selection
o1-47 to o1-51	Trend Plot 1 or 2 Scale Settings	o5-02	Log Sampling Interval
o1-55 to o1-56	Analog Gauge Area Selection/Setting	o5-03 to o5-12	Log Monitor Data 1 to 10
o2-27	bCE Detection Selection		

◆ o1: Keypad Display Selection

o1 parameters select the parameters shown on the initial keypad screen and to configure the parameter setting units and display units. These parameters also adjust the backlight and contrast of the LCD display.

■ Home Screen Display Format

o1-40 [Home Screen Display Selection] changes the display of the monitor shown on the Home screen. You can show numerical values or one of these three displays on the Home screen monitor:

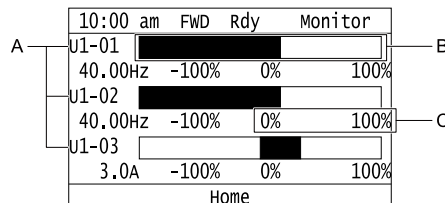

A - Set *Ux-xx* [Monitors] to *o1-24*, *o1-25*, and *o1-26*.

C - Set display ranges to *o1-42*, *o1-44*, and *o1-46*.

B - Set display regions to *o1-41*, *o1-43*, and *o1-45*.

Figure 2.125 Bar Graph Display

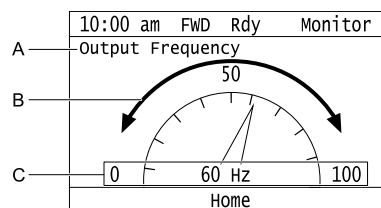

A - Set *Ux-xx* [Monitors] to *o1-24*.

C - Set display ranges to *o1-55*.

B - Set display regions to *o1-56*.

Figure 2.126 Analog Gauge Display

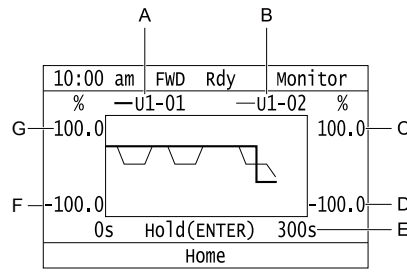

- A - Set $Ux-xx$ [Monitors] (Monitor 1) to $o1-24$.
- B - Set $Ux-xx$ [Monitors] (Monitor 2) to $o1-25$.
- C - Set the maximum value of Monitor 2 to $o1-50$.
- D - Set the minimum value of Monitor 2 to $o1-49$.
- E - Set the time scale to $o1-51$.
- F - Set the minimum value of Monitor 1 to $o1-47$.
- G - Set the maximum value of Monitor 1 to $o1-48$.

Figure 2.127 Trend Plot Display

■ o1-01: User Monitor Selection

No. (Hex.)	Name	Description	Default (Range)
o1-01 (0500) RUN	User Monitor Selection	<div style="display: flex; gap: 5px;"> V/f OLV OLV/PM AOLV/PM EZOLV </div> <p>Sets the U monitor for the Drive Mode. This parameter is only available with an LED keypad.</p>	106 (104 - 855)

When the drive is in Drive Mode, push on the keypad to cycle through this data: frequency reference → rotational direction → output frequency → output current → $o1-01$ selection.

Set the $x-xx$ part of $Ux-xx$ that is shown in the fifth position in Drive Mode. For example, to show $U1-05$ [Motor Speed], set $o1-01 = 105$.

Note:

The monitors that you can select are different for different control methods.

■ o1-02: Monitor Selection at Power-up

No. (Hex.)	Name	Description	Default (Range)
o1-02 (0501) RUN	Monitor Selection at Power-up	<div style="display: flex; gap: 5px;"> V/f OLV OLV/PM AOLV/PM EZOLV </div> <p>Sets the monitor item that the keypad screen shows after you energize the drive. Refer to "U: Monitors" for information about the monitor items that the keypad screen can show. This parameter is only available with an LED keypad.</p>	1 (1 - 5)

1 : Frequency Reference (U1-01)

2 : Direction

3 : Output Frequency (U1-02)

4 : Output Current (U1-03)

5 : User Monitor (o1-01)

Shows the monitor item selected in $o1-01$ [User Monitor Selection].

■ o1-03: Frequency Display Unit Selection

No. (Hex.)	Name	Description	Default (Range)
o1-03 (0502)	Frequency Display Unit Selection	<div style="display: flex; gap: 5px;"> V/f OLV OLV/PM AOLV/PM EZOLV </div> <p>Sets the display units for the frequency reference and output frequency.</p>	Determined by A1-02 (0 - 3)

Note:

- Select the setting unit of these parameters:
 - d1-01 to d1-17 [Reference 1 to 17]
 - U1-01 [Frequency Reference]
 - U1-02 [Output Frequency]
 - U1-05 [Motor Speed]
 - U1-16 [SFS Output Frequency]
 - U4-14 [PeakHold Output Freq]
- For monitor 2, the setting value is always 0 [Hz Unit].

0 : 0.01 Hz**1 : 0.01% (100% = E1-04)**

The maximum output frequency is 100%.

2 : min⁻¹ (r/min) units

The drive uses the maximum output frequency and number of motor poles to calculate this value automatically.

Note:

When you set *o1-03* = 2 [min⁻¹ (r/min) units], make sure that you set the number of motor poles in these parameters:

- E2-04 [Motor Pole Count]
- E4-04 [Motor 2 Motor Poles]
- E5-04 [PM Motor Pole Count]
- E9-08 [Number of Poles]





3 : User Units (o1-10 & o1-11)

Uses *o1-10* and *o1-11* to set the unit of measure. The value of parameter *o1-10* is the value when you remove the decimal point from the maximum output frequency. Parameter *o1-11* is to the number of digits after the decimal point in the maximum output frequency.

To display a maximum output frequency of 100.00, set parameters to these values:

- *o1-10* = 10000
- *o1-11* = 2 [User Units Decimal Position = 2 Dec (XXX.XX)]

■ o1-04: V/f Pattern Display Unit

No. (Hex.)	Name	Description	Default (Range)
<i>o1-04</i> (0503)	V/f Pattern Display Unit	     Sets the setting unit for parameters that set the V/f pattern frequency.	Determined by A1-02 (0, 1)

Note:

- Select the setting unit of these parameters:
 - E1-04 [Maximum Output Frequency]
 - E1-06 [Base Frequency]
 - E1-07 [Mid Point A Frequency]
 - E1-09 [Minimum Output Frequency]
 - E1-11 [Mid Point B Frequency]
 - E9-02 [Maximum Speed]
 - E9-04 [Base Frequency]
- For monitor 2, the setting value is always 0 [Hz Unit].

0 : Hz**1 : min⁻¹ (r/min) units**

When you set *o1-04* = 1, make sure that you set the number of motor poles in these parameters:

- E5-04 [PM Motor Pole Count]
- E9-08 [Motor Pole Count]

■ o1-05: LCD Contrast Adjustment

No. (Hex.)	Name	Description	Default (Range)
o1-05 (0504) RUN	LCD Contrast Adjustment	<div style="display: flex; gap: 5px;"> V/f OLV OLV/PM AOLV/PM EZOLV </div> Sets the contrast of the LCD display on the keypad.	5 (0 - 10)

When you decrease the setting value, the contrast of the LCD display decreases. When you increase the setting value, the contrast increases.

■ o1-10: User Units Maximum Value

No. (Hex.)	Name	Description	Default (Range)
o1-10 (0520)	User Units Maximum Value	<div style="display: flex; gap: 5px;"> V/f OLV OLV/PM AOLV/PM EZOLV </div> Sets the value that the drive shows as the maximum output frequency.	Determined by o1-03 (1 - 60000)

To display a maximum output frequency of 100.00, set parameters to these values:

- o1-10 = 10000
- o1-11 = 2 [User Units Decimal Position = Two Decimal Places (XXX.XX)]

Note:

Set o1-03 = 3 [Frequency Display Unit Selection = User Units (o1-10 & o1-11)] before you set o1-10 and o1-11.

■ o1-11: User Units Decimal Position

No. (Hex.)	Name	Description	Default (Range)
o1-11 (0521)	User Units Decimal Position	<div style="display: flex; gap: 5px;"> V/f OLV OLV/PM AOLV/PM EZOLV </div> Sets the number of decimal places for frequency reference and monitor values.	Determined by o1-03 (0 - 3)

0 : No Decimal Places (XXXXX)

1 : One Decimal Places (XXXX.X)

2 : Two Decimal Places (XXX.XX)

3 : Three Decimal Places (XX.XXX)

Note:

Set o1-03 = 3 [Frequency Display Unit Selection = User Units (o1-10 & o1-11)] before you set o1-10 [User Units Maximum Value] and o1-11.

■ o1-24 to o1-35: Custom Monitor 1 to 12





No. (Hex.)	Name	Description	Default (Range)
o1-24 to o1-35: (11AD - 11B8) RUN	Custom Monitor 1 to 12	<div style="display: flex; gap: 5px;"> V/f OLV OLV/PM AOLV/PM EZOLV </div> Sets a maximum of 12 monitors as user monitors. This parameter is only available when using an LCD keypad.	o1-24: 101 o1-25: 102 o1-26: 103 o1-27 to o1-35: 0 (0, 101 - 999)

These parameters save the monitor items selected by the LCD keypad [Custom Monitor].

Note:





- You can show a maximum of three selected monitors on one LCD keypad screen.
 - When you select only one monitor, the text size of this monitor increases. For example, when $o1-25$ to $o1-35 = 0$, the text size of the monitor saved in $o1-24$ increases.
 - When you select two monitors, the text size of these monitors increase.
 - When you select four or more monitors, the fourth monitor and all additional monitors are shown on the next screens.
- Monitors selected with $o1-24$ to $o1-26$ can be displayed as a bar graph, analog gauge, or trend plot.
 - Bar graph display: 3 monitors maximum
Select with $o1-24$, $o1-25$, and $o1-26$.
 - Analog gauge display: 1 monitor
Select with $o1-24$.
 - Trend plot display: 2 monitors
Select with $o1-24$ and $o1-25$.
- You can only set parameters $o1-24$ to $o1-26$ with analog output monitors.
- You can set all monitors to parameters $o1-27$ to $o1-35$.

■ o1-36: LCD Backlight Brightness

No. (Hex.)	Name	Description	Default (Range)
o1-36 (11B9) RUN	LCD Backlight Brightness	     Sets the intensity of the LCD keypad backlight.	5 (1 - 5)

When you decrease the setting value, the intensity of the backlight decreases.

■ o1-37: LCD Backlight ON/OFF Selection

No. (Hex.)	Name	Description	Default (Range)
o1-37 (11BA) RUN	LCD Backlight ON/OFF Selection	     Sets the automatic shut off function for the LCD backlight.	1 (0, 1)

Note:



Use $o1-36$ [LCD Backlight Brightness] to adjust the intensity of the LCD backlight.

0 : OFF

The backlight will automatically turn off after the time set in $o1-38$ [LCD Backlight Off-Delay] is expired.

When the backlight is off, push a key on the keypad to temporarily turn the backlight on. After the backlight turns on, it will turn off automatically after the time set in $o1-38$ is expired.





Note:

When the backlight is off, push a key on the keypad to temporarily turn the backlight on. Push any key to start keypad operation. Push  to turn the backlight on, then push  again to enter a Run command to the drive.

1 : ON

The backlight will always be ON.

■ o1-38: LCD Backlight Off-Delay

No. (Hex.)	Name	Description	Default (Range)
o1-38 (11BB) RUN	LCD Backlight Off-Delay	     Sets the time until the LCD backlight automatically turns off.	60 s (10 - 300 s)

When $o1-37 = 0$ [LCD Backlight ON/OFF Selection = OFF], the backlight will automatically turn off after the time set in $o1-38$ expires.

When the backlight is off, push a key on the keypad to temporarily turn the backlight on. After the backlight turns on, it will turn off automatically after the time set in $o1-38$ is expired.

■ o1-39: Show Initial Setup Screen

No. (Hex.)	Name	Description	Default (Range)
o1-39 (11BC) RUN	Show Initial Setup Screen	V/f OLV OLV/PM AOLV/PM EZOLV Sets the function to show the LCD keypad initial setup screen each time you energize the drive. This parameter is only available with an LCD keypad.	1 (0, 1)

The initial setup screen shows a menu where you can select the display language, set the date, time, and other basic settings. When you set this parameter to 0, the drive will not show this screen each time you energize the drive.

0 : No

The drive will not show the initial setup display screen each time you energize the drive. The drive will show the Home screen.

1 : Yes

When you input the Run command before you energize the drive or when you turn on the Run command while the drive shows the initial setup screen, the drive will replace the initial setup screen with the Home screen.

■ o1-40: Home Screen Display Selection

No. (Hex.)	Name	Description	Default (Range)
o1-40 (11BD) RUN	Home Screen Display Selection	V/f OLV OLV/PM AOLV/PM EZOLV Sets the monitor display mode for the Home screen. This parameter is only available with an LCD keypad.	0 (0 - 3)

0 : Custom Monitor

1 : Bar Graph

2 : Analog Gauge

3 : Trend Plot

■ o1-41: 1st Monitor Area Selection

No. (Hex.)	Name	Description	Default (Range)
o1-41 (11C1) RUN	1st Monitor Area Selection	V/f OLV OLV/PM AOLV/PM EZOLV Sets the horizontal axis value used to display the monitor set in o1-24 [Custom Monitor 1] as a bar graph. This parameter is only available with an LCD keypad.	0 (0 - 1)

0 : +/- Area (- o1-42 ~ o1-42)

1 : + Area (0 ~ o1-42)

■ o1-42: 1st Monitor Area Setting

No. (Hex.)	Name	Description	Default (Range)
o1-42 (11C2) RUN	1st Monitor Area Setting	V/f OLV OLV/PM AOLV/PM EZOLV Sets the horizontal axis value used to display the monitor set in o1-24 [Custom Monitor 1] as a bar graph. This parameter is only available with an LCD keypad.	100.0% (0.0 - 100.0%)

■ o1-43: 2nd Monitor Area Selection

No. (Hex.)	Name	Description	Default (Range)
o1-43 (11C3) RUN	2nd Monitor Area Selection	V/f OLV OLV/PM AOLV/PM EZOLV Selects the horizontal range used to display the monitor set in o1-25 [Custom Monitor 2] as a bar graph. This parameter is only available with an LCD keypad.	0 (0 - 1)

0 : +/- Area (- o1-44 ~ o1-44)

1 : + Area (0 ~ o1-44)

■ o1-44: 2nd Monitor Area Setting

No. (Hex.)	Name	Description	Default (Range)
o1-44 (11C4) RUN	2nd Monitor Area Setting	<div style="display: flex; justify-content: space-between; align-items: center;"> V/f OLV OLV/PM AOLV/PM EZOLV </div> <p>Sets the horizontal axis value used to display the monitor set in o1-25 [Custom Monitor 2] as a bar graph. This parameter is only available with an LCD keypad.</p>	100.0% (0.0 - 100.0%)

■ o1-45: 3rd Monitor Area Selection

No. (Hex.)	Name	Description	Default (Range)
o1-45 (11C5) RUN	3rd Monitor Area Selection	<div style="display: flex; justify-content: space-between; align-items: center;"> V/f OLV OLV/PM AOLV/PM EZOLV </div> <p>Sets the horizontal axis value used to display the monitor set in o1-26 [Custom Monitor 3] as a bar graph. This parameter is only available with an LCD keypad.</p>	0 (0 - 1)

0 : +/- Area (- o1-46 ~ o1-46)

1 : + Area (0 ~ o1-46)

■ o1-46: 3rd Monitor Area Setting

No. (Hex.)	Name	Description	Default (Range)
o1-46 (11C6) RUN	3rd Monitor Area Setting	<div style="display: flex; justify-content: space-between; align-items: center;"> V/f OLV OLV/PM AOLV/PM EZOLV </div> <p>Sets the horizontal axis value used to display the monitor set in o1-26 [Custom Monitor 3] as a bar graph. This parameter is only available with an LCD keypad.</p>	100.0% (0.0 - 100.0%)

■ o1-47: Trend Plot 1 Scale Minimum Value

No. (Hex.)	Name	Description	Default (Range)
o1-47 (11C7) RUN	Trend Plot 1 Scale Minimum Value	<div style="display: flex; justify-content: space-between; align-items: center;"> V/f OLV OLV/PM AOLV/PM EZOLV </div> <p>Sets the horizontal axis minimum value used to display the monitor set in o1-24 [Custom Monitor 1] as a trend plot. This parameter is only available with an LCD keypad.</p>	-100.0% (-300.0 - +299.9%)

Note:

Parameter o1-48 [Trend Plot 1 Scale Maximum Value] sets the upper limit. The upper limit is (o1-48 - 0.1)%.

■ o1-48: Trend Plot 1 Scale Maximum Value

No. (Hex.)	Name	Description	Default (Range)
o1-48 (11C8) RUN	Trend Plot 1 Scale Maximum Value	<div style="display: flex; justify-content: space-between; align-items: center;"> V/f OLV OLV/PM AOLV/PM EZOLV </div> <p>Sets the maximum value for the vertical axis used to display the monitor that was set in o1-24 [Custom Monitor 1] as a trend plot. This parameter is only available with an LCD keypad.</p>	100.0% (-299.9 - +300.0%)

Note:

Parameter o1-47 [Trend Plot 1 Scale Minimum Value] sets the lower limit. The lower limit is (o1-47 + 0.1)%.

■ o1-49: Trend Plot 2 Scale Minimum Value

No. (Hex.)	Name	Description	Default (Range)
o1-49 (11C9) RUN	Trend Plot 2 Scale Minimum Value	<div style="display: flex; justify-content: space-between; align-items: center;"> V/f OLV OLV/PM AOLV/PM EZOLV </div> <p>Sets the horizontal axis minimum value used to display the monitor set in o1-25 [Custom Monitor 2] as a trend plot. This parameter is only available with an LCD keypad.</p>	-100.0% (-300.0 - +299.9%)

Note:

Parameter o1-50 [Trend Plot 2 Scale Maximum Value] sets the upper limit. The upper limit is (o1-50 - 0.1)%.

■ o1-50: Trend Plot 2 Scale Maximum Value

No. (Hex.)	Name	Description	Default (Range)
o1-50 (11CA) RUN	Trend Plot 2 Scale Maximum Value	<div style="display: flex; justify-content: space-between; align-items: center;"> V/f OLV OLV/PM AOLV/PM EZOLV </div> <p>Sets the maximum value for the vertical axis used to display the monitor that was set in o1-25 [Custom Monitor 2] as a trend plot. This parameter is only available with an LCD keypad.</p>	100.0% (-299.9 - +300.0%)

Note:

Parameter o1-49 [Trend Plot 2 Scale Minimum Value] sets the lower limit. The lower limit is (o1-49 + 0.1)%.

■ o1-51: Trend Plot Time Scale Setting

No. (Hex.)	Name	Description	Default (Range)
o1-51 (11CB) RUN	Trend Plot Time Scale Setting	<div style="display: flex; justify-content: space-between; align-items: center;"> V/f OLV OLV/PM AOLV/PM EZOLV </div> <p>Sets the time scale (horizontal axis) to display the trend plot. When you change this setting, the drive automatically adjusts the data sampling time. This parameter is only available with an LCD keypad.</p>	300 s (1 - 3600 s)

■ o1-55: Analog Gauge Area Selection

No. (Hex.)	Name	Description	Default (Range)
o1-55 (11EE) RUN	Analog Gauge Area Selection	<div style="display: flex; justify-content: space-between; align-items: center;"> V/f OLV OLV/PM AOLV/PM EZOLV </div> <p>Sets the range used to display the monitor set in o1-24 [Custom Monitor 1] as an analog gauge. This parameter is only available with an LCD keypad.</p>	1 (0, 1)

0 : +/- Area (- o1-56 ~ o1-56)

1 : + Area (0 ~ o1-56)

■ o1-56: Analog Gauge Area Setting

No. (Hex.)	Name	Description	Default (Range)
o1-56 (11EF) RUN	Analog Gauge Area Setting	<div style="display: flex; justify-content: space-between; align-items: center;"> V/f OLV OLV/PM AOLV/PM EZOLV </div> <p>Sets the value used to display the monitor set in o1-24 [Custom Monitor 1] as an analog meter. This parameter is only available with an LCD keypad.</p>	100.0% (0.0 - 100.0%)

■ o1-58: Motor Power Unit Selection

No. (Hex.)	Name	Description	Default (Range)
o1-58 (3125)	Motor Power Unit Selection	<div style="display: flex; justify-content: space-between; align-items: center;"> V/f OLV OLV/PM AOLV/PM EZOLV </div> <p>Sets the setting unit for parameters that set the motor rated power.</p>	1 (0, 1)

The drive shows these parameter values in the set units:

- E2-11 [Motor Rated Power]
- E4-11 [Motor 2 Rated Power]
- E5-02 [PM Motor Rated Power]
- E9-07 [Motor Rated Power]
- T1-02 [Motor Rated Power]
- T2-04 [PM Motor Rated Power]
- T4-08 [Motor Rated Capacity]

0 : kW

Shows the motor output in kW units.

1 : HP



Shows the motor output in HP units.

Note:

When you use an LED keypad, use o1-58 to make sure that the units for the monitors and parameters are correct.

◆ o2: Keypad Operation

■ o2-01: LO/RE Key Function Selection

No. (Hex.)	Name	Description	Default (Range)
o2-01 (0505)	LO/RE Key Function Selection	 Sets the function that lets you use  to switch between LOCAL and REMOTE Modes.	1 (0, 1)

0 : Disabled

You cannot use  to switch between LOCAL and REMOTE Modes.

1 : Enabled

You can use  to switch between LOCAL and REMOTE Modes when the drive is stopped. When LOCAL Mode is selected,  on the keypad will come on.



WARNING! Sudden Movement Hazard. If you change the control source when b1-07 = 1 [LOCAL/REMOTE Run Selection = Accept Existing RUN Command], the drive can start suddenly. Before you change the control source, remove all personnel from the area around the drive, motor, and load. Sudden starts can cause serious injury or death.

WARNING! Sudden Movement Hazard. Fully examine all mechanical and electrical connections before you change o2-01 [LO/RE Key Function Selection] or b1-07 [LOCAL/REMOTE Run Selection]. Sudden starts can cause serious injury or death. If b1-07 = 1 [Accept Existing RUN Command] and there is an active Run command when you switch from LOCAL to REMOTE Mode, the drive can start suddenly.

Table 2.65 Function Settings with o2-01 and b1-07

 Function Selection	LOCAL/REMOTE Run Selection	Switching from LOCAL Mode to REMOTE Mode	Switching from REMOTE Mode to LOCAL Mode
o2-01 = 0 [Disabled]	b1-07 = 0 [Disregard Existing RUN Command]	The drive will not switch modes.	The drive will not switch modes.
	b1-07 = 1 [Accept Existing RUN Command]		
o2-01 = 1 [Enabled]	b1-07 = 0 [Disregard Existing RUN Command]	The drive will not start operating although the Run command is active. When you set Run command to active again, the drive will start to run.	The drive cannot operate because the Run command is not enabled.
	b1-07 = 1 [Accept Existing RUN Command]	When the Run command is active, the drive will start to run immediately when the mode switches from LOCAL to REMOTE.	The drive cannot operate because the Run command is not enabled.

■ o2-02: STOP Key Function Selection

No. (Hex.)	Name	Description	Default (Setting Range)
o2-02 (0506)	STOP Key Function Selection	 Sets the function to use  on the keypad to stop the drive when the Run command source for the drive is REMOTE (external) and not assigned to the keypad.	1 (0, 1)

0 : Disabled

1 : Enabled

 stays enabled when the Run command source has not been assigned to the keypad.

To start the drive again after you push  to stop operation, turn the external Run command OFF and ON again.

■ o2-03: User Parameter Default Value

No. (Hex.)	Name	Description	Default (Range)
o2-03 (0507)	User Parameter Default Value	 Sets the function to keep the settings of changed parameters as user parameter defaults to use during initialization.	0 (0 - 2)

2.11 o: Keypad-Related Settings

When you set $o2-03 = 1$ [Set defaults], the drive saves changed parameter settings as user parameter setting values in a part of the memory that is isolated from drive parameters.

When you set $A1-03 = 1110$ [Initialize Parameters = User Initialization] to initialize the drive, the drive resets the internal parameter setting values to those user parameter setting values.

0 : No change

1 : Set defaults

Saves changed parameter setting values as user default settings.





Set $o2-03 = 1$ then push  to save the user parameter setting values. After the drive saves the setting value, $o2-03$ automatically resets to 0.

2 : Clear all

Deletes all of the saved user parameter setting values.

Set $o2-03 = 2$ then push  to clear the user parameter setting values. The drive will automatically reset $o2-03$ to 0. If you delete the user parameter setting values, you cannot set $A1-03 = 1110$ to initialize parameters.

■ o2-04: Drive Model (KVA) Selection

No. (Hex.)	Name	Description	Default (Setting Range)
o2-04 (0508)	Drive Model (KVA) Selection	     Sets the Drive Model code. Set this parameter after replacing the control board.	Determined by the drive (-)

NOTICE: Set $o2-04$ [Drive Model (KVA) Selection] correctly. If you set this parameter incorrectly, it will decrease drive performance, cause the protection function to operate incorrectly, and cause damage to the drive.

Note:



When the setting value of $o2-04$ changes, related parameter setting values also change. Refer to [Defaults by Drive Model and Duty Rating ND/HD on page 130](#) for more information.

Table 2.66 lists the relation between $o2-04$ setting values and drive models.

Table 2.66 Drive Models and o2-04 Settings

Drive Model	o2-04 Setting	Drive Model	o2-04 Setting
B001	30	2056	6D
B002	31	2070	6E
B004	32	2082	6F
B006	33	4001	91
B010	34	4002	92
B012	35	4004	93
B018	37	4005	94
2001	60	4007	95
2002	61	4009	96
2004	62	4012	97
2006	63	4018	99
2010	65	4023	9A
2012	66	4031	9C
2021	68	4038	9D
2030	6A	4044	9E
2042	6B	4060	9F



■ o2-05: Home Mode Freq Ref Entry Mode

No. (Hex.)	Name	Description	Default (Setting Range)
o2-05 (0509)	Home Mode Freq Ref Entry Mode	 Sets the function that makes it necessary to push  to use the keypad to change the frequency reference value while in Drive Mode.	0 (0, 1)

0 : ENTER Key Required

You must push  to use the keypad to change the frequency reference value.

1 : Immediate / MOP-style

The frequency reference changes when you enter it with the keypad. This then changes the output frequency. It is not necessary to push . The drive keeps the frequency reference for 5 seconds after you use  and  on the keypad to change the frequency reference value.

■ o2-06: Keypad Disconnect Detection

No. (Hex.)	Name	Description	Default (Range)
o2-06 (050A)	Keypad Disconnect Detection	 Sets the function that stops the drive if you disconnect the keypad connection cable from the drive or if you damage the cable while the keypad is the Run command source.	1 (0, 1)

This parameter continues to operate if the keypad installed to the drive becomes disconnected.

This parameter is enabled in these conditions:

- When $b1-02 = 0$ [Run Command Selection 1 = Keypad] or $b1-16 = 0$ [Run Command Selection 2 = Keypad]
- In LOCAL Mode

0 : Disabled

The drive continues operation when it detects a keypad disconnection.

1 : Enabled

The drive stops operation, detects oPr [Keypad Connection Fault], and the motor coasts to stop when the drive detects a keypad disconnection.

■ o2-07: Keypad RUN Direction @ Power-up

No. (Hex.)	Name	Description	Default (Range)
o2-07 (0527)	Keypad RUN Direction @ Power-up	 Sets the direction of motor rotation when the drive is energized and the keypad is the Run command source.	0 (0, 1)

This parameter is enabled in these conditions:

- When $b1-02 = 0$ [Run Command Selection 1 = Keypad] or $b1-16 = 0$ [Run Command Selection 2 = Keypad]
- In LOCAL Mode

0 : Forward

1 : Reverse

■ o2-09: Reserved

No. (Hex.)	Name	Description	Default (Range)
o2-09 (050D)	Reserved	-	-

■ o2-19: Parameter Write during Uv

No. (Hex.)	Name	Description	Default (Range)
o2-19 (061F) Expert	Parameter Write during Uv	V/f OLV OLV/PM AOLV/PM EZOLV Lets you change parameters during Uv [<i>Undervoltage</i>].	0 (0, 1)

0 : Disable

1 : Enabled

■ o2-23: External 24V Powerloss Detection

No. (Hex.)	Name	Description	Default (Setting Range)
o2-23 (11F8) RUN	External 24V Powerloss Detection	V/f OLV OLV/PM AOLV/PM EZOLV Sets the function to give a warning if the backup external 24 V power supply turns off when the main circuit power supply is in operation.	0 (0, 1)

Note:

The drive will not run when it is operating from one 24-V external power supply.

0 : Disabled

The drive does not detect the loss of the 24-V external power supply.

1 : Enabled

The keypad shows the *L24v* [*Loss of External Power 24 Supply*] indicator if the drive detects the loss of the 24-V external power supply.

Note:

A minor fault signal is not output from *H2-xx = 10* [*MFDO Function Selection = Alarm*].

■ o2-26: Alarm Display at Ext. 24V Power

No. (Hex.)	Name	Description	Default (Range)
o2-26 (1563)	Alarm Display at Ext. 24V Power	V/f OLV OLV/PM AOLV/PM EZOLV When you connect a backup external 24 V power supply, this parameter sets the function to trigger an alarm when the main circuit power supply voltage decreases.	1 (0, 1)

0 : Disabled

The drive will not detect *EP24v* [*External Power 24V Supply*] if the main circuit power supply voltage decreases. The [Ready] light on the LED Status Ring flashes quickly to identify that drive operation is not possible.

1 : Enabled

The drive detects *EP24v* when the main circuit power supply voltage decreases.

Note:

A minor fault signal is not output from *H2-xx = 10* [*MFDO Function Selection = Alarm*].

■ o2-27: bCE Detection Selection

No. (Hex.)	Name	Description	Default (Range)
o2-27 (1565)	bCE Detection Selection	V/f OLV OLV/PM AOLV/PM EZOLV Sets drive operation if the Bluetooth device is disconnected when you operate the drive in Bluetooth Mode.	3 (0 - 4)

0 : Ramp to Stop

1 : Coast to Stop

2 : Fast Stop (Use C1-09)

3 : Alarm Only

4 : No Alarm Display

◆ o3: Copy Function

o3 parameters set the operation of the parameter backup function.

■ o3-01: Copy Keypad Function Selection

No. (Hex.)	Name	Description	Default (Range)
o3-01 (0515)	Copy Keypad Function Selection	V/f OLV OLV/PM AOLV/PM EZOLV Sets the function that saves and copies drive parameters to a different drive with the keypad.	0 (0 - 4)

0 : Copy Select

1 : Backup (drive → keypad)

The parameter setting values are read from the drive and saved in the keypad.

2 : Restore (keypad → drive)

Copies the parameter setting values saved in the keypad to a different drive.

3 : Verify (check for mismatch)

Makes sure that the parameter setting values in the drive agree with the parameters saved in the keypad.

4 : Erase (backup data of keypad)

Deletes the parameter setting values saved in the keypad.

■ o3-02: Copy Allowed Selection

No. (Hex.)	Name	Description	Default (Range)
o3-02 (0516)	Copy Allowed Selection	V/f OLV OLV/PM AOLV/PM EZOLV Sets the copy function when <i>o3-01</i> = 1 [<i>Copy Keypad Function Selection</i> = Backup (drive → keypad)].	0 (0, 1)

Note:

When you select [Parameter Backup] on the keypad menu screen to do the backup function, the drive automatically sets *o3-02* = 1.

0 : Disabled

1 : Enabled

■ o3-04: Select Backup/Restore Location

No. (Hex.)	Name	Description	Default (Range)
o3-04 (0B3E)	Select Backup/Restore Location	V/f OLV OLV/PM AOLV/PM EZOLV Sets the storage location for drive parameters when you back up and restore parameters. This parameter is only available when using an LCD keypad.	0 (0 - 3)

You can use the LCD keypad to make a maximum of 4 parameter backup sets.

0 : Memory Location 1

1 : Memory Location 2

2 : Memory Location 3

3 : Memory Location 4

■ o3-05: Select Items to Backup/Restore

No. (Hex.)	Name	Description	Default (Range)
o3-05 (0BDA)	Select Items to Backup/Restore	V/f OLV OLV/PM AOLV/PM EZOLV Sets which parameters are backed up, restored, and referenced. This parameter is only available when using an LCD keypad.	1 (0, 1)

0 : Standard Parameters

1 : Standard + DWEZ Parameters

2.11 o: Keypad-Related Settings

Note:

- Parameters *qx-xx* [DriveWorksEZ Parameters] and *rx-xx* [DriveWorksEZ Connections] show when $A1-07 = 1$ or 2 [DriveWorksEZ Function Selection = DWEZ Enabled or Enabled/Disabled wDigital Input].
- The password for DriveWorksEZ PC software is necessary to back up *qx-xx* and *rx-xx*. If you enter an incorrect password, the drive detects *PWEr* [DWEZ Password Mismatch].

■ o3-06: Auto Parameter Backup Selection

No. (Hex.)	Name	Description	Default (Range)
o3-06 (0BDE)	Auto Parameter Backup Selection	V/f OLV OLV/PM AOLV/PM EZOLV Sets the function that automatically backs up parameters. This parameter is only available when using an LCD keypad.	1 (0, 1)

When you connect the drive and keypad, parameters set to the drive are automatically backed up to the keypad as specified by the setting of parameters *o3-06* and *o3-07*.

0 : Disabled

1 : Enabled

Note:

When you replace the LCD keypad then energize the drive, the keypad shows the restore operation screen automatically to restore the drive configuration with the parameters backed up to the LCD keypad. If you connect an LCD keypad that does not have parameter backup data, the keypad will not show the restore operation screen.

■ o3-07: Auto Parameter Backup Interval

No. (Hex.)	Name	Description	Default (Range)
o3-07 (0BDF)	Auto Parameter Backup Interval	V/f OLV OLV/PM AOLV/PM EZOLV Sets the interval at which the automatic parameter backup function saves parameters from the drive to the keypad.	1 (0 - 3)

The drive saves parameter settings to the keypad at these times:

- After you energize the drive and the auto backup period passes.
- When you use ROM enter or the keypad to change parameters, the drive saves those changes in the drive, waits for the auto backup period to pass, then saves those parameters in the keypad.

Note:

The drive can write data to the keypad a maximum of 100,000 times. If you write data to the keypad more than 100,000 times, you must replace the keypad.

0 : Every 10 minutes

1 : Every 30 minutes

2 : Every 60 minutes

3 : Every 12 hours

◆ o4: Maintenance Mon Settings

o4 parameters set the expected service life to help you know when to replace parts. The drive will show an alarm to tell you when the replacement part interval is near.

■ o4-01: Elapsed Operating Time Setting

No. (Hex.)	Name	Description	Default (Range)
o4-01 (050B)	Elapsed Operating Time Setting	V/f OLV OLV/PM AOLV/PM EZOLV Sets the initial value of the cumulative drive operation time in 10-hour units.	0 h (0 - 9999 h)

When you select *o4-01* on the keypad, it will show the current value of *U4-01* in units of 10 hours (h). When you change the setting of *o4-01* through the monitor, the *U4-01* count starts again as specified by the setting of *o4-01*.

Note:

Set this parameter in 10-hour (h) units. When $o4-01 = 30$, $U4-01$ [Cumulative Ope Time] = 300 h.

■ o4-02: Elapsed Operating Time Selection

No. (Hex.)	Name	Description	Default (Range)
o4-02 (050C)	Elapsed Operating Time Selection	V/f OLV OLV/PM AOLV/PM EZOLV Sets the condition that counts the cumulative operation time.	0 (0, 1)

0 : U4-01 Shows Total Power-up Time

Counts the time from when the drive is energized to when it is de-energized.

1 : U4-01 Shows Total RUN Time

Counts the time that the drive outputs voltage.

■ o4-03: Fan Operation Time Setting

No. (Hex.)	Name	Description	Default (Range)
o4-03 (050E)	Fan Operation Time Setting	V/f OLV OLV/PM AOLV/PM EZOLV Sets the value from which to start the cumulative drive cooling fan operation time in 10-hour units.	0 h (0 - 9999 h)

Use monitor *U4-03 [Cooling Fan Ope Time]* to view the total operation time of the cooling fan. When you replace a cooling fan, set *o4-03 = 0* to reset *U4-03*. Select *o4-03* on the keypad to show the current value of *U4-03* in 10-hour (h) units. If you use the monitor to change *o4-03*, the recount of *U4-03* starts with the *o4-03* setting.

Note:

The drive sets *o4-03* in 10-hour (h) units. When *o4-03 = 30*, *U4-03 [Cooling Fan Ope Time]* will show "300 h".

■ o4-05: Capacitor Maintenance Setting

No. (Hex.)	Name	Description	Default (Range)
o4-05 (051D)	Capacitor Maintenance Setting	V/f OLV OLV/PM AOLV/PM EZOLV Sets the <i>U4-05 [CapacitorMaintenance]</i> monitor value.	0% (0 - 150%)

When you replace a drive, set *o4-05 = 0* to reset *U4-05*. When the *o4-05* setting changes, the count of *U4-05* starts again as specified by the setting of *o4-05*. After you complete the configuration, *o4-05* automatically resets to 0.

Note:

The maintenance period changes for different operating environments.

■ o4-07: Softcharge Relay Maintenance Set

No. (Hex.)	Name	Description	Default (Range)
o4-07 (0523)	Softcharge Relay Maintenance Set	V/f OLV OLV/PM AOLV/PM EZOLV Sets the <i>U4-06 [PreChargeRelayMainte]</i> monitor value.	0% (0 - 150%)

When you replace a drive, set *o4-07 = 0* to reset *U4-06*. When the *o4-07* setting changes, the count of *U4-06* starts again as specified by the setting of *o4-07*. After you complete the configuration, *o4-07* automatically resets to 0.

Note:

The maintenance period changes for different operating environments.

■ o4-09: IGBT Maintenance Setting

No. (Hex.)	Name	Description	Default (Range)
o4-09 (0525)	IGBT Maintenance Setting	V/f OLV OLV/PM AOLV/PM EZOLV Sets the <i>U4-07 [IGBT Maintenance]</i> monitor value.	0% (0 - 150%)

When you replace a drive, set *o4-09 = 0* to reset *U4-07*. When the *o4-09* setting changes, the count of *U4-07* starts again as specified by the setting of *o4-09*. After you complete the configuration, *o4-09* automatically resets to 0.

Note:

The maintenance period changes for different operating environments.

■ o4-11: Fault Trace/History Init (U2/U3)

No. (Hex.)	Name	Description	Default (Range)
o4-11 (0510)	Fault Trace/History Init (U2/U3)	V/f OLV OLV/PM AOLV/PM EZOLV Resets the records of Monitors U2-xx [Fault Trace] and U3-xx [Fault History].	0 (0, 1)

Note:

When you initialize the drive with A1-03 [Initialize Parameters], the drive will not reset the records for U2-xx and U3-xx.

0 : Disabled

Keeps the records of Monitors U2-xx and U3-xx.

1 : Enabled

Resets the records for Monitors U2-xx and U3-xx. After the reset, the drive automatically resets o4-11 to 0.

■ o4-12: kWh Monitor Initialization

No. (Hex.)	Name	Description	Default (Range)
o4-12 (0512)	kWh Monitor Initialization	V/f OLV OLV/PM AOLV/PM EZOLV Resets the monitor values for U4-10 [kWh, Lower 4 Digits] and U4-11 [kWh, Upper 5 Digits].	0 (0, 1)

Note:

When you initialize the drive with A1-03 [Initialize Parameters], the drive will not reset U4-10 and U4-11.

0 : No Reset

Keeps the monitor values for U4-10 and U4-11.

1 : Reset

Resets the values of U4-10 and U4-11. After the reset, the drive automatically resets o4-12 to 0.

■ o4-13: RUN Command Counter @ Initialize

No. (Hex.)	Name	Description	Default (Range)
o4-13 (0528)	RUN Command Counter @ Initialize	V/f OLV OLV/PM AOLV/PM EZOLV Resets the monitor values for U4-02 [Num of Run Commands], U4-24 [Number of Runs (Low)], and U4-25 [Number of Runs (High)].	0 (0, 1)

0 : No Reset

Keeps the monitor values for U4-02, U4-24, and U4-25.

1 : Reset

Resets the values of U4-02, U4-24, and U4-25. After the reset, the drive automatically resets o4-13 to 0.

■ o4-22: Time Format

No. (Hex.)	Name	Description	Default (Range)
o4-22 (154F) RUN	Time Format	V/f OLV OLV/PM AOLV/PM EZOLV Sets the time display format. This parameter is only available when using an LCD keypad.	1 (0 - 2)

Sets the display of the time shown in the upper-left of the LCD keypad screen.

0 : 24 Hour Clock

1 : 12 Hour Clock

2 : 12 Hour JP Clock

■ o4-23: Date Format

No. (Hex.)	Name	Description	Default (Range)
o4-23 (1550) RUN	Date Format	<div style="display: flex; justify-content: space-between; border: 1px solid black; padding: 2px;"> V/f OLV OLV/PM AOLV/PM EZOLV </div> Sets the date display format. This parameter is only available when using an LCD keypad.	2 (0 - 2)

Sets the date format that the drive uses for the fault history and other records.

0 : YYYY/MM/DD

1 : DD/MM/YYYY

2 : MM/DD/YYYY

■ o4-24: bAT Detection Selection

No. (Hex.)	Name	Description	Default (Range)
o4-24 (310F) RUN	bAT Detection Selection	<div style="display: flex; justify-content: space-between; border: 1px solid black; padding: 2px;"> V/f OLV OLV/PM AOLV/PM EZOLV </div> Sets the operation when the drive detects <i>bAT</i> [Keypad Battery Low Voltage] and <i>TiM</i> [Keypad Time Not Set]. This parameter is only available when you use an LCD keypad.	0 (0 - 2)

0 : Disable

The drive will not detect *bAT* or *TiM*.

1 : Enable (Alarm Detected)

The keypad shows *bAT* or *TiM* and the drive continues operation. The output terminal set to *Alarm* [H2-01 to H2-03 = 10] activates.

2 : Enable (Fault Detected)

The output turns off and the motor coasts to stop. The output terminal set for *Fault* [H2-01 to H2-03 = E] activates.

◆ o5: Log Function

The data log function saves drive status information as a CSV file in the microSD memory card in the keypad.

Monitors *Ux-xx* are the source of data log information. You can record a maximum of 10 monitors.

Change the LCD keypad screen from the main menu to the Diagnostic Tools screen and select the data log function. Set the number of the monitor to record and the sampling time, then start to record the data log.

Table 2.67 Setting Parameters for Data Log Items

No.	Name	Default	Data Log Monitors
o5-03	Log Monitor Data 1	101	U1-01 [Frequency Reference]
o5-04	Log Monitor Data 2	102	U1-02 [Output Frequency]
o5-05	Log Monitor Data 3	103	U1-03 [Output Current]
o5-06	Log Monitor Data 4	107	U1-07 [DC Bus Voltage]
o5-07	Log Monitor Data 5	108	U1-08 [Output Power]
o5-08	Log Monitor Data 6	A1-02 = 0, 5: 000 A1-02 ≠ 0, 5: 105	A1-02 = 0, 5: Not selected A1-02 ≠ 0, 5: U1-05
o5-09	Log Monitor Data 7	110	U1-10
o5-10	Log Monitor Data 8	112	U1-12
o5-11	Log Monitor Data 9	000	Not selected
o5-12	Log Monitor Data 10	000	Not selected

Note:

- Do not de-energize the drive or disconnect the keypad from the drive during log transfer communication. A loss of connection can cause the log function to fail after you restore power or connect the keypad.
- You can use a microSDHC card that has a maximum of 32 GB capacity.

■ Log File Specifications

Item	Specification
File storage location	A folder called [Log_File] is created in the root directory of the microSD card.
Filename	GLOG0xxx.csv Note: [xxx] identifies a 3-digit decimal number
Maximum number of files	999 (GLOG0001.csv to GLOG0999.csv)
Character code	ASCII code
Line break code	<CR><LF>
Separating character	[,] (Commas)
Header rows	First Row: Drive information including the drive model, software version, control method, and sampling time Second Row: Log data information including the monitor number, number decimal points, and unit code

■ Log File Configuration

The [Log_Files] folder is created in the root directory of the micro SD card. This is where the log data is stored as CSV files. Log data files are created in this configuration. The number of rows changes when the number of selected monitors change.

First Row	Drive information
Second Row	Log data information
Third Row	Log data 1
:	Log data 2
:	Log data 3
:	:
Last Row	Log data n

First Row: Drive Information

This example shows the data text strings and data generated for the first row of log data.

Example of generated data: 00,0012,160107111230,GA500,VSVA01010,2,62,1000,000001

No.	Item	Number of Characters	Example	Description
1	Attribute	2	00	[00] shows that the record is a drive information record.
2	File number	4	0012	Generates the [xxx] part (a 3-digit decimal number) of the [GLOG0xxx.csv] filename of the log data in hexadecimal format. Example filename of [GLOG0018.csv]: 018 (Dec.) = 0012 (Hex.)
3	Time stamp ^{*1}	12	160107111230	Date file was generated • Date: 20YY/MM/DD • Time in 24-hour format: HH:MM:SS Example data of [160107111230]: 11:12:30 on January 7, 2016
4	Model	5	GA500	Drive model information
5	Software number	9	VSVA01011	Drive software number
6	Control Method Selection	1	2	Setting value (Hex.) of A1-02 [Control Method Selection]
7	Drive capacity	2	62	Setting value (Hex.) of o2-04 [Drive Model (KVA) Selection]
8	Sampling time	5 (Maximum)	1000	Setting value (Dec.) of o5-02 [Log Sampling Interval] Unit: ms
9	Row number	6	000001	Row number (Hex.) in the data log file

*1 If you do not set the time in the keypad, the text string of [000000000000] is generated to show the time.

Second Row: Log Data Information

This example shows the data text strings and data generated for the second row of log data.

Example of generated data:

01,0012,160107111230,0101,0201,0102,0201,0103,0206,0107,0005,0108,0209,0000,0000,0000,0000,0000,000,000,0000,0000,0000,0000,0000,0000,0000,0000,0000,000002

No.	Item	Number of Characters	Description
1	Attribute	2	[01] shows that the record is a log data information record.
2	File number	4	Generates the [xxx] part (a 3-digit decimal number) of the [GLOG0xxx.csv] filename of the log data in hexadecimal format.
3	Time stamp	12	Date file was generated
4	Monitor Number 1 *1	4	Monitor number selected by o5-03 [Log Monitor Data 1] Ex.: 0101 (Dec.) for U1-01
5	Monitor Unit 1 *2	4	Unit code and number of decimal places used for the monitor selected with o5-03 Example when U1-01 = 30.00 Hz: Number of decimal places = 2, Hz unit code = 01, monitor unit 1 = 0201 (Hex.)
6	Monitor number 2	4	Monitor number (Dec.) selected by o5-04 [Log Monitor Data 2]
7	Monitor Unit 2	4	Unit code and number of decimal places used for the monitor selected with o5-04
:	:	:	:
22	Monitor number 10	4	Monitor number (Dec.) selected by o5-12 [Log Monitor Data 10]
23	Monitor Unit 10	4	Unit code and number of decimal places used for the monitor selected with o5-12
24 to 27	Reserved	4	-
28	Row number	6	Row number (Hex.) in the data log file

*1 If there is no data log monitor selected, the text string of [0000] is generated.

*2 Refer to Table 2.68 for information about unit codes.

Table 2.68 Unit Codes

Unit Code (Hex.)	Unit	Unit Code (Hex.)	Unit	Unit Code (Hex.)	Unit	Unit Code (Hex.)	Unit
00	-	08	PPR	10	H	18	0H
01	Hz	09	kW	11	V	19	-
02	RPM	0A	Ω	12	us	1A	-
03	%	0B	ms	13	min	1B	-
04	VAC	0C	kHz	14	°C	1C	-
05	VDC	0D	PSI	15	W	1D	-
06	A	0E	MPM	16	kWH	1E	-
07	sec	0F	FPM	17	MWH	1F	-

Third and Subsequent Rows: Log Data

This example shows the data text strings and data generated for the third row of log data.

Example of generated data:

02,0012,160107111239,1770,1770,00BE,0118,0028,0000,0000,0000,0000,0000,0000,0000,0000,00000C

No.	Item	Number of Characters	Description
1	Attribute	2	[02] shows that the record is a monitor data record.
2	File number	4	Generates the [xxx] part (a 3-digit decimal number) of the [GLOG0xxx.csv] filename of the log data in hexadecimal format.
3	Time stamp	12	Data log data was retrieved (YYMMDDHHMMSS)
4	Log Monitor Data 1	4	Log monitor data (Hex.) of the monitor selected with o5-03 [Log Monitor Data 1]
5	Log Monitor Data 2	4	Log monitor data (Hex.) of the monitor selected with o5-04 [Log Monitor Data 2]
:	:	:	:
13	Log Monitor Data 10	4	Log monitor data (Hex.) of the monitor selected with o5-12 [Log Monitor Data 10]
14	Reserved	4	-

2.11 o: Keypad-Related Settings

No.	Item	Number of Characters	Description
15	Encoding data	4	Log Monitor Data 1 to 10 Code Data (Hex.) Bits 0 through 9 show the encoding of log monitor data 1 through 10. A bit value of 1 shows that the data represents a negative value. (Log monitor data 1 through 10 is absolute value data without encoding) Example when log monitor data 2, 5, and 8 show negative values: Bits 1, 4, and 7 have values of 1, and the encoding data = 0010010010 (Bin.) = 0092 (Hex.)
16	Row number	6	Row number (Hex.) in the data log file

■ o5-01: Log Start/Stop Selection

No. (Hex.)	Name	Description	Default (Range)
o5-01 (1551) RUN	Log Start/Stop Selection	<input type="checkbox"/> V/f <input type="checkbox"/> OLV <input type="checkbox"/> OLV/IPM <input type="checkbox"/> AOLV/IPM <input type="checkbox"/> EZOLV Sets the data log function. This parameter is only available when using an LCD keypad.	0 (0 - 1)

0 : OFF

Stops the data log.

1 : ON

Starts the data log as specified by the sampling cycle set in o5-02 [*Log Sampling Interval*].

■ o5-02: Log Sampling Interval

No. (Hex.)	Name	Description	Default (Range)
o5-02 (1552) RUN	Log Sampling Interval	<input type="checkbox"/> V/f <input type="checkbox"/> OLV <input type="checkbox"/> OLV/IPM <input type="checkbox"/> AOLV/IPM <input type="checkbox"/> EZOLV Sets the data log sampling cycle. This parameter is only available when using an LCD keypad.	100 ms (100 - 60000 ms)

■ o5-03: Log Monitor Data 1

No. (Hex.)	Name	Description	Default (Range)
o5-03 (1553) RUN	Log Monitor Data 1	<input type="checkbox"/> V/f <input type="checkbox"/> OLV <input type="checkbox"/> OLV/IPM <input type="checkbox"/> AOLV/IPM <input type="checkbox"/> EZOLV Sets the data log monitor. This parameter is only available with an LCD keypad.	101 (000, 101 - 999)

Note:

Set the number of the *U monitor* to record the data log.

For example, to show *U1-01* [*Frequency Reference*], set o5-03 = 101. When it is not necessary to set data log monitors, set this parameter to 000. You cannot set *U2 monitor* [*Fault Trace*] or *U3 Monitor* [*Fault History*].

■ o5-04: Log Monitor Data 2

No. (Hex.)	Name	Description	Default (Range)
o5-04 (1554) RUN	Log Monitor Data 2	<input type="checkbox"/> V/f <input type="checkbox"/> OLV <input type="checkbox"/> OLV/IPM <input type="checkbox"/> AOLV/IPM <input type="checkbox"/> EZOLV Sets the data log monitor. This parameter is only available when using an LCD keypad.	102 (000, 101 - 999)

Note:

Set the *U monitor* number you will log.

For example, to show *U1-02* [*Output Frequency*], set o5-04 = 102. When it is not necessary to set data log monitor, set this parameter to 000.

■ o5-05: Log Monitor Data 3

No. (Hex.)	Name	Description	Default (Range)
o5-05 (1555) RUN	Log Monitor Data 3	<input type="checkbox"/> V/f <input type="checkbox"/> OLV <input type="checkbox"/> OLV/IPM <input type="checkbox"/> AOLV/IPM <input type="checkbox"/> EZOLV Sets the data log monitor. This parameter is only available with an LCD keypad.	103 (000, 101 - 999)

Note:

Sets the number of the *U* monitor you will log.

For example, to show *U1-03 [Output Current]*, set *o5-05 = 103*. When it is not necessary to set data log monitors, set this parameter to *000*. You cannot select *U2* monitor [*Fault Trace*] or *U3* Monitor [*Fault History*].

o5-06: Log Monitor Data 4

No. (Hex.)	Name	Description	Default (Range)
o5-06 (1556) RUN	Log Monitor Data 4	V/f OLV OLV/PM AOLV/PM EZOLV Sets the data log monitor. This parameter is only available with an LCD keypad.	107 (000, 101 - 999)

Note:

Sets the number of the *U* monitor you will log.

For example, to show *U1-07 [DC Bus Voltage]*, set *o5-06 = 107*. When it is not necessary to set data log monitors, set this parameter to *000*. You cannot select *U2* monitor [*Fault Trace*] or *U3* Monitor [*Fault History*].

o5-07: Log Monitor Data 5

No. (Hex.)	Name	Description	Default (Range)
o5-07 (1557) RUN	Log Monitor Data 5	V/f OLV OLV/PM AOLV/PM EZOLV Sets the data log monitor. This parameter is only available with an LCD keypad.	108 (000, 101 - 999)

Note:

Sets the number of the *U* monitor you will log.

For example, to show *U1-08 [Output Power]*, set *o5-07 = 108*. When it is not necessary to set data log monitors, set this parameter to *000*. You cannot select *U2* monitor [*Fault Trace*] or *U3* Monitor [*Fault History*].

o5-08: Log Monitor Data 6

No. (Hex.)	Name	Description	Default (Setting Range)
o5-08 (1558) RUN	Log Monitor Data 6	V/f OLV OLV/PM AOLV/PM EZOLV Sets the data log monitor. This parameter is only available when using an LCD keypad.	V/f, OLV/PM : 000, OLV, AOLV/PM, EZOLV : 105 (000, 101 - 999)

Note:

Set the *U* monitor number you want to log.

For example, to display *U1-01 [Frequency Reference]*, set *o5-08 = 101*. When it is not necessary to set a data log monitor, set this parameter to *000*. You cannot set *U2* Monitors [*Fault Trace*] or *U3* Monitors [*Fault History*].

o5-09: Log Monitor Data 7

No. (Hex.)	Name	Description	Default (Range)
o5-09 (1559) RUN	Log Monitor Data 7	V/f OLV OLV/PM AOLV/PM EZOLV Sets the data log monitor. This parameter is only available when using an LCD keypad.	110 (000, 101 - 999)

Note:

Set the *U* monitor number you will log.

For example, to show *U1-01 [Frequency Reference]*, set *o5-09 = 101*. When it is not necessary to set data log monitor, set this parameter to *000*.

o5-10: Log Monitor Data 8

No. (Hex.)	Name	Description	Default (Range)
o5-10 (155A) RUN	Log Monitor Data 8	V/f OLV OLV/PM AOLV/PM EZOLV Sets the data log monitor. This parameter is only available with an LCD keypad.	112 (000, 101 - 999)





2.11 o: Keypad-Related Settings

Note:

Sets the number of the *U monitor* you will log.

For example, to show *U1-01 [Frequency Reference]*, set *o5-10 = 101*. When it is not necessary to set data log monitors, set this parameter to *000*. You cannot select *U2 monitor [Fault Trace]* or *U3 Monitor [Fault History]*.

■ o5-11: Log Monitor Data 9





No. (Hex.)	Name	Description	Default (Range)
o5-11 (155B) RUN	Log Monitor Data 9	     Sets the data log monitor. This parameter is only available with an LCD keypad.	000 (000, 101 - 999)

Note:

Sets the number of the *U monitor* you will log.

For example, to show *U1-01 [Frequency Reference]*, set *o5-11 = 101*. When it is not necessary to set data log monitors, set this parameter to *000*. You cannot select *U2 monitor [Fault Trace]* or *U3 Monitor [Fault History]*.

■ o5-12: Log Monitor Data 10

No. (Hex.)	Name	Description	Default (Range)
o5-12 (155C) RUN	Log Monitor Data 10	     Sets the data log monitor. This parameter is only available with an LCD keypad.	000 (000, 101 - 999)

Note:

Sets the number of the *U monitor* you will log.

For example, to show *U1-01 [Frequency Reference]*, set *o5-12 = 101*. When it is not necessary to set data log monitors, set this parameter to *000*. You cannot select *U2 monitor [Fault Trace]* or *U3 Monitor [Fault History]*.





2.12 T: Auto-Tuning

Numbers identifying the *T* parameters are displayed when an LED keypad is used. The names of the parameters are displayed on the LCD screen of the LCD keypad. Set the following.

- Induction Motor Auto-Tuning
- PM Motor Auto-Tuning
- ASR and Inertia Tuning

◆ T0: Tuning Mode Selection

■ T0-00: Tuning Mode Selection

No. (Hex.)	Name	Description	Default (Range)
T0-00 (1197)	Tuning Mode Selection	     Sets the type of Auto-Tuning.	0 (0, 1)

When you use an LED keypad to do Control Tuning, set the tuning mode in this order:

1. Set $T0-00 = 1$.
2. Set $T3-00$ [Control Loop Tuning Selection] to set the tuning mode.

Note:

The available tuning modes are different for different control methods.

0 : Motor Parameter Tuning

1 : Control Tuning





◆ T1: Induction Motor Auto-Tuning

T1 parameters set the Auto-Tuning input data for induction motor tuning.

Note:

- The base frequency of drive dedicated motors and special motors for use with vector control may be lower than the base frequency of general-purpose motors, which is 50 Hz or 60 Hz. In such cases, this lower frequency is used as the value for $E1-06$ [Base Frequency] and $E1-04$ [Maximum Output Frequency] after Auto-Tuning completes. If the maximum output frequency is too low and causes problems, change the setting of $E1-04$ after Auto-Tuning completes.
- The following induction motor parameters are set automatically.
 - $E1-xx$ [V/f Pattern for Motor 1]
 - $E2-xx$ [Motor Parameters]
 - $E3-xx$ [V/f Pattern for Motor 2]
 - $E4-xx$ [Motor 2 Parameters]

■ T1-00: Motor 1/Motor 2 Selection

No. (Hex.)	Name	Description	Default (Range)
T1-00 (0700)	Motor 1/Motor 2 Selection	     Sets which motor to tune when motor 1/2 switching is enabled.	1 (1, 2)

Note:

Set $H1-xx = 16$ [Motor 2 Selection] to enable this parameter. When $H1-xx \neq 16$ the keypad will not show this parameter.

1 : Motor 1

Auto-Tuning automatically sets parameters $E1-xx$ and $E2-xx$ for motor 1.

2 : Motor 2

Auto-Tuning automatically sets parameters $E3-xx$ and $E4-xx$ for motor 2. Make sure that you connect motor 2 to the drive for Auto-Tuning.

■ T1-01: Auto-Tuning Mode Selection

No. (Hex.)	Name	Description	Default (Range)
T1-01 (0701)	Auto-Tuning Mode Selection	<input type="radio"/> V/f <input type="radio"/> OLV <input type="radio"/> OLV/PM <input type="radio"/> AOLV/PM <input type="radio"/> EZOLV Sets the type of Auto-Tuning.	Determined by A1-02 (Determined by A1-02)

0 : Rotational Auto-Tuning

1 : Stationary Auto-Tuning 1

2 : Stationary Line-Line Resistance

■ T1-02: Motor Rated Power

No. (Hex.)	Name	Description	Default (Range)
T1-02 (0702)	Motor Rated Power	<input type="radio"/> V/f <input type="radio"/> OLV <input type="radio"/> OLV/PM <input type="radio"/> AOLV/PM <input type="radio"/> EZOLV Uses the units set in o1-58 [Motor Power Unit Selection] to set the motor rated output power.	Determined by o2-04, C6-01 (0.00 - 650.00 HP)

■ T1-03: Motor Rated Voltage

No. (Hex.)	Name	Description	Default (Range)
T1-03 (0703)	Motor Rated Voltage	<input type="radio"/> V/f <input type="radio"/> OLV <input type="radio"/> OLV/PM <input type="radio"/> AOLV/PM <input type="radio"/> EZOLV Sets the rated voltage (V) of the motor. Enter the base speed voltage for constant output motors.	Determined by o2-04, C6-01 (200 V Class: 0.0 - 255.5 V, 400 V Class: 0.0 - 511.0 V)

If you do Auto-Tuning on a drive-dedicated motor or a specialized motor for vector control, the voltage or frequency can be lower than that of a general-purpose motor. Always compare the data from the nameplate or test report with the Auto-Tuning results and check for differences. Enter the voltage necessary to operate the motor in no-load conditions at rated speed for better control precision around rated speed. If the motor test report or the motor nameplate is not available, enter approximately 90% of the motor rated voltage.

If the drive input power supply voltage is low, enter approximately 90% of the input voltage. When the input power supply voltage is low, the current will increase. Make sure that the main power supply capacity is correct and use a molded-case circuit breaker for the drive.

■ T1-04: Motor Rated Current

No. (Hex.)	Name	Description	Default (Range)
T1-04 (0704)	Motor Rated Current	<input type="radio"/> V/f <input type="radio"/> OLV <input type="radio"/> OLV/PM <input type="radio"/> AOLV/PM <input type="radio"/> EZOLV Sets the rated current (A) of the motor.	Determined by o2-04 (10% to 200% of the drive rated current)

Set the motor rated current between 50% and 100% of the drive rated current for the best performance. Enter the current at the motor base speed.

■ T1-05: Motor Base Frequency

No. (Hex.)	Name	Description	Default (Range)
T1-05 (0705)	Motor Base Frequency	<input type="radio"/> V/f <input type="radio"/> OLV <input type="radio"/> OLV/PM <input type="radio"/> AOLV/PM <input type="radio"/> EZOLV Sets the base frequency (Hz) of the motor.	60.0 Hz (0.0 - 590.0 Hz)

When Auto-Tuning is carried out, the value of T1-05 is set to E1-04 [Maximum Output Frequency]. If T1-05 < 40 Hz, E1-04 = 40 Hz. If you operate the drive at a speed that is higher than the base frequency, or if you operate in the field weakening range, set E1-04 (E3-04 for motor 2) to the maximum output frequency after you complete Auto-Tuning.

■ T1-06: Number of Motor Poles

No. (Hex.)	Name	Description	Default (Range)
T1-06 (0706)	Number of Motor Poles	<input type="radio"/> V/f <input checked="" type="radio"/> OLV <input type="radio"/> OLV/PM <input type="radio"/> AOLV/PM <input type="radio"/> EZOLV Sets the number of motor poles.	4 (2 to 120)

■ T1-07: Motor Base Speed

No. (Hex.)	Name	Description	Default (Range)
T1-07 (0707)	Motor Base Speed	<input type="radio"/> V/f <input checked="" type="radio"/> OLV <input type="radio"/> OLV/PM <input type="radio"/> AOLV/PM <input type="radio"/> EZOLV Sets the motor base speed for Auto-Tuning (min^{-1} (r/min)).	1750 min^{-1} (r/min) (0 - 35400 min^{-1} (r/min))

■ T1-09: Motor No-Load Current

No. (Hex.)	Name	Description	Default (Range)
T1-09 (0709)	Motor No-Load Current	<input type="radio"/> V/f <input checked="" type="radio"/> OLV <input type="radio"/> OLV/PM <input type="radio"/> AOLV/PM <input type="radio"/> EZOLV Sets the no-load current of the motor.	- (0A - T1-04; max. of 2999.9)

Note:

The display units are different for different models:

- 0.01 A: B001 - B018, 2001 - 2042, 4001 - 4023
- 0.1 A: 2056 - 2082, 4031 - 4060

The value shown is the no-load current that the drive automatically calculates from the values set in *T1-02 [Motor Rated Power]* and *T1-04 [Motor Rated Current]*. Set the no-load current shown on the motor test report. If the motor test report is not available, do not change this parameter.

■ T1-10: Motor Rated Slip Frequency

No. (Hex.)	Name	Description	Default (Range)
T1-10 (070A)	Motor Rated Slip Frequency	<input type="radio"/> V/f <input checked="" type="radio"/> OLV <input type="radio"/> OLV/PM <input type="radio"/> AOLV/PM <input type="radio"/> EZOLV Sets motor rated slip.	- (0.000 - 20.000 Hz)

Shows 0.000 Hz as the default value. Set the rated slip shown on the motor test report. If the motor test report is not available, do not change this parameter.

■ T1-11: Motor Iron Loss

No. (Hex.)	Name	Description	Default (Range)
T1-11 (070B)	Motor Iron Loss	<input checked="" type="radio"/> V/f <input type="radio"/> OLV <input type="radio"/> OLV/PM <input type="radio"/> AOLV/PM <input type="radio"/> EZOLV Sets the iron loss to calculate the energy-saving coefficient.	Determined by E2-10 or E4-10 (0 - 65535 W)

Note:

The default setting is different for different motor codes and motor parameter settings.

The value shown is *E2-10 [Motor Iron Loss]* or *E4-10 [Motor 2 Iron Loss]* for the motor output set in *T1-02 [Motor Rated Power]*. If the motor test report is available, enter the motor iron loss value to *T1-11*.

■ T1-12: Test Mode Selection

No. (Hex.)	Name	Description	Default (Range)
T1-12 (0BDB)	Test Mode Selection	<input type="radio"/> V/f <input checked="" type="radio"/> OLV <input type="radio"/> OLV/PM <input type="radio"/> AOLV/PM <input type="radio"/> EZOLV Sets the function to enable Test Mode after Stationary Auto-Tuning. When you can operate the motor with a light load attached after Stationary Auto-Tuning is complete, enable this parameter.	0 (0, 1)

0 : No

1 : Yes

2.12 T: Auto-Tuning

After Auto-Tuning, the drive automatically sets *E2-02 [Motor Rated Slip]* and *E2-03 [Motor No-Load Current]* when you operate the motor for the first time in Drive Mode.

Note:

After Auto-Tuning is complete and you set the drive to Drive Mode, operate the motor in these conditions:

- Make sure that you connect all wiring between the drive and motor
- Make sure that a mechanical brake on the motor shaft is not locked
- Keep the motor-load ratio at 30%
- Hold constant speed for longer than 1 second at a minimum of 30% of the speed set in *E1-06 [Base Frequency]* (the default setting is the same as the maximum frequency).

■ T1-13: No-load voltage

No. (Hex.)	Name	Description	Default (Range)
T1-13 (0BDC)	No-load voltage	<div style="display: flex; justify-content: space-between; align-items: center;"> V/f OLV OLV/PM AOLV/PM EZOLV </div> <p>Sets the no-load voltage of the motor. When the no-load voltage at rated speed is available, for example on the motor test report, set the voltage in this parameter. If the no-load voltage is not available, do not change this parameter.</p>	T1-03 × 0.9 (200 V Class: 0.0 - 255.0 V, 400 V Class: 0.0 - 510.0 V)

Note:

- To get the same qualities as a Yaskawa 1000-series drive or previous series drive, set this parameter = *T1-03 [Motor Rated Voltage]*.
- The default setting is different for different models.
 - B001 - B006, 2001 - 2008, 4001 - 4004: T1-03 × 0.85
 - B010 - B018, 2010 - 2082, 4005 - 4060: T1-03 × 0.90

◆ T2: PM Motor Auto-Tuning

T2 parameters set the Auto-Tuning input data for PM motor tuning.

Note:

The drive automatically sets these PM motor parameters:

- E1-xx [V/f Pattern for Motor 1]
- E5-xx [V/f Pattern for Motor 1]

■ T2-01: PM Auto-Tuning Selection

No. (Hex.)	Name	Description	Default (Range)
T2-01 (0750)	PM Auto-Tuning Selection	<div style="display: flex; justify-content: space-between; align-items: center;"> V/f OLV OLV/PM AOLV/PM EZOLV </div> <p>Sets the type of Auto-Tuning for PM motors.</p>	0 (Determined by A1-02)

Note:

Yaskawa recommends PM Rotational Auto-Tuning for specialized motors. Rotational Auto-Tuning rotates the motor to measure the actual induction voltage constants for more accurate control than Stationary Auto-Tuning.

0 : Manual Entry w/ Motor Data Sheet

1 : Stationary (Ld, Lq, R)

2 : Stationary (R Only)

4 : Rotational (Ld, Lq, R, back-EMF)

5 : High Frequency Injection

■ T2-02: PM Motor Code Selection

No. (Hex.)	Name	Description	Default (Range)
T2-02 (0751)	PM Motor Code Selection	<div style="display: flex; justify-content: space-between; align-items: center;"> V/f OLV OLV/PM AOLV/PM EZOLV </div> <p>If the drive is operating an SMRD, SMRA, or SSR1 series Yaskawa PM motor, enter the PM motor code in to align with the rotation speed and motor output.</p>	FFFF (0000 - FFFF)

Enter the motor code to automatically set parameters *T2-03 to T2-14*. When you are operating a specialized motor or a non-Yaskawa motor, set *T2-02 = FFFF* and enter the data from the motor nameplate or the motor test report.

You can only enter the permitted PM motor codes. Different drive control methods will accept different PM motor codes.

■ T2-03: PM Motor Type

No. (Hex.)	Name	Description	Default (Range)
T2-03 (0752)	PM Motor Type	<div style="display: flex; justify-content: space-between; align-items: center;"> V/f OLV OLV/PM AOLV/PM EZOLV </div> Sets the type of PM motor the drive will operate.	1 (0, 1)

0 : IPM motor

IPM motors have magnets in the rotor, and $L_d \neq L_q$.

1 : SPM motor

SPM motors have magnets attached to the surface of the rotor with adhesive material, and $L_d = L_q$.

■ T2-04: PM Motor Rated Power

No. (Hex.)	Name	Description	Default (Range)
T2-04 (0730)	PM Motor Rated Power	<div style="display: flex; justify-content: space-between; align-items: center;"> V/f OLV OLV/PM AOLV/PM EZOLV </div> Uses the units set in o1-58 [Motor Power Unit Selection] to set the PM motor rated output power.	Determined by o2-04, C6-01 (0.00 - 650.00 HP)

■ T2-05: PM Motor Rated Voltage

No. (Hex.)	Name	Description	Default (Range)
T2-05 (0732)	PM Motor Rated Voltage	<div style="display: flex; justify-content: space-between; align-items: center;"> V/f OLV OLV/PM AOLV/PM EZOLV </div> Sets the rated voltage (V) of the motor.	200 V Class: 230.0 V, 400 V Class: 460.0 V (200 V Class: 0.0 - 255.0 V, 400 V Class: 0.0 - 510.0 V)

■ T2-06: PM Motor Rated Current

No. (Hex.)	Name	Description	Default (Range)
T2-06 (0733)	PM Motor Rated Current	<div style="display: flex; justify-content: space-between; align-items: center;"> V/f OLV OLV/PM AOLV/PM EZOLV </div> Sets the rated current (A) of the motor.	Determined by o2-04 (10% to 200% of the drive rated current)

■ T2-07: PM Motor Base Frequency

No. (Hex.)	Name	Description	Default (Range)
T2-07 (0753)	PM Motor Base Frequency	<div style="display: flex; justify-content: space-between; align-items: center;"> V/f OLV OLV/PM AOLV/PM EZOLV </div> Sets the base frequency (Hz) of the motor.	60.0 Hz (0.0 - 590.0 Hz)

■ T2-08: Number of PM Motor Poles

No. (Hex.)	Name	Description	Default (Range)
T2-08 (0734)	Number of PM Motor Poles	<div style="display: flex; justify-content: space-between; align-items: center;"> V/f OLV OLV/PM AOLV/PM EZOLV </div> Sets the number of motor poles.	4 (2 - 120)

■ T2-09: PM Motor Base Speed

No. (Hex.)	Name	Description	Default (Range)
T2-09 (0731)	PM Motor Base Speed	<div style="display: flex; justify-content: space-between; align-items: center;"> V/f OLV OLV/PM AOLV/PM EZOLV </div> Sets the motor base speed (min^{-1} (r/min)).	1750 min^{-1} (r/min) (0 - 34500 min^{-1} (r/min))

■ T2-10: PM Motor Stator Resistance

No. (Hex.)	Name	Description	Default (Range)
T2-10 (0754)	PM Motor Stator Resistance	<input type="radio"/> V/f <input type="radio"/> OLV <input checked="" type="radio"/> OLV/PM <input type="radio"/> AOLV/PM <input type="radio"/> EZOLV Sets the stator resistance for each motor phase.	Determined by T2-02 (0.000 - 65.000 Ω)

Note:

This parameter does not set line-to-line resistance.

■ T2-11: PM Motor d-Axis Inductance

No. (Hex.)	Name	Description	Default (Range)
T2-11 (0735)	PM Motor d-Axis Inductance	<input type="radio"/> V/f <input type="radio"/> OLV <input checked="" type="radio"/> OLV/PM <input type="radio"/> AOLV/PM <input type="radio"/> EZOLV Sets the d-axis inductance of the motor on a per phase basis.	Determined by T2-02 (0.00 - 600.00 mH)

■ T2-12: PM Motor q-Axis Inductance

No. (Hex.)	Name	Description	Default (Range)
T2-12 (0736)	PM Motor q-Axis Inductance	<input type="radio"/> V/f <input type="radio"/> OLV <input checked="" type="radio"/> OLV/PM <input type="radio"/> AOLV/PM <input type="radio"/> EZOLV Sets the q-Axis inductance of the motor on a per phase basis.	Determined by T2-02 (0.00 - 600.00 mH)

■ T2-13: Back-EMF Units Selection

No. (Hex.)	Name	Description	Default (Range)
T2-13 (0755)	Back-EMF Units Selection	<input type="radio"/> V/f <input type="radio"/> OLV <input checked="" type="radio"/> OLV/PM <input type="radio"/> AOLV/PM <input type="radio"/> EZOLV Sets the units that the drive uses to set the induced voltage constant.	0 (0, 1)

0 : mV/(rev/min)

1 : mV/(rad/s)

Note:

- When $T2-13 = 0$, the drive will use $E5-24$ [PM Back-EMF L-L V_{rms} (mV/rpm)] and will automatically set $E5-09$ [PM Back-EMF V_{peak} (mV/(rad/s))] = 0.0.
- When $T2-13 = 1$, the drive will use $E5-09$ and will automatically set $E5-24 = 0.0$.

■ T2-14: Back-EMF Voltage Constant (Ke)

No. (Hex.)	Name	Description	Default (Range)
T2-14 (0737)	Back-EMF Voltage Constant (Ke)	<input type="radio"/> V/f <input type="radio"/> OLV <input checked="" type="radio"/> OLV/PM <input type="radio"/> AOLV/PM <input type="radio"/> EZOLV Sets the motor induced voltage constant (Ke).	Determined by T2-13 (0.0 - 2000.0)

■ T2-15: Pull-In Current Level

No. (Hex.)	Name	Description	Default (Range)
T2-15 (0756)	Pull-In Current Level	<input type="radio"/> V/f <input type="radio"/> OLV <input checked="" type="radio"/> OLV/PM <input type="radio"/> AOLV/PM <input type="radio"/> EZOLV Sets the level of the pull-in current as a percentage of $E5-03$ [PM Motor Rated Current (FLA)]. Usually it is not necessary to change this setting.	30% (0 - 120%)

If the load inertia is high, increase the setting value.

◆ T3: ASR and Inertia Tuning

■ T3-00: Control Loop Tuning Selection

No. (Hex.)	Name	Description	Default (Range)
T3-00 (1198)	Control Loop Tuning Selection	<div style="display: flex; justify-content: space-between; align-items: center;"> V/f OLV OLV/PM AOLV/PM EZOLV </div> Sets the type of Control Auto-Tuning.	2 (2, 3)

2 : Deceleration Rate Tuning

3 : KEB Tuning

◆ T4: EZ Tuning

Use *T4 parameters* to input the data necessary for motor parameter Auto-Tuning when $AI-02 = 8$ [Control Method Selection = EZ Vector Control]. These two modes are available:

T4-01 Setting	Operational overview	Items input for tuning	Items tuned
0	Follow the instructions in the setup wizard on the keypad to manually enter the necessary motor parameters.	<ul style="list-style-type: none"> • T4-02 [Motor Type Selection] • T4-03 [Motor Max Revolutions] • T4-04 [Motor Rated Revolutions] • T4-05 [Motor Rated Frequency] ^{*1} • T4-06 [Motor Rated Voltage] • T4-07 [Motor Rated Current] • T4-08 [Motor Rated Capacity] • T4-09 [Number of Poles] 	<ul style="list-style-type: none"> • E9-01 [Motor Type Selection] • E9-02 [Maximum Speed] • E9-03 [Rated Speed] • E9-04 [Base Frequency] • E9-05 [Base Voltage] • E9-06 [Motor Rated Current (FLA)] • E9-07 [Motor Rated Power] • E9-08 [Motor Pole Count] • E9-09 [Motor Rated Slip] • E9-10 [Motor Line-to-Line Resistance]
1	Do only line-to-line resistance tuning.	Motor Rated Current	E9-10 [Motor Line-to-Line Resistance]

*1 When you use a PM motor or a synchronous reluctance motor, it is not necessary to enter the rated frequency. The drive will use the rated rotation speed and number of motor poles to automatically calculate the rated frequency.

■ T4-01: EZ Tuning Mode Selection

No. (Hex.)	Name	Description	Default (Range)
T4-01 (3130)	EZ Tuning Mode Selection	<div style="display: flex; justify-content: space-between; align-items: center;"> V/f OLV OLV/PM AOLV/PM EZOLV </div> Sets the type of Auto-Tuning for EZOLV control.	0 (0, 1)

0 : Motor Parameter Setting

1 : Line-to-Line Resistance

■ T4-02: Motor Type Selection

No. (Hex.)	Name	Description	Default (Range)
T4-02 (3131)	Motor Type Selection	<div style="display: flex; justify-content: space-between; align-items: center;"> V/f OLV OLV/PM AOLV/PM EZOLV </div> Sets the type of motor.	0 (0, 1, 2)

0 : Induction (IM)

1 : Permanent Magnet (PM)

2 : Synchronous Reluctance (SynRM)

■ T4-04: Motor Rated Revolutions

No. (Hex.)	Name	Description	Default (Range)
T4-04 (3133)	Motor Rated Revolutions	<div style="display: flex; justify-content: space-between; align-items: center;"> V/f OLV OLV/PM AOLV/PM EZOLV </div> Sets rated rotation speed (min ⁻¹) of the motor.	- ((40 Hz to 120 Hz) × 60 × 2/ E9-08)

■ T4-05: Motor Rated Frequency

No. (Hex.)	Name	Description	Default (Range)
T4-05 (3134)	Motor Rated Frequency	<div style="display: flex; justify-content: space-between; align-items: center;"> V/f OLV OLV/PM AOLV/PM EZOLV </div> Sets the rated frequency (Hz) of the motor.	Determined by E9-01 and o2-04 (40.0 - 120.0 Hz)

Note:

When $T4-02 = 1, 2$ [Motor Type Selection = Permanent Magnet (PM), Synchronous Reluctance (SynRM)], input is not necessary because it assumes: Motor Rated Revolutions/60 × Number of Motor Poles/2.

■ T4-06: Motor Rated Voltage

No. (Hex.)	Name	Description	Default (Range)
T4-06 (3135)	Motor Rated Voltage	<div style="display: flex; justify-content: space-between; align-items: center;"> V/f OLV OLV/PM AOLV/PM EZOLV </div> Sets the rated voltage (V) of the motor.	200 V Class: 230.0 V, 400 V Class: 460.0 V (200 V Class: 0.0 - 255.0 V, 400 V Class: 0.0 - 510.0 V)

■ T4-07: Motor Rated Current

No. (Hex.)	Name	Description	Default (Range)
T4-07 (3136)	Motor Rated Current	<div style="display: flex; justify-content: space-between; align-items: center;"> V/f OLV OLV/PM AOLV/PM EZOLV </div> Sets the rated current (A) of the motor.	Determined by o2-04, C6-01 (10% to 200% of the drive rated current)

Note:

The value set here becomes the base value for motor protection, the torque limit, and torque control.

■ T4-08: Motor Rated Capacity

No. (Hex.)	Name	Description	Default (Range)
T4-08 (3137)	Motor Rated Capacity	<div style="display: flex; justify-content: space-between; align-items: center;"> V/f OLV OLV/PM AOLV/PM EZOLV </div> Sets the motor rated power in the units set in o1-58 [Motor Power Unit Selection].	Determined by E9-10 (0.10 - 650.00 HP)

■ T4-09: Number of Poles

No. (Hex.)	Name	Description	Default (Range)
T4-09 (3138)	Number of Poles	<div style="display: flex; justify-content: space-between; align-items: center;"> V/f OLV OLV/PM AOLV/PM EZOLV </div> Sets the number of motor poles.	Determined by E9-01 (2 - 120)

Startup Procedure and Test Run

3.1	Section Safety	458
3.2	Overview of Keypad Components and Functions	459
3.3	Keypad Operation	466
3.4	Automatic Parameter Settings Optimized for Specific Applications (Application Presets).....	471
3.5	Auto-Tuning	472
3.6	Test Run	479
3.7	Fine Tuning during Test Runs (Adjust the Control Function).....	481
3.8	Test Run Checklist	486

3.1 Section Safety

DANGER

Electrical Shock Hazard

Do not examine, connect, or disconnect wiring on an energized drive. Before servicing, disconnect all power to the equipment and wait for the time specified on the warning label at a minimum. The internal capacitor stays charged after the drive is de-energized. The charge indicator LED extinguishes when the DC bus voltage decreases below 50 Vdc. When all indicators are OFF, measure for dangerous voltages to make sure that the drive is safe.

If you do work on the drive when it is energized, it will cause serious injury or death from electrical shock.

WARNING

Electrical Shock Hazard

Do not operate the drive when covers are missing. Replace covers and shields before you operate the drive. Use the drive only as specified by the instructions.

Some figures in this section include drives without covers or safety shields to more clearly show the inside of the drive. If covers or safety shields are missing from the drive, it can cause serious injury or death.

Do not remove covers or touch circuit boards while the drive is energized.

If you touch the internal components of an energized drive, it can cause serious injury or death.

Sudden Movement Hazard

If you change the control source when $b1-07 = 1$ [*LOCAL/REMOTE Run Selection = Accept Existing RUN Command*], the drive can start suddenly. Before you change the control source, remove all personnel from the area around the drive, motor, and load.

Sudden starts can cause serious injury or death.

3.2 Overview of Keypad Components and Functions

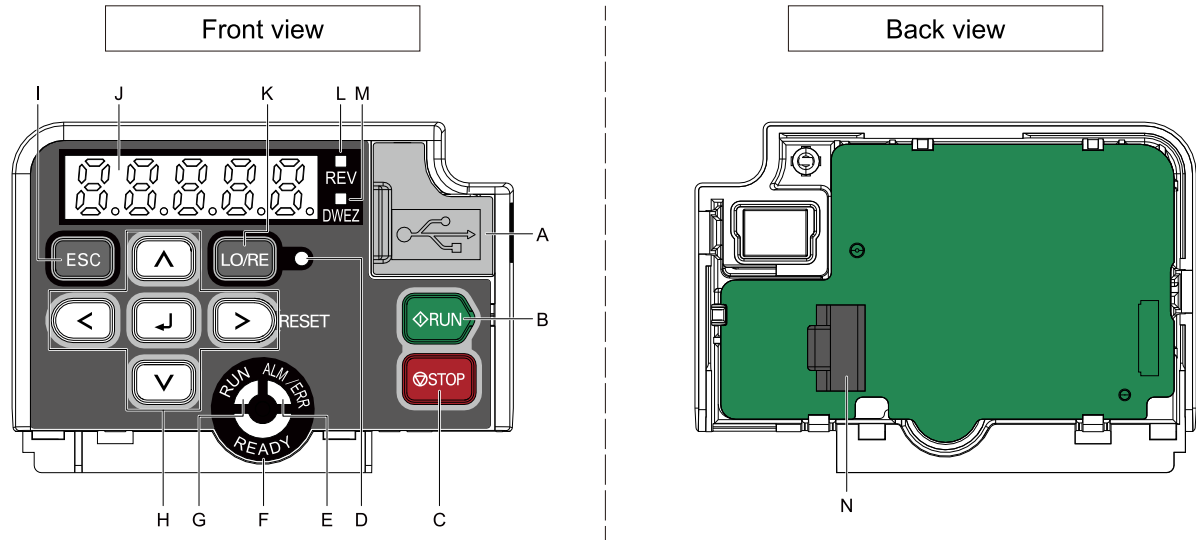





















Figure 3.1 Keypad

Table 3.1 Keypad Components and Functions

Symbol	Name	Function
A	USB Terminal Pass-through	Pass-through point to connect a USB cable to the drive to use the DriveWizard PC tool or the DriveWizard Mobile App to program the drive. Uses a USB cable (USB standard 2.0, type A - mini-B) to connect the drive to a PC, Android smartphone, or tablet.
B	RUN Key 	Starts the drive in LOCAL Mode. Starts the operation in Auto-Tuning Mode. Note: Before you use the keypad to operate the motor, push  on the keypad to set the drive to LOCAL Mode.
C	STOP Key 	Stops drive operation. Note: Uses a stop-priority circuit. Push  to stop the motor. This will also apply when a Run command (REMOTE Mode) is active at an external Run command source. To disable  priority, set $o2-02 = 0$ [<i>STOP Key Function Selection = Disabled</i>].
D	LO/RE LED 	Illuminated: The keypad controls the Run command (LOCAL Mode). OFF: The control circuit terminal or serial transmission device controls the Run command (REMOTE Mode). Note: • LOCAL: Use the keypad to operate the drive. Use the keypad to enter Run/Stop commands and the frequency reference command. • REMOTE: Use the control circuit terminal or serial transmission to operate the drive. Use the frequency reference source entered in $b1-01$ and the Run command source selected in $b1-02$.
E	ALM/ERR LED 	Illuminated: The drive detects a fault. OFF: There are no drive faults or alarms. Flashing: • Alarm • Operation Errors • An Auto-Tuning error Note: The LED will illuminate to identify a fault if the drive detects a fault and an alarm at the same time.
F	READY LED 	Illuminated: The drive is operating or is ready for operation. OFF: • The drive detects a fault. • There is no fault and the drive received a Run command, but the drive cannot run. For example, in Programming Mode. Flashing: The drive is in <i>Sto</i> [<i>Safe Torque OFF</i>] condition. Flashing quickly: The voltage of the main circuit power supply is not in the drive nameplate specifications, and the external 24 V power supply is providing the only power to the drive.

3.2 Overview of Keypad Components and Functions

Symbol	Name	Function
G	RUN LED 	<p>Illuminated: The drive is in normal operation. OFF: The drive is stopped. Flashing: • The drive is decelerating to stop. • The drive received a Run command with a frequency reference of 0 Hz, but the drive is not set for zero speed control Flashing quickly: • The drive received a Run command from the MFDI terminals while in LOCAL Mode and it switched to REMOTE Mode. • The drive received a Run command from the MFDI terminals when the drive is not in Drive Mode. • The drive received a Fast Stop command. • The safety function shut off the drive output.</p> <p>• You pushed  on the keypad while the drive is operating in REMOTE Mode. • The drive is energized with an active Run command and $b1-17 = 0$ [Run Command at Power Up = Disregard Existing RUN Command].</p>
H	Left Arrow Key 	Moves the cursor to the left.
	Up Arrow Key/Down Arrow Key 	<ul style="list-style-type: none"> Moves to a different screen. Selects parameter numbers and increments or decrements setting values.
	Right Arrow Key (RESET) 	<ul style="list-style-type: none"> Moves the cursor to the right. Resets the drive to clear a fault.
	ENTER Key 	<ul style="list-style-type: none"> Enters parameter values and settings. Selects each mode, parameter, and set value.
I	ESC Key 	<ul style="list-style-type: none"> Goes back to the previous screen. Push and hold to go back to the frequency reference screen (the initial screen).
J	LED Display	Shows parameters, errors, and other data.
K	LO/RE Selection Key 	<p>Switches drive control for the Run command and frequency reference between the keypad (LOCAL) and an external source (REMOTE).</p> <p>Note:</p> <ul style="list-style-type: none"> The LOCAL/REMOTE Selection Key continuously stays enabled after the drive stops in Drive Mode. If the application must not switch from REMOTE to LOCAL because it will have a negative effect on system performance, set $o2-01 = 0$ [LO/RE Key Function Selection = Disabled] to disable . The drive will not switch between LOCAL and REMOTE when it is receiving a Run command from an external source.
L	REV LED 	Illuminated: The drive received a Reverse run command.
M	DWEZ LED 	Illuminated: The drive is In DriveWorksEZ operation.
N	RJ-45 Connector	Connects to the drive. Use an RJ-45 8-pin straight UTP CAT5e extension cable to install the keypad in a different location than the drive.

WARNING! Sudden Movement Hazard. If you change the control source when $b1-07 = 1$ [LOCAL/REMOTE Run Selection = Accept Existing RUN Command], the drive can start suddenly. Before you change the control source, remove all personnel from the area around the drive, motor, and load. Sudden starts can cause serious injury or death.

Drive models GA50Axxxxxxx-xxxxLx ship from the factory with a blank cover instead of a keypad. To set parameters on these models, connect an optional keypad or engineering tool to one of the connection ports shown in [Figure 3.2](#).

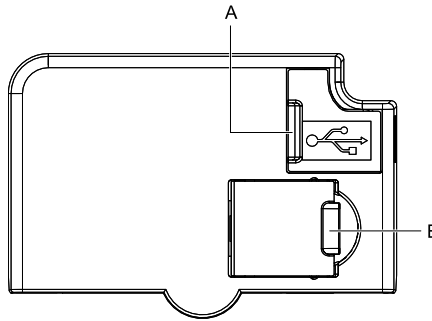

Figure 3.2 Blank Cover

Table 3.2 Blank Cover Components and Functions

Symbol	Name	Function
A	USB Terminal Pass-through	Pass-through point to connect a USB cable to the drive to use the DriveWizard PC tool or the DriveWizard Mobile App to program the drive. Uses a USB cable (USB standard 2.0, type A - mini-B) to connect the drive to a PC, Android smartphone, or tablet.
B	RJ-45 Connector Pass-through	Connects to the drive. Use an RJ-45 8-pin straight UTP CAT5e extension cable to use the keypad option to program the drive.

◆ Indicator flashing statuses

Refer to [Figure 3.3](#) for the difference between “flashing” and “flashing quickly”.

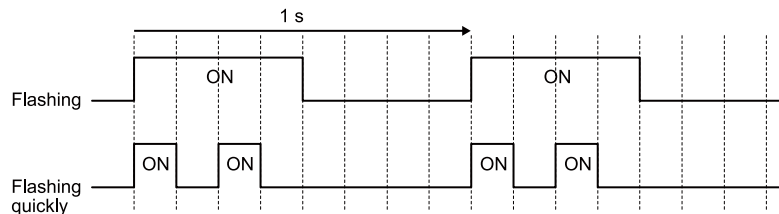

Figure 3.3 About indicator flashing statuses

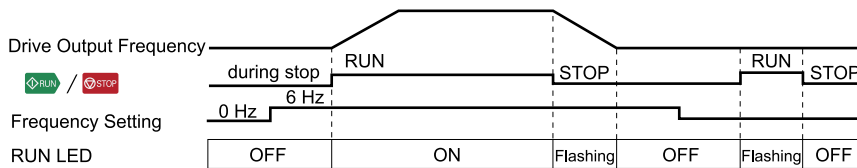

Figure 3.4 Relation between RUN indicator and Drive Operation

◆ Keypad Mode and Menu Displays

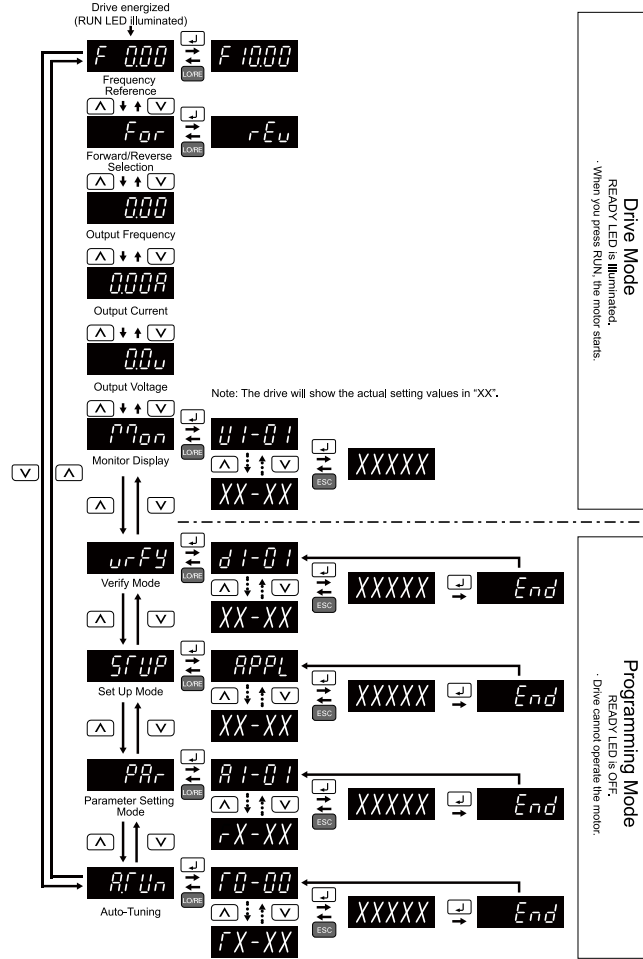

Figure 3.5 Keypad Functions and Display Levels

◆ Set up the Drive with General-Purpose Setup Mode

Drive parameters are in letter groups from A to U. Setup Mode **SFUP** contains only the most frequently used parameters to help you set up the drive more easily.

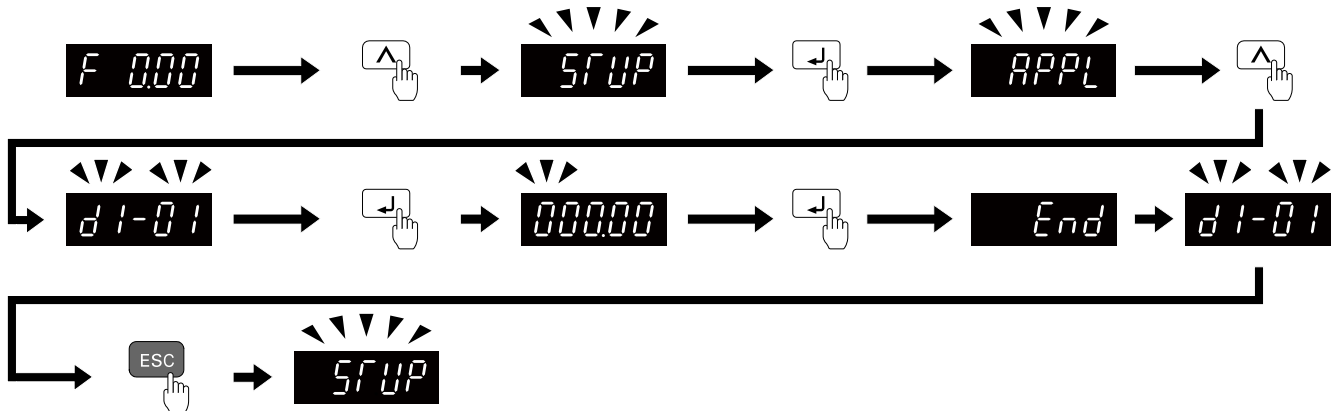

Figure 3.6 Parameters in General-Purpose Setup Mode

Table 3.3 shows the parameters available in Setup Mode. To access parameters not shown in the Setup Mode, use the **PR-** menu.

Table 3.3 Parameters in General-Purpose Setup Mode

User Parameter	Parameter	Name
A2-01	A1-02	Control Method Selection
A2-02	b1-01	Frequency Reference Selection 1
A2-03	b1-02	Run Command Selection 1
A2-04	b1-03	Stopping Method Selection
A2-05	C1-01	Acceleration Time 1
A2-06	C1-02	Deceleration Time 1
A2-07	C6-01	Normal / Heavy Duty Selection
A2-08	C6-02	Carrier Frequency Selection
A2-09	d1-01	Reference 1
A2-10	d1-02	Reference 2
A2-11	d1-03	Reference 3
A2-12	d1-04	Reference 4
A2-13	d1-17	Jog Reference
A2-14	E1-01	Input AC Supply Voltage
A2-15	E1-03	V/f Pattern Selection
A2-16	E1-04	Maximum Output Frequency
A2-17	E1-05	Maximum Output Voltage
A2-18	E1-06	Base Frequency
A2-19	E1-09	Minimum Output Frequency
A2-20	E1-13	Base Voltage
A2-21	E2-01	Motor Rated Current (FLA)
A2-22	E2-04	Motor Pole Count
A2-23	E2-11	Motor Rated Power
A2-24	H4-02	Terminal AM Analog Output Gain
A2-25	L1-01	Motor Overload (oL1) Protection
A2-26	L3-04	Stall Prevention during Decel

Note:

- When you change A1-02 [Control Mode Selection], the settings of some parameters automatically change.
- This manual also shows parameters that are not in Setup Mode. Use **PAR** to set the parameters not shown in the Setup Mode.
- Display parameters change when the A1-06 [Application Preset] setting changes.

◆ Programming Mode

In Programming Mode, you can set parameters or do Auto-Tuning. This mode has 4 sub-modes for different programming requirements:

- Verify Menu: Use this mode to examine and set the parameters that are not at default settings.
- Setup Mode: Use this mode to see and set the minimum parameters necessary for drive operation. Refer to *Verify and Set the Changed Parameters (Verify Menu) on page 464* for more information.
- Parameter Setting Mode: Use this mode to see and set all parameters.
- Auto-Tuning Mode: Use this mode to automatically set the motor parameters necessary for each control method.

■ Setup Mode

In Setup Mode, you can see and set the minimum parameters necessary for drive operation. Refer to [Figure 3.7](#) for an example.

3.2 Overview of Keypad Components and Functions

Note:

1. Refer to [Set up the Drive with General-Purpose Setup Mode on page 462](#) and [Automatic Parameter Settings Optimized for Specific Applications \(Application Presets\) on page 471](#) for more information about Setup mode parameters.
2. Push **APPL** and **↓** to continue to the application selection screen. When you change the setting, it will optimize the parameter for the application. The default setting is 0 [General-purpose].
3. To go back to the initial screen, push **ESC**. To change another parameter in Setup Mode, push **↑** or **↓**.

Change *b1-01* [Frequency Reference Selection 1] from 1 [Analog Input] to 0 [Keypad].

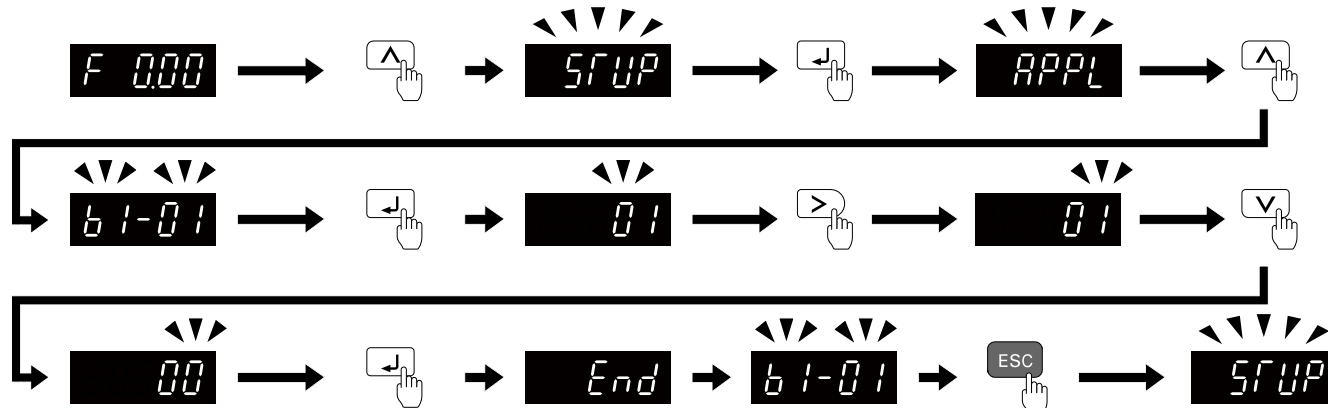

Figure 3.7 Key operation examples in Setup Mode

◆ Change Parameter Settings

Show the frequency reference screen in advance.

Note:

Push and hold **ESC** to go back to the frequency reference screen from any screen.

Use these steps to change *C1-01* [Acceleration Time 1] from 1.0 s (default) to 2.0 s.

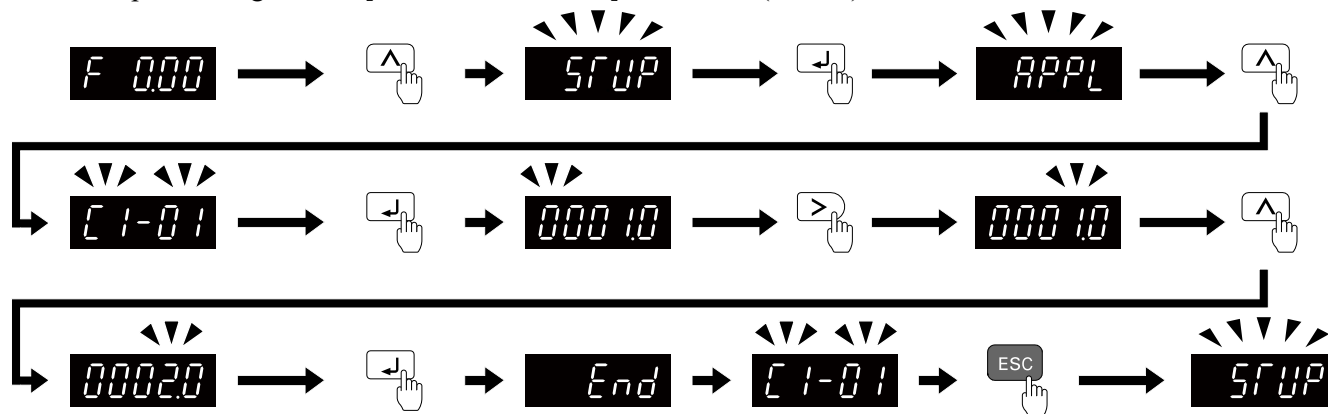

Figure 3.8 Key Operation Examples for Parameter Settings

◆ Verify and Set the Changed Parameters (Verify Menu)

Show the frequency reference screen.

Note:

Push and hold **ESC** to return to frequency reference screen from any screen.

Use Verify mode to view all parameters that are not at default settings. This is very useful when you replace a drive.

When there are no changes to parameter settings, the display shows *nonE*. This lets you quickly access and re-edit changed parameters. [Figure 3.9](#) shows the procedure.

Note:

The drive will only display *A1-02* [Control Method Selection], *A1-xx*, *A2-01* to *A2-32* [User Parameter 1 to User Parameter 32], and *E5-01* [PM Motor Code Selection].

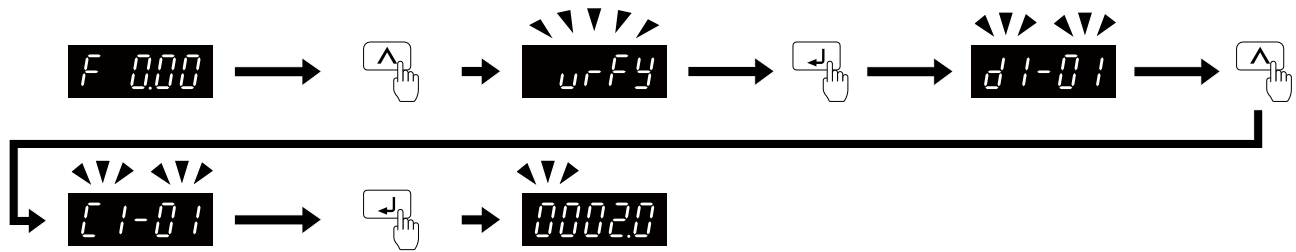

Figure 3.9 Verify and Set the Changed Parameters

◆ How to Switch between LOCAL and REMOTE

LOCAL mode lets you use the keypad to input Run commands. REMOTE mode lets you use other sources than the keypad to input Run commands.

WARNING! Sudden Movement Hazard. If you change the control source when *b1-07* = 1 [LOCAL/REMOTE Run Selection = Accept Existing RUN Command], the drive can start suddenly. Before you change the control source, remove all personnel from the area around the drive, motor, and load. Sudden starts can cause serious injury or death.

You can use  or MFDI functions (LOCAL/REMOTE Selection) to switch between LOCAL and REMOTE.

Note:

1.  illuminates while the drive is in LOCAL Mode.
2. While you are entering a Run command, you cannot switch between LOCAL and REMOTE.

■ Use the LO/RE Selection Key on the Keypad to Switch between LOCAL and REMOTE

Each time you push , the mode switches between LOCAL and REMOTE. The LED illuminates in LOCAL Mode.



Figure 3.10 Use the LO/RE Selection Key to Switch between LOCAL and REMOTE

■ Use MFDI Terminals (S1 to S7) to Switch between LOCAL and REMOTE

When you set *H1-xx* = 1 [MFDI Function Selection = LOCAL/REMOTE Selection], you can activate/deactivate the terminal to switch between LOCAL and REMOTE. Set *H1-xx* = 1 to disable the LO/RE key on the keypad. For information about the MFDI functions, refer to the list in *H1: Digital Inputs on page 287*.

3.3 Keypad Operation

Note:

Make sure that you use a keypad that has a flash number of 1004 or later. Keypads that have a flash number of 1003 or earlier will not show characters correctly.

◆ Digital character mapping table

The LED keypad shows the digital characters as shown in [Table 3.4](#)

Table 3.4 Digital character mapping table

Characters	LED Display	Characters	LED Display	Characters	LED Display	Characters	LED Display
0	0	9	9	I	i	R	r
1	1	A	A	J	j	S	s
2	2	B	b	K	k	T	t
3	3	C	c	L	l	U	u
4	4	D	d	M	m*1	V	v
5	5	E	e	N	n	W	w*1
6	6	F	f	O	o	X	No indication
7	7	G	g	P	p	Y	y
8	8	H	h	Q	q	Z	No indication

*1 Shown across two digits.

◆ Show the Monitor

Show the frequency reference screen.

Note:

Push and hold **ESC** to return to frequency reference screen from any screen.

Use these steps to monitor parameter settings.

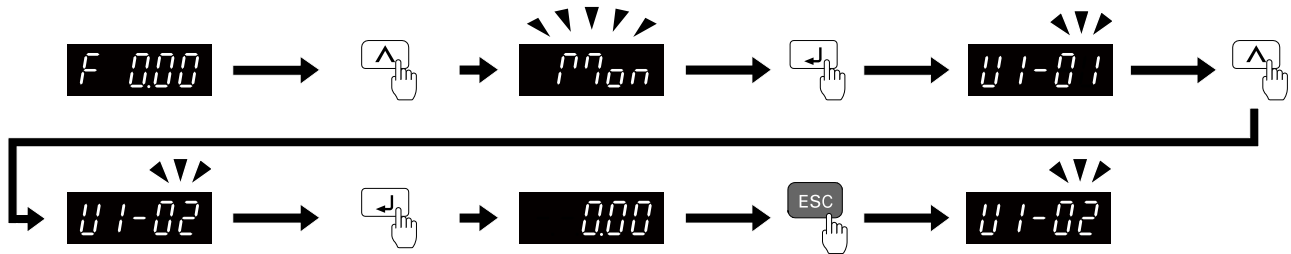

Figure 3.11 How to Monitor the Parameter Setting Values

◆ Check Modified Parameters

Show the frequency reference screen.

Note:

Push and hold **ESC** to return to frequency reference screen from any screen.

Use Verify mode to view all parameters that are not at default settings. This is very useful when you replace a drive. This lets you quickly access and re-edit changed parameters.

Note:

The drive will only display *A1-02 [Control Method Selection]*, *A1-xx*, *A2-01 to A2-32 [User Parameter 1 to User Parameter 32]*, and *E5-01 [PM Motor Code Selection]*.

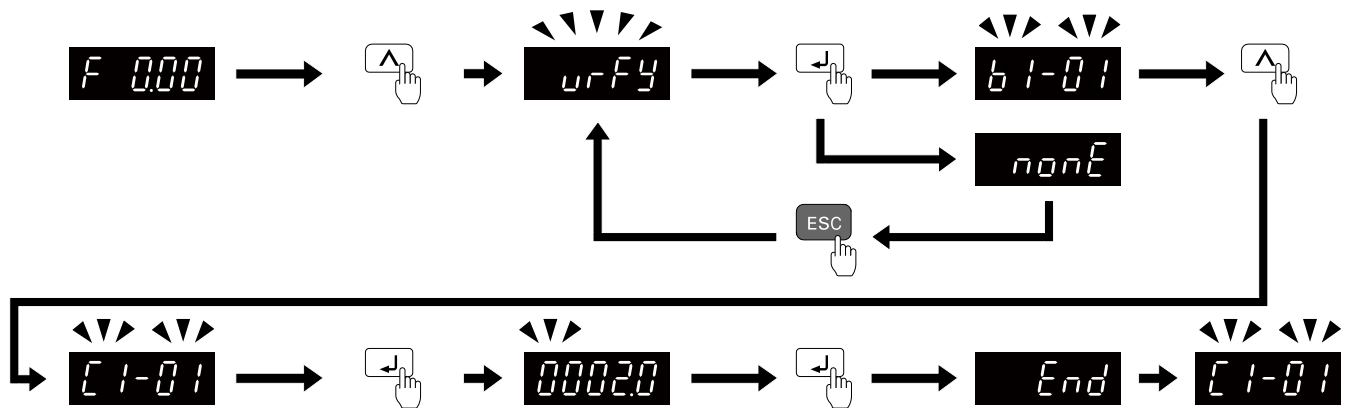

Figure 3.12 How to Examine the Changed Parameters

◆ Set and View Necessary Parameters

Show the frequency reference screen.

Note:

Push and hold **ESC** to return to frequency reference screen from any screen.

The setup mode shows the parameters set in *A2-01 to A2-32 [User Parameter 1 to User Parameter 32]*. This lets you quickly access and change these parameters.

Note:

Setup mode always shows **APPL** (*A1-06 [Application Preset]*) at the top of the list. When you change the setting, the settings for *A2-01 to A2-32* change.

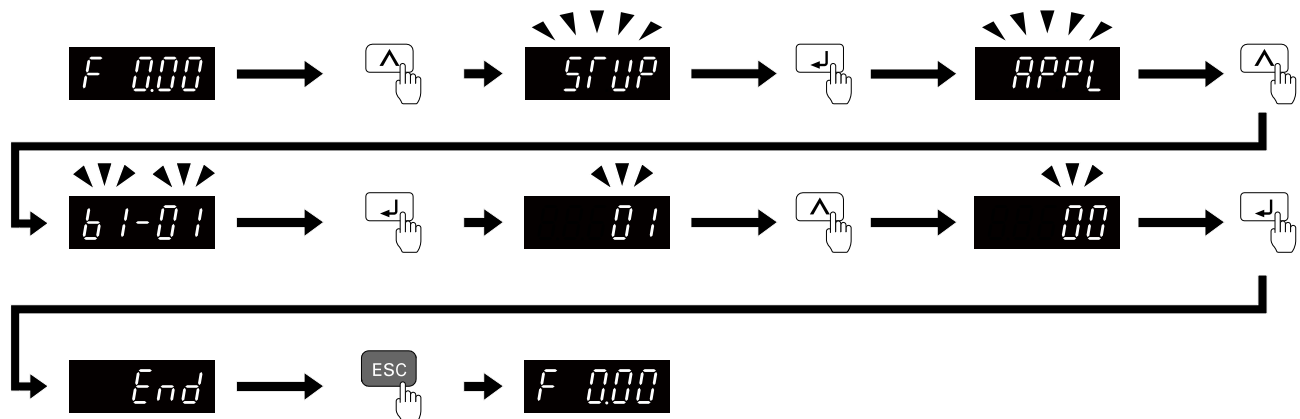

Figure 3.13 View and Set the Necessary Parameters

Continue to change the parameters or press and hold **ESC** to go back to the frequency reference screen.

◆ Change Parameter Settings

Show the frequency reference screen in advance.

Note:

Push and hold **ESC** to go back to the frequency reference screen from any screen.

This example shows how to change *C1-01 [Acceleration Time 1]*. Set the parameter to the necessary value.

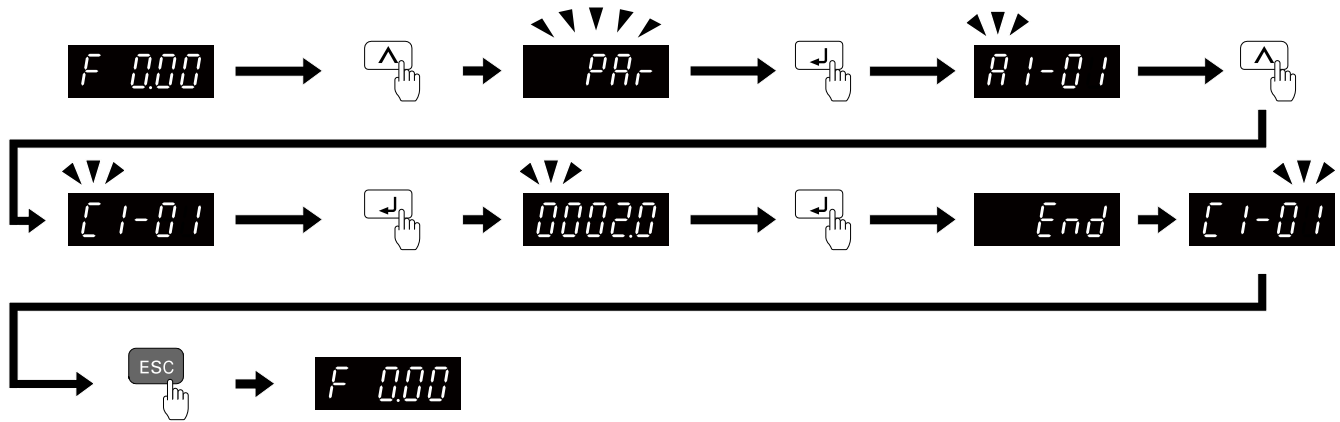

Figure 3.14 How to Change the Parameter Setting

Continue to change parameters or push and hold **ESC** to go back to the frequency reference screen.

◆ Save a Backup of Parameters

Show the frequency reference screen.

Note:

Push and hold **ESC** to return to the frequency reference screen from any screen.

Use these steps to save a backup of the drive parameters to the keypad.

Backups of the parameter settings can save time when you set parameters after you replace a drive. When you set up more than one drive, you can copy the parameter settings from a drive that completed a test run to the other drives.

Note:

- Stop the motor before you back up parameters.
- While the drive makes a backup, it will not accept Run commands.
- Set o3-02 = 0 [Copy Allowed Selection = Disabled] to protect the parameters saved in the keypad.

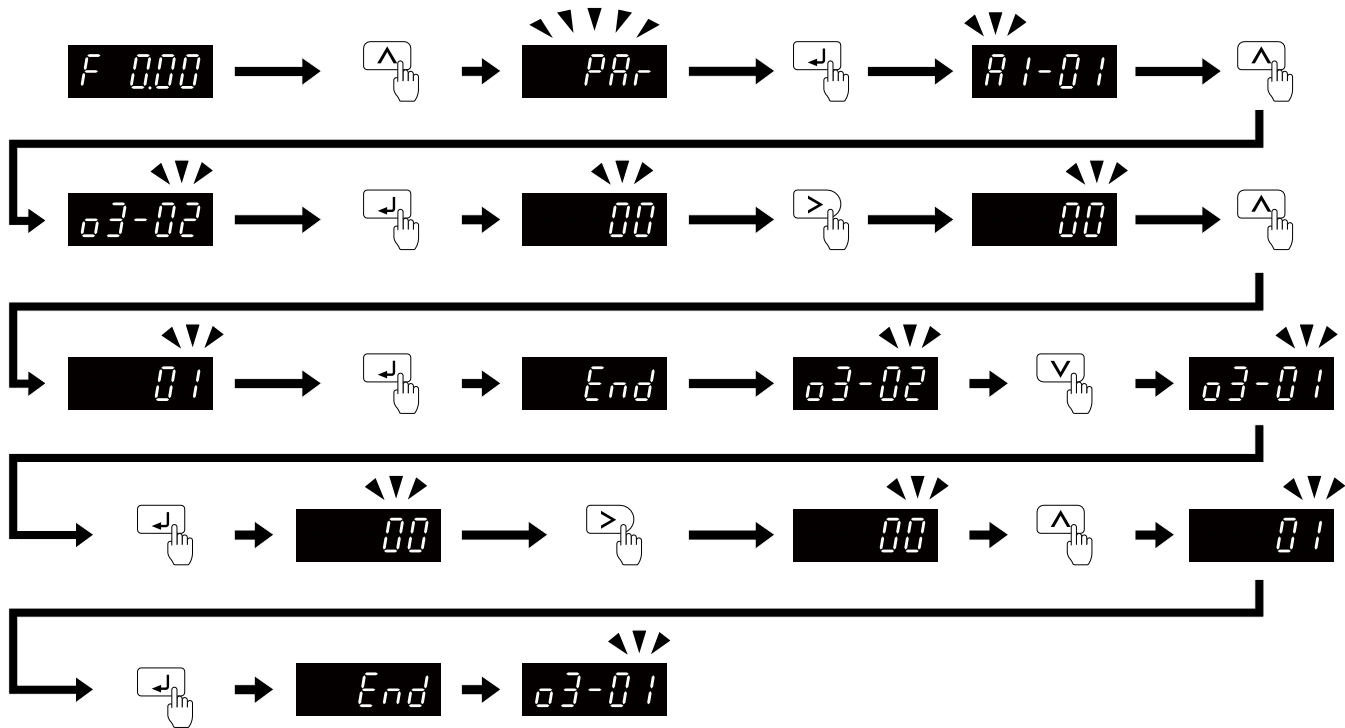

Figure 3.15 How to Save Backed-up Parameters

Push and hold **ESC** to go back to the frequency reference screen.

◆ Write Backed-up Parameters to the Drive

Show the frequency reference screen in advance.

Note:

Push and hold **ESC** to go back to the frequency reference screen from any screen.

Use these steps to write the parameters backed up in the keypad into a different drive.

Note:

- Make sure that you stop the drive before you restore the backed-up parameters.
- The drive does not accept Run commands while it is restoring parameters.

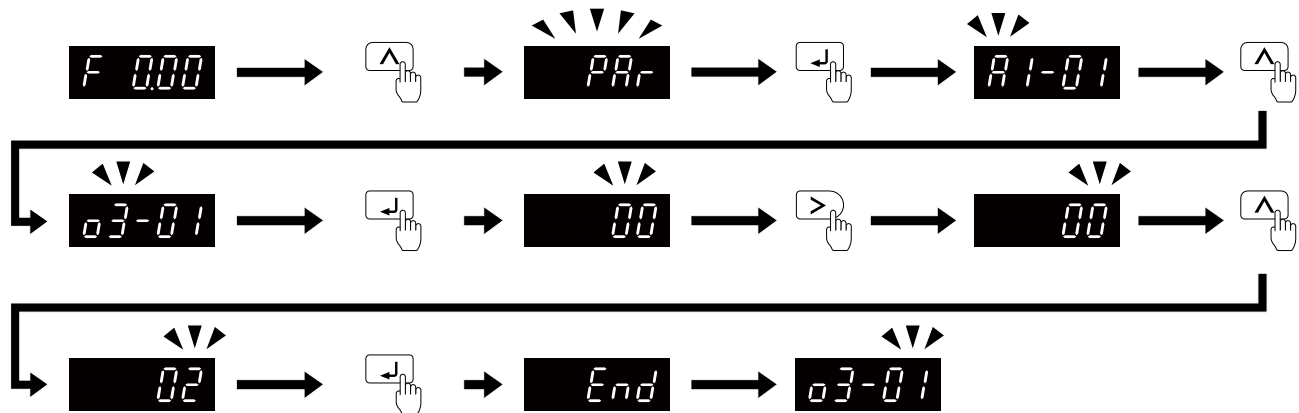

Figure 3.16 Writing backed up parameters

Push and hold **ESC** to go back to the frequency reference screen.

◆ Verify Keypad Parameters and Drive Parameters

Show the frequency reference screen in advance.

Note:

Push and hold **ESC** to go back to the frequency reference screen from any screen.

This procedure verifies that the parameter setting values that were backed up in the keypad agree with the parameter setting values in the drive.

Note:

- Make sure that you stop the drive before you examine parameters.
- The drive does not accept Run commands while it is restoring parameters.

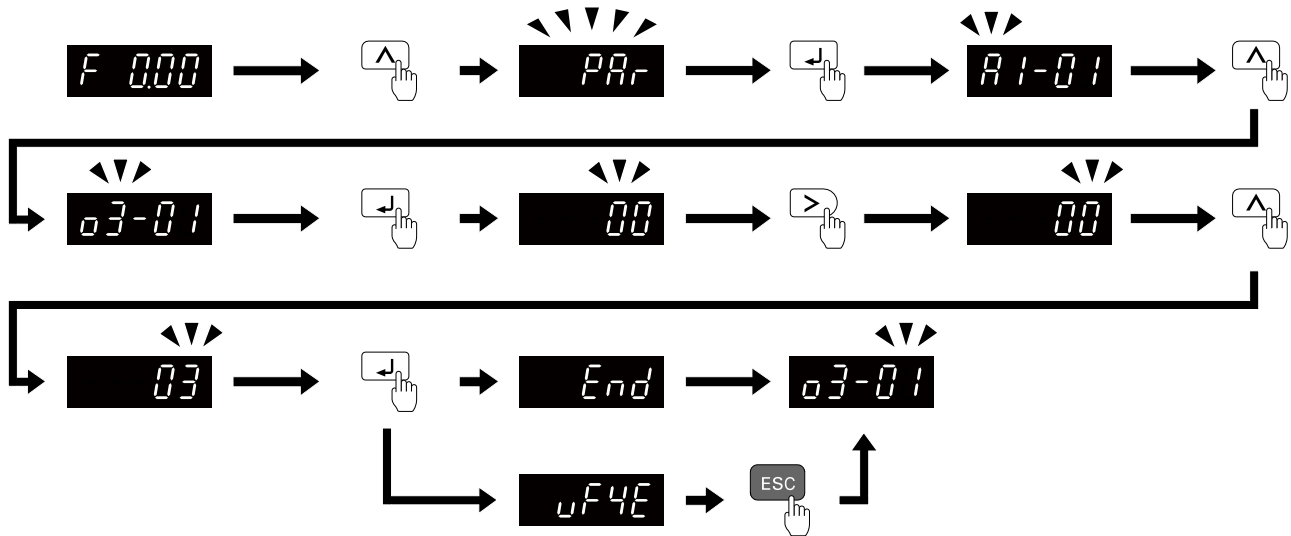

Figure 3.17 Verify Keypad Parameters and Drive Parameters

Push and hold **ESC** to go back to the frequency reference screen.

◆ Delete Parameters Backed Up to the Keypad

Show the frequency reference screen in advance.

Note:

Push and hold **ESC** to go back to the frequency reference screen from any screen.

Use these steps to erase the parameters backed up in the keypad.

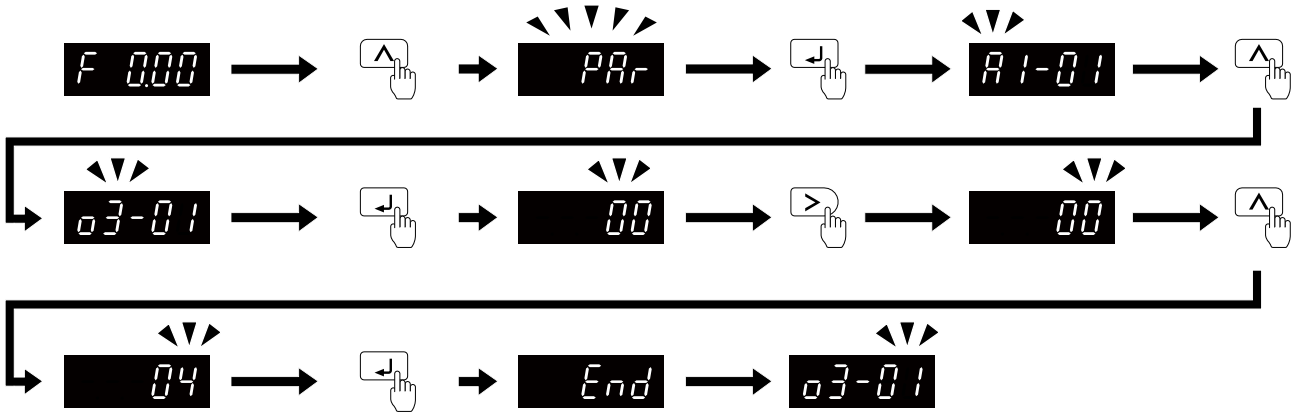

Figure 3.18 How to Erase the Backed-up Parameters

Push and hold **ESC** to go back to the frequency reference screen.

3.4 Automatic Parameter Settings Optimized for Specific Applications (Application Presets)

Show the frequency reference screen.

Note:

Press and hold **ESC** to return to the frequency reference screen from any screen.

Use this procedure to set an application preset.

The drive has application presets to set the necessary parameters for different applications to their best values. Use **ur-F4** to find parameters that were changed automatically by the application preset function in *A1-06*.

Note:

Before you set *A1-06*, make sure that you set *A1-03* = 2220, 3330 [*Initialize Parameters = 2-Wire Initialization, 3-Wire Initialization*] to initialize parameters.

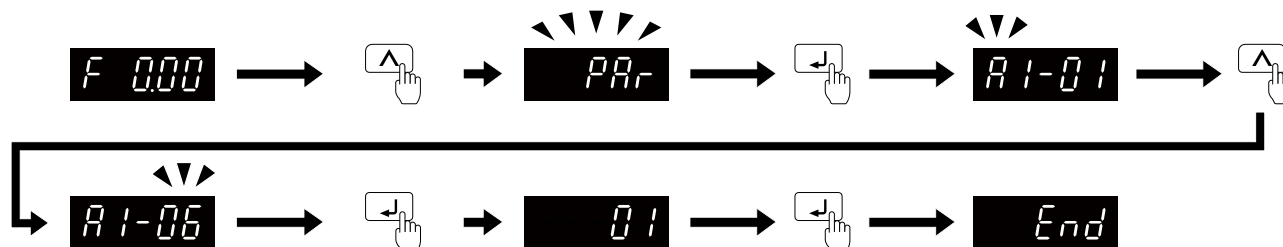

Figure 3.19 Automatic Parameter Settings

Press and hold **ESC** to go back to the frequency reference screen.

Note:

- You cannot directly set parameter *A1-06*. To set an application preset, first set *A1-03* = 2220 to initialize parameters, then set this parameter. If initializing all parameters will cause a problem, do not change the settings.
- When the drive applies the *A1-06* setting, it will also reset the parameters automatically registered to *A2-17* to *A2-32* [*User Parameters 17 to 32*] when *A2-33* = 1 [*User Parameter Auto Selection = Enabled: Auto Save Recent Params*].

3.5 Auto-Tuning

Auto-Tuning uses motor characteristics to automatically set drive parameters for vector control. Think about the type of motor, drive control method, and the motor installation environment and select the best Auto-Tuning method.

WARNING! Injury to Personnel. Rotational Auto-Tuning rotates the motor at 50% or more of the motor rated frequency. Make sure that there are no issues related to safety in the area around the drive and motor. Increased motor frequency can cause serious injury or death.

◆ Auto-Tuning for Induction Motors

This section gives information about Auto-Tuning for induction motors. Set motor parameters *E1-xx* and *E2-xx* (or, for motor 2, *E3-xx* and *E4-xx*) for Auto-Tuning.

Note:

Do Stationary Auto-Tuning if you cannot do Rotational Auto-Tuning. There can be large differences between the measured results and the motor characteristics when Auto-Tuning is complete. Examine the parameters for the measured motor characteristics after you do Stationary Auto-Tuning.

Table 3.5 Auto-Tuning Mode Selection

Method	Parameter Settings	Application Conditions and Benefits	Applicable Control Method (A1-02 Setting)	
			V/f (0)	OLV (2)
Rotational Auto-Tuning	T1-01 = 0	<ul style="list-style-type: none"> When you can decouple the motor and load the motor can rotate freely while Auto-Tuning. When operating motors that have fixed output characteristics. When it is necessary to use motors that have high-precision control. When you cannot decouple the motor and load, but the motor load is less than 30%. 	x	x
Stationary Auto-Tuning 1	T1-01 = 1	<ul style="list-style-type: none"> When you cannot decouple the motor and load. When the motor load is more than 30%. When the information from the motor test report or motor nameplate is not available. <p>With Stationary Auto-Tuning, the energized drive stays stopped for approximately 1 minute. During this time, the drive automatically measures the necessary motor parameters.</p> <ul style="list-style-type: none"> When you operate the motor with less than 30% load after Auto-Tuning. <p>Set <i>T1-12 = 1</i> [<i>Test Mode Selection = Yes</i>] to do a test run after Auto-Tuning.</p>	-	x
Stationary Line-Line Resistance	T1-01 = 2	<ul style="list-style-type: none"> After Auto-Tuning, the wiring distance between the drive and motor changed by 50 m or more. When the wiring distance is 50 m or more in the V/f Control mode. When the motor output and drive capacity are different. 	x	x

■ Input Data for Induction Motor Auto-Tuning

To do Auto-Tuning, input data for the items in Table 3.6 that have an "x". Before you start Auto-Tuning, prepare the motor test report or record the information from the motor nameplate as a reference.

Table 3.6 Input Data for Induction Motor Auto-Tuning

Input Data	Parameter	Unit	Auto-Tuning Mode (T1-01 Setting)		
			Rotational Auto-Tuning (0)	Stationary Auto-Tuning 1 (1)	Stationary Line-Line Resistance (2)
Motor Rated Power	T1-02	HP	x	x	x
Motor Rated Voltage	T1-03	V	x	x	-
Motor Rated Current	T1-04	A	x	x	x
Motor Base Frequency	T1-05	Hz	x	x	-
Number of Motor Poles	T1-06	-	x	x	-
Motor Base Speed	T1-07	min ⁻¹	x	x	-

Input Data	Parameter	Unit	Auto-Tuning Mode (T1-01 Setting)		
			Rotational Auto-Tuning (0)	Stationary Auto-Tuning 1 (1)	Stationary Line-Line Resistance (2)
Motor No-Load Current	T1-09	A	-	x	-
Motor Rated Slip Frequency	T1-10	Hz	-	x *1	-
Motor Iron Loss	T1-11	W	x *2	-	-
Test Mode Selection *3	T1-12	-	-	x *4	-
No-Load Voltage	T1-13	V	x *5	x *5	-

*1 Shows 0 Hz as the default value. If you do not know the Motor Rated Slip Frequency, keep the setting at 0 Hz.

*2 Input this value when $A1-02 = 0$ [Control Method Selection = V/f].

*3 If $T1-12 = 1$ [Test Mode Selection = Yes], when you run the motor in Drive Mode for the first time after Auto-Tuning, the drive will automatically set $E2-02$ [Motor Rated Slip] and $E2-03$ [Motor No-Load Current].

*4 Input this value when $T1-10$ [Motor Rated Slip Frequency] = 0 Hz.

*5 Set the same value to No-Load Voltage as $T1-03$ [Motor Rated Voltage] to get the same characteristics using Yaskawa 1000-Series drives or other legacy models.

◆ Auto-Tuning for PM Motors

This section gives information about Auto-Tuning for PM motors. Auto-Tuning sets motor parameters $E1-xx$ and $E5-xx$.

Table 3.7 Auto-Tuning for PM Motors

Mode	Parameter Settings	Application Conditions and Benefits	Applicable Control Method (A1-02 Setting)	
			OLV/PM (5)	AOLV/PM (6)
Manual Entry w/ Motor Data Sheet	T2-01 = 0	<ul style="list-style-type: none"> When the information from the motor test report or motor nameplate is available. Rotational/Stationary Auto-Tuning that energizes the motor is not done. Manually input the necessary motor parameters. 	x	x
PM Stationary Auto-Tuning	T2-01 = 1	<ul style="list-style-type: none"> When the information from the motor test report or motor nameplate is not available. <p>Note: With Stationary Auto-Tuning, the energized drive stays stopped for approximately 1 minute. During this time, the drive automatically measures the necessary motor parameters.</p>	x	x
PM Stationary Auto-Tuning for Stator Resistance	T2-01 = 2	<ul style="list-style-type: none"> After Auto-Tuning, the wiring distance between the drive and motor changed by 50 m (164 ft) or more. When the motor output and drive capacity are different. 	x	x
Rotational (Ld, Lq, R, back-EMF)	T2-01 = 4	<ul style="list-style-type: none"> When the information from the motor test report or motor nameplate is not available. When you can decouple the motor and load and the motor can rotate freely while Auto-Tuning. Values measured during Auto-Tuning are automatically set to the motor parameters. 	x	x
High Frequency Injection	T2-01 = 5	<ul style="list-style-type: none"> Automatically sets the control parameters that are necessary to set $n8-35 = 1$ [Initial Pole Detection Method = High Frequency Injection] or $n8-57 = 1$ [HFI Overlap Selection = Enabled]. Applicable to IPM motors only. Do Auto-Tuning with the motor connected to the drive. <p>Note: When you set $n8-35 = 1$ or $n8-57 = 1$, do High Frequency Injection Auto-Tuning. Set the data on the motor nameplate to the drive before you do High Frequency Injection Auto-Tuning. In High Frequency Injection Auto-Tuning, the drive energizes the stopped motor and automatically adjusts the parameters.</p>	x	x

■ Input Data for PM Motor Auto-Tuning

To do Auto-Tuning, input data for the items in Table 3.8 and Table 3.9 that have an "x". Before you start Auto-Tuning, prepare the motor test report or record the information from the motor nameplate as a reference.

Table 3.8 Input Data for PM Motor Auto-Tuning

Input Data	Parameter	Unit	Auto-Tuning Mode (T2-01 Setting)					
			Manual Entry w/ Motor Data Sheet (0)			PM Stationary Auto-Tuning (1)		PM Stationary Auto- Tuning for Stator Resistance (2)
Control Method Selection	A1-02	-	5, 6	5	6	5	6	5, 6
PM Motor Code Selection	T2-02	-	Motor code of Yaskawa motor *1	FFFF *2	FFFF *2	-	-	-
PM Motor Type	T2-03	-	-	-	-	x	x	-
PM Motor Rated Power	T2-04	kW	-	x	x	x	x	-
PM Motor Rated Voltage	T2-05	V	-	x	x	x	x	-
PM Motor Rated Current	T2-06	A	-	x	x	x	x	x
PM Motor Base Frequency	T2-07	Hz	-	x	-	x	-	-
Number of PM Motor Poles	T2-08	-	-	x	x	x	x	-
PM Motor Base Speed	T2-09	min ⁻¹	-	-	x	-	x	-
PM Motor Stator Resistance	T2-10	Ω	x	x	x	-	-	-
PM Motor d-Axis Inductance	T2-11	mH	x	x	x	-	-	-
PM Motor q-Axis Inductance	T2-12	mH	x	x	x	-	-	-
Back-EMF Units Selection	T2-13	-	x	x	x	-	-	-
Back-EMF Voltage Constant (Ke)	T2-14	*3	x	x	x	-	-	-
Pull-In Current Level	T2-15	%	-	-	-	x	x	-

*1 Set the motor code for a Yaskawa PM motor.

*2 Set the motor code to FFFF for a PM motor from a different manufacturer.

*3 Changes when the value set in T2-13 changes.

Table 3.9 Input Data for PM Motor Auto-Tuning

Input Data	Parameter	Unit	Auto-Tuning Mode (T2-01 Setting)		
			Rotational (Ld, Lq, R, back-EMF) (4)		High Frequency Injection (5)
Control Method Selection	A1-02	-	5	6	5, 6
PM Motor Code Selection	T2-02	-	-	-	-
PM Motor Type	T2-03	-	x	x	-
PM Motor Rated Power	T2-04	kW	x	x	-
PM Motor Rated Voltage	T2-05	V	x	x	-
PM Motor Rated Current	T2-06	A	x	x	-
PM Motor Base Frequency	T2-07	Hz	x	-	-
Number of PM Motor Poles	T2-08	-	x	x	-
PM Motor Base Speed	T2-09	min ⁻¹	-	x	-
Pull-In Current Level	T2-15	%	x	x	-

◆ Auto-Tuning in EZ Open Loop Vector Control Method

This section gives information about the Auto-Tuning mode for EZ Open Loop Vector Control. Auto-Tuning will set the $E\theta$ -xx parameters.

Table 3.10 EZ Tuning Mode Selection

Mode	Parameter Settings	Application Conditions and Benefits	Applicable Control Method (A1-02 Setting)
Motor Parameter Setting	T4-01 = 0	<ul style="list-style-type: none"> Applicable when driving an induction motor or a PM motor Suitable for derating torque applications, for example fans and pumps. 	EZOLV (8)
Line-to-Line Resistance	T4-01 = 1	<ul style="list-style-type: none"> After Auto-Tuning, the wiring distance between the drive and motor changed by 50 m or more. When the motor output and drive capacity are different. 	EZOLV (8)

■ Auto-Tuning Input Data in EZ Open Loop Vector Control Method

To do Auto-Tuning, input data for the items in Table 3.11 that have an "x". Before you start Auto-Tuning, prepare the motor test report or record the information from the motor nameplate as a reference.

Table 3.11 Auto-Tuning Input Data in EZ Open Loop Vector Control Method

Input Data	Parameter	Unit	Auto-Tuning Mode (T4-01 Setting)	
			Motor Parameter Setting (0)	Line-to-Line Resistance (1)
Motor Type Selection	T4-02	-	x	-
Motor Max Revolutions	T4-03	min ⁻¹	x	-
Motor Rated Revolutions	T4-04	min ⁻¹	x	-
Motor Rated Frequency	T4-05	Hz	x	-
Motor Rated Voltage	T4-06	V	x	-
Motor Rated Current (FLA)	T4-07	A	x	x
PM Motor Rated Power (kW)	T4-08	kW	x	x
Number of Motor Poles	T4-09	-	x	-

◆ ASR and Inertia Tuning

To increase drive responsiveness and prevent hunting, use Auto-Tuning to automatically adjust the control-related parameters.

These types of Auto-Tuning are available for the control system:

- Deceleration Rate Tuning
- KEB Tuning

Note:

If you do Control Tuning, you cannot set $H1-xx = 16$ [Motor 2 Selection]. Do not do Control Tuning for applications that switch between motor 1 and motor 2.

Table 3.12 Control Loop Tuning Selection

Mode	Parameter Settings	Application Conditions and Benefits	Applicable Control Methods (A1-02 Settings)				
			V/f (0)	OLV (2)	OLV/PM (5)	AOLV/PM (6)	EZOLV (8)
Deceleration Rate Tuning	T3-00 = 2	To automatically adjust the deceleration rate to prevent an <i>ov</i> [Overvoltage] fault.	x	x	x	x	x
KEB Tuning	T3-00 = 3	<ul style="list-style-type: none"> To automatically adjust parameter settings to prevent an <i>ov</i> [Overvoltage] fault with the KEB Ride-Thru function. When $L3-11 = 1$ [Overvoltage Suppression Select = Enabled]. 	x	x	x	x	x

■ Deceleration Rate Tuning

Deceleration Rate Tuning automatically sets the deceleration rate to prevent an *ov* [Overvoltage] fault during motor deceleration. Set $C1-11$ [Accel/Decel Time Switchover Freq] first to automatically set parameters $C1-02$ [Deceleration Time 1] (high speed range) and $C1-08$ [Deceleration Time 4] (low speed range).

■ KEB Tuning

KEB Tuning automatically sets parameters used for the KEB Ride-Thru function and for the overvoltage suppression function.

Control Tuning automatically sets the parameters in [Table 3.13](#) to the best values.

Table 3.13 Parameters set in Control Tuning

Parameters Automatically Set	Deceleration Rate Tuning	KEB Tuning
C1-02 [Deceleration Time 1]	x	-
C1-08 [Deceleration Time 4]	x ^{*1}	-
C1-09 [Fast Stop Time]	-	x ^{*2}
L2-06 [Kinetic Energy Backup Decel Time]	-	x ^{*3}
L3-25 [Load Inertia Ratio]	-	x

*1 The drive automatically sets C1-08 [Deceleration Time 4] only when C1-11 [Accel/Decel Time Switchover Freq] ≠ 0.

*2 When L2-29 = 0 [Kinetic Energy Backup Method = Single Drive KEB Ride-Thru 1], the drive will automatically adjust C1-09 [Fast Stop Time] and will not adjust L2-06 [Kinetic Energy Backup Decel Time]. If you must not change the Fast Stop time, do not do KEB Tuning.

*3 When L2-29 = 1, 2, or 3 [Kinetic Energy Backup Method = Single Drive KEB Ride-Thru 2, System KEB Ride-Thru 1, or System KEB Ride-Thru 2], the drive will automatically adjust L2-06 [Kinetic Energy Backup Decel Time].

◆ Precautions before Auto-Tuning

Examine the topics in this section before you start Auto-Tuning.

■ Prepare for Basic Auto-Tuning

- You must input data from the motor nameplate or motor test report to do Auto-Tuning. Make sure that this data is available before you do Auto-Tuning.
- For best performance, make sure that the drive input supply voltage is equal to or more than the motor rated voltage.

Note:

Better performance is possible when you use a motor with a rated voltage that is less than the input supply voltage (by 20 V for 200 V class models or by 40 V for 400 V class models). This is very important when you operate the motor at more than 90% of base speed, where high torque precision is necessary. If the input power supply is equal to the motor rated voltage, the drive output voltage will not be sufficient and performance will decrease.

- Push  on the keypad to cancel Auto-Tuning.
- If a Safe Disable input signal is input to the drive during Auto-Tuning, Auto-Tuning measurements will not complete successfully. If this occurs, cancel the Auto-Tuning, then do it again.
- [Table 3.14](#) shows the status of multi-function input/output terminals during Auto-Tuning.

Table 3.14 Status of Input/Output Terminals during Auto-Tuning

Auto-Tuning Type	Mode	Parameter	Multi-Function Input	Multi-Function Output ^{*1}	
Induction Motor Auto-Tuning	Rotational	Rotational Auto-Tuning	T1-01 = 0	Disabled	Functions the same as during usual operation.
	Stationary	Stationary Auto-Tuning 1	T1-01 = 1	Disabled	Keeps the status at the start of Auto-Tuning.
		Line-to-Line Resistance	T1-01 = 2	Disabled	Keeps the status at the start of Auto-Tuning.
PM Motor Auto-Tuning	Rotational	PM Rotational Auto-tuning	T2-01 = 4	Disabled	Functions the same as during usual operation.
	Stationary	PM Motor Parameter Settings	T2-01 = 0	Disabled	Keeps the status at the start of Auto-Tuning.
		PM Stationary Auto-Tuning	T2-01 = 1	Disabled	Keeps the status at the start of Auto-Tuning.
		PM Stationary Auto-Tuning for Stator Resistance	T2-01 = 2	Disabled	Keeps the status at the start of Auto-Tuning.
	High Frequency Injection	T2-01 = 5	Disabled	Keeps the status at the start of Auto-Tuning.	

Auto-Tuning Type	Mode	Parameter	Multi-Function Input	Multi-Function Output */	
EZ Tuning	Stationary	Motor Parameter Setting	T4-01 = 0	Disabled	Keeps the status at the start of Auto-Tuning.
		Line-to-Line Resistance	T4-01 = 1	Disabled	Keeps the status at the start of Auto-Tuning.
ASR and Inertia Tuning	Rotational	Deceleration Rate Tuning	T3-00 = 2	Disabled	Functions the same as during usual operation.
		KEB Tuning	T3-00 = 3	Disabled	Functions the same as during usual operation.

*1 When you set a terminal to H2-xx = E [MFDO Function Selection = Fault], it will function the same as during usual operation.

WARNING! Crush Hazard. Wire a sequence that will not let a multi-function output terminal open the holding brake during Stationary Auto-Tuning. If the holding brake is open during Stationary Auto-Tuning, it can cause serious injury or death.

WARNING! Sudden Movement Hazard. Before you do Rotational Auto-Tuning, disconnect the load from the motor. The load can move suddenly and cause serious injury or death.

WARNING! Injury to Personnel. Rotational Auto-Tuning rotates the motor at 50% or more of the motor rated frequency. Make sure that there are no issues related to safety in the area around the drive and motor. Increased motor frequency can cause serious injury or death.

WARNING! Electrical Shock Hazard. During Auto-Tuning, the motor will receive high voltage when the motor is stopped. Do not touch the motor until Auto-Tuning is complete. If you touch a motor that is energized, it can cause serious injury or death.

■ Precautions before Rotational Auto-Tuning

WARNING! Electrical Shock Hazard. During Auto-Tuning, the motor will receive high voltage when the motor is stopped. Do not touch the motor until Auto-Tuning is complete. If you touch a motor that is energized, it can cause serious injury or death.

- Before you do Rotational Auto-Tuning to prevent drive malfunction, uncouple the motor from the load. If you do Rotational Auto-Tuning with the motor connected to a load that is more than 30% of the motor duty rating, the drive will not correctly calculate the motor parameters and the motor can operate incorrectly.
- When the load is 30% or less of the motor duty rating, you can do Auto-Tuning with the motor connected to a load.
- Make sure that the motor magnetic brake is released.
- Make sure that external force from the machine will not cause the motor to rotate.

■ Precautions before Stationary Auto-Tuning

- Make sure that the motor magnetic brake is not open.
- Make sure that external force from the machine will not cause the motor to rotate.

WARNING! Electrical Shock Hazard. During Auto-Tuning, the motor will receive high voltage when the motor is stopped. Do not touch the motor until Auto-Tuning is complete. If you touch a motor that is energized, it can cause serious injury or death.

■ Automatically Set E2-02 [Motor Rated Slip] and E2-03 [Motor No-Load Current]

If T1-12 = 1 [Test Mode Selection = Yes] when selecting Stationary Auto-Tuning, the drive will automatically set motor parameters E2-02 [Motor Rated Slip] and E2-03 [Motor No-Load Current] after Auto-Tuning is complete when you use the motor for the first time in Drive Mode.

After Stationary Auto-Tuning is complete, use this procedure to do the operation in test mode:

1. Check the E2-02 and E2-03 values on the “Modified Parameters/Fault Log” screen or the “Parameters” screen.
2. Operate the motor in Drive Mode with these conditions:
 - Make sure that you connect all wiring between the drive and motor
 - Make sure that a mechanical brake on the motor shaft is not locked
 - The maximum motor load must be 30% of the rated load.
 - Keep a constant speed of 30% of E1-06 [Base Frequency] (default value = maximum frequency) or more for 1 second or longer.
3. After the motor stops, examine the values of E2-02 and E2-03 again in the Verify Menu or Parameter Setting Mode.
4. Make sure that the input data is correct.
When the settings in E2-02 and E2-03 are different than in step 1, the drive set the values automatically.

■ Precautions before Stationary Auto-Tuning for Line-to-Line Resistance and Stator Resistance Auto-Tuning

In V/f control, when the motor cable is 50 meters (164 feet) or longer, do Stationary Auto-Tuning for Line-to-Line Resistance.

WARNING! *Electrical Shock Hazard. During Auto-Tuning, the motor will receive high voltage when the motor is stopped. Do not touch the motor until Auto-Tuning is complete. If you touch a motor that is energized, it can cause serious injury or death.*

■ Precautions before Using Deceleration Rate Tuning and KEB Tuning

Before Deceleration Rate Tuning or KEB Tuning, check these items:

Note:

- Do not do Deceleration Rate Tuning if you use a braking resistor unit or a regenerative converter.
- Do Deceleration Rate Tuning and KEB Tuning with the load attached to the motor.
- Do not do Deceleration Rate Tuning or KEB Tuning for these applications:
In Deceleration Rate Tuning and KEB Tuning, the drive will automatically rotate the motor forward and accelerate and decelerate the motor again and again.
 - On a machine that does not let the motor rotate forward
 - In applications with a small range of operation (trolleys and other such applications that can only move linearly)
 - Applications where sudden acceleration and sudden deceleration are not applicable.
- To do KEB Tuning with the external main circuit capacitors connected to the drive, set *L3-26 [Additional DC Bus Capacitors]* then do KEB Tuning.
- Do not do KEB Tuning or Deceleration Rate Tuning if the drive is set to use *H1-xx = 16 [MFDI Function Select = Motor 2 Selection]*. Failure to obey can cause an *ov [Overvoltage]* fault.

3.6 Test Run

After you set the basic parameters and do Auto-Tuning, do a test run.

WARNING! Crush Hazard. Test the system to make sure that the drive operates safely after you wire the drive and set parameters. If you do not test the system, it can cause damage to equipment or serious injury or death.

◆ No-Load Test Run

Before connecting the motor to the machine, make sure that you check the operation status of the motor.

■ Precautions before Operation

Before rotating the motor, check these items:

- Check for safety issues near the drive, motor, and machine.
- Make sure that all emergency stop circuits and machine safety mechanisms are operating correctly.

■ Items to Check before Operation

Check these items before operation:

- Is the motor rotating in the forward direction?
- Is the motor rotating smoothly (no unusual sounds or unusual vibrations)?
- Does the motor accelerate/decelerate smoothly?

◆ Do a No-Load Test Run

Do these steps for a no-load test run:

1. Energize the drive, or push **ESC** to show the frequency reference screen.
2. Push **LO/RE** to illuminate the LOCAL/REMOTE LED.
3. Use **▲** / **▼** / **◀** / **▶** to set $d1-01 = 6.00$ [Frequency Reference 1 = 6.00 Hz], then push **↵**.
4. Push **◀RUN**.
The RUN indicator illuminates, and the motor runs at 6.00 Hz in the forward direction.
5. Make sure that the motor is rotating in the correct direction and that the drive does not show a fault. If the drive detects a fault, remove the cause.

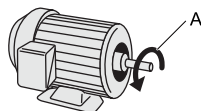

A - Forward Rotation of Motor (Counter Clockwise Direction as Seen from Load Shaft)

6. Push **▲** to increase the frequency reference value.
Change the setting value in increments of 10 Hz if necessary and examine the response.
Ex.: 6 Hz → 20 Hz → 30 Hz → 40 Hz → 50 Hz → 60 Hz
7. Each time you increase the setting value, use $U1-03$ [Output Current] to check the drive output current. When the output current of the drive is not more than the motor rated current, the status is correct.
8. Make sure that the motor rotates correctly, then push **STOP**.
The RUN LED flashes and goes off when the motor stops completely.

◆ Actual-Load Test Run

Test the operation without a load, then connect the motor and machine to do a test run.

■ Precautions before Operation

Before rotating the motor, check these items:

- Check for safety issues near the drive, motor, and machine.
- Make sure that all emergency stop circuits and machine safety mechanisms are operating correctly.
- Make sure that the motor is fully stopped.
- Connect the motor with the machine.
Make sure that there are no loose installation screws and that the motor load shafts and machine junctions are correctly secured.
- Keep the keypad near you to push  immediately if there is unusual or incorrect operation.

■ Items to Check before Operation











- Make sure that the direction of the machine operation is correct (The motor must rotate in the correct direction).
- Make sure that the motor accelerates and decelerates smoothly.

◆ Do an Actual-Load Test Run

Note:

During a test run, make sure that *U1-03 [Output Current]* is not too high.

Connect the motor and machine, then do the test run with the same procedure that you used for the no-load test run.

1. Energize the drive, or push  to show the frequency reference screen.
2. Use  /  /  /  to set *d1-01 = 6.00 [Frequency Reference 1 = 6.00 Hz]*, then push .
3. Push  to illuminate the LOCAL/REMOTE LED.
4. Push .
The RUN indicator illuminates, and the motor runs at 6.00 Hz in the forward direction.
5. Make sure that the motor is rotating in the correct direction and that the drive does not show a fault.
If the drive detects a fault, remove the cause.
6. Push  to increase the frequency reference value.
Change the setting value in increments of 10 Hz if necessary and examine the response.
Ex.: 6 Hz → 20 Hz → 30 Hz → 40 Hz → 50 Hz → 60 Hz
7. Each time you increase the setting value, use *U1-03 [Output Current]* to check the drive output current.
When the output current of the drive is not more than the motor rated current, the status is correct.
8. Make sure that the motor rotates correctly, then push .
The RUN LED flashes and goes off when the motor stops completely.
9. Change the frequency reference and direction of motor rotation, and make sure that there are no unusual sounds or vibrations.
10. If the control function causes hunting or oscillation errors, adjust the settings to stop the errors.

3.7 Fine Tuning during Test Runs (Adjust the Control Function)

This section gives information about the adjustment procedures to stop hunting or oscillation errors caused by the control function during a test run. Adjust the applicable parameters as specified by your control method and drive status.

- [V/f Control on page 481](#)
- [Open Loop Vector Control for PM Motors on page 484](#)
- [Advanced Open Loop Vector Control Method for PM Motors on page 485](#)
- [EZ Open Loop Vector Control Method on page 485](#)

Note:

This section only lists frequently adjusted parameters. If you must adjust parameters that have a higher degree of precision, contact Yaskawa.

◆ V/f Control

Table 3.15 Parameters for Fine Tuning the Drive (A1-02 = 0 [V/f])

Issue	Parameter Number	Possible Solutions	Default	Recommended Setting
Hunting or oscillation at mid-range speeds (10 Hz to 40 Hz)	n1-02 [Hunting Prevention Gain Setting]	<ul style="list-style-type: none"> • If torque is not sufficient with heavy loads, decrease the setting value. • If hunting or oscillation occur with light loads, increase the setting value. • If hunting occurs with a low-inductance motor, for example a motor with a larger frame size or a high-frequency motor, lower the setting value. Set n1-01 = 1 [Hunting Prevention Selection = Enabled]. 	1.00	0.10 - 2.00
<ul style="list-style-type: none"> • The volume of the motor excitation sound is too high. • Hunting or oscillation at low speeds (10 Hz or lower), or at mid-range speeds (10 Hz to 40 Hz) 	C6-02 [Carrier Frequency Selection]	<ul style="list-style-type: none"> • If the volume of the motor excitation sound is too high, increase the carrier frequency. • If hunting or oscillation occur at low or mid-range speeds, decrease the carrier frequency. 	1 (2 kHz) *1	1 to upper limit value
<ul style="list-style-type: none"> • Unsatisfactory motor torque and speed response • Hunting or oscillation 	C4-02 [Torque Compensation Delay Time]	<ul style="list-style-type: none"> • If torque or speed response are slow, decrease the setting value. • If hunting or oscillation occur, increase the setting value. 	200 ms *2	100 ms to 1000 ms
<ul style="list-style-type: none"> • Torque at low speeds (10 Hz or lower) is not sufficient. • Hunting or oscillation 	C4-01 [Torque Compensation Gain]	<ul style="list-style-type: none"> • If torque at low speeds (10 Hz or lower) is not sufficient, increase the setting value. • If hunting or oscillation occur with light loads, decrease the setting value. 	1.00	0.50 - 1.50
• If you use the drive with an IE3 high efficiency motor, the current that is more than the motor rated current will flow and trip at overload. Hunting or oscillation.	C4-01 [Torque Compensation Gain]	Decrease the setting value in these conditions: <ul style="list-style-type: none"> • Drive trips at overload. • Hunting or oscillation. 	1.00	0.00 - 1.00
<ul style="list-style-type: none"> • Torque at low speeds (10 Hz or lower) is not sufficient. • Large initial vibration at start up. 	<ul style="list-style-type: none"> • E1-08 [Mid Point A Voltage] • E1-10 [Minimum Output Voltage] 	<ul style="list-style-type: none"> • If torque at low speeds (10 Hz or lower) is not sufficient, increase the setting value. • If there is large initial vibration at start up, decrease the setting value 	<ul style="list-style-type: none"> • E1-08: 16.0 V *3 • E1-10: 12.0 V *3 	Default setting +/- 5 V *4
Speed precision is unsatisfactory.	C3-01 [Slip Compensation Gain]	Set E2-01 [Motor Rated Current], E2-02 [Motor Rated Slip], and E2-03 [Motor No-Load Current], then adjust C3-01.	0.0 (no slip compensation)	0.5 - 1.5

*1 The default setting changes when the settings for C6-01 [Normal / Heavy Duty Selection] and o2-04 [Drive Model (KVA) Selection] change.

*2 The default setting changes when the settings for A1-02 [Control Method Selection] and o2-04 change.

*3 The default setting changes when the settings for A1-02 and E1-03 [V/f Pattern Selection] change.

*4 Recommended settings are for 200 V class drives. Multiply the voltage by 2 for 400 V class drives.

■ **Precaution When You Use IE3 Premium Efficiency Motors**

IE3 motors have different motor characteristics from IE1 and other motors. Set the parameters as specified by the motor characteristics. If you have a momentary power loss, and the drive detects *oC* [Overcurrent] or *ov* [Overvoltage] during speed search after it restores power, set these parameters:

- *b3-03* [Speed Search Deceleration Time] = default value × 2
- *L2-03* [Minimum Baseblock Time] = default value × 2
- *L2-04* [Powerloss V/f Recovery Ramp Time] = default value × 2

◆ **Open Loop Vector Control Method**

In Open Loop Vector Control, keep *C4-01* [Torque Compensation Gain] at its default setting (1.00).

If you cannot get speed precision during regeneration in Open Loop Vector Control, set *C3-04* = 1 [Slip Compensation at Regen = Enabled Above 6 Hz].

Table 3.16 Parameters for Fine Tuning the Drive (A1-02 = 2 [OLV])

Issue	Parameter Number	Possible Solutions	Default	Recommended Setting
<ul style="list-style-type: none"> • Unsatisfactory motor torque and speed response • Hunting or oscillation at mid-range speeds (10 Hz to 40 Hz) 	<i>n2-01</i> [Automatic Freq Regulator Gain]	<ul style="list-style-type: none"> • To increase the speed of torque or speed response, decrease the setting value in 0.05-unit increments. • If hunting or oscillation occur, decrease the setting value in 0.05-unit increments. 	1.00	0.50 to 2.00
	<i>n2-02</i> [Automatic Freq Regulator Time 1]	<ul style="list-style-type: none"> • To increase the speed of torque or speed response, decrease the setting value in 10 ms increments and examine the response. • If hunting or oscillation occur or if the load inertia is too much, increase the setting value in 50 ms increments and examine the response. <p>Note: Make sure that this parameter setting is: $n2-02 \leq n2-03$ [Automatic Freq Regulator Time 2]. When you adjust <i>n2-02</i>, you must also increase the <i>C4-02</i> [Torque Compensation Delay Time] value by the same ratio.</p>	50 ms	50 ms to 2000 ms
<p><i>ov</i> [Overvoltage] occurs when the drive stops accelerating, starts to decelerate, or when there are large changes in the load.</p>	<i>n2-03</i> [Automatic Freq Regulator Time 2]	<ul style="list-style-type: none"> • If <i>ov</i> occurs, increase the setting value in 50 ms increments and examine the response. • If the response is not sufficient, decrease the setting value in 10 ms increments and examine the response. <p>Note: Make sure that this parameter setting is: $n2-02$ [Automatic Freq Regulator Time 1] $\leq n2-03$. When you adjust <i>n2-03</i>, you must also increase the <i>C4-06</i> [Motor 2 Torque Comp Delay Time] value by the same ratio.</p>	750 ms	750 ms to 2000 ms
	<i>C4-06</i> [Motor 2 Torque Comp Delay Time]	<ul style="list-style-type: none"> • If <i>ov</i> occurs, increase the setting value in 10 ms increments and examine the response. • If the response is not sufficient, decrease the setting value in 2 ms increments and examine the response. <p>Note: Make sure that this parameter setting is: $C4-02$ [Torque Compensation Delay Time] $\leq C4-06$. When you adjust <i>C4-06</i>, you must also increase the <i>n2-03</i> [Automatic Freq Regulator Time 2] value by the same ratio.</p>	150 ms	150 ms to 750 ms

Issue	Parameter Number	Possible Solutions	Default	Recommended Setting
<ul style="list-style-type: none"> Unsatisfactory motor torque and speed response Hunting or oscillation 	C4-02 [Torque Compensation Delay Time]	<ul style="list-style-type: none"> If torque or speed response are slow, decrease the setting value in 2 ms increments. If hunting or oscillation occur, increase the setting value in 10 ms increments. <p>Note: Make sure that this parameter setting is: $C4-02 \leq C4-06$ [Motor 2 Torque Comp Delay Time].</p> <p>When you adjust C4-02, you must also increase the n2-02 [Automatic Freq Regulator Time 1] value by the same ratio.</p>	20 ms *1	20 ms - 100 ms *1
<ul style="list-style-type: none"> Speed response is slow. Speed is not stable. 	C3-02 [Slip Compensation Delay Time]	<ul style="list-style-type: none"> If speed response is slow, decrease the setting value in 10 ms increments. If speed is not stable, increase the value in 10 ms increments. 	200 ms *1	100 ms to 500 ms
Speed precision is unsatisfactory.	C3-01 [Slip Compensation Gain]	<ul style="list-style-type: none"> If speed is too slow, increase the setting value in 0.1 unit increments. If speed is too fast, decrease the setting value in 0.1 unit increments. 	1.0 *2	0.5 to 1.5
<ul style="list-style-type: none"> The volume of the motor excitation sound is too high. Hunting or oscillation at low speeds (10 Hz or lower) 	C6-02 [Carrier Frequency Selection]	<ul style="list-style-type: none"> If the volume of the motor excitation sound is too high, increase the carrier frequency. If hunting or oscillation occur at low speeds, decrease the carrier frequency. 	7 (Swing PWM1) *3	0 to upper limit value
<ul style="list-style-type: none"> Torque at low speeds (10 Hz or lower) is not sufficient. speed response is slow. Speed response is slow. Large initial vibration at start up. 	<ul style="list-style-type: none"> E1-08 [Mid Point A Voltage] E1-10 [Minimum Output Voltage] 	<ul style="list-style-type: none"> If torque or speed response are slow, increase the setting value. If there is large initial vibration at start up, decrease the setting value <p>Note: If you set the value too high, the drive can output a large torque reference although the load is light.</p>	<ul style="list-style-type: none"> E1-08: 12.0 V *2 E1-10: 2.5 V *2 	Default setting +/- 2 V *4

*1 The default setting changes when the settings for A1-02 [Control Method Selection] and o2-04 [Drive Model (KVA) Selection] change.

*2 The default setting changes when the settings for A1-02 [Control Method Selection] and E1-03 [V/f Pattern Selection] change.

*3 The default setting changes when the settings for C6-01 [Normal / Heavy Duty Selection] and o2-04 change.

*4 Recommended settings are for 200 V class drives. Multiply the voltage by 2 for 400 V class drives.

■ Precaution When You Use IE3 Premium Efficiency Motors

IE3 motors have different motor characteristics from IE1 and other motors. Set the parameters as specified by the motor characteristics. If you have a momentary power loss, and the drive detects *oC* [Overcurrent] or *ov* [Overvoltage] during speed search after it restores power, set these parameters:

- $b3-03$ [Speed Search Deceleration Time] = default value $\times 2$
- $L2-03$ [Minimum Baseblock Time] = default value $\times 2$
- $L2-04$ [Powerloss V/f Recovery Ramp Time] = default value $\times 2$

◆ Open Loop Vector Control for PM Motors

Table 3.17 Parameters for Fine Tuning the Drive (A1-02 = 5 [OLV/PM])

Issue	Parameter Number	Possible Solutions	Default	Recommended Setting
Unsatisfactory motor performance	E1-xx parameters, E5-xx parameters	<ul style="list-style-type: none"> Check the settings for E1-06, E1-04 [Base Frequency, Maximum Output Frequency]. Check the E5-xx and make sure that you set all motor data correctly. <p>Note: Do not set E5-05 [PM Motor Resistance (ohms/phase)] to a line-to-line resistance value.</p> <ul style="list-style-type: none"> Do Auto-Tuning. 	-	-
Unsatisfactory motor torque and speed response	n8-55 [Motor to Load Inertia Ratio]	Adjust to align the load inertia ratio of the motor and machine.	0	Near the load inertia ratio.
	n8-45 [Speed Feedback Detection Gain]	Decrease the setting value in increments of 0.05.	0.80	-
	C4-01 [Torque Compensation Gain]	Adjust the setting value. Note: If you set this value too high, it can cause overcompensation and motor oscillation.	0.00	1.00
<ul style="list-style-type: none"> Oscillation when the motor starts. Motor stalls. 	n8-51 [Pull-in Current @ Accel/Decel]	Increase the setting value in increments of 5%.	50%	-
	<ul style="list-style-type: none"> b2-02 [DC Injection Braking Current] b2-03 [DC Inject Braking Time at Start] 	Use DC Injection Braking at start. Note: This can cause the motor to rotate in reverse for approximately 1/8 of a turn at start.	<ul style="list-style-type: none"> b2-02: 50% b2-03: 0.00 s 	<ul style="list-style-type: none"> b2-02: Adjust as necessary. b2-03: 0.5 s
	n8-55 [Motor to Load Inertia Ratio]	Increase the setting value. Note: When you operate a single motor or with a minimum quantity of inertia, if you set this value too high, it can cause motor oscillation.	0	Near the load inertia ratio.
There is too much current during deceleration.	n8-79 [Pull-in Current at Deceleration]	Set $n8-79 < n8-51$.	50% Note: When $n8-79 = 0$, the drive will apply the $n8-51$ setting to the pull-in current during deceleration.	Decrease in increments of 5%.
Stalling or oscillation occurs when you apply the load during constant speed	n8-47 [Pull-in Current Comp Filter Time]	Decrease the setting value in increments of 0.2 s.	5.0 s	-
	n8-48 [Pull-in/Light Load Id Current]	Increase the setting value in increments of 5%.	30%	-
	n8-55 [Motor to Load Inertia Ratio]	Increase the setting value. Note: When you operate a single motor or with a minimum quantity of inertia, if you set this value too high, it can cause motor oscillation.	0	Near the load inertia ratio.
Hunting or oscillation	n8-45 [Speed Feedback Detection Gain]	Increase the setting value in increments of 0.05.	0.80	-
The drive detects STPo [Motor Step-Out Detected] fault when the load is not too high.	<ul style="list-style-type: none"> E5-09 [PM Back-EMF Vpeak (mV/(rad/s))] E5-24 [PM Back-EMF L-L Vrms (mV/rpm)] 	<ul style="list-style-type: none"> Adjust the setting value. Examine the motor code on the motor nameplate or the data sheet, then set correct values for E5-09 or E5-24. 	*1	<ul style="list-style-type: none"> Yaskawa motor Set the motor code from the motor nameplate. Motor from another manufacturer Set the values from the test report.
The drive detected stalling or STPo [Motor Step-Out Detected] at high speed and maximum output voltage.	n8-62 [Output Voltage Limit Level]	Set to a value lower than the actual input voltage.	<ul style="list-style-type: none"> 200.0 V 400.0 V 	-

*1 The default setting changes when the settings for E5-01 [Motor Code Selection] and o2-04 [Drive Model (KVA) Selection] change.

◆ Advanced Open Loop Vector Control Method for PM Motors

Table 3.18 Parameters for Fine Tuning the Drive (A1-02 = 6 [AOLV/PM])

Issue	Parameter Number	Possible Solutions	Default	Recommended Setting
<ul style="list-style-type: none"> Unsatisfactory motor torque and speed response Hunting or oscillation 	<ul style="list-style-type: none"> High speed C5-01 [ASR Proportional Gain 1] Low speed C5-03 [ASR Proportional Gain 2] 	<ul style="list-style-type: none"> If torque or speed response are slow, increase the setting value in increments of 5.00. If hunting or oscillation occur, decrease the setting value. 	10.00	5.00 to 30.00 ^{*1}
	<ul style="list-style-type: none"> High speed C5-02 [ASR Integral Time 1] Low speed C5-04 [ASR Integral Time 2] 	<ul style="list-style-type: none"> If torque or speed response are slow, decrease the setting value. If hunting or oscillation occur, increase the setting value. 	0.500 s	0.300 s to 1.000 s ^{*1}
The drive cannot find ASR proportional gain or integral time for low speed or high speed.	C5-07 [ASR Gain Switchover Frequency]	Change the ASR proportional gain and ASR integral time to conform to the output frequency.	0.0%	0.0% to maximum rotation speed
Hunting or oscillation	C5-06 [ASR Delay Time]	If the rigidity of the machine is unsatisfactory and vibration is possible, increase the setting value in increments of 0.010.	0.016 s	0.016 s to 0.035 s ^{*1}
Step-out	E1-xx parameters, E5-xx parameters	Refer to the motor nameplate or test report and set E1-xx or E5-xx correctly.	-	-

*1 The best values for a no-load operation are different than the best values for actual loading operation.

◆ EZ Open Loop Vector Control Method

Table 3.19 Parameters for Fine Tuning the Drive (A1-02 = 8 [EZOLV])

Issue	Parameter Number	Possible Solutions	Default	Recommended Setting
<ul style="list-style-type: none"> Unsatisfactory motor torque and speed response Hunting or oscillation 	<ul style="list-style-type: none"> High speed C5-01 [ASR Proportional Gain 1] Low speed C5-03 [ASR Proportional Gain 2] 	<ul style="list-style-type: none"> If torque or speed response are slow, increase the setting value in increments of 5.00. If hunting or oscillation occur, decrease the setting value. 	10.00	10.00 to 50.00 ^{*1}
	<ul style="list-style-type: none"> High speed C5-02 [ASR Integral Time 1] Low speed C5-04 [ASR Integral Time 2] 	<ul style="list-style-type: none"> If torque or speed response are slow, decrease the setting value. If hunting or oscillation occur, increase the setting value. 	0.500 s	0.300 s to 1.000 s ^{*1}
The drive cannot find ASR proportional gain or integral time for low speed or high speed.	C5-07 [ASR Gain Switchover Frequency]	Change the ASR proportional gain and ASR integral time to conform to the output frequency.	0.0%	0.0% to maximum rotation speed
Hunting or oscillation	C5-06 [ASR Delay Time]	If the rigidity of the machine is unsatisfactory and vibration is possible, increase the setting value in increments of 0.010.	0.004 s	0.004 s to 0.020 s ^{*1}
Step-out	E9-xx parameters	Refer to the motor nameplate or test report and set E9-xx correctly.	-	-
Oscillation when the motor starts.	n8-51 [Accel / Decel Pull-In Current]	Increase the setting value.	80%	Increase in increments of 5%.
Motor stalls.	L7-01 to L7-04 [Torque Limit]	Increase the setting value.	200%	Increase in increments of 10%.

*1 The best values for a no-load operation are different than the best values for actual loading operation.

3.8 Test Run Checklist

Examine the items in this checklist and check each item before a test run.

Checked	No.	Description
	1	Correctly install and wire the drive as specified by this manual.
	2	Energize the drive.
	3	Set the voltage for the power supply in <i>E1-01 [Input AC Supply Voltage]</i> .

Check the applicable items as specified by your control method.

WARNING! Sudden Movement Hazard. Correctly wire the start/stop and safety circuits before you energize the drive. If you momentarily close a digital input terminal, it can start a drive that is programmed for 3-Wire control and cause serious injury or death from moving equipment.

Table 3.20 V/f [A1-02 = 0]

Checked	No.	Description
	4	Select the best V/f pattern for your application and motor characteristics. Example: For a motor with a rated frequency of 60 Hz, set <i>E1-03 = 1 [V/f Pattern Selection = Const Trq, 60Hz base, 60Hz max]</i> as a standard V/f pattern.

Table 3.21 OLV [A1-02 = 2]

Checked	No.	Description
	5	Decouple motor shafts and machines.
	6	Refer to the information on the motor nameplate and set this data correctly: <ul style="list-style-type: none"> • Motor rated power (kW) to <i>T1-02</i> • Motor rated voltage (V) to <i>T1-03</i> • Motor rated current (A) to <i>T1-04</i> • Motor base frequency (Hz) to <i>T1-05</i> • Number of motor poles to <i>T1-06</i> • Motor base speed (min^{-1}) to <i>T1-07</i>
	7	Do Rotational Auto-Tuning.

Table 3.22 OLV/PM [A1-02 = 5]

Checked	No.	Description
	8	Set <i>E5-01 to E5-24 [PM Motor Settings]</i> according to manufacturer data, or do Rotational Auto-Tuning

Table 3.23 AOLV/PM [A1-02 = 6]

Checked	No.	Description
	9	Set <i>E5-01 to E5-24 [PM Motor Settings]</i> according to manufacturer data, or do Rotational Auto-Tuning
	10	Set <i>C5-01 [ASR Proportional Gain 1]</i> and <i>C5-02 [ASR Integral Time 1]</i> .

Checked	No.	Description
	11	Make sure that the keypad shows READY LED before you start to operate the motor.
	12	To give the Run command and frequency reference from the keypad, push LORE to set to LOCAL Mode (when in LOCAL Mode, the LO/RE LED illuminates).
	13	If the motor rotates in the opposite direction during test run, switch two of the motor cables (U/T1, V/T2, W/T3).
	14	Set Heavy Duty or Normal Duty Mode with <i>C6-01 [Normal / Heavy Duty Selection]</i> to conform to the load condition.
	15	Set <i>E2-01 [Motor Rated Current (FLA)]</i> and <i>L1-01 [Motor Overload (oL1) Protection]</i> correctly for motor thermal protection.
	16	Set the drive for REMOTE Mode when the control circuit terminals supply the Run command and frequency reference (in REMOTE Mode, the LO/RE LED turns OFF).
	17	When you use terminal A1 for the frequency reference: <ul style="list-style-type: none"> • Set <i>H3-01 = 0, 4 [Terminal A1 Signal Level Select = 0 to 10 V (Lower Limit at 0), -10 to +10V (Bipolar Reference)]</i>. • Set <i>H3-02 = 0 [Terminal A1 Function Selection = Frequency Reference]</i>.

Checked	No.	Description
	18	<p>When you use terminal A2 for the frequency reference:</p> <ul style="list-style-type: none"> • Voltage input <ul style="list-style-type: none"> – Set DIP Switch S1 on the drive to "V". – Set H3-09 = 0, 4 [Terminal A2 Signal Level Select = 0-10V (Lower Limit at 0), -10 to +10V (Without Lower Limit)]. – Set H3-10 = 0 [Terminal A2 Function Selection = Frequency Reference]. • Current input <ul style="list-style-type: none"> – Set DIP Switch S1 on the drive to "I". – Set H3-09 = 2, 3 [Terminal A2 Signal Level Select = 4 to 20 mA, 0 to 20 mA]. – Set H3-10 = 0 [Terminal A2 Function Selection = Frequency Reference].
	19	<p>Make sure that the frequency reference gets to the necessary minimum and maximum values. If drive operation is incorrect, make these adjustments:</p> <ul style="list-style-type: none"> • Gain Adjustment Set the maximum voltage and current values, then adjust the analog input gain until the frequency reference is at the necessary value. <ul style="list-style-type: none"> – For terminal A1 input: H3-03 – For terminal A2 input: H3-11 • Bias adjustment Set the maximum voltage and current values, then adjust the analog input gain until the frequency reference is at the necessary value. <ul style="list-style-type: none"> – For terminal A1 input: H3-04 – For terminal A2 input: H3-12

Mechanical Installation

This chapter gives information about the correct environment and clearances to install the drive.

4.1	Section Safety	490
4.2	Removing/Reattaching Covers	491
4.3	Remove and Reattach the Keypad.....	493

4.1 Section Safety

WARNING

Electrical Shock Hazard

Only let approved personnel install, wire, maintain, examine, replace parts, and repair the drive.

If personnel are not approved, it can cause serious injury or death.

Do not modify the drive body or drive circuitry.

Modifications to drive body and circuitry can cause serious injury or death, will cause damage to the drive, and will void the warranty. Yaskawa is not responsible for modifications of the product made by the user.

Fire Hazard

Do not put flammable or combustible materials on top of the drive and do not install the drive near flammable or combustible materials. Attach the drive to metal or other noncombustible material.

Flammable and combustible materials can start a fire and cause serious injury or death.

When you install the drive in an enclosure, use a cooling fan or cooler to decrease the temperature around the drive. Make sure that the intake air temperature to the drive is 50 °C (122 °F) or less for IP20/UL Open Type drives, and 40 °C (104 °F) or less for IP20/UL Type 1 drives.

If the air temperature is too hot, the drive can become too hot and cause a fire and serious injury or death.

CAUTION

Crush Hazard

Tighten terminal cover screws and hold the case safely when you move the drive.

If the drive or covers fall, it can cause moderate injury.

NOTICE

Do not let unwanted objects, for example metal shavings or wire clippings, fall into the drive during drive installation. Put a temporary cover over the drive during installation. Remove the temporary cover before start-up.

Unwanted objects inside of the drive can cause damage to the drive.

Damage to Equipment

When you touch the drive and circuit boards, make sure that you observe correct electrostatic discharge (ESD) procedures.

If you do not follow procedures, it can cause ESD damage to the drive circuitry.

Install vibration-proof rubber on the base of the motor or use the frequency jump function in the drive to prevent specific frequencies that vibrate the motor.

Motor or system resonant vibration can occur in fixed speed machines that are converted to variable speed. Too much vibration can cause damage to equipment.

You can use the drive with an explosion-proof motor, but the drive is not explosion-proof. Install the drive only in the environment shown on the nameplate.

If you install the drive in a dangerous environment, it can cause damage to the drive.

Do not lift the drive with the covers removed.

If the drive does not have covers, you can easily cause damage to the internal parts of the drive.

4.2 Removing/Reattaching Covers

DANGER! Electrical Shock Hazard. Do not examine, connect, or disconnect wiring on an energized drive. Before servicing, disconnect all power to the equipment and wait for the time specified on the warning label at a minimum. The internal capacitor stays charged after the drive is de-energized. The charge indicator LED extinguishes when the DC bus voltage decreases below 50 Vdc. When all indicators are OFF, measure for dangerous voltages to make sure that the drive is safe. If you do work on the drive when it is energized, it will cause serious injury or death from electrical shock.

◆ Remove the Front Cover

1. Use a slotted screwdriver to unlock the front cover of the drive.
Use a slotted screwdriver with a tip width of 2.5 mm (0.1 in) or less and a thickness of 0.4 mm (0.02 in) or less.

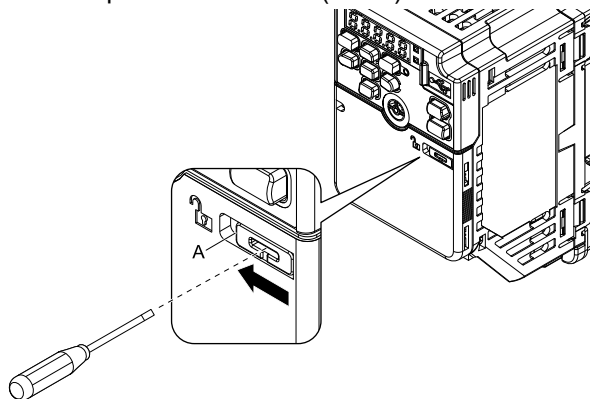

A - Front cover lock

Figure 4.1 Unlocking

2. Pull down, then pull away from the drive to remove the front cover.

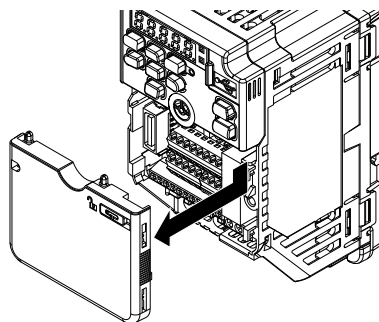

Figure 4.2 Remove the Front Cover

◆ Reattach the Front Cover

1. Reverse the steps to reattach the cover.

Note:

Make sure that you do not pinch wires or signal lines between the front cover and the drive before you reattach the cover.

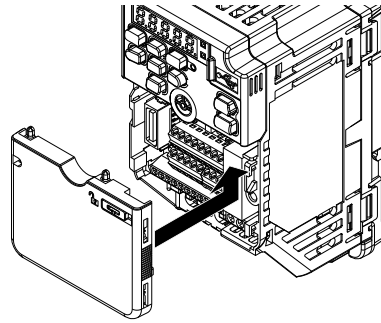
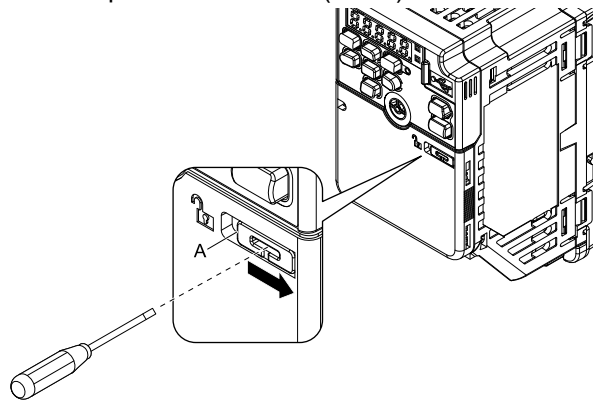

Figure 4.3 Reattach the Front Cover

2. Use a slotted screwdriver to lock the front cover of the drive.
Use a slotted screwdriver with a tip width of 2.5 mm (0.1 in) or less and a thickness of 0.4 mm (0.02 in) or less.



A - Front cover lock

Figure 4.4 Locking the Front Cover

4.3 Remove and Reattach the Keypad

◆ Remove the Keypad

Remove the front cover.

Push on the tab on the right side of the keypad, then pull the keypad forward to remove it from the drive.

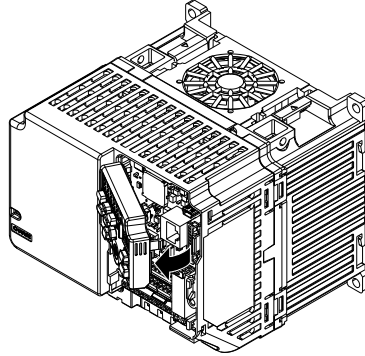

Figure 4.5 Remove the Keypad

◆ Reattach the Keypad

Push in the keypad from the front until the hooks click into place.

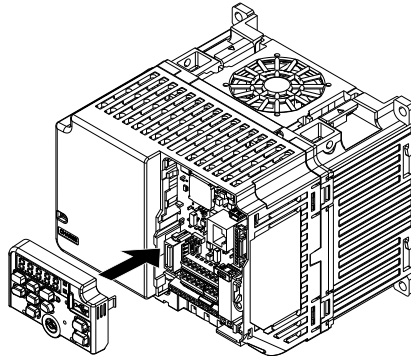

Figure 4.6 Reattach the Keypad

Attach the front cover.

Electrical Installation

This chapter gives how to wire the control circuit terminals, motor, and power supply of the drive.

5.1	Section Safety	496
5.2	Standard Connection Diagram	499
5.3	Control Circuit Wiring	502
5.4	Control I/O Connections	508
5.5	Connect the Drive to a PC	511

5.1 Section Safety

⚠ DANGER

Electrical Shock Hazard

Do not examine, connect, or disconnect wiring on an energized drive. Before servicing, disconnect all power to the equipment and wait for the time specified on the warning label at a minimum. The internal capacitor stays charged after the drive is de-energized. The charge indicator LED extinguishes when the DC bus voltage decreases below 50 Vdc. When all indicators are OFF, measure for dangerous voltages to make sure that the drive is safe.

If you do work on the drive when it is energized, it will cause serious injury or death from electrical shock.

⚠ WARNING

Electrical Shock Hazard

Do not operate the drive when covers are missing. Replace covers and shields before you operate the drive. Use the drive only as specified by the instructions.

Some figures in this section include drives without covers or safety shields to more clearly show the inside of the drive. If covers or safety shields are missing from the drive, it can cause serious injury or death.

Ground the neutral point on the power supply of drive models BxxxE, 2xxxE, and 4xxxE to comply with the EMC Directive before you turn on the EMC filter or if there is high resistance grounding.

If you turn ON the EMC filter, but you do not ground the neutral point, it can cause serious injury or death.

Make sure that the protective ground wire complies with technical standards and local safety regulations. The EN 61800-5-1:2007 standard specifies that you must wire the power supply to automatically de-energize when the protective ground wire disconnects. If you turn on the internal EMC filter, the leakage current of the drive will be more than 3.5 mA. Use these closed-loop crimp terminals or equivalent to connect a protective ground wire that has a minimum cross-sectional area of 10 mm² (copper wire).

- 8-4NS from JST Mfg. Co., Ltd.
- R8-4S from NICHIFU Co., Ltd.
- P10-8R from PANDUIT Corp.

If you do not obey the standards and regulations, it can cause serious injury or death.

When there is a DC component in the protective earthing conductor, the drive can cause a residual current. When a residual current operated protective or monitoring device prevents direct or indirect contact, always use a type B Ground Fault Circuit Interrupter (GFCI) as specified by IEC/EN 60755.

If you do not use the correct GFCI, it can cause serious injury or death.

Do not wear loose clothing or jewelry when you do work on the drive. Tighten loose clothing and remove all metal objects, for example watches or rings.

Loose clothing can catch on the drive and jewelry can conduct electricity and cause serious injury or death.

Do not remove covers or touch circuit boards while the drive is energized.

If you touch the internal components of an energized drive, it can cause serious injury or death.

Only let approved personnel install, wire, maintain, examine, replace parts, and repair the drive.

If personnel are not approved, it can cause serious injury or death.

Do not modify the drive body or drive circuitry.

Modifications to drive body and circuitry can cause serious injury or death, will cause damage to the drive, and will void the warranty. Yaskawa is not responsible for modifications of the product made by the user.

Fire Hazard

Tighten all terminal screws to the correct tightening torque.

Connections that are too loose or too tight can cause incorrect operation and damage to the drive. Incorrect connections can also cause death or serious injury from fire.

⚠ WARNING

Tighten screws at an angle in the specified range shown in this manual.

If you tighten the screws at an angle not in the specified range, you can have loose connections that can cause damage to the terminal block or start a fire and cause serious injury or death.

Damage to Equipment

Do not apply incorrect voltage to the main circuit of the drive. Operate the drive in the specified range of the input voltage on the drive nameplate.

Voltages that are higher than the permitted nameplate tolerance can cause damage to the drive.

Fire Hazard

When you install a dynamic braking option, wire the components as specified by the wiring diagrams.

Incorrect wiring can cause damage to braking components or serious injury or death.

NOTICE

Do not let unwanted objects, for example metal shavings or wire clippings, fall into the drive during drive installation. Put a temporary cover over the drive during installation. Remove the temporary cover before start-up.

Unwanted objects inside of the drive can cause damage to the drive.

Damage to Equipment

When you touch the drive and circuit boards, make sure that you observe correct electrostatic discharge (ESD) procedures.

If you do not follow procedures, it can cause ESD damage to the drive circuitry.

Select a motor that is compatible with the load torque and speed range. When 100% continuous torque is necessary at low speed, use an inverter-duty motor or vector-duty motor. When you use a standard fan-cooled motor, decrease the motor torque in the low-speed range.

If you operate a standard fan-cooled motor at low speed and high torque, it will decrease the cooling effects and can cause heat damage.

Obey the speed range specification of the motor as specified by the manufacturer. When you must operate the motor outside of its specifications, contact the motor manufacturer.

If you continuously operate oil-lubricated motors outside of the manufacturer specifications, it can cause damage to the motor bearings.

When the input voltage is 440 V or higher or the wiring distance is longer than 100 m (328 ft), make sure that the motor insulation voltage is sufficient or use an inverter-duty motor or vector-duty motor with reinforced insulation.

Motor winding and insulation failure can occur.

Before you connect a dynamic braking option to the drive, make sure that qualified personnel read and obey the Braking Unit and Braking Resistor Unit Installation Manual (TOBPC7206001).

If you do not read and obey the manual or if personnel are not qualified, it can cause damage to the drive and braking circuit.

Make sure that all connections are correct after you install the drive and connect peripheral devices.

Incorrect connections can cause damage to the drive.

Note:

- Torque characteristics are different than when you operate the motor directly from line power. Make sure that you understand the load torque characteristics for the application.
- The rated input current of submersible motors is higher than the rated input current of standard motors. Carefully select the correct drive capacity. When the distance between the motor and drive is long, use a wire that can connect the motor to the drive without a reduction in motor torque.
- Do not use unshielded wire for control wiring. Use shielded, twisted-pair wires and ground the shield to the ground terminal of the drive. Unshielded wire can cause electrical interference and unsatisfactory system performance.

5.2 Standard Connection Diagram

Wire the drive as specified by [Figure 5.1](#).

WARNING! Sudden Movement Hazard. Set the MFDI parameters before you close control circuit switches. Incorrect Run/Stop circuit sequence settings can cause serious injury or death from moving equipment.

WARNING! Sudden Movement Hazard. Correctly wire the start/stop and safety circuits before you energize the drive. If you momentarily close a digital input terminal, it can start a drive that is programmed for 3-Wire control and cause serious injury or death from moving equipment.

WARNING! Sudden Movement Hazard. When you use a 3-Wire sequence, set A1-03 = 3330 [Initialize Parameters = 3-Wire Initialization] and make sure that b1-17 = 0 [Run Command at Power Up = Disregard Existing RUN Command] (default). If you do not correctly set the drive parameters for 3-Wire operation before you energize the drive, the motor can suddenly rotate when you energize the drive.

WARNING! Sudden Movement Hazard. Check the I/O signals and the external sequences for the drive before you set the Application Preset function. When you set the Application Preset function (A1-06 \neq 0), it changes the I/O terminal functions for the drive and it can cause equipment to operate unusually. This can cause serious injury or death.

NOTICE: Fire Hazard. Install sufficient branch circuit short circuit protection as specified by applicable codes and this manual. The drive is suitable for circuits that supply not more than 31,000 RMS symmetrical amperes, 240 Vac maximum (200 V Class), 480 Vac maximum (400 V Class). Incorrect branch circuit short circuit protection can cause serious injury or death.

NOTICE: When the input voltage is 440 V or higher or the wiring distance is longer than 100 m (328 ft), make sure that the motor insulation voltage is sufficient or use an inverter-duty motor or vector-duty motor with reinforced insulation. Motor winding and insulation failure can occur.

Note:

Do not connect the AC control circuit ground to the drive enclosure. Failure to obey can cause incorrect control circuit operation.

5.2 Standard Connection Diagram

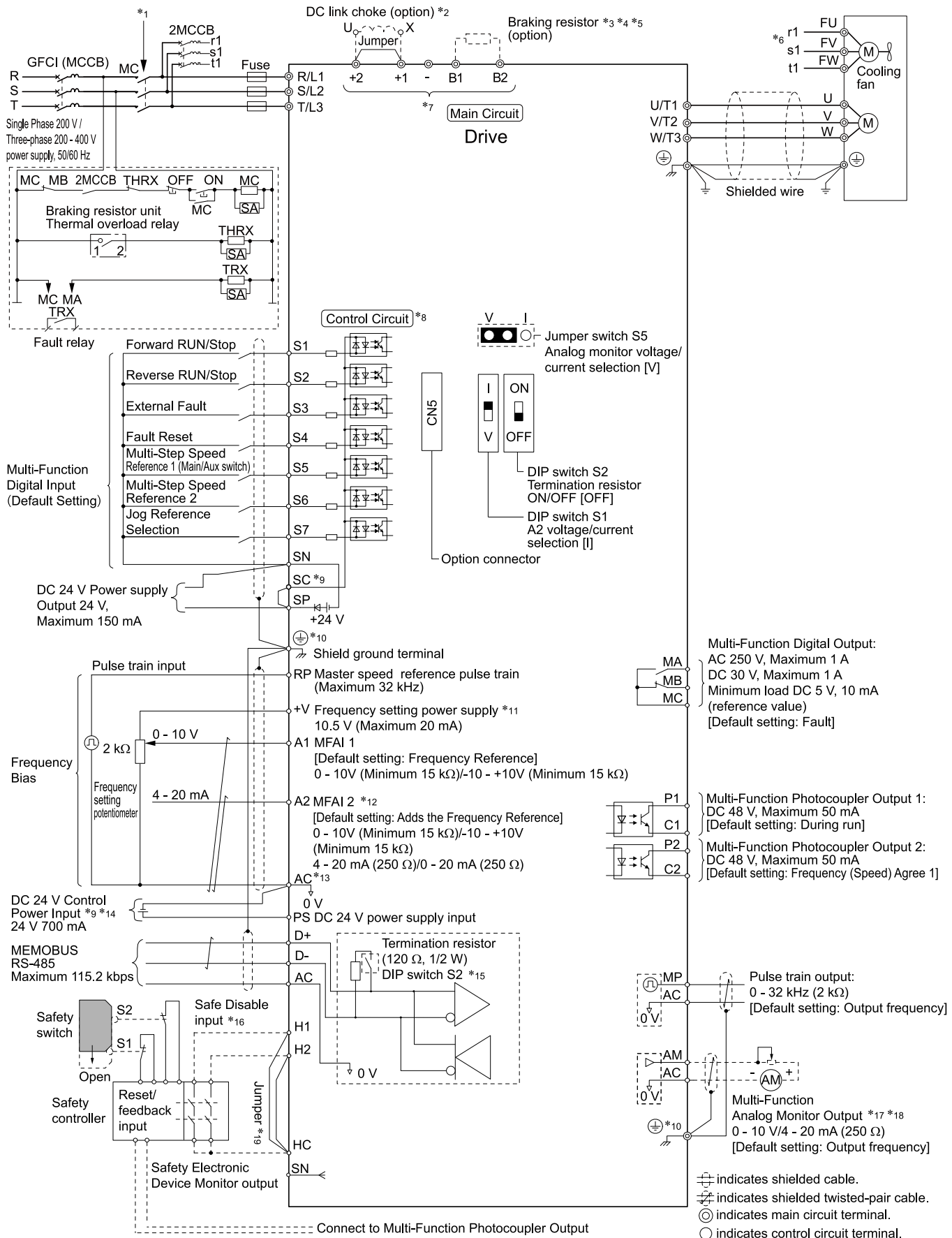

Figure 5.1 Standard Drive Connection Diagram

- *1 Set the wiring sequence to de-energize the drive with the MFDO. If the drive outputs a fault during fault restart when you use the fault restart function, set $L5-02 = 1$ [*Fault Contact at Restart Select = Always Active*] to de-energize the drive. Be careful when you use a cut-off sequence. The default setting for $L5-02$ is 0 [*Active Only when Not Restarting*].
 - *2 When you install a DC link choke, you must remove the jumper between terminals +1 and +2.
 - *3 When you use a regenerative converter or regenerative unit, set $L8-55 = 0$ [*Internal DB Transistor Protection = Disable*]. If $L8-55 = 1$ [*Protection Enabled*], the drive will detect rF [*Braking Resistor Fault*].
 - *4 When you use a regenerative converter, regenerative unit, braking resistor, or braking resistor unit, set $L3-04 = 0$ [*Stall Prevention during Decel = Disabled*]. If $L3-04 = 1$ [*General Purpose*], the drive could possibly not stop in the specified deceleration time.
 - *5 When you use an ERF-type braking resistor, set $L8-01 = 1$ [*3% ERF DB Resistor Protection = Enabled*] and set a wiring sequence to de-energize the drive with the MFDO.
 - *6 Cooling fan wiring is not necessary for self-cooling motors.
 - *7 Connect peripheral options to terminals -, +1, +2, B1, and B2.
- WARNING! Fire Hazard.** Only connect factory-recommended devices or circuits to drive terminals B1, B2, -, +1, and +2. Do not connect an AC power supply lines to these terminals. Incorrect wiring can cause damage to the drive and serious injury or death from fire.
- *8 Connect a 24 V power supply to terminals PS-AC to operate the control circuit while the main circuit power supply is OFF.
 - *9 To set the MFDI power supply (Sinking/Sourcing Mode or internal/external power supply), install or remove a jumper between terminals SC-SP or SC-SN depending on the application.
- NOTICE: Damage to Equipment.** Do not close the circuit between terminals SP-SN. If you close the circuits between terminals SC-SP and terminals SC-SN at the same time, it will cause damage to the drive.
- Sinking Mode, Internal power supply: Install the jumper to close the circuit between terminals SC-SP.
NOTICE: Damage to Equipment. Do not close the circuit between terminals SC-SN. If you close the circuits between terminals SC-SP and terminals SC-SN at the same time, it will cause damage to the drive.
 - Sourcing Mode, Internal power supply: Install the jumper to close the circuit between terminals SC-SN.
NOTICE: Damage to Equipment. Do not close the circuit between terminals SC-SP. If you close the circuits between terminals SC-SP and terminals SC-SN at the same time, it will cause damage to the drive.
 - External power supply: Remove the jumper from the MFDI terminals. It is not necessary to close the circuit between terminals SC-SP and terminals SC-SN.
- *10 **WARNING! Electrical Shock Hazard.** When you connect the shield wire of the control circuit wiring to the protective ground terminal, do not connect the protective ground wire. If you connect the shield wire and the protective ground wire to the protective grounding terminal, it may not comply with the technical standards and local safety regulations and can cause serious injury or death.
 - *11 The maximum output current capacity for terminal +V on the control circuit is 20 mA.
NOTICE: Damage to Equipment. Do not install a jumper between terminals +V and AC. A closed circuit between these terminals will cause damage to the drive.
 - *12 DIP switch S1 sets terminal A2 for voltage or current input. The default setting for S1 is current input (“I” side).
 - *13 Do not ground the control circuit terminals AC or connect them to the drive chassis.
NOTICE: Do not ground the AC control circuit terminals and only connect the AC terminals as specified by the product instructions. If you connect the AC terminals incorrectly, it can cause damage to the drive.
 - *14 Connect the positive lead from an external 24 Vdc power supply to terminal PS and the negative lead to terminal AC.
NOTICE: Connect terminals PS and AC correctly for the 24 V power supply. If you connect the wires to the incorrect terminals, it will cause damage to the drive.
 - *15 Set DIP switch S2 to “ON” to enable the termination resistor in the last drive in a MEMOBUS/Modbus network.
 - *16 Use only Sourcing Mode for Safe Disable input.
 - *17 Use multi-function analog monitor outputs with analog frequency meters, ammeters, voltmeters, and wattmeters. Do not use monitor outputs with feedback-type signal devices.
 - *18 Jumper S5 sets terminal AM for voltage or current output. The default setting for S5 is voltage output (“V” side).
 - *19 Disconnect the wire jumpers between H1 and HC and H2 and HC to use the Safe Disable input.

5.3 Control Circuit Wiring

This section gives information about how to correctly wire the control circuit.

◆ Control Circuit Connection Diagram

Wire the drive control circuit as shown in Figure 5.2.

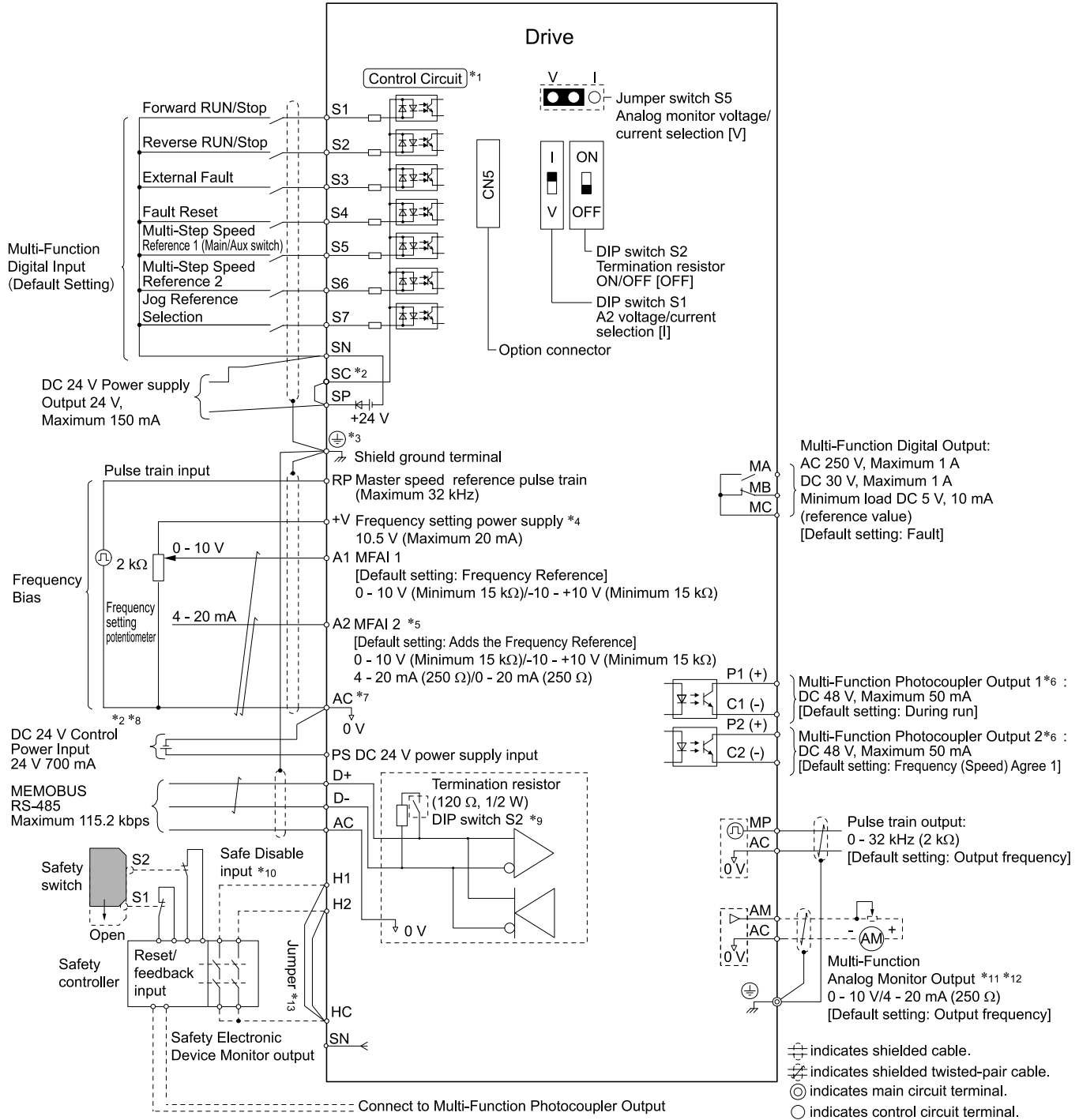

Figure 5.2 Control Circuit Connection Diagram

*1 Connect a 24 V power supply to terminals PS-AC to operate the control circuit while the main circuit power supply is OFF.

- *2 To set the MFDI power supply (Sinking/Sourcing Mode or internal/external power supply), install or remove a jumper between terminals SC-SP or SC-SN depending on the application.
- NOTICE: Damage to Equipment.** Do not close the circuit between terminals SP-SN. If you close the circuits between terminals SC-SP and terminals SC-SN at the same time, it will cause damage to the drive.
- Sinking Mode, Internal power supply: Install the jumper to close the circuit between terminals SC-SP.
NOTICE: Damage to Equipment. Do not close the circuit between terminals SC-SN. If you close the circuits between terminals SC-SP and terminals SC-SN at the same time, it will cause damage to the drive.
 - Sourcing Mode, Internal power supply: Install the jumper to close the circuit between terminals SC-SN.
NOTICE: Damage to Equipment. Do not close the circuit between terminals SC-SP. If you close the circuits between terminals SC-SP and terminals SC-SN at the same time, it will cause damage to the drive.
 - External power supply: Remove the jumper from the MFDI terminals. It is not necessary to close the circuit between terminals SC-SP and terminals SC-SN.
- *3 **WARNING! Electrical Shock Hazard.** When you connect the shield wire of the control circuit wiring to the protective ground terminal, do not connect the protective ground wire. If you connect the shield wire and the protective ground wire to the protective grounding terminal, it may not comply with the technical standards and local safety regulations and can cause serious injury or death.
- *4 The maximum output current capacity for terminal +V on the control circuit is 20 mA.
- NOTICE: Damage to Equipment.** Do not install a jumper between terminals +V and AC. A closed circuit between these terminals will cause damage to the drive.
- *5 DIP switch S1 sets terminal A2 for voltage or current input. The default setting for S1 is current input (“I” side).
- *6 Do not ground the control circuit terminals AC or connect them to the drive chassis.
- NOTICE: Do not ground the AC control circuit terminals and only connect the AC terminals as specified by the product instructions. If you connect the AC terminals incorrectly, it can cause damage to the drive.**
- *7 Do not connect terminals PS and AC inversely. If you connect the wires to the incorrect terminals, it will cause damage to the drive.
- *8 Set DIP switch S2 to the ON position to enable the termination resistor in the last drive when you use MEMOBUS/Modbus communications.
- *9 To use the internal power supply with the Safe Disable input, use sourcing mode.
- *10 Use multi-function analog monitor outputs with analog frequency meters, ammeters, voltmeters, and wattmeters. Do not use monitor outputs with feedback-type signal devices.
- *11 Jumper S5 sets terminal AM for voltage or current output. The default setting for S5 is voltage output (“V” side).
- *12 Disconnect the wire jumpers between H1 and HC and H2 and HC to use the Safe Disable input.

◆ Control Circuit Terminal Block Functions

Hx-xx parameters set functions for the multi-function input and output terminals.

WARNING! Sudden Movement Hazard. Correctly wire and test all control circuits to make sure that the control circuits operate correctly. If you use a drive that has incorrect control circuit wiring or operation, it can cause death or serious injury.

WARNING! Sudden Movement Hazard. Check the I/O signals and the external sequences for the drive before you set the Application Preset function. When you set the Application Preset function (A1-06 ≠ 0), it changes the I/O terminal functions for the drive and it can cause equipment to operate unusually. This can cause serious injury or death.

NOTICE: Damage to Equipment. Do not energize and de-energize the drive more frequently than one time each 30 minutes. If you frequently energize and de-energize the drive, it can cause drive failure.

■ Input Terminals

Refer to [Table 5.1](#) for a list of input terminals and functions.

Table 5.1 Multi-function Input Terminals

Type	Terminal	Name (Default)	Function (Signal Level)	
MFDI	S1	MFDI selection 1 (ON: Forward run, OFF: Stop)	<ul style="list-style-type: none"> Photocoupler 24 V, 6 mA <p>Note: To set the MFDI power supply (Sinking/Sourcing Mode or internal/external power supply), install or remove a jumper between terminals SC-SP or SC-SN depending on the application.</p> <ul style="list-style-type: none"> Sinking Mode, Internal power supply: Install the jumper to close the circuit between terminals SC-SP. <p>NOTICE: Damage to Equipment. Do not close the circuit between terminals SC-SN. If you close the circuits between terminals SC-SP and terminals SC-SN at the same time, it will cause damage to the drive.</p> <ul style="list-style-type: none"> Sourcing Mode, Internal power supply: Install the jumper to close the circuit between terminals SC-SN. <p>NOTICE: Damage to Equipment. Do not close the circuit between terminals SC-SP. If you close the circuits between terminals SC-SP and terminals SC-SN at the same time, it will cause damage to the drive.</p> <ul style="list-style-type: none"> External power supply: Remove the jumper from the MFDI terminals. It is not necessary to close the circuit between terminals SC-SP and terminals SC-SN. 	
	S2	MFDI selection 2 (ON: Reverse run OFF: Stop)		
	S3	MFDI selection 3 (External fault (N.O.))		
	S4	MFDI selection 4 (Fault reset)		
	S5	MFDI selection 5 (Multi-step speed reference 1)		
	S6	MFDI selection 6 (Multi-step speed reference 2)		
	S7	MFDI selection 7 (Jog command)		
	SN	MFDI power supply 0 V		MFDI power supply, 24 V (maximum 150 mA)
	SC	MFDI selection common		<p>NOTICE: Damage to Equipment. Do not close the circuit between terminals SP-SN. If you close the circuits between terminals SC-SP and terminals SC-SN at the same time, it will cause damage to the drive.</p>
	SP	MFDI power supply +24 Vdc		
Safe Disable Input	H1	Safe Disable input 1	<p>Remove the jumper between terminals H1-HC and H2-HC to use the Safe Disable input.</p> <ul style="list-style-type: none"> 24 V, 6 mA ON: Normal operation OFF: Coasting motor Internal impedance 4.7 kΩ OFF Minimum OFF time of 3 ms. <p>Safe Disable function common</p> <p>NOTICE: Do not close the circuit between terminals HC and SN. A closed circuit between these terminals will cause damage to the drive.</p>	
	H2	Safe Disable input 2		
	HC	Safe Disable function common		
Master Frequency Reference	RP	Master frequency reference pulse train input (Master frequency reference)	<ul style="list-style-type: none"> Response frequency: 0 to 32 kHz H level duty: 30% to 70% H level voltage: 3.5 V to 13.2 V L level voltage: 0.0 V to 0.8 V Input impedance: 3 kΩ <p>10.5 V (allowable current 20 mA maximum)</p> <p>Voltage input Use H3-01 [Terminal A1 Signal Level Select] to select the signal level.</p> <ul style="list-style-type: none"> 0 V to 10 V/ 100% (input impedance: minimum 15 kΩ) -10 V to +10 V/-100% to +100% (input impedance: minimum 15 kΩ) <p>Voltage input or current input Use DIP switch S1 and H3-09 [Terminal A2 Signal Level Select] to select the input.</p> <ul style="list-style-type: none"> 0 V to 10 V/ 100% (input impedance: minimum 15 kΩ) -10 V to +10 V/-100% to +100% (input impedance: minimum 15 kΩ) 4 mA to 20 mA/100%, 0 mA to 20 mA/100% (input impedance: 250 Ω) <p>0 V</p>	
	+V	Power supply for frequency setting		
	A1	MFAI1 (Master frequency reference)		
	A2	MFAI2 (Combined to terminal A1)		
	AC	Frequency reference common		

■ Output Terminals

Refer to Table 5.2 and Table 5.3 for a list of Output terminals and functions.

Table 5.2 Control Circuit Output Terminals

Type	Terminal	Name (Default)	Function (Signal Level)
Digital Outputs	MA	N.O. output (Fault)	<ul style="list-style-type: none"> Relay output 30 Vdc, 10 mA to 1 A 250 Vac, 10 mA to 1 A Minimum load: 5 V, 10 mA (Reference value)
	MB	N.C. output (Fault)	
	MC	Digital output common	
Multi-function Photocoupler Outputs	P1	Multi-function photocoupler output 1 (During RUN)	<ul style="list-style-type: none"> Photocoupler output 48 V, 2 mA to 50 mA
	C1		
	P2	Multi-function photocoupler output 2 (Speed agree 1)	
	C2		

Table 5.3 Control Circuit Monitor Output Terminals

Type	Terminal	Name (Default)	Function (Signal Level)
Monitor Output	MP	Pulse train output (Output frequency)	32 kHz (maximum) Refer to "Pulse Train Output" (page 508) for more information.
	AM	Analog monitor output (Output frequency)	Select voltage or current output. <ul style="list-style-type: none"> 0 V to 10 V/0% to 100% 4 mA to 20 mA (Receiver recommended impedance: 250 Ω) Note: Use jumper S5 and H4-07 [Terminal AM Signal Level Select] to set the signal type.
	AC	Monitor common	0 V

External Power Supply Input Terminals

Refer to Table 5.4 for a list of the functions of the external power supply input terminals.

Table 5.4 External Power Supply Input Terminals

Type	Terminal	Name (Default)	Function
External Power Supply Input Terminals	PS	External 24 V power supply input	Supplies backup power to the drive control circuit, keypad, and option board. 21.6 VDC to 26.4 VDC, 700 mA
	AC	External 24 V power supply ground	0 V

Alarm Display When You Use External 24 V Power Supply

When you use an external 24 V power supply, the drive detects an alarm as shown in Table 5.5 if you set o2-23 [External 24V Powerloss Detection] and o2-26 [Alarm Display at Ext. 24V Power] for the main circuit power supply. Set the alarm display as necessary.

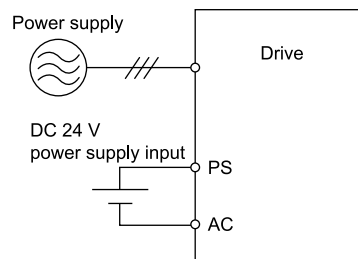

Table 5.5 Power Supply and Alarm Display

Main Circuit Power Supply	External 24 V Power Supply	o2-23 [External 24V Powerloss Detection]	o2-26 [Alarm Display at Ext. 24V Power]	Alarm Display
ON	ON	-	-	-
ON	OFF	0 [Disabled]	-	-
		1 [Enabled]	-	L24v [Loss of External Power 24 Supply]

5.3 Control Circuit Wiring

Main Circuit Power Supply	External 24 V Power Supply	o2-23 [External 24V Powerloss Detection]	o2-26 [Alarm Display at Ext. 24V Power]	Alarm Display
OFF	ON	-	0 [Disabled]	"Ready" LED light flashes quickly
		-	1 [Enabled]	EP24v [External Power 24V Supply]

Serial Communication Terminals

Refer to [Table 5.6](#) for a list of serial communication terminals and functions.

Table 5.6 Serial Communication Terminals

Type	Terminal	Terminal Name	Function (Signal Level)	
Modbus Communication	D+	Communication input/output (+)	MEMOBUS/Modbus communications Use an RS-485 cable to connect the drive. Note: Set DIP switch S2 to ON to enable the termination resistor in the last drive in a MEMOBUS/Modbus network.	<ul style="list-style-type: none"> • RS-485 • MEMOBUS/Modbus communication protocol • Maximum 115.2 kbps
	D-	Communication output (-)		
	AC	Shield ground	0 V	

Control Circuit Terminal Configuration

The control circuit terminals are in the positions shown in [Figure 5.3](#).

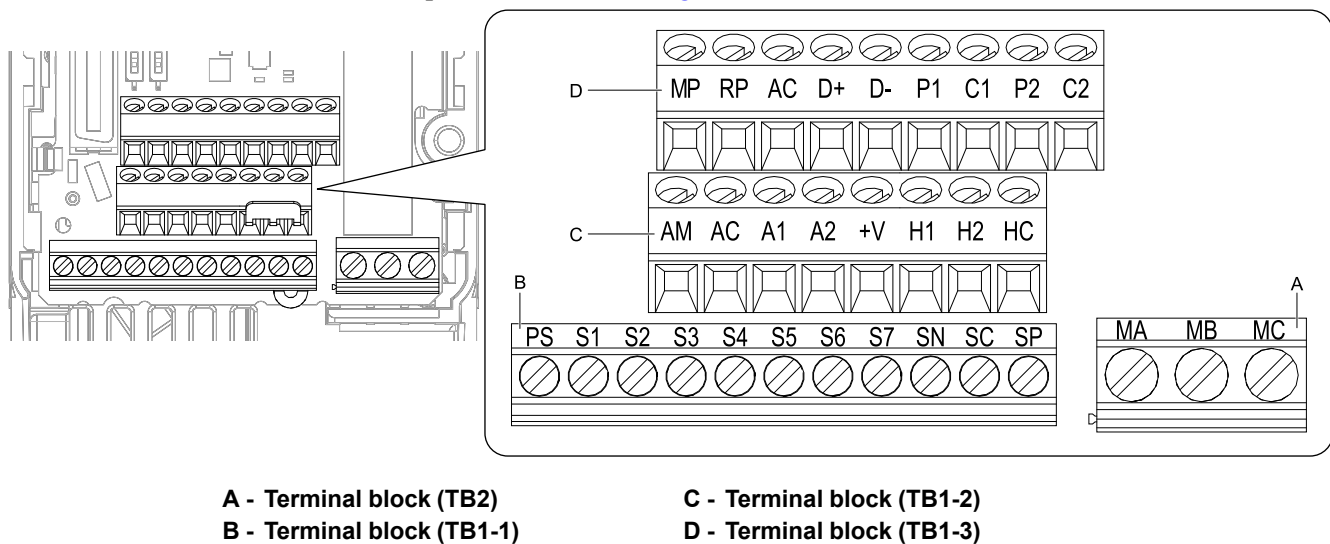

Figure 5.3 Control Circuit Terminal Arrangement

Switches and Jumpers on the Terminal Board

The terminal board has switches to adapt the drive I/Os to the external control signals as shown in [Figure 5.4](#). Set the switches to select the functions for each terminal.

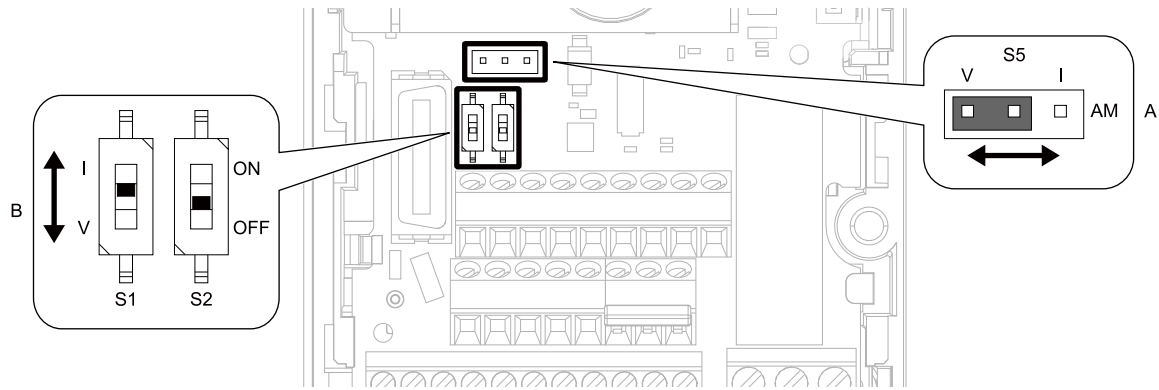

Figure 5.4 Locations of Switches

Table 5.7 I/O Terminals and Switches Functions

Position	Switch	Terminal	Function	Default
A	Jumper switch S5	AM	Sets the output method for terminal AM (voltage or current).	V (voltage output)
B	DIP switch S1	A2	Sets the input method for terminal A2 (voltage or current).	I (current input)
	DIP switch S2	-	Enables and disables the MEMOBUS/Modbus communications termination resistor.	OFF

5.4 Control I/O Connections

This section gives information about the settings for the listed control circuit I/O signals.

- MFDI (terminals S1 to S7)
- Pulse train output (terminal MP)
- MFAI (terminal A2)
- MFAO (terminal AM)
- MEMOBUS/Modbus communications (terminals D+, D-, AC)

◆ Pulse Train Output

You can use pulse train monitor output terminal MP for sourcing mode or for sinking mode.

NOTICE: Correctly connect peripheral devices. Incorrect installation can cause damage to the drive and connected circuits.

- Use for sourcing mode
The load impedance changes the voltage level of the pulse train output signal.

Load Impedance $R_L(k\Omega)$	Output Voltage $V_{MP}(V)$
1.5 k Ω or more	5 V or more
4.0 k Ω or more	8 V or more
10 k Ω or more	10 V or more

Note:

Use the formula in Figure 5.5 to calculate the necessary load resistance (k Ω) to increase output voltage $V_{MP}(V)$.

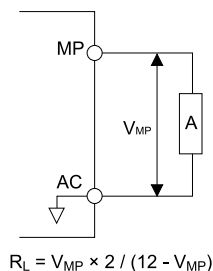

A - Load Impedance

Figure 5.5 Wiring to Use Pulse Train Output in Sourcing Mode

- Use in sinking mode
The external power supply changes the voltage level of the pulse train output signal. Keep the voltage from an external source between 10.8 Vdc to 16.5 Vdc. Adjust the load impedance to keep the current at 16 mA or lower.

External Power Supply (V)	Load Impedance (k Ω)	Sinking current (mA)
10.8 Vdc to 16.5 Vdc	1.0 k Ω or more	16 mA maximum

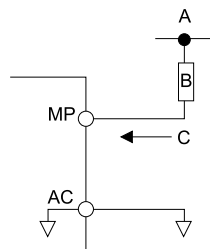

A - External power supply
B - Load Impedance

C - Sinking current

Figure 5.6 Wiring to Use Pulse Train Output in Sinking Mode

◆ Set Sinking Mode/Sourcing Mode

Close the circuit between terminals SC-SP and SC-SN to set the sinking mode/sourcing mode and the internal/external power supply for the MFDI terminals. The default setting for the drive is internal power supply sinking mode.

NOTICE: Damage to Equipment. Do not close the circuit between terminals SP-SN. If you close the circuits between terminals SC-SP and terminals SC-SN at the same time, it will cause damage to the drive.

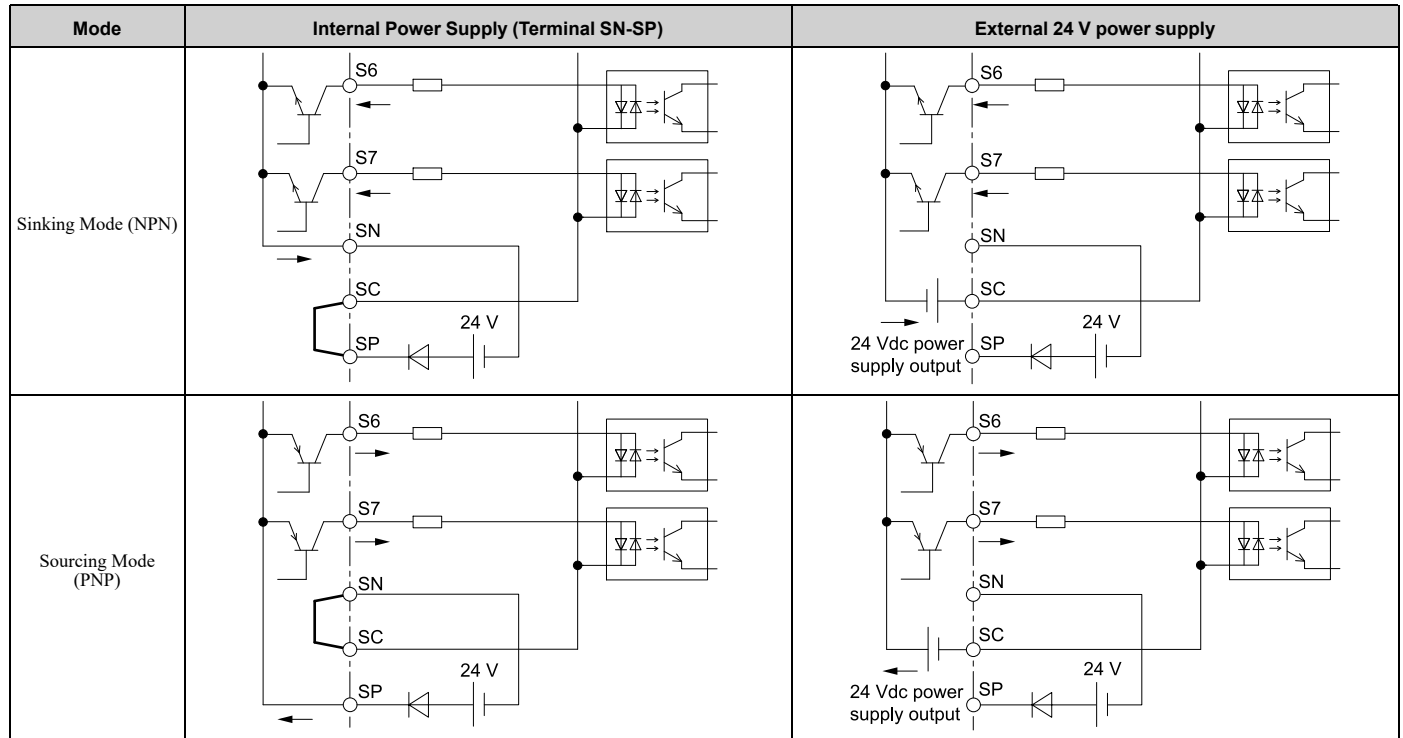

◆ Set the Input Signal for the MFAI Terminal A2

Use terminal A2 to input a voltage or a current signal. Set the signal type as shown in [Table 5.8](#).

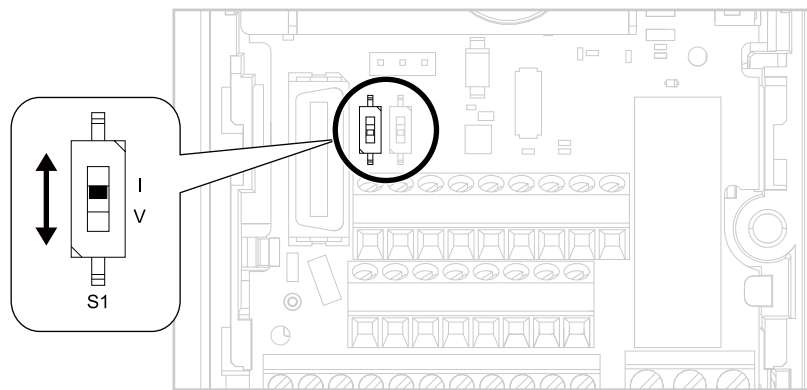

Figure 5.7 Location of DIP Switch S1

Table 5.8 MFAI Terminal A2 Signal Settings

Terminal	Input Signal	DIP Switch Settings		Parameter	
		Switch	Setting	No.	Signal Level
A2	Current input	S1	I (Default)	H3-09	2: 4 mA to 20 mA/0% to 100% (input impedance: 250 Ω) 3: 0 mA to 20 mA/0% to 100% (input impedance: 250 Ω)
	Voltage input		V		0: 0 V to 10 V/0% to 100% (with zero limit) (input impedance: minimum 15 kΩ) 4: -10 V to +10 V/-100% to 100% (input impedance: minimum 15 kΩ)

Note:

Use tweezers or a jig with a tip width of approximately 0.8 mm (0.03 in) to set DIP switches.

◆ **Set the Output Signal for the MFAO Terminal AM**

Set the signal type for terminal AM to voltage or current output. Use jumper S5 and H4-07 [Terminal AM Signal Level Select] to set the signal type.

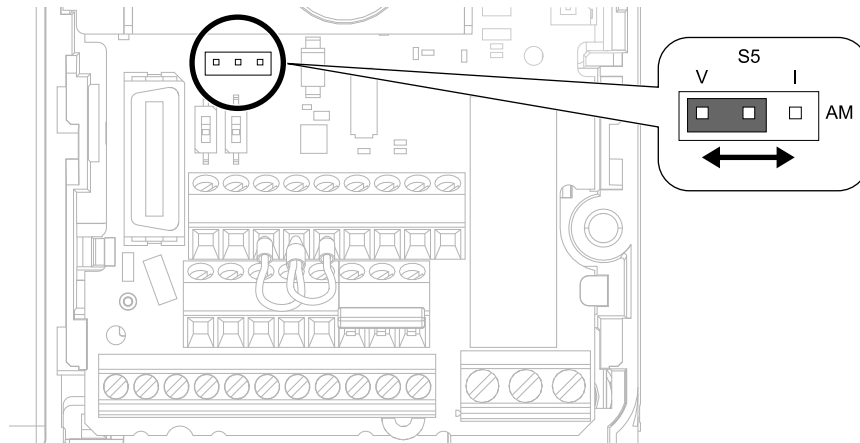
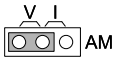
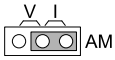

Figure 5.8 Location of Jumper Switch S5

Terminal	Types of Output Signals	Jumper S5	Parameter	
			No.	Signal Level
AM	Voltage output (Default)	 AM	H4-07	0: 0 V to 10 V
	Current output	 AM		2: 4 mA to 20 mA

◆ **Switch ON Termination Resistor for MEMOBUS/Modbus Communications**

When the drive is the last slave in a MEMOBUS/Modbus communications, set DIP switch S2 to the ON position. This drive has a built-in termination resistor for the RS-485 interface.

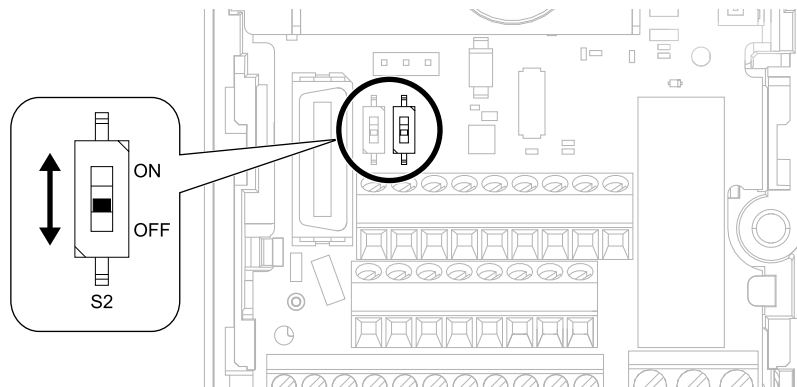

Figure 5.9 Location of DIP Switch S2

Table 5.9 MEMOBUS/Modbus Communications Termination Resistor Setting

DIP switch S2	Description
ON	The built-in termination resistor is ON.
OFF (Default)	The built-in termination resistor is OFF.

5.5 Connect the Drive to a PC

The drive has a mini-B type USB port.

You can use a USB cable (USB 2.0, type: A - mini-B) to connect the drive to a type-A USB port on a PC. After you connect the drive to the PC, you can use Yaskawa DriveWizard software to monitor drive performance and manage parameter settings.

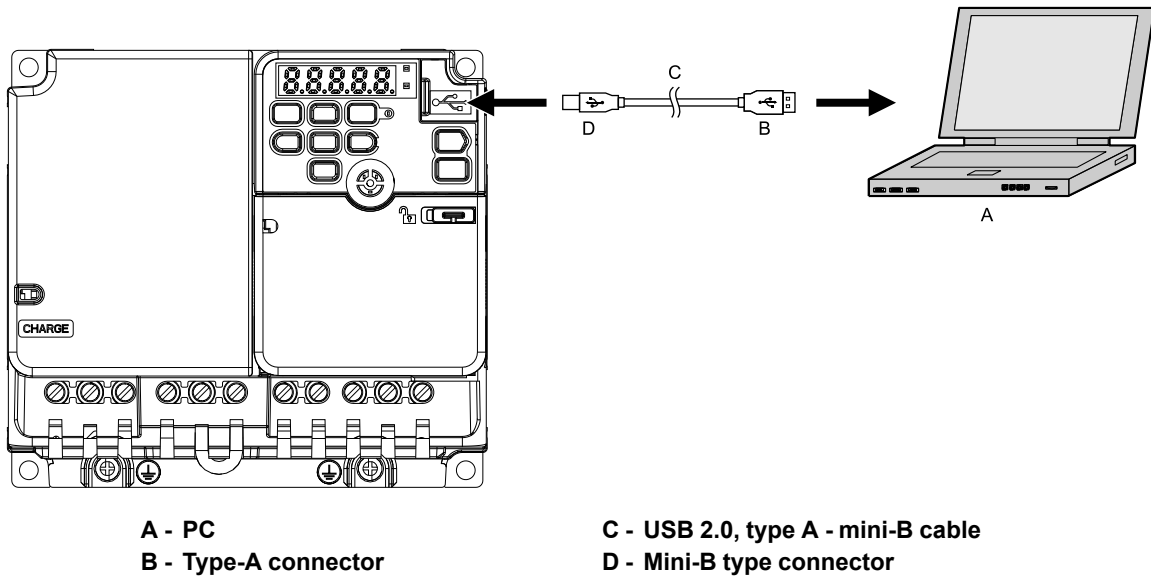

Figure 5.10 Connect to a PC (USB)

Yaskawa recommends that you use a USB cable with connectors connected with shielded wires.

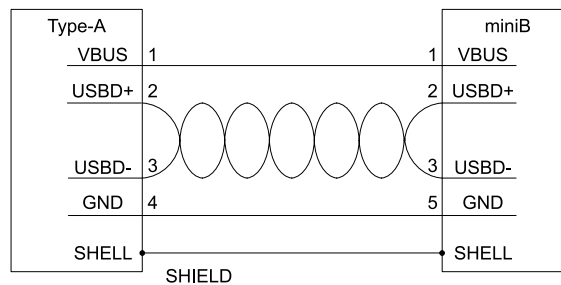

Figure 5.11 Recommended USB Cable

Preface and General Precautions

This chapter gives information about important safety precautions for the use of this product. Failure to obey these precautions can cause serious injury or death, or damage to the product or related devices and systems. Yaskawa must not be held responsible for any injury or equipment damage as a result of the failure to observe these precautions and instructions.

6.1	Receiving	514
6.2	Using the Product Safely	515

6.1 Receiving

These instructions contain the information necessary to use the product correctly. Read and understand the safety information and precautions before you start to use the product.

◆ Glossary

Phrase	Definition
AOLV/PM	Advanced Open Loop Vector Control for Permanent Magnet Motors
Drive	YASKAWA AC Drive GA500
EDM	External Device Monitor
EZOLV	EZ Open Loop Vector Control
HD	Heavy Duty
IPM motor	Interior Permanent Magnet Synchronous Motor
MFAI	Multi-Function Analog Input
MFAO	Multi-Function Analog Output
MFDI	Multi-Function Digital Input
MFDO	Multi-Function Digital Output
ND	Normal Duty
OLV	Open Loop Vector Control
OLV/PM	Open Loop Vector Control for Permanent Magnet Motors
PM motor	Permanent Magnet Synchronous Motor (generic name for IPM motors and SPM motors)
SIL	Safety Integrity Level
SPM motor	Surface Permanent Magnet Synchronous Motor
V/f	V/f Control

◆ About Registered Trademarks

- CANopen is a registered trademark of CAN in Automation (CIA).
- CC-Link is a registered trademark of CC-Link Partner Association.
- DeviceNet is a registered trademark of Open DeviceNet Vendor Association, Inc. (ODVA).
- EtherCAT is a registered trademark of Beckhoff Automation GmbH.
- EtherNet/IP is a registered trademark of Open DeviceNet Vendor Association, Inc. (ODVA).
- LonWorks and LonTalk are registered trademarks of Echelon Corporation.
- MECHATROLINK-I, MECHATROLINK-II, and MECHATROLINK-III are registered trademarks of MECHATROLINK Members Association (MMA).
- Modbus is a registered trademark of Schneider Electric SA.
- PROFIBUS-DP and PROFINET are registered trademarks of PROFIBUS International.
- Other company names and product names in this document are trademarks or registered trademarks of the respective companies.

6.2 Using the Product Safely

◆ Explanation of Signal Words

WARNING! Read and understand this manual before you install, operate, or do maintenance on the drive. Install the drive as specified by this manual and local codes. The symbols in this section identify safety messages in this manual. If you do not obey these safety messages, the hazards can cause serious injury, death, or damage to the products and related equipment and systems.

These identifier words categorize and emphasize important safety precautions in these instructions.

DANGER! This signal word identifies a hazard that will cause serious injury or death if you do not prevent it.

WARNING! This signal word identifies a hazard that can cause death or serious injuries if you do not prevent it.

CAUTION! This signal word identifies a hazard that can cause minor or moderate injuries if you do not prevent it.

NOTICE: This signal word identifies a property damage message that is not related to personal injury.

◆ Section Safety

General Precautions

- Some figures in the instructions include options and drives without covers or safety shields to more clearly show the inside of the drive. Replace covers and shields before operation. Use options and drives only as specified by the instructions.
- The figures in this manual are examples only. All figures do not apply to all products included in this manual.
- Yaskawa can change the products, specifications, and content of the instructions without notice to make the product and/or the instructions better.
- If you damage or lose these instructions, contact a Yaskawa representative or the nearest Yaskawa sales office on the rear cover of the manual, and tell them the document number on the front cover to order new copies.

DANGER! Do not ignore the safety messages in this manual. If you ignore the safety messages in this manual, it will cause serious injury or death. The manufacturer is not responsible for injuries or damage to equipment.

DANGER! Electrical Shock Hazard. Do not examine, connect, or disconnect wiring on an energized drive. Before servicing, disconnect all power to the equipment and wait for the time specified on the warning label at a minimum. The internal capacitor stays charged after the drive is de-energized. The charge indicator LED extinguishes when the DC bus voltage decreases below 50 Vdc. When all indicators are OFF, measure for dangerous voltages to make sure that the drive is safe. If you do work on the drive when it is energized, it will cause serious injury or death from electrical shock.

WARNING! Crush Hazard. Test the system to make sure that the drive operates safely after you wire the drive and set parameters. If you do not test the system, it can cause damage to equipment or serious injury or death.

WARNING! Sudden Movement Hazard. Before you do a test run, make sure that the setting values for virtual input and output function parameters are correct. Virtual input and output functions can have different default settings and operation than wired input and output functions. Incorrect function settings can cause serious injury or death.

WARNING! Sudden Movement Hazard. Remove all personnel and objects from the area around the drive, motor, and machine and attach covers, couplings, shaft keys, and machine loads before you energize the drive. If personnel are too close or if there are missing parts, it can cause serious injury or death.

WARNING! Sudden Movement Hazard. Examine the I/O signals and internal sequence with the engineer who made the DriveWorksEZ program before you operate the drive. If you do not know how the drive will operate, it can cause serious injury or death. When you use DriveWorksEZ to make custom programming, the drive I/O terminal functions change from factory settings and the drive will not operate as written in this manual.

WARNING! Electrical Shock Hazard. Do not modify the drive body or drive circuitry. Modifications to drive body and circuitry can cause serious injury or death, will cause damage to the drive, and will void the warranty. Yaskawa is not responsible for modifications of the product made by the user.

WARNING! Electrical Shock Hazard. Only let approved personnel install, wire, maintain, examine, replace parts, and repair the drive. If personnel are not approved, it can cause serious injury or death.

WARNING! Electrical Shock Hazard. Do not remove covers or touch circuit boards while the drive is energized. If you touch the internal components of an energized drive, it can cause serious injury or death.

WARNING! Electrical Shock Hazard. After the drive blows a fuse or trips a GFCI, do not immediately energize the drive or operate peripheral devices. Wait for the time specified on the warning label at a minimum and make sure that all indicators are OFF. Then check the wiring and peripheral device ratings to find the cause of the problem. If you do not know the cause of the problem, contact Yaskawa before you energize the drive or peripheral devices. If you do not fix the problem before you operate the drive or peripheral devices, it can cause serious injury or death.

WARNING! Damage to Equipment. Do not apply incorrect voltage to the main circuit of the drive. Operate the drive in the specified range of the input voltage on the drive nameplate. Voltages that are higher than the permitted nameplate tolerance can cause damage to the drive.

WARNING! Fire Hazard. Install sufficient branch circuit short circuit protection as specified by applicable codes and this manual. The drive is suited for circuits that supply not more than 31,000 RMS symmetrical amperes, 240 Vac maximum (200 V Class), 480 Vac maximum (400 V Class). Incorrect branch circuit short circuit protection can cause serious injury or death.

6.2 Using the Product Safely

CAUTION! *Crush Hazard. Tighten terminal cover screws and hold the case safely when you move the drive. If the drive or covers fall, it can cause moderate injury.*

NOTICE: *Use an inverter-duty motor or vector-duty motor with reinforced insulation and windings applicable for use with an AC drive. If the motor does not have the correct insulation, it can cause a short circuit or ground fault from insulation deterioration.*

NOTICE: *Damage to Equipment. When you touch the drive and circuit boards, make sure that you observe correct electrostatic discharge (ESD) procedures. If you do not follow procedures, it can cause ESD damage to the drive circuitry.*

NOTICE: *Damage to Equipment. Do not do a withstand voltage test or use a megohmmeter or megger insulation tester on the drive. These tests can cause damage to the drive.*

NOTICE: *Do not operate a drive or connected equipment that has damaged or missing parts. You can cause damage to the drive and connected equipment.*

NOTICE: *Damage to Equipment. Do not use steam or other disinfectants to fumigate wood for packaging the drive. Use alternative methods, for example heat treatment, before you package the components. Gas from wood packaging fumigated with halogen disinfectants, for example fluorine, chlorine, bromine, iodine or DOP gas (phthalic acid ester), can cause damage to the drive.*

Index

Numerics

- 24 V power supply
Power supply input terminals 505

A

- Acceleration and deceleration times
 - Switching by external input 203
 - Switching by output frequency 204
 - Switching by Motor 2 Selection commands 204
- Acceleration time
 - Parameter 203
 - Unit of measurement setting 206
- Adjustment of control functionality 481
- AFR
 - Parameter 406
- Ambient Temperature Setting
 - Parameter 400
- Analog input
 - Function selection for terminals A1 and A2 332
- Analog Output
 - Gain/Bias Adjustment 343
 - Monitor Parameter Selection 343
 - Signal Level Selection 343
 - Terminal AM Monitor Selection 344
- Application Preset 149
 - Operation 471
- ASR
 - Fine tuning 217
 - Parameter 215
 - Vector Control Adjustment Procedure 216
- Auto-Tuning 472, 475
 - ASR and Inertia Tuning Parameters 455
 - Induction Motor 472
 - Induction Motor Parameters 449
 - PM Motor Parameters 452
 - PM motors 473
 - Precautions 476
 - Rotational Auto-Tuning Precautions 477
 - Stationary Auto-Tuning for Line-to-Line Resistance precautions 478
 - Stationary Auto-Tuning Precautions 477
 - Stator resistance Auto-Tuning precautions 478

B

- Backup
 - Parameters (drive to keypad) 468
- Backup function 439
- Base frequency
 - Parameter 248
- Base Frequency
 - Motor 2 Parameters 253
- Base voltage
 - Motor 2 parameters 254
 - Parameter 249
- Bi-Directional function 238
- Braking Resistor
 - Protection Functions 397
- bUS
 - Detection condition settings 275
 - Detection conditions 271

- Operation Selection after Detection 270

C

- Capacitor Maintenance Setting 441
- Carrier frequency 221
 - Parameter 220
- CE
 - Detection Selection 346
 - Detection time 347
 - Operation Selection after Detection 346
- Checklist
 - Test run 486
- Communication option
 - Parameter 264
- Control circuit terminals
 - Configuration of terminal block 506
 - I/O terminals function selection switches 506
 - Terminal functions 503
 - Wiring 502
- Control method
 - Selection 146
- Cooling Fan
 - Activation Conditions Setting 399
 - Off Delay Timer 400
- Cumulative Operation Time Setting 440
- Current Detection Speed Search 171

D

- DC Injection Braking
 - Parameter 167
- Deceleration time
 - Parameter 203
 - Unit of measurement setting 206
- Delete
 - Delete Backed-up Parameters 470
- Derating
 - Ambient Temperature Setting 400
 - Enclosure Type 401
 - External Cooling Fin 401
 - Finless 401
 - Side-by-side 401
- dEv
 - Detection level 264
 - Detection time 264
 - Operation Selection after Detection 263
- Digital character 466
- DIP switch 506
- Down 2 command
 - Parameter 233, 238
- Down command 294, 296
 - Parameter 233, 238
- Drive
 - Initialization 147
 - Initialize Parameters 147
 - Drive Mode Unit Monitor Select 428
 - Drive Model Selection 436
- Dwell function
 - Parameter 197

E

- E5
 - Operation Selection after Detection 274
- EF0
 - Detection conditions 271

Detection conditions setting (DeviceNet).....	277
Operation Selection after Detection.....	271
Elapsed Operating Time Selection.....	441
Enclosure Type	
Derating.....	401
Encoder option	
Parameter.....	262
Energy-saving control	
Parameter.....	198
ERF type braking resistor	
Protection Functions.....	397
External 24 V power supply	
Power supply input terminals.....	505
External Cooling Fin	
Derating.....	401
F	
Fan Operation Time Setting.....	441
Fast Stop Time	
Parameter.....	206
Fault Restart	
Parameter.....	386
Feed Forward Control	
Parameter.....	411
Field Forcing	
Parameter.....	238
Field weakening	
Parameter.....	238
Fine tuning.....	481
Finless	
Derating.....	401
Firmware update lock.....	155
Freq Ref Setting Method Select.....	437
Frequency Agreement	
Parameter.....	384
Frequency reference	
Command source correlation diagram.....	225
LOCAL/REMOTE Run selection.....	157, 225
Offset frequency addition.....	239
Switching between LOCAL/REMOTE.....	157, 164, 225
Upper and lower frequency limits.....	231
Frequency reference bias	
Parameter.....	233, 238
Frequency reference hold function	
Parameter.....	233, 238
G	
Gateway Mode.....	266
GF	
Protection Functions.....	399
Ground Fault Detection	
Protection Functions.....	399
H	
HCA	
Alarm Settings.....	402
High-Slip Braking	
Parameter.....	407
Horsepower.....	434
I	
IGBT Maintenance Setting.....	441
Induction Motor	
Auto-Tuning.....	472
Induction motors	

Motor Parameters.....	249
Input Phase Detection	
Protection Functions.....	398
Input voltage	
Parameter.....	242
Installation	
Front cover.....	491
Keypad.....	493
Internal Drive Braking Transistor	
Protection Functions.....	403
J	
Jog command.....	231
Jump frequency	
Parameter.....	232
Jumper switch.....	506
K	
KEB ride-thru function	
Compensation Time.....	370
KEB Method Selection.....	373
Operation during momentary power loss.....	369
Parameter.....	364
Single Drive KEB Method.....	373
System KEB Method.....	373
Keypad	
Application Preset.....	471
Installation.....	493
Language selection.....	145
LED status.....	459
Method of operation.....	459
Remove.....	493
Keypad Display.....	427
Keypad Display Selection.....	428
Keypad Operation.....	435
Keypad-related settings.....	427
kWh Monitor Initialization.....	442
L	
Language selection.....	145
LCD contrast adjustment.....	430
Leakage current.....	363–364
LED display.....	466
LF	
Protective function.....	399
LF2	
Protection Functions.....	401
Load Inertia Ratio	
Parameter.....	382
LO/RE Key Function Selection.....	435
LOCAL/REMOTE indicator.....	459
LSo	
Protective function.....	404
M	
Maintenance Period.....	440
Maximum Output Frequency	
Motor 2 Parameters.....	253
Parameter.....	247
Maximum Output Voltage	
Motor 2 Parameters.....	253
Parameter.....	248
Mechanical Weakening Detection	
Parameter.....	390
MEMOBUS/Modbus Communications	

Parameter	345	Motor 2 rated power (kW)	256
Serial communication terminals	506	Motor Parameters	241, 249
Setting for termination resistor	510	Motor 2 Iron Loss	256
Mid point B frequency		Motor 2 Leakage Inductance	255
Motor 2 parameters	253	Motor 2 Line-to-Line Resistance	255
Parameter	248	Motor 2 No-load Current	255
Mid point B voltage		Motor 2 rated Current	254
Motor 2 parameters	254	Motor 2 Rated Slip	254
Parameter	249	Motor parameters (induction motors)	249
Middle Output Frequency		Leakage Inductance	251
Motor 2 Parameters	253	Line-to-Line Resistance	250
Parameter	248	Motor Iron Loss	251
Middle Output Frequency Voltage		Motor Iron-Core Saturation Coefficient 1	251
Motor 2 Parameters	253	Motor Iron-Core Saturation Coefficient 2	251
Parameter	248	Motor rated power (kW)	252
Minimum output frequency		No-load Current	250
Parameter	248	Number of motor poles	250
Minimum Output Frequency		Rated current	249
Motor 2 Parameters	253	Rated Slip	250
Minimum Output Voltage		Motor Power Unit Selection	434
Motor 2 Parameters	253	MotorDirect@PowUpWhenUsingKeypad	437
Parameter	248	Multi-step speed operation	225
Momentary Power Loss		Setting procedure	225
KEB Compensation Time	370	Multiple-unit connection	266
Monitors		N	
Display procedure	466	No-Load Voltage	
Motor		Parameter	249
Positive Temperature Coefficient (PTC) Thermistor	357	NumOfRunCommands Counter Initial	442
Motor 2		O	
Base Frequency	253	oC	
Base voltage	254	Overcurrent Detection Gain	401
Control mode settings	252	Off-Delay Timer	179
Leakage Inductance	255	Offset frequency	
Line-to-Line Resistance	255	Parameter	239
Maximum Output Frequency	253	oH	
Maximum Output Voltage	253	Alarm Settings	397
Mid point B frequency	253	oH2	
Mid point B voltage	254	Alarm Settings	397
Middle Output Frequency	253	oH3	
Middle Output Frequency Voltage	253	Operation During Detection of Alarms	362
Minimum Output Frequency	253	oH4	
Minimum Output Voltage	253	Operation During Detection of Faults (PTC Input)	362
Motor Iron Loss	256	oL2	
Motor Iron-Core Saturation Coefficient 1	256	Protection Functions	400
Motor Iron-Core Saturation Coefficient 2	256	On-Delay Timer	179
Motor rated power (kW)	256	Ope Select @Keypad is Disconnect	437
No-load Current	255	Operation During Momentary Power Loss	
Number of motor poles	255	KEB ride-thru function	364
Rated current	254	Operation method selection	369
Rated Slip	254	Parameter	369
V/f Pattern	252	Speed Search function	170
Motor Code Selection	257	Option card	
Motor Overheating		Parameter	262
Operation During Detection of Alarms	362	oS	
Operation During Detection of Faults (PTC Input)	362	Detection level	263
Motor Overload		Detection time	264
Electric Thermal Protection Operation Time	361	Operation Select at Overspeed	262
Protection Functions	358	Output Control	425
Motor parameters		Output Phase Loss Detection	
Motor 2	254	Protective function	399
Motor 2 Iron-Core Saturation Coefficient 1	256	Overexcitation deceleration	
Motor 2 Iron-Core Saturation Coefficient 2	256	Parameter	408
Motor 2 number of motor poles	255		

Overtorque detection		
Parameter	389	
P		
Parameter		
Access Level Selection	145	
Automatic selection	155	
Backup (drive to keypad).....	468	
Changing setting values	467	
Checking modified parameters	466	
Delete Backed-up Parameters.....	470	
Restore (keypad to drive).....	469	
Setup mode	467	
User-set	155	
Verify (keypad and drive)	469	
Parameter Change	438	
Password		
Setting.....	149	
Verification	148	
PC		
Connection procedure.....	511	
PF		
Protection Functions	398	
PGo		
Detection time	264	
Operation Selection after Detection.....	262	
Phase Order Selection	164	
PID control	181	
control block diagram.....	183	
Feedback value input.....	182	
fine tuning	184	
Parameter	186	
PID feedback loss detection.....	183	
PID Sleep	184	
Setpoint input	182	
PM motor parameters.....	256	
d-Axis inductance	258	
Induced voltage constant 1	258	
Induced voltage constant 2	259	
Motor rated current.....	257	
Motor rated power (kW).....	257	
Number of motor poles	257	
q-Axis inductance	258	
Stator resistance	258	
PM motors		
Auto-Tuning.....	473	
PM Motors		
Fine Adjustment	415, 426	
Motor Code Selection.....	257	
Motor parameters.....	256	
Positive Temperature Coefficient (PTC) Thermistor.....	357	
Protection Functions		
DC bus undervoltage.....	371	
Drive Overheating.....	397	
GF	399	
Ground Fault Detection.....	399	
HCA	402	
Input Phase Detection.....	398	
Internal Drive Braking Transistor	403	
LF2	401	
Motor Overheating	362	
Motor Overheating (PTC Input).....	362	
Motor Overload.....	358	
oC.....	401	
oH.....	397	
oH2	397	
oH3	362	
oH4	362	
oL2	400	
Output Current Overload	402	
Overcurrent.....	401	
Overload	400	
PF.....	398	
rr	403	
Software Current Limit Selection	400	
Uv1	371	
Protective function		
Desynchronization.....	404	
LF.....	399	
Low Speed Desynchronization	404	
LSo	404	
Output Phase Loss Detection	399	
Pulse Train Input		
Terminal RP Function Selection.....	349	
Pulse Train Input/Output		
Parameter.....	349	
Pulse train output		
Terminal MP function selection	351	
Wiring specifications.....	508	
R		
Remove		
Front cover	491	
Keypad.....	493	
RESET key.....	459	
Restore		
Parameters (keypad to drive)	469	
Reverse Operation Selection.....	162	
RJ-45 connector	459	
Rotational Auto-Tuning		
Induction Motor	472	
PM motors.....	473	
Precautions	477	
rr		
Protection Functions	403	
Run command		
LOCAL/REMOTE Run selection.....	159	
Switching between LOCAL/REMOTE	159	
Run Command at Power Up.....	166	
Run Command Selection 2		
Switching between LOCAL/REMOTE	166	
RUN indicator	459	
RUN key	459	
S		
S-curve characteristics		
Parameter.....	209	
Screen.....	466	
Serial communication terminals		
MEMOBUS/Modbus Communications	506	
Short Circuit Braking		
Parameter.....	167	
Side-by-side		
Derating.....	401	
Slip compensation		
Parameter	209	
Softcharge Relay Maintenance Set	441	

Software Current Limit Selection		User Parameter Default Value	435
Protection Functions	400	User-Set Display Units Max Value	430
Speed Agreement		User-SetDisplayUnits Dec Display	430
Parameter	384	Uv	438
Speed Detection	385	Speed Search Selection at Start.....	178
Parameter	384	Uv1	
Speed Estimation Speed Search.....	172	Detection level settings	371
Speed Search function		V	
Operation during momentary power loss.....	369	V/f Pattern.....	241
Parameter	170	Second Motor	252
Stall Prevention function		V/f Pattern Display Unit	429
Parameter	374	Verify	
Stationary Auto-Tuning		Parameters (keypad and drive)	469
Induction Motor	472	Voltage Limit	425
PM motors.....	473	Voltage Saturation.....	425
Precautions	477	W	
Stationary Auto-Tuning for Line-to-Line Resistance	472	Wiring	
Precautions	478	Control circuit terminals.....	502
Stator resistance Auto-Tuning.....	473		
Precautions	478		
Stop command			
LOCAL/REMOTE Run selection.....	159		
STOP key.....	459		
STOP Key Function Selection.....	435		
Stop with Constant Distance.....	238		
Stopping Method Selection	159		
T			
Terminal block			
Configuration of control circuit terminal block	506		
Control circuit terminal block functions.....	503		
I/O terminals function selection switches	506		
Terminal function selection.....	509		
Terminal A2	506, 509		
Terminal AM.....	506, 510		
Termination resistor			
Setting switch	510		
Test run			
Checklist	486		
Fine tuning	481		
Procedure for no-load test run	479		
Procedure for test run with actual load	479		
Timer function			
Parameter	179		
Torque Compensation			
Parameter	213		
Torque limit function			
Parameter	394		
Tuning	203		
U			
U2, U3 Initialization	442		
Undertorque detection			
Parameter	389		
Unit of measurement setting			
Acceleration and deceleration times	206		
Unit selector	434		
Up 2 command			
Parameter	233, 238		
Up command.....	294, 296		
Parameter	233, 238		
USB port	459		
Connecting a PC.....	511		
User Monitor Select afterPowerUp.....	428		

Revision History

Date of Publication	Revision Number	Section	Revised Content
November 2019	-	-	First Edition

YASKAWA

GA500 DRIVE PROGRAMMING

YASKAWA AMERICA, INC.

2121, Norman Drive South, Waukegan, IL
60085, U.S.A.
Phone: +1-800-YASKAWA (927-5292) or +1-
847-887-7000 Fax: +1-847-887-7310
www.yaskawa.com

DRIVE CENTER (INVERTER PLANT)

2-13-1, Nishimiyaichi, Yukuhashi, Fukuoka,
824-8511, Japan
Phone: +81-930-25-2548 Fax: +81-930-25-
3431
www.yaskawa.co.jp

YASKAWA EUROPE GmbH

Philipp-Reis-Str. 6, 65795 Hattersheim am
Main, Germany
Phone: +49-6196-569-300 Fax: +49-6196-
569-398
E-mail: info@yaskawa.eu.com
www.yaskawa.eu.com

YASKAWA ELÉTRICO DO BRASIL LTDA.

777, Avenida Piraporinha, Diadema, São
Paulo, 09950-000, Brasil
Phone: +55-11-3585-1100 Fax: +55-11-3585-
1187
www.yaskawa.com.br

In the event that the end user of this product is to be the military and said product is to be employed in any weapons systems or the manufacture thereof, the export will fall under the relevant regulations as stipulated in the Foreign Exchange and Foreign Trade Regulations. Therefore, be sure to follow all procedures and submit all relevant documentation according to any and all rules, regulations and laws that may apply.

Specifications are subject to change without notice for ongoing product modifications and improvements.

Original Instructions

© 2019 YASKAWA America, Inc.

YASKAWA America, Inc.



TOEPYAIGA5002

TOEPYAIGA5002
Revision: A <0>-0
November 2019
Published in U.S.A.
19-11-18_YAI