

AC SERVOPACK  
**JUNMA Series**  
**INSTRUCTIONS**

MODEL: SJDE-□□A

To properly use the product, read this manual thoroughly and retain for easy reference, inspection, and maintenance. Ensure the end user receives this manual.

AC伺服单元  
**JUNMA系列**  
**使用说明书**

型号: SJDE-□□A

为了安全使用本产品，请务必阅读该使用说明书。  
另外，请妥善保管该使用说明书，并将其交至最终用户手中。

ACサーボパック  
**JUNMAシリーズ**  
**取扱説明書**

形式: SJDE-□□A

製品を安全にお使い頂くために、本書を必ずお読みください。  
また、本書をお手元に保管していただくとともに、最終的に本製品をご使用になるユーザー様のお手元に確実に届けられるよう、お取り計らい願います。

# Introduction

This instruction manual describes the JUNMA series AC SERVOPACKs. To properly use the JUNMA series AC SERVOPACK, read these instructions thoroughly and retain for easy reference for inspections, maintenance, and so on. Make sure that the end user receives this manual.

## Related Manuals

Refer to the following manuals as required.

Manual Name	Manual Number
AC SERVO DRIVES JUNMA SERIES	KAEPS80000023
JUNMA series AC SERVOMOTOR INSTRUCTIONS	TOMPC23026100 or TOBPC23026100

## Safety Information

The following conventions are used to indicate precautions in this manual. Failure to heed these precautions can result in serious or possibly even fatal injury or damage to the products or to related equipment and systems.



**WARNING**

Indicates precautions that, if not heeded, could possibly result in loss of life or serious injury.



**CAUTION**

Indicates precautions that, if not heeded, could result in relatively serious or minor injury, damage to the product, or faulty operation.

In some situations, the precautions indicated could have serious consequences if not heeded.



**PROHIBITED**

Indicates prohibited actions that must not be performed. For example, this symbol would be used as follows to indicate that fire is prohibited: .













**MANDATORY**

Indicates compulsory actions that must be performed. For example, this symbol would be used as follows to indicate that grounding is compulsory: .





## Notes for Safe Operation

Read these instructions thoroughly before checking products on delivery, storage and transportation, installation, wiring, operation and inspection, and disposal of the AC SERVOPACK.

### WARNING

-  • Be sure to correctly connect the SERVOPACK connectors, CNA and CNB.  
Incorrect wiring may result in electric shock, injury, or damage to the equipment. For the wiring method, refer to *3.8 Wiring the Power Supply/Regenerative Unit Connector (CNA)* and *3.9 Wiring the Servomotor Main Circuit Cable Connector (CNB)*.
-  • Make sure that the emergency-stop circuit turns OFF the Servo ON signal and the power supply of the main circuit when the EMG (emergency stop) signal turns ON.  
Because of residual voltage, the servomotor rotates for a few seconds after the power supply has turned OFF. This may result in injury or damage to the equipment. Make sure that the EMG means the stop of the motor rotation.
- Never touch any rotating motor parts while the motor is running.  
Failure to observe this warning may result in injury.
-  • Before starting operation with a machine connected, make sure that an emergency stop can be applied at any time. Also, design the circuit's power supply to be automatically cut off if /S-ON signal is OFF, and an emergency stop occurs at the same time.  
Failure to observe this warning may result in injury.
-  • Never touch the inside of the SERVOPACKS.  
Failure to observe this warning may result in electric shock.
-  • Do not touch terminals for five minutes after the power is turned OFF.  
Residual voltage may cause electric shock.
-  • Follow the procedures and instructions for trial operation precisely as described in this manual.  
Malfunctions that occur after the servomotor is connected to the equipment not only damage the equipment, but may also cause an accident resulting in death or injury.
-  • Do not remove the front cover, cables, connectors, or optional items while the power is ON.  
Failure to observe this warning may result in electric shock.
-  • Installation, wiring, advice on inspection and malfunction must be performed only by authorized personnel.  
Failure to observe this warning may result in fire, electric shock, or injury.
-  • Do not damage, press, exert excessive force or place heavy objects on the cables or the cables between other objects where they might be pinched.  
Failure to observe this warning may result in electric shock, stopping operation of the product, or burning.
-  • Provide an appropriate stopping device on the machine side to ensure safety.  
A holding brake for a servomotor with brake is not a braking device for ensuring safety. Failure to observe this warning may result in injury.

## WARNING

- 
  - Do not come close to the machine immediately after resetting momentary power loss to avoid an unexpected restart.  
Take appropriate measures to ensure safety against an unexpected restart. Failure to observe this warning may result in injury.
- 
  - Do not modify the product.  
Failure to observe this warning may result in injury or damage to the product.
- 
  - Be sure to correctly ground the SERVOPACK and the servomotor.
- 
  - Connect the SERVOPACK's ground terminal to electrical codes (ground resistance: 100 Ω or less).  
Improper grounding may result in electric shock or fire.



### ■ Checking on Delivery

## WARNING

- 
  - Always use the servomotor and SERVOPACK in one of the specified combinations.  
Failure to observe this caution may result in fire or malfunction.

### ■ Storage and Transportation

## WARNING

- 
  - Do not store or install the product in the following places.  
Failure to observe this caution may result in damage to the product.
    - Locations subject to direct sunlight.
    - Locations subject to temperatures outside the range specified in the storage or installation temperature conditions.
    - Locations subject to humidity outside the range specified in the storage or installation humidity conditions.
    - Locations subject to condensation as the result of extreme changes in temperature.
    - Locations subject to corrosive or flammable gases.
    - Locations subject to dust, salts, or iron dust.
    - Locations subject to exposure to water, oil, or chemicals.
    - Locations subject to shock or vibration.
- 
  - Do not hold the product by the cables or motor shaft while transporting it.  
Failure to observe this caution may result in injury or malfunction.
- 
  - Do not place any load exceeding the limit specified on the packing box.  
Failure to observe this caution may result in injury or malfunction.

## WARNING

- If disinfectants or insecticides must be used to treat packing materials such as wooden frames, pallets, or plywood, the packing materials must be treated before the product is packaged, and methods other than fumigation must be used.  
Example: Heat treatment, where materials are kiln-dried to a core temperature of 56°C for 30 minutes or more.

If the electronic products, which include stand-alone products and products installed in machines, are packed with fumigated wooden materials, the electrical components may be greatly damaged by the gases or fumes resulting from the fumigation process. In particular, disinfectants containing halogen, which includes chlorine, fluorine, bromine, or iodine can contribute to the erosion of the capacitors.

### ■ Installation

## WARNING





- ❗ • Make sure to follow the conditions on *2.1 Installation Conditions*.  
Failure to observe this caution may result in electric shock, fire, or SERVOPACK's malfunction.
- ⊘ • Do not step on or place a heavy object on the product.  
Failure to observe this caution may result in injury.
- ⊘ • Do not cover the inlet or outlet parts and prevent any foreign objects, such as metallic fragment, or combustibles from entering the product.  
Failure to observe this caution may cause internal elements to deteriorate resulting in malfunction or fire.
- ❗ • Be sure to install the product in the correct direction.  
Failure to observe this caution may result in malfunction.
- ❗ • Provide the specified clearances between the SERVOPACK and the control panel or with other devices.  
Failure to observe this caution may result in fire or malfunction.
- ⊘ • SERVOPACK is precision equipment. Do not apply any strong impact.  
Failure to observe this caution may result in malfunction.





### ■ Wiring

## WARNING

- ⊘ • Do not connect a three-phase power supply to the U, V, or W output terminals.  
Failure to observe this caution may result in injury or fire.
- ❗ • Securely connect the power supply terminals, regenerative unit connection terminal, and motor main circuit cable terminals.  
Failure to observe this caution may result in fire.

## ⚠ WARNING







-  • Do not bundle or run power and signal lines together in the same duct. Keep power and signal lines separated by at least 30 cm (11.81 in).  
Failure to observe this caution may result in malfunction.
-  • Use twisted-pair shielded wires or multi-core twisted pair shielded wires for I/O signal cable and encoder cable.  
The maximum length is 3 m (118.11 in) for reference input lines and is 20 m (787.40 in) for PG feedback lines.
-  • Do not touch the power terminals for five minutes after turning the power supply LED (PWR) are OFF because high voltage may still remain in the SERVOPACK.  
Make sure the charge indicator is turned OFF first before starting an inspection.
-  • Avoid frequently turning power ON and OFF. Do not turn power ON or OFF more than once per minute.  
Since the SERVOPACK has a capacitor in the power supply, a high charging current flows for 0.2 seconds when power is turned ON. Frequently turning power ON and OFF causes main power devices such as capacitors and fuses to deteriorate, resulting in unexpected problems.
-  • Observe the following precautions when wiring connector for power supply/regenerative unit.

  - Remove the connector for power supply/regenerative unit from the SERVOPACK prior to wiring.
  - Insert only one wire per terminal on the connector for power supply/regenerative unit.
  - Make sure that the core wire is not electrically shorted to adjacent core wires.
-  • Be sure to wire correctly and securely.  
Failure to observe this caution may result in motor overrun, injury, or malfunction.
-  • Always use the specified power supply voltage of single-phase 200 V to 230 V without connecting directly to a voltage of 400 V.  
The SERVOPACK will be destroyed.
-  • Take appropriate measures to ensure that the input power supply is supplied within the specified voltage fluctuation range. Be particularly careful in places where the power supply is unstable.  
An incorrect power supply may result in damage to the product.
-  • Install external breakers or other safety devices against short-circuiting in external wiring.  
Failure to observe this caution may result in fire.
-  • Take appropriate and sufficient countermeasures for each when installing systems in the following locations.  
Failure to observe this caution may result in damage to the product.

  - Locations subject to static electricity or other forms of noise.
  - Locations subject to strong electromagnetic fields and magnetic fields.
  - Locations subject to possible exposure to radioactivity.
  - Locations close to power supplies including power supply lines.
-  • Do not reverse the polarity of the battery when wiring with regenerative unit.  
Failure to observe this caution may result in damage to the product.

## ■ Operation

### WARNING

-  • Conduct trial operation on the servomotor alone with the motor shaft disconnected from machine to avoid any unexpected accidents.  
Failure to observe this caution may result in injury.
- During a trial operation, confirm that the holding brake works correctly. Furthermore, secure system safety against problems such as signal line disconnection.
-  • Before starting any operation with a machine connected, change the settings of the SERVOPACK's reference pulse with the PULSE rotary switch to match those of the machine.  
Starting operation without matching the proper settings may cause the machine to run out of control or malfunction.
-  • When using the servomotor for a vertical axis, install safety devices to prevent workpieces from falling off because of alarms.  
Workpiece's falling off may result in injury or malfunction.
-  • Do not touch the SERVOPACK heatsinks, regenerative unit, or servomotor while power is ON or soon after the power is turned OFF.  
Failure to observe this caution may result in burns due to high temperatures.
-  • When an alarm occurs, remove the cause, turn OFF the power and ON again after confirming safety, and then resume operation.  
Failure to observe this caution may result in injury.
-  • Do not use the holding brake of the servomotor for ordinary braking.  
Failure to observe this caution may result in malfunction.

## ■ Maintenance and Inspection

### WARNING

- Do not open the SERVOPACK case for 5 minutes after the power supply lamp (PWR LED) goes out. High voltage may remain in the SERVOPACK after the power supply has been turned OFF.
- After turning OFF the power supply, wait 15 minutes before replacing the cooling fan.  
Failure to observe this caution may result in burns because the cooling fan is hot.
- Mount the cooling fan in the correct way explained in 6.3 *Replacement of Cooling Fan*.  
Mounting the cooling fan in the incorrect direction may result in the breakdown of the SERVOPACK.
-  • Do not attempt to change wiring while the power is ON.  
Failure to observe this caution may result in electric shock or injury.

---

**■ Disposal**** WARNING**

- When disposing of the products, treat them as general industrial waste.

**■ General Precautions****Note the following to ensure safe application.**

- The drawings presented in this manual are sometimes shown without covers or protective guards. Always replace the cover or protective guard as specified first, and then operate the products in accordance with the manual.
- The drawings presented in this manual are typical examples and may not match the product you received.
- This manual is subject to change due to product improvement, specification modification, and manual improvement. When this manual is revised, the manual code is updated and the new manual is published as a next edition.
- If the manual must be ordered due to loss or damage, inform your nearest Yaskawa representative or one of the offices listed on the back of this manual.
- Yaskawa will not take responsibility for the results of unauthorized modifications of this product. Yaskawa shall not be liable for any damages or troubles resulting from unauthorized modification.



---

## CONTENTS

Introduction	E-1
Related Manuals	E-1
Safety Information	E-1
Notes for Safe Operation	E-2
<b>1 Before Use</b>	<b>E-10</b>
1.1 Warning Label	E-10
1.2 Checking Products	E-10
1.3 Model Designation	E-11
1.4 SERVOPACKs and Applicable Servomotors	E-11
1.5 Part Names and Functions	E-12
■ Reference Pulse Setting (PULSE)	E-12
■ Reference Filter Setting Rotary Switch (FIL)	E-13
■ Reference Display (REF)	E-13
■ Alarm Display (AL1, AL2, and AL3)	E-13
<b>2 Installation</b>	<b>E-14</b>
2.1 Installation Conditions	E-14
2.2 Installation Method	E-15
■ Installation Method and Direction	E-15
■ Space between SERVOPACK Units	E-15
<b>3 Wiring</b>	<b>E-16</b>
3.1 Precautions on Wiring	E-16
■ Protection for Power Supply Line	E-16
■ Caution for Grounding	E-16
■ Caution for Cable	E-16
■ Other Precautions	E-17
■ Power Loss	E-17
■ Molded-Case Circuit Breaker (MCCB) or Fuse Capacity Relation to Power-Supply Capacity	E-18
■ Noise Prevention	E-19
3.2 System Configuration	E-21
3.3 Standard Connection	E-22
3.4 Installation and Wiring Conditions on CE Marking	E-23
■ Attaching the Ferrite Core	E-24
■ Fixing the Cable	E-25
■ Shield Box	E-25
3.5 SERVOPACKs and Applicable Peripheral Devices	E-25
3.6 Main Circuit Wiring	E-26

3.7	SERVOPACK Main Circuit Wire Size	E-26
■	Cable Types	E-26
■	Cable Size and Allowable Current	E-26
■	Power Supply Input Terminals (L1, L2), Motor Connection Terminals (U, V, W), and Regenerative Unit Connection Terminals (+, -)	E-26
■	Ground Terminal ( $\oplus$ )	E-27
■	Encoder Signal Connector	E-27
■	I/O Signal Connector	E-27
3.8	Wiring the Power Supply/Regenerative Unit Connector (CNA)	E-28
■	Wire Size	E-28
■	Connector for Power Supply/Regenerative Unit (CNA)	E-29
3.9	Wiring the Servomotor Main Circuit Cable Connector (CNB)	E-30
■	Servomotors without Brakes	E-30
■	Servomotors with Brakes	E-31
3.10	Wiring the Encoder Connector (CN2)	E-33
■	Connection Diagram for Standard Encoder Cable	E-33
3.11	Wiring I/O Connectors	E-34
■	Connection Diagram for Standard I/O Cable	E-34
3.12	Connection Examples of Input Signal	E-35
■	Line Driver Output	E-35
■	Open-collector Output	E-35
3.13	Connection Example of Output Signal	E-36
3.14	EMG Sequence	E-37
3.15	Explanation of I/O Signals	E-38
4	Trial Operation	E-40
5	Troubleshooting	E-42
5.1	Alarm Indicator Lights	E-42
5.2	Troubleshooting for Malfunctions when Alarm Indicators Are Not Lit	E-47
6	Inspections	E-50
6.1	Regular Inspections	E-50
6.2	Part's Life Expectancy	E-50
6.3	Replacement of Cooling Fan	E-51
7	Specifications	E-56
7.1	Specifications	E-56
7.2	Overload Protection Characteristics	E-57

Revision History

# 1 Before Use

## 1.1 Warning Label

A warning label is located on the side of the SERVOPACK.

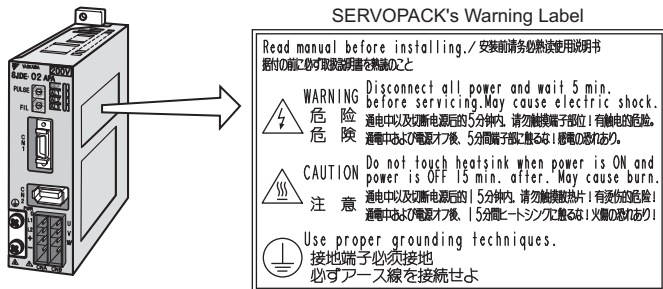

## 1.2 Checking Products

Confirm that the following items have been delivered together with the SERVOPACK. Verify that the ordered product as received by the model number marked on the nameplate on the SERVOPACK.

If you find any irregularities such as incorrect SERVOPACK model, damages, and missing parts or items, contact your Yaskawa representative or the dealer from whom you purchased the products.

① SJDE SERVOPACK

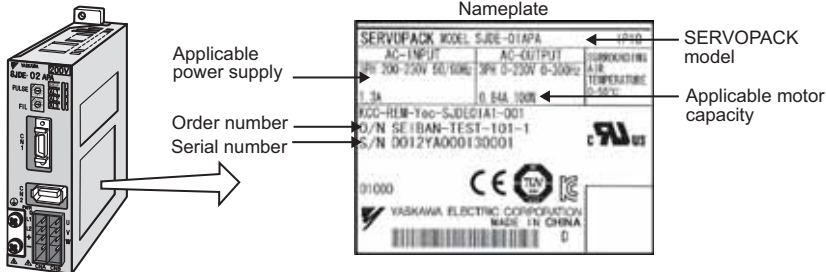

② One screwdriver for selecting the pulse and setting the filter



③ One copy of this Instruction Manual



## 1.3 Model Designation

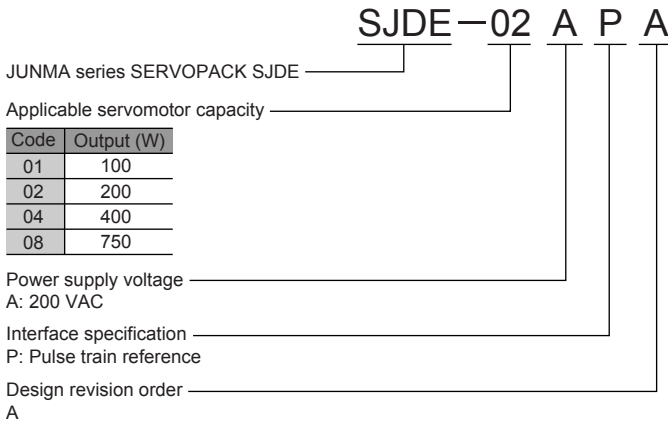

## 1.4 SERVOPACKs and Applicable Servomotors

Rated Output	Servomotor		SERVOPACK
	Without Brakes	With Brakes	
100W	SJME-01AM□41	SJME-01AM□4C	SJDE-01APA
200W	SJME-02AM□41	SJME-02AM□4C	SJDE-02APA
400W	SJME-04AM□41	SJME-04AM□4C	SJDE-04APA
750W	SJME-08AM□41	SJME-08AM□4C	SJDE-08APA

1.5 Part Names and Functions

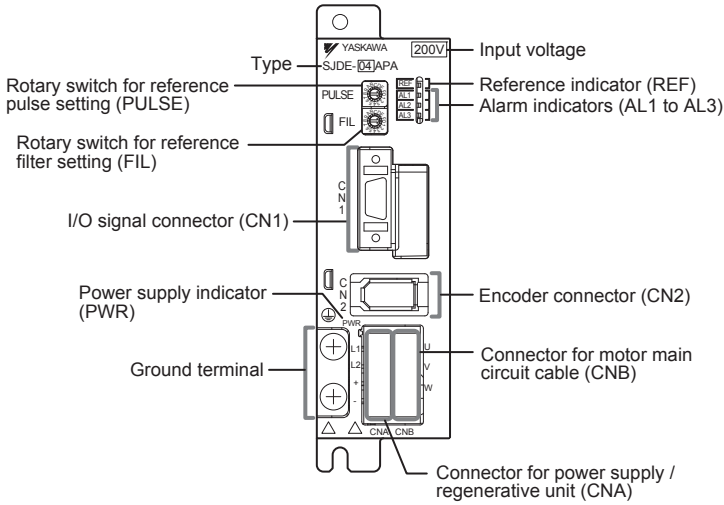

■ Reference Pulse Setting (PULSE)

PULSE



Set Value	Reference Pulse Resolution (P/REV)	Reference Pulse Connection Method	Reference Pulse Type
0	1000	Open collector or line driver	CW + CCW Positive logic
1	2500		
2	5000	Line driver	CW
3	10000		CCW
4	1000	Open collector or line driver	CW + CCW Negative logic
5	2500		
6	5000	Line driver	CW
7	10000		CCW
8	1000	Open collector or line driver	Mark + pulse sequence, Positive logic
9	2500		
A	5000	Line driver	PULS
B	10000		SIGN
C	1000	Open collector or line driver	Mark + pulse sequence, Negative logic
D	2500		
E	5000	Line driver	PULS
F	10000		SIGN

Note: 1. Make settings after turning OFF the power.  
 2. The factory setting is 0.

### Reference Filter Setting Rotary Switch (FIL)

Filter Setting Value* <sup>2</sup>	Acceleration/Deceleration Time for Step Reference* <sup>4</sup>	Approx. Time between Completing Reference and Completing Positioning (Settling Time)* <sup>3</sup>	Description
0* <sup>1</sup>	45 ms	100 to 200 ms	↑ Small filter time constant (short positioning time)  Large filter time constant (little vibration with a long positioning time) ↓
1	50 ms	110 to 220 ms	
2	60 ms	130 to 260 ms	
3	65 ms	150 to 300 ms	
4	70 ms	170 to 340 ms	
5	80 ms	200 to 400 ms	
6	85 ms	250 to 500 ms	
7	170 ms	500 to 1000 ms	
8 to F	Do not set 8 through F.		



- \* 1. The factory setting is 0. If the machine vibrates, this value must be changed.
- \* 2. If the machine vibrates when starting or stopping the machine, set a larger value.
- \* 3. The value depends on conditions such as the level of command acceleration and deceleration, the machine rigidity and the motor resolution (PULSE switch).
- \* 4. Select the correct servomotor capacity with these values if using a step reference that has no acceleration or deceleration time.

### Reference Display (REF)

Indicators*	Motor Power	Reference Pulses
Lit orange.	OFF	–
Blinks orange.	OFF	Input
Lit green.	ON	–
Blinks green.	ON	Input

\* Lit yellow for 1s when the clear signal is input.

### Alarm Display (AL1, AL2, and AL3)

■: Lit □: OFF

Indicators	Meaning of Alarm	Indicators	Meaning of Alarm
AL1 □ AL2 □ AL3 □	Normal	AL1 ■ AL2 □ AL3 ■	Overcurrent
AL1 ■ AL2 □ AL3 □	Speed error	AL1 □ AL2 ■ AL3 ■	SERVOPACK's built-in fan stop
AL1 □ AL2 ■ AL3 □	Overload	AL1 ■ AL2 ■ AL3 ■	System error
AL1 ■ AL2 ■ AL3 □	Encoder error	AL1 ■ □ AL2 ■ ← □ AL3 ■ □ Blinks at regular intervals.	Rotary switch for reference pulse setting (PULSE) changed.
AL1 □ AL2 □ AL3 ■	Voltage error		

## 2 Installation

The following shows the installation location and method of the SERVOPACK.

### 2.1 Installation Conditions

Item		Specifications
Operating temperature		0 °C to +55 °C
Operating humidity		90% RH or less (with no condensation)
Storage temperature		-20 °C to +70 °C
Storage humidity		90% RH or less (with no condensation)
Installation site		Free of corrosive gases Free of dust and iron powder Clean and dry
Altitude		1000 m or below
Vibration resistance		4.9m/s <sup>2</sup>
Shock resistance		19.6m/s <sup>2</sup>
Operating conditions		Installation category (overvoltage category): II Pollution degree: 2 Protection class: IP1X (EN50178)
Installation Site	Installation in a control panel	Design the control panel size, unit layout, and cooling method so the temperature around the SERVOPACK does not exceed 55 °C.
	Installation near a heating unit	Minimize the heat radiating from the heating unit as well as any temperature rise caused by natural convection so the temperature around the SERVOPACK does not exceed 55 °C.
	Installation near a source of vibration	Install a vibration isolator beneath the SERVOPACK to avoid subjecting it to vibration.
	Installation at a site exposed to corrosive gas	Corrosive gas does not have an immediate effect on the SERVOPACK but will eventually cause the electronic components and contactor-related devices to malfunction. Take appropriate action to avoid corrosive gas.

## 2.2 Installation Method

### ■ Installation Method and Direction

- Install the SERVOPACK perpendicular to the wall. The SERVOPACK contains a built-in fan for cooling and must be mounted in the specified direction.
- Connect the mounting holes securely to the mounting surface with M4 screws (two mounting holes).

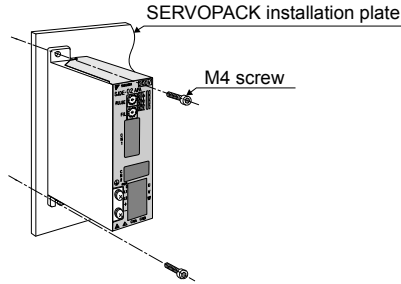

### ■ Space between SERVOPACK Units

- Be sure to keep a space between adjacent SERVOPACK units if they are mounted inside the control panel so that the units can be cooled.
- Do not cover the inlet or outlet parts and prevent any foreign objects, such as metallic fragment, or combustibles from entering the product.

Failure to observe this caution may cause internal elements to deteriorate resulting in malfunction or fire.

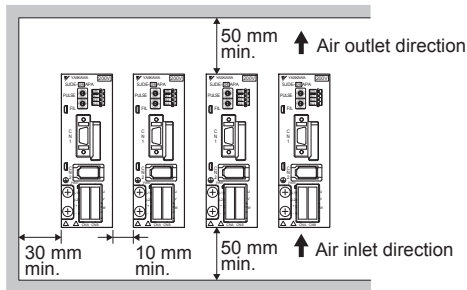



## 3 Wiring

### 3.1 Precautions on Wiring

#### WARNING

- Be sure to correctly ground the SERVOPACK and the servomotor.
- Wiring must be performed by an authorized person qualified in electrical work.

#### ■ Protection for Power Supply Line

- Use a molded-case circuit breaker and fuse to protect the power supply line from high voltage. The SJDE SERVOPACK connects directly to a commercial power supply without a transformer, so always use a circuit breaker and fuse to protect the SERVOPACK from accidental high voltage.

#### ■ Caution for Grounding

Consider the following conditions when grounding the SERVOPACK.

- For a ground wire, use as thick a cable as possible ( $2.0 \text{ mm}^2$  or thicker).
- A ground resistance of  $100 \text{ } (\Omega)$  or less is recommended.
- Ground to one point only.

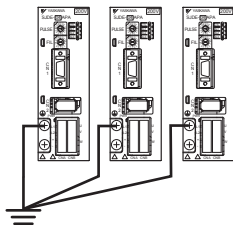

#### ■ Caution for Cable

- For wiring, use the specified cables. Use cables that are as short as possible.
- Do not bend or apply tension to cables. The conductor of a signal cable is very thin ( $0.08$  to  $0.12 \text{ mm}^2$ ), so handle the cables carefully.

### ■ Other Precautions

- Make sure that the emergency-stop circuit turns OFF the /S-ON signal as well as the power supply of the main circuit. Refer to 3.14 EMG Sequence.
- An overtravel function is not provided for the SERVOPACK.  
For system safety, include a sequence so that the /S-ON signal will turn OFF when the limit switch is activated.
- If the servomotor is used to drive a vertical axis, install a safety device with an alarm function to prevent the workpiece from falling down. Failure to observe this precaution may result in injury or damage to the equipment from fallen workpieces.
- Install an interlock system in the circuit to avoid any accident when opening or closing the machine's protective cover.
- Whether the electricity is served or not to the motor, do not use the motor being rotated from the outside.
- When restarting the power supply soon after turning OFF, alarm may occur to the SERVOPACK. Refer to the power supply holding time in the following table to restart the power supply correctly.

SERVOPACK		Min. Waiting Time before Restarting (s)
Model	Capacity	
SJDE-01APA	100W	20
SJDE-02APA	200W	
SJDE-04APA	400W	
SJDE-08APA	750W	30

### ■ Power Loss

Power Loss with SERVOPACK Rated Output

Main Circuit Power Supply	Max. Applicable Servomotor Capacity kW	SERVOPACK Model No.	Output Current (Effective Value) A	Main Circuit Power Loss W	Diode Power Loss W	IPM Power Loss W	Control Circuit Power Loss W	Total Power Loss W
Single-phase 200 V	0.1	SJDE-01A	0.84	6	0.9	4.2	9	15
	0.2	SJDE-02A	1.1	8	1.8	5.8		17
	0.4	SJDE-04A	2.0	16	3.6	11.9		25
	0.75	SJDE-08A	3.7	27	6.4	20.3		36

Note: Valued obtained with the servomotor with the rated output.

### 3.1 Precautions on Wiring

#### ■ Molded-Case Circuit Breaker (MCCB) or Fuse Capacity Relation to Power-Supply Capacity

MCCB or Fuse Capacity Relation to Power-Supply Capacity

Main Circuit Power Supply	SERVOPACK		Applicable Servomotor Model	Power-Supply Capacity kVA	MCCB Current Capacity Arms *1	External Fuse Model No. [Power-Supply Capacity Arms] *2	Inrush Current A	Rated Voltage V	
	Capacity kW	Model No.						Fuse	MCCB
Single-phase 200 V	0.1	SJDE-01A	SJME-01A	0.4	4	0KLK 015.T [15]	30	250	240
	0.2	SJDE-02A	SJME-02A	0.75					
	0.4	SJDE-04A	SJME-04A	1.2	8				
	0.75	SJDE-08A	SJME-08A	2.2	16	0KLK 030.T [30]	60		

\* 1. Valued obtained with the servomotor with the rated output.

\* 2. Fuse manufactured by Littelfuse Inc.

#### NOTE

##### Ground Fault

The ground protection circuit is designed for ground fault inside the motor windings while the motor is running. Therefore, it may not protect the system under the following conditions.

- A low-resistance ground fault occurs between the main circuit cable and connector for the servomotor.
- The power supply is turned ON during a ground fault.

To configure a safer system, install an earth leakage breaker for protection against overloads and short-circuiting, or install an earth leakage breaker combined with a wiring circuit breaker for ground protection.

## ■ Noise Prevention

### Example of Wiring for Noise Prevention

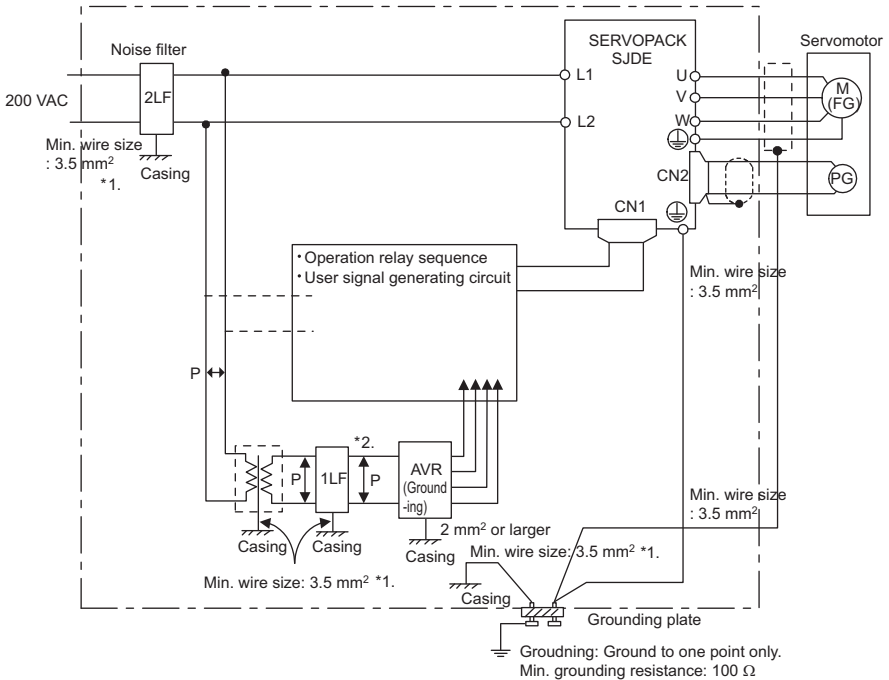

\* 1. For the wires connected to the casings for installation purposes, use wires with a diameter of 3.5 mm<sup>2</sup> or larger. Flat braided copper wires are recommended.

\* 2. Use twisted pair wires for section P.

### Correct Grounding

- Servomotor frame grounding:  
Be sure to connect the FG grounding terminal on the frame of the servomotor to the grounding terminal on the SERVOPACK.
- Be sure to ground the grounding terminal of the SERVOPACK.
- If the wires of the servomotor's main circuit are laid in a metal conduit, ground the conduit and the grounding box.

One-point grounding must be used.

### 3.1 Precautions on Wiring

---

#### Noise Filters

Use noise filters to prevent any noise interference from the power-supply line.

The following table lists the recommended noise filters.

Recommended Noise Filters

Power-Supply Voltage	SERVOPACK Model	Recommended Noise Filters		
		Model	Specifications	Manufacturer
Single-phase 200 V	SJDE-01A to -02A	FN2070-6/07	Single-phase 250 VAC, 6A	Schaffner EMC, Inc.
	SJDE-04A	FN2070-10/07	Single-phase 250 VAC, 10A	
	SJDE-08A	FN2070L-16/07	Single-phase 250 VAC, 16A	

### 3.2 System Configuration

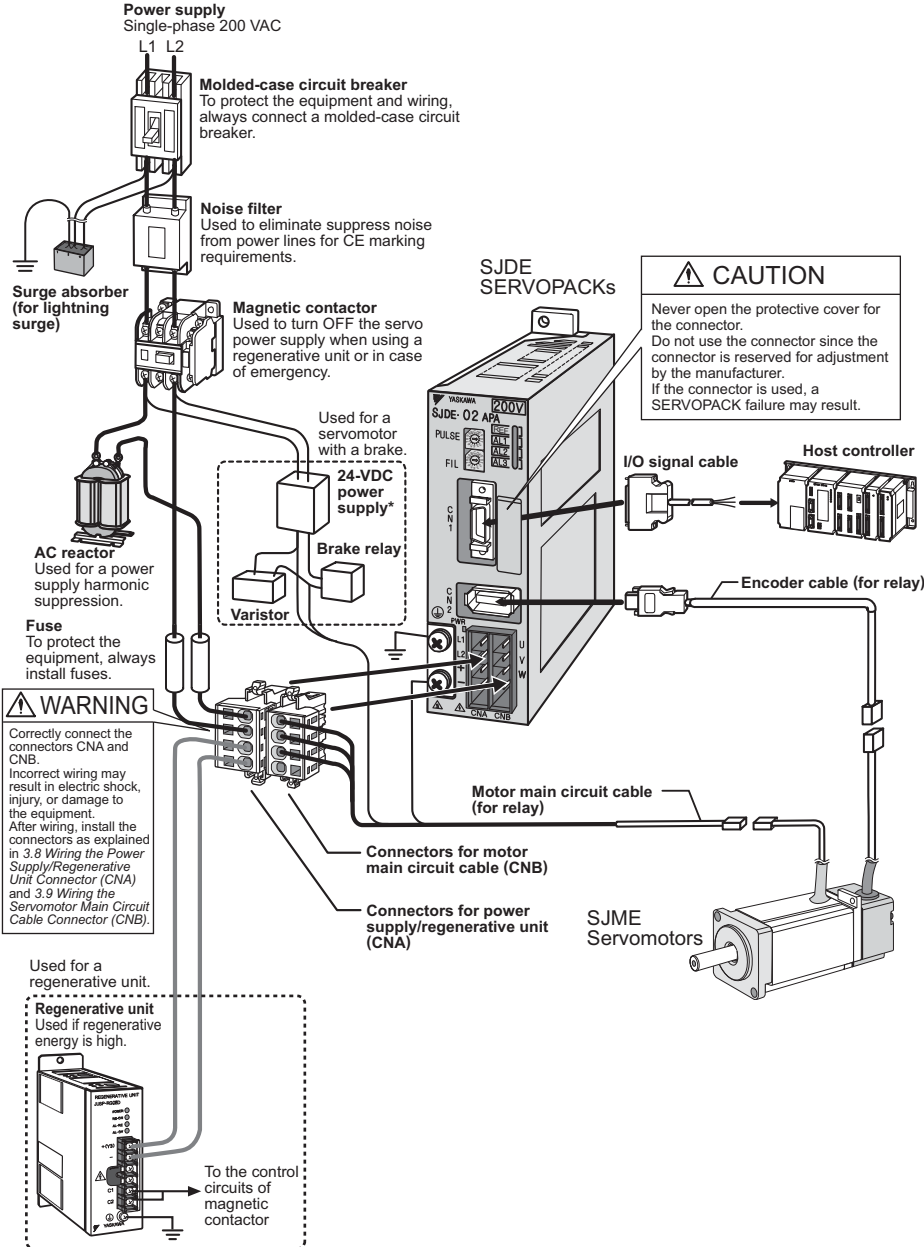

\* Prepare a 24-VDC power supply for the brake separately from the sequence power supply.

### 3.3 Standard Connection

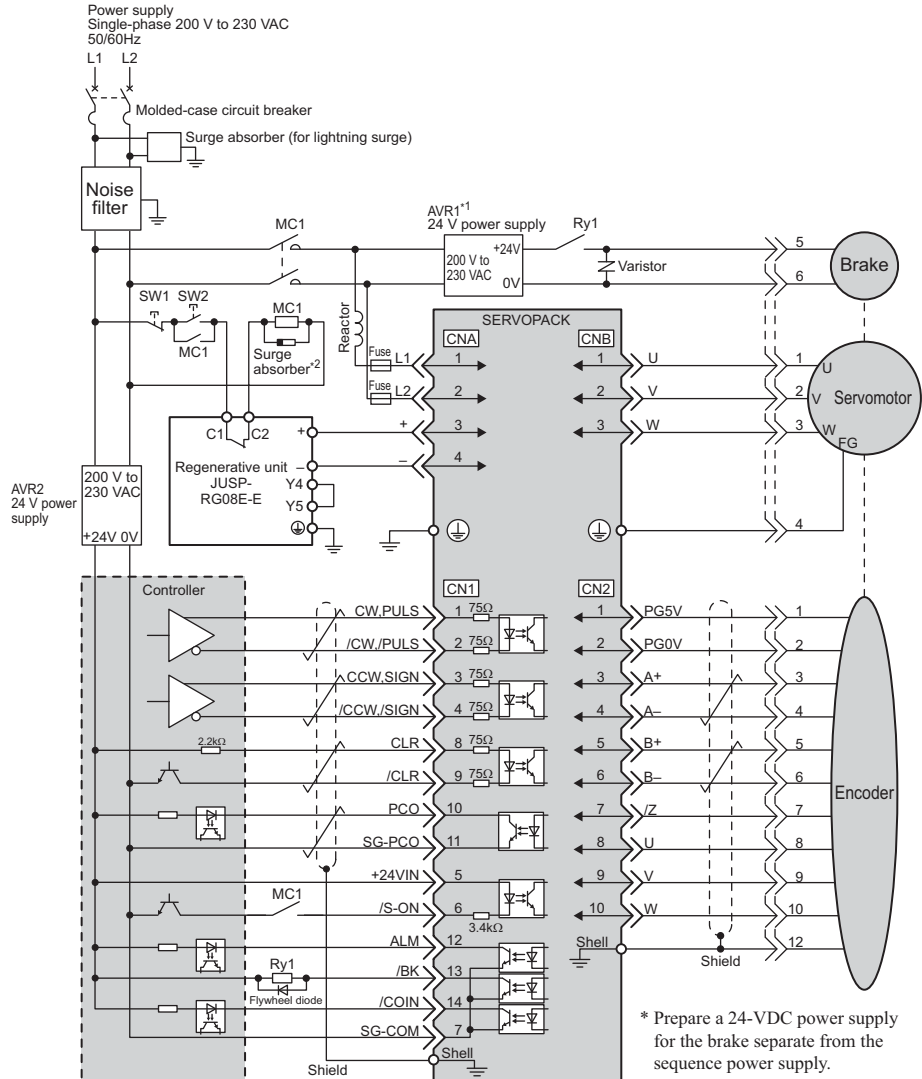

Note: 1. AVR1: 24 VDC power supply for brake  
AVR2: 24 VDC power supply for sequence

SW1: Power OFF switch  
SW2: Power ON switch  
MC1: Magnetic contactor  
Ry1: Brake relay

• Parts example

Surge absorber	Okaya Electric Industries Co., Ltd. CRE-50500 (Sold as: Spark Quencher)
Flywheel diode	Toshiba Corporation 1NH42
Brake relay	OMRON Corporation MY series
Varistor	Nippon Chemi-Con Corporation TNR7V121K

2. The ground protection circuit is designed for ground fault inside the motor windings while the motor is running. Therefore, it may not protect the system under the following conditions.
- A low-resistance ground fault occurs between the main circuit cable and connector for the servomotor.
  - The power supply is turned ON during a ground fault.

To configure a safer system, install an earth leakage breaker for protection against overloads and short-circuiting, or install an earth leakage breaker combined with a wiring circuit breaker for ground protection.

- \* 1. Prepare a 24 VDC power supply for sequence separately from the 24 VDC power supply for brake.
- \* 2. For switching surge

**IMPORTANT**

Configure the relay circuit to apply the holding brake by the emergency stop.

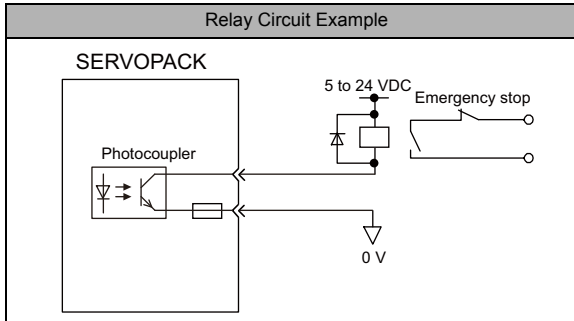

### 3.4 Installation and Wiring Conditions on CE Marking

To adapt a combination of a SJME servomotor and a SJDE SERVOPACK to EMC Directives (EN55011, group 1, class A and EN61000-6-2), the following conditions must be satisfied. After installing the SERVOPACK, do a test run to make sure that the machine operates correctly.

**NOTE**

The actual EMC level may differ depending on the actual system's configuration, wiring, and other conditions.



### 3.4 Installation and Wiring Conditions on CE Marking

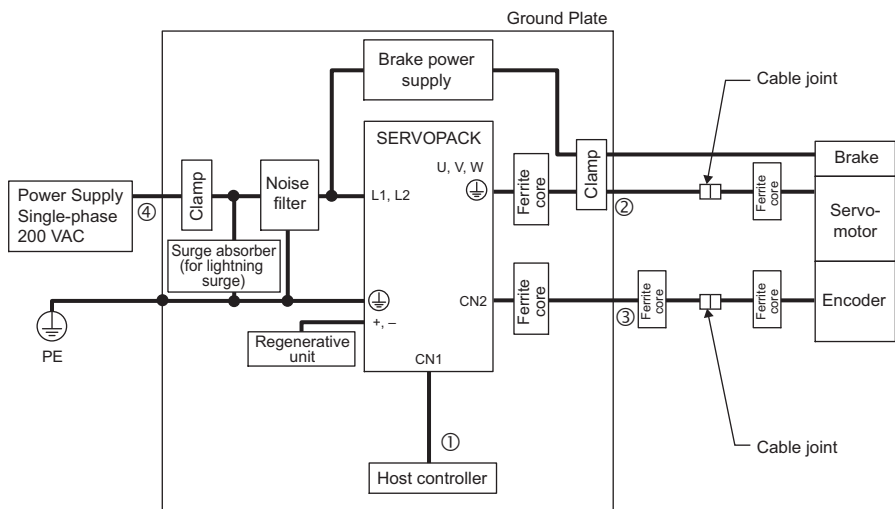

Symbol	Cable Name	Specifications
①	I/O Signals cable	Shield cable
②	Servomotor Main Circuit cable	Shield cable
③	Encoder cable	Shield cable
④	AC Line cable	Shield cable

#### ■ Attaching the Ferrite Core

Coil the motor main circuit cable (as a connection) around the ferrite core with two turns, then attach them by the SERVOPACK. Refer to the diagram in the previous page.

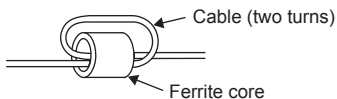

Note: Recommended Ferrite-core  
Model: ESD-SR-25 (Tokin. Corp.)

■ Fixing the Cable

Fix and ground the cable shield using a piece of conductive metal.

- Example of Cable Clamp

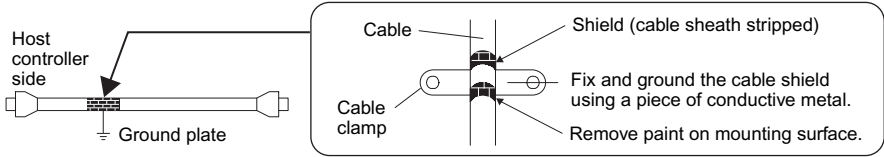

■ Shield Box

A shield box, which is a closed metallic enclosure, should be used for shielding magnetic interference. The structure of the box should allow the main body, door, and cooling unit to be attached to the ground. The box opening should be as small as possible.

3.5 SERVOPACKs and Applicable Peripheral Devices

SERVOPACK Type	Capacity	Power Supply Capacity per SERVOPACK kVA	Current Capacity of Molded-case Circuit Breaker Arms*1*2	Current Capacity and Model of External Fuse	Inrush Current A0-p	Mag-netic Con-tac-tor*3	Noise Filter	Surge Absorber	AC Reac-tor	Rated Voltage V	
										Fuse	MCCB
SJDE-01APA	100 W	0.40	4	0KLK 015.T (15 Arms)	30	HI-11J	FN2070-6/07	R·C·M-601BQZ-4	X5052	250	240
SJDE-02APA	200 W	0.75							X5053		
SJDE-04APA	400 W	1.2	8	FN2070-10/07	X5054						
SJDE-08APA	750 W	2.2	16	0KLK 030.T (30 Arms)	60	HI-15J	FN2070-16/07		X5056		
Manufacturer	-	-	-	Littelfuse Inc.	-	Yaskawa Controls Co., Ltd.	Schaffner Electronic	Okaya Electric Industries Co., Ltd. (Sold as: Surge Protector)	Yaskawa Controls Co., Ltd.	-	-

\* 1. Nominal value at the rated load. The specified derating is required to select the appropriate molded-case circuit breaker.

\* 2. Cut-off characteristics (25 °C): 200 % two seconds min. and 700 % 0.01 seconds min.

Note: 1. The ground protection circuit is designed for ground fault inside the motor windings while the motor is running. Therefore, it may not protect the system under the following conditions.

- A low-resistance ground fault occurs between the main circuit cable and connector for the servomotor.
- The power supply is turned ON during a ground fault.

To configure a safer system, install an earth leakage breaker for protection against over-loads and short-circuiting, or install an earth leakage breaker combined with a wiring circuit breaker for ground protection.

2. It is recommended to use a general-purpose circuit breaker of the rated current 200 mA or more, or a circuit breaker for inverters (for high-frequency).

### 3.6 Main Circuit Wiring

- SJDE SERVOPACKs are suitable where the power supply is less than 5000 Arms (230 V max.).
- SERVOPACKs must be used with UL-listed fuses or circuit breakers, in accordance with the National Electrical Code (NEC).
- Use 75 °C heat-resistant copper wires or an equivalent.

### 3.7 SERVOPACK Main Circuit Wire Size

#### ■ Cable Types

Symbol	Name	Allowable Conductor Temperature
PVC	Normal vinyl cable	–
IV	600 V vinyl cable	60 °C
HIV	Temperature-resistant vinyl cable	75 °C

- Wire sizes are selected for three cables per bundle at 40 °C ambient temperature with the rated current.
- Use cables with a minimum withstand voltage of 600 V for main circuits.
- If cables are bundled in PVC or metal ducts, consider the reduction ratio of the allowable current.
- Use heat-resistant cables under high ambient or panel temperatures where normal vinyl cables will rapidly deteriorate.
- Do not use cables under continuous regenerative state.

#### ■ Cable Size and Allowable Current

The following table shows the wire size and allowable current for three cables. Use a cable whose specifications meet or are less than allowable current in the table.

- 600 V Heat-resistant Vinyl Cables (HIV)

AWG Size	Nominal Cross Section Diameter mm <sup>2</sup>	Configuration Number of wires/mm <sup>2</sup>	Conductive Resistance Ω/mm <sup>2</sup>	Allowable Current at Ambient Temperature A		
				30 °C	40 °C	50 °C
20	0.5	19/0.18	39.5	6.6	5.6	4.5
–	0.75	30/0.18	26.0	8.8	7.0	5.5
18	0.9	37/0.18	24.4	9.0	7.7	6.0
16	1.25	50/0.18	15.6	12.0	11.0	8.5
14	2.0	7/0.6	9.53	23	20	16

Note: The values in the table are only for reference.

#### ■ Power Supply Input Terminals (L1, L2), Motor Connection Terminals (U, V, W), and Regenerative Unit Connection Terminals (+, -)

Capacity W	SERVOPACK Type	Terminal Symbol		
		L1, L2	U, V, W	+, -
100	SJDE-01A	HIV1.25 mm <sup>2</sup>	HIV1.25mm <sup>2</sup> Wiring length: 20 m max.	HIV1.25mm <sup>2</sup> Wiring length: 0.5 m max.
200	SJDE-02A			
400	SJDE-04A	HIV2.0 mm <sup>2</sup>	HIV1.25mm <sup>2</sup> Wiring length: 20 m max.	HIV1.25mm <sup>2</sup> Wiring length: 0.5 m max.
750	SJDE-08A			

Note: Connectors are used for all wiring.

■ Ground Terminal (⊕)

Wire Size	Terminal Screw Size	Tightening Torque
HIV 2.0 mm <sup>2</sup> min.	M4	1.2 to 1.4N·m

■ Encoder Signal Connector

Item	Specifications
Cable	Use Yaskawa specified wires, or shielded twisted-pair wires.
Maximum cable length	20 m
Applicable wires	AWG22 (0.33 mm <sup>2</sup> ) and AWG26 (0.12 mm <sup>2</sup> ) Used AWG22 for the encoder power supply and AWG26 for signal lines.
Finished cable outer diameter	φ9 mm max.

■ I/O Signal Connector

Item	Specifications
Cable	Use twisted-pair wires or shielded twisted-pair wires.
Maximum cable length	3 m
Applicable wires	AWG24 (0.2 mm <sup>2</sup> ), AWG26 (0.12 mm <sup>2</sup> ), AWG28 (0.08 mm <sup>2</sup> )
Finished cable outer diameter	φ8 mm max.

### 3.8 Wiring the Power Supply/Regenerative Unit Connector (CNA)

## ⚠ WARNING

- Observe the following precautions when wiring main circuit connector.
  - Remove the connector from the SERVOPACK prior to wiring.
  - Insert only one wire per terminal opening on the connector.
  - Make sure that the core wire is not electrically shorted to adjacent core wires.

Use the following procedure when connecting the SERVOPACK to the power supply/regenerative unit connector.

**1. Remove the connector from the SERVOPACK.**

Make sure to remove the connector from the SERVOPACK when wiring.

**2. Strip the outer coating.**

Straighten the wire core with your fingers to prevent the wires from unwinding.

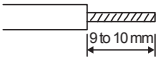

**3. Open the wire terminal on the power supply connector housing (plug) with the tool (lever for wiring) using the procedure shown in Fig. A or B.**

- Insert the connection hook end of the provided tool into the slot as shown in Fig. A. Tool must be purchased by the customer.
- Use a standard flat-blade screwdriver (blade width of 2.5 to 3.0 mm (0.09 to 0.12 in)). Put the blade into the slot, as shown in Fig. B, and press down firmly to open the wire terminal.

Either the procedure shown in Fig. A or B can be used to open the wire insert opening.

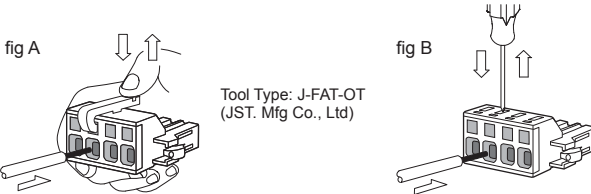

**4. Insert the wire core into the opening and then close the opening by releasing the tool hook or removing the screwdriver.**

■ Wire Size

Item		Wire Size
Conductor Size	Braided wire	AWG14 to AWG22
	Single wire	φ1.6mm to φ0.65mm
Sheath Dimension		φ3.8mm to φ1.7mm

5. Connect the connector to the SERVOPACK.

After wiring the connector, reconnect the connector to the SERVOPACK.

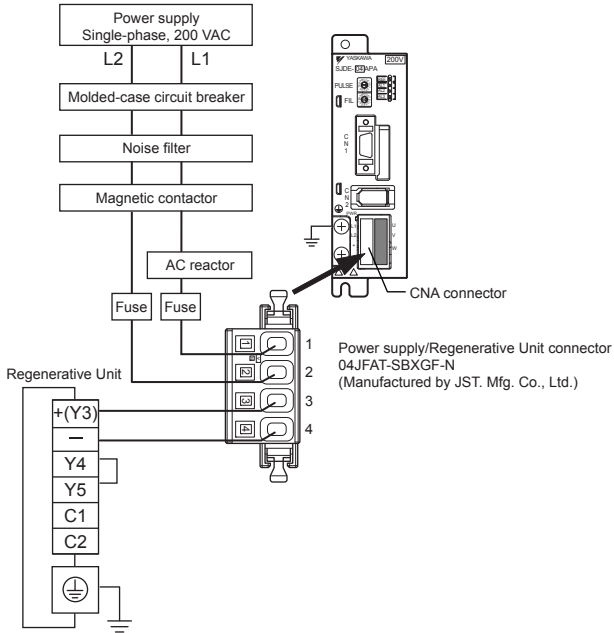

- Note: 1. Pull lightly on the wires to confirm that they are securely connected.  
 2. Be sure that none of the insulating sheaths of the wires are caught in the springs.

■ Connector for Power Supply/Regenerative Unit (CNA)

Pin No.	Symbol	Signal Name
1	L1	Power supply input terminals
2	L2	
3	+	Regenerative unit connection terminals
4	-	

### 3.9 Wiring the Servomotor Main Circuit Cable Connector (CNB)

### 3.9 Wiring the Servomotor Main Circuit Cable Connector (CNB)

Wire the connector for the servomotor main circuit cable (CNB) in the same way as the connector for the power supply/regenerative unit (CNA). Refer to the previous section for details and the procedure.

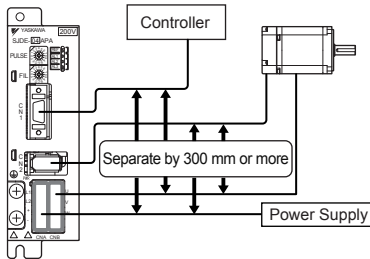

#### IMPORTANT

- The distance between the cable for the servomotor's main circuit and the encoder as well as the I/O cable is 300 mm or more.
- Do not bundle or run the servomotor main circuit cable in the same duct with other cables.
- Be sure that the maximum wiring length of the servomotor main circuit cable is 20 m.

#### ■ Servomotors without Brakes

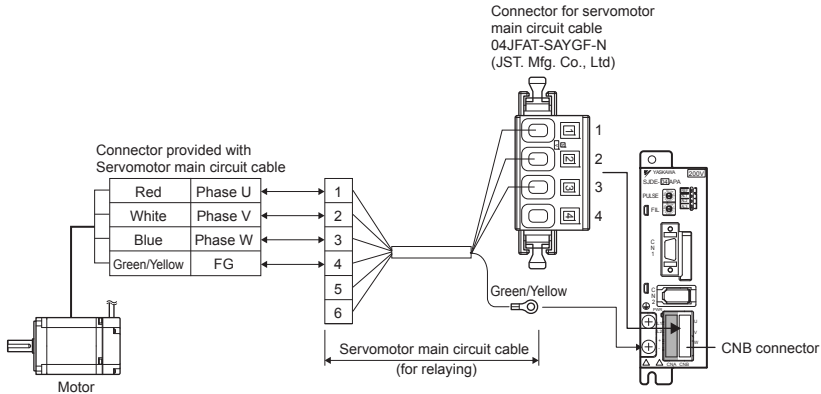

Note: Pin numbers are given on the connector as well. Confirm all pin numbers.

Connection Diagram for Standard Servomotor Main Circuit Cable

If a user-prepared servomotor main circuit cable is used, refer to the following connection diagram for the standard cable (JZSP-CHM000-□□ Cable with Connectors on Both Ends) and wire the servomotor main circuit cable.

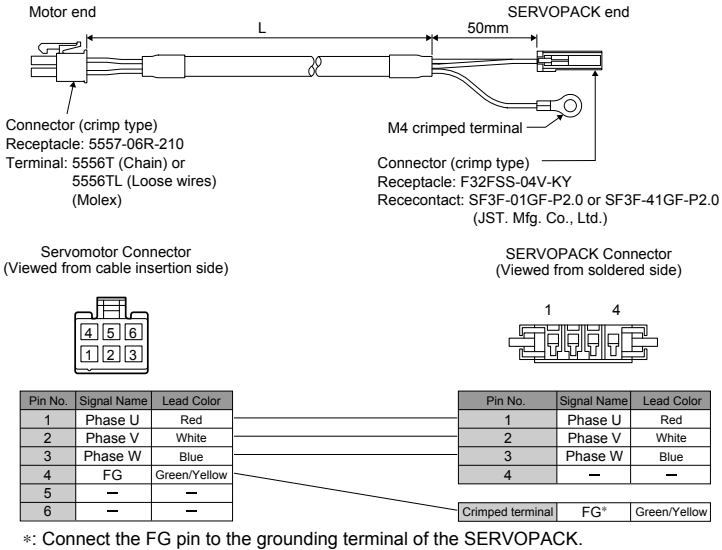

■ Servomotors with Brakes

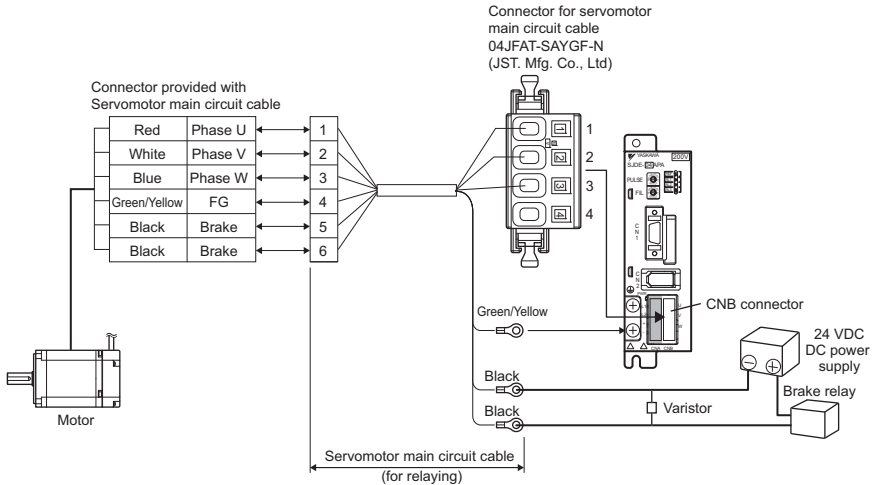

- Note: 1. Prepare a double-insulated 24-VDC power supply.  
 2. Connect the varistor in parallel with the 24-V power supply terminal and GND terminal to suppress the surge voltage resulting from the holding brake turned ON and OFF.  
 3. Pin numbers are given on the connector as well.



### 3.9 Wiring the Servomotor Main Circuit Cable Connector (CNB)

- If using the servomotor to drive a vertical axis, provide a circuit to turn the holding brake ON so that the movable section will not be pulled down by gravity when the power supply of the SERVOPACK is turned OFF.

#### IMPORTANT

Failures caused by incorrect wiring or wrong voltage application in the brake circuit may damage the equipment or cause an accident resulting in death or injury.

Follow the procedures and instructions for wiring and trial operation precisely as described in the manual.

#### Connection Diagram for Standard Servomotor Main Circuit Cable

If a user-prepared servomotor main circuit cable is used, refer to the following connection diagram for the standard cable (JZSP-CHM030-□□ Cable with Connectors on Both Ends) and wire the servomotor main circuit cable.

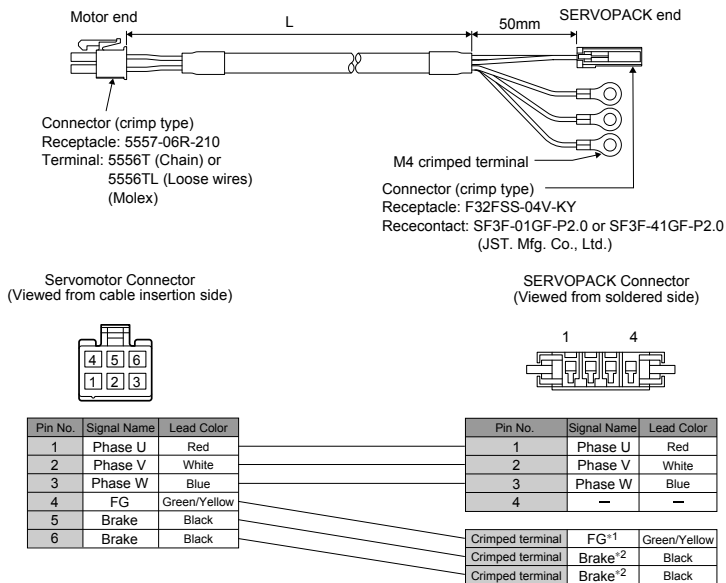

\*1: Connect the FG pin to the grounding terminal of the SERVOPACK.

\*2: No polarity for connection to the brake.

### 3.10 Wiring the Encoder Connector (CN2)

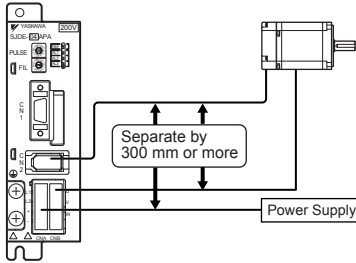

- Separate the encoder cable at least 300 mm from power lines (i.e., high-voltage lines such as the power supply line and servomotor main circuit cable).
- Do not bundle with or run the encode cable in the same duct as power lines.
- Be sure that the maximum wiring length of the encoder cable is 20 m.

#### ■ Connection Diagram for Standard Encoder Cable

If a user-prepared encoder cable is used for relaying, refer to the following connection diagram for the standard cable (JZSP-CHP800-□□ Cable with Connectors on Both Ends) and wire the encoder cable.

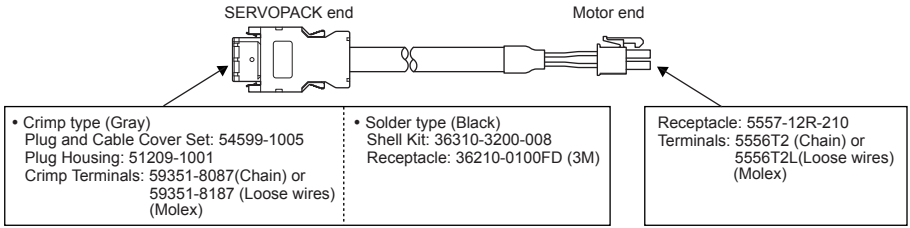

SERVOPACK Connector  
(Viewed from soldered side)

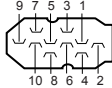

Servomotor Connector  
(Viewed from cable insertion side)

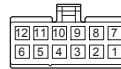

Pin No.	Signal Name	Lead Color
1	PG5V	Red
2	PG0V(GND)	Black
3	Phase A (+)	Blue
4	Phase A (-)	Blue/White
5	Phase B (+)	Yellow
6	Phase B (-)	Yellow/White
7	Phase /Z	Purple
8	Phase U	Gray
9	Phase V	Green
10	Phase W	Orange
Shell	—	Shield

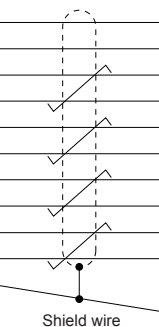

Pin No.	Signal Name	Lead Color
1	PG5V	Red
2	PG0V(GND)	Black
3	Phase A (+)	Blue
4	Phase A (-)	Blue/White
5	Phase B (+)	Yellow
6	Phase B (-)	Yellow/White
7	Phase /Z	Purple
8	Phase U	Gray
9	Phase V	Green
10	Phase W	Orange
11	—	—
12	Shield	Shield

Note: Pin numbers are given on the connector as well.

### 3.11 Wiring I/O Connectors

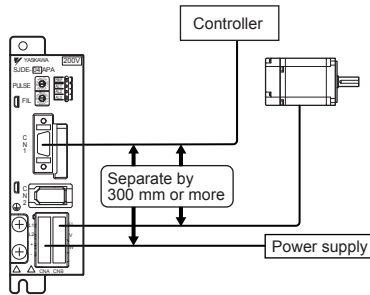

Note: Do not apply excessive force when connecting or disconnecting the cable or the connector. Damage to the cable or connectors may cause the product to stop operating or malfunction.



- Separate the I/O cable at least 300 mm from power lines (i.e., high-voltage lines, such as the power supply line and servomotor main circuit cable).
- Be sure that the maximum wiring length of the I/O cable is 3 m.
- The longer the I/O cable is, the lower the maximum transmission frequency will be.

#### ■ Connection Diagram for Standard I/O Cable

If a user-prepared I/O cable is used for relaying, refer to the following connection diagram for the standard cable (JZSP-CHI003-□□ Cable with Connector) and wire the encoder cable.

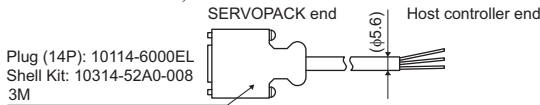

SERVOPACK Connector (Plug)  
(Viewed from soldered side)

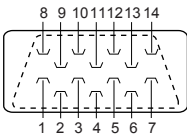

Pin No.	I/O	Code	Signal Name	Lead Color	Dot Mark		
					Number	Color	
1	Input	CW, PULS	Reverse pulse, Reference pulse	Orange	1	Black	
2	Input	/CW, /PULS				Red	
3	Input	CCW, SIGN	Forward pulse, Reference sign	Light gray		Black	
4	Input	/CCW, /SIGN				Red	
5	Input	+24VIN	External input power supply	White	Black		
6	Input	/S-ON	Servo ON			Red	
7	Output	SG-COM	Output signal ground	Yellow	Black		
8	Input	CLR	Position deviation Pulse clear			Pink	Red
9	Input	/CLR		Black			
10	Output	PCO	Phase-C signal	Orange	Red		
11	Output	SG-PCO	Phase-C signal ground				
12	Output	ALM <sup>*1</sup>	Servo alarm	Orange	2	Black	
13	Output	/BK <sup>*2</sup>	Brake			Light gray	Red
14	Output	/COIN <sup>*3</sup>	Positioning completion			Black	Red
Shell	-	-	FG	-		-	-

\* 1. If an alarm occurs, the servo alarm signal (ALM) turns OFF to open the circuit.  
 \* 2. When the brake signal (/BK) turns ON to close the circuit, the brake is released.  
 \* 3. After positioning is completed, the positioning completion signal (/COIN) turns ON to close the circuit.

Note: Pin numbers are given on the connector as well.

### 3.12 Connection Examples of Input Signal

#### Line Driver Output

Applicable line driver: SN75174 or MC3487 (Manufactured by Texas Instruments or equivalent)

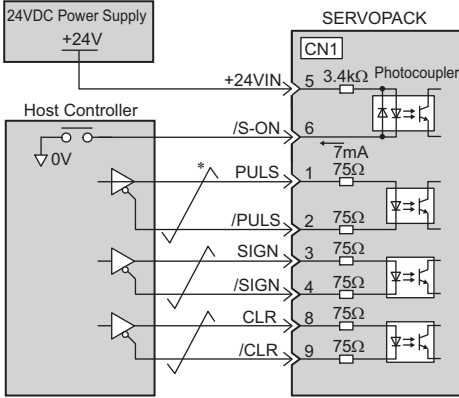

\* Twisted-pair wires

#### Open-collector Output

Set the current limit resistors R1 through R3 so that the input current (i) will be within the following range.  
Input Current (i) = 7 mA to 15 mA

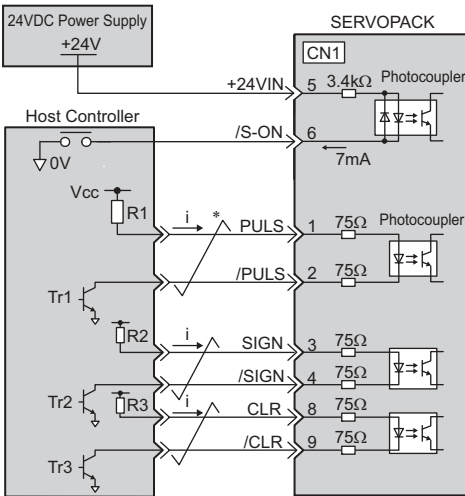

\* Twisted-pair wires

Examples:

- When Vcc is +24V: R1 through R3=2.2 kΩ
- When Vcc is +12V: R1 through R3=1 kΩ
- When Vcc is +5V: R1 through R3=180 Ω

Note: The following signal logic applies for an open-collector output.

Tr1 to Tr3 ON	Equivalent to high level input.
Tr1 to Tr3 OFF	Equivalent to low level input.

### 3.13 Connection Example of Output Signal

Set the load so that the output current (i) will fall within 50 mA or less.

Photocoupler output (Per output signal)

- Max. voltage: 30VDC
- Max. current: 50mADC

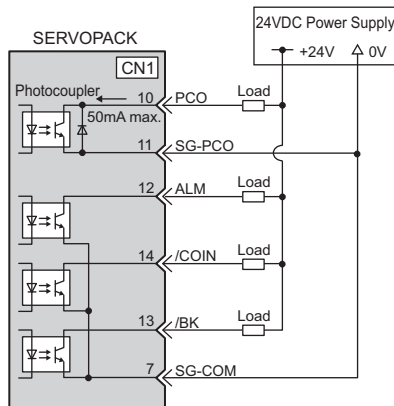

---

**IMPORTANT**

Incorrect wiring or wrong voltage application in the output circuit may cause short-circuit.

---

## 3.14 EMG Sequence

## ⚠ WARNING

- Make the emergency stop circuit to turn OFF the Servo ON signal as well as the main circuit power supply when the EMG (emergency stop) signal turns ON.

The residual voltage rotates the servomotor for a few seconds after the power supply has turned OFF, which may result in injury or damage to the equipment.

### IMPORTANT

- Use the power ON/OFF signals or the servo ON/OFF signals only when necessary to turn the servomotor's power supply ON or OFF.  
Failure to observe this caution may result in unpredictable performance of the servomotor.

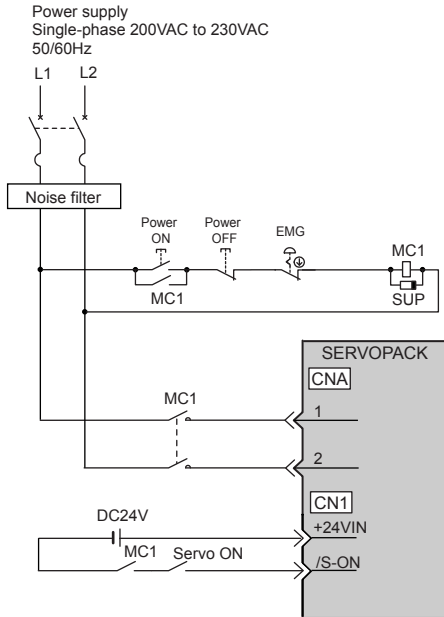

### 3.15 Explanation of I/O Signals

Pulse train references are given to control the position of the servomotor. The following pulse train output forms are supported from the host controller.

- Line driver output
- +24-V open-collector output
- +12-V open-collector output
- +5-V open-collector output

#### I/O Signal Timing Examples

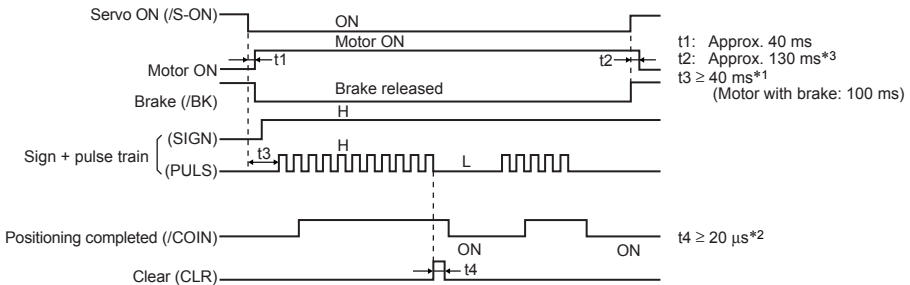

- \* 1. The interval from when the servo ON signal is turned ON until the reference pulse is input must be at least 40 ms, or the reference pulse may not be received by the SERVOPACK. If a motor with a brake is in used, more time will be required to release the brake. Therefore, provide an interval of at least 100 ms.
- \* 2. The error counter clear signal must be ON for at least 20  $\mu$ s. If the reference pulse is stopped when the clear signal is turned ON, the motor will stop at that position.
- \* 3. The lag time for the brake is 100 ms. Use a relay for brakes with an operating time of 30 ms or less.

Note: 1. The maximum lag time from the time that the error or fault is detected until the time that the alarm signal is turned ON is 2 ms.

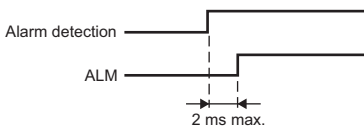

- 2. If using the phase-C output signal, use an edge when the signal changes from OFF to ON at the start, so that the wave form will rise after a set time lag.

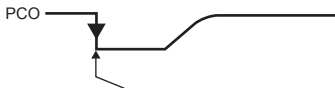

**IMPORTANT**

Failures caused by incorrect wiring or wrong voltage application in the brake circuit may damage the equipment or cause an accident resulting in death or injury. Follow the procedures and instructions for wiring and trial operation precisely as described in the manual.

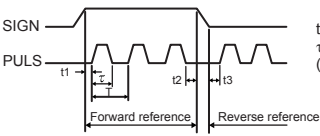
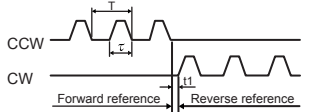
Reference Pulse Signal Form	Electrical Specifications	Remarks
Sign + pulse train input (SIGN + PULS signal)  Maximum reference frequency: 750 kpps (187.5 kpps for an open-collector output)	 <p> <math>t_1, t_2, t_3 &gt; 3\mu\text{s}</math>  <math>\tau \geq 0.65\mu\text{s}</math>  <math>(\tau/T) \times 100 \leq 50\%</math> </p>	Sign (SIGN): High = Forward reference Low = Reverse reference
CW pulse + CCW pulse  Maximum reference frequency: 750 kpps (187.5 kpps for an open-collector output)	 <p> <math>t_1 &gt; 3\mu\text{s}</math>  <math>\tau \geq 0.65\mu\text{s}</math>  <math>(\tau/T) \times 100 \leq 50\%</math> </p>	—



# 4 Trial Operation

**IMPORTANT**

Failures caused by incorrect wiring or wrong voltage application in the brake circuit may damage the equipment or cause an accident resulting in death or injury. Follow the procedures and instructions for wiring and trial operation precisely as described in the manual.

Use the following procedure to perform trial operation.

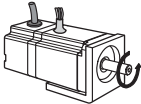
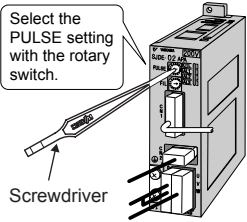
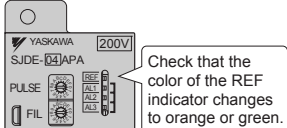
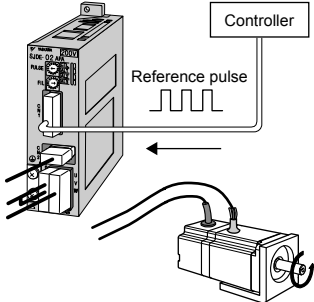
Step	Details
<p>1. Installation</p> 	<ul style="list-style-type: none"> <li>• Install the SERVOPACK and servomotor under the installation conditions. Do not connect the servomotor shaft to the machine.</li> </ul>
<p>2. Wiring and PULSE Settings</p> 	<ul style="list-style-type: none"> <li>• Wire the power supply connector, servomotor main circuit cable, encoder cable, and the I/O signal cable correctly following the procedures in Section 3.</li> <li>• If a servomotor with a brake is used, connect all signal cables including those for the brake power supply and the relay.</li> <li>• Use the PULSE rotary switch to select the type of controller's output pulse and set the resolution of the servomotor.</li> </ul> <p>Note: Use the screwdriver to change the setting on the rotary switch. Never use the screwdriver for any purpose other than setting the rotary switch.</p>
<p>3. LED Check</p> 	<ul style="list-style-type: none"> <li>• Turn ON the power and confirm that the REF indicator is lit orange or green. If the indicator is orange, turn ON the servo ON (S-ON) input signal and check that the color of the REF indicator changes from orange to green.</li> <li>• If the REF indicator is not orange or green, or the indicator of the AL1, AL2 or AL3 alarm is red, refer to Section 5 Troubleshooting and clear the alarm.</li> </ul>
<p>4. PULSE Reference Input 1</p> 	<ul style="list-style-type: none"> <li>• Input the reference pulse from the controller, and then check on the number of the pulses and servomotor's rotational direction. Make sure the servomotor rotates in the correct direction while the REF indicator is blinking green.</li> <li>• If the servomotor does not rotate according to the reference, refer to Section 5 Troubleshooting and clear the alarm.</li> </ul>

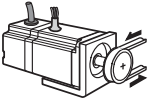
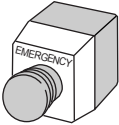
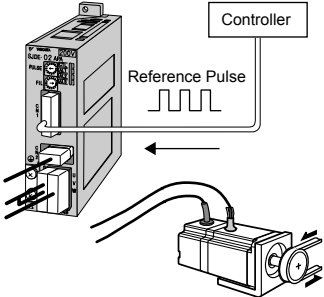
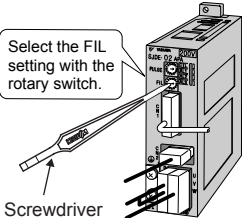
Step	Details
<p>5. Servomotor Shaft Coupling</p> 	<ul style="list-style-type: none"> <li>Set the servomotor to servo OFF (servomotor OFF) status to turn OFF the power. Couple the servomotor shaft to the machine under the conditions outlined in the servomotor instructions.</li> </ul>
<p>6. Protective Functions</p> 	<ul style="list-style-type: none"> <li>Turn ON the power, activate the servo ON (S-ON) input signal, and check that the color of the REF indicator changes from orange to green. The machine may momentarily make a sound after the servo is turned ON. This is due to the setting of the automatic filter in the servo and is not an error.</li> <li>Check that all the protective functions, such as the emergency stop and holding brake functions are working correctly.</li> </ul>
<p>7. PULSE Reference Input 2</p> 	<ul style="list-style-type: none"> <li>Input the reference pulse from the controller, and then check that the machine is running in the correct direction and at the correct rate designed by the settings. The machine may momentarily make a sound after the machine moves. This is due to the setting of the automatic filter in the servo and is not an error.</li> </ul>
<p>8. Filter Settings</p>  <p>Select the FIL setting with the rotary switch.</p> <p>Screwdriver</p>	<ul style="list-style-type: none"> <li>If the machine vibrates or if the positioning completed signal (/COIN) repeatedly turns ON and OFF after the servomotor stops, turn the FIL rotary switch from 0 to 1, and then to 0 again. If the machine still vibrates, gradually increase the setting on the FIL rotary switch from 0 to 7 until the optimum setting is reached.</li> </ul> <p>Note: Use the screwdriver to change the setting on the rotary switch. Never use the screwdriver for any purpose other than setting the rotary switch.</p>

## 5 Troubleshooting

If the servomotor does not operate correctly due to setting failures, wiring faults, or other problems, refer to this section and take corrective actions. Contact your Yaskawa representative if the problem cannot be solved by the corrective actions described here.









When taking a corrective action, turn OFF the power, remove the cause of the alarm, and then turn ON the power again.

### 5.1 Alarm Indicator Lights

Alarm Display	Alarm Name	Conditions at Alarm Occurrence	Cause	Corrective Action
AL1 <input checked="" type="checkbox"/> AL2 <input type="checkbox"/> AL3 <input type="checkbox"/>	Speed error	Power was turned ON.	A SERVOPACK fault occurred.	Replace the SERVOPACK.
		Servo was turned ON.	Phases U, V, and W in the servomotor are wired to the wrong terminals.	Correct the servomotor wiring.
			The encoder wiring is incorrect.	
			Malfunction occurred due to noise interference in the encoder wiring.	Take measures against noise for the encoder wiring.
			A SERVOPACK fault occurred.	Replace the SERVOPACK.
		Servomotor operation was started or was switched to high-speed operation.	Phases U, V, and W in the servomotor are wired to the wrong terminals.	Check and correct the servomotor wiring.
			The encoder wiring is incorrect.	
			Malfunction occurred due to noise interference in the encoder wiring.	Take measures against noise for the encoder wiring.
			The position pulse reference input has exceeded 10,000 pulses per revolution.	Input the correct reference value.
				A SERVOPACK fault occurred.













Alarm Display	Alarm Name	Conditions at Alarm Occurrence	Cause	Corrective Action	
AL1 <input type="checkbox"/> AL2 <input checked="" type="checkbox"/> AL3 <input type="checkbox"/>	Overload	Power was turned ON.	A SERVOPACK fault occurred.	Replace the SERVOPACK.	
		Servo was turned ON.	Servomotor main circuit cable wiring is incorrect or a contact in servomotor wiring is faulty.	Check and correct the servomotor wiring.	
			Encoder cable wiring is incorrect or a contact in encoder wiring is faulty.		
			A SERVOPACK fault occurred.	Replace the SERVOPACK.	
		The servomotor did not operation for a reference input from the controller.	Servomotor main circuit cable wiring is incorrect or a contact in servomotor wiring is faulty.	Check and correct the servomotor wiring.	
					Encoder cable wiring is incorrect or a contact in the cable is faulty.
			The starting torque exceeds the maximum torque.	Reconsider and correct the load, operating conditions, and servomotor capacity.	
			A SERVOPACK fault occurred.	Replace the SERVOPACK.	
		AL1 <input type="checkbox"/> AL2 <input checked="" type="checkbox"/> AL3 <input type="checkbox"/>	Normal operation.	The effective torque continued over the period of the rated torque, or the starting torque greatly exceeds the rated torque.	Reconsider the load and operation conditions.
					Reconsider the servomotor capacity and use a servomotor with a larger capacity.
Drop in power supply voltage.	Make sure that the power supply voltage is within the permissible range.				
The servomotor coil burned out.	Measure the coil resistance. If the coil burned out, replace the servomotor.				
The servomotor was operated with the holding brake engaged.	Measure the voltage of the brake terminals and release the brake.				
The ambient temperature around the servomotor exceeded 55 °C.	Reconsider the installation conditions so that the ambient temperature will be 55 °C or less.				
				The installation conditions of the SERVOPACK are not suitable (the SERVOPACK is influenced by the mounting direction, mounting space, or ambient objects).	
A SERVOPACK fault occurred.	Replace the SERVOPACK.				
Servo OFF status.	The servomotor did not stop three seconds after the SERVOPACK is set to servo OFF status.			Reconsider the load conditions.	
		Check to see if the servomotor is being rotated by an external force.			

## 5.1 Alarm Indicator Lights

Alarm Display	Alarm Name	Conditions at Alarm Occurrence	Cause	Corrective Action
AL1  AL2  AL3 	Encoder error	Power was turned ON or during servomotor operation.	The encoder wiring and the contact are incorrect.	Correct the encoder wiring.
			Noise interference occurred due to incorrect encoder cable specifications.	Use twisted-pair or shielded twisted-pair cables with a core of at least 0.12 mm <sup>2</sup> .
			Noise interference occurred because the wiring distance for the encoder cable is too long.	The wiring distance must be 20 m maximum.
			The encoder cable is disconnected.	Replace the encoder cable.
			An zero point error occurred.	Replace the servomotor.
			An encoder fault occurred.	
AL1  AL2  AL3 	Voltage error	Power was turned ON.	The AC power supply voltage exceeded the permissible range.	Make sure the AC power voltage is within the specified range.
			The power supply was turned ON again before the power supply to the SERVOPACK was completely OFF.	Wait until the REF indicator is OFF, and turn ON the power supply again.
			A SERVOPACK fault occurred.	Replace the SERVOPACK.
		Normal operation.	The AC power supply voltage exceeded the permissible range.	Make sure the AC power voltage is within the specified range.
			The servomotor speed is high and load moment of inertia is excessive.	Reconsider the load and operation conditions.
			The regenerative unit is not connected or the selection of the regenerative unit is wrong.	Calculate the regenerative energy and connect a regenerative unit with sufficient processing capacity.
			A SERVOPACK fault occurred.	Replace the SERVOPACK.

Alarm Display	Alarm Name	Conditions at Alarm Occurrence	Cause	Corrective Action
AL1 <input checked="" type="checkbox"/>	Overcurrent	Power was turned ON or during servomotor operation.	Phases U, V, and W in the servomotor are wired to the wrong terminals.	Check and correct the servomotor wiring.
AL2 <input type="checkbox"/>			The ground wire is caught on other terminals.	
AL3 <input checked="" type="checkbox"/>			<ul style="list-style-type: none"> <li>• A short circuit occurred between ground and U, V, or W of the servomotor main circuit cable.</li> <li>• A short circuit occurred between phase U, V, or W of the servomotor main circuit cable.</li> </ul>	Correct the servomotor circuits or cable. Replace the servomotor. Note: Before turning ON the power supply, make sure that the circuit is correctly grounded without a short circuit.
			The Regenerative Unit is wired incorrectly.	Check and correct the wiring.
			A short circuit occurred between ground and U, V, or W of the SERVOPACK.	Replace the SERVOPACK.
			<ul style="list-style-type: none"> <li>• A short circuit occurred between ground and U, V, or W of the servomotor.</li> <li>• A short circuit occurred between phase U, V, or W of the servomotor.</li> </ul>	Replace the servomotor.
			The load is excessive or beyond the capacity of regeneration processing.	Reconsider and correct the load and operating conditions.
			The installation conditions of the SERVOPACK are not suitable (the SERVOPACK is influenced by the mounting direction, mounting space, or ambient heat).	Reconsider the installation conditions so that the ambient temperature will be 55 °C or less.
			The servomotor is operating in excess of the rated output.	Reduce the load.
			The built-in cooling fan of the SERVOPACK stopped operating.	Replace the cooling fan.
			The SERVOPACK and servomotor capacities do not match each other.	Refer to the catalog and select the proper combination of SERVOPACK and servomotor capacities.
			A SERVOPACK fault occurred.	Replace the SERVOPACK.
	The servomotor burned out.	Check the balance of the resistance between servomotor phases. If there is any unbalance, replace the servomotor.		

## 5.1 Alarm Indicator Lights

Alarm Display	Alarm Name	Conditions at Alarm Occurrence	Cause	Corrective Action
AL1  AL2  AL3 	SERVO- PACK built-in fan stopped.	Power was turned ON or during servo- motor opera- tion.	The cooling fan built into the SERVOPACK stopped.	Refer to Section 6 and replace the cooling fan.
			The air inlet of the cooling fan is blocked with dirt or other foreign matter.	Inspect the cooling fan.
AL1  AL2  AL3 	System error	Power was turned ON.	A SERVOPACK fault occurred.	<ul style="list-style-type: none"> <li>• Replace the SERVOPACK.</li> <li>• Contact your Yaskawa rep- resentative.</li> </ul>
AL1   AL2    AL3   Flashing at regular intervals.	Refer- ence pulse set- ting rotary switch (PULSE) changed	Power was turned ON or during servo- motor opera- tion.	-	Turn ON the power again. (The operation of the servo- motor can continue during display of this alarm.)

## 5.2 Troubleshooting for Malfunctions when Alarm Indicators Are Not Lit

Troubleshooting for malfunctions that occur with the servomotor even though the alarm indicators do not light are listed below. Perform the appropriate corrective actions accordingly.

■ : Take corrective actions for the shaded items only after turning the servo system OFF.

Problem	Cause	Inspection Items	Corrective Action
PWR indicator does not light when power is turned ON.	The wiring of the power cable is incorrect.	Check the power supply to be sure it is within the permissible voltage range.	Set the power supply input within the permissible power supply voltage range.
		Check the wiring of the power supply input.	Correct the wiring.
		Check the connection cable for the regenerative unit is correctly wired.	—
Servomotor does not rotate for reference input from the controller.	The servo ON (/S-ON) input is OFF.	Check to see if the REF indicator is lit green.	Turn ON the servo ON signal or wire the servomotor correctly if the REF indicator is lit orange.
	The reference pulse settings are incorrect.	Check to see if the REF indicator is flashing.	Wire the servomotor correctly or set the pulse type of the SERVOPACK according to the reference pulse type of the controller if the REF indicator is not lit.
		Check the reference pulse types of the controller and the SERVOPACK.	Set the pulse type of the SERVOPACK according to the reference pulse type of the controller.
	The wiring of the servomotor main circuit cable is incorrect.	Check the wiring.	Correct the wiring.
	The wiring of the encoder cable is incorrect		
	The wiring of the I/O signal (connector CN1) is incorrect.	Check the wiring of the reference pulse.	Correct the wiring.
		Check the reference pulse type.	Set the pulse type of the SERVOPACK according to the reference pulse type of the controller.
		Check the voltage of the reference pulse.	Connect a resistor according to the voltage.
	The power is not turned ON.	Check the power supply and the status of PWR indicator.	Turn ON the power.
		Check the voltage between the power supply terminals.	Correct the power ON circuit.
Both CW input and CCW input are ON simultaneously.	Check the wiring of the reference pulses.	<ul style="list-style-type: none"> <li>• Input either the CW pulse signal or CCW pulse signal.</li> <li>• Be sure to turn OFF all terminals with no input signals.</li> </ul>	
A SERVOPACK fault occurred.	—	Replace the SERVOPACK.	



## 5.2 Troubleshooting for Malfunctions when Alarm Indicators Are Not Lit

Problem	Cause	Inspection Items	Corrective Action
Servomotor turns for a moment and stops.	The wiring of the servomotor main circuit cable and encoder cable is incorrect.	Check the order of phases U, V, and W in the servomotor main circuit cable and the wiring of the encoder cable.	Correct the wiring.
Servomotor turns even without a reference.	The reference pulse input is not correct.	Check the reference pulse type.	Set the suitable reference pulse type.
		Check the voltage of the reference pulse.	Connect a resistor according to the voltage.
	The SERVOPACK is faulty.	–	Replace the SERVOPACK.
Servomotor turns in the wrong direction.	The CW and CCW inputs are connected backward.	Check the reference pulse types of the controller and the SERVOPACK.	Connect the CW pulse signal to the CW input and the CCW pulse signal to the CCW input.
Servomotor operation is not stable.	The servomotor main circuit cable or encoder cable is not wired correctly.	Check the wiring of the servomotor main circuit cable phases U, V, and W and the encoder cable.	Wire the cables correctly.
	Misalignment of the coupling connecting the servomotor shaft and machine, loose screws, or load torque changes resulting from pulley and gear engagement.	Check the coupling to the machine system.	Review and adjust the machine.
		Operate the servomotor with no load (i.e., disconnect the servomotor from the machine).	
	The load moment of inertia exceeds the permissible value of the SERVOPACK.	Operate the servomotor with no load (i.e., disconnect the servomotor from the machine).	Reduce the load.
	The connection of the pulse signal wires is incorrect.	Check the wiring of the pulse signal wires of the host controller and SERVOPACK.	Replace the servomotor and SERVOPACK with ones with higher capacities.
Check the reference pulse types of the controller and the SERVOPACK.		Correct the wiring.	
Motor overheated	The ambient temperature around the servomotor is too high.	Be sure that the ambient temperature around the servomotor is 40 °C or less.	Reconsider the installation conditions so that the ambient temperature will be 40 °C or less. Cool down the servomotor with a fan or cooler.
	The ventilation is obstructed.	Check to see if ventilation is obstructed.	Provide good ventilation.
	The servomotor is overloaded.	Operate the servomotor with no load (i.e., disconnect the servomotor from the machine).	Reduce the load.
Replace the servomotor and SERVOPACK with ones with higher capacities.			
The holding brake does not work.	The holding brake power is turned ON.	Check to see if the holding brake power is turned ON.	Design the circuit so that the holding brake is turned OFF when the holding brake needs to hold the load when the servomotor comes to a stop.

Problem	Cause	Inspection Items	Corrective Action
Servomotor does not stop operation smoothly or at all when servo is turned OFF.	The servomotor is overloaded.	Check to see if the load is excessive or the servomotor speed is too high.	Reconsider the load conditions and replace the SERVOPACK.
	A stop circuit fault occurred.	—	Replace the SERVOPACK.
Abnormal noise from Servomotor or machine vibrates.	Mounting not secured.	Check to see if there are any loose mounting screws.	Tighten the mounting screws.
		Check to see if the coupling is misaligned.	Align the coupling.
		Check to see if the coupling is unbalanced.	Balance the coupling.
	Defective bearings	Check for the noise and vibration around the bearings.	If there is a fault, contact your Yaskawa representative.
	Vibration source on the driven machine	Foreign matter, looseness, or deformation on the machine movable section.	(Contact the machine manufacturer.)
	Noise interference due to incorrect input signal cable specifications.	Be sure that the twisted-pair or shielded twisted-pair cable with a core of at least 0.08 mm <sup>2</sup> is used.	Use the specified input signal cables.
	Noise interference because the input signal cable is longer than the applicable range.	The wiring distance must be 3 m max.	Shorten the wiring distance for input signal cable to 3 m or less.
	Noise interference because the encoder cable specifications are incorrect.	Check to see if a shielded twisted-pair cable with a core of at least 0.12 mm <sup>2</sup> is being used.	Use a cable that meets the encoder cable specifications.
	Noise interference because the encoder cable is longer than the applicable range.	Check the length of the encoder cable.	The wiring distance must be 20 m or less.
	Noise is entering the encoder cable because the sheath is damage.	Check to see if the encoder cable is damaged.	Modify the encoder cable layout so the cable is not subjected to surge.
	Excessive noise interference on encoder cable.	Check to see if the encoder cable is bundled with high-current lines or near high-current lines.	Install a surge absorber (for lightning surge) on the encoder cable.
	FG potential varies due to the influence of machines such as a welder at the servomotor.	Check to see if the machine is correctly grounded properly.	Ground the machine separately from the PG's FG.
	Excessive vibration and shock on the encoder.	Vibration from the machine occurred or servomotor installation is incorrect. (Mounting surface accuracy, securing, alignment, etc.)	Reduce vibration from the machine or secure the servomotor.
The filter setting is improper.	Check the set value on the reference filter (FIL) rotary switch.	Increase the set value on the reference filter (FIL) rotary switch.	

## 6 Inspections

### 6.1 Regular Inspections

For inspection and maintenance of the SERVOPACK, follow the inspection procedures in the following table at least once every year. Other routine inspections are not required.

Item	Frequency	Procedure	Comments
Exterior	At least once a year	Check for dust, dirt, and oil on the surfaces.	Clean with cloth or compressed air.
Loose Screws		Check for loose connector screws.	Tighten any loose screws.

### 6.2 Part's Life Expectancy

The following electric or electrical parts are subject to mechanical wear or deterioration over time.

If an unusual noise or vibration occurs, refer to the life expectancy table and contact your Yaskawa representative. After examining the part in question, we will determine whether the parts should be replaced or not. When the part has expired before the expected time, further inspection will be required.

Part	Life Expectancy	Comments
Cooling Fan	30,000 hours	Life depends on operation conditions. Check that there is no unusual noise or vibration.

Note: 1. The life expectancy listed in the table is a reference period that may be affected by the environmental and operating conditions.

2. The recommended models of the replacement cooling fans are:

SERVOPACK	Model	Manufacturer
SJDE-01 to 04	JZSP-CHF08-1	Sun-Wa Technos Co., Ltd. <a href="http://www.sunwa.co.jp/">http://www.sunwa.co.jp/</a>
SJDE-08	JZSP-CHF08-2	

## 6.3 Replacement of Cooling Fan

### ⚠ WARNING

- Do not open the SERVOPACK case for five minutes after the LED (PWR) is turned OFF. Residual voltage may cause electric shock.
- Disconnect all power and wait at least 15 minutes before replacing the cooling fan. Failure to observe this caution may cause burns due to heatsink's high temperature.
- Be sure that the cooling fan is positioned in the correct direction when it is installed. Failure to observe this caution may result in the malfunction of the SERVOPACK.

## SERVOPACKs of 100 to 400 W

## 1. Open the case of the SERVOPACK.

Insert the tip of a straight-edge screwdriver into the three notches on the SERVOPACK one by one and pry the case off.

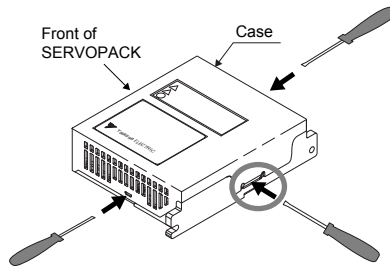

## 2. Lift up to remove the case.

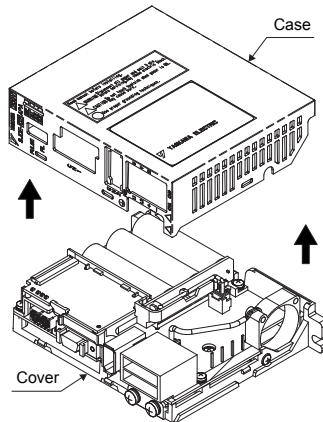

## 6.3 Replacement of Cooling Fan

3. Disconnect the cable of the cooling fan from the fan connector on the SERVOPACK.

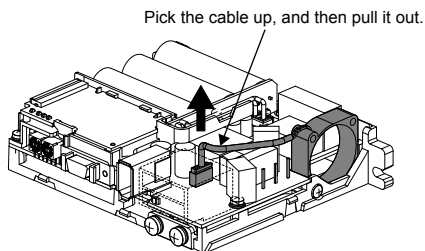

4. Unscrew the cooling fan and remove it.

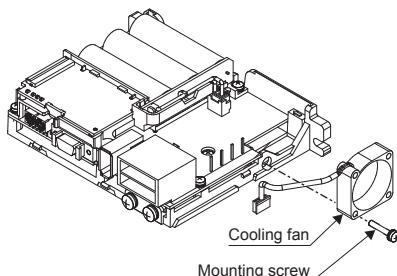

5. Install the new cooling fan.  
(Type: JZSP-CHF08-1)

CAUTION: Before installing the new cooling fan, make sure that the arrow on the heatsink and the arrow on the fan face the same direction as shown in the diagram.

6. Secure the new cooling fan on the SERVOPACK with mounting screws.

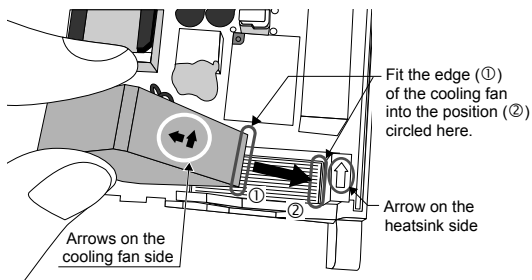

7. Connect the cooling-fan cable to the fan connector on the SERVOPACK.

CAUTION: Make sure that the wiring layout of the cable matches that shown in the diagram.

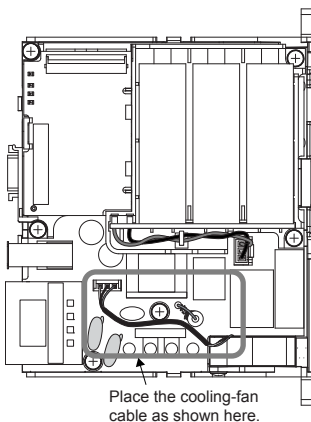

8. Reattach the case and cover to the SERVOPACK in their original positions.

## 750 W SERVOPACKs

1. Open the case of the SERVOPACK.

Insert the tip of a straight-edge screwdriver into the three notches on the case and the two on the cover on the SERVOPACK one by one and pry the case off.

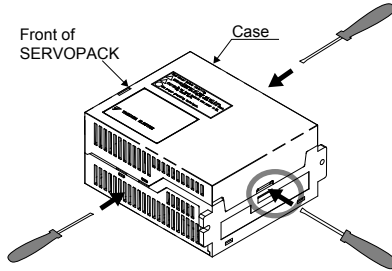

2. Pull the case and the cover off of the SERVOPACK.

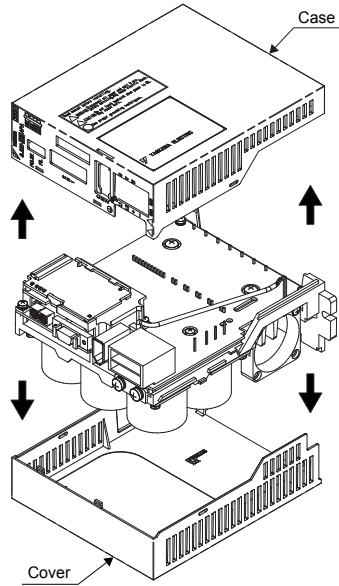

3. Disconnect the cable of the cooling fan from the fan connector on the SERVOPACK.

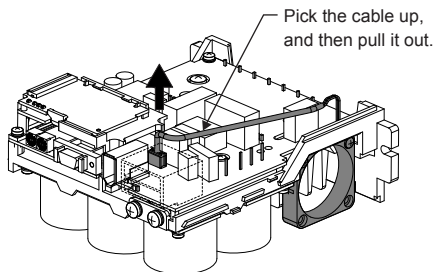

## 6.3 Replacement of Cooling Fan

- Remove the two mounting screws of the cooling fan.

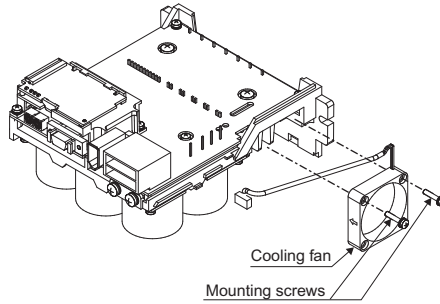

- Install the new cooling fan.  
Thread the cooling-fan cable through the opening (C) as shown in the diagram A.

**CAUTION:** Make sure that the arrow on the heatsink and the arrow on the fan face the same direction as shown in the diagram B.

Diagram A

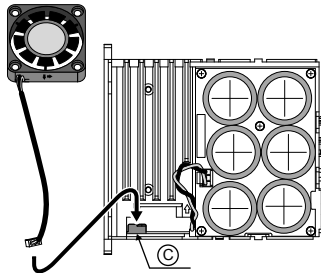
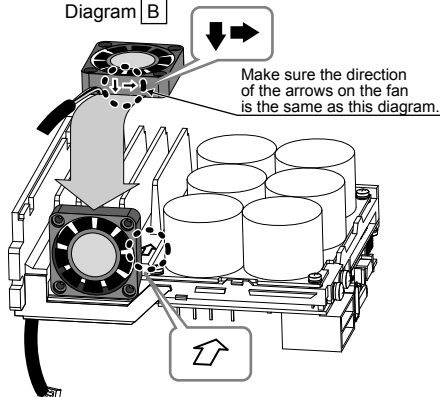

Diagram B



- Secure the fan on the SERVOPACK with mounting screws.

- Turn the SERVOPACK over, and then connect the cooling-fan cable to the fan connector on the SERVOPACK.

**CAUTION:** Make sure that the wiring layout of the cable matches that shown in the diagram.

- Reattach the case and cover to the SERVOPACK in their original positions.

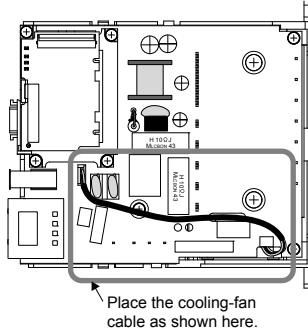



# 7 Specifications

## 7.1 Specifications

SERVOPACK model SJDE-		01APA	02APA	04APA	08APA
Max. applicable servomotor capacity [kW]		0.1	0.2	0.4	0.75
Continuous output current [Arms]		0.84	1.1	2.0	3.7
Instantaneous max. output current [Arms]		2.5	3.3	6.0	11.1
Input power supply (for main circuit and control circuit)	Voltage	Single-phase 200 V to 230 VAC, +10% to -15%			
	Frequency	50/60Hz ± 5%			
	Capacity at rated output [kVA]	0.40	0.75	1.2	2.2
Power loss at rated output [W]		14	16	24	35
Input control method		Capacitor-input type, single-phase full-wave rectification with resistance to prevent inrush currents.			
Output control method		PWM control, sine wave power driven system			
Feedback		Analog output encoder			
Allowable load inertia [kgm <sup>2</sup> ]*		0.6×10 <sup>-4</sup>	3×10 <sup>-4</sup>	5×10 <sup>-4</sup>	10×10 <sup>-4</sup>
Leakage current	Power-supply frequency	5 mA or less			
	High frequency	2.5 A0-p Motor cable length: 20 m max.			
I/O Signals	Input signal for reference Designated pulse type and pulse resolution with PULSE switch.	Pulse type	Select one of the following signals: 1. CCW + CW 2. Sign + pulse train 3. CCW + CW (logic reversal) 4. Sign + pulse train (logic reversal)		
		Pulse resolution	Select one of the following signals: 1. 1000 pulses/rev (Open collector/line driver) 75 kpps max. 2. 2500 pulses/rev (Open collector/line driver) 187.5 kpps max. 3. 5000 pulses/rev (Line driver) 375 kpps max. 4. 10000 pulses/rev (Line driver) 750 kpps max.		
	Clear input signal	Clears the positioning error when turned ON.			
	Servo ON input signal	Turns the servomotor on or off.			
	Alarm output signal	OFF if an alarm occurs. Note: OFF for 2s when power is turned ON.			
	Brake output signal	External signal to control brakes. Turn ON to release the brake.			
	Positioning completed output signal	ON if the current position is equal to the reference position ±10 pulses. External signal to control brakes.			
	Origin output signal	ON if the motor is at the origin. (Width: 1/500 rev) Note: Use the pulse edge that changes the signal from OFF to ON.			

SERVOPACK model SJDE-		01APA	02APA	04APA	08APA
Built-in functions	Dynamic brake (DB)	Operated at main power OFF, servo alarm, servo OFF. (OFF after motor stops; ON if the motor power is off.)			
	Regenerative processing	Optional (If the regenerated energy is too large, install a regenerative unit.)			
	LED display	5 (PWR, REF, AL1, AL2, AL3)			
	Reference filter	Select one of eight levels with FIL switch.			
Cooling method		Forced cooling (built-in fan)			

## 7.2 Overload Protection Characteristics

The SERVOPACK provides a function to protect the servomotor and SERVOPACK from overloads.

**NOTE**

- If an overload alarm occurs, remove the cause of the alarm and wait for at least one minute. Turn ON the servomotor again after the servomotor has cooled sufficiently. If the operation of the servomotor is repeated within a short time, the servomotor coil may burn out.
- Use a correct combination of the SERVOPACK and servomotor.
- Overload protection characteristics are the values used when the motor attached to the aluminum heatsink [250 mm × 250 mm × 6 mm (23.62 in × 23.62 in × 0.24 in)] at the ambient temperature of 40 °C (104 °F). Make sure to use the SERVOPACK in the recommended operating conditions.

The overload protection characteristics are shown below.

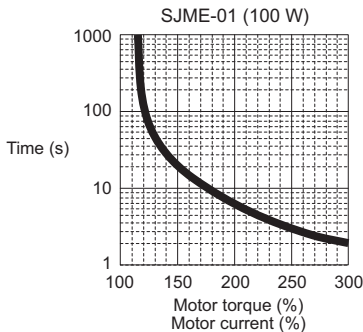

Example: If the Servomotor torque is 300%, an overload alarm will occur in approximately two seconds.

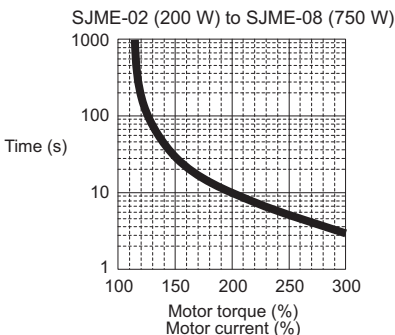

Note: The servomotor torque is given as a percentage of the rated torque.

## Revision History

The revision dates and numbers of the revised manuals are given on the bottom of the back cover.

MANUAL NO. TOMP C710806 00B

Published in China June 2005 04-8 ◇ -1

◇ Date of publication  
 04-8 Date of original publication  
 -1 WEB revision number  
 Revision number

Date of Publication	Rev. No.	WEB Rev. No.	Section	Revised Content
March 2014	◇	0	Back cover	Revision: Address
May 2013	◇	0	-	Chinese version only.
February 2013	◇	0	-	Printed version of the user's manual that is available on the web (web version: TOMP C710806 00E<4>-2)
			1.2	Revision: Nameplate
			5.1	Revision: Conditions at alarm occurrence of overcurrent
			Inside of back cover	Addition: Precautions for Korean Radio Waves Act
			Back cover	Revision: Address
August 2012	◇	2	3.11	Addition: Descriptions of ALM, /BK and /COIN
			3.13	Revision: BK → /BK
			Back cover	Revision: Address
July 2011		1	3.15	Revision: Unit of electrical specifications of I/O signals
September 2010		0	Preface, 3.3	Revision: Description of holding brake
			3.1, 3.5	Addition: Rated voltage
			7.2	Addition: Current description
			Back cover	Revision: Address
March 2009	◇	0	Preface	Addition: PL on fumigation
			3.2, 3.9, 3.13, 3.15, Chapter 5	Addition: Precautions on brake signal processing
			3.3	Revision: Model number of regenerative unit in connection diagram JUSP-RG08D → JUSP-RG08E-E
			Back cover	Revision: Address
December 2007	◇	1	3.3	Revision: Connection diagram
			3.12	Revision: Terminal number Revision: Unit of limit resistor
			Back cover	Revision: Address
January 2006		0	-	Japanese version (TOJPC71080600B) and multi-language version (TOJPC71080600B) bound together.
			1.1, 1.2, 6.3	Revision: Nameplate
			3.1	Addition: ■ Power Loss ■ MCCB or Fuse Capacity Relation to Power Supply Capacity ■ Noise Prevention
			7.1	Revision: Values for the allowable load inertia Addition: Leakage current

Date of Publication	Rev. No.	WEB Rev. No.	Section	Revised Content	
June 2005	◇	1	All chapters	Revision: Nameplate	
March 2005		0	–		Based on Japanese instruction manual, TOJPC71080600B<1> printed in February 2005.
			All chapters		Revision: SERVOPACK exterior
			1.2		Addition: Checking Products
			1.5		Revision: Acceleration/deceleration time for step reference for the Reference Filter Setting Rotary Switch (FIL)
			3.1		Revised
			3.2		Addition: Drawings for warning, caution, surge absorber (for lightning surge), fuse, and varistor in the system configuration
			3.3		Revised
			3.4		Revision: EMC directives
			3.5		Revised
			3.9		Addition: Connection diagram for standard servomotor main circuit cable
			3.12 to 3.15		Added
			Chapter 5		Revised
	Chapter 6		Revision: Name and address of manufacturer of cooling fan		
	Chapter 7		Revision: Value of the power loss at rated output		
August 2004	–	–	–	First edition: Based on Japanese instruction manual, TOJPC71080600A printed in August 2004.	

# AC SERVOPACK JUNMA Series INSTRUCTIONS

---

**IRUMA BUSINESS CENTER (SOLUTION CENTER)**

480, Kamifujisawa, Inuma, Saitama 358-8555, Japan  
Phone 81-4-2962-5151 Fax 81-4-2962-6138  
<http://www.yaskawa.co.jp>

**YASKAWA AMERICA, INC.**

2121 Norman Drive South, Waukegan, IL 60085, U.S.A.  
Phone 1-800-YASKAWA (927-5292) or 1-847-887-7000 Fax 1-847-887-7310  
<http://www.yaskawa.com>

**YASKAWA ELÉTRICO DO BRASIL LTDA.**

Avenida Piraporinha 777, Diadema, São Paulo, 09950-000, Brasil  
Phone 55-11-3585-1100 Fax 55-11-3585-1187  
<http://www.yaskawa.com.br>

**YASKAWA EUROPE GmbH**

Hauptstraße 185, Eschborn 65760, Germany  
Phone 49-6196-569-300 Fax 49-6196-569-398  
<http://www.yaskawa.eu.com>

**YASKAWA ELECTRIC KOREA CORPORATION**

9F, Kyobo Securities Bldg, 26-4, Yeouido-dong, Yeongdeungpo-gu, Seoul, 150-737, Korea  
Phone 82-2-784-7844 Fax 82-2-784-8495  
<http://www.yaskawa.co.kr>

**YASKAWA ELECTRIC (SINGAPORE) PTE. LTD.**

151 Lorong Chuan, #04-02A, New Tech Park 556741, Singapore  
Phone 65-6282-3003 Fax 65-6289-3003  
<http://www.yaskawa.com.sg>

**YASKAWA ELECTRIC (CHINA) CO., LTD.**

12F, Carlton Bld., No.21 HuangHe Road, HuangPu District, Shanghai 200003, China  
Phone 86-21-5385-2200 Fax 86-21-5385-3299  
<http://www.yaskawa.com.cn>

**YASKAWA ELECTRIC (CHINA) CO., LTD. BEIJING OFFICE**

Room 1011, Tower W3 Oriental Plaza, No.1 East Chang An Ave.,  
Dong Cheng District, Beijing 100738, China  
Phone 86-10-8518-4086 Fax 86-10-8518-4082

**YASKAWA ELECTRIC TAIWAN CORPORATION**

9F, 16, Nanking E. Rd., Sec. 3, Taipei 104, Taiwan  
Phone 886-2-2502-5003 Fax 886-2-2505-1280



YASKAWA ELECTRIC CORPORATION

In the event that the end user of this product is to be the military and said product is to be employed in any weapons systems or the manufacture thereof, the export will fall under the relevant regulations as stipulated in the Foreign Exchange and Foreign Trade Regulations. Therefore, be sure to follow all procedures and submit all relevant documentation according to any and all rules, regulations and laws that may apply.

Specifications are subject to change without notice for ongoing product modifications and improvements.

© 2004-2014 YASKAWA ELECTRIC CORPORATION. All rights reserved.

MANUAL NO. TOMP C710806 00G

Published in China March 2014 04-8  0  
13-6-9