

Servopack™

TRANSISTORIZED/PWM CONTROL REVERSING

TYPE PCR-MR 052K

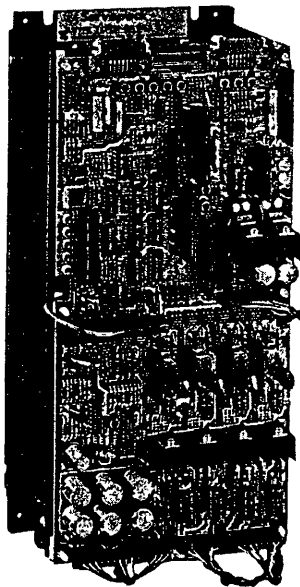

582-38

Servopack
 Type PCR-MR 052K

1. GENERAL DESCRIPTION

Servopack type PCR-MR 052K is designed as servo unit controller for our CNC YASNAC LX 1/2 and MX1/2 series. Servopack can control a wide variety of speed range for servomotor feed drives (Cup Motor, Minertia Motor or Hi-Cup Motor).

Servopack with a transistorized PWM control offers a highly responsive servo system with superior stability. In addition, low-noise servo drives and low-heat generation are two of Servopack's main features.

This manual is used as a selection guide to determine a servo system for the CNC YASNAC LX1, MX1, LX2 and MX2.

CONTENTS

1	GENERAL DESCRIPTION	7
2	RATINGS AND SPECIFICATIONS	7
3	COMBINATION OF SERVOPACK WITH SERVO MOTOR AND REACTOR	9
4	CHARACTERISTICS IN COMBINATION OF SERVOPACK WITH SERVO MOTOR	12
5	INTERNAL BLOCK DIAGRAMS	15
5 1	Servopack	15
5 2	Power Supply Unit	18
6	INPUT/OUTPUT SIGNALS	18
6 1	List of Input/Output Signals	18
6 2	Description of Input/Output Signals	18
6 3	List of Terminal and Connector	20
7	CONNECTION DIAGRAM	7
7 1	Connection for YASNAC LX1	7
7 2	Connection for YASNAC MX1	9
8	CHARACTERISTICS OF SERVOPACK AND SERVO MOTOR COMBINATION	12
8 1	Characteristics Description	12
8 2	Torque-Speed Characteristics	12
9	APPLICATION TECHNIC OF YASNAC	15
9 1	Servomotor Selection	15
9 2	Coasting Distance After YASNAC Emergency Stop	18
9 3	Minimum Dog Length for Returning to Home Position	18
6	APPENDIX SELECTION LIST OF DC SERVO MOTOR FOR YASNAC	20

2. RATINGS AND SPECIFICATIONS

Table 1 Ratings and Specifications of Servopack

Item	Type	CPCR-	MR05□K	MR073K	MR08□K	MR15□K	MR22□K	MR37□K
Main Circuit DC Voltage	270 V (Supplied from power supply unit)							
Control Power Supply	200/220 VAC 50/60 Hz (Supplied from power supply unit)							
Ambient Temperature	0 to +60°C (Fin: 0 to +45°C)							
Storage Temperature	-20°C to +85°C							
Storage Humidity	90% or below							
Vibration, Shock	Vibration. 0.5 G or less, Shock 2 G or less							
Control Method	Transistorized/PWM control							
Maximum Acceleration/Deceleration Current	±25A (MR054K ±16A)	±30A	±25A (MR084K ±19A)	±40A (MR154K2 ±25A) (MR154K ±32A)	±40A	±60A		
Continuous Output Current	±9A	±14A	±8A	±13A	±18A	±24A		
Continuous Output Voltage	±200V							
Function	Reference Input Adjustable Range	Rated speed at 4 to 50 V						
	Differential Input Adjustable Range	Rated speed at 4 to 10 V						
	External Current Limit	Maximum acceleration/deceleration current at +10 V						
	Servo ON/OFF	Servo ON at LOW level (with pull-up resistor)						
	Dynamic Brake	Operated at alarm, Servo OFF or control power OFF						
	TG ON/OFF	TG detecting level $\frac{\text{Rated speed}}{10}$ or less (open collector)						
	Overload Detection	Not operated at 125%, 150 sec at 150%, 50 sec at 200%						
Speed, Current Detection	Current at 2V/100%, Speed at 3.6V/1000 rpm, maximum output current ±10 mA							
Protection	Device	Use of fuse						
	TG Trouble	Shortcircuit, open, wrong, connection, overspeed (120% to 140%)						
	Overcurrent	V_{CE} detection ($V_{CE} \geq 7V$)						
	Overvoltage	Protected at 400 to 420 V						
Indication	LED	<ul style="list-style-type: none"> • Power ON [POWER] (green) • Input ON [IN], TG ON [TG] (white) • TG trouble, overcurrent, overvoltage, overload, blown fuse (red) 						

TYPE DESIGNATION

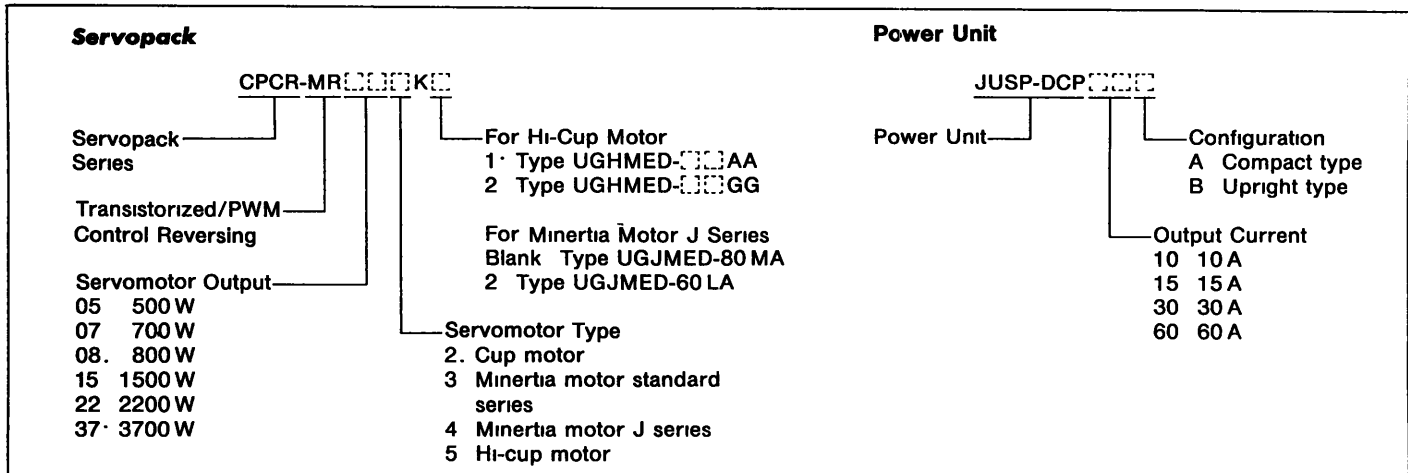

3. COMBINATION OF SERVOPACK WITH SERVOMOTOR AND REACTOR

Table 2 Combination of Servopack with Servomotor and Reactor

Servopack Type CPCR-	Applicable Servomotor Type	Reactor (Separately Installed)	Servopack Type CPCR-	Applicable Servomotor Type	Reactor (Separately Installed)
MR052K	UGCMED-04	10mH, 14 A(Dwg No DE8402698)	MR154K2	UGJMED-60LA	5mH, 11 A(Dwg No DE8402744)
MR053K	UGMMEM-13	10mH, 14 A(Dwg No DE8402698)	MR155K1	UGHMED-12AA	10mH, 14 A(Dwg No DE8402698)
MR054K	UGJMED-40L	10mH, 14 A(Dwg No DE8402698)	MR155K2	UGHMED-12GG	10mH, 14 A(Dwg No DE8402698)
MR055K	UGHMED-03GG	10mH, 14 A(Dwg No DE8402698)	MR222K	UGCMED-22	10mH, 18 A(Dwg No DE8403030)
MR073K	UGMMEM-25	10mH, 14 A(Dwg No DE8402698)	MR224K	UGJMED-80LA	5mH, 25 A(Dwg No DE8402745)
MR082K	UGCMED-08	10mH, 14 A(Dwg No DE8402698)	MR225K1	UGHMED-20AA	10mH, 18 A(Dwg No DE8403030)
MR084K	UGJMED-60MA	5mH, 11 A(Dwg No DE8402744)	MR225K2	UGHMED-20GG	10mH, 18 A(Dwg. No DE8403030)
MR085K1	UGHMED-06AA	10mH, 14 A(Dwg No DE8402698)	MR372K	UGCMED-37	10mH, 25 A(Dwg No DE8402699)
MR085K2	UGHMED-06GG	10mH, 14 A(Dwg No DE8402698)	MR373K	UGMMED-1A	10mH, 25 A(Dwg. No DE8402699)
MR152K	UGCMED-15	10mH, 14 A(Dwg No DE8402698)	MR374K	UGJMED-80KA	10mH, 25 A or 28 A(Dwg No DE8401695)
MR153K	UGMMEM-50	10mH, 14 A(Dwg No. DE8402698)	MR375K1	UGHMED-30AA	10mH, 25 A(Dwg No DE8402699)
MR154K	UGJMED-80MA	5mH, 11 A(Dwg No DE8402744)	MR375K2	UGHMED-30GG	10mH, 25 A(Dwg No DE8402699)

4. CHARACTERISTICS IN COMBINATION OF SERVOPACK WITH SERVOMOTOR

Table 3 Characteristics in Combination of Servopack with Servomotor

Servopack Type CPCR-	Servomotor Type	Servopack Maximum Current (A)	At Rated Operation			At Overspeed			Applicable Load GD ² /4 (kg cm ²)
			Rated Speed (rpm)	Continuous Effective Torque (kg cm)	Instantaneous Effective Torque (kg·cm)	Overspeed (rpm)	Continuous Effective Torque (kg cm)	Instantaneous Effective Torque (kg cm)	
MR052K	UGCMED-04	25	1750	21.2	70.5	2400	18	70	22.4
MR053K	UGMMEM-13	25	3000	12.4	43.2	—	—	—	1.41
MR054K	UGJMED-40L	16	1000	23.2	78.4	1500	17	37	20.0
MR055K	UGHMED-03GG	25	1000	22.8	79.8	1500	22.8	79	20.3
MR073K	UGMMEM-25	30	3000	23.8	56.1	—	—	—	2.83
MR082K	UGCMEM-08	25	1750	39.6	161.5	2400	33	160	36.0
MR084K	UGJMED-60MA	19	1000	41.8	161.7	1500	27	105	44.0
MR085K1	UGHMED-06AA	25	1000	55.5	239.9	1500	48	223	73.3
MR085K2	UGHMED-06GG	25	1000	47.5	194.0	1500	38	195	33.0
MR152K	UGCMED-15	40	1750	79.3	303.2	2400	62	300	101
MR153K	UGMMEM-50	40	3000	47.5	162.6	—	—	—	9.00
MR154K	UGJMED-80MA	32	1000	101.7	319.2	1200	104	237	140
MR154K2	UGJMED-60LA	25	1000	78.9	210.4	1500	59	175	63.0
MR155K1	UGHMED-12AA	40	1000	111.2	444.6	1400	84	437	134
MR155K2	UGHMED-12GG	40	1000	111.2	444.6	1400	90	329	134
MR222K	UGCMED-22	40	1750	116.9	295.3	2300	85	295	152
MR224K	UGJMED-80LA	40	1000	166.3	383.8	1500	110	290	245
MR225K1	UGHMED-20AA	40	1000	185.3	475.0	1400	188	463	292
MR225K2	UGHMED-20GG	40	1000	166.3	437.0	1500	130	437	234
MR372K	UGCMED-37	60	1750	195.7	465.7	2200	136	465	298
MR373K	UGMMEM-1A	60	3000	95.0	236.5	—	—	—	25.2
MR374K	UGJMED-80KA	43	1000	242.3	535.1	1300	185	345	335
MR375K1	UGHMED-30AA	60	1000	277.4	752.4	1200	188	752	494
MR375K2	UGHMED-30GG	60	1000	266.0	786.6	1200	175	786	365

5. INTERNAL BLOCK DIAGRAMS

5.1 Servopack

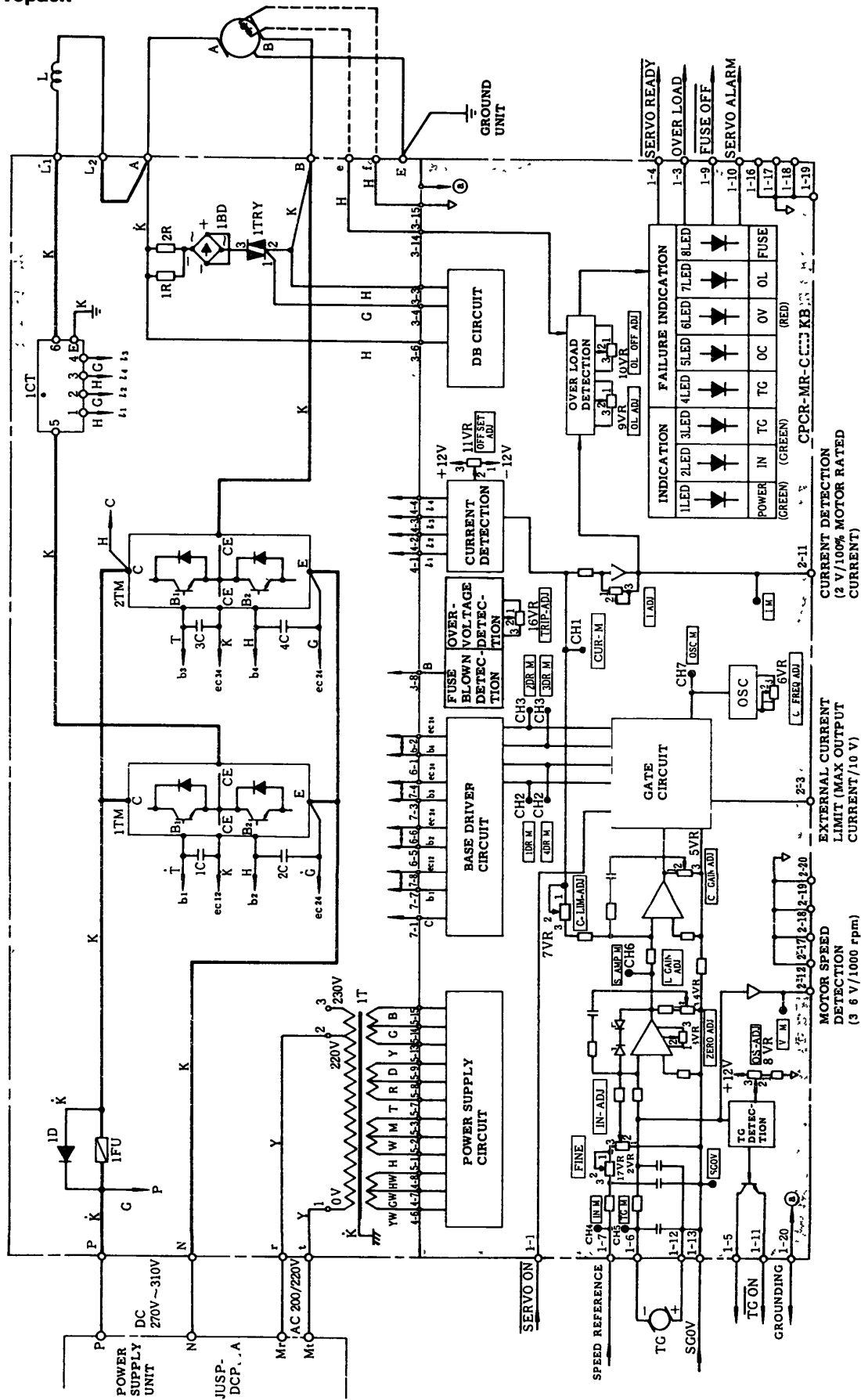
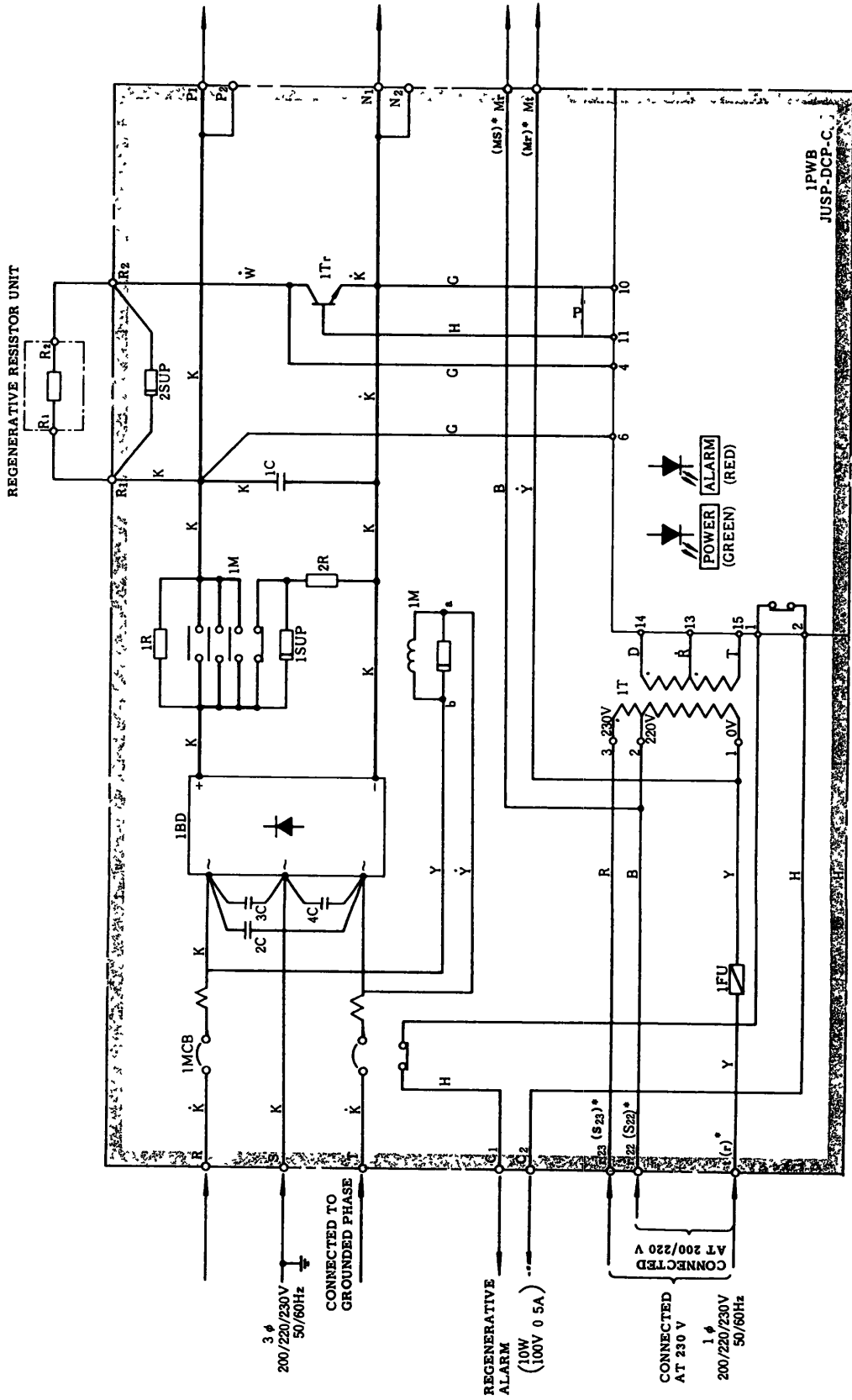

Fig 1 Internal Block Diagram of Servopack

5.2 Power Supply Unit



* Parenthesized symbols are terminals of power supply unit Type DCP:;B.

Fig. 2 Internal Block Diagram of Power Supply Unit

6. INPUT/OUTPUT SIGNALS

6.1 List of Input/Output Signals

Table 4 List of Input/Output Signals

Terminal Symbol	Signal Name	Description	
Main Circuit Terminals	P, N	Main Circuit Power Supply Input 270 to 310VDC (Supplied from the power supply unit)	
	r, t	Control Power Supply Input 200/220VAC, 50/60Hz (Supplied from the power supply unit)	
	L ₁ , L ₂	DC Reactor Connection Connected to the separately installed DC reactor	
	A, B	Motor Connection A Connected to motor terminal A B Connected to motor terminal B	
	e, f	Thermoguard Connection Connected to terminals B1 and B2 of Minertia Motor J series with a thermoguard	
Control Circuit Connectors	1CN	1-1	SERVO ON See Table 5
		1-3	OVERLOAD See Table 6
		1-4	SERVO READY See Table 6
		1-5	TG ON See Table 6
		1-11	
		1-6	Connected to TG terminal (-)
		1-12	Connected to TG terminal (+)
		1-7	Speed Reference Speed reference input 4 to 50V
		1-9	FUSE OFF See Table 6
		1-10	SERVO ALARM See Table 6
		1-13	SG 0V SG 0V Signal grounding
1-20	Grounding —		

6.2 Description of Input/Output Signals

- Input Signals (Input through open-collector)

Table 5 Input Signals

Signal Name	Functions
SERVO ON	At LOW the controller is ready to operate Make a sequence so that SERVO ON signal is turned on after power is applied to the controller and main circuit, adjusting SERVO ON signal to HIGH turns off control power and main circuit power
	CONTROL POWER SUPPLY (r, t)
	MAIN CIRCUIT POWER SUPPLY (P, N) SERVO ON

- Output Signals (Output through open-collector I_{sink}=10 mA max)

Table 6 Output Signals

Signal Name	Functions
TG ON	TG ON signal turns LOW when motor speed exceeds 1/10 of the rated speed
SERVO ALARM	TG lights up when TG failure (disconnection, shortcircuit, reverse connection) or motor over-speed is detected OC lights up when overcurrent is detected OV lights up when overvoltage is detected
SERVO READY	Applying power to main circuit without generation of SERVO ALARM signal makes SERVO ALARM output LOW
OVERLOAD	OVERLOAD output signal turns HIGH when motor overload (internal thermal relay circuit or thermostat) is detected
FUSE OFF	Blowing fuses in the Servopack unit turns FUSE OFF signal LOW

6.3 List of Terminal and Connector

- Terminal (Type LC-01-30)

P	N	L ₁	L ₂	A	B	r	t	e	f
---	---	----------------	----------------	---	---	---	---	---	---

Fig 3 Terminal List

- Connector (Type MR-20 RMA)

1	2	3	4	5	6	7	8	9	10
SERVO ON		OVERLOAD	SERVO READY	TG ON	TG (-)	SPEED REFERENCE		FUSE OFF	SERVO ALARM
11	12	13	14	15	16	17	18	19	20
TG ON	TG (+)	SG 0V			0c	0c	0c	0c	GROUND

Fig 4 Connector List

7. CONNECTION DIAGRAM

7.1 Connection for YASNAC LX1/LX2

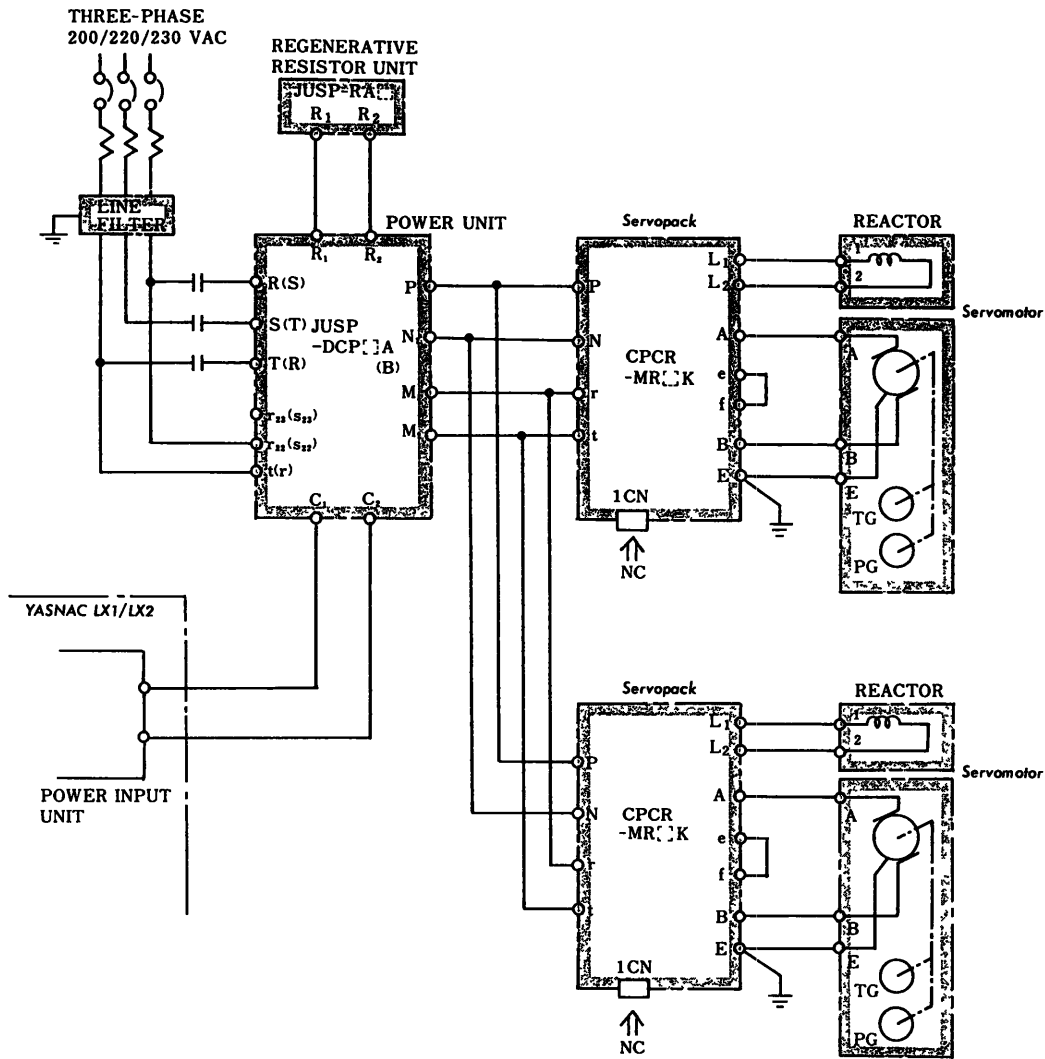

Note

1. Where supplying 230VAC, connect a control power supply across terminals 23 (S23) and 1 (T) of a power unit
2. For a Servomotor (Minertia motor J series) with built-in thermostat, connect the thermostat leads to the external terminals ② and ① of Servopack. See figure surrounded by solid line at right. If a Servomotor without thermostat will be used, short-circuit across the terminals ② and ①

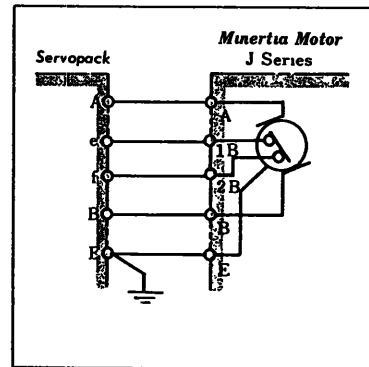

Connection of Minertia Motor J Series and Servopack

Fig 5 Connection for YASNAC LX1/LX2

7.1 Connection for YASNAC LX1/LX2 (Cont'd)

- Wiring of Servopack and YASNAC LX1/LX2
- Detail of Wiring

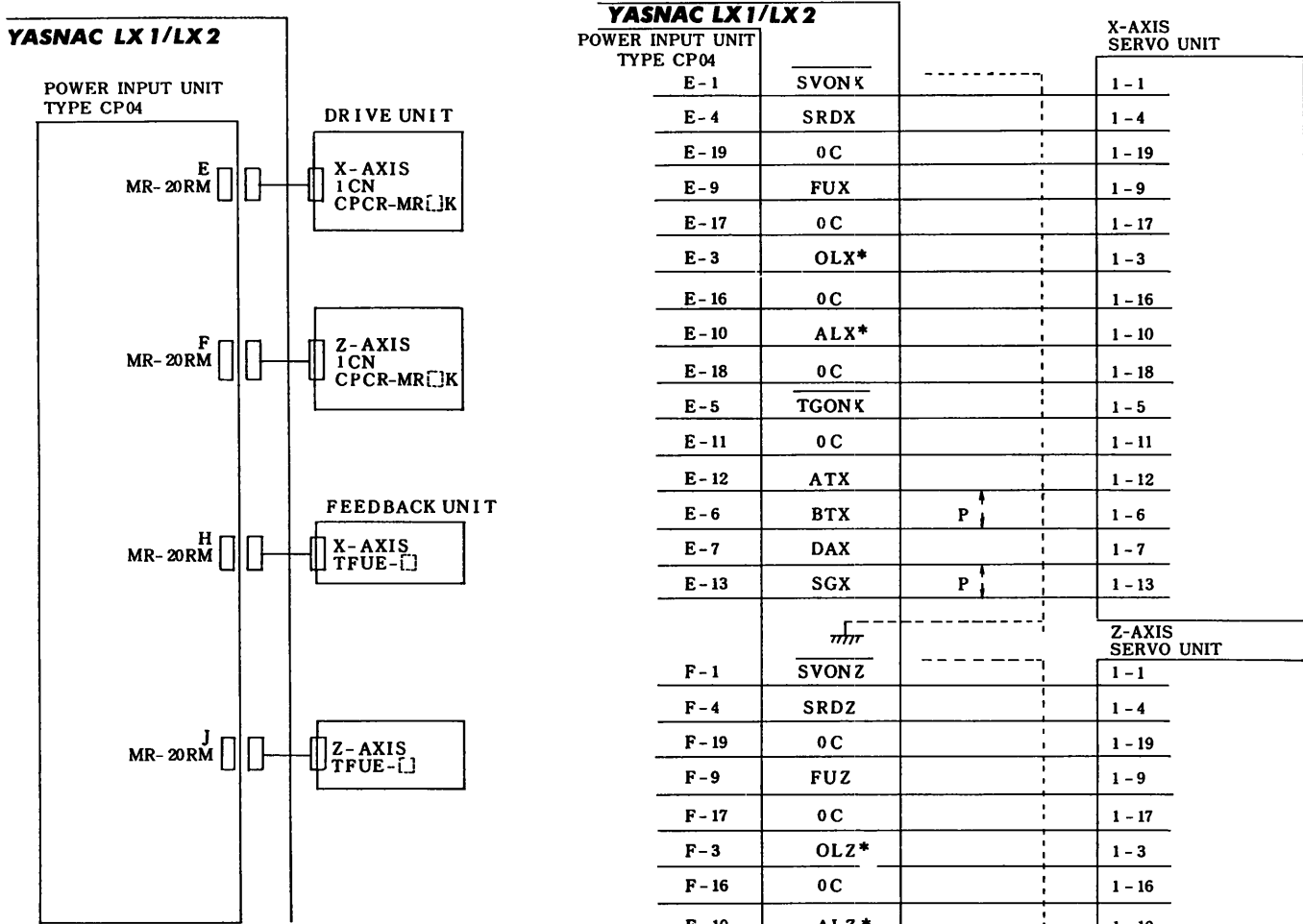
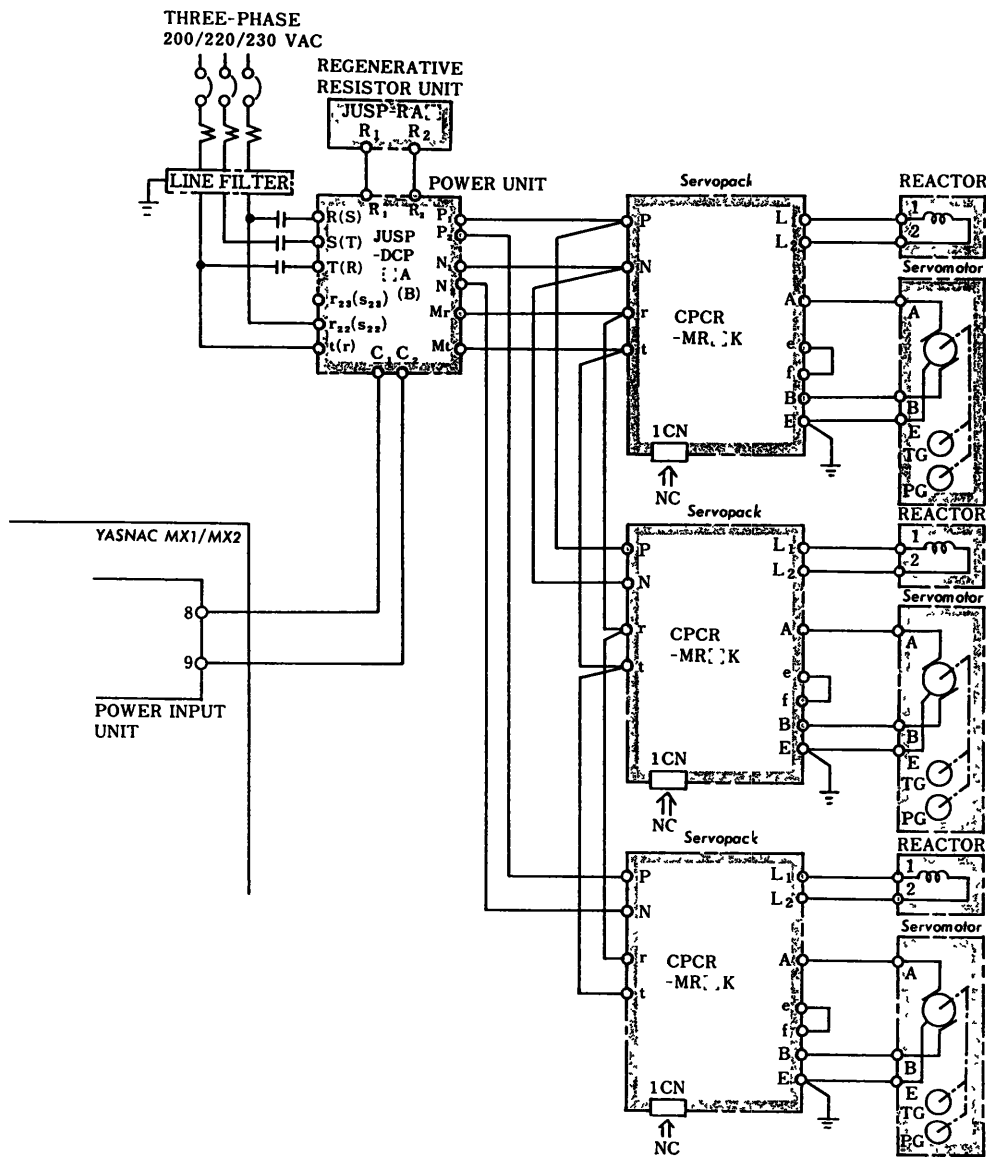

Fig 6 Wiring of Servopack and YASNAC LX1/LX2

* Normally closed contact

Fig 7 Detail of Wiring

7.2 Connection for YASNAC MX1/MX2



Note

- 1 Where supplying 230VAC, connect a control power supply across terminals (R23) (S23) and (T) (r) of a power unit
- 2 For a Servomotor (Minertia motor J series) with built-in thermostat, connect the thermostat leads to the external terminals (A) and (B) of Servopack. See figure surrounded by solid line at right. If a Servomotor without thermostat will be used, short-circuit across the terminals (A) and (B).

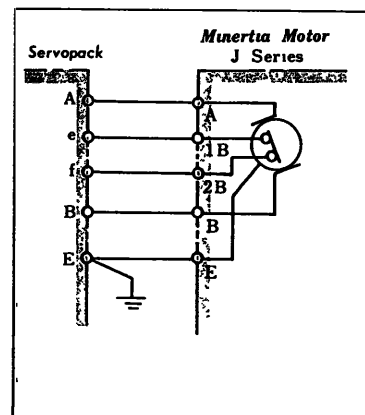

Connection of Minertia Motor J Series and Servopack

Fig 8 Connection for YASNAC MX1/MX2

7.2 Connection for YASNAC MX1/MX2 (Cont'd)

• Wiring of Servopack and YASNAC MX1/MX2

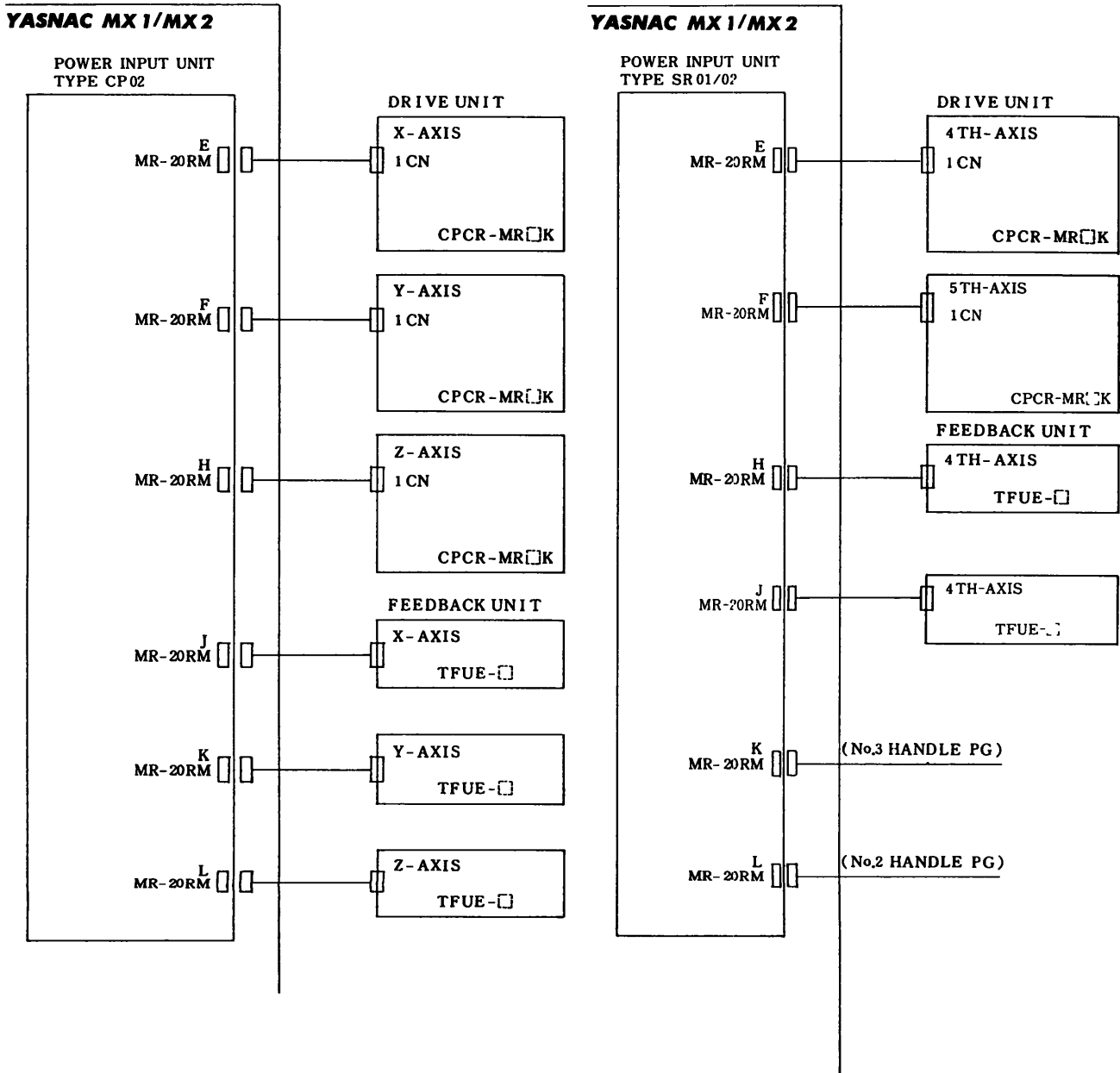

Fig 9 Wiring of Servopack and YASNAC MX1/MX2

• Detail of Wiring

YASNAC MX1/MX2

POWER INPUT UNIT
TYPE CP02

		Servopack	
		X-AXIS	
E-12	ATX	P	1 CN-12
E-6	BTX		1 CN-6
E-7	DAX		1 CN-7
E-13	SGX		1 CN-13
E-1	SVONX*		1 CN-1
E-5	TGONX*		1 CN-5
E-11	0C		1 CN-11
E-4	SRDX		1 CN-4
E-19	0C		1 CN-19
E-9	FUX		1 CN-9
E-17	0C		1 CN-17
E-3	OLX*		1 CN-3
E-16	0C		1 CN-16
E-10	ALX*		1 CN-10
E-18	0C		1 CN-18
E-20	EPX		

CPCR-MR□K

YASNAC MX1/MX2

POWER INPUT UNIT
TYPE CP02

		Servopack	
		Z-AXIS	
H-12	ATZ	P	1 CN-12
H-6	BTZ		1 CN-6
H-7	DAZ		1 CN-7
H-13	SGZ		1 CN-13
H-1	SVONZ*		1 CN-1
H-5	TGONZ*		1 CN-5
H-11	0C		1 CN-11
H-4	SRDZ		1 CN-4
H-19	0C		1 CN-19
H-9	FUZ		1 CN-9
H-17	0C		1 CN-17
H-3	OLZ*		1 CN-3
H-16	0C		1 CN-16
H-10	ALZ*		1 CN-10
H-18	0C		1 CN-18
H-20	EPZ		

CPCR-MR□K

Servopack

Y-AXIS

F-12	ATY	P	1 CN-12
F-6	BTY		1 CN-6
F-7	DAY		1 CN-7
F-13	SGY		1 CN-13
F-1	SVONY*		1 CN-1
F-5	TGONY*		1 CN-5
F-11	0C		1 CN-11
F-4	SRDY		1 CN-4
F-19	0C		1 CN-19
F-9	FUY		1 CN-9
F-17	0C		1 CN-17
F-3	OLY*		1 CN-3
F-16	0C		1 CN-16
F-10	ALY*		1 CN-10
F-18	0C		1 CN-18
F-20	EPY		

CPCR-MR□K

YASNAC MX1/MX2

POWER INPUT UNIT
TYPE SRC1/02

		Servopack	
		4-AXIS	
E-12	AT4	P	1 CN-12
E-6	BT4		1 CN-6
E-7	DA4		1 CN-7
E-13	SG4		1 CN-13
E-1	SVON4*		1 CN-1
E-5	TGON4*		1 CN-5
E-11	0C		1 CN-11
E-4	SRD4		1 CN-4
E-19	0C		1 CN-19
E-9	FU4		1 CN-9
E-17	0C		1 CN-17
E-3	OL4*		1 CN-3
E-16	0C		1 CN-16
E-10	AL4*		1 CN-10
E-18	0C		1 CN-18
E-20	EP4		

CPCR-MR□K

* Normally closed contact

Fig 10 Detail of Wiring

7.2 Connection for YASNAC MX1/MX2 (Cont'd)

YASNAC MX1/MX2 POWER INPUT UNIT TYPE SR01/02		Servopack	
F-12	AT4		5-AXIS 1 CN-12
F-6	BT4		1 CN-6
F-7	DA4		1 CN-7
F-13	SG4		1 CN-13
F-1	SVON4*		1 CN-1
F-5	TGON4*		1 CN-5
F-11	0C		1 CN-11
F-4	SRD4		1 CN-4
F-19	0C		1 CN-19
F-9	FU4		1 CN-9
F-17	0C		1 CN-17
F-3	OL4*		1 CN-3
F-16	0C		1 CN-16
F-10	AL4*		1 CN-10
F-18	0C		1 CN-18
F-20	EP4		

CPCR-MR□K

Fig 10 Detail of Wiring (Cont'd)

Table 7 Relation between Servopack and DC Reactor

Servopack Type CPCR-	DC Reactor Resistance (Ω)	DC Reactor Specification Numbers
MR05□K	0.2	DE 8402698
MR08□K	0.2	DE 8402698
MR15□K	0.2	DE 8402698
MR22□K	0.15	DE 8403030
MR37□K	0.10	DE 8402699

Note For Servomotor characteristics list, refer to the following lists

- Cup Motor A series C 74980107
- Hi-Cup Motor G series C 74980109

8.2 Torque-Speed Characteristics

In combination of Servomotor (Cup Motor A series, Hi-Cup Motor G series) with Servopack (Type CPCR-MR □K), torque-speed characteristics are shown below.

Cup Motor A Series

- Cup-Motor Type: UGCMED-04 AA
- Servopack Type: CPCR-MR 052 K

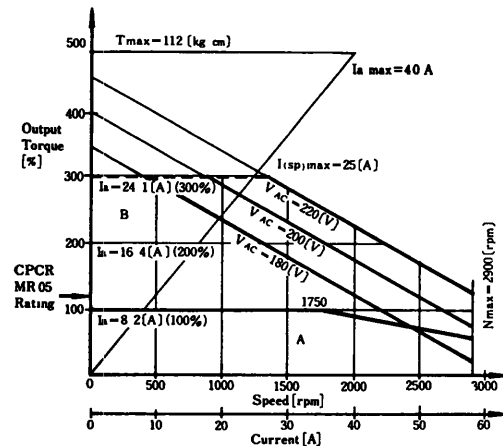

(a)

- Cup Motor Type: UGCMED-08 AA
- Servopack Type: CPCR-MR 082 K

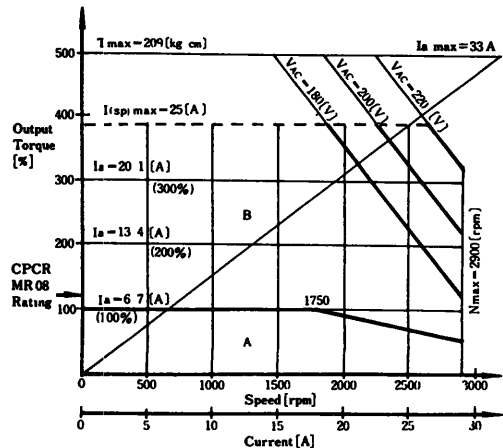

(b)

8. CHARACTERISTICS OF SERVOPACK AND SERVMOTOR COMBINATION

8.1 Characteristics Description

When Servopack is combined with DC Servomotor (Cup-Motor or Hi-Cup Motor), a torque-speed characteristics can be obtained by the following formula.

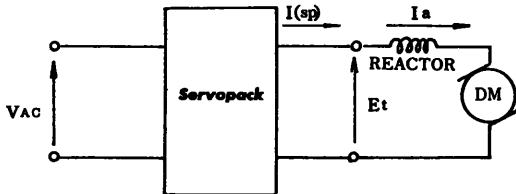

- V_{AC} AC input voltage to Servopack
- I(sp) Output current to Servopack
- E_t DC terminal voltage of Servomotor
- I_a Armature current

Fig 11 Connection of Servopack and Servomotor

$$E_t = K_e \cdot N + (R_a + R_k) \cdot I_a + V_r + 6$$

- K_e: Motor voltage constant (V/rpm)
- N: Motor Speed (rpm)
- R_a: Armature resistance (Ω) at 20°C
- R_k: DC reactor resistance (Ω)
- V_r: Ripple voltage (V)
- 6: Transistor voltage drop (V)

- Cup Motor Type UGCMED-15 AA
- Servopack Type CPR-MR 152 K

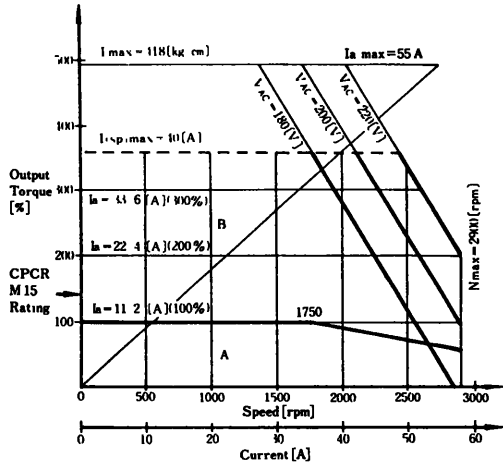

(c)

- Cup Motor Type: UGCMED-37 AA
- Servopack Type: CPR-MR 372 K

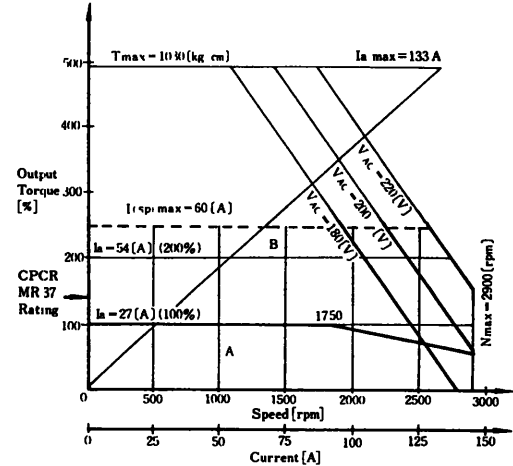

(e)

Fig 12 Torque-Speed Characteristics of Cup Motor A Series

- Cup Motor Type: UGCMED-22 AA
- Servopack Type: CPR-MR 222 K

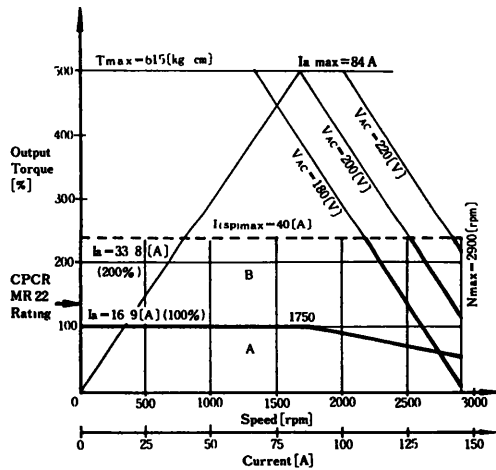

(d)

Figure Description

An output torque of y-distance is expressed as a percentage.

- 100 % Output Torque = Torque Constant × Rated Current.
- Torque Constant = $\frac{\text{Instantaneous Max Torque (1 sec)}}{\text{Instantaneous Max Current (1 sec)}}$

Dashed Bold Line Servopack max output current

Vertical Line. Continuous output current

T max Instantaneous max torque, 1 sec (kg·cm)

N max. Instantaneous max speed, 1 sec (rpm)

V_{AC} Input voltage (V)

I_a Armature current (A)

I(sp)max Max output current at driven side

A Continuous rating range

B Instantaneous rating range

8.2 Torque-Speed Characteristics (Cont'd)

Hi-Cup Motor G Series

- Hi-Cup Motor Type: UGHMED-03 GG
- Servopack Type: CPR-MR 055 K

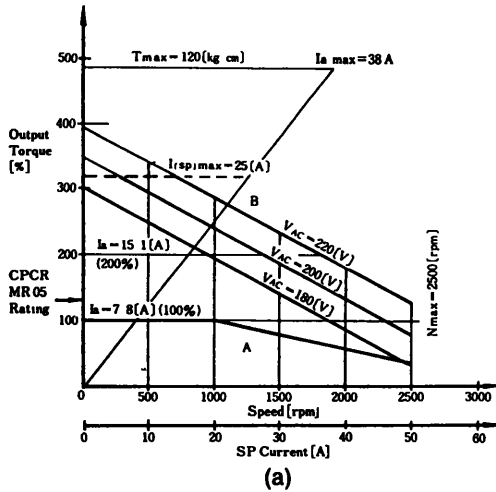

- Hi-Cup Motor Type: UGHMED-20 GG
- Servopack Type: CPR-MR 225 K 1

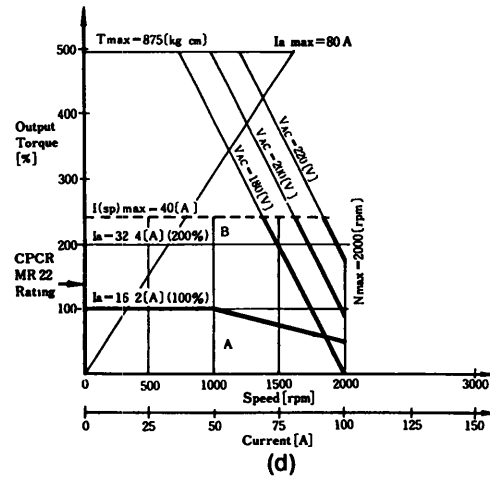

- Hi-Cup Motor Type: UGHMED-06 GG
- Servopack Type: CPR-MR 085 K 1

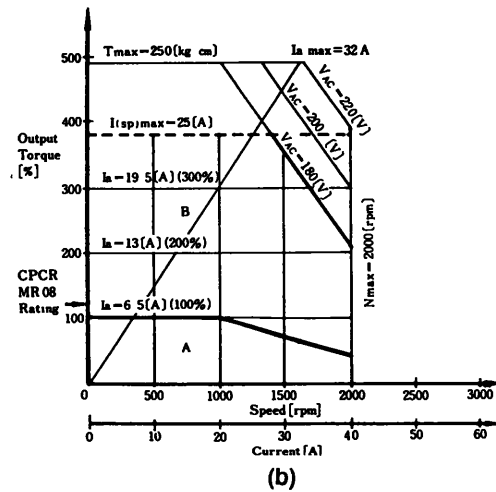

- Hi-Cup Motor Type: UGHMED-30 GG
- Servopack Type: CPR-MR 375 K 2

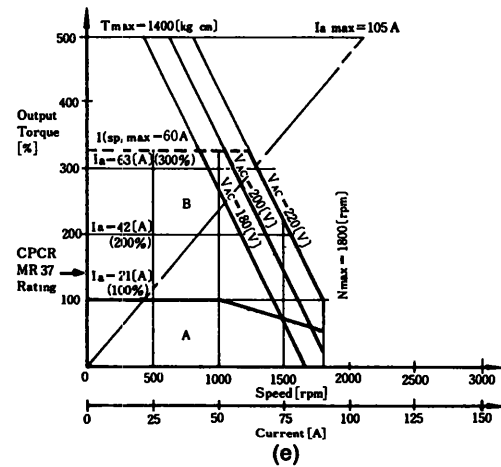

- Hi-Cup Motor Type: UGHMED-12 GG
- Servopack Type: CPR-MR 155 K 1

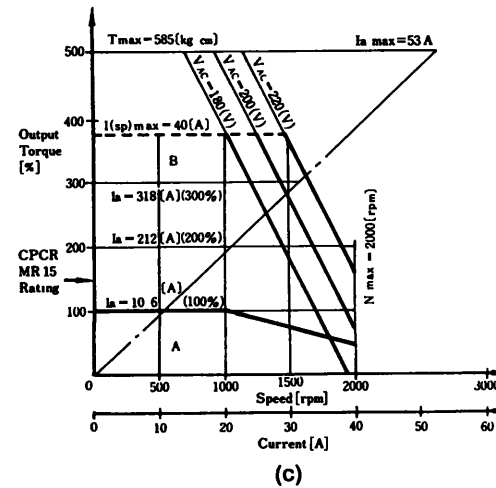

Fig 13 Torque-Speed Characteristics of Hi-Cup Motor G Series

9. APPLICATION TECHNIC OF YASNAC

9.1 Servomotor Selection

Where selecting DC Servomotor, the functions shown below should be considered. The motor is selected in accordance with customer's requirements.

- Motor speed
- Torque
- Positioning time
- Dimensions

For an example of motor selection, Table 8 is used. In this case, the motor speed and the torque are important in selecting the motor.

9.1.1 Prerequisite

To select the motor, its prerequisite is shown below.

(1) Ball Screw Length and $GD^2/4$ (Fig. 14)

The ball screw $GD^2/4$ is obtained by the following formula

$$GD^2/4 = M \times \left(\frac{D}{2}\right)^2 \times \frac{1}{2}$$

$$= n \left(\frac{D}{2}\right)^2 \times \ell P \times \left(\frac{D}{2}\right)^2 \times \frac{1}{2} \times 10^{-3} [\text{kg} \cdot \text{cm}^2]$$

$$= \frac{1}{32} \pi D^4 \times \ell P \times 10^{-3} [\text{kg} \cdot \text{cm}^2]$$

- D:** Ball screw diameter [cm]
- ℓ:** Ball screw length [cm] (screw section+400mm)
- P:** Iron specific gravity [787 g/cm³]
- M:** Ball screw weight [kg]

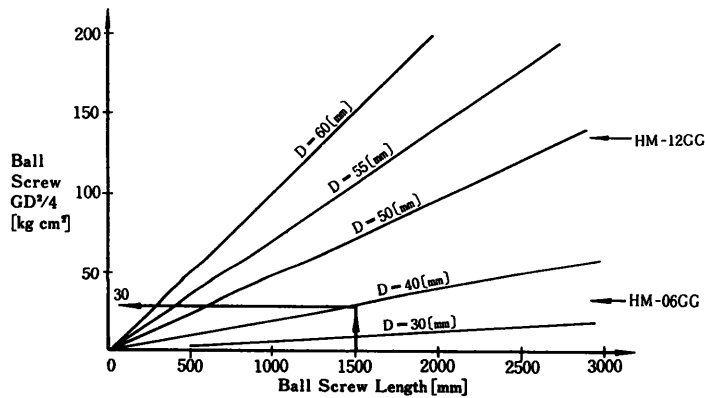

Fig 14 Ball Screw Length and Ball Screw $GD^2/4$

(2) Moving Member Weight and Ball Screw Shaft Inertia $GD^2/4$ (Fig. 15)

Ball screw shaft inertia $GD^2/4$ for moving member weight (work table, tool fixture, tool) depends on a ball screw pitch. The formula is as follows.

$$GD^2/4 = W \times \left(\frac{P}{2\pi}\right)^2 [\text{kg} \cdot \text{cm}^2]$$

- P:** Ball screw pitch [cm]
- W:** Moving member weight [kg]

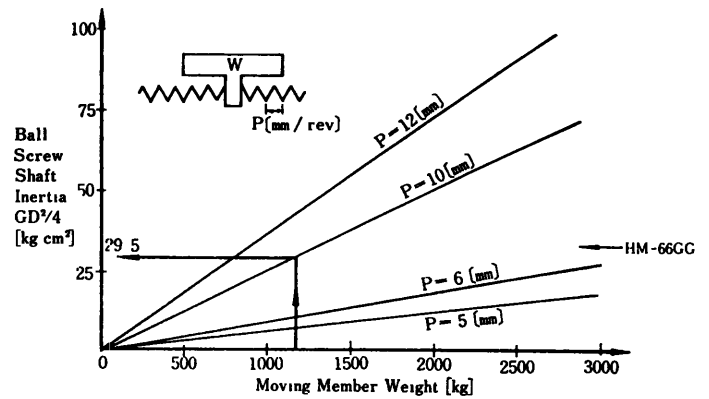
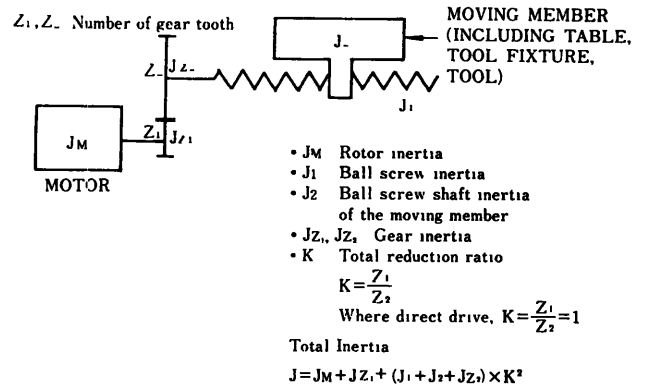

Fig 15 Moving Member Weight and Ball Screw Shaft Inertia $GD^2/4$

How to Obtain Rotor Inertia $GD^2/4$ from Load Inertia $GD^2/4$



(3) Motor Torque-Thrust Load

Fig 16 shows the relationship of motor torque and thrust load. The thrust load (F) is from the following formula.

$$F = \frac{2\pi}{P \cdot K} \times T [\text{kg}]$$

- T:** Motor torque [kg·cm]
- P:** Ball screw pitch [cm]
- K:** Total reduction ratio

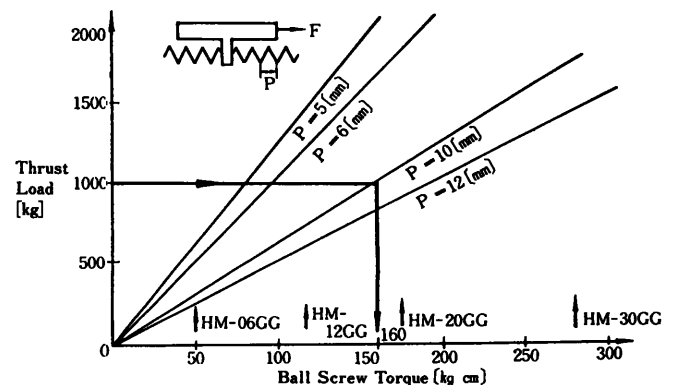
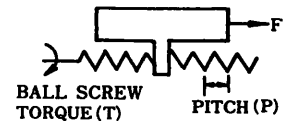

Note: Data is under no friction and 100% efficiency.

Fig 16 Ball Screw Torque and Thrust Load

9.1 Servomotor Selection (Cont'd)

(4) Load $GD^2/4$ – Accelerating Torque

Accelerating torque (T_L) used to accelerate to N rpm at accelerating time (t_a) is calculated by the following formula. The same formula is used for decelerating torque. See Figs 17 and 18

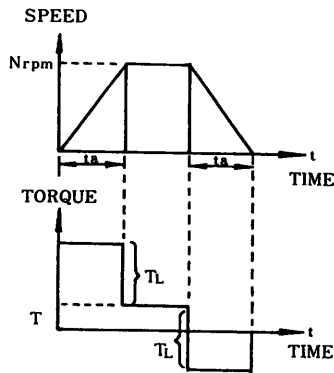

Fig 17 Speed-Time and Torque-Time

$$\text{Accelerating torque } T_L = \frac{GD^2 \times N}{375 \times t_a \times 10^2} \text{ [kg} \cdot \text{cm]}$$

t_a Accelerating time [sec]
 N Speed [rpm]
 GD^2 Total load inertia [kg cm²]
 T' Friction torque

$$\text{Actual accelerating torque } T = T_L + T'$$

Accelerating Torque T_L [kg cm]

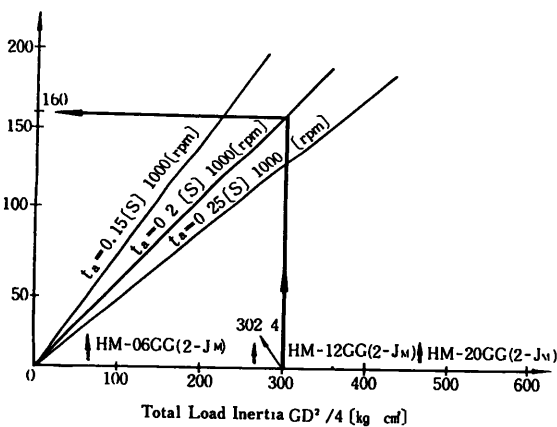

Fig 18 Total Load Inertia $GD^2/4$ and Accelerating Torque

9.1.2 Selection Example

In this section, a Servomotor which met selection criteria shown in Table 8 is selected.

(1) Motor Speed N

Refer to Nos 6, 7, 12 and 13 in APPENDIX

(a) At quick feed (N_1)

$$12,000 \text{ [mm/min]} = N_1 \times \frac{4}{5} \times 10 \text{ [mm/rev]}$$

$$N_1 = \frac{12,000}{10 \times \frac{4}{5}} = 1500 \text{ [rpm]}$$

(b) At cutting feed (N_2)

$$N_2 = \frac{2400}{10 \times \frac{4}{5}} = 300 \text{ [rpm]}$$

$$\boxed{\text{Motor Speed } 1500 \text{ [rpm]}} \dots \text{ (A)}$$

(2) Motor Torque at Cutting Operation

Refer to Nos 6, 7 and 10 in APPENDIX

(a) At feed of low speed

$$\text{Friction torque } T' = 25 \text{ [kg} \cdot \text{cm]} \dots \text{ ①}$$

(b) Cutting thrust

• Ball screw torque 160 [kg cm] (See Fig. 16.)

• Total reduction ratio $K = \frac{4}{5}$

$$\begin{aligned} \text{Rotor torque } T &= 160 \times K \\ &= 160 \times \frac{4}{5} \\ &= 128 \text{ [kg} \cdot \text{cm]} \dots \text{ ②} \end{aligned}$$

Actual rotor torque is obtained as follows
Refer to Paragraph 9.1 1 (3)

$$\begin{aligned} 1000 \text{ kg} &= \frac{2\pi}{P \cdot K} \times T \\ &= \frac{4}{5} \times 10 \text{ [mm/rev]} \\ T &= \frac{2\pi}{2\pi} \times 1000 \times 10^{-1} \text{ [cm/mm]} \\ &= 127.4 \text{ [kg} \cdot \text{cm]} \end{aligned}$$

Therefore, actual motor torque is as follows

$$\text{①} + \text{②} = 25 + 128 = 153 \text{ [kg} \cdot \text{cm]}$$

(c) Maximum torque at cutting operation

$$165 \text{ [kg} \cdot \text{cm]} = 1.08 \times 153 \text{ [kg} \cdot \text{cm]}$$

$$\boxed{\text{Motor Torque at Cutting Operation } 153 \text{ [kg} \cdot \text{cm]}} \dots \text{ (B)}$$

From (A) and (B), Servomotor type UGHMED-20GG can be selected as the first motor selection. See Tables 2 and 3. In this example, Cup motor and Hi-Cup motor only are considered for the selection

(3) Motor Accelerating/Decelerating Torque at Quick Feed

(a) How to obtain total load inertia $GD^2/4$

- Ball screw inertia $GD^2/4$

Refer to Fig. 14.

Ball screw inertia = 30 [kg·cm²].....③

For calculation by the formula, see Paragraph 9.1.1(1).

- Ball screw shaft inertia $GD^2/4$ to moving member weight

Refer to No. 4 in APPENDIX and Fig. 15.

Ball screw shaft inertia = 29.5 [kg·cm²].....④

For calculation by the formula, see Paragraph 9.1.1(2)

- Rotor inertia $GD^2/4$ from load inertia $GD^2/4$

See Paragraph 9.1.1(2)

$$\begin{aligned} \text{Rotor inertia} &= (\textcircled{3} + \textcircled{4}) \times K^2 \\ &= (30 + 29.5) \times \left(\frac{4}{5}\right)^2 \\ &= 38.1 \text{ [kg} \cdot \text{cm}^2] \end{aligned}$$

However, No. 9 in APPENDIX, that is;

Rotor inertia = 68.9 [kg·cm²].....⑤

The rotor inertia in APPENDIX contains coupling and gear inertias. Therefore, 68.9 kg·cm² should be used to obtain the total load inertia $GD^2/4$

- Total load inertia $GD^2/4$

Rotor inertia of Hi-Cup motor type UGHMED-20 GG is 234 kg·cm². See Table 2. As a result of that,

$\begin{aligned} \text{Total Load Inertia } GD^2/4 &= 234 + \textcircled{5} \\ &= 234 + 68.9 \\ &= 302.9 \text{ [kg} \cdot \text{cm}^2] \end{aligned}$⑥
--	--------

(b) Accelerating/decelerating torque

Refer to Fig. 18. Where accelerating/decelerating time at quick feed $t_a = 0.2$ sec, total load inertia = 302.9 kg·cm² and motor speed = 1000 rpm, accelerating torque T_L is 160 kg·cm. However, since actual motor speed at quick feed is 1500 rpm, actual accelerating/decelerating torque is as follows,

$$\begin{aligned} \text{Accelerating/decelerating torque} &= 160 \times 1.5 \\ &= 240 \text{ [kg} \cdot \text{cm}] \dots\dots \textcircled{7} \end{aligned}$$

For calculation by the formula, see Paragraph 9.1.1(4).

(c) Friction torque at quick feed

$$T_f = 45 \text{ [kg} \cdot \text{cm}] \dots\dots \textcircled{8}$$

$\begin{aligned} \text{Actual Accelerating/Decelerating} \\ \text{Torque at Quick Feed} &= \textcircled{7} + \textcircled{8} \\ &= 240 + 45 \\ &= 285 \text{ [kg} \cdot \text{cm}] \end{aligned}$

(4) Final Motor Selection

- Motor Speed { at Quick Feed 1500 [rpm]
at Cutting Feed 300 [rpm]
- Motor Torque at Cutting Feed 153 [kg·cm]
- Motor Accelerating/Decelerating Torque at Quick Feed 285 [kg·cm]

The following Servomotor is selected in accordance with the values:

Hi-Cup Motor Type UGHMED-20 GG

9.1.3 Selected Motor Check

In combination of Hi-Cup motor type UGHMED with Servopack type PCR-MR225 GD, torque-speed characteristics of Fig. 19 can accept the three selecting criteria described in Paragraph 9.1.2 (4). Therefore, Hi-Cup motor type UGHMED-20 GG is selected.

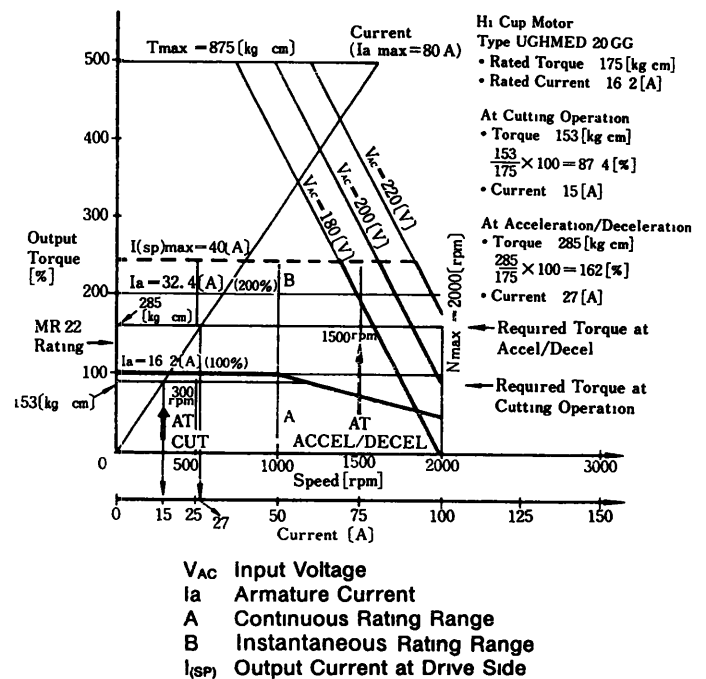

Fig. 19 Torque-Speed Characteristics in Combination of Hi-Cup Motor Type UGHMED-20 GG with Servopack Type PCR-MR225GD

Furthermore, these values are within limits of the following three items shown in Table 3 Characteristics in Combination of Servopack and Servomotor.

- Overspeed 1500 [rpm] = 1500 [rpm] (Motor speed at quick feed)
- Continuous Effective Torque at Rated Operation 166.3 [kg·cm] > 153 [kg·cm] (Motor torque at cutting feed)
- Instantaneous Effective Torque at Overspeed 438 [kg·cm] > 285 [kg·cm] (Motor accel/decel torque at quick feed)

9.2 Coasting Distance After YASNAC Emergency Stop

9.2.1 Calculation of Coasting Distance

The coasting distance after YASNAC emergency stop functions during quick feed is obtained as shown below

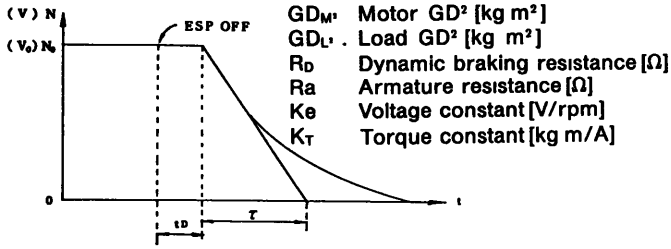

Fig 20 Coasting Distance

$$V = V_0 e^{-\frac{t}{\tau}} \quad \tau = \frac{(GD_M^2 + GD_L^2)(R_D + R_a)}{375 \cdot K_e \cdot K_T} \text{ [sec]} \dots\dots ①$$

The emergency stop is achieved by a dynamic brake. The coasting distance (S_{DB}) by the dynamic brake is obtained by the following formula.

$$S_{DB} = (V_0 \times t_D) + (V_0 \times \tau) \text{ [mm]} \dots\dots ②$$

V : Quick feed speed [mm/s]
 t_D : Delay time of emergency stop reference to deceleration [sec]
 τ : Decelerating constant [sec]

Fig. 21 shows relationship of S_{DB} and $GD_L^2/4$ for DC Servomotor (Cup Motor A series, Hi-Cup Motor G series). These relationships are obtained using formulas ① and ②, under $t_D = 0.04$ sec.

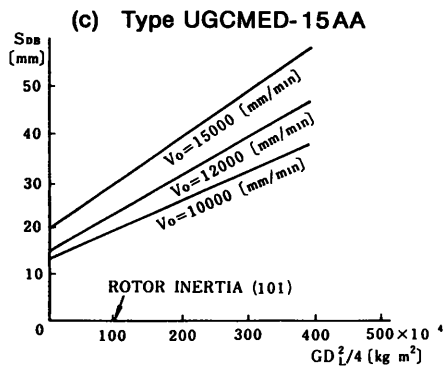
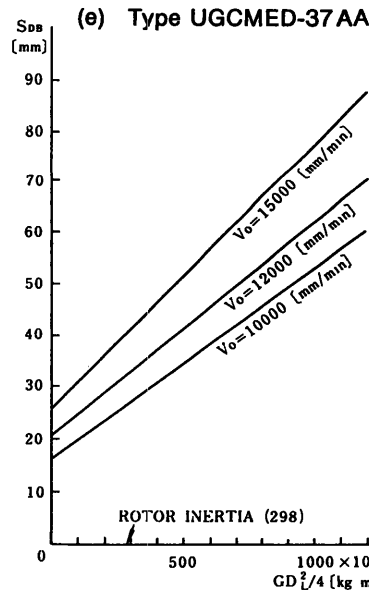
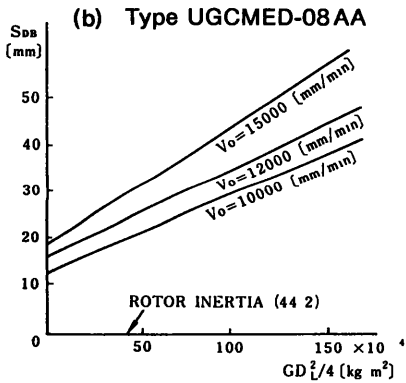
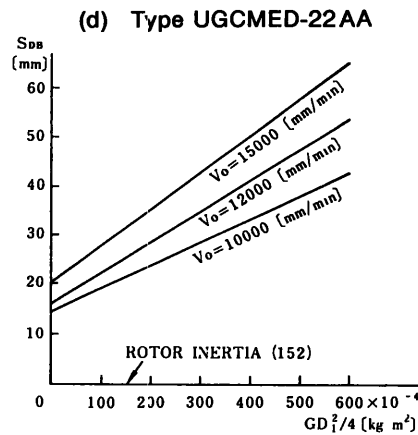
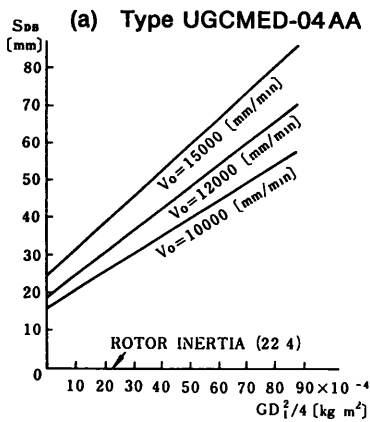

S_{DB} : Coasting distance after emergency stop [mm]
 V_0 : Quick feed speed [mm/min]
 GD_L : Load GD^2 [kg m²]

Fig 21 Relationship of S_{DB} and $GD_L^2/4$ for Cup Motor A Series

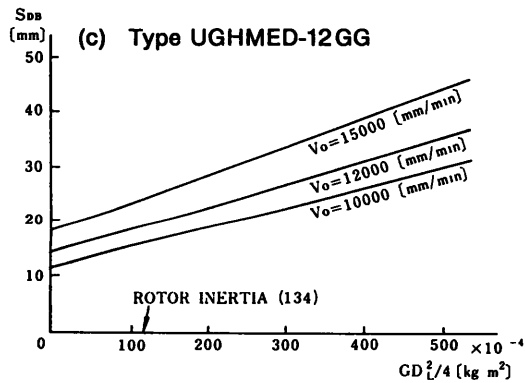
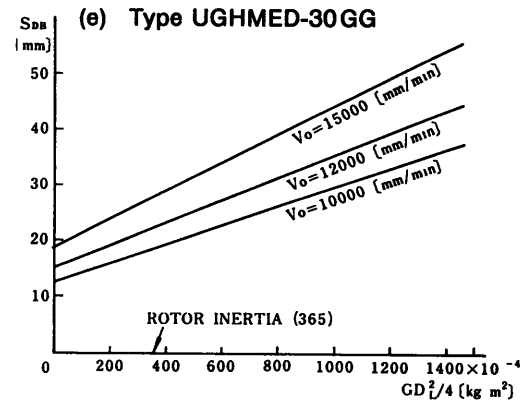
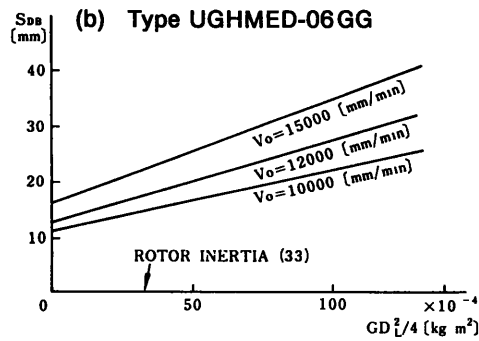
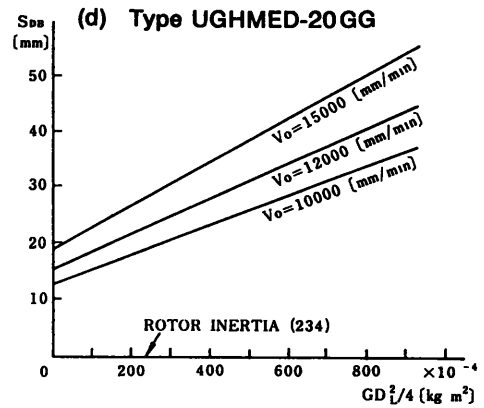
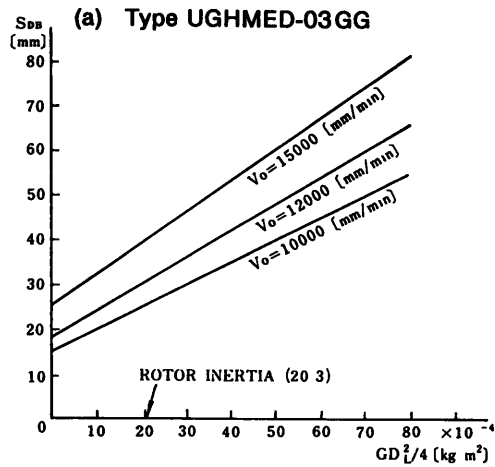

S_{DB} Coasting distance after emergency stop [mm]
 V_0 Quick feed speed [mm/min]
 GD_L^2 Load GD^2 [kg·m²]

Fig 22 Relationship of S_{DB} and $GD_L^2/4$ for Hi-Cup Motor G Series

9.3 Minimum Dog Length for Returning to Home Position

For returning to home position, minimum dog length is obtained by the following formula. Refer to Fig. 23.

$$L_D \geq \frac{(V_0 - V_1)^2}{2D_c} + V_0 \times t_c \text{ [mm]}$$

- V_0 : Quick feed speed [mm/sec]
- V_1 : Approach speed 1 [mm/sec]
- D_c : Quick feed accel/decel constant [mm/sec²]
- L_D : Dog length [mm]
- t_c : Delay time of emergency stop reference to deceleration [sec]
- V_2 : Approach speed 2 [mm/sec]

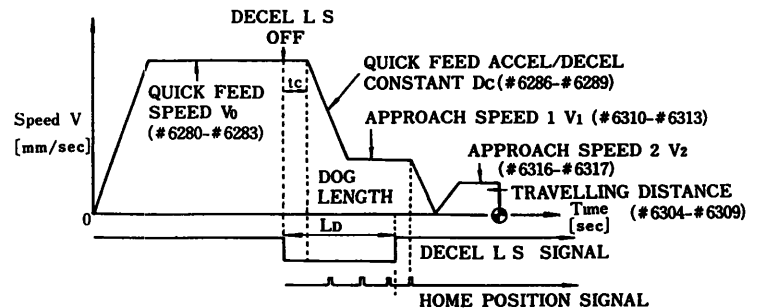

Fig 23 Time Chart for Returning to Home Position

APPENDIX SELECTION LIST OF DC SERVO MOTOR FOR YASNAC

Selection List of DC Servomotor for YASNAC

MACHINE NAME	
MACHINE TYPE	
CNC NAME	YASNAC

APPVL.	CK.	SEL

No.	Items	X	Y	Z
1	Moving Direction (Horizontal, Vertical, Rotating, Diagonal)	Horizontal		
2	Max Stroke (between Machine Ends) (mm)	1000		
3	Table Support (Slip, Rolling)	Slip		
4	Moving Member Weight (with Workpiece) (kg)	1180		
5	Counterbalance (kg)	—		
6	Ball Screw	Diameter (mm)	40	
		Lead (mm)	10	
		Length (mm)	1506	
7	Total Reduction Ratio	4/5		
8	Friction Coefficient			
9	Rotor Inertia $GD^2/4$ (kg-cm ²)	68.9		
10	Load Torque	At Low Feed (kg-cm)	25	
		At Quick Feed (kg-cm)	45	
		Cutting Thrust (kg)	1000	
		At Max Cutting (kg-cm)	165	
11	Duty	Max Cutting Duty (% ED-min)	45%/12 min	
		Positioning Frequency (sec/time)	5	
12	Quick Feed (mm/min)	12,000		
13	Max Cutting Speed (mm/min)	2400		
14	Position Detection Method			
15	Detector	Type TFUE-		
		Feed per Revolution (mm/rev)		
16	Motor	Type		
		Quick Feed Speed (rpm)	1500 →	Obtained in Paragraph 9 1 2 (a)
17	Servopack Type PCR-			
18	Position Loop Gain Kp (sec ⁻¹)			
19	Decelerating Distance	Deceleration Stop (mm)		
		Emergency Stop (mm)		
		Zero Point Dog Length (mm)		
20	Remarks	Accelerating/Decelerating Time at Quick Feed: 0.2 [sec]		



A Better Tomorrow for Industry through Automation

YASKAWA Electric Mfg. Co., Ltd.

TOKYO OFFICE Ohtemachi Bldg. Chiyoda-ku, Tokyo, 100 Japan
 Phone (03) 284-9111, -9145 -9146 Telex YASKAWA J33530 Fax (03) 284-9034

TAIPEI OFFICE Union Commercial Bldg., 137, Nanking East Road Sec 2 Taipei Taiwan
 Phone (2) 531-7732, 551-7065 Fax (2) 537-3837

YASKAWA ELECTRIC AMERICA, INC SUBSIDIARY
Chicago Office/YASNAC America
 3160 MacArthur Blvd., Northbrook, Illinois 60062 U S A
 Phone (312) 291-2348 Telex (230) 270197 YSKW YSNC NBRK Fax (312) 564-3276

Los Angeles Office
 14811 Myford Road, Tustin, California 92680 U S A
 Phone (714) 731-6841 Telex (230) 678396 YASKAWAUS TSTN Fax (714) 730-8294

New Jersey Office 769 Northfield Ave., Suite 140 West Orange NJ 07052 U S A
 Phone (201) 325-7397 Fax (201) 325-7398

YASKAWA ELECTRIC EUROPE GmbH SUBSIDIARY
 Monschauerstrasse 1, 4000 Düsseldorf 11, West Germany
 Phone (0211) 501127 Telex (41) 8588673 YASD D Fax (0211) 507737

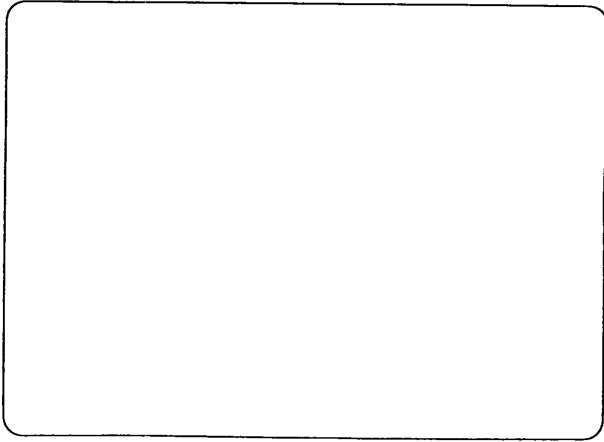

Due to ongoing product modification/improvement, data subject to change without notice