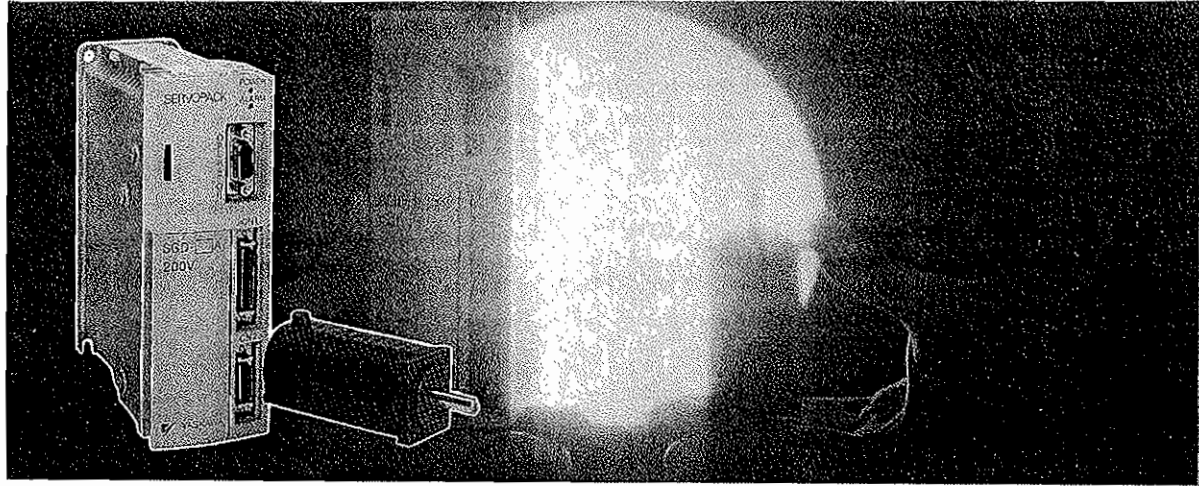


Σ SERIES SGM/SGD

AC SERVO DRIVES WITH INCREMENTAL/ABSOLUTE ENCODER
FOR POSITIONING CONTROL

SERVOMOTOR: TYPES SGM- A 1 , SGM- B 1
SERVOPACK: TYPES SGD- AP, SGD- BP



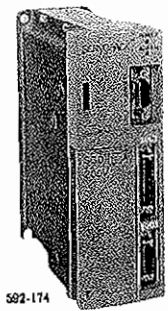
Yaskawa AC Servo Drives with absolute encoder have been developed as basic mechatronics drives for the most advanced FA and FMS, including robots and machine tools. In addition, Σ series has been newly developed.

This manual covers AC servo drive Σ series for speed (torque) control. AC Servo Drives consist primarily of AC SERVOMOTORS and their controllers, SERVOPACKS. The AC SERVOMOTOR features a high power rating for achieving quick response. Custom LSI and hybrid ICs built in SERVOPACK reduce the unit size and simplify wiring. The additional feature of a highly accurate pulse resolution offers non-stop pulse flow.

For your mechatronics systems, the flexible combination of our AC SERVOMOTOR and SERVOPACK achieves stable control operation with high accuracy, quick response control under any environmental condition, and easy maintenance by display/protective functions.

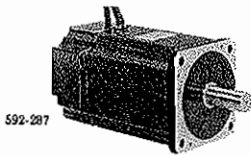
FEATURES

- (1) Highest power rating and fastest response in the class
- (2) For SGM SERVOMOTORS:
1/3 the size and weight of conventional models
For SGD SERVOPACKS :
1/4 the size of conventional models.
- (3) Both incremental and absolute encoders available in a base-mounted SERVOPACK
- (4) Easily operated with an auto tuning function
- (5) High performance with a speed control range of 1 : 5000 realized
- (6) Number of wires between the motor and the encoder is reduced from 15 to 9 (with incremental encoder).
- (7) Can be installed under any environmental condition due to varnish coating.

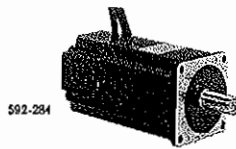


592-174

SERVOPACK

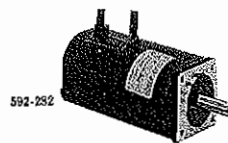


592-287



592-284

SERVOMOTOR



592-252



592-28

DIGITAL OPERATOR

CONTENTS

	Page
1. RATINGS AND SPECIFICATIONS	1
1.1 RATINGS AND SPECIFICATIONS OF SGM SERVOMOTORS (200 VAC)	1
1.1.1 Ratings and Specifications	1
1.1.2 Torque-Speed Characteristics	3
1.2 RATINGS AND SPECIFICATIONS OF SGM SERVOMOTORS (100 VAC)	4
1.2.1 Ratings and Specifications	4
1.2.2 Torque-Speed Characteristics	5
1.3 RATINGS AND SPECIFICATIONS OF SGD SERVOPACKS	6
2. TYPE DESIGNATION	8
2.1 OUTLINE OF SYSTEM	8
2.2 TYPE DESIGNATION	8
3. LIST OF STANDARD COMBINATION	10
4. CHARACTERISTICS	11
4.1 OVERLOAD CHARACTERISTICS	11
4.2 STARTING AND STOPPING TIME	12
4.3 ALLOWABLE FREQUENCY OF OPERATION	13
4.4 SERVOMOTOR FREQUENCY	15
4.5 MOTOR MECHANICAL CHARACTERISTICS	16
4.5.1 Mechanical Strength	16
4.5.2 Allowable Radial Load and Thrust Load	16
4.5.3 Mechanical Specifications	16
4.5.4 Direction of Rotation	17
4.5.5 Impact Resistance	18
4.5.6 Vibration Resistance	18
4.5.7 Vibration Class	18
5. CONFIGURATION	19
5.1 CONNECTION DIAGRAM	19
5.2 EXTERNAL TERMINALS	20
5.3 APPLICABLE RECEPTACLES	20
5.3.1 1CN (Connector for I/O Signals)	20
5.3.2 2CN (Connector for Encoder)	20
5.4 CONNECTION (WITH INCREMENTAL ENCODER)	21
5.4.1 Connection Diagram	21
5.4.2 Connector 1CN for I/O Signals	22
5.5 CONNECTION (WITH ABSOLUTE ENCODER)	28
5.5.1 Connection Diagram	28
5.5.2 Connector 1CN for I/O Signals	29
5.6 OUTPUT CIRCUIT	33
5.6.1 Encoder (PG) Output Circuit	33

CONTENTS (Cont'd)

	Page
5.7 CONNECTOR TO TERMINAL CONVERSION UNIT FOR 1CN (PERIPHERAL DEVICES FOR SGD SERVOPACK)	35
5.8 CONNECTOR 2CN FOR OPTICAL ENCODER	36
5.8.1 Connector 2CN Layout	36
5.8.2 Cable Specifications	37
5.8.3 Connection	38
6. OPERATION	39
6.1 POWER ON AND OFF	39
6.2 POSITION CONTROL	41
6.2.1 Input Reference Pulse Logic Level	41
6.2.2 Reference Pulse Form	41
6.2.3 Reference Pulse Timing	42
6.2.4 Reference Pulse (including CLR Input) Interface	43
6.2.5 Clear Input Signal	44
6.2.6 Positioning Completion Signal (COIN)	44
6.2.7 I/O Signal Timing	44
6.2.8 Function of Electronic Gears	45
6.2.9 Smoothing	47
6.2.10 Feed Forward	47
6.3 USE OF 12-BIT ABSOLUTE ENCODER	48
6.3.1 Output Signal Processing Circuit	49
6.3.2 Serial Data Specification for Phase-S (PSO) No. of Rotations	50
6.3.3 Incremental Pulse	51
6.3.4 Power ON to Absolute Encoder	52
6.3.5 Battery	52
6.3.6 Setup Method for 12-bit Absolute Encoder	53
6.3.7 Alarm Output of the 12-bit Absolute Encoder	54
6.4 PROTECTIVE FUNCTIONS	57
6.4.1 Dynamic Brake Function	57
6.4.2 Alarm Detection Functions	58
6.4.3 Servo Alarm Output (ALM, ALM-SG)	59
6.4.4 Protective Circuit Operation	59
6.4.5 Resetting Servo Alarm	59
6.5 DISPLAY	59
6.6 PRECAUTIONS FOR APPLICATION	59
6.6.1 Overheating Loads	59
6.6.2 Load Inertia J_L	60
6.6.3 Regenerative Unit (Peripheral Device for SGD SERVOPACK)	61
6.6.4 High Voltage Line	62
6.7 PRECAUTIONS OF OPERATION	63
6.7.1 Noise Control	63
6.7.2 Power Line Protection	66

CONTENTS (Cont'd)

	Page
6.8 APPLICATION	67
6.8.1 Connection for Reverse Motor Running	67
6.8.2 Holding Brake Interlock Signal	68
7. USER CONSTANTS	69
8. DIGITAL OPERATOR (TYPES : JUSP-OP02A-1, 03A)	77
8A. DIGITAL OPERATOR (TYPE : JUSP-OP02A-1) OPERATION METHOD	77
8A.1 SWITCH OPERATION	77
8A.2 DIGITAL OPERATOR FUNCTIONS	78
8A.3 STATUS INDICATION MODE	79
8A.4 SETTING MODE	80
8A.4.1 User Constant (Data) Setup and Monitor (Cn-03 to Cn-23)	80
8A.4.2 User Constant (Memory Switch) Setup and Monitor (Cn-01 and Cn-02)	81
8A.4.3 Digital Operator Controlled Operation Mode Selection and Operating Procedure	82
8A.4.4 Clearing Fault Traceback Data	84
8A.4.5 Check of Motor Parameters	85
8A.4.6 Auto Tuning	87
8A.4.7 Check of Software Version	91
8A.5 MONITOR MODE	93
8A.6 FAULT TRACEBACK MODE	95
8B. DIGITAL OPERATOR (TYPE : JUSP-OP03A) OPERATION METHOD	97
8B.1 SWITCH OPERATION	97
8B.2 DIGITAL OPERATOR FUNCTIONS	98
8B.3 STATUS INDICATION MODE	99
8B.4 SETTING MODE	100
8B.4.1 User Constant (Data) Setup and Monitor (Cn-03 to Cn-23)	100
8B.4.2 User Constant (Memory Switch) Setup and Monitor (Cn-01 and Cn-02)	102
8B.4.3 Digital Operator Controlled Operation Mode Selection and Operating Procedure	103
8B.4.4 Clearing Fault Traceback Data	105
8B.4.5 Check of Motor Parameters	106
8B.4.6 Auto Tuning	108
8B.4.7 Check of Software Version	112
8B.5 MONITOR MODE	114
8B.6 FAULT TRACEBACK MODE	116
9. INSTALLATION AND WIRING	118
9.1 RECEIVING	118
9.2 INSTALLATION	118
9.2.1 SGM SERVOMOTOR	118
9.2.2 SGD SERVOPACK	119

CONTENTS (Cont'd)

	Page
9.3 WIRING	121
9.3.1 Rated Current Cable Size	121
9.3.2 Wiring Precautions	123
10. OUTSIDE DIMENSIONS	124
10.1 SGM SERVOMOTOR	124
10.2 SGD SERVOPACK	148
10.3 REGENERATIVE UNIT	149
10.4 DIGITAL OPERATOR	150
10.5 CABLES	151
10.5.1 When Provided by YASKAWA	151
10.5.2 When Connector on SERVOPACK Side is Provided by User	153
10.5.3 Cable without Connector	155
10.6 CONNECTOR KIT	157
10.7 NOISE FILTER	159
10.8 PERIPHERAL DEVICES	159
11. TEST RUN	161
11.1 CHECK ITEMS BEFORE TEST RUN	161
11.1.1 SGM SERVOMOTOR	161
11.1.2 SGD SERVOPACK	161
11.2 TEST RUN PROCEDURES	161
11.2.1 Preparation for Operation	161
11.2.2 Operation	162
11.2.3 Inspection during Test Run	162
12. ADJUSTMENT	163
12.1 CHARACTERISTICS PRESET AT THE FACTORY PRIOR TO SHIPMENT	163
12.2 RESET	164
13. INSPECTION AND MAINTENANCE	165
13.1 SGM SERVOMOTOR	165
13.2 SGD SERVOPACK	165
13.3 PRECAUTIONS FOR BATTERY REPLACEMENT	165
14. TROUBLESHOOTING	166
14.1 SGM SERVOMOTOR	166
14.2 SGD SERVOPACK	167
14.2.1 LED Indication (7-segment) for Troubleshooting	167
14.2.2 Examples of Troubleshooting for Defective Wiring or Parts	170
14.2.3 Examples of Errors Resulting Setting Errors	170
14.2.4 Cause and Corrective Actions :	
No Alarm is Displayed but the Motor does not Run	171

1. RATINGS AND SPECIFICATIONS

1.1 RATINGS AND SPECIFICATIONS OF SGM SERVOMOTORS (200 VAC)

1.1.1 Ratings and Specifications

Time Rating : Continuous
 Insulation : Class B
 Withstand Voltage : 1500 VAC
 Insulation Resistance : 500 VDC, 10 M Ω or more
 Enclosure : Totally-enclosed, self-cooled

Ambient Temperature : 0 to +40°C
 Ambient Humidity : 20 to 80% (non-condensing)
 Vibration : 15 μ m or below
 Excitation : Permanent magnet
 Mounting : Flange-mounted
 Drive Method : Direct drive

Table 1.1 Ratings and Specifications of SGM SERVOMOTORS (200 VAC)

Motor Type SGM-		A3A312	A5A312	01A312	02A312	04A312	08A312
Rated Output*	W (HP)	30 (0.04)	50 (0.07)	100 (0.13)	200 (0.27)	400 (0.53)	750 (1.01)
Rated Torque*	N · m	0.095	0.159	0.318	0.637	1.27	2.39
	(oz · in)	(13.5)	(22.6)	(45.1)	(90.1)	(181)	(338)
Instantaneous Peak Torque*	N · m	0.29	0.48	0.96	1.91	3.82	7.1
	(oz · in)	(40.5)	(67.7)	(135)	(270)	(542)	(1010)
Rated Current*	A (rms)	0.42	0.6	0.87	2.0	2.6	4.4
Instantaneous Max Current*	A (rms)	1.3	1.9	2.8	6.0	8.0	13.9
Rated Speed*	r/min	3000					
Instantaneous Max Speed*	r/min	4500					
Torque Constant*	N · m/A (rms)	0.255	0.286	0.408	0.355	0.533	0.590
	(oz · in/A) (rms)	(36.2)	(40.5)	(57.8)	(50.2)	(75.5)	(83.5)
Moment of Inertia $J_M (= GD^2 M/4)$	kg · m ² × 10 ⁻⁴	0.021	0.026	0.040	0.123	0.191	0.671
	(oz · in · s ² × 10 ⁻⁷)	(0.288)	(0.368)	(0.576)	(1.74)	(2.70)	(9.52)
Power Rating*	kW/s	4.36	9.63	25.4	32.8	84.6	85.1
Rated Angular Acceleration*	rad/s ²	45200	61200	79500	51800	66600	35600
Inertia Time Constant	ms	1.5	0.9	0.5	0.4	0.3	0.3
Inductive Time Constant	ms	1.5	1.8	1.9	5.4	6.4	13

Notes :

- Items marked with * and the torque-speed characteristic are measured when the armature winding combined with the SGD SERVOPACK is 100°C. Other figures are measured when the temperature is 20°C. All the figures are typical values.
- Rated torque is the continuous allowable torque when the motor is mounted to a heat sink of 250 × 250 × 6 (mm) and the ambient temperature is 40°C.
- When shaft seal is mounted on a motor, run the motor at the following derating factor because of increase of friction torque.

SGM-	A3A	A5A	01A	02A	04A	08A
Derating Rate (%)	70	80	90	90	95	95

1.1.1 Ratings and Specifications (Cont'd)

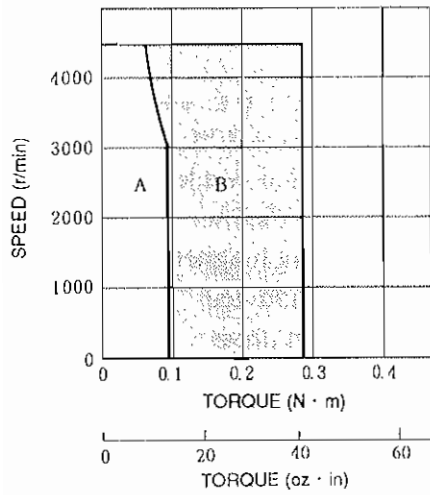
[OPTION]

When options are applied, inertia is increased as shown in the following table.
 Characteristics may vary accordingly.

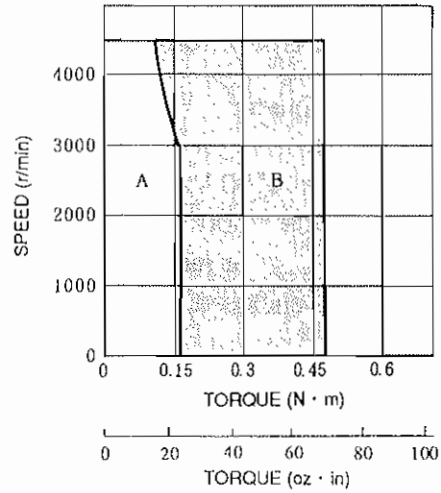
Item	Type	SGM-					
		A3A	A5A	01A	02A	04A	08A
With Holding Brake	$\text{kg} \cdot \text{m}^2 \times 10^{-4}$ $(\text{oz} \cdot \text{in} \cdot \text{s}^2 \times 10^{-3})$		0.0085 (0.120)		0.058 (0.816)		0.14 (1.98)
With 12-bit Absolute Encoder	$\text{kg} \cdot \text{m}^2 \times 10^{-4}$ $(\text{oz} \cdot \text{in} \cdot \text{s}^2 \times 10^{-3})$				0.025 (0.352)		

1.1.2 Torque-Speed Characteristics

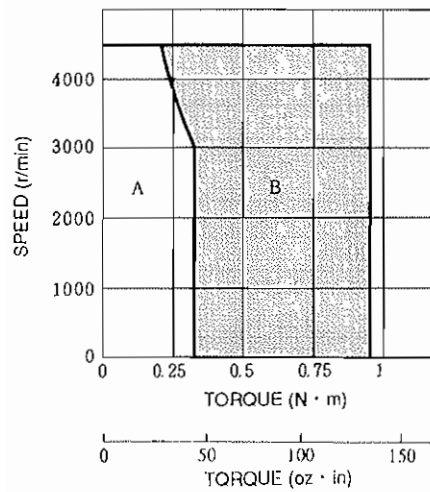
· TYPE SGM-A3A



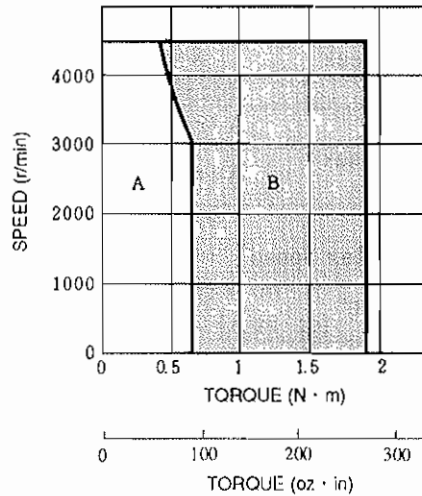
· TYPE SGM-A5A



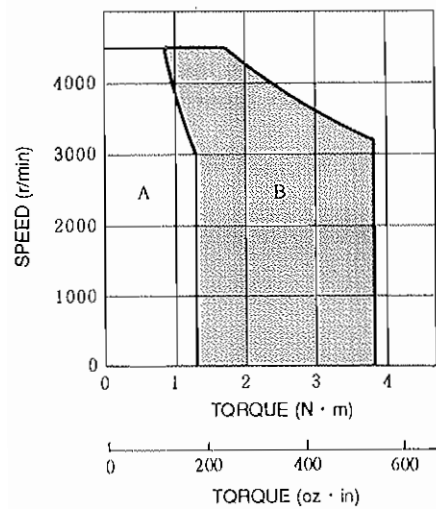
· TYPE SGM-01A



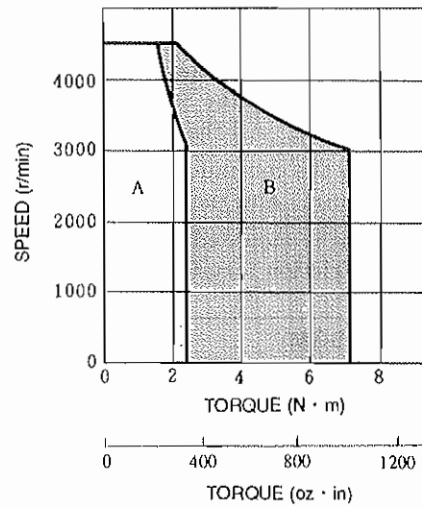
· TYPE SGM-02A



· TYPE SGM-04A



· TYPE SGM-08A



A : CONTINUOUS DUTY ZONE

B : INTERMITTENT DUTY ZONE

1.2 RATINGS AND SPECIFICATIONS OF SGM SERVOMOTORS (100 VAC)

1.2.1 Ratings and Specifications

Time Rating : Continuous	Ambient Temperature : 0 to +40°C
Insulation : Class B	Ambient Humidity : 20 to 80%
With stand Voltage : 1500 VAC	(non-condensing)
Insulation Resistance : 500 VDC, 10 MΩ or more	Vibration : 15 μm or below
Enclosure : Totally-enclosed, self-cooled	Excitation : Permanent magnet
	Mounting : Flange-mounted
	Drive Method : Direct drive

Table 1.2 Ratings and Specifications of SGM SERVOMOTORS (100 VAC)

Motor Type SGM-		A3B312	A5B312	01B312	02B312
Rated Output *	W (HP)	30 (0.04)	50 (0.07)	100 (0.13)	200 (0.27)
Rated Torque *	N · m	0.095	0.159	0.318	0.637
	(oz · in)	(13.5)	(22.6)	(45.1)	(90.1)
Instantaneous Peak Torque *	N · m	0.29	0.48	0.96	1.91
	(oz · in)	(40.5)	(67.7)	(135)	(270)
Rated Current *	A (rms)	0.63	0.9	2.2	2.7
Instantaneous Peak Current *	A (rms)	2.0	2.9	7.1	8.4
Rated Speed *	r/min	3000			
Instantaneous Max Speed *	r/min	4500			
Torque Constant *	N · m/A (rms)	0.168	0.194	0.156	0.255
	(oz · in/A) (rms)	(23.8)	(27.5)	(22.1)	(36.1)
Moment of Inertia $J_M (= GD^2 M/4)$	kg · m ² × 10 ⁻⁴	0.021	0.026	0.040	0.123
	(oz · in · s ² × 10 ⁻³)	(0.288)	(0.368)	(0.576)	(1.74)
Power Rating *	kW/s	4.36	9.63	25.4	32.8
Rated Angular Acceleration *	rad/s ²	45200	61200	79500	51800
Inertia Time Constant	ms	1.6	0.9	0.6	0.4
Inductive Time Constant	ms	1.3	1.6	1.6	5.7

Notes :

- Items marked with * and the torque-speed characteristic are measured when the armature winding combined with the SGD SERVOPACK is 100°C. Other figures are measured when the temperature is 20°C. All the figures are typical values.
- Rated torque is the continuous allowable torque when the motor is mounted to a heat sink of 250 × 250 × 6 (mm) and the ambient temperature is 40°C.
- When shaft seal is mounted on a motor, run the motor at the following derating factor because of increase of friction torque.

SGM-	A3B	A5B	01B	02B
Derating Rate (%)	70	80	90	90

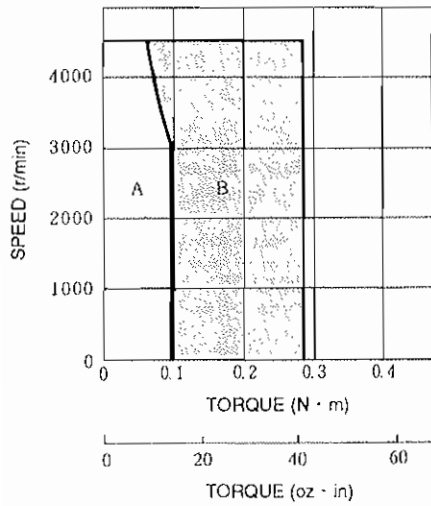
[OPTION]

When options are applied, inertia is increased as shown in the following table. Characteristics may vary accordingly.

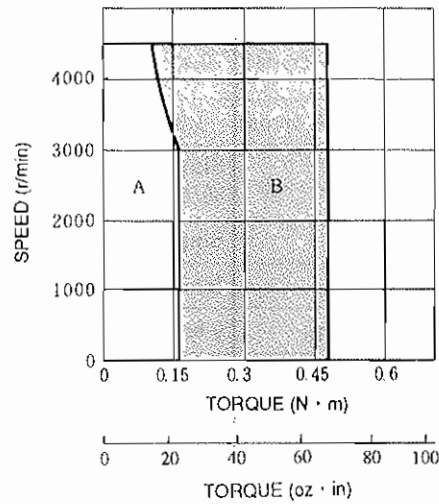
Item	Type	SGM--			
		A3B	A5B	01B	02B
With Holding Brake	$\text{kg} \cdot \text{m}^2 \times 10^{-4}$ $(\text{oz} \cdot \text{in} \cdot \text{s}^2 \times 10^{-3})$		0.0085 (0.120)		0.058 (0.816)
With 12-bit Absolute Encoder	$\text{kg} \cdot \text{m}^2 \times 10^{-4}$ $(\text{oz} \cdot \text{in} \cdot \text{s}^2 \times 10^{-3})$			0.025 (0.352)	

1.2.2 Torque-Speed Characteristics

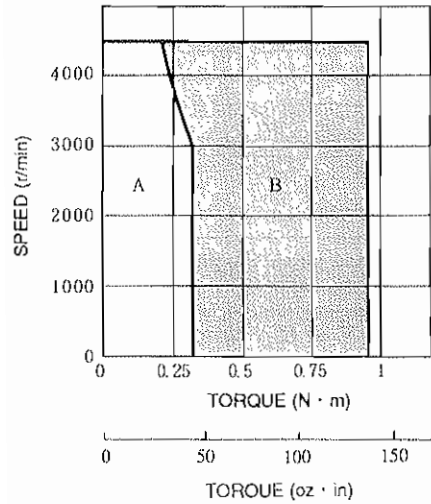
· TYPE SGM-A3B



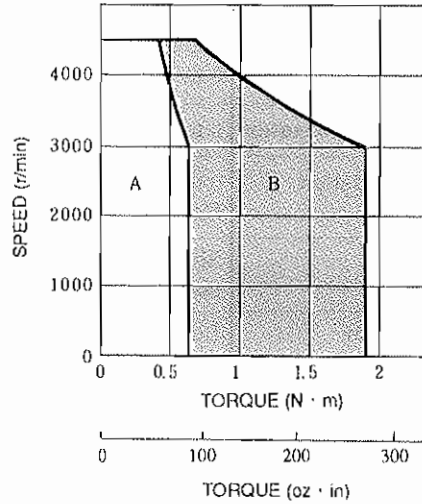
· TYPE SGM-A5B



· TYPE SGM-01B



· TYPE SGM-02B



A : CONTINUOUS DUTY ZONE

B : INTERMITTENT DUTY ZONE

1.3 RATINGS AND SPECIFICATIONS OF SGD SERVOPACKS

Table 1.3 Ratings and Specifications of SGD SERVOPACKS

Applied Voltage		200 VAC						100 VAC						
SERVOPACK Type	SGD-	A3AP	A5AP	01AP	02AP	04AP	08AP	A3BP	A5BP	01BP	02BP			
Max Motor Capacity	W (HP)	30 (0.04)	50 (0.07)	100 (0.13)	200 (0.27)	400 (0.53)	750 (1.01)	30 (0.04)	50 (0.07)	100 (0.13)	200 (0.27)			
Applicable SERVOMOTORS	Type	A3A[]	A5A[]	01A[]	02A[]	04A[]	08A[]	A3B[]	A5B[]	01B[]	02B[]			
	Motor Capacity	30	50	100	200	400	750	30	50	100	200			
	Rated/Max Rotation Speed	3000/4500 r/min						3000/4500 r/min						
	Applicable Encoder	Incremental encoder 2048P/R, 2000P/R, absolute encoder 1024P/R												
	Allowable Load Inertia *1	$\text{kg} \cdot \text{m}^2 \times 10^{-1}$ $\text{oz} \cdot \text{in} \cdot \text{s}^2 \times 10^{-3}$	0.63 (8.80)	0.78 (11.0)	1.20 (17.0)	3.69 (52.2)	3.82 (54.1)	13.4 (189)	0.63 (8.80)	0.78 (11.0)	1.20 (17.0)	3.69 (52.2)		
	Continuous Output Current	A (rms)	0.42	0.60	0.87	2.0	2.6	4.4	0.63	0.90	2.2	2.7		
	Max Output Current	A (rms)	1.3	1.9	2.8	6.0	8.0	13.9	2.0	2.9	7.1	8.4		
Power Supply		Single-phase 200 to 230 VAC, +10 to -15%, 50/60 Hz						Single-phase 100 to 115 VAC*2, +10 to -15%, 50/60 Hz						
Control Method		Single-phase full-wave rectifier IGBT-PWM (Sine-wave drive)												
Feedback Pulse		Incremental encoder 2048P/R, absolute encoder 1024P/R												
Basic Specifications	Location	Ambient Temp.	0 to 55°C*3											
		Storage Temp.	-20 to +85°C											
		Ambient and Storage Humidity	90% or less (non-condensing)											
		Vibration/ Shock Resistance	0.5/2 G											
Structure		Base-mounted												
Approx. Mass		kg (lb)			0.9 (1.98)			1.2 (2.65)		1.5 (3.31)		0.9 (1.98)		1.2 (2.65)
Bias Setting		0 to 450 r/min (Setting resolution : 1 r/min)												
Feed Forward Compensation		0 to 100% (Setting resolution : 1%)												
Positioning Completion Width Setting		0 to 250 reference unit Reference unit : minimum unit of position data												
Input Signal	Reference Pulse	Type	SIGN + PULSE, 90° phase difference 2-phase pulse (A-phase + B-phase) CCW pulse + CW pulse											
		Pulse Form	Line driver (+5 V level), open collector (+5 V or 12 V level)											
		Pulse Frequency	0 to 450 kpps											
Control Signal		CLEAR (input pulse form is the same as that of reference pulse)												

Table 1.3 Ratings and Specifications of SGD SERVOPACKS (Cont'd)

Applied Voltage		200 VAC						100 VAC			
SERVOPACK Type	SGD	A3AP	A5AP	01AP	02AP	04AP	08AP	A3BP	A5BP	01BP	02BP
Max Motor Capacity	W (HP)	30 (0.04)	50 (0.07)	100 (0.13)	200 (0.27)	400 (0.53)	750 (1.01)	30 (0.04)	50 (0.07)	100 (0.13)	200 (0.27)
I/O Signals	Position Output	Output Form A-, B-, C-phase, line driver									
		Freq. Dividing Ratio (16 to N)/N = 2048, 2000, 1024 * ¹ ("N" represents number of encoder pulses)									
	Sequence Input	Servo ON, P drive (or motor run/stop by internal setting speed), forward run stop (P-OT), reverse run stop (N-OT), alarm reset, current limit/select (or internal speed select)									
	Sequence Output	TGON (or current limit detection), positioning completion brake interlock, servo alarm, alarm code (3 bits)									
Dynamic Brake		Operated at main power OFF, servo alarm, servo OFF									
External Regenerative Unit		Required when exceeding the allowable load inertia* ¹									
Overtravel		DB stop at P-OT, N-OT or deceleration stop									
Protective Function		Overcurrent, grounding, overload, overvoltage, overspeed, overrun prevention, origin error, CPU error, encoder error, overflow									
Indication		Alarm (7-segment LEDs), power supply (MCCB LED) Programming panel is available as an option									
Others		Soft start/stop, brake interlock signal output, reverse run connection, JOG run, electronic gear, auto tuning									

*1 The allowable load inertia specifies the range requiring no optional regenerative unit. Allowable load inertia is 30 times the motor rotor inertia for 30W to 200W classes ; 20 times for 400W and 750W classes. If a load inertia over the specified allowable value is to be applied, use a regenerative unit or operations may be limited.

*2 Supply voltage should not exceed 230V +10% (253V) or 115V +10% (127V). If the voltage should exceed these values, a step-down transformer is required.

*3 When housed in a panel, the internal temperature must not exceed ambient temperature range.

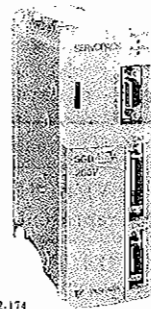
*4 "N" shows the number of encoder pulses.

As for the 2000P/R encoder, only the following frequency dividing ratios can be used :
1/2, 1/4, 1/5, 1/8, 1/10, 1/16, 1/20, 1/25.

2. TYPE DESIGNATION

2.1 OUTLINE OF SYSTEM

- SGD SERVOPACK



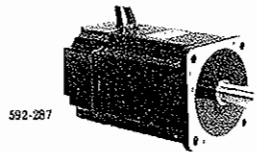
592-174



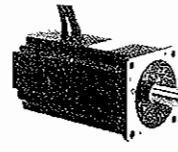
592-28

SGD SERVOPACK DIGITAL OPERATOR

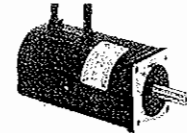
- SGM SERVOMOTOR



592-287



592-284



592-282

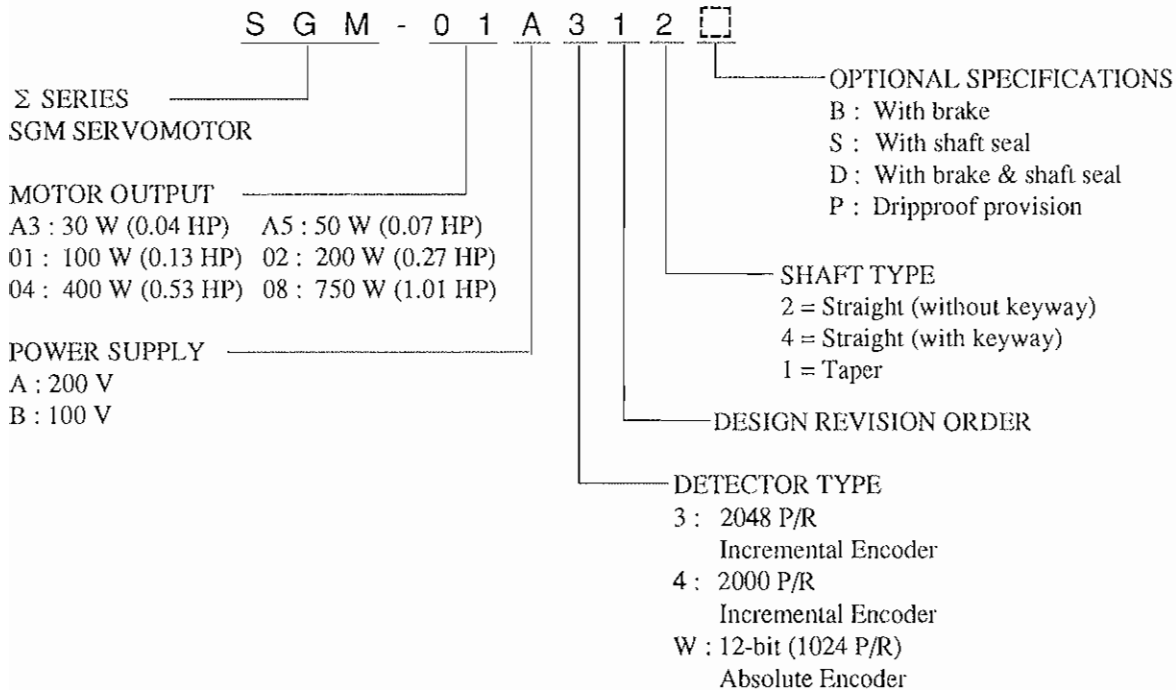
750 W (1.01 HP)

200 W (0.27 HP)
400 W (0.53 HP)

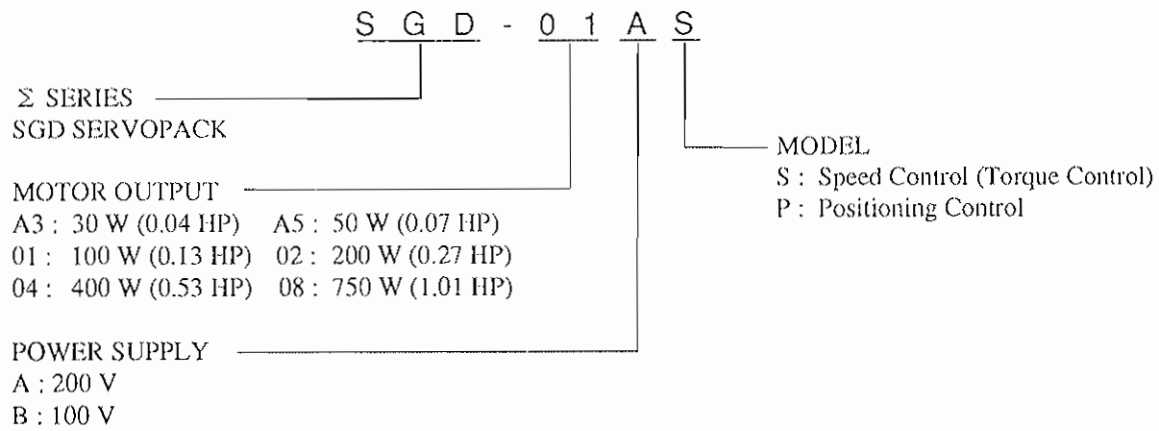
30 W (0.04 HP)
50 W (0.07 HP)
100 W (0.13 HP)

2.2 TYPE DESIGNATION

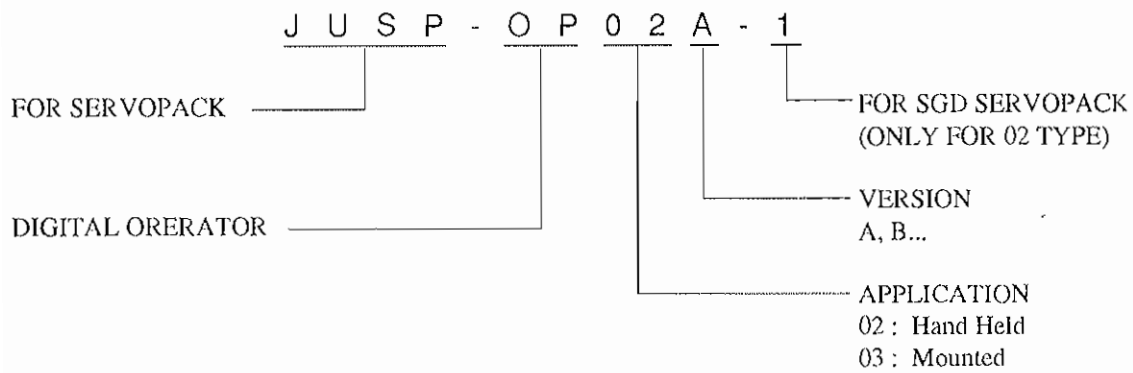
(1) SGM SERVOMOTOR



(2) SGD SERVOPACK





(3) DIGITAL OPERATOR



3. LIST OF STANDARD COMBINATION

Table 3.1 Combination of SGM SERVOMOTOR, SGD SERVOPACK and Accessories

CLASS	SERVOPACK Type SGD-		SERVOMOTOR Type SGM-	Power Capacity per SERVOPACK* ¹ kVA	Current Capacity per MCCB or Fuse* ² A	Applicable Noise Filter	Recommended* ³ Noise Filter		Power ON/OFF Switch
	Type	Specification	Type	Type	Type	Type	Specification		
200 VAC	30 W (0.04 HP)	A3AP	A3A	0.25	5	(Good) 	LF-205A	Single- phase 200 VAC Class 5 A	Contactor 30 A or above
	50 W (0.07 HP)	A5AP	A5A	0.3					
	100 W (0.13 HP)	01AP	01A	0.5					
	200 W (0.27 HP)	02AP	02A	0.75					
	400 W (0.53 HP)	04AP	04A	1.2	9	LF-210	Single- phase 200 VAC Class 10 A		
	750 W (1.01 HP)	08AP	08A	2.2	16	(Poor) 	LF-220	Single- phase 200 VAC Class 20 A	
100 VAC	30 W (0.04 HP)	A3BP	A3B	0.25	5		LF-205A	Single- phase 200 VAC Class 5 A	
	50 W (0.07 HP)	A5BP	A5B	0.3					
	100 W (0.13 HP)	01BP	01B	0.5					
	200 W (0.27 HP)	02BP	02B	0.75	8		LF-210	Single- phase 200 VAC Class 10 A	

*1 Values at rated load

*2 Overload characteristics (25°C) : 200% 2s or more, 700% 0.01s or more

*3 Made by Tokin Corp. Contact YASKAWA sales representative for detail.

4. CHARACTERISTICS

4.1 OVERLOAD CHARACTERISTICS

The overload protective function built in SGD SERVOPACK prevents the SGM SERVOMOTOR and SGD SERVOPACK from overloading and restricts the allowable conduction time of SGD SERVOPACK (See Fig. 4.1).

The overload detection level is set precisely by the hot start conditions at an ambient temperature of 55°C and cannot be changed.

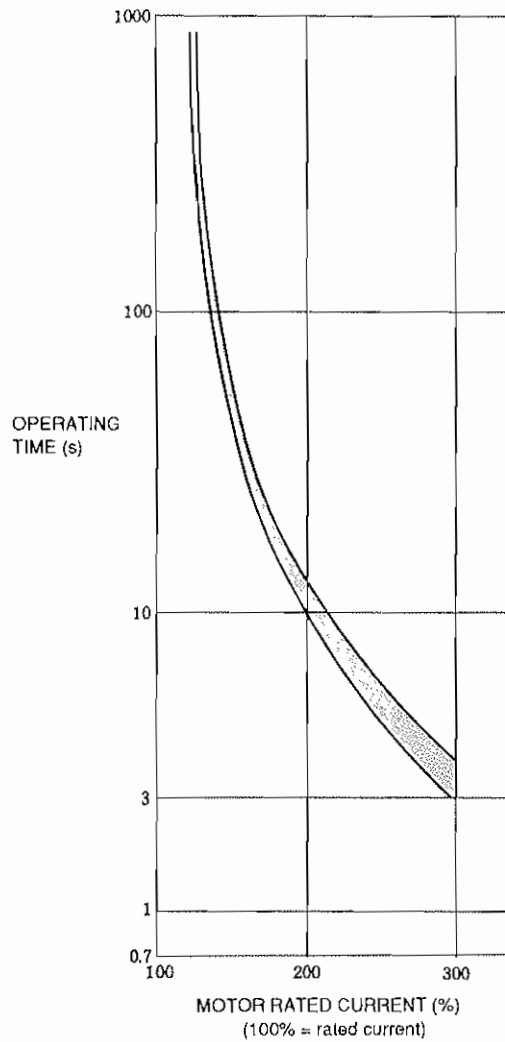


Fig. 4.1 Allowable Overload Characteristics of SERVOPACK

4.2 STARTING AND STOPPING TIME

The starting time and stopping time of SERVOMOTOR under a constant load is shown by the formula below. Viscous or friction torque of the motor is disregarded.

Starting Time :

$$t_r = 104.7 \times \frac{N_R (J_M + J_L)}{K_t \cdot I_R (\alpha - \beta)} \text{ (ms)}$$

Stopping Time :

$$t_f = 104.7 \times \frac{N_R (J_M + J_L)}{K_t \cdot I_R (\alpha + \beta)} \text{ (ms)}$$

Where,

N_R : Rated motor speed (r/min)

$J_M (= GD_M^2/4)$: Moment of rotor inertia ($\text{kg} \cdot \text{m}^2 = \text{lb} \cdot \text{in} \cdot \text{s}^2$)

$J_L (= GD_L^2/4)$: Moment of load inertia ($\text{kg} \cdot \text{m}^2 = \text{lb} \cdot \text{in} \cdot \text{s}^2$)

K_t : Torque constant of motor ($\text{N} \cdot \text{m}/\text{A} = \text{lb} \cdot \text{in}/\text{A}$)

I_R : Motor rated current (A)

$\alpha = I_p / I_R$: Accel/decel current constant

I_p : Accel/decel current

(Accel/decel current α times the motor rated current) (A)

$\beta = I_L / I_R$: Load current constant

I_L : Current equivalent to load torque

(Load current β times the motor rated current) (A)

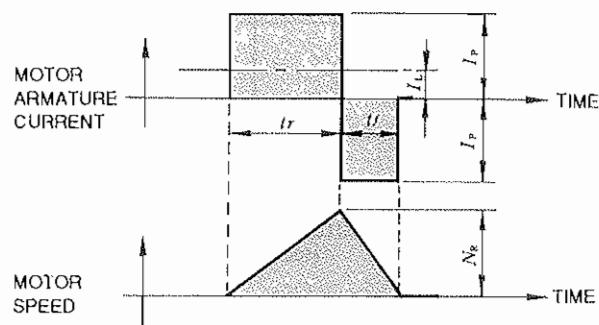


Fig. 4.2 Timing Chart of Motor Armature Current and Speed (Constant Load)

4.3 ALLOWABLE FREQUENCY OF OPERATION

The allowable frequency of operation is restricted by the SERVOMOTOR, and the conditions must be considered for satisfactory operation.

(1) Allowable Frequency of Operation Restricted by the SERVOMOTOR

The allowable frequency of operation varies depending on the load conditions, motor running time and the operating conditions. Typical examples are shown below. See Par. 4.2, "STARTING AND STOPPING TIME" for symbols.

·When the motor repeats rated speed operation and being at standstill (Fig. 4.3).

Cycle time (T) should be determined so that RMS value of motor armature current is lower than the motor rated current :

$$T \geq \frac{I_p^2 (t_r + t_f) + I_L^2 t_s}{I_R^2} \text{ (s)}$$

Where cycle time (T) is determined, values I_p , t_r , t_f satisfying the formula above, should be specified.

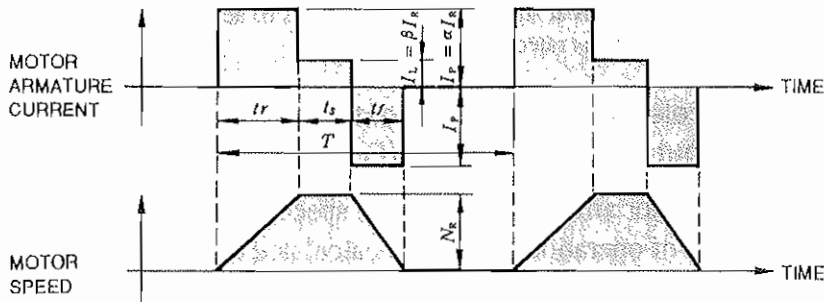


Fig. 4.3 Timing Chart of Motor Armature Current and Speed
(Restricted by SERVOMOTOR)

- When the motor remains at standstill between cycles of acceleration and deceleration without continuous rated speed running (Fig.4.4).

The timing chart of the motor armature current and speed is as shown in Fig. 4.4.

The allowable frequency of operation "n" can be calculated as follows :

$$n = 286.5 \times \frac{Kt + I_R}{N_R(J_M + J_L)} \times \left(\frac{1}{\alpha} - \frac{\beta^2}{\alpha^3} \right) \text{ (times/min)}$$

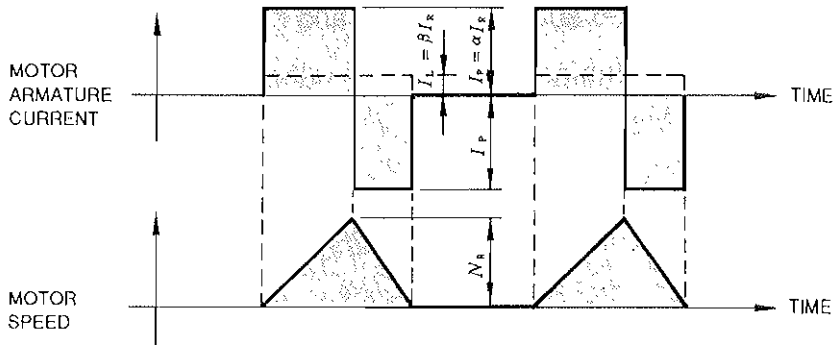


Fig. 4.4 Timing Chart of Motor Armature Current and Speed
(The motor remains at standstill between cycles of accel/decel without continuous rated speed running)

- When the motor accelerates, runs at constant speed, and decelerates in a continuing cycle without being at standstill (Fig. 4.5).

The timing chart of the motor armature current and speed is as shown in Fig. 4.5.

The allowable frequency of operation "n" can be calculated as follows :

$$n = 286.5 \times \frac{Kt + I_R}{N_R(J_M + J_L)} \times \left(\frac{1}{\alpha} - \frac{\beta^2}{\alpha} \right) \text{ (times/min)}$$

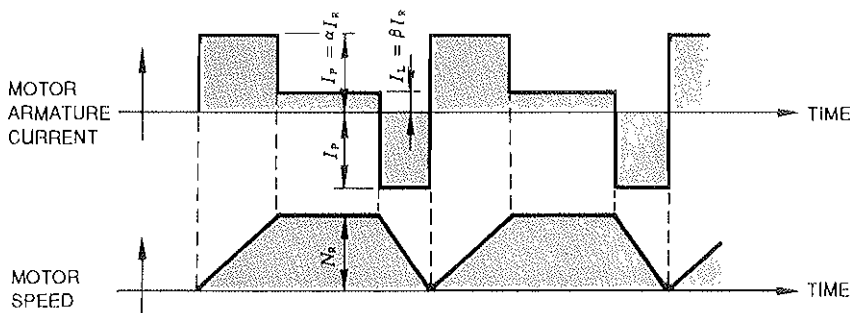


Fig. 4.5 Timing Chart of Motor Armature Current and Speed
(The motor accelerates, runs at constant speed, and decelerates in a continuing cycle without being at standstill)

4.4 SERVOMOTOR FREQUENCY

In the servo drive consisting of SERVOPACK and SERVOMOTOR, motor speed amplitude is restricted by the maximum armature current controlled by SERVOPACK.

The relation between motor speed amplitude (N) and frequency (f) is shown by the formula below :

$$N = 1.52 \times \frac{\alpha \cdot K_t \cdot I_R}{(J_M + J_L) f} \quad (\text{r/min})$$

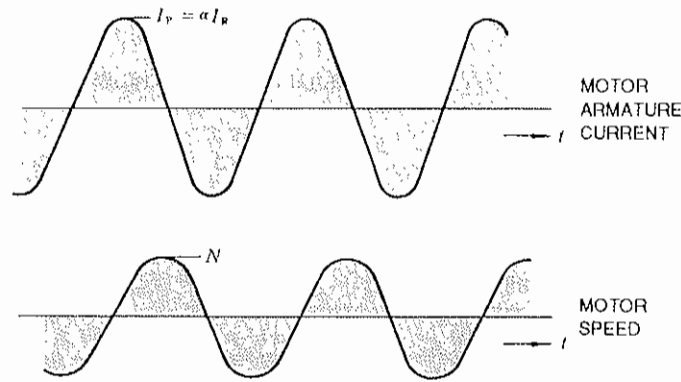


Fig. 4.6 Timing Chart of Motor Armature Current and Speed
(Restricted by the maximum armature current)

4.5 MOTOR MECHANICAL CHARACTERISTICS

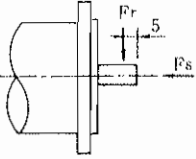
4.5.1 Mechanical Strength

SGM SERVOMOTORS can carry momentary maximum torque up to 300% of the rated torque at output shaft.

4.5.2 Allowable Radial Load and Thrust Load

Table 4.1 shows allowable loads according to SGM SERVOMOTOR types.

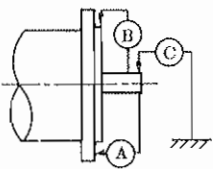
Table 4.1 Allowable Radial Load and Thrust Load

SERVOMOTOR Type	Allowable Radial Load F_r (N (lb))	Allowable Thrust Load F_s (N (lb))	Reference Diagram
SGM-A3	49 (11)	19 (4)	
SGM-A5	68 (15)	19 (4)	
SGM-01	68 (15)	19 (4)	
SGM-02	196 (44)	49 (11)	
SGM-04	196 (44)	68 (15)	
SGM-08	343 (77)	98 (22)	

Note : Load generated from motor torque plus load applied to the shaft extension never exceed the values mentioned above.

4.5.3 Mechanical Specifications

Table 4.2 Mechanical Specifications in mm (inches)

Accuracy (T.I.R.)	Reference Diagram
Flange Surface Perpendicular to Shaft (A) 0.04 (0.0016)	
Flange Diameter Concentric to Shaft (B) 0.04 (0.0016)	
Shaft Run Out (C) 0.02 (0.00079)	

Note : T.I.R. (Total Indicator Reading)

4.5.4 Direction of Rotation

SGM SERVOMOTORS rotate counterclockwise (CCW) when viewed from the drive end when motor and detector leads are connected as shown below.

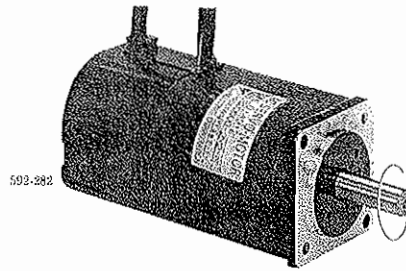
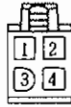


Fig. 4.7 SGM SERVOMOTOR

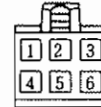
(1) Connector Specifications

• Motor connection
(for standard SERVOMOTOR)



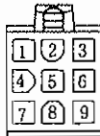
1	Phase-U	Red
2	Phase-V	White
3	Phase-W	Blue
4	FG (Frame ground)	Green

• Motor connection
(for SERVOMOTOR with brake)



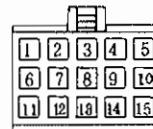
1	Phase-U	Red
2	Phase-V	White
3	Phase-W	Blue
4	FG (Frame ground)	Green
5	Brake terminal	Black
6	Brake terminal	Black

• Detector connection
(incremental encoder)



1	Channel A output	Blue
2	Channel \bar{A} output	Blue/Black
3	Channel B output	Yellow
4	Channel \bar{B} output	Yellow/Black
5	Channel C output	Green
6	Channel \bar{C} output	Green/Black
7	0 V (Power supply)	Gray
8	+5 V (Power supply)	Red
9	FG (Frame ground)	Orange

• Detector connection
(absolute encoder)



1	Channel A output	Blue
2	Channel \bar{A} output	White/Blue
3	Channel B output	Yellow
4	Channel \bar{B} output	White/Yellow
5	Channel Z output	Green
6	Channel \bar{Z} output	White/Green
7	0 V (Power supply)	Black
8	+5 V (Power supply)	Red
9	FG (Frame ground)	Green/Yellow
10	Channel S output	Purple
11	Channel \bar{S} output	White/Purple
* (12)	(Capacitor reset)	(Gray)
13	Reset	White/Gray
14	0 V (Battery)	White/Orange
15	3.6 V (Battery)	Orange

* Don't use this terminal since this is used for capacitor discharge terminal at shipment.

4.5.5 Impact Resistance

When mounted horizontally and exposed to vertical shock impulses, the motor can withstand up to two impacts with impact acceleration of 10 G (Fig. 4.8).

NOTE

A precision detector is mounted on the opposite-drive end of the SGM SERVOMOTOR. Care should be taken to protect the shaft from impacts that could damage the detector.

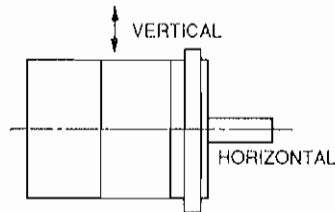


Fig. 4.8 Impact Resistance

4.5.6 Vibration Resistance

When mounted horizontally, the motor can withstand vibration (vertical, lateral, axial) of 2.5 G (Fig. 4.9).

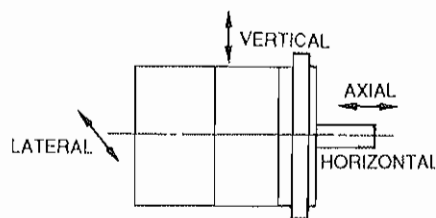


Fig. 4.9 Vibration Resistance

4.5.7 Vibration Class

Vibration of the motor running at rated speed is 15 μ m or below (Fig. 4.10).

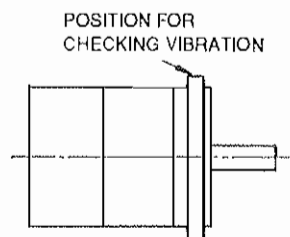


Fig. 4.10 Vibration Checking

5. CONFIGURATION

5.1 CONNECTION DIAGRAM

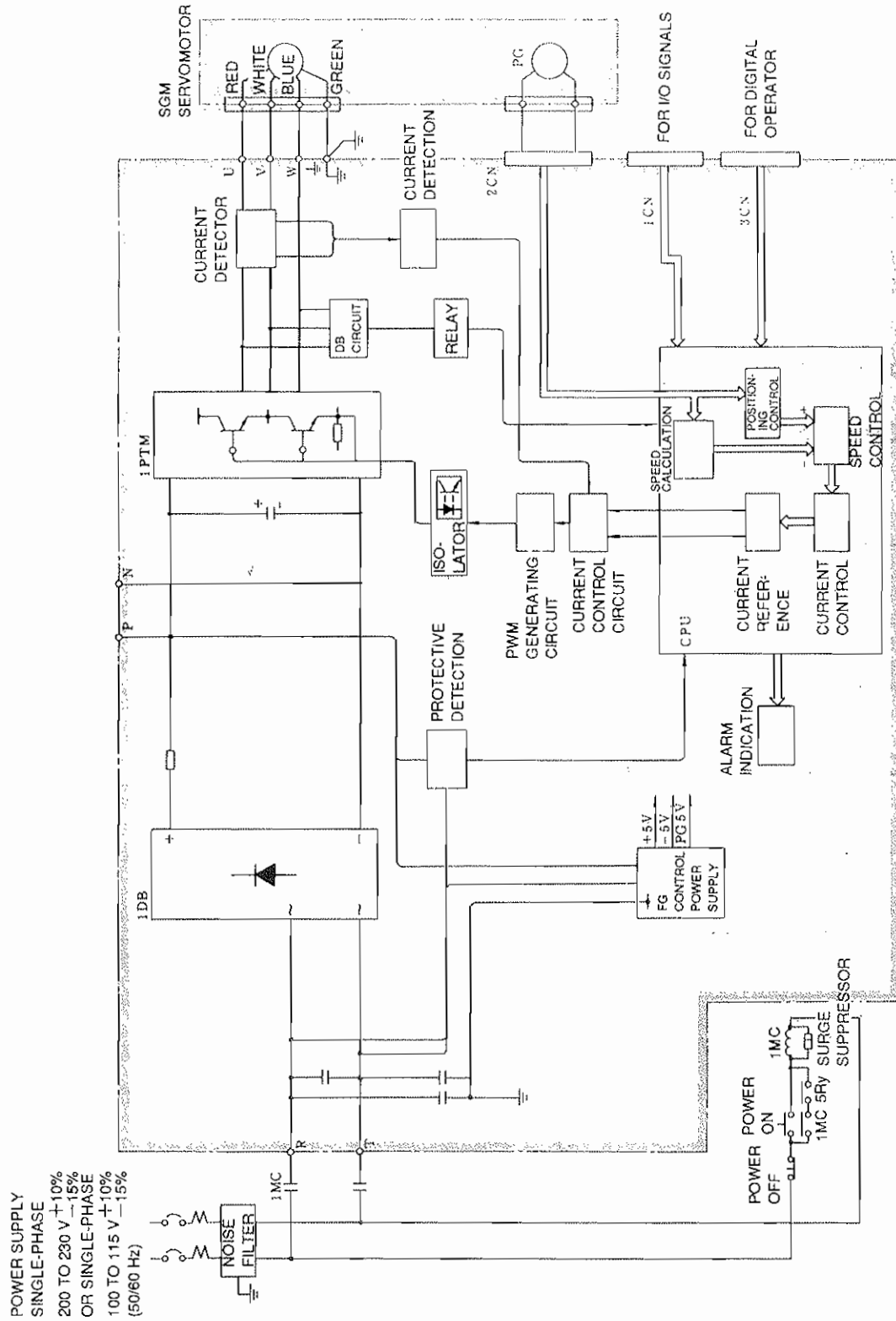


Fig. 5.1 Connection Diagram of SGM SERVOPACK (SGD Series)

5.2 EXTERNAL TERMINALS

Table 5.1 External Terminal for SERVOPACK

Terminal Symbol	Name	Description
Ⓜ Ⓣ	Main circuit AC input	Single-phase 200 to 230 VAC $\begin{matrix} +10 \\ -15 \end{matrix}$ %, 50/60 Hz*
Ⓤ Ⓥ Ⓦ	Motor connection	Connects terminal Ⓤ to motor terminal (Red), Ⓥ to (White) and Ⓦ to (Blue).
Ⓧ	Ground	Connects to motor terminal (Green). Must be securely grounded.
Ⓟ Ⓝ	Regenerative unit connection	Regenerative unit connection terminal (External connection not normally required.)

* For 100 VAC class, single-phase 100 to 115 VAC $\begin{matrix} +10 \\ -15 \end{matrix}$ %, 50/60 Hz is applied.

5.3 APPLICABLE RECEPTACLES

5.3.1 1CN (Connector for I/O Signals)

Table 5.2 Specifications of Applicable Receptacles for SGD SERVOPACK I/O Signals

Connector Type used in SGD SERVOPACK	Applicable Receptacle Type		
	Soldering Type	Case	Manufacturer
10236-52A2JL Right Angle 36P	10136-3000VE	10336-52A0-008	Sumitomo 3M Ltd.

5.3.2 2CN (Connector for Encoder)

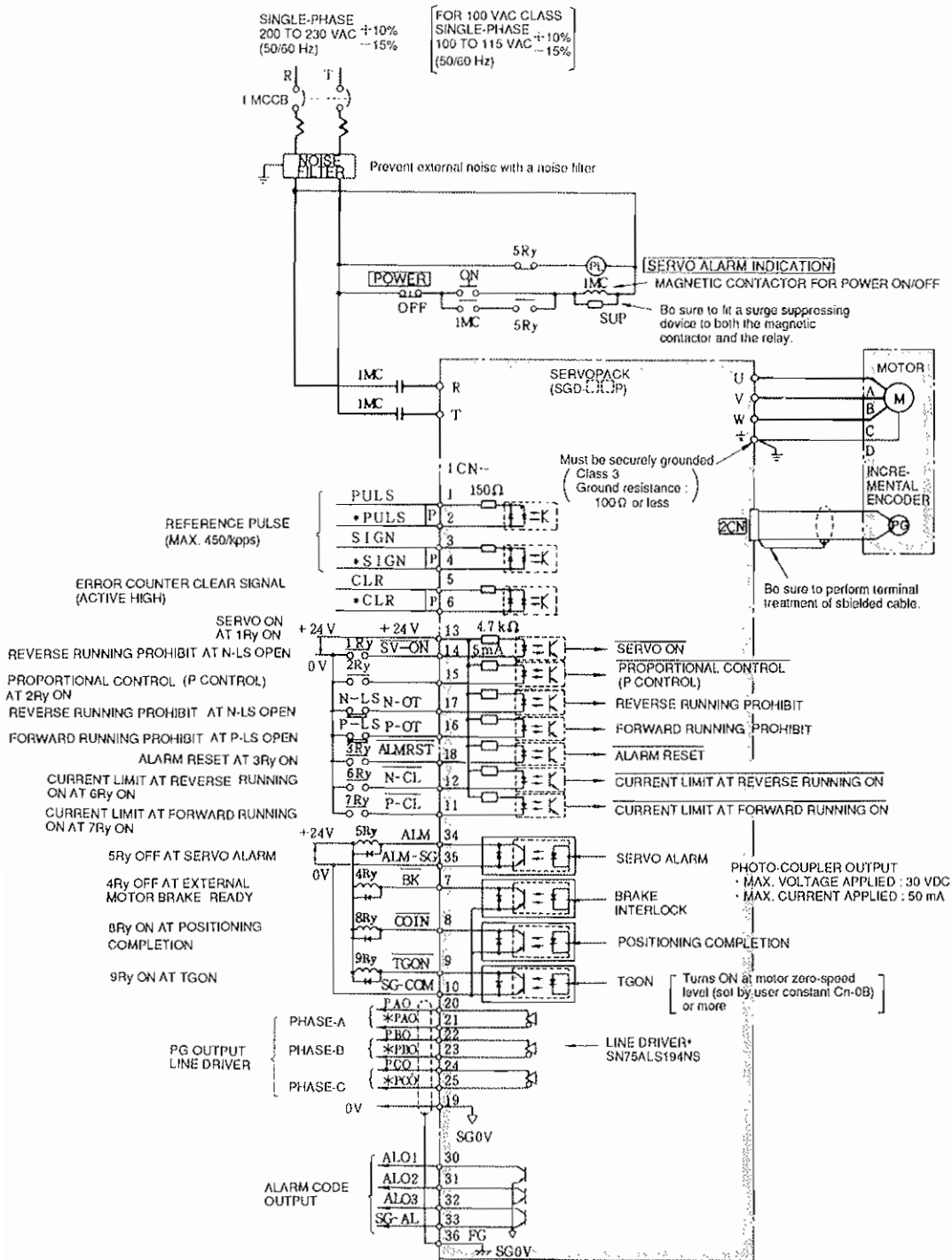
Table 5.3 Specifications of Applicable Receptacles and Cables

Connector Type used in SGD SERVOPACK	Applicable Receptacle Type			Cable Specifications
	Soldering Type	Case	Manufacturer	
10220-52A2JL Right Angle 20P	10120-3000VE	10320-52A0-008	Sumitomo 3M Ltd.	See Par. 10.5, "CABLES."

Note : The cables mentioned above are provided by YASKAWA.
For details, see Par. 10.5, "CABLES."

5.4 CONNECTION (WITH INCREMENTAL ENCODER)

5.4.1 Connection Diagram



* Made by Texas Instruments Inc.

Notes :

1. Capacity of each output circuit is 30 VDC, 50 mA or less.
2. \overline{TP} : Twisted pair wires
3. The user must provide the 24 V power supply.

Fig. 5.2 Example of Connection Diagram of SGD SERVOPACK with a SERVOMOTOR and Peripherals (1)

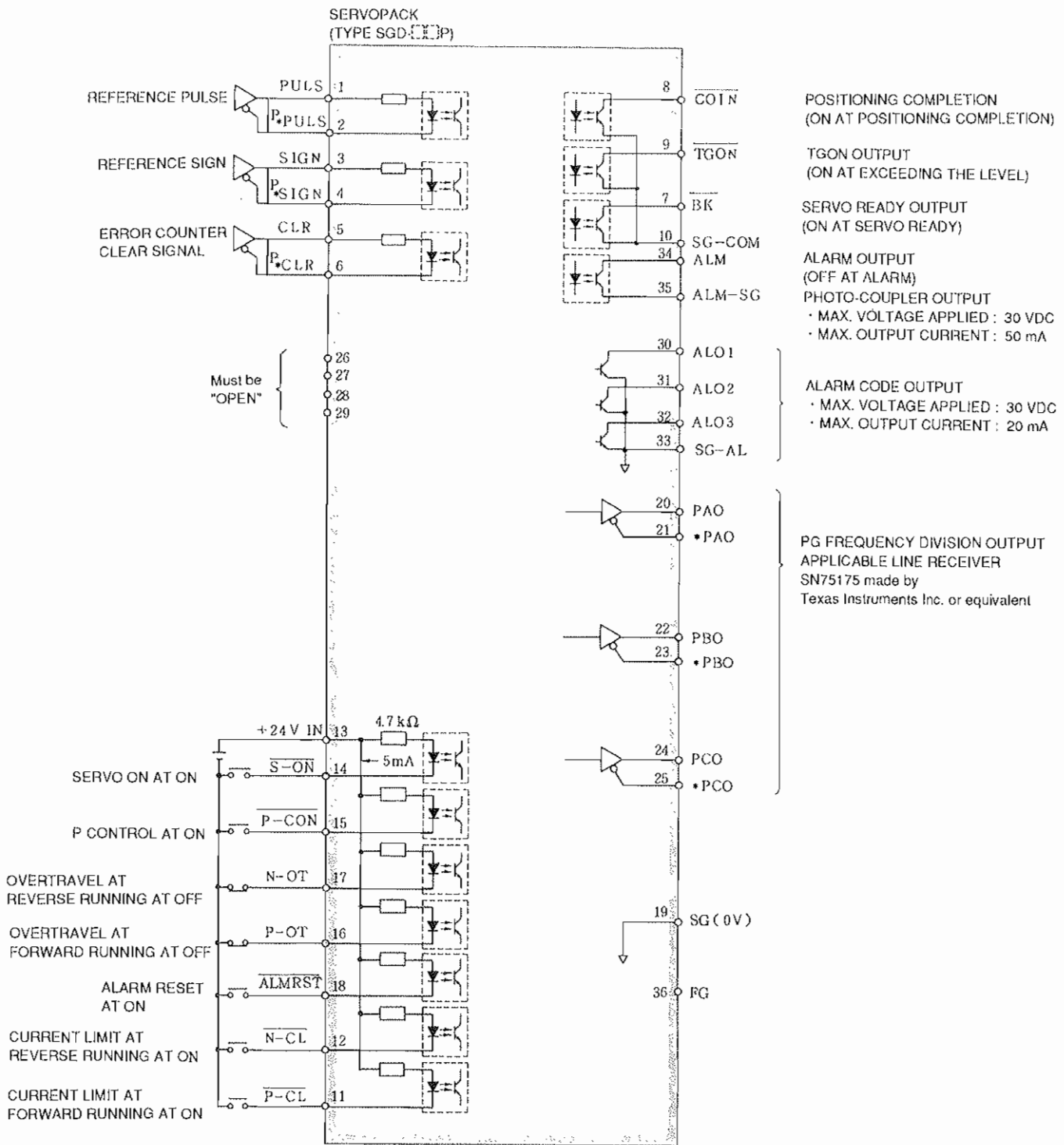
5.4.2 Connector 1CN for I/O Signals

(1) Connector 1CN Layout

Table 5.4 Connector 1CN Layout of SGD SERVOPACK

2	*PULS	Reference Pulse Input 0V	1	PULS	Reference Pulse Input	20	PAO	PG Output (Phase-A)	19	SG	PG Output Signal 0V
4	*SIGN	Reference Sign Input 0V	3	SIGN	Reference Sign Input	22	PBO	PG Output (Phase-B)	21	*PAO	PG Output (Phase-A)
6	CLRO	Error Counter Clear Input 0V	5	CLR	Error Counter Clear Input	24	PCO	PG Output (Phase-C)	23	*PBO	PG Output (Phase-B)
8	$\overline{\text{COIN}}$	Positioning Completion Signal Output	7	$\overline{\text{BK}}$	Brake Interlock Signal Output	26			25	*PCO	PG Output (Phase-C)
10	SG-COM	Common 0V to $\overline{\text{BK}}$, $\overline{\text{COIN}}$ and $\overline{\text{TGON}}$	9	$\overline{\text{TGON}}$	TGON Signal Output	28			27		
12	$\overline{\text{N-CL}}$	Reverse Current Limit ON Input	11	$\overline{\text{P-CL}}$	Forward Current Limit ON Input	30	ALO1	Alarm Code Output (Open collector output)	29		
14	$\overline{\text{S-ON}}$	Servo ON Input	13	+24 V IN	External Power Input	32	ALO3		31	ALO2	Alarm Code Output (Open collector output)
16	P-OT	Forward Prohibit Input	15	$\overline{\text{P-CON}}$	P Drive Input	34	ALM	Servo Alarm Output	33	SG-AL	Alarm Code Output Common 0V
18	ALMRST	Alarm Reset Input	17	N-OT	Reverse Prohibit Input	36	FG	Frame Ground	35	ALM-SG	Servo Alarm Output

(2) I/O Signals and Connector 1CN



* \updownarrow P : Twisted pair wires

Notes :

1. Cable for 1CN is not provided.
2. The user must provide the 24 V power supply.

Fig. 5.3 I/O Signals Connection and Connector 1CN

(3) Input Signals of Connector 1CN

Table 5.5 Input Signals

Signal Name	Connector 1CN No.	Function	Description
$\overline{S-ON}$	14	Servo ON	<ul style="list-style-type: none"> Inputting this signal makes the SERVOPACK ready to receive speed reference inputs. Base block and dynamic brake are released. When Servo ON signal is not used, this signal can be disabled by setting bit 0 of user constant Cn-01 to bit 1.
$\overline{P-CON}$	15 2 functions can be selected by setting bit 2 of user constant Cn-02	Proportional drive reference	Inputting this signal switches the speed loop control mode from proportional integration (PI) control to proportional (P) control.
		External setting speed rotating direction reference	Inputs rotating direction reference at 1st to 3rd speed. Used with 1st to 3rd speed selection signal input ($\overline{N-CL}$, $\overline{P-CL}$).
$\overline{N-OT}$	17	Reverse running prohibit	<ul style="list-style-type: none"> In the case of linear motion, etc., connect limit switch signal according to the run direction. This is a normally closed contact.
$\overline{P-OT}$	16	Forward running prohibit	<ul style="list-style-type: none"> This signal can be disabled by setting bit 2 or 3 of user constant Cn-01. Maintains the "$\overline{N-OT}$ at normal run" and "$\overline{P-OT}$ at normal run" status.
+24V IN	13	24 V	External power supply for 1CN-11, -12, -14, -15, -16, -17 and 18. Use 24 VDC (50 mA min) power supply.
PULS	1 (2)	Reference pulse input	Pulse train frequency ≤ 450 kpps When pulses of phase -A and -B are used by input multiplication : $\text{Pulse train frequency} \times \text{input multiplication} \leq 800 \text{ kpps}$
SIGN	3 (4)	Reference sign input	Sign reference : Forward reference, H level Reverse reference, L level
$\overline{N-CL}$	12	Current limit at reverse running reference (1st to 3rd speed selection reference)	Current limit reference input or external setting speed (1st to 3rd speed) selection reference input is obtained by setting bit 2 of user constant Cn-02. Current limit value or set speed value is set by user constant.
$\overline{P-CL}$	11	Current limit at forward running reference (1st to 3rd speed selection reference)	
ALMRST	18	Alarm reset	Resets the servo alarm status.

(4) Input Circuit

There are seven kinds of input signals : Forward running prohibit, reverse running prohibit, servo ON, proportional drive, overtravel prevention, current limit and alarm reset. Construct the input circuit using 24 V power supply (Fig. 5.4). Typical circuits are shown in Fig. 5.2.

NOTE

The user must provide the 24 V power supply :
 24 ± 1 VDC, 50 mA or more (approx 5 mA/circuit)

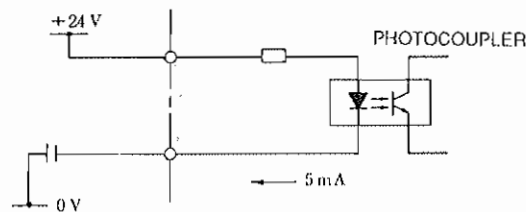


Fig. 5.4 Configuration of I/O Circuit

① P-CON

This input signal functions as any of the following two signals depending on bit 2 of user constant Cn-02.

(a) Proportional drive (P drive)

Switches the speed loop control mode from proportional integration (PI) control to proportional (P) control.

(b) Rotation direction for preset speed reference

Select running direction, if preset-speed reference mode is used.

② P-OT, N-OT (forward overtravel, reverse overtravel)

These inputs are used to stop the forward running of the motor (counterclockwise when viewed from the drive end of the motor) and reverse running. When the overtravel prevention input is not used, connect 1CN- ⑩ and - ⑪ to the 0 V of the external 24 V power supply, or invalidate this function by setting bit 2 or 3 of user constant Cn-01.

Operation to be performed when an overtravel occurs can be selected from the following four by setting bit 6, 8, or 9 of user constant Cn-01.

(a) Coasting to a stop

When overtravel occurs, the motor coasts to a stop.

(b) DB stop

When overtravel occurs, the motor is stopped by the dynamic brake. The brake is released after the motor stops.

(c) Stop at the torque specified by user constant Cn-06

When an overtravel occurs, regardless of speed reference, the internal circuit forcibly changes speed reference to zero and immediately stops the motor. After the motor stops, it is released free.

(d) Zero-clamp after stopping at the torque specified by user constant Cn-06

After the motor stops as (c) above, it is held in zero-clamp mode.

③ Servo ON [$\overline{S-ON}$]

Turning this signal ON activates the power drive circuit of the SERVOPACK main circuit. The motor cannot be started unless this signal is input (that is, in the servo-OFF status).

When this signal is turned OFF while the motor is rotating, the motor is stopped by the dynamic brake. This signal is automatically input by setting bit 0 of user constant Cn-01.

④ $\overline{P-CL}$, $\overline{N-CL}$

These input signals function as any of the following two signals depending on bit 2 of user constant Cn-02.

(a) External current limit at forward/reverse running reference

A circuit to limit motor armature current max. value during forward (counterclockwise when viewed from the drive end of the motor) or reverse running. The limit value can be specified independently for forward or reverse running by setting user constants Cn-18 and -19.

Regarding the continuous rated output current value as 100%, up to the maximum output current can be specified for the parameters.

(b) Internally set speeds (1st to 3rd) selection reference

The 1st to 3rd speeds are selected according to the inputs as shown in the following tables :

Table 5.6

	$\overline{N-CL}$	$\overline{P-CL}$
1st Speed	ON	OFF
2nd Speed	ON	ON
3rd Speed	OFF	ON
Stop	OFF	OFF

Table 5.7

	$\overline{P-CON}$
Forward Running	OFF
Reverse Running	ON

⑤ Alarm reset (\overline{ALMRST})

This is an external reset signal for servo alarm. Remove the cause of the alarm before restarting operation. For safety, set a 0V speed reference when inputting the reset signal.

(5) Output Signals

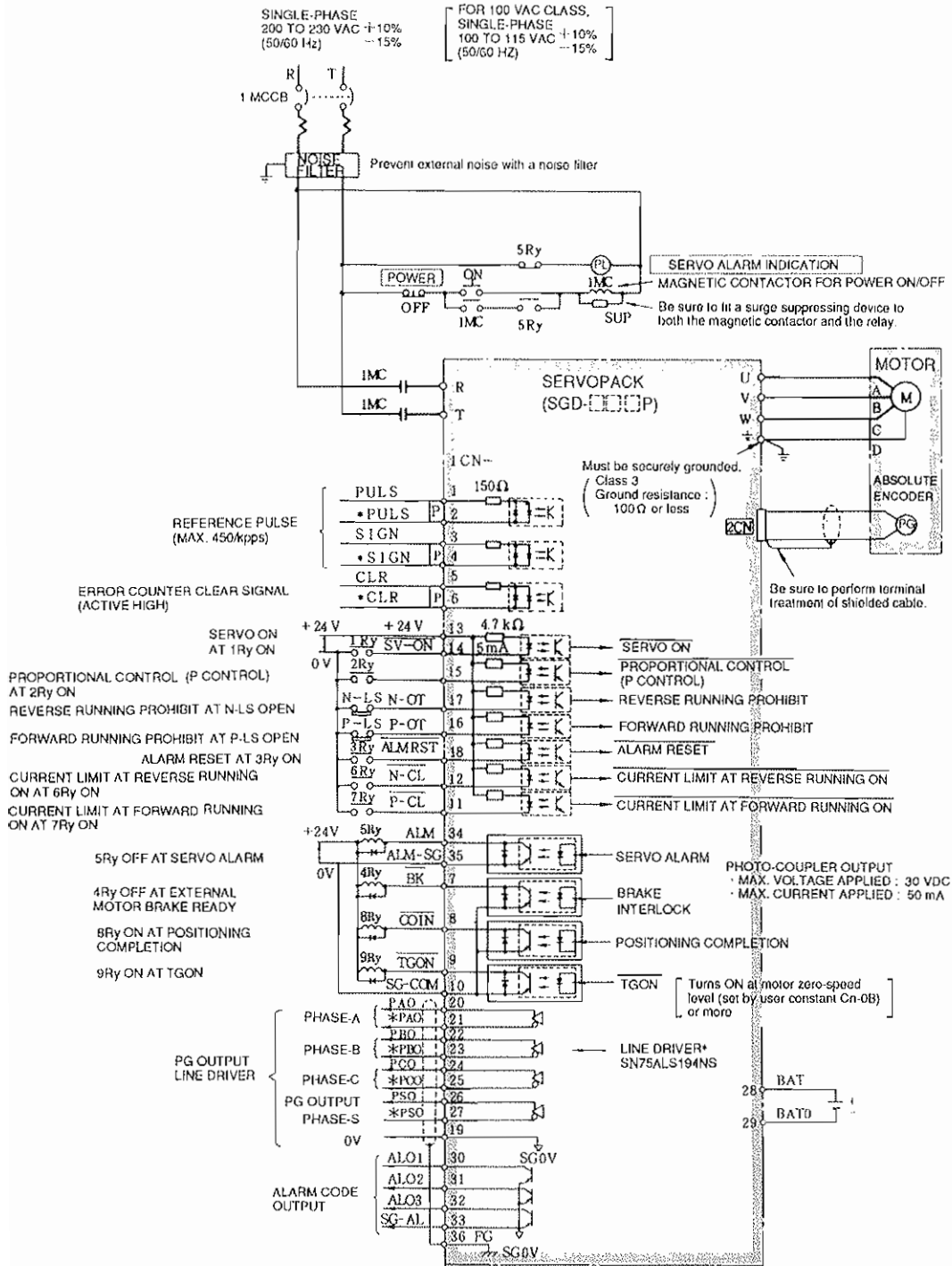
Table 5.8 Output Signals

Signal Name	Connector 1CN No.	Function	Description
ALM	34 (35)	Servo alarm	<ul style="list-style-type: none"> • Goes OFF when fault is detected. • For details, see Table 6.8, "Fault Detection Function."
^{Note} TGON	9 (10)	Rotation detection	Turns ON when the motor rotation speed exceeds the value specified by user constant Cn-0B.
^{Note} (CLT)		Current limit detection	① When $\overline{N-CL}$ or $\overline{P-CL}$ is ON, this signal turns ON when the torque reaches the lower level value either limited by Cn-18 and Cn-19 or set by Cn-08 and Cn-09. ② When both $\overline{N-CL}$ and $\overline{P-CL}$ are OFF, this signal turns ON when the torque set by Cn-08 or Cn-09 is reached.
\overline{BK}	7 (10)	Brake interlock output	Output timing signal for external brake signal.
\overline{COIN}	8 (10)	Positioning completion	Sequence signal (\overline{COIN}) is output when lag pulse of error counter enters the range of positioning completion width set by user constant Cn-1B.
PAO * PAO PBO * PBO PCO * PCO	20 21 22 23 24 25	PG signal output	Phase-A, \overline{A} Phase-B, \overline{B} Phase-C, \overline{C}
	(19)		
AL01 AL02 AL03	30 31 32	Alarm output code (BCD code)	Open collector output Max voltage applied : 30 VDC Max output current : 20 mA

Note : Select \overline{TGON} or \overline{CLT} by setting bit 4 of user constant Cn-01.

5.5 CONNECTION (WITH ABSOLUTE ENCODER)

5.5.1 Connection Diagram



* Made by Texas Instruments Inc.

Notes :

1. Capacity of each output circuit is 30 VDC, 50 mA or less.
2. TP : Twisted pair wires
3. The user must provide the 24 V power supply.

Fig. 5.5 Example of Connection Diagram of SGD SERVOPACK with a SERVOMOTOR and Peripherals (2)

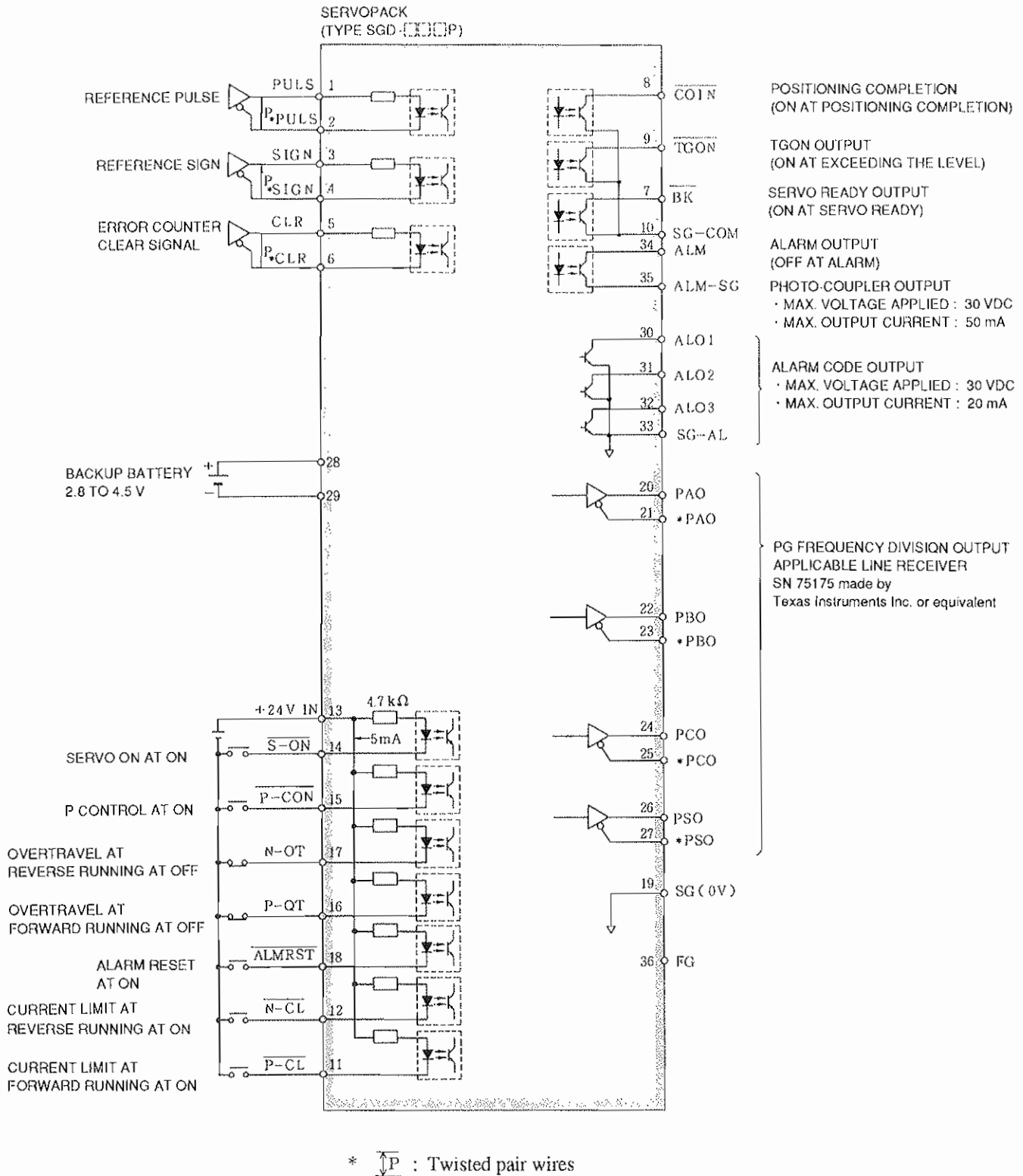
5.5.2 Connector 1CN for I/O Signals

(1) Connector 1CN Layout

Table 5.9 Connector 1CN Layout of SGD SERVOPACK

2	*PULS	Reference Pulse Input	1	PULS	Reference Pulse Input	20	PAO	PG Output (Phase-A)	19	SG	PG Output Signal 0V
4	*SIGN	Reference Sign Input	3	SIGN	Reference Sign Input	22	PBO	PG Output (Phase-B)	21	*PAO	PG Output (Phase-A)
6	*CLR	Error Counter Clear Input	5	CLR	Error Counter Clear Input	24	PCO	PG Output (Phase-C)	23	*PBO	PG Output (Phase-B)
8	$\overline{\text{COIN}}$	Positioning Completion Signal Output	7	$\overline{\text{BK}}$	Brake Interlock Signal Output	26	PSO	PG Output S-phase (For absolute encoder only)	25	*PCO	PG Output (Phase-C)
10	SG-COM	Common 0V to BK, COIN and TGON	9	$\overline{\text{TGON}}$	TGON Signal Output	28	BAT	Battery (+) (For absolute encoder only)	27	*PSO	PG Output S-phase (For absolute encoder only)
12	$\overline{\text{N-CL}}$	Reverse Current Limit ON Input	11	$\overline{\text{P-CL}}$	Forward Current Limit ON Input	30	ALO1	Alarm Code Output	29	BAT0	Battery (-) (For absolute encoder only)
14	$\overline{\text{S-ON}}$	Servo ON Input	13	+24 V IN	External Power Input	32	ALO3	Open Collector Output	31	ALO2	Alarm Code Output (Open collector output)
16	P-OT	Forward Prohibit Input	15	$\overline{\text{P-CON}}$	P Drive Input	34	ALM	Servo Alarm Output	33	SG-AL	Alarm Code Output Common 0V
18	ALMRST	Alarm Reset Input	17	N-OT	Reverse Prohibit Input	36	FG	Frame Ground	35	ALM-SG	Servo Alarm Output

(2) I/O Signals and Connector 1CN



Notes :

1. Cable for ICN is not provided.
2. The user must provide the 24 V power supply.

Fig. 5.6 I/O Signals Connection and Connector 1CN

(3) Input Signals of Connector 1CN

Table 5.10 Input Signals

Signal Name	Connector 1CN No.	Function	Description
S-ON	14	Servo ON	<ul style="list-style-type: none"> Inputting this signal makes the SERVOPACK ready to receive speed reference inputs. Base block and dynamic brake are cleared. When Servo ON signal is not required, this signal can be ineffective by setting bit 0 of user constant Cn-01.
P-CON	15 (2 functions can be selected by setting the bit 2 of user constant Cn-02)	Proportional drive reference	Inputting this signal switches the speed loop control mode from proportional integration (PI) control to proportional (P) control.
		External setting speed rotating direction reference	Inputs rotating direction reference at 1st to 3rd speed. Used with 1st to 3rd speed selection signal input (N-CL, P-CL).
N-OT	17	Reverse running prohibit	<ul style="list-style-type: none"> In the case of linear motion, etc., connect limit switch signal according to the run direction. Since it is a bar signal (reverse signal), it is "Closed" during normal run. When limit switch is tripped, it becomes "Open." This signal can be ineffective by setting bit 2 or 3 of user constant Cn-01. Maintains the "N-OT at normal run" and "P-OT at normal run" status.
P-OT	16	Forward running prohibit	
+24 VIN	13	24 V	External power supply to 1CN-11, -12, -14, -15, -16, -17 and -18. Prepare a 24 VDC (50 mA min) power supply.
PULS (*PULS)	1 (2)	Reference pulse input	Pulse train frequency ≤ 450 kpps When pulses of phase -A and -B are used by input multiplication: Pulse train frequency \times input multiplication ≤ 800 kpps
SIGN (*SIGN)	3 (4)	Reference sign input	Sign reference: Forward reference, H level Reverse reference, L level
CLR (*CLR)	5 (6)	Error counter clear signal	Interrupts F- and B- pulses and clears the error counter at H level.
N-CL	12	Current limit at reverse running reference (1st to 3rd speed selection reference)	Current limit reference input or external setting speed (1st to 3rd speed) selection reference input is obtained by setting bit 2 of user constant Cn-02. Current limit value or set speed value is set by user constant.
P-CL	11	Current limit at forward running reference (1st to 3rd speed selection reference)	
ALMRST	18	Alarm reset	Resets the servo alarm status.
BAT	28	Backup battery positive input	These terminals are for connecting backup battery in case of a power failure of the absolute encoder. Applicable voltage is 2.8 to 4.5 V. (No battery is provided by YASKAWA.)
BAT0	29	Backup battery negative input	

(4) Input Circuit

Input signals are the same as those of the SERVOPACK with incremental encoder.
See Par. 5.4.2 (3), "Input Signals of Connector 1CN."

(5) Output Signals

Table 5.11 Output Signals

Signal Name	Connector 1CN No.	Function	Description
ALM+ (ALM--)	34 (35)	Servo alarm	<ul style="list-style-type: none"> • Goes OFF when fault is detected. • For details, see Table 6.4.2, "Fault Detection Function."
^{Note} TGON	9 (10)	Rotation detection	Turns ON when the motor rotation speed exceeds the value specified by user constant Cn-0B.
^{Note} (CLT)		Current limit detection	① When $\overline{N-CL}$ or $\overline{P-CL}$ is ON, this signal turns ON when the torque reaches the lower level value either limited by Cn-18 and Cn-19 or set by Cn-08 and Cn-09. ② When both $\overline{N-CL}$ and $\overline{P-CL}$ are OFF, this signal turns ON when the torque set in Cn-08 or Cn-09 is reached.
\overline{BK}	7 (10)	Brake interlock output	Output timing signal for external brake signal.
\overline{COIN}	8 (10)	Positioning Completion	Sequence signal (\overline{COIN}) is output when lag pulse of error counter enters the range of positioning completion width set by user constant Cn-1B.
PAO * PAO PBO * PBO PCO * PCO	20 21 22 23 24 25	PG signal output	<ul style="list-style-type: none"> • PG pulse after frequency division is output by line driver (SN75ALS194NS made by TI or equivalent). • To be received by a line receiver (SN75175 made by TI or equivalent). • 1CN-⑨ is 0 V for PG output signal. Connect to 0 V of the host controller.
	(19)		
PSO * PSO	26 27	PG signal output	<ul style="list-style-type: none"> • This is PG phase-S signal output. The cumulative number of motor rotations is continuously output in serial data. • This signal is output by a line driver (SN75ALS194NS made by Texas Instruments or equivalent). • Receive this signal by a line driver (SN75175 made by Texas Instruments or equivalent).
ALO1 ALO2 ALO3	30 31 32	Alarm output code (BCD code)	Open collector output Max voltage applied : 30 VDC Max output current : 20 mA

Note : Select TGON or CLT by setting bit 4 of user constant Cn-01.

5.6 OUTPUT CIRCUIT

There are seven output signals :

TGON, brake interlock, servo alarm, positioning completion and three alarm codes for open collector output.

These output circuits are non-contact, employing transistors. Voltage and current specifications are :

Applied Voltage (V Max) ≤ 30 V

Conduction Current (I_p) ≤ 50 mA

For alarm codes 1 to 3, I_p is 20 mA max.

NOTE

The output circuit requires a separate power supply (20 mA max. for open collector output). It is recommended to use the same 24 V power supply used for the input circuit (Fig. 5.7).

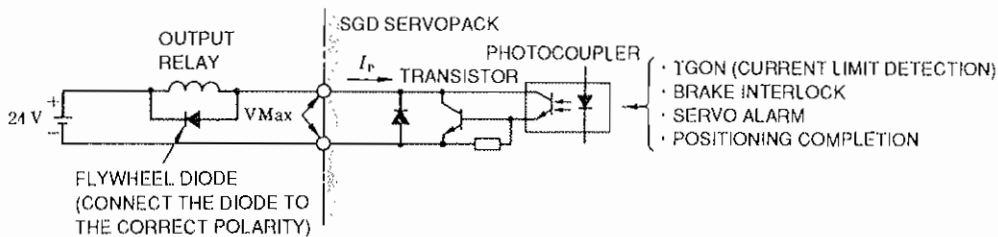


Fig. 5.7 Output Circuit

5.6.1 Encoder (PG) Output Circuit

[PAO, *PAO, PBO, *PBO, PCO, *PCO]

Outputs PG phase-A, -B, and -C (reference) signals. Use as position signals. Specifications of output signals are as follows.

(1) Signal Form

Two-phase pulse with 90-degree phase difference for phase-A, -B and reference pulse for phase-C.

(2) Output Circuit and Receiver Circuit

Output circuit is a line driver output circuit. See Fig. 5.8.

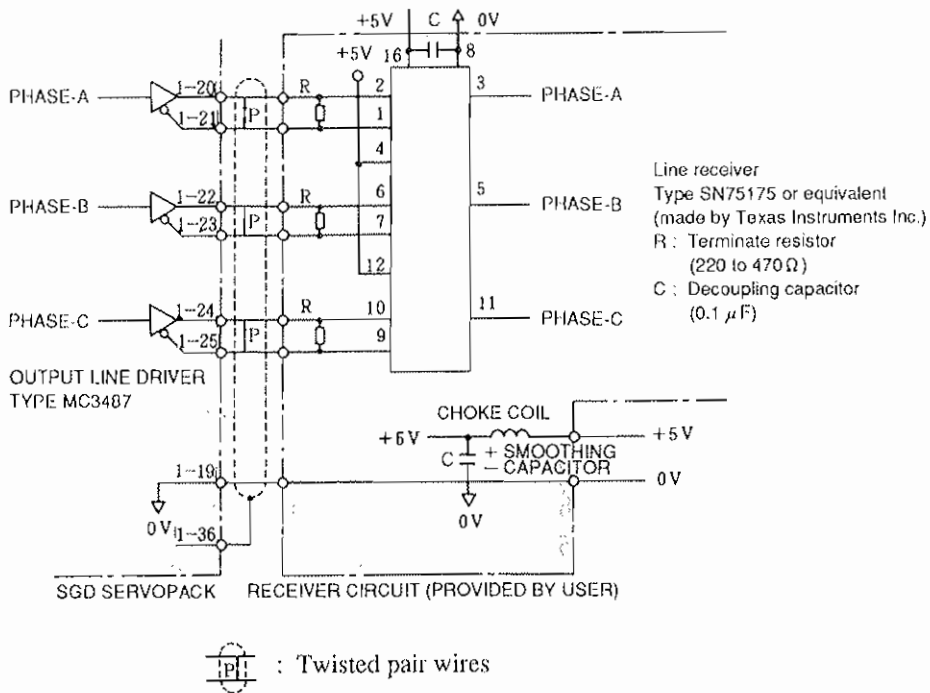
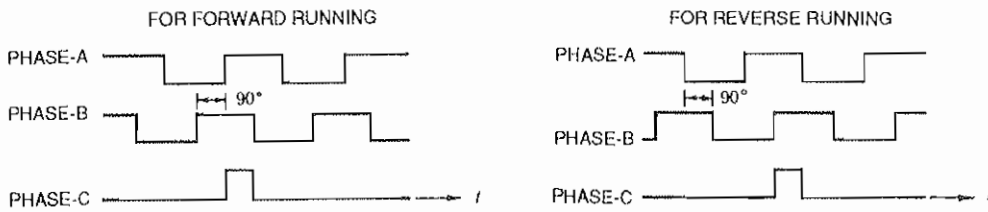


Fig. 5.8 Example of Output Circuit and Receiver Circuit

(3) Output Phase (Frequency dividing ratio : 1/1)

(a) In case the incremental encoder is applied



(b) In case the absolute encoder is applied

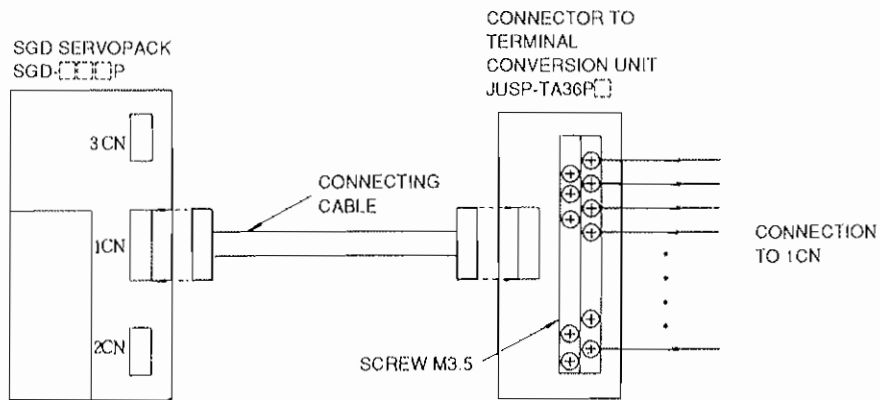


Note : For details of frequency dividing, refer to Par. 7 (8), "PG Division Ratio Setting."

Fig. 5.9 Forward/Reverse Output Phase

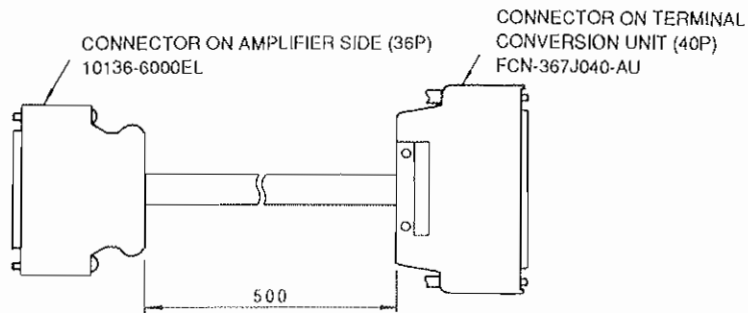
5.7 CONNECTOR TO TERMINAL CONVERSION UNIT FOR 1CN (PERIPHERAL DEVICES FOR SGD SERVOPACK)

(1) Application



Note : Connector to terminal conversion unit for 2CN is not provided.
Cable for absolute/incremental encoder is available. For details, refer to Par. 10.5, "CABLES."

(2) Connecting Cable (Accessories for conversion unit JUSP-TA36 [])



5.8 CONNECTOR 2CN FOR OPTICAL ENCODER

5.8.1 Connector 2CN Layout

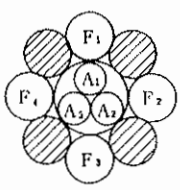
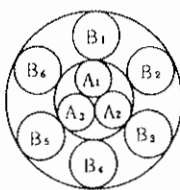
Table 5.12 Connector 2CN Layout of SGD SERVOPACK

2	PG0V	PG Power 0 V	1	PG0V	PG Power 0 V	12	BAT +	Battery (+) (For absolute encoder only)	11		
			3	PG0V	PG Power 0 V				13	BAT -	Battery (-) (For absolute encoder only)
4	PG5V	PG Power 0 V	5	PG5V	PG Power +5V	14	PC	PG Input C-phase	15	*PC	PG Input C-phase
6	PG5V					16	PA	PG Input A-phase	17	*PA	PG Input A-phase
8	PS	PG Input S-phase (For absolute encoder only)	7	DIR	Rotating Direction Input	18	PB	PG Input B-phase	19	*PB	PG Input B-phase
			9	*PS	PG Input S-phase (For absolute encoder only)				20	FG	Frame Ground
10											

5.8.2 Cable Specifications

If required, order in units of standard lengths as shown in Table 5.13.

Table 5.13 Cable Specifications

YASKAWA Drawing No.	Incremental Encoder B9400064	Absolute Encoder DP8409123				
General Specifications	Double KQVV-SW AWG22 × 3C AWG26 × 4P	Double KQVV-SW AWG22 × 3C AWG26 × 6P				
Finishing Dimensions	φ7.5 mm (φ0.30 in.)	φ8.0 mm (φ0.31 in.)				
Internal Composition and Lead Color						
	A ₁	Red	A ₁	Red		
	A ₂	Black	A ₂	Black		
	A ₃	Green yellow	A ₃	Green yellow		
	F ₁	Bule/White blue	Twisted pair wires	B ₁	Blue/White blue	Twisted pair wires
	F ₂	Yellow/White yellow	Twisted pair wires	B ₂	Yellow/White yellow	Twisted pair wires
	F ₃	Green/White green	Twisted pair wires	B ₃	Green/White green	Twisted pair wires
	F ₄	Orange/White orange	Twisted pair wires	B ₄	Orange/White orange	Twisted pair wires
			B ₅	Purple/White purple	Twisted pair wires	
			B ₆	Gray/White gray	Twisted pair wires	
YASKAWA Standard Specifications	Standard lengths : 3 m, 5 m, 10 m, 15 m, 20 m*					

* For cables with connectors, see Par. 10.5, "CABLES."

Note : Allowable wiring distance between SGD SERVOPACK and SGM SERVOMOTOR (PG) is 20 m max. Cables must be assembled by authorized vendor with appropriate tooling.

5.8.3 Connection

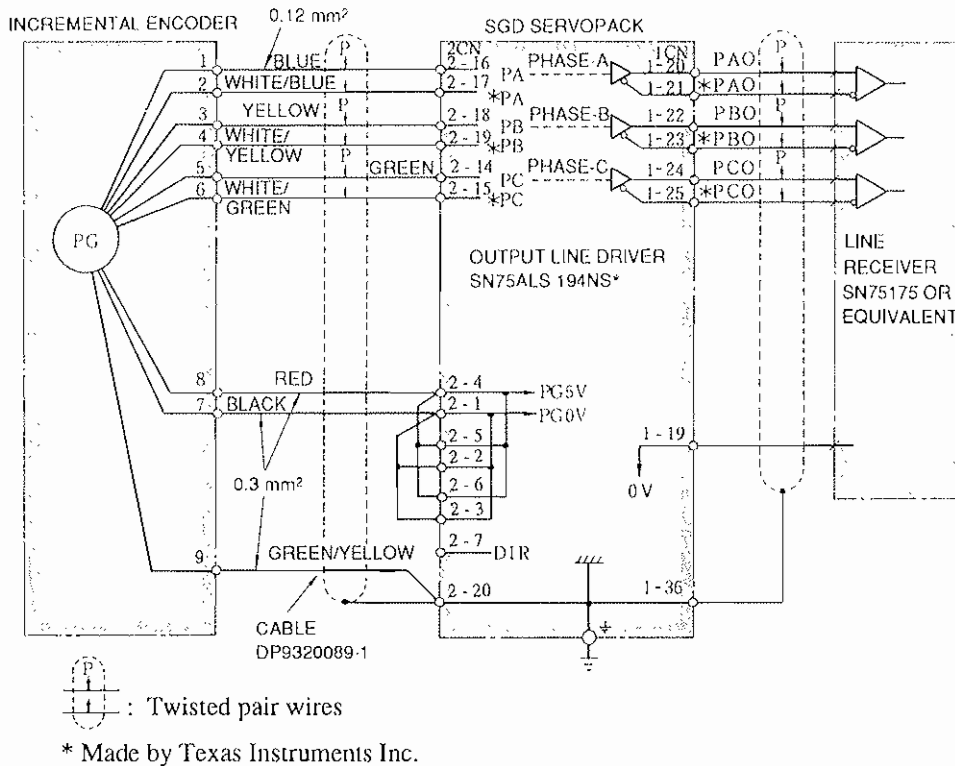


Fig. 5.10 Connector 2CN for Incremental Encoder Connection and 1CN Output Processing (When using Connection Cable DP9320089-1)

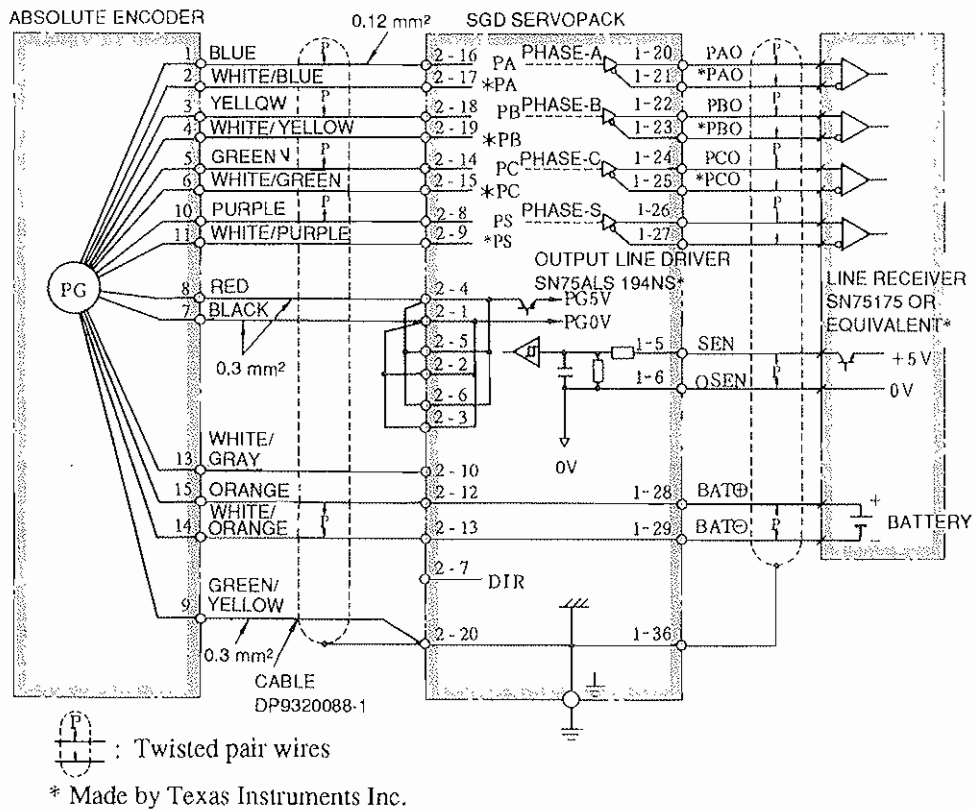
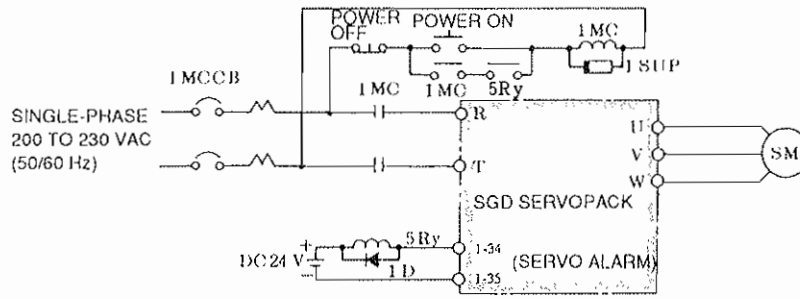


Fig. 5.11 Connector 2CN for Absolute Encoder Connection and 1CN Output Processing (When using Connection Cable DP9320088-1)

6. OPERATION

6.1 POWER ON AND OFF

The following diagram (Fig. 6.1) shows the sequence example for power ON/OFF.



1SUF : Surge suppressor

1D : Flywheel diode (to prevent 5Ry spike)

Fig. 6.1 Connection Example for Power ON/OFF (200 VAC)

Precautions for Connections in Fig. 6.1 are as follows.

- Make sequence to assure that the main circuit power will be cut OFF by a servo alarm signal.
For operation at alarm signal output, refer to Par. 6.5.4, "Protective Circuit Operation".
- When power is supplied to the power ON/OFF sequence shown in Fig. 6.1, the normal signal is set (5Ry is turned ON) in the control circuit after a maximum delay of 2 seconds.

NOTE

When the power is turned ON, a servo alarm signal continues for approximately 2 seconds to initialize the SGD SERVOPACK.

- Since SGD SERVOPACK is of a capacitor input type, large in-rush current flows when the main circuit power is turned ON (recharging time : 0.2 s.). If the power is turned ON and OFF frequently, the in-rush current limit resistor may be degraded and a malfunction may occur. When the motor starts, turn ON the speed reference and turn it OFF when the motor stops. Do not turn the power ON or OFF.
- A momentary power failure may occur when power is supplied again immediately after power turns OFF. Make sure to turn ON the power after the time shown below has elapsed.

Type	SGD-	A3AP A5AP	01AP 02AP 04AP	08AP	200 V AC input
		A3BP	A5BP 01BP 02BP	--	100 V AC input
Power Holding Time		6 s	10 s	15 s	Max. Value

Caution :

High voltage remains for a while in SERVOPACK after power goes OFF.

6.2 POSITION CONTROL

Position control is performed by inputting two reference pulse trains between 1CN-① and -②, and 1CN-③ and -④.

It is effective in the status where the input reference pulse CLR (abbreviation of CLEAR) input signal is at the "L" level.

6.2.1 Input Reference Pulse Logic Level

For input reference pulse, positive (+) logic (active H) or negative (-) logic (active L) can be selected.

This can be set by logic level selection (user constant Cn-02 bit D).

Positive logic is preset at the factory prior to shipping.

6.2.2 Reference Pulse Form

Signals in three forms can be input as reference pulses.

Set user constant Cn-02 (bit 3, 4, 5) as shown in Table 6.1 according to the reference pulse form and input multiplier (only for 2-phase signals).

Table 6.1 Reference Pulse Form

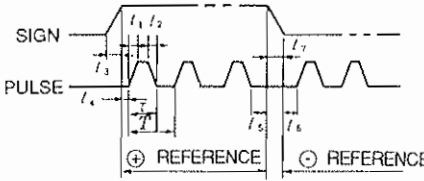
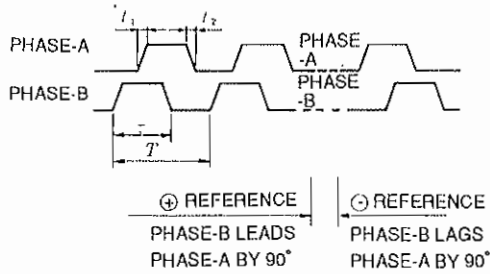
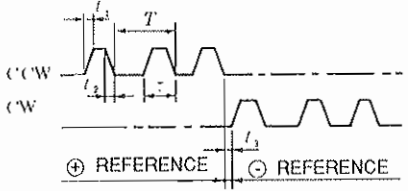
	Reference Pulse Form	Input Terminal No.	Fwd Reference	Rev Reference	Input Multipli- cation*	Cn-02		
						3	4	5
Positive Logic Setting	SIGN + PULSE	1CN-① 1CN-③			---	0	0	0
	90° phase difference* 2-phase pulse (×1, ×2, ×4 can be available)	1CN-① 1CN-③			× 1	0	1	0
					× 2	1	1	0
					× 4	0	0	1
CW pulse + CCW pulse	1CN-① 1CN-③			---	1	0	0	
Negative Logic Setting	SIGN + PULSE	1CN-① 1CN-③			---	0	0	0
	90° phase difference* 2-phase pulse (×1, ×2, ×4 can be available)	1CN-① 1CN-③			× 1	0	1	0
					× 2	1	1	0
					× 4	0	0	1
CW pulse + CCW pulse	1CN-① 1CN-③			---	1	0	0	

* When "90° phase difference, 2-phase pulse" input is applied, input multiplication can be set.

6.2.3 Reference Pulse Timing

Table 6.2 shows the timing pulse waveform when positive logic is selected. The conditions are the same as when negative logic is selected.

Table 6.2 Allowable Voltage Level and Timing

Item	Electrical Specifications	Remarks
<p>Sign + Pulse Train Input (SIGN + PULSE Signals)</p> <p>Max Reference Frequency : 450 kpps</p>	 <p>$t_1, t_2 \leq 0.1 \mu s$ $\tau \geq 1.1 \mu s$ $t_3, t_4 \leq 0.1 \mu s$ $t_1, t_2, t_5 > 3 \mu s$</p>	<p>Sign (SIGN) H : ⊕ reference L : ⊖ reference</p>
<p>90° Phase Difference 2-phase Pulse (Phase-A + Phase-B)</p> <p>Max Reference Frequency : ×1 : 450 kpps ×2 : 400 kpps ×4 : 200 kpps</p>	 <p>$t_1, t_2 \leq 0.1 \mu s$ $\tau \geq 1.1 \mu s$ $\frac{\tau}{T} \times 100 \leq 50\%$</p>	<p>Changing multiplier mode is set by user constant Cn-02 (bit 3, 4, 5).</p>
<p>CCW Pulse + CW Pulse</p> <p>Max Reference Frequency : 450 kpps</p>	 <p>$t_1, t_2 \leq 0.1 \mu s$ $\tau \geq 1.1 \mu s$ $t_3 > 3 \mu s$ $\frac{\tau}{T} \times 100 \leq 50\%$</p>	

6.2.4 Reference Pulse (including CLR Input) Interface

Three types (line driver output, +12 V and +5 V open collectors) can be applied. The following shows each input circuit.

(a) Line driver output

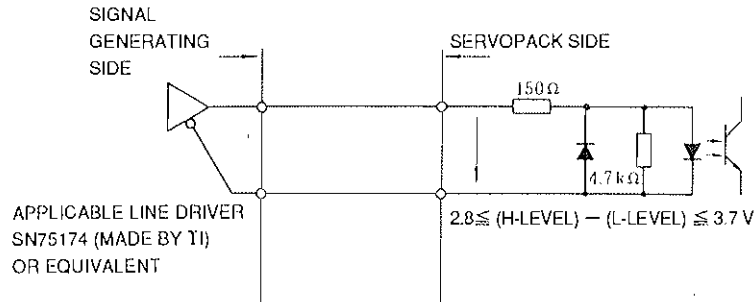


Fig. 6.2

(b) Open collector

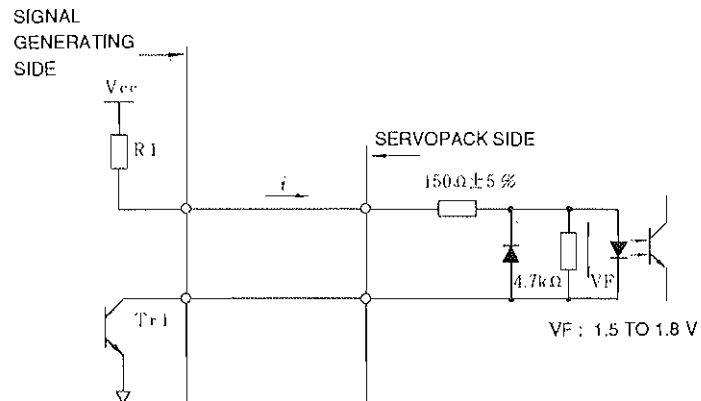


Fig. 6.3

Set the pull-up resistance R1 value switch so that input current i will be within the range from 6.6 mA to 15.3 mA.

Typical application

- When VCC is 12 V \pm 5% :

$$R1 = 1000 \Omega$$

- When VCC is 5 V \pm 5% :

$$R1 = 180 \Omega$$

When the reference pulse is an open collector (in Table 6.2), it is equivalent to :

"H" level input when Tr1 is ON,

"L" level input when Tr1 is OFF.

6.2.5 Clear Input Signal

When the CLR signal is set to "H", the position error counter value becomes 0 and position loop becomes disabled.

Use the signal by setting to "L" for normal operation. (For definition of "H" and "L" when reference pulse is an open collector, refer to Par. 6.2.4.)

6.2.6 Positioning Completion Signal (COIN)

This signal is output when the position counter lag pulse (unit : reference unit *) is within the setting range of user constant (Cn-1B).

NOTE

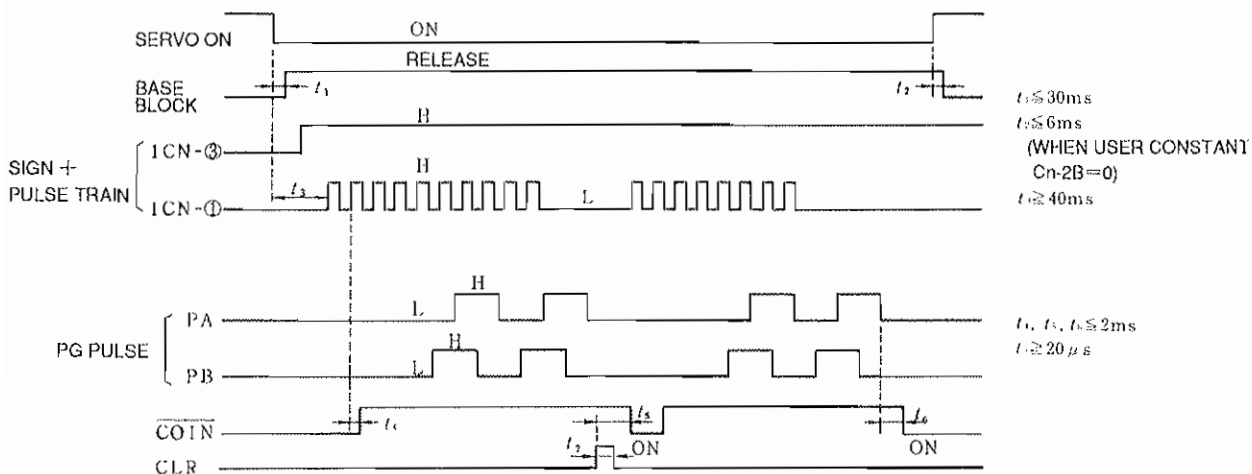
If the positioning completion width (user constant Cn-1B) is set to a large value at low-speed operation, the positioning completion signal (COIN) may remain ON.

* : Reference unit is the minimum unit of the position data required to move the load. For details, refer to Par. 6.2.8 "Function of Electronic Gears".

6.2.7 I/O Signal Timing

Fig. 6.4 shows the I/O signal timing.

[PG dividing ratio = 1, output multiplier = 4 (fixed), positioning completion width = ± 1 reference unit, electronic gear ratio (numerator) = 1, electronic gear ratio (denominator) = 1]



Notes :

1. More than 40 ms are needed from when the servo ON signal is turned ON to when the reference pulse is input. If the reference pulse is input within 40 ms after the servo ON signal is turned ON, the reference pulse may not be counted.
2. The clear signal must be stayed ON more than 20 μ s. Otherwise, it may be ignored.

Fig. 6.4 Typical I/O Signal Timing

6.2.8 Function of Electronic Gears

A function to set moving amount per reference pulse to an arbitrary value. That is, it is set according to the number of encoder pulses, reference unit (the minimum unit of position data to move the load) and gear ratio.

Input of one pulse moves the load by one reference unit.

How to calculate electronic gear ratio (B/A)

Electronic gear ratio B/A indicates the number of encoder pulses per reference unit.

Reference unit is the minimum unit of position data required to move the load.

Example : Reference unit 0.01 mm, 0.1°, 0.01 inch, etc.

Input of one pulse moves the load by one reference unit.

For example, assuming that 50000 reference pulses are received when the reference unit is 0.1 μm, actual moving amount can be calculated by the following equation :

$$50000 \times 0.1 = 5000 \mu\text{m} = 5 \text{ mm}$$

Determine the reference unit, considering the machine specifications or positioning accuracy.

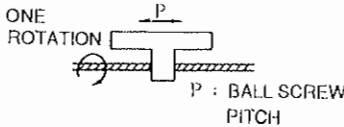
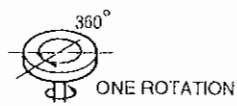
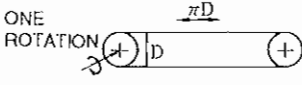
Then load moving amount at one rotation of load axis is obtained in the reference unit.

Moving amount at one rotation of load axis [reference unit]

$$= \frac{\text{Moving amount at one rotation of load axis}}{\text{Reference unit}}$$

Table 6.3 shows typical load moving amount at one rotation of load axis.

Table 6.3 Typical Load Moving Amount at One Rotation of Load Axis

Load Moving Amount at One Rotation of Load Axis	Typical Load Configuration	
P	Ball Screw	
360°	Disc Table	
π D	Belt	

(Example) Load moving amount at one rotation of load axis = 12 mm

Reference unit = 0.01 mm

Load moving amount at one rotation of load axis = $12/0.01 = 1200$ [reference unit]

Finally, calculate the electronic gear ratio (B/A).

$B = [(Cn-11) \times 4] \times [\text{Motor axis rotating speed}]$

$A = [\text{Load moving amount at one rotation of load axis (reference unit)}]$
 $\times [\text{Load axis rotating speed}]$

Reduce the calculated values of A and B so that both values will be smaller than 65535, and set them to Cn-25 and Cn-24.

· Motor axis rotating speed, load axis rotating speed

Machine system gear ratio is obtained.

In the case where the machine system is composed so that the load axis will rotate at ℓ times when the motor axis rotates at m times :

Motor axis rotating speed m [rotation]

Load axis rotating speed ℓ [rotation]

Fig. 6.5 shows the block diagram.

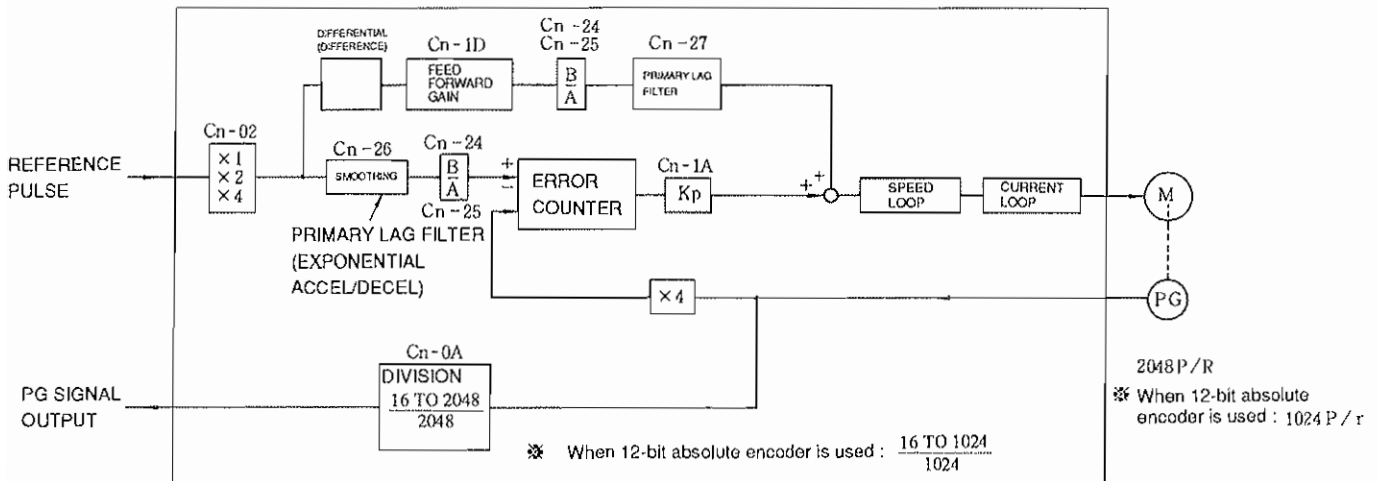


Fig. 6.5 Block Diagram of Electronic Gear Function

6.2.9 Smoothing

When the accel/decel function cannot be input to the reference pulse train, an overshooting or overflow alarm (A. 31) may occur if reference pulse frequency changes rapidly.

In this case, set accel/decel time constant to user constant Cn-26.

When reference pulse frequency is low (low speed), or when the electronic gear ratio is large (more than 10 times), the motor moves in a stepping fashion.

In the above cases, set accel/decel time constant to user constant Cn-26.

6.2.10 Feed Forward

A function to differentiate reference pulse and add it to speed reference to reduce the positioning time.

Feed forward value is set to Cn-1D (0 to 100%).

When Cn-1D set value is large or the load is small, overshooting may occur.

Use this function in a range where overshooting will not occur. A primary lag filter can be inserted for the feed forward command. Set the primary lag filter time constant to user constant Cn-27.

6.3 USE OF 12-BIT ABSOLUTE ENCODER

The 12-bit absolute encoder outputs PAO, PBO, PCO and PSO are shown below :

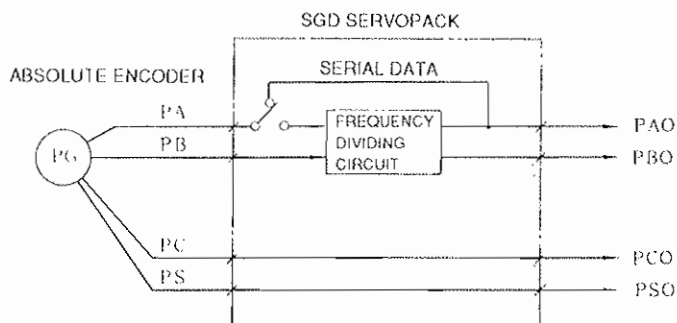


Fig. 6.6 Absolute Encoder Output

Absolute data is read as serial data from phase-S (PSO). When SERVOPACK power is turned ON, absolute data are first output from PAO as serial data, then as initial incremental pulses PAO and PBO (2-phase pulse with 90-degree phase difference).

After this, output operation same as normal incremental encoder (2-phase pulse with 90-degree phase difference) is performed.

Number of rotations (serial data) is output from PSO.

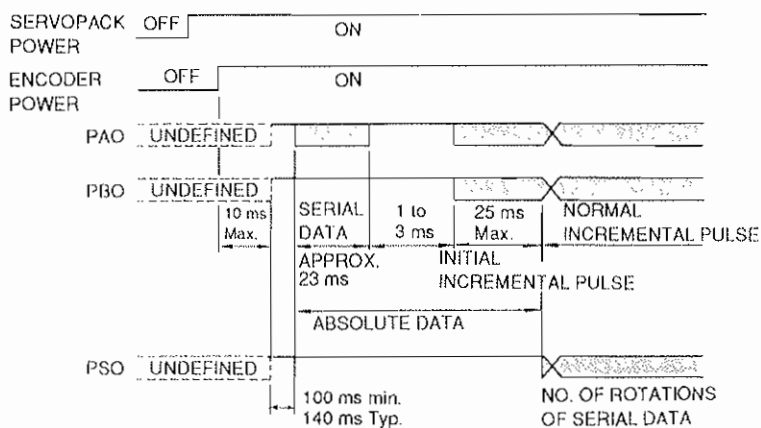


Fig. 6.7 Absolute Data Output

Use PAO, PBO or PCO if necessary.

When PAO or PBO is used, absolute value data are output to PAO or PBO at power supply ON as shown in Fig. 6.7. On the other hand, in the processing circuit provided by user (see Par. 6.3.1, "Output Signal Processing Circuit"), absolute value data cannot be read-in through PAO or PBO since timing for the encoder power supply turning-ON cannot be taken.

6.3.1 Output Signal Processing Circuit

The 12-bit absolute encoder output processing circuit as shown below :

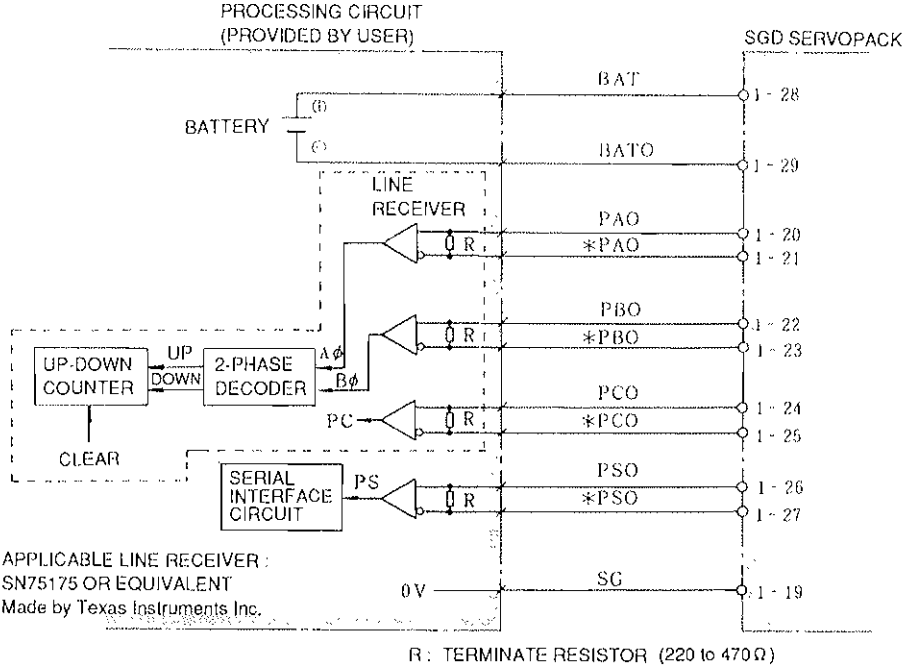


Fig. 6.8 Example of Output Processing Circuit

6.3.2 Serial Data Specification for Phase-S (PSO) No. of Rotations

Table 6.4 Serial Data Specification for Phase-S

Transmission Mode	Asynchronous (ASYNC)
Baud Rate	9600 baud
Start Bit	1 bit
Stop Bit	1 bit
Parity	Even
Character Code	ASCII 7 bits
Data Format	13 characters ; (P/Δ), (+/-), (0 to 9) × 5 digits, (0 to 9) × 4 digits (CR)

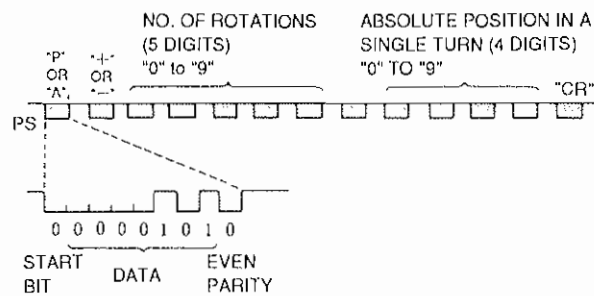


Fig. 6.9 Serial Data for Phase-S

During normal operation, serial data of the number of cumulative rotations (5 digits) and the absolute position in a single turn (4 digits) are output in the format shown in Table 6.4.

The send period is about 40 ms. The absolute position data increase when the motor turns counterclockwise when viewed from the drive end.

Absolute position value is increased at rotation in the counterclockwise (CCW) direction when viewed from the motor axis.

The proper value is not output when the rotation exceeds ± 99999 . When exceeding ± 99999 , the rotation data value is returned to 00000.

Assuming that rotation data value is M (rotation) and absolute position value in one rotation is P_0 , absolute position PE can be obtained by the following equation :

$$PE = 4096 \times M + P_0 \text{ (pulse)}$$

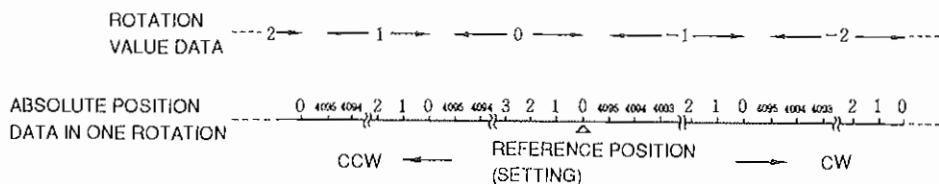


Fig. 6.10 Relation between Rotation Value Data and Absolute Position Data in One Rotation

6.3.3 Incremental Pulse

Initial incremental pulse giving absolute data and normal incremental pulse are output through the frequency divider. The frequency divider is set by Cn-0A.

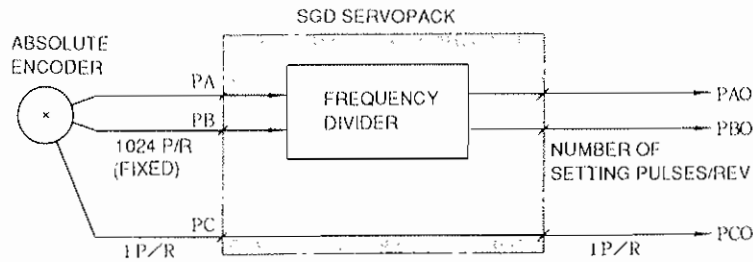
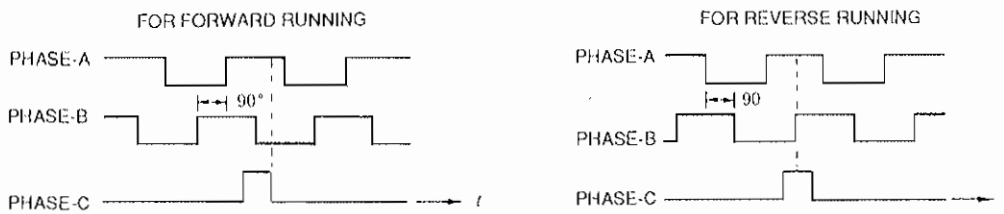


Fig. 6.11 Incremental Pulse

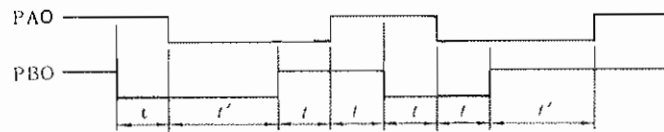
Output Phase



Note : For details of frequency dividing, refer to Par. 7 (6), "PG Division Ratio Setting".

Fig. 6.12 Forward/Reverse Output Phase

PCO (reference pulse) synchronizes with PAO, but the pulse width becomes narrow because PCO is not divided. If the dividing ratio is not $1/2n$, accurate 90-degree phase difference is not made and the pulses are output as shown in Fig. 6.13 :



(The phase difference between t and t' is equal within one revolution, thus the minimum position error results.)

Fig. 6.13 Frequency Dividing Ratio and Output Phase Difference

6.3.4 Power ON to Absolute Encoder

- (1) When the SERVOPACK power supply is turned ON, +5 V power supply is applied to the absolute encoder, and normal operation starts after serial data and initial incremental pulses are sent.
- (2) Until the SERVOPACK power supply is turned ON and the encoder starts normal operation, or until serial data and initial incremental pulses are completely sent, the motor power is not activated even if servo ON is input.

NOTE

The SEN signal is not provided for the position control type. By turning ON the SERVOPACK power supply, the encoder power supply is automatically turned ON inside the SERVOPACK.

6.3.5 Battery

Be sure to use battery to store position information if absolute encoder power should fail. The following battery is recommended :

- Lithium battery* : type ER6VC, 3.6 V 200 mAH×1

For battery replacement method, see Par. 13.3.

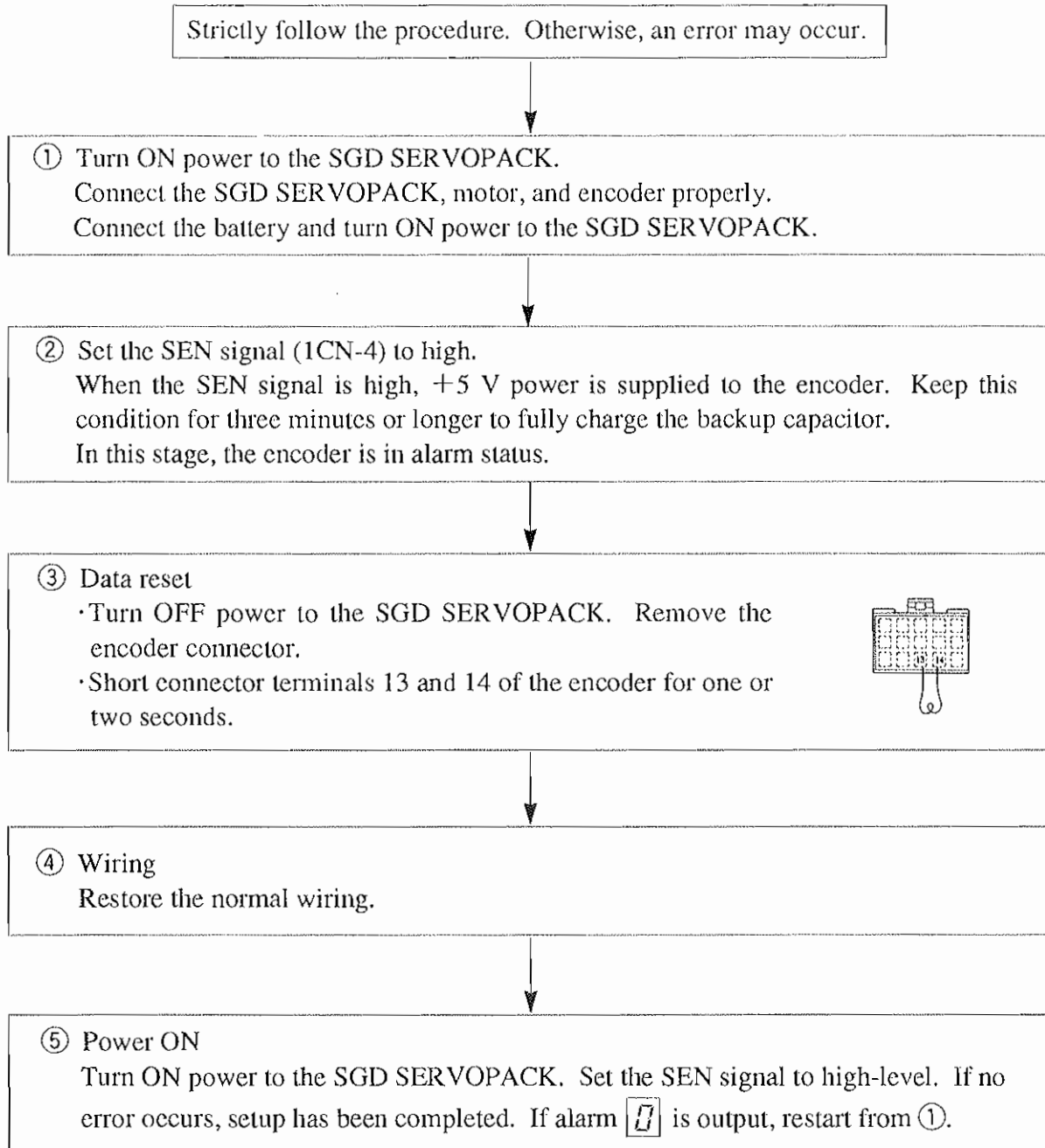
* Made by TOSHIBA CORP.

NOTE

- Securely connect the battery so as to prevent an environmental change or a change with the passage of time from causing contact failure.
- Battery voltage is not monitored in the SERVOPACK. Prevent the voltage from falling below 2.8 V. If necessary in the system, provide a battery voltage loss detection circuit or monitor.

6.3.6 Setup Method for 12-bit Absolute Encoder

To clear the cumulative rotation number to zero to set up the motor, or when the absolute encoder has been left disconnected from a battery for more than two days, the encoder needs to be setup by the following procedure. (Under the above conditions, capacitors in the encoder may be charged insufficiently so that the internal circuits may malfunction.)



6.3.7 Alarm Output of the 12-bit Absolute Encoder

Table 6.5 lists error detection functions of the 12-bit absolute encoder.

If an error occurs in the encoder while the SGD SERVOPACK is operating, the SGD SERVOPACK displays

		A.	8	0
--	--	----	---	---

 on the digital operator.

- Turn OFF SGD SERVOPACK power.
- Turn ON SERVOPACK power. The encoder outputs phase-A serial data ALARMO *

CR

 and phase-S serial data ALARMO*, *

CR

 to the SGD SERVOPACK. The SGD SERVOPACK in turn outputs phase-A and -S serial data from the PAO and PSO output terminals. When the digital operator is connected, the SGD SERVOPACK determines the type of error from the above data and changes the display of digital operator to

		A.	8	*
--	--	----	---	---

.
- If the SGD SERVOPACK miscounts PG pulses and the number of pulses per rotation is an odd sum, the SGD SERVOPACK displays

		A.	8	0
--	--	----	---	---

 on the digital operator but phase-A and -S serial data are not output since the encoder is functioning normally. (For details of the serial data, see Table 6.7.)

Table 6.5 Alarm Output

Name	Contents
Backup Alarm	Backup voltage drop is detected. (This check ensures data reliability of the number of cumulative rotations.)
Battery Alarm	Battery voltage drop is detected. (This checks for battery replacement timing or break in wire.)
Checksum Error	Memory data check resulted in an error.
Overspeed	Rotation speed is 400 r/min. or higher when 5 V power is turned ON.
Absolute Error	Sensor check resulted in an error (indicating an internal error in the encoder).

Table 6.7 Output in Accordance with Encoder Alarm

Alarm	Display	Phase-A Output (PAO)		Phase-S Output (PSO)
	Digital Operator Display	(Phase-A Serial Data)	(SGD-SERVOPACK Alarm Code)	(Phase-S Serial Data)
Backup Alarm	<input type="text"/> <input type="text"/> A. 8 1	ALARMOA <input type="text"/> CR	ALM 81. <input type="text"/> CR	ALARMOA, BACK <input type="text"/> CR
Battery Alarm	<input type="text"/> <input type="text"/> A. 8 3	ALARMOD <input type="text"/> CR	ALM 83. <input type="text"/> CR	ALARMOD, BATT <input type="text"/> CR
Checksum Error	<input type="text"/> <input type="text"/> A. 8 2	ALARMOB <input type="text"/> CR	ALM 82. <input type="text"/> CR	ALARMOB, CHEC <input type="text"/> CR
Overspeed	<input type="text"/> <input type="text"/> A. 8 5	ALARMOP <input type="text"/> CR	ALM 85. <input type="text"/> CR	ALARMOP, OVER <input type="text"/> CR
Absolute Error	<input type="text"/> <input type="text"/> A. 8 4	ALARMOH <input type="text"/> CR	ALM 84. <input type="text"/> CR	ALARMOH, ABSO <input type="text"/> CR
Backup Alarm + Battery Alarm	<input type="text"/> <input type="text"/> A. 8 1	ALARMOE <input type="text"/> CR	ALM 81. <input type="text"/> CR	ALARMOE, BACK <input type="text"/> CR (or BATT)

Notes :

1. Digital operator display and SGD SERVOPACK alarm codes are also output for alarms that occurred within the SGD SERVOPACK other than the above encoder alarms. For details of the SGD SERVOPACK alarm codes, refer to Par. 6.4, "PROTECTIVE FUNCTIONS."
2. The digital operator is SGD SERVOPACK peripheral equipment. For details, refer to Par. 8, "DIGITAL OPERATOR."

6.4 PROTECTIVE FUNCTIONS

SGD SERVOPACK provides functions to protect the drive and motor from malfunctions.

6.4.1 Dynamic Brake Function

SGD SERVOPACK incorporates a dynamic brake for emergency stop. This brake operates when :

- Alarm (fault detection) occurs.
- Servo ON input is opened.
- Power supply is turned OFF.
- Overtravel (P/N-OT) occurs.

Coasting to a stop can also be selected by user constant setting.

6.4.2 Alarm Detection Functions

Table 6.8 lists alarm detection functions of the SGD SERVOPACK. Type of alarm is identified by a combination of three alarm code outputs.

Table 6.8 Alarm Detection Function

○: Output transistor ON
×: Output transistor OFF

Digital Operator JUSP-OP02A-1 Type JUSP-OP03A Type	Output Form				Alarm Detection Function	Detection Contents
	Alarm Output Code			SVALM Output		
	AL01	AL02	AL03			
A0 *	×	×	×	×	Parameter error	An absolute error or parameter error is detected.
A10	○	×	×	×	Overcurrent	<ul style="list-style-type: none"> An overcurrent for the main circuit is detected. An overheat for the SERVOPACK heat sink is detected.
A31	○	○	×	×	Overflow	Detected when lag pulse of error counter exceeds the range of positioning completion width set by user constant.
A40	×	×	○	×	Overvoltage	The main circuit DC voltage exceeds about 420 V.
A5 *	○	×	○	×	Overspeed	<ul style="list-style-type: none"> The motor speed exceeds the maximum allowable rotation speed. Speed reference voltage exceeding the max. rotation speed is input.
A7 *	○	○	○	×	Overload	An overload to the motor and the SGD SERVOPACK is detected.
A *	○	×	○	×	Overrun	<ul style="list-style-type: none"> Overrun resulting from connection error of the motor or PG signals. Disconnection is detected in PG signal cables.
A8 *	×	×	×	×	Encoder alarm	Absolute encoder alarm
A F3	×	○	×	×	Momentary power loss	Momentary power failure (less than holding time) is detected.
CPF00	(not specified)				Digital operator transmission error 1	Transmission error between digital operator and SGD SERVOPACK
CPF01	(not specified)				Digital operator transmission error 2	Transmission error between digital operator and SGD SERVOPACK
A99	×	×	×	○	This is not an alarm	

* A numeral appears in this position identifying the type of the alarm. (For details, see Tables 8A.6 and 8B.6.)

6.4.3 Servo Alarm Output (ALM, ALM-SG)

If any of the alarm detection functions listed in Par. 6.4.2 is activated, the power drive circuit in the SGD SERVOPACK is turned OFF and an alarm display is output.

- When no digital operator is provided : The red LED on the SGD SERVOPACK lights.
- When a digital operator is provided : Alarm contents are displayed on the digital operator. (See Table 6.8.) An alarm code is also output to external equipment through open collector output circuits ALO1 to ALO3. For the alarm codes, see Table 6.8.

6.4.4 Protective Circuit Operation

An alarm signal indicates some trouble. Check the cause and fix the problem, and restart the operation.

Procedure for troubleshooting and corrective action :

Using the error traceback mode function of the digital operator (JUSP-OP02A-1 or -OP03A), check history of errors and take action according to Table 14.2.

6.4.5 Resetting Servo Alarm

To reset a servo alarm, input the alarm reset signal or turn OFF power.

6.5 DISPLAY

(1) When no Digital Operator is Provided

Displays on the front panel of the SGD SERVOPACK

- Power ON : Green LED "ON"
- Alarm occurred : Red LED "ON"

(2) When a Digital Operator is Provided

Status of the SGD SERVOPACK is displayed. (For details, refer to Par. 8, "DIGITAL OPERATOR (JUSP-OP02A-1, -OP03A)."

6.6 PRECAUTIONS FOR APPLICATION

6.6.1 Overhanging Loads

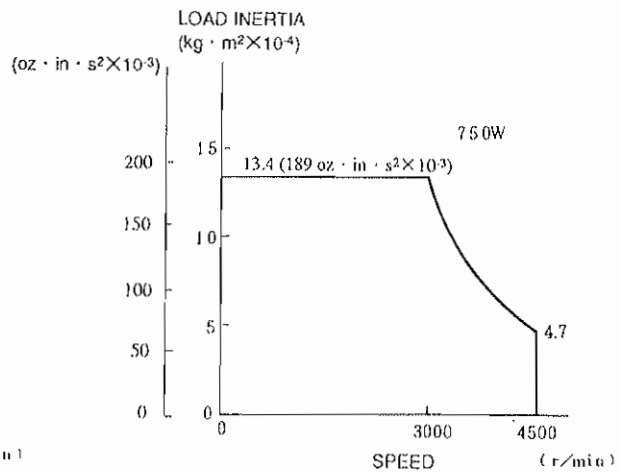
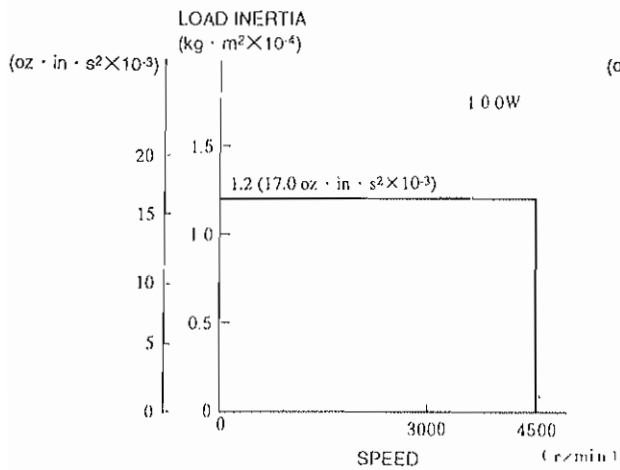
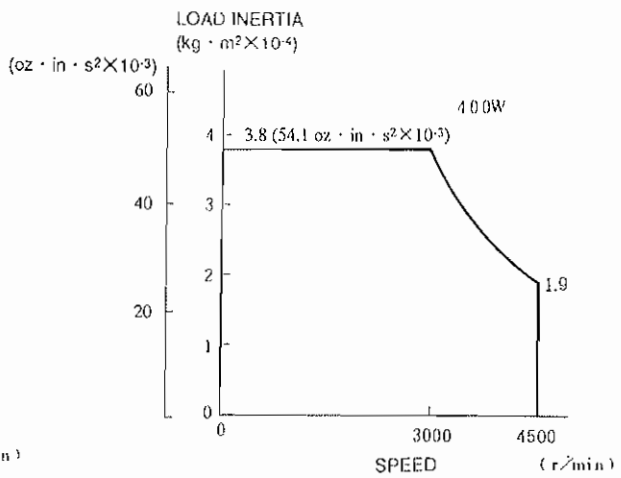
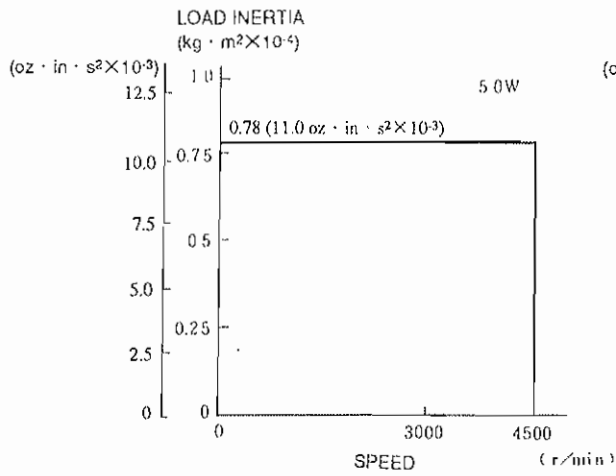
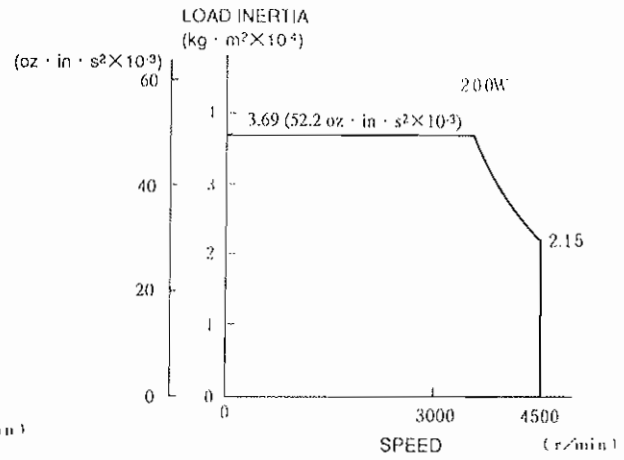
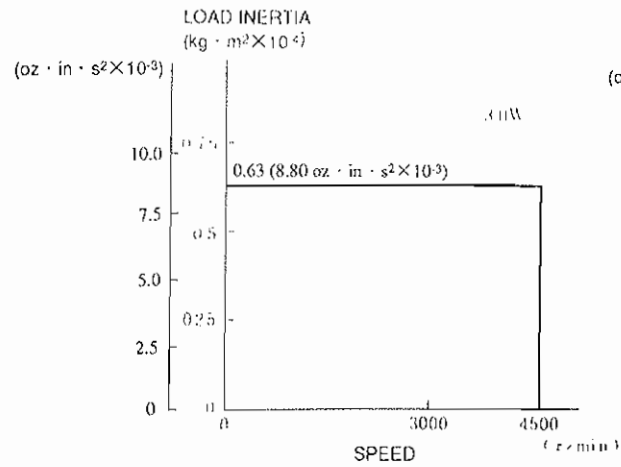
The motor is rotated by the load ; it is impossible to apply brake (regenerative brake) against this rotation and achieve continuous running.

Example : Driving a motor to lower objects (without counterweight)

Since SGD SERVOPACK has short time regenerative brake capability (corresponding to the motor stopping time), for application to a overhanging loads, contact your YASKAWA representative.

6.6.2 Load Inertia J_L

For the allowable load inertia J_L converted to the motor shaft, refer to the following figs. (200 VAC, with incremental encoder)



If the allowable inertia is exceeded, an overvoltage alarm may be occurred during deceleration. If this occurs, take one or more of the following actions :

- Reduce the current limit.
- Slow down the deceleration curve.
- Decrease the maximum speed.
- Provide a regenerative unit.

For details, contact your YASKAWA representative.

6.6.3 Regenerative Unit (Peripheral Device for SGD SERVOPACK)

(1) Rating and Specifications

Table 6.9 Specifications of Regenerative Unit

Type	JUSP-RG08	Remarks
Applicable SGD SERVOPACK	SGD-XXXX	
Regenerative Operation Voltage	380 VDC	
Regenerative Current	8 ADC	Regenerative resistance value : 50Ω, 60 W
Alarm Detection Function	Regenerative resistance disconnection, regenerative TR malfunction, overvoltage.	
Alarm Output	1b contact (contact "open" at protective function operation)	200 V operation is available
Size in mm (in inches)	55 W × 160 H × 130 D (2.17 W × 6.30 H × 5.12 D)	

(2) Connecting Method

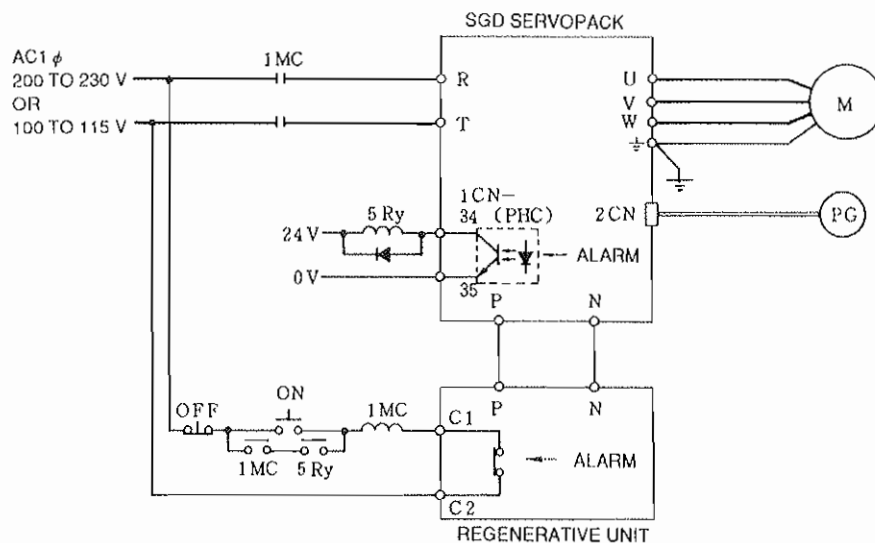


Fig. 6.14 Connecting of Regenerative Unit

(3) Notes on Applications

- The regenerative unit has three alarm detection functions (regenerative-resistance-disconnection detection, regenerative-TR-malfunction detection and overvoltage detection).
- If any of these trouble detection function is activated, the internal alarm relay is tripped, and connection between output terminals (C1) and (C2) on the regenerative unit becomes open.
- Make a sequence so that power supply (R-T) to the SGD SERVOPACK is turned OFF whenever the alarm relay is activated.
- It takes two or three seconds after the alarm relay is activated until it recovers to normal status. (The relay recovers when the main capacitor in the SGD SERVOPACK has been fully discharged.)

6.6.4 High Voltage Line

If the supply voltage is 400/440 V, the voltage must be dropped to 200 V or 100 V using a power transformer. Table 6.11 shows the transformer selection. Connection should be made so that the power is supplied and cut through the primary side of the transformer.

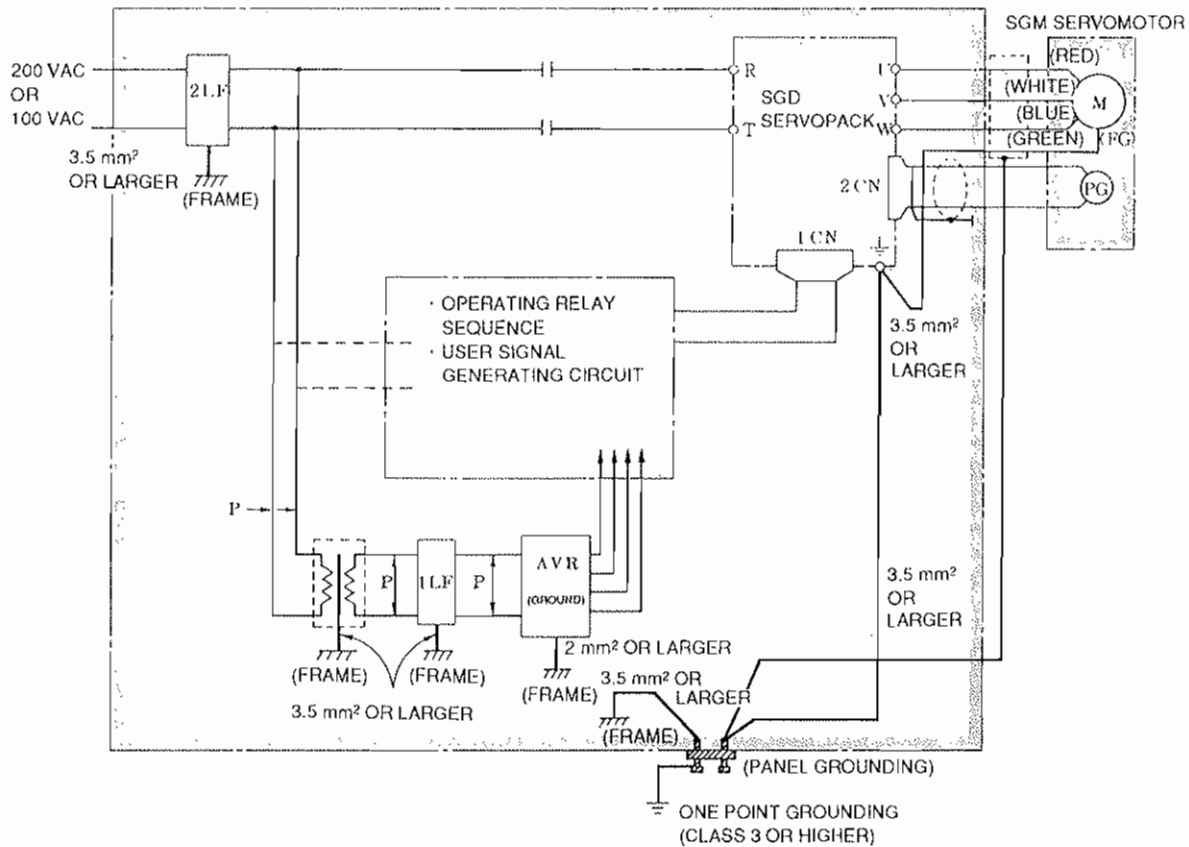
6.7 PRECAUTIONS OF OPERATION

6.7.1 Noise Control

SGD SERVOPACK uses high-speed switching elements in the main circuit. When these high-speed switching elements are switched, the effect of $\frac{di}{dt}$ or $\frac{dv}{dt}$ (switching noise) may sometimes occur depending on the wiring or grounding method.

SGD SERVOPACK incorporates a CPU. This requires wiring and provision to prevent noise interference. To reduce switching noise as much as possible, the recommended method of wiring and grounding is shown in Fig. 6.15.

(1) Grounding Method



\overline{P} : Twisted pair wires

Notes :

1. Use wires of 3.5 mm² or larger for grounding to the case (preferably flat-woven copper wire).
2. Connect line filters observing the precautions as shown in (2), "Noise Filter Installation."

Fig. 6.15 Grounding Method

• Motor frame grounding

When the motor is at the machine side and grounded through the frame, $Cf \frac{dv}{dt}$ current flows from the PWM power through the stress capacitance of the motor. To prevent this effect of current, motor ground terminal FG (motor frame) should be connected to terminal Ⓧ of SGD SERVOPACK. (Terminal Ⓧ of SGD SERVOPACK should be directly grounded.)

• SGD SERVOPACK SG 0 V

Noise may remain in the input signal line, so make sure to ground SG 0 V. When motor wiring is contained in metal conduits, the conduits and boxes must be grounded. The above grounding uses one-point grounding.



(2) Noise Filter Installation

When noise filters are installed to prevent noise from the power line, the block type must be used. The recommended noise filters are shown in Table 6.10. The power supply to peripherals also needs noise filters.

NOTE

If the noise filter connection is wrong, the effect decreases greatly. Observing the precautions, carefully connect them as shown in Figs. 6.17 to 6.19.

Table 6.10 Recommended Noise filter

Class	SGD SERVOPACK Type		Applicable Noise Filter	Recommended Noise Filter*	
				Type	Specifications
200 VAC	30 W (0.04 HP)	SGD-A3AP	 Good	LF-205A	Single-phase 200 VAC class, 5A
	50 W (0.07 HP)	SGD-A5AP			
	100 W (0.13 HP)	SGD-01AP			
	200 W (0.27 HP)	SGD-02AP		LF-210	Single-phase 200 VAC class, 10 A
	400 W (0.53 HP)	SGD-04AP		LF-220	Single-phase 200 VAC class, 20 A
	750 W (1.01 HP)	SGD-08AP			
100 VAC	30 W (0.04 HP)	SGD-A3BP	 Poor	LF-205A	Single-phase 200 VAC class, 5 A
	50 W (0.07 HP)	SGD-A5BP			
	100 W (0.13 HP)	SGD-01BP		LF-210	Single-phase 200 VAC class, 10 A
	200 W (0.27 HP)	SGD-02BP			

* Made by Tokin Corp.

- (a) Separate the input and output leads.
Do not bundle or run them in the same duct.

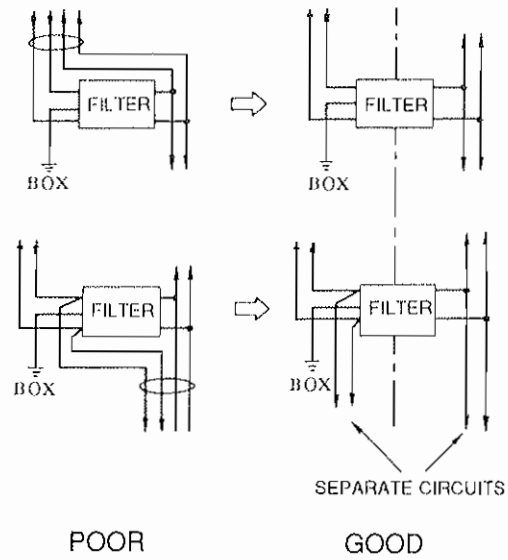


Fig. 6.16

- (b) Do not bundle the ground lead with the filter output line or other signal lines or run them in the same duct.

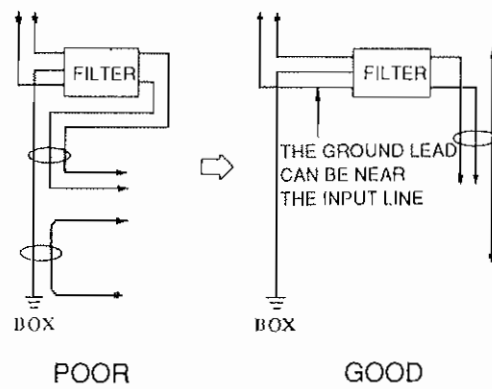


Fig. 6.17

- (c) Connect the ground lead singly to the box or the ground panel.

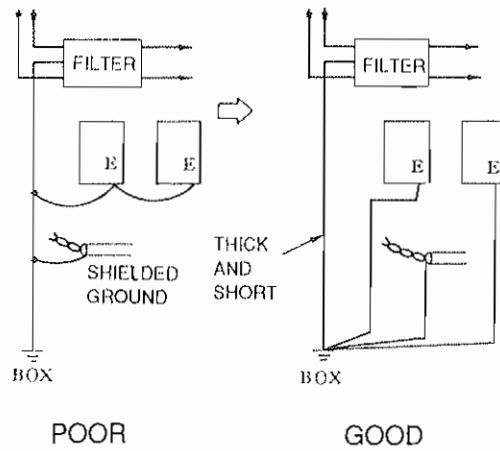


Fig. 6.18

- (d) If the control panel contains the filter, connect the filter ground and the equipment ground to the base of the control unit.

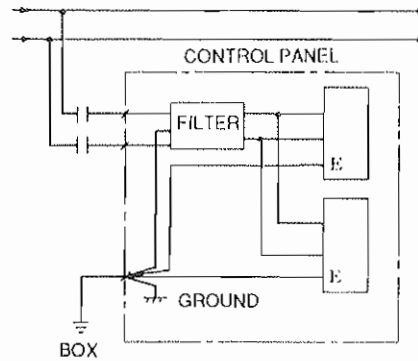


Fig. 6.19

6.7.2 Power Line Protection

SGD SERVOPACK is operated through the commercial power line (200 V or 100 V). To prevent power line accidents due to grounding error, contact error, or to protect the system from a fire, circuit breakers (MCCB) or fuses must be installed according to the number of SGD SERVOPACKS used (Table 6.11).

A fast blow fuse cannot be used, because of the in-rush current.

Table 6.11 Power Supply Capacity and MCCB or Fuse Capacity

Class	SGD SERVOPACK Type	Power Capacity Per SGD SERVOPACK* kVA	Current Capacity per MCCB or Fuse † A
200 VAC	SGD-A3AP	0.25	5
	SGD-A5AP	0.3	
	SGD-01AP	0.5	
	SGD-02AP	0.75	9
	SGD-04AP	1.2	
	SGD-08AP	2.2	
100 VAC	SGD-A3BP	0.2	5
	SGD-A5BP	0.3	
	SGD-01BP	0.5	8
	SGD-02BP	0.75	

* Values at rated load

† Operating characteristics (25°C) : 200%/2s or more, 700%/0.01s or more

6.8 APPLICATION

6.8.1 Connection for Reverse Motor Running

If the machine construction requires that the normal forward rotation reference is used for reverse motor running and the normal reverse rotation reference for forward running, set bit 0 of user constant Cn-02 to 1, or short circuit across terminals **2CN-1** and **2CN-7** on the PG connector (2CN).

In this case, other change of motor and PG connection is not required.

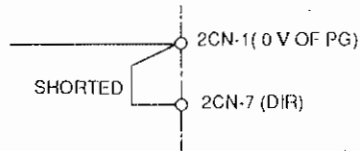


Fig. 6.20

As for the divider outputs from the SGD SERVOPACK, phase-B precedes phase-A by 90 degrees when forward rotation reference is input.

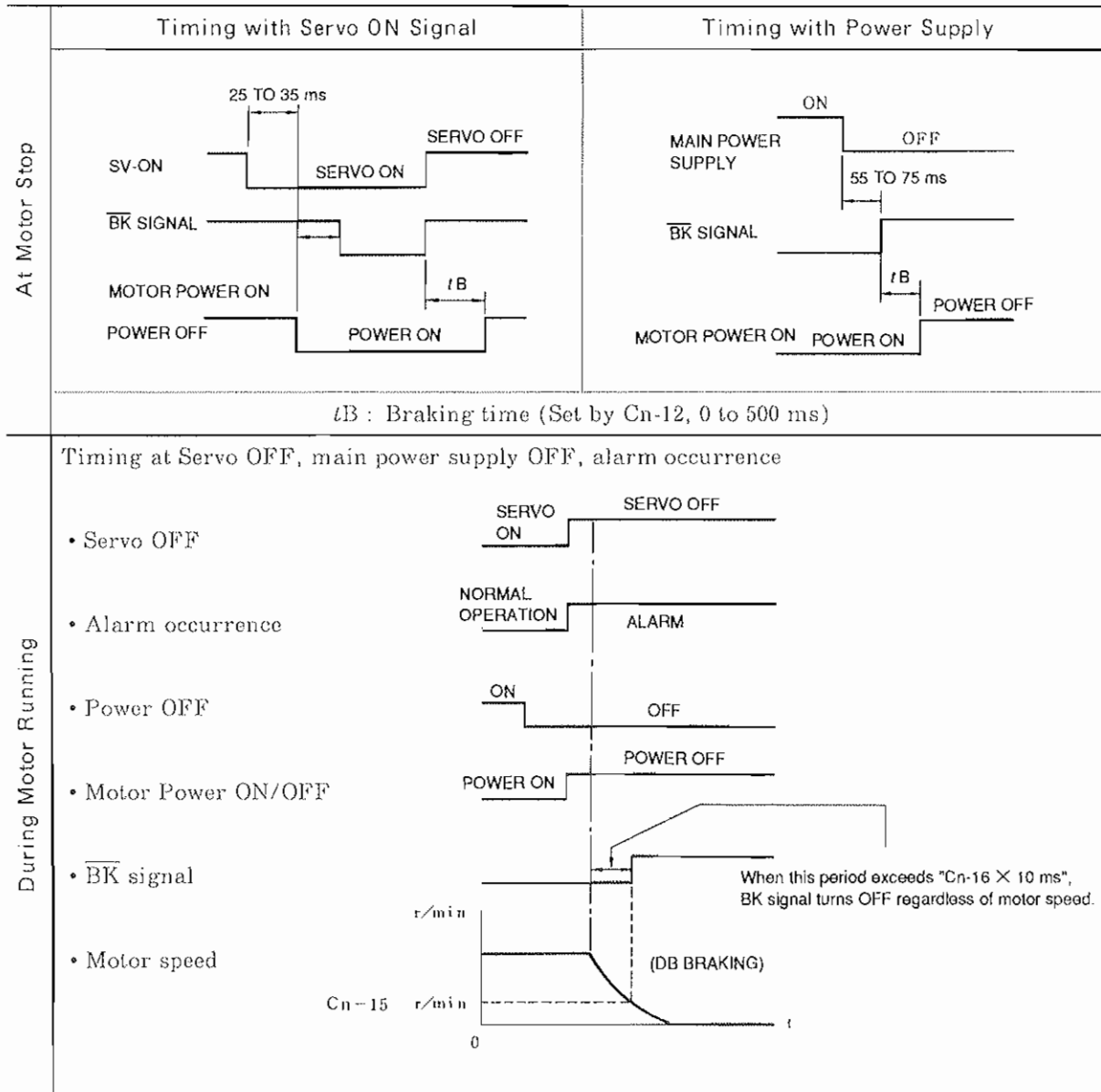
6.8.2 Holding Brake Interlock Signal

A brake signal can be output for interlocking motor circuit power ON/OFF status and motor rotation speed.

< Setup procedure >

The brake signal is output from 1CN-7 (10). Delay time t_B [$\times 10$ ms] from start of braking to motor power OFF can be adjusted by setting a value for user constant Cn-12.

Table 6.12 Brake Timing



7. USER CONSTANTS

SGD SERVOPACK supports the following user constants that can be set up and modified to fit the system.

Learn the meanings of these constants and use them. Use the digital operator to set up and modify them. (See Par. 8, "DIGITAL OPERATOR (JUSP-OP02A-1, -OP03A).")

- (1) Speed Loop Gain : Cn-04 (LOOPHZ)
 - This is the proportional gain for the speed controller. Adjustment range is from 1 to 2000 (Hz) (when used at an equivalent inertia).
 - Factory setting is 80 (Hz).
 - When motor is rotated without load, set to 40 (Hz) or lower.
- (2) Speed Loop Integration Time Constant : Cn-05 (PITIME)
 - This is integration time for the speed controller. Adjustment range is from 2 to 10,000 (ms).
 - Factory setting is 20 (ms).
- (3) Emergency Stop Torque : Cn-06 (EMGTRQ)
 - Set up braking torque for overtravel stop (a percentage of the motor is rated torque). Setting range is from 0% to the maximum torque.(100 % = rated torque)
 - It is possible to decelerate the motor at the set torque value, if the overtravel inputs P/N-OT are triggered (1CN-16, -17 set bit 8 of Cn-01).
 - Factory setting is of the maximum torque.
- (4) Forward Running Torque Limit : Cn-08 (TLMTF)
 - This is torque limit of the motor in the forward running direction. Setting range is from 0% to the maximum torque.(100 % = rated torque)
 - Factory setting is of the maximum torque.
- (5) Reverse Running Torque Limit : Cn-09 (TLMTR)
 - This is torque limit of the motor in the reverse running direction. Setting range is from 0% to the maximum torque.(100 % = rated torque)
 - Factory setting is of the maximum torque.
- (6) PG Dividing Ratio Setting : Cn-0A (PGRAT)
 - Number of detected (phase-A and -B) pulses per rotation sent from the PG (encoder) is converted to the pulse number according to the setting of this constant and is output to 1CN-20 to -23.
 - Set the number of output pulses per rotation. Setting range depends on the PG. See the following table.

Encoder	Number of Encoder Pulses (P/R)	Dividing Pulse Set Value
Incremental Encoder	2048	Any integer from 16 to 2048
Absolute Encoder	1024	Any integer from 16 to 1024

(7) Zero-Speed Level : Cn-0B (TGONLV)

- This is motor zero-speed determination level. Setting range is from 1 (r/min.) to the maximum speed.
- When the motor rotation speed exceeds the set value, sequence output TGON is turned ON (between 1CN-9 and -10 are "closed").
- Factory setting is 20 (r/min.).

(8) Mode Switches

- The following constants are used for setting mode switch operating points. Detection points where PI control is switched to P control are set for improving transient characteristic of acceleration, deceleration and output saturation of the speed controller. Different levels can be set for four types of detection points for the mode switch.

Torque reference (output from the speed controller) : Cn-0C (TRQMSW)

Speed reference : Cn-0D (REFMSW)

Detection of motor acceleration : Cn-0E (ACCMSW)

Error pulse : Cn-0F (ERPMSW)

- The detection points can be selected by setting bits C and D of user constant Cn-01.

(9) Jog Speed : Cn-10 (JOGSPD)

- Set up jogging speed. Setting range is from 0 r/min. to the maximum speed.
- To start jogging, enter the operation reference from the digital operator.
- Factory setting is 500 (r/min.).

(10) Encoder Pulse Number : Cn-11 (PULSNO)

- This is the number of pulses per rotation of the motor encoder.
- Factory setting is 2048 (P/R).
- When 12-bit absolute encoder is used, set to 1024 (P/R).

(11) Delay Time from Brake Reference Output to SVOFF Operation :

Cn-12 (BRKTIM)

- This is delay time from the output of brake reference to the actuation of SVOFF for a motor with a brake. Setting range is from 0 ms to 500 ms, in increments of 10 ms. Factory setting is 0 ($\times 10$ ms).

(12) Selection of Sequence Inputs, Reference Signal Error Stop Methods, Control Modes, and Mode Switches

Use user constant Cn-01 memory switches for the above selections. (For the assignment and explanation of the memory switches, see Table 7.4, "User Constant Cn-01 List.")

See sequences (1), (2) and select an error stop method fit for the system.

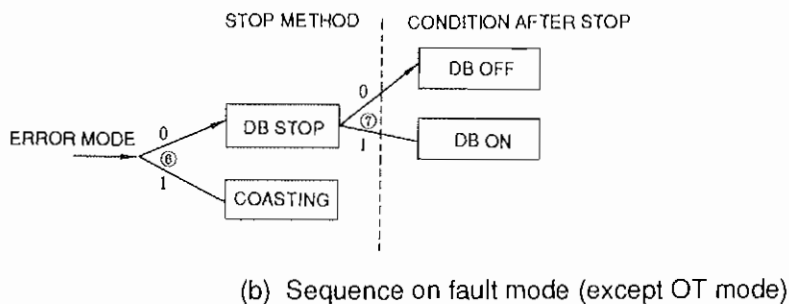
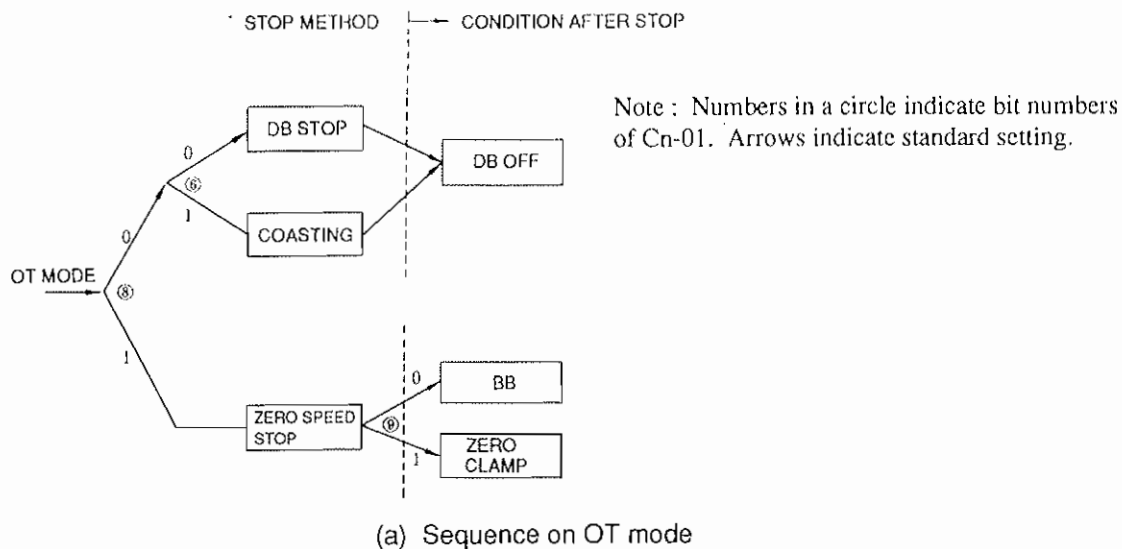


Fig. 7.1 Error Stop Sequences

(13) Forward Rotation External Current Limit : Cn-18 (CLMIF)

This is motor current limit in the forward rotation direction. This limit is effective when contact input $\overline{P-CL}$ (1CN-11) is ON. Setting range is from 0% to the maximum torque. (100 % = rated torque)

Factory setting is the maximum torque.

(14) Reverse Rotation External Current Limit : Cn-19 (CLMIR)

This is motor current limit in the reverse rotation direction. This limit is effective when contact input $\overline{N-CL}$ (1CN-12) is ON. Setting range is from 0% to the maximum torque. (100 % = rated torque)

Factory setting is the maximum torque.

(15) Position Loop Gain : Cn-1A (POSGN)

This is proportional gain for position loop. Adjustable range is from 1 to 500 (1/s). Factory setting is 40 (1/s).

- (16) Bias : Cn-1C (BIASLV)
Bias setting for position control. Used to reduce the positioning time, according to the load conditions. Adjusting range is 0 to 45 (r/min.). Factory setting is 0 (r/min.).
- (17) Feed Forward Compensation : Cn-1D (FFGN)
Feed forward compensation for the position controller. Adjusting range is 0 to 100 (%). Factory setting is 0 (%).
- (18) Positioning Completion Width : Cn-1B (COINLV)
Sets range of positioning completion signal output (COIN). Setting range is 0 to 100 (reference unit). Factory setting is 7 (reference unit).
- (19) Overflow : Cn-1E (OVERLV)
Detects overflow detection level. Setting range is 1 to 65535 ($\times 256$ reference units). Factory setting is 1024 ($\times 256$ reference unit).
- (20) Contact Input Speed Control
The following constants are used to enter a mode where speed control is performed according to contact inputs $\overline{P-CL}$ and $\overline{N-CL}$ (1CN-11, -12).
Three speeds are programmed.
Corresponding user constants are shown below.
- 1st speed : Cn-1F (SPEED1)
 - 2nd speed : Cn-20 (SPEED2)
 - 3rd speed : Cn-21 (SPEED3)
- Setting range of each constant is from 0 (r/min.) to the maximum speed. Factory setting is 100 (r/min.) for the first speed, 200 (r/min.) for the second, and 300 (r/min.) for the third.

Table 7.1 Rotation Direction Setting

Rotation Direction	P-CON
Forward	OFF
Reverse	ON

Table 7.2 Speed Setting

Selected Speed	N-CL	P-CL
1st	ON	OFF
2nd	ON	ON
3rd	OFF	ON
Stop	OFF	OFF

- (21) Electronic Gear Ratio : Cn-24 (RATB), Cn-25 (RATA)
Electronic gear ratio B/A (Cn-24/Cn-25) indicates the number of encoder pulses per reference unit, with a limitation of $0.01 \leq B/A \leq 100$. If this condition is not established, recheck the machine specifications. When $B/A < 1$, since the reference unit becomes smaller than the encoder pulse resolution, the smaller the B/A value becomes, the worse positioning accuracy becomes.

For calculation of electronic gear ratio, refer to Par. 6.2.8 "Function of Electronic Gears".

Table 7.3 User Constants Cn-04 through Cn-27 (Constant Setting) List

	User Constant	Symbol	Name	Unit	Lower Limit	Upper Limit	Setting Prior to Shipment	Remarks
Gain Constants	Cn-04	LOOPHZ	Speed Loop Gain	Hz	1	2000	80	*
	Cn-05	PITIME	Speed Loop Integration Time	ms	2	10000	20	
	Cn-1A	POSGN	Position Loop Gain	1/s	1	500	40	
	Cn-1C	BIASLV	Bias	r/min	0	450	0	
	Cn-1D	FFGN	Feed Forward	%	0	100	0	
Torque Constants	Cn-06	EMGTRQ	Emergency Stop Torque	%	0	Max Torque	Max Torque	OT Note Mode
	Cn-08	TLMTF	Forward Running Torque Limit	%	0	Max Torque	Max Torque	Note
	Cn-09	TLMTR	Reverse Running Torque Limit	%	0	Max Torque	Max Torque	Note
	Cn-17	TRQFIL	Torque Reference Filter Time	100 μs	0	250	4	
	Cn-18	CLMIF	Forward External Current Limit	%	0	Max Torque	100	Note
	Cn-19	CLMIR	Reverse External Current Limit	%	0	Max Torque	100	Note
Sequence Constants	Cn-07	SFSACC	Soft Start Time	ms	0	10000	0	#
	Cn-23	SFSDEC	Soft Start Time (Deceleration)	ms	0	10000	0	#
	Cn-0B	TGONLV	Zero-speed Level	r/min	1	Max Speed	20	
	Cn-12	BRKTIM	Delay Time from Braking Reference to SVOFF	10 ms	0	50	0	
	Cn-15	BRKWAI	Brake Timing at Motor Rotation (Speed level at which brake reference is output.)	r/min	0	Max Speed	100	
	Cn-16	BRKSPD	Brake Timing at Motor Rotation (Waiting time from SVOFF to brake reference output.)	10 ms	10	100	50	
	Cn-1B	COINLV	Positioning Completion Width (COIN Output Width)	Reference Unit	0	250	1	

Note : 100% = rated torque

* Factory setting of Cn-04 (speed loop gain) is determined by the following conditions :

Load inertia ≤ motor inertia × 3

Be sure to set the value of Cn-04 to -20 or less when motor is rotated without load. If the value has been kept at the factory setting, the motor may oscillate.

† After modifying Cn-0A, 11, 24 and 25, turn OFF power and start up again. The modified value takes effect only after restarting.

‡ Electronic gear ratio (Cn-24, Cn-25) : $0.01 \leq \frac{B (Cn-24)}{A (Cn-25)} \leq 100$

Soft start function is effective at jog operation or internally set speeds selection. Soft start function is not effective when pulse train is used as reference.

Table 7.3 User Constants Cn-04 through Cn-27 (Constant Setting) List (Cont'd)

	User Constant	Symbol	Name	Unit	Lower Limit	Upper Limit	Setting Prior to Shipment	Remarks
Encoder Pulse Constants	Cn-0A	PGRAT	PG Dividing Ratio	P/R	16	32768	Encoder Number of Pulses 2048	†
	Cn-11	PULSNO	Number of Encoder Pulses	P/R	513	32768	Encoder Number of Pulses 2048	†
Other Constants	Cn-0C	TRQMSW	Mode Switch (Torque Reference)	%	0	Max Torque	200	Note
	Cn-0D	REFMSW	Mode Switch (Speed Reference)	r/min	0	Max Speed	0	
	Cn-0E	ACCMSW	Mode Switch (Motor Acceleration Detection)	10 (r/min)/s	0	3000	0	
	Cn-0F	ERPMSW	Mode Switch (Error Pulse)	Reference Unit	0	10000	10	
	Cn-10	JOGSPD	JOG Speed	r/min	0	Max Speed	500	
	Cn-1E	OVERLV	Overflow	×256 (Reference Unit)	1	65535	1024	
	Cn-1F	SPEED1	1st Speed	r/min	0	Max Speed	100	
	Cn-20	SPEED2	2nd Speed	r/min	0	Max Speed	200	
	Cn-21	SPEED3	3rd Speed	r/min	0	Max Speed	300	
	Cn-26	ACCTME	Position Reference Accel/Decel Time Constant (Smoothing)	0.1 ms	0	640	0	
Cn-27	FFFILT	Feed Forward Reference Filter	0.1 ms	0	640	0		
Electronic Gear	Cn-24	RATB	Electronic Gear Ratio (molecule)		1	65535	4	† ‡
	Cn-25	RATA	Electronic Gear Ratio (denominator)		1	65535	1	† ‡

Note : 100% = rated torque

* Factory setting of Cn-04 (speed loop gain) is determined by the following conditions :

Load inertia ≤ motor inertia × 3

Be sure to set the value of Cn-04 to -20 or less when motor is rotated without load. If the value has been kept at the factory setting, the motor may oscillate.

† After modifying Cn-0A, 11, 24 and 25, turn OFF power and start up again. The modified value takes effect only after restarting.

‡ Electronic gear ratio (Cn-24, Cn-25) : $0.01 \leq \frac{B(Cn-24)}{A(Cn-25)} \leq 100$

Soft start function is effective at jog operation or internally set speeds selection. Soft start function is not effective when pulse train is used as reference.

Table 7.4 User Constant Cn-01 (Memory Switch) List

Selection	Bit No.	Setting	Conditions	Standard	
Sequence Input Selection	0	0	Servo ON/OFF by external input (SV-ON).	0	
		1	The servo is ON at all times.		
	1	—	Don't change.	—	
		0	The P-OT signal prohibits forward running.		
	2	0	The P-OT signal prohibits forward running.	0	
		1	Forward running is permitted at all times.		
3	0	The N-OT signal permits reverse running.	0		
	1	Reverse running is permitted at all times.			
Sequence Output Signal Changeover (TGON)	4	0	$\overline{\text{TGON}}$ signal is used as a signal output when rotation is detected. (TGON)	0	
		1	$\overline{\text{TGON}}$ signal is used as a signal when current limit is detected.		
Treatment of Momentary Power Loss Reset	5	0	Maintains the servo alarm status at momentary power loss reset.	0	
		1	Releases the servo alarm status automatically at momentary power loss reset.		
Fault Stop Selection	6	0	<DB stop> The dynamic brake stops the motor.	0	
		1	<Coasting to a stop> The motor is freed and brought to a stop.		
	7	0	<DB OFF after DB stop> The dynamic brake is turned OFF after the motor is stopped.	1	
		1	<OB continuously ON after DB stop> The dynamic brake remains activated after the motor is stopped.		
	8	0	The overtravel status stop method coincides with bit 6.	0	
		1	<Overtravel zero speed stop> In the overtravel status, the motor is stopped at the torque setting defined by user constant Cn-06.		
	9*	0	In the overtravel status, base blocking (BB) is implemented after zero speed stop.	0	
		1	In the overtravel status, zero clamping is effected after zero speed stop.		
	Position Error at Base Blocking	A	0	Clears.	0
			1	Does not clear.	
Mode Switch Function	B	0	The mode switch function is provided. The mode switch operation agrees with bits C and D.	0	
		1	The mode switch function is not provided.		
Mode Switch Selection	D·C†	0·0	<Torque reference> Based on the torque reference level defined by user constant Cn-0C.	00	
		0·1	<Speed reference> Based on the speed reference level defined by user constant Cn-0D.		
		1·0	<Acceleration> Based on the acceleration level defined by user constant Cn-0E.		
		1·1	<Error pulse> Based on the error pulse level defined by user constant Cn-0F.		
Encoder Selection	E‡	0	Incremental encoder	0	
		1	Absolute encoder		
—	F		Don't change.	0	

* Selects the status based on the stop method selected for the overtravel status (bit 8).

† Selects the mode switch operating condition. When the mode switch operates, the speed control mode changes from P·I control to P control.

‡ When the value of user constant Cn-01 is changed, turn OFF the power supply once and restart the operation. The changed value after restart of operation is effective.

Table 7.5 User Constant Cn-02 (Memory Switch) List

Selection	Bit No.	Setting	Description	Standard
Reverse Rotation Mode	0	0	CCW : Forward running	0
		1	CW : Forward running	
Home Position Error Mask	1 (ABSO.) (PG only)	0	Home position error is detected.	0
		1	Home position error is not detected.	
Contact Reference Mode	2	0	Contact inputs P-CL and N-CL are used as power supply limit ON/OFF reference inputs.	0
		1	Contact inputs \bar{P} -CL and \bar{N} -CL are used as speed input reference selection (1st to 3rd speed) signals.	
Mode Reference Pulse	3, 4, 5	000	SIGN + PULSE	000
		100	CW + CCW	
		010	Phase-A + Phase-B ($\times 1$)	
		110	Phase-A + Phase-B ($\times 2$)	
		001	Phase-A + Phase-B ($\times 4$)	
For Adjustment	6, 7, 8, 9	6	Don't change.	0
		7	Don't change.	0
		8, 9	Don't change.	0
Error Counter Clear	A	0	Solid (High level signal)	0
		1	Differential (Leading edge)	
	B		Don't change.	
		C		Don't change.
Reference Pulse Reversal	D	0	Normal operation	0
		1	Reverse operation	
Output Level Changeover	E	0	Changes the digital monitor (position deviation) to reference unit ($\times 1$)	0
		1	Changes the digital monitor (position deviation) to reference unit ($\times 100$)	
	F		Don't change.	

Note : Turn OFF the power supply once setting and restart the operation.

8. DIGITAL OPERATOR (TYPES : JUSP-OP02A-1, 03A)

8A. DIGITAL OPERATOR (TYPE : JUSP-OP02A-1) OPERATION METHOD

8A.1 SWITCH OPERATION

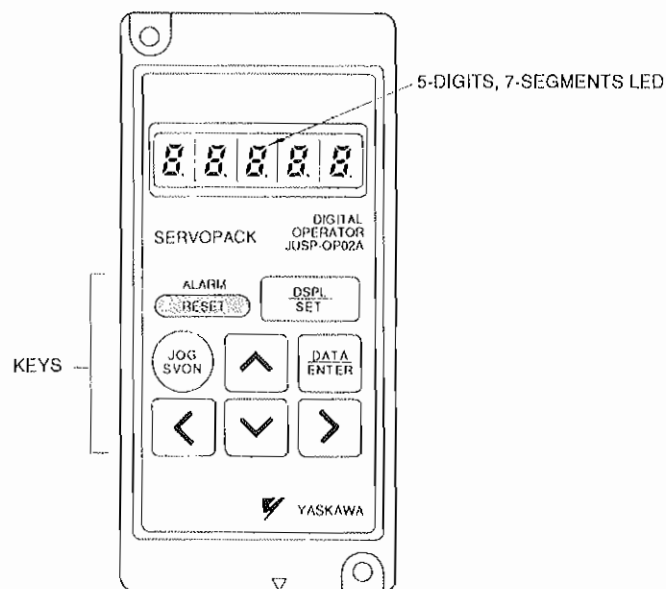
Fig. 8A.1 shows the digital operator. The digital operator has various functions as listed by modes in Par. 8A.2, "DIGITAL OPERATOR FUNCTION."

Notes :

1. The data set by the digital operator is retained in SERVOPACK even after the power is turned OFF.
2. Even if the power is turned OFF after fault occurrence, the fault data is retained in memory. Therefore, it is possible to check the fault data after the power is turned back ON.
3. The monitor mode can be changed even during operations.



Fig. 8A.1 Digital Operator (Hand-held Type)



8A.2 DIGITAL OPERATOR FUNCTIONS


Table 8A.1 shows the digital operator's functions. The status display is the default when control power is turned ON. To change the mode, use  key as shown in Fig. 8A.2.

Table 8A.1 Digital Operator Functions

Mode	Function
Status Indication Mode	Various Status Indications • Base Block • On Operation • Fault (See Par. 8A.3)
Setting Mode	Refer to "User Constant Setting." (See Par. 8A.4.1) • Operation (JOG) from digital operator (See Par. 8A.4.3) • Clearing Fault Traceback Data (See Par. 8A.4.4) • Check of Motor Parameters (See Par. 8A.4.5) • Auto Tuning (See Par. 8A.4.6) • Check of Software Version (See Par. 8A.4.7)
Monitor Mode	Various Monitoring • Speed • Torque Reference • Number of Pulses from Origin (Phase-U) • Electrical Angle • Internal Status Bit • Position Error (See Par. 8A.4)
Fault Traceback Indication Mode	Fault History (See Par. 8A.5)

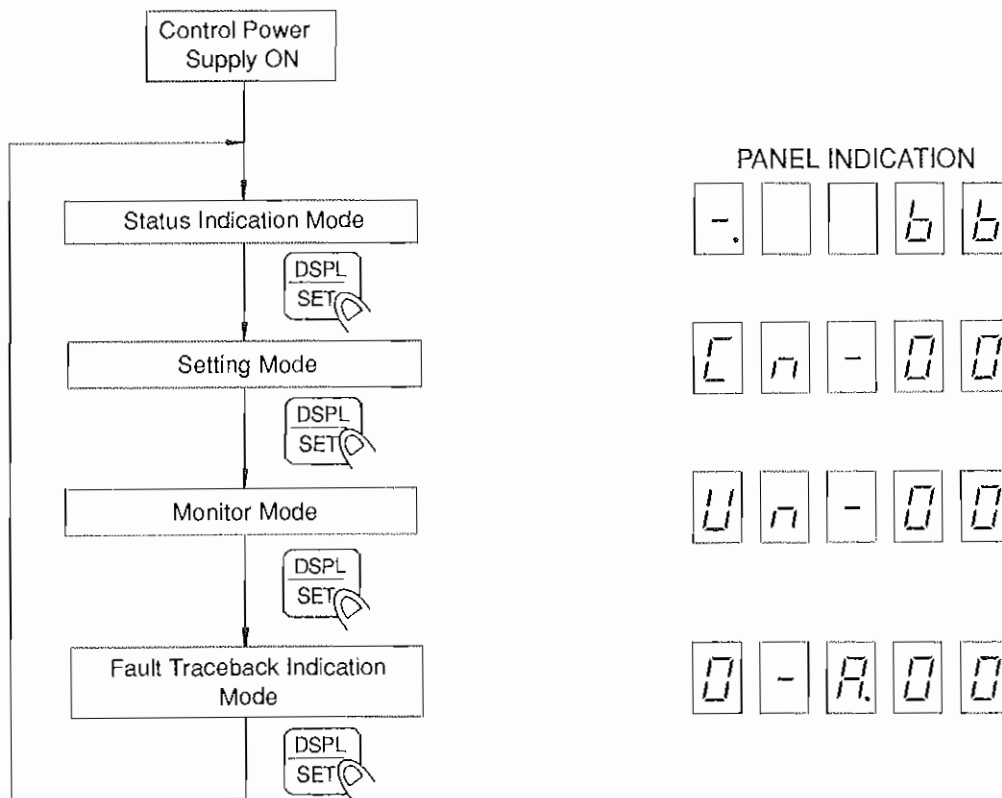


Fig. 8A.2 Mode Changeover

8A.3 STATUS INDICATION MODE

When this mode is selected, the condition of SERVOPACK is indicated with bits and codes as shown in Fig. 8A.3. Table 8A.2 shows the bit data contents. Table 8A.3 shows the codes and conditions.

ALARM

RESET : Alarm reset switch

**DSPL
SET**

: Changes status indication mode into setting mode.

Panel Display

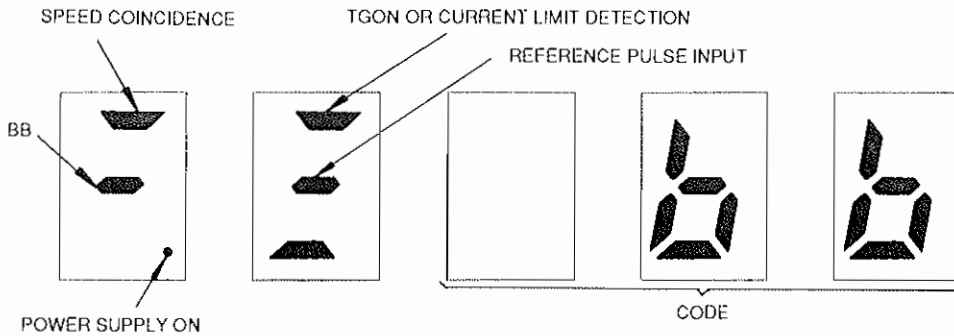


Fig. 8A.3 Status Indication Mode

Table 8A.2 Bit Data Contents

Bit Data	Contents	Remarks
Power Supply ON	Light goes ON with power supply ON.	
BB	Light goes ON with base block, and goes OFF with servo ON.	
Positioning Completion	Light goes ON when positioning is completed.	
TGON	Light goes ON with motor rotating speed higher than TGON level (Standard setting is 20 r/min).	Selected by bit 4 of user constant Cn-01.
Current Limit Detection	Light goes ON when torque reference reaches the torque limit value. (TGON or current limit detection is displayed according to bit 4 of user constant Cn-01.)	
During Reference Pulse Input	Light goes ON during reference pulse input.	

Table 8A.3 Codes and Status

Code	Status
<i>bb</i>	Base Block
<i>run</i>	On Operation
<i>pot</i>	Forward Running Prohibited
<i>not</i>	Reverse Running Prohibited
<i>A00</i> {	Alarm Status Refer to Table 8A.6.

8A.4 SETTING MODE

In this mode, the following operations can be performed.

- User constant setup and monitor
- Jog operations from the digital operator
- Fault traceback data clearing
- Check of motor parameters
- Auto tuning
- Check of software version

8A.4.1 User Constant (Data) Setup and Monitor (Cn-04 to Cn-27)

Panel Display

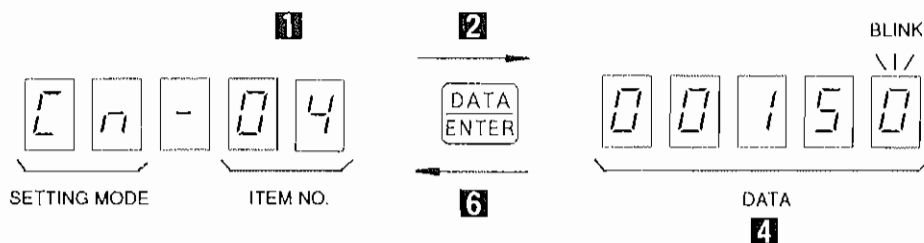


















Fig. 8A.4 User Constant Setting

- 1 Set up the item number with the , , , or  key.
 - With the  or  key, choose a setup digit. The chosen digit starts blinking to indicate that its numerical value can be changed.
 - With the  or  key, increase or decrease the numerical value until the desired value is obtained.
- 2 With the  key, display the data related to the selected item number.
- 3 With the , , , or  key, set up the data. (The same operation as stated in 1.)
- 4 Retain the data with the  key.
- 5 With the  key, return to the item No. display status.
- 6 Repeat steps 1 through 5 as needed.
- 7 Using the  key, switch from the setting mode to the monitor mode.

For details, see Table 7.3, "User Constants Cn-04 through Cn-27 (Constant Setting) List."

8A.4.2 User Constant (Memory Switch) Setup and Monitor (Cn-01 and Cn-02)

User constants Cn-01 and Cn-02 can be set up or monitored as memory switch bits. The procedures for item number setup and data display are the same as indicated in Par. 8A.4.1 1 and 2.

Panel Display

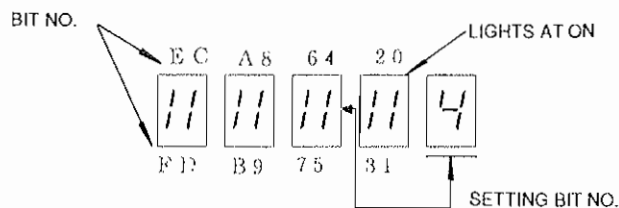


Fig. 8A.5 Bit Data Display









- 1 With the  or  key, enter the setup memory switch bit No. at the far right end of the panel.
- 2 With the  key, set the memory switch to ON or OFF (either  or  can be used). The panel indication comes on when the switch is ON, and goes off when the switch is OFF.
- 3 Repeat steps 1 and 2 as needed.
- 4 Retain the data with the  key.
- 5 With the  key, return to the item No. display status.
- 6 Using the  key, switch from the setting mode to the monitor mode.

Table 7.4 shows memory switches of user constant Cn-01, and Table 7.5 those of user constant Cn-02.

8A.4.3 Digital Operator Jog Operation Mode Selection and Operating Procedure

(1) Digital Operator Jog Operation Mode Selection

When user constant Cn-00 is set to 00, the operations are to be controlled from the digital operator.

Panel Display

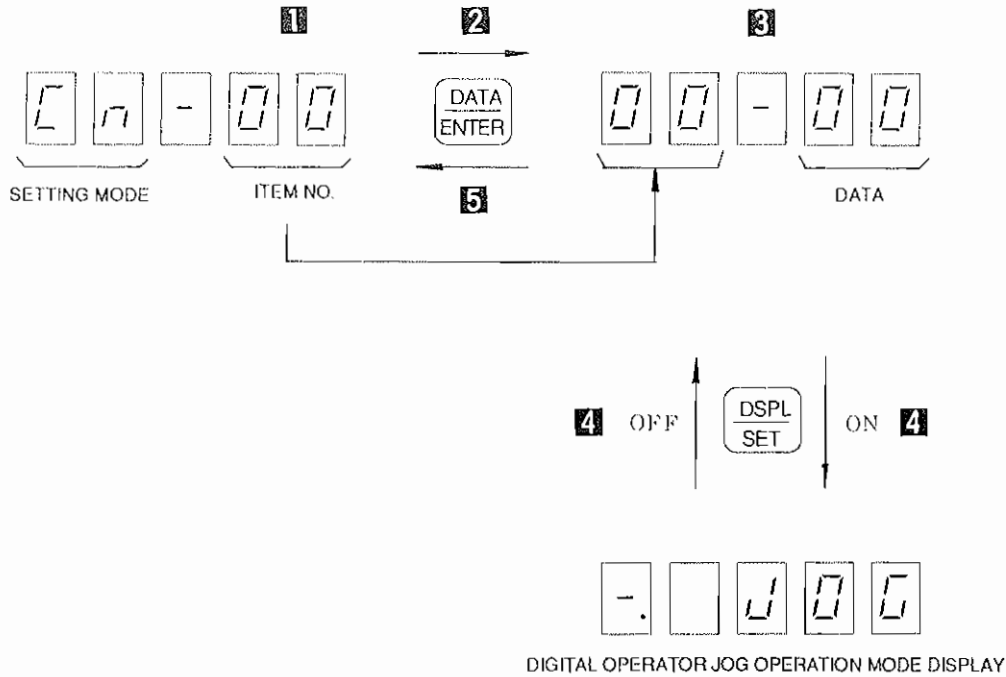

















Fig. 8A.6 Digital Operator Jog Operation Mode

- 1** Select the item number 00 with the , ,  or  key.
- 2** With the  key, display the data related to the selected item number.
- 3** With the , ,  or  key, select the number 00.
- 4** With the  key, turn ON or OFF the monitor panel jog operation mode.
- 5** With the  key, return to the item No. display status.
- 6** Using the  key, switch from the setting mode to the monitor mode.

(2) Digital Operator Jog Operation Procedure

For speed reference adjustment, use user constant Cn-10 (see Table 7.3).

- 1 With the  switch, effect SVON/SVOFF changeover.
- 2 The motor runs in the forward direction while the  key is held down.
- 3 The motor runs in the reverse direction while the  key is held down.

8A.4.4 Clearing Fault Traceback Data

When user constant Cn-00 is set to 02, fault traceback data are cleared.

Panel Display

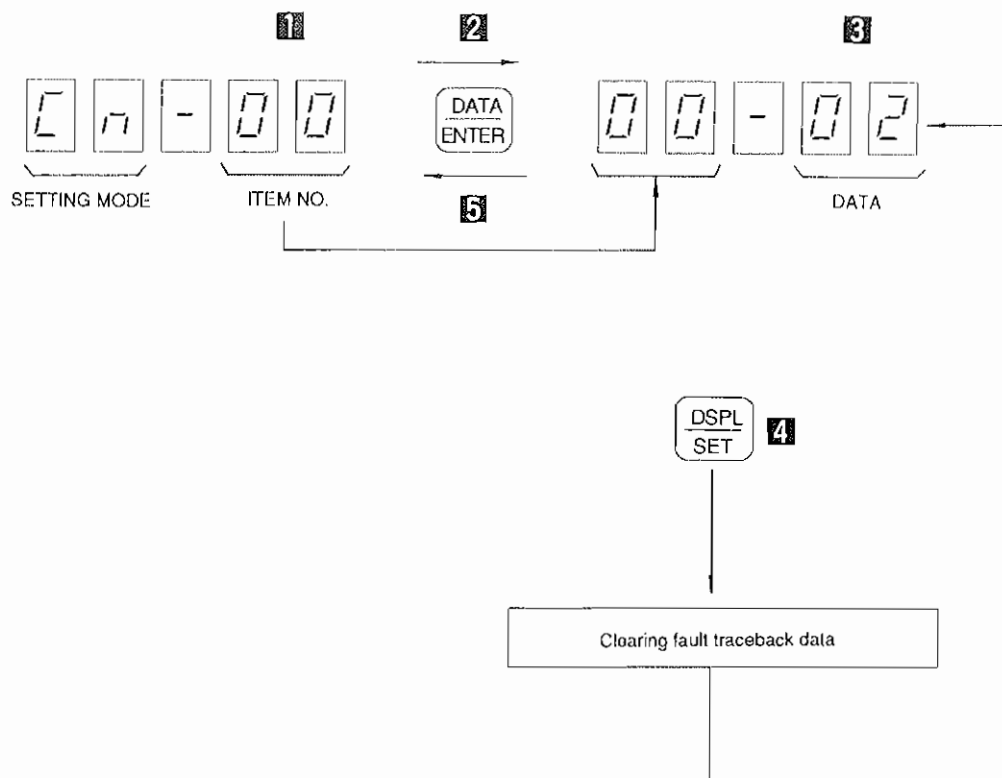














Fig. 8A.7 Clearing Fault Traceback Data

- 1 Select the item number 00 with the  ,  ,  or  key.
- 2 With the  key, display the data related to the selected item number.
- 3 With the  ,  ,  or  key, select the number 02.
- 4 With the  key, clear fault traceback data and return to the user constant Cn-00 data display status.
- 5 With the  key, return to the item No. display status.
- 6 Using the  key, switch from the setting mode to the monitor mode.

8A.4.5 Check of Motor Parameters

(1) Check Method of Motor Parameters

When user constant Cn-00 is set to 04, the system enters the motor parameter check mode.

Panel Display

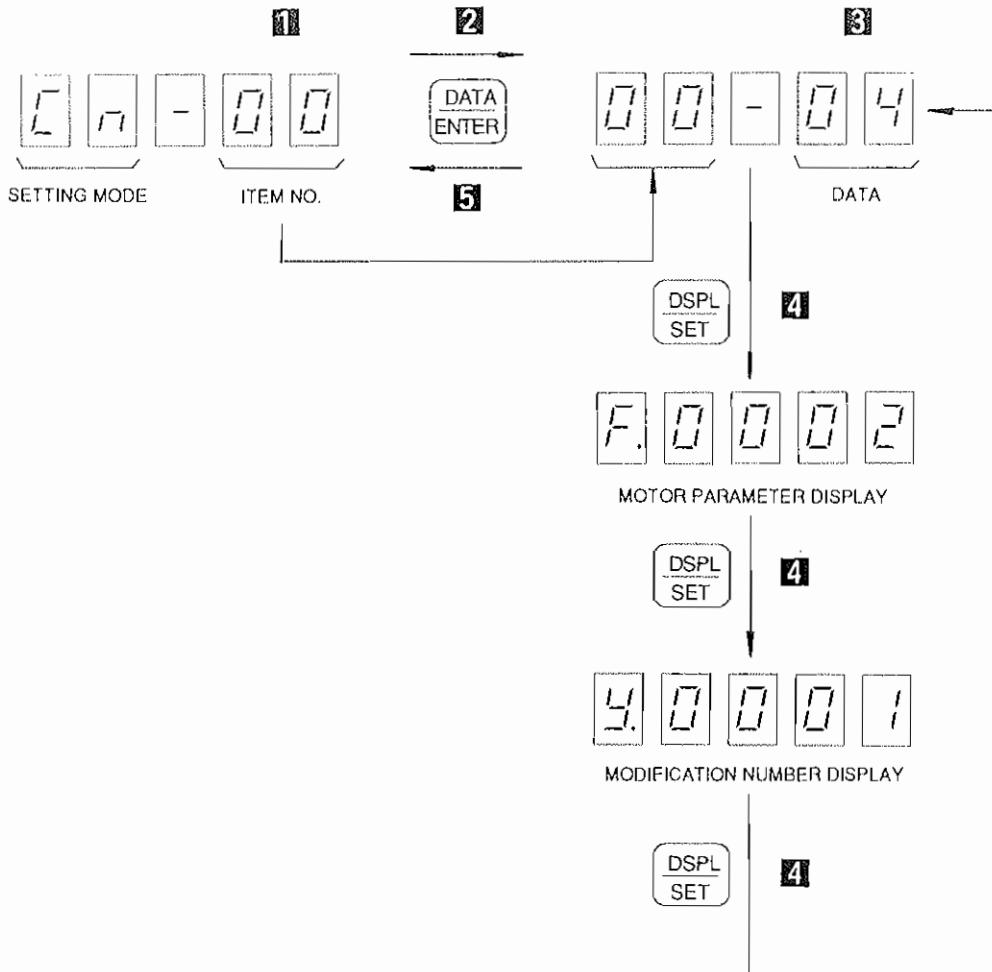














Fig. 8A.8 Switch Functions in Motor Parameter Check

- 1 Set up item number 00 with the , ,  or  key.
- 2 With the  key, display the data related to the selected item number.
- 3 With the , ,  or  key, select the number 04.
- 4 With the  key, check the motor parameter.
- 5 With the  key, return to the item No. display status.
- 6 Using the  key, switch from the setting mode to the monitor mode.

(2) Parameter Display

· Motor Parameter

F. 0 0 0 2

Motor Capacity

9E : 30 W (0.04HP)

b2 : 50 W (0.07HP)

01 : 100 W (0.13HP)

02 : 200 W (0.27HP)

04 : 400 W (0.53HP)

08 : 750 W (1.01HP)

Motor Type

0 : Σ Siries, 200 V

1 : Σ Siries, 100 V

· Modification Index

4. a b c d

Modification No. (Hexadecimal display)

$(a \times 16^3 + b \times 16^2 + c \times 16 + d) = \text{Modification No.}$

Nos. Corresponding to Alphabets

A = 10

b = 11

C = 12

d = 13

E = 14

F = 15

8A.4.6 Auto Tuning

(1) Mode Setting in Auto Tuning

When user constant Cn-00 is set to 05, the system enters the auto tuning mode.

Panel Display

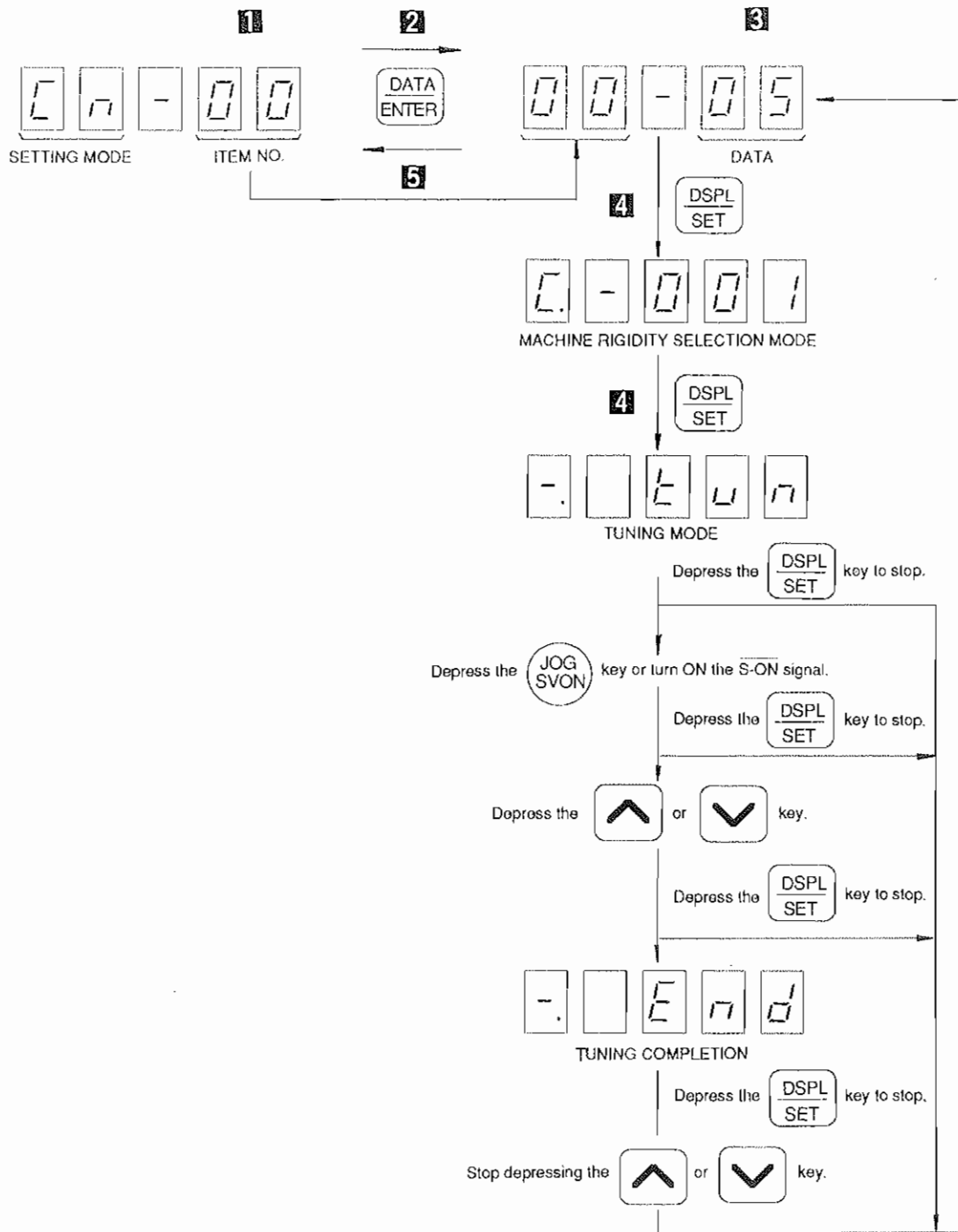
















Fig. 8A.9 Auto Tuning Mode

- 1 Set up item number 00 with the  ,  ,  or  key.
- 2 With the  key, display the data related to the selected item number.
- 3 With the  ,  ,  or  key, select the number 05.
- 4 With the  key, switch to the machine rigidity selection mode or tuning mode.
- 5 With the  key, return to the item No. display status.
- 6 Using the  key, switch from the setting mode to the monitor mode.

(2) Tuning Method


(a) Speed setting


When tuning is being performed, the maximum value of speed reference is set by user constant Cn-10. Set the value to approximately 500 r/min. (If the value is too small, auto tuning cannot be performed properly.)


The motor runs intermittently when the  or  key is held down. (The motor does not run at the same speed continuously.)

(b) Machine rigidity selection

According to the machine rigidity, select the following :


 : Low response




 : Medium response


 : High response

When the machine rigidity is not defined, select the middle-speed response.

· Machine vibration


When entering the servo ON status with the  switch or machine vibrates


suddenly at depressing the  or  key, depress the  key and stop the tuning operation.

Then depress the  key to enter the machine rigidity selection mode, and set the level of machine rigidity selection at one level lower.




· When tuning is not completed.





When tuning is not completed even though the machine does not vibrate, depress the

 key to stop the tuning operation.




Then depress the  key to enter the machine rigidity selection mode and set the level of machine rigidity selection at one level higher.

(c) Tuning

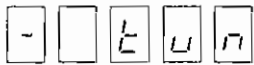
- 1 With the  switch, effect SVON/SVOFF changeover.
- 2 The motor runs in the forward direction while the  key is held down.
- 3 The motor runs in the reverse direction while the  key is held down.

Note : If the machine vibrates when depressing the  or  key, stop depressing the  or  key since the gain is decreased.

- 4 With the tuning completion,  is displayed and power supply to the motor is stopped.

Stop depressing the  or  key. Display is returned to .

(d) Input signals

- In the auto tuning mode, OT signal is effective.
Make sure to input OT signal.
When absolute encoder is used, SEN signal is also effective and should be input.
When these signals are not used, set the bits of 1, 2 and 3 of user constant Cn-01 to 1 respectively.
- During overtravel (OT signal is OFF), auto tuning cannot be performed.
Perform auto tuning when the driven part of the machine is not in the overtravel position.
- When performing auto tuning, make sure to keep the $\overline{\text{P-CON}}$ signal OFF (PI control status).
- When $\overline{\text{S-ON}}$ signal is used, display the  and turn ON the signal.

8A.4.7 Check of Software Version

(1) Mode Setting in Software Version Check

When user constant Cn-00 is set to 06, the system enters the software version check mode.

Panel Display

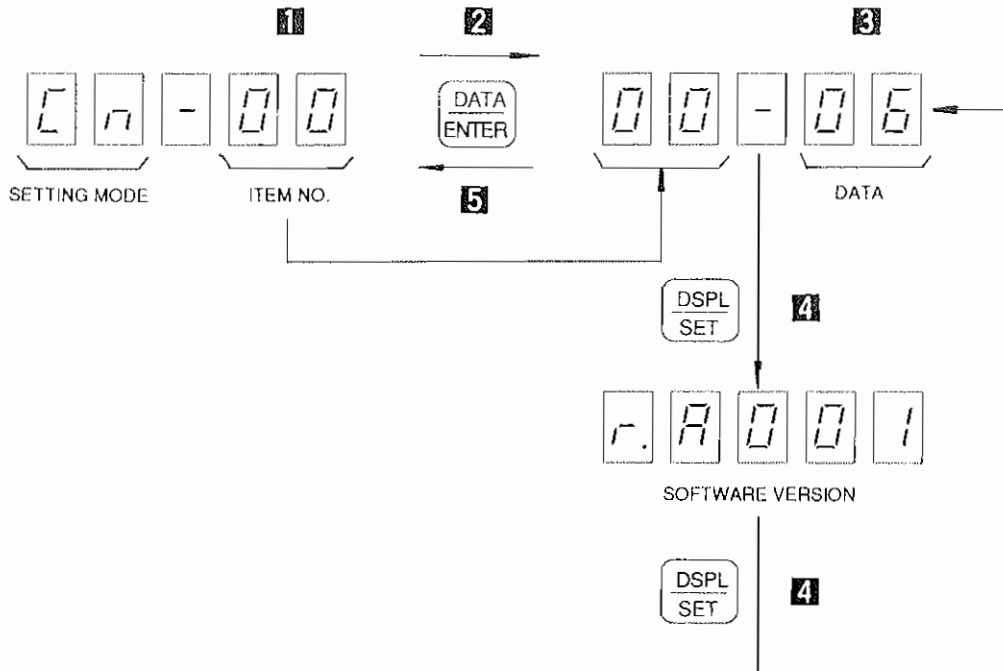














Fig. 8A.10 Software Version Check Mode

- 1** Set up item number 00 with the  ,  ,  or  key.
- 2** With the  key, display the data related to the selected item number.
- 3** With the  ,  ,  or  key, select the number 06.
- 4** With the  key, display the software version.
- 5** With the  key, return to the item No. display status.
- 6** Using the  key, switch from the setting mode to the monitor mode.

(2) Software Version Display



Software Version No.

Type

A : Speed control

d : Positioning control

8A.5 MONITOR MODE

In this mode, the speed reference, torque reference, and other data can be monitored on the digital operator.

Table 8A.4 lists the data that can be monitored.

Monitor No.	Data Monitored
00	Feedback Speed (r/min)
02	Torque Reference (%)
03	No. of Pulses from Phase-U edge
04	Electrical Angle (deg)
05	Internal Status Bit Display 1 (Refer to Table 8A.5)
06	Internal Status Bit Display 2 (Refer to Table 8A.5)
07	Reference Pulse Speed Display (r/min)
08	Position Error (Reference unit)

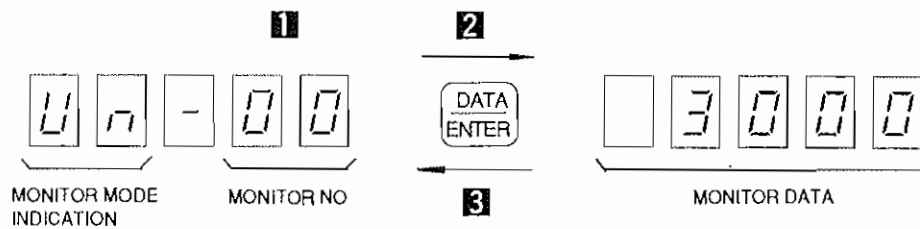


Fig. 8A.11 Switch Functions in Monitor Mode






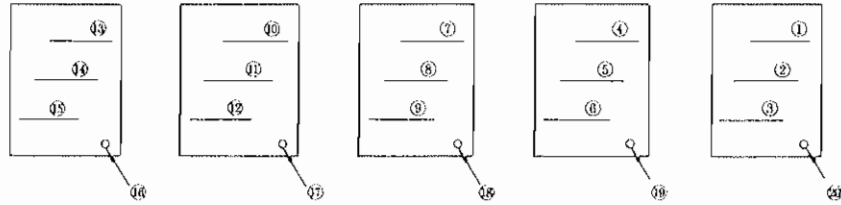
- 1 With the  or  key, select a desired monitor No.
- 2 With the  key, initiate monitor display.
- 3 Using the  key, return to the monitor No. selection status.
- 4 With the  key, switch from the monitor mode to the fault traceback mode.

Table 8A.5 Bit Indication of Monitor Mode Un-05, Un-06 Internal Status



Bit No.	Symbol	Contents	Remarks	
①	SVALM	Turns ON at servo alarm		
②	DBON	Turns ON at dynamic braking		
③	DIR	Turns ON in reverse run mode		
④	TGON	Turns ON at motor running (Motor speed is TGON level or higher)	Select by setting of bit 4 of user constant Cn-01.	
	CLT	Turns ON during current limit		
⑤	COIN	Turns ON at positioning completion		
⑥	MSON	Turns ON at mode switch ON		
⑦	P-CL	Turns ON during forward current limit		
⑧	N-CL	Turns ON during reverse current limit		
⑨	B-ON	Motor under current condition		
Un-05	⑩	PA	Turns OFF when each of input signal is at high level.	
	⑪	PB		
	⑫	PC		
	⑬	PU		Incremental encoder only
	⑭	PV		Incremental encoder only
	⑮	PW		Incremental encoder only
⑯	SVON	Turns ON at SVON signal is ON.		
⑰	P-CON	Turns ON during P operation input	Select by setting of bit A or B of user constant Cn-01 or bit 2 of user constant Cn-02.	
	DR	Rotating direction input by external setting speed (ON at reverse, OFF at forward)		
⑱	P-OT	Turns ON at forward running prohibit input status		
⑲	N-OT	Turns ON at reverse running prohibit input status		
⑳	---	---	---	
Un-06	①	PUL	Reference pulse input	
	②	SIGN	Sign input	
	③	CLR	Error counter clear input	
	④ to ⑳	---	---	

8A. 6 FAULT TRACEBACK MODE

In this mode, information on past fault occurrences can be displayed.

- Information on up to 10 past fault occurrences can be stored.
- When a fault is reset or the control power is turned ON, traceback data A.99 is saved (These data are also counted as one of a total of 10 stored items of fault information.)
- For the relationship between traceback data and fault descriptions, refer to Table 8A.6.

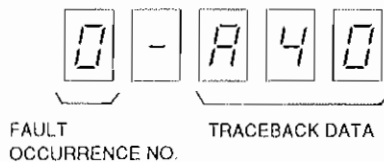


Fig. 8A.12 Fault Traceback Mode




- 1 With the  or  key, increase or decrease the fault occurrence number.
The fault information related to the selected number is then displayed. (The higher the fault occurrence number, the older the fault occurrence.)
- 2 With the  key, switch from the fault traceback mode to the status display mode.

Table 8A.6 Error Displays with Digital Operator and Traceback Data

Digital Operator (Traceback Data)	Detection	Remarks
<i>R00</i>	Absolute Encoder Data Error	Only when absolute encoder is used.
<i>R02</i>	Parameter Breakdown	
<i>R04</i>	Parameter Setting Error	
<i>R10</i>	Overcurrent or Heatsink Overheat or Ground Fault	
<i>R31</i>	Overflow	
<i>R40</i>	Overvoltage	
<i>R51</i>	Feedback Overspeed	Detected at 110% of max speed.
<i>R52</i>	Overspeed Reference Input	Detected at 110% of max speed.
<i>R71</i>	Overload	Momentary overload
<i>R72</i>	Overload	Continuous overload
<i>R80</i>	Encoder Error	Only when absolute encoder is used.
<i>R81</i>	Encoder Backup Alarm	Only when 12-bit absolute encoder is used.
<i>R82</i>	Encoder Checksum Error	Only when 12-bit absolute encoder is used.
<i>R83</i>	Encoder Battery Alarm	Only when 12-bit absolute encoder is used.
<i>R84</i>	Encoder Absolute Error	Only when 12-bit absolute encoder is used.
<i>R85</i>	Encoder Overspeed	Only when 12-bit absolute encoder is used.
<i>RC1</i>	Overrun	
<i>RC2</i>	Phase Detection Error	Only when incremental encoder is used.
<i>RC3</i>	PA-, PB-phase Disconnection of PG Signal Line	
<i>RC4</i>	PC Disconnection of PG Signal Line	
<i>RF3</i>	Momentary Power Loss Alarm	Detected when power is turned ON again during power holding time.
<i>R99</i>	Not Applicable to Alarm Alarm Reset, Power ON	Only for traceback data
<i>CPF00</i>	Digital Operator Transmission Error 1	Digital operator error
<i>CPF01</i>	Digital Operator Transmission Error 2	Not detected as traceback data.

8B. DIGITAL OPERATOR (TYPE : JUSP-OP03A) OPERATION METHOD

8B.1 SWITCH OPERATION

Fig. 8B.1 shows the digital operator. The digital operator has various functions as listed by modes in Par. 8B.2, "DIGITAL OPERATOR FUNCTION".

Notes :

1. The data set by the digital operator is retained in SERVOPACK even after the power is turned OFF.
2. Even if the power is turned OFF after fault occurrence, the fault data is retained in memory. Therefore, it is possible to check the fault data after the power is turned back ON.
3. The monitor mode can be changed even during operations.

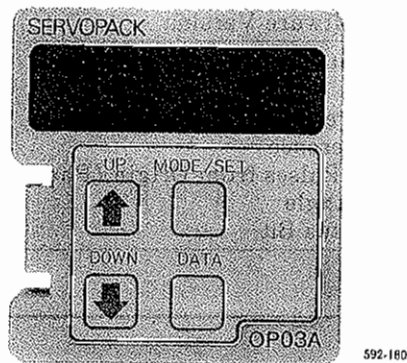
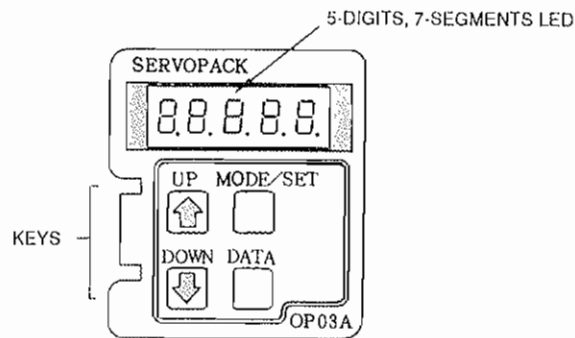


Fig. 8B.1 Digital Operator (Mounted Type)



8B.2 DIGITAL OPERATOR FUNCTIONS


Table 8B.1 shows the digital operator's functions. The status display is the default when control power is turned ON. To change the mode, use  key as shown in Fig. 8B.2.

Table 8B.1 Digital Operator Functions

Mode	Function
Status Indication Mode	Various Status Indications • Base Block • On Operation • Fault (See Par. 8B.3)
Setting Mode	Refer to "User Constant Setting." (See Par. 8B.4.1) • Operation (JOG) from digital operator (See Par. 8B.4.3) • Clearing Fault Traceback Data (See Par. 8B.4.4) • Check of Motor Parameters (See Par. 8B.4.5) • Auto Tuning (See Par. 8B.4.6) • Check of Software Version (See Par. 8B.4.7)
Monitor Mode	Various Monitoring • Speed • Speed Reference • Torque Reference • Number of Pulses from Origin (Phase-U) • Electrical Angle • Interior Status Bit (See Par. 8B.4)
Fault Traceback Indication Mode	Fault History (See Par. 8B.5)

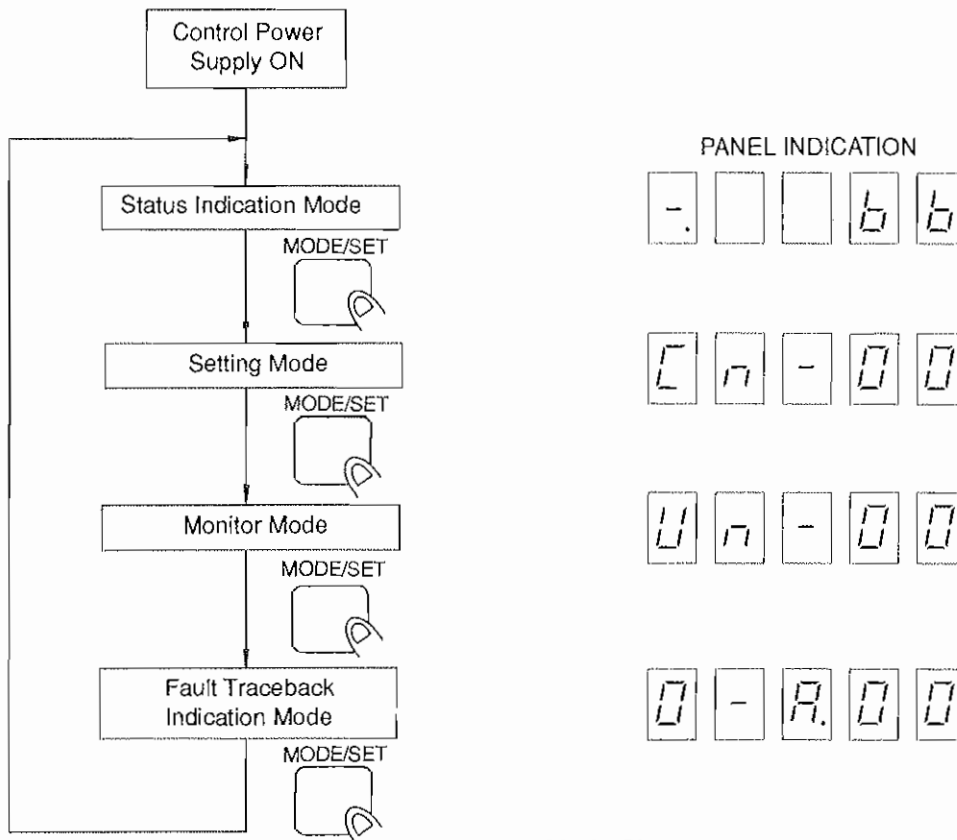
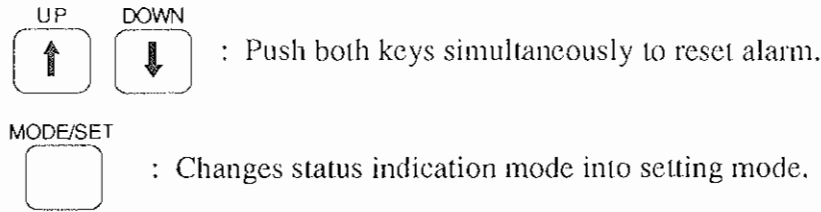


Fig. 8B.2 Mode Changeover

8B.3 STATUS INDICATION MODE

When this mode is selected, the condition of SERVOPACK is indicated with bits and codes as shown in Fig. 8B.3. Table 8B.2 shows the bit data contents. Table 8B.3 shows the codes and conditions.



Panel Display

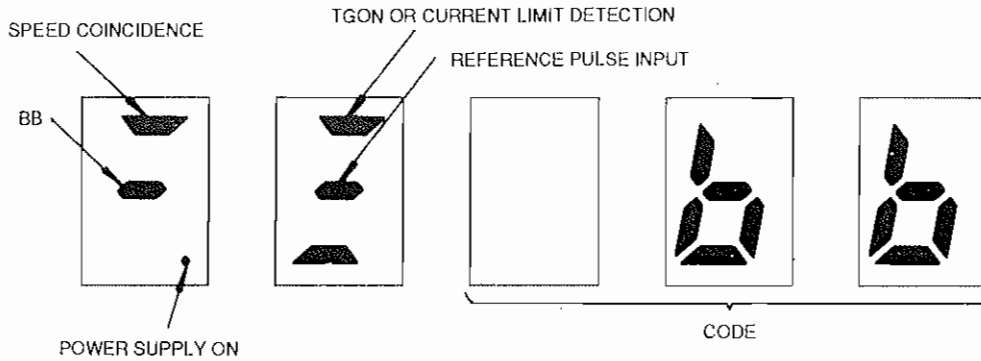


Fig. 8B.3 Status Indication Mode

Table 8B.2 Bit Data Contents

Bit Data	Contents	Remarks
Power Supply ON	Light goes ON with power supply ON.	
BB	Light goes ON with base block, and goes OFF with servo ON.	
Positioning Completion	Light goes ON when positioning is completed.	
TGON	Light goes ON with motor rotating speed higher than TGON level (Standard setting is 20 r/min).	Selected by bit 4 of user constant Cn-01.
Current Limit Detection	Light goes ON when torque reference reaches the torque limit value. (TGON or current limit detection is displayed according to bit 4 of user constant Cn-01.)	
During Reference Pulse Input	Light goes ON during reference pulse input.	

Table 8B.3 Codes and Status

Code	Status
<i>bb</i>	Base Block
<i>run</i>	On Operation
<i>For</i>	Forward Running Prohibited
<i>Rev</i>	Reverse Running Prohibited
<i>ALM</i>	Alarm Status Refer to Table 8B.6.

8B.4 SETTING MODE

In this mode, the following operations can be performed.

- User constant setup and monitor
- Jog operations from the digital operator
- Fault traceback data clearing
- Check of motor parameters
- Auto tuning
- Check of software version

8B.4.1 User Constant (Data) Setup and Monitor (Cn-04 to Cn-23)

Panel Display

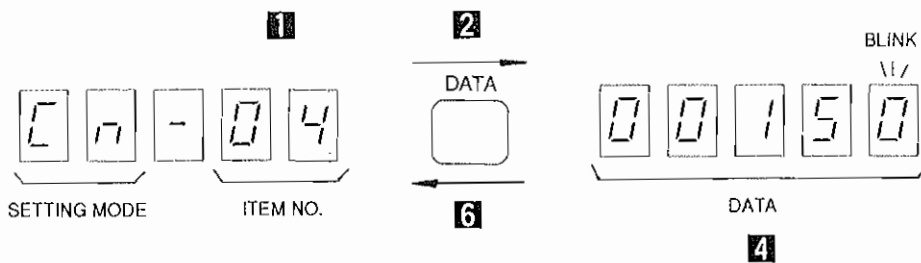







Fig. 8B.4 User Constant Setting

- 1** Set up the item number with the  or  key.

While the key is held down, the numerical value increases or decreases successively by one.

- 2** With the  key, display the data related to the selected item number.

- 3** With the  or  key, set up the data. (The same operation as stated in **1**.)



While the key is held down, the numerical value increases or decreases successively by one.

Holding down the key increases or decreases the number in increments of 10. Keeping the key held down changes the increment unit to 100, 1000 to 10000.

- 4 Retain the data with the key.
- 5 With the key, return to the item No. display status.
- 6 Repeat steps 4 through 5 as needed.
- 7 Using the key, switch from the setting mode to the monitor mode.

For details, see Table 7.3, "User Constants Cn-04 through Cn-23 (Constant Setting) List".

8B.4.2 User Constant (Memory Switch) Setup and Monitor (Cn-01 to Cn-02)

User constants Cn-01 and Cn-02 can be set up or monitored as memory switch bits. The procedures for item number setup and data display are the same as indicated in Par. 8B.4.1  and :

Panel Display

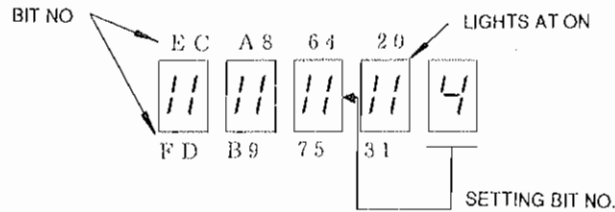


Fig. 8B.5 Bit Data Display









- 1 With the  or  key, enter the setup memory switch bit No. at the far right end of the panel.
- 2 With the  key, set the memory switch to ON or OFF. The panel indication comes on when the switch is ON, and goes off when the switch is OFF.
- 3 Repeat steps  and  as needed.
- 4 Retain the data with the  key.
- 5 With the  key, return to the item No. display status.
- 6 Using the  key, switch from the setting mode to the monitor mode.

Table 7.4 shows memory switches of user constant Cn-01, and Table 7.5 those of user constant Cn-02.

8B.4.3 Digital Operator Jog Operation Mode Selection and Operating Procedure

(1) Digital Operator Jog Operation Mode Selection

When user constant Cn-00 is set to 00, the operations are to be controlled from the digital operator.

Panel Display

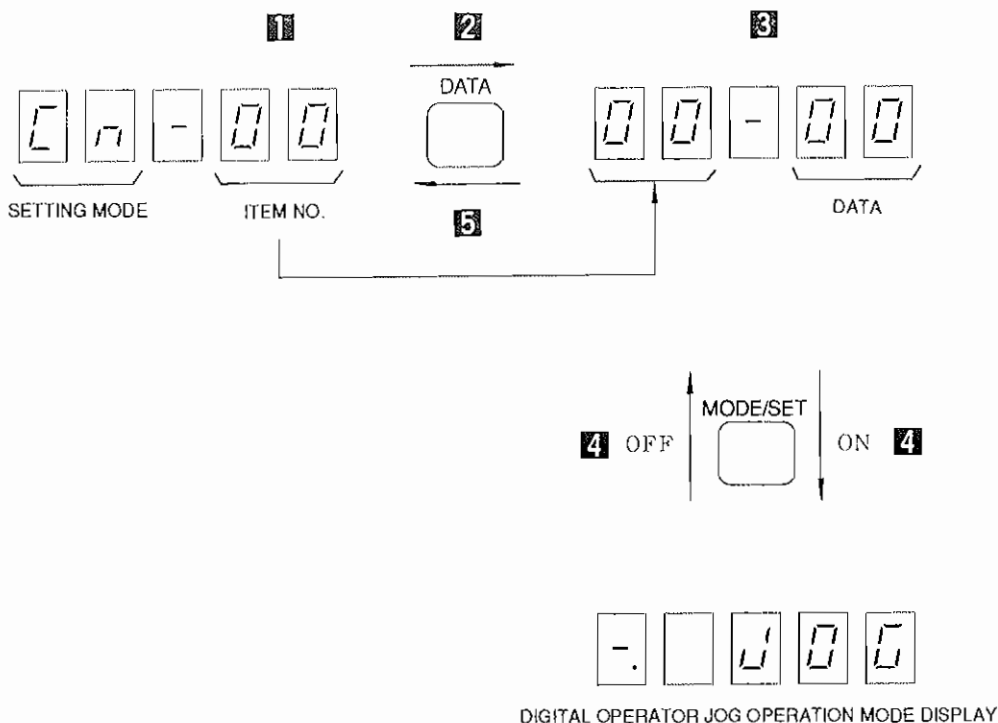













Fig. 8B.6 Digital Operator Jog Operation Mode

- 1** Select the item number 00 with the  or  key.
- 2** With the  key, display the data related to the selected item number.
- 3** With the  or  key, select the number 00.
- 4** With the  key, turn ON or OFF the monitor panel jog operation mode.
- 5** With the  key, return to the item No. display status.
- 6** Using the  key, switch from the setting mode to the monitor mode.

(2) Digital Operator Jog Operation Procedure

For speed reference adjustment, use user constant Cn-10 (see Table 7.3).

- 1 With the  key, effect SVON/SVOFF changeover.
- 2 The motor runs in the forward direction while the  key is held down.
- 3 The motor runs in the reverse direction while the  key is held down.

8B.4.4 Clearing Fault Traceback Data

When user constant Cn-00 is set to 02, fault traceback data are cleared.

Panel Display

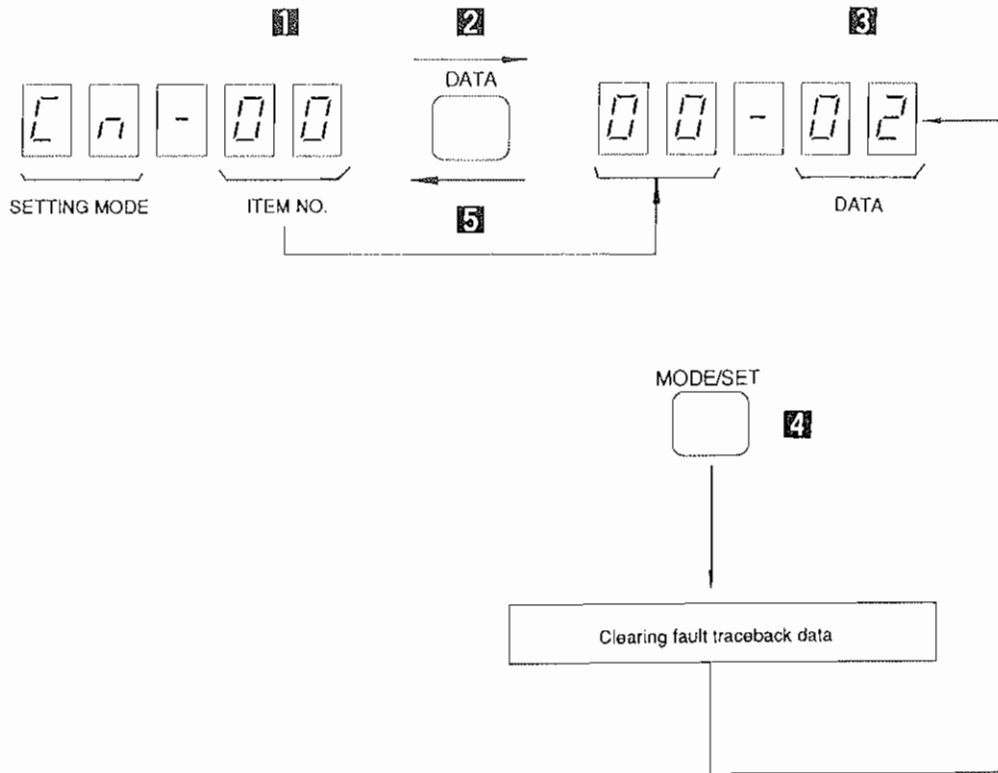


Fig. 8B.7 Clearing Fault Traceback Data

- 1** Select the item number 00 with the or key.
- 2** With the key, display the data related to the selected item number.
- 3** With the or key, select the number 02.
- 4** With the key, clear fault traceback data and return to the user constant Cn-00 data display status.
- 5** With the key, return to the item No. display status.
- 6** Using the key, switch from the setting mode to the monitor mode.

8B.4.5 Check of Motor Parameters

(1) Check Method of Motor Parameters

When user constant Cn-00 is set to 04, the system enters the motor parameter check mode.

Panel Display

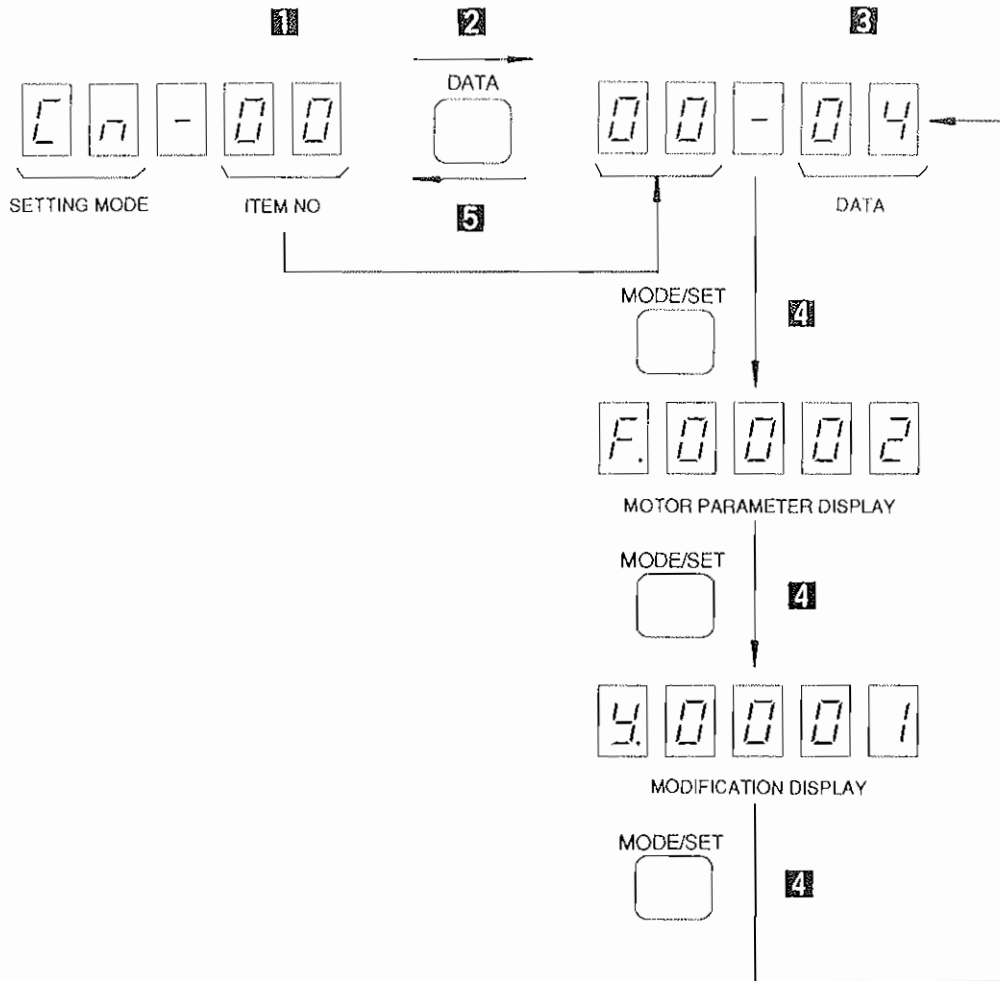










Fig. 8B.8 Switch Functions in Motor Parameter Check

- 1 Set up item number 00 with the  or  key.
- 2 With the  key, display the data related to the selected item number.
- 3 With the  or  key, select the number 04.

4 With the  key, check the motor parameter.

5 With the  key, return to the item No. display status.

6 Using the  key, switch from the setting mode to the monitor mode.

(2) Parameter Display

· Motor Parameter



Motor Capacity

- 9E : 30W (0.04HP)
- b2 : 50 W (0.07HP)
- 01 : 100 W (0.13HP)
- 02 : 200 W (0.27HP)
- 04 : 400 W (0.53HP)
- 08 : 750 W (1.01HP)

Motor Type

- 0 : Σ Series, 200 V
- 1 : Σ Series, 100 V

· Modification Number



Modification No. (Hexadecimal display)

$$(a \times 16^3 + b \times 16^2 + c \times 16 + d) = \text{Modification No.}$$

Nos. Corresponding to Alphabets

- A = 10
- b = 11
- C = 12
- d = 13
- E = 14
- F = 15

8B.4.6 Auto Tuning

(1) Mode Setting in Auto Tuning

When user constant Cn-00 is set to 05, the system enters the auto tuning mode.

Panel Display

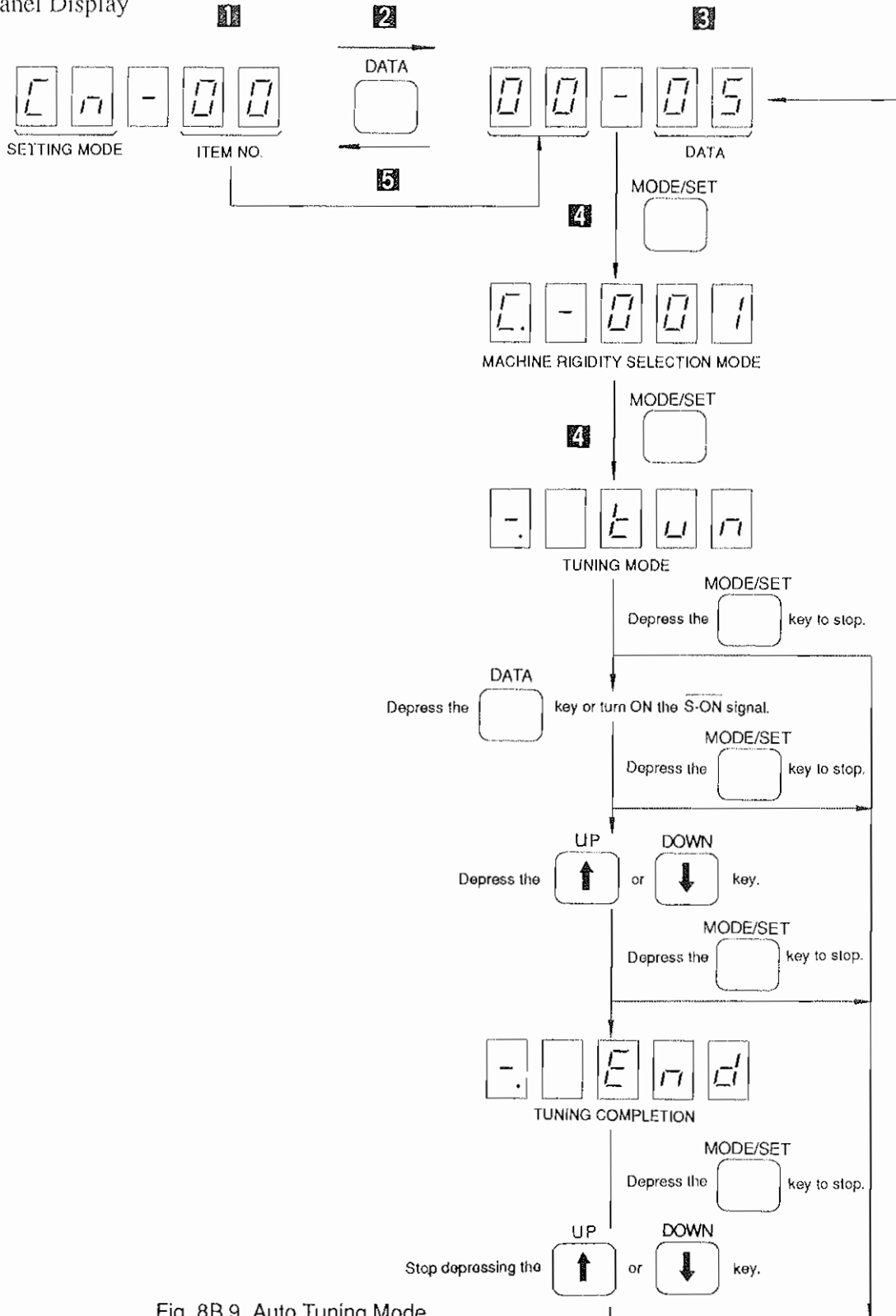










Fig. 8B.9 Auto Tuning Mode



- 1 Set up item number 00 with the  or  key.
- 2 With the  key, display the data related to the selected item number.
- 3 With the  or  key, select the number 05.
- 4 With the  key, switch to the machine rigidity selection mode or tuning mode.
- 5 With the  key, return to the item No. display status.
- 6 Using the  key, switch from the setting mode to the monitor mode.

(2) Tuning Method

(a) Speed setting

When tuning is being performed, the maximum value of speed reference is set by user constant Cn-10.


Set the value to approximately 500 r/min. (If the value is too small, auto tuning cannot be performed properly.)


The motor runs intermittently when the  or  key is held down. (The motor does not run at the same speed continuously.)

(b) Machine rigidity selection

According to the machine rigidity, select the following :


 : Low response




 : Medium response


 : High response

When the machine rigidity is not defined, select the middle-speed response.


· Machine vibration


When entering the servo ON status with the  switch or machine vibrates

suddenly at depressing the  or  key, depress the  key and interrupt the tuning operation.


Then depress the  key to enter the machine rigidity selection mode and set the level of machine rigidity selection at one level lower.


· When tuning is not completed.


When tuning is not completed even though machine does not vibrate, depress the  key to interrupt the tuning operation.





Then depress the  key to enter the machine rigidity selection mode and set the level of machine rigidity selection at one level higher.


(c) Tuning



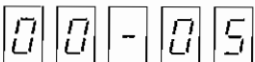
1 With the  switch, effect SVON/SVOFF changeover.

2 The motor runs in the forward direction while the  key is held down.

3 The motor runs in the reverse direction while the  key is held down.

Note : If the machine vibrates when depressing the  or  key, stop depressing the  or  key since the gain is decreased.

4 With the tuning completion,  is displayed and power supply to the motor is stopped.

Stop depressing the  or  key. Display is returned to .

(d) Input signals

• In the auto tuning mode, OT signal is effective.

Make sure to input OT signal.

When absolute encoder is used, SEN signal is also effective and should be input.

When these signals are not used, set the bits of 1, 2 and 3 of user constant Cn-01 to 1 respectively.

• During overtravel (OT signal is OFF), auto tuning cannot be performed.

Perform auto tuning when the driven part of the machine is not in the overtravel position.

• When performing auto tuning, make sure to keep the $\overline{\text{P-CON}}$ signal OFF (PI control status).

• When $\overline{\text{S-ON}}$ signal is used, display the  and turn ON the signal.

8B.4.7 Check of Software Version

(1) Mode Setting in Software Version Check

When user constant Cn-00 is set to 06, the system enters the software version check mode.

Panel Display

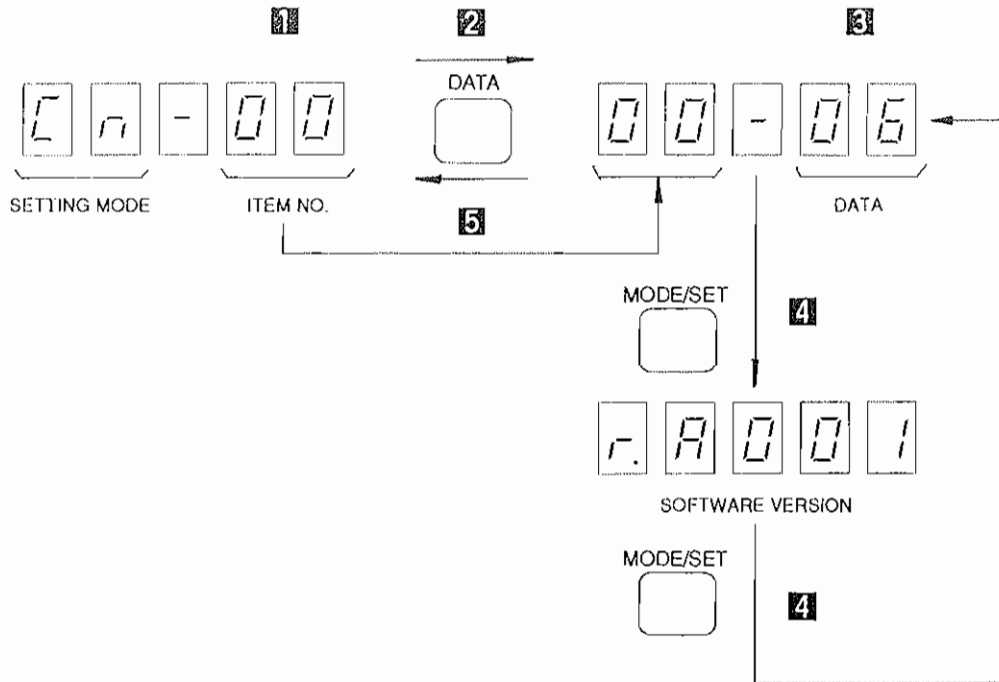








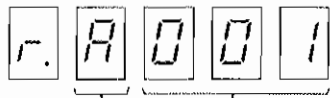


Fig. 8B.10 Software Version Check Mode

- 1** Set up item number 00 with the  or  key.
- 2** With the  key, display the data related to the selected item number.
- 3** With the  or  key, select the number 06.
- 4** With the  key, display the software version.
- 5** With the  key, return to the item No. display status.
- 6** Using the  key, switch from the setting mode to the monitor mode.

(2) Software Version Display



Software Version No.

Type

A : Speed control

d : Positioning control

8B.5 MONITOR MODE

In this mode, the speed reference, torque reference, and other data can be monitored on the digital operator.

Table 8B.4 lists the data that can be monitored.

Table 8B.4 Data Monitored

Monitor No.	Data Monitored
00	Feedback Speed (r/min)
02	Torque Reference (%)
03	No. of Pulses from Phase-U edge
04	Electrical Angle (deg)
05	Internal Status Bit Display 1 (Refer to Table 8B.5)
06	Internal Status Bit Display 2 (Refer to Table 8B.5)
07	Reference Pulse Speed Display (r/min)
08	Position Error (Reference unit)

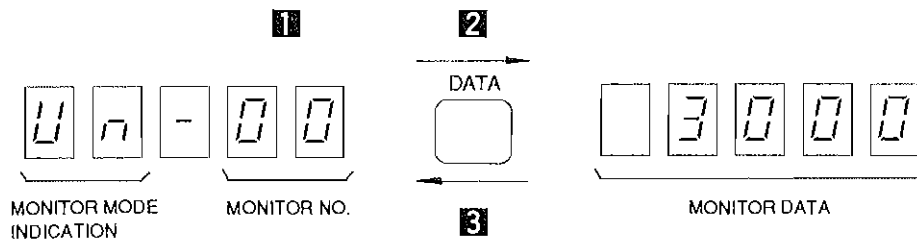


Fig. 8A.11 Switch Functions in Monitor Mode






- 1** With the  or  key, select a desired monitor No.
- 2** With the  key, initiate monitor display.
- 3** Using the  key, return to the monitor No. selection status.
- 4** With the  key, switch from the monitor mode to the fault traceback mode.

Table 8B.5 Bit Indication of Monitor Mode Un-05, Un-06 Internal Status

Bit No.	Symbol	Contents	Remarks	
①	SVALM	Turns ON at servo alarm		
②	DBON	Turns ON at dynamic braking		
③	DIR	Turns ON in reverse run mode		
④	TGON	Turns ON at motor running (Motor speed is TGON level or higher)	Select by setting of bit 4 of user constant Cn-01.	
	CLT	Turns ON during current limit		
⑤	COIN	Turns ON at positioning completion		
⑥	MSON	Turns ON at mode switch ON		
⑦	P-CL	Turns ON during forward current limit		
⑧	N-CL	Turns ON during reverse current limit		
⑨	B-ON	Motor under present condition		
Un-05	⑩	PA	Phase-A Phase-B Phase-C Phase-U Phase-V Phase-W Servo ON Turns OFF when each of input signal is at high level.	Incremental encoder only
	⑪	PB		
	⑫	PC		
	⑬	PU		
	⑭	PV		
	⑮	PW		
	⑯	SVON		
⑰	P-CON	Turns ON during P operation input	Select by setting of bit A or B of user constant Cn-01 or bit 2 of user constant Cn-02.	
	DR	Rotating direction input by external setting speed (ON at reverse, OFF at forward)		
⑱	P-OT	Turns ON at forward running prohibit input status		
⑲	N-OT	Turns ON at reverse running prohibit input status		
⑳	—	—	—	
Un-06	①	PUL	Reference pulse input	
	②	SIGN	Sign input	
	③	CLR	Error counter clear input	
	④ to ⑳	—	—	—

8B.6 FAULT TRACEBACK MODE

In this mode, information on past fault occurrences can be displayed.

- Information on up to 10 past fault occurrences can be stored.
- When a fault is reset or the control power is turned ON, traceback data A. 99 is saved. (These data are also counted as one of a total of 10 stored items of fault information.)
- For the relationship between traceback data and fault descriptions, refer to Table 8B.6.

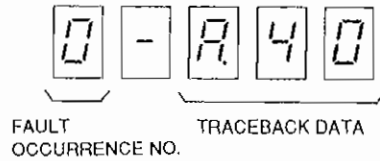




Fig. 8B.12 Fault Traceback Mode

- 1 With the  or  key, increase or decrease the fault occurrence number.

The fault information related to the selected number is then displayed. (The higher the fault occurrence number, the older the fault occurrence).


- 2 With the  key, switch from the fault traceback mode to the status display mode.

Table 8B.6 Error Displays with Digital Operator and Traceback Data

Digital Operator (Traceback Data)	Detection	Remarks
A00	Absolute Encoder Data Error	Only when absolute encoder is used.
A02	Parameter Breakdown	
A04	Parameter Setting Error	
A.10	Overcurrent or Heatsink Overheat or Ground Fault	
A31	Overflow	
A40	Overvoltage	
A51	Feedback Overspeed	Detected at 110% of max speed.
A52	Overspeed Reference Input	Detected at 110% of max speed.
A71	Overload	Momentary overload
A72	Overload	Continuous overload
A80	Encoder Error	Only when absolute encoder is used.
A81	Encoder Backup Alarm	Only when 12-bit absolute encoder is used.
A82	Encoder Checksum Error	Only when 12-bit absolute encoder is used.
A83	Encoder Battery Alarm	Only when 12-bit absolute encoder is used.
A84	Encoder Absolute Error	Only when 12-bit absolute encoder is used.
A85	Encoder Overspeed	Only when 12-bit absolute encoder is used.
AL1	Overrun	
AL2	Phase Detection Error	Only when incremental encoder is used.
AL3	PA-, PB-phase Disconnection of PG Signal Line	
AL4	PC Disconnection of PG signal Line	
AF3	Momentary Power Loss Alarm	Detected when power is turned ON again during power holding time.
A99	Not Applicable to Alarm Alarm Reset, Power ON	Only for traceback data
CPF00	Digital Operator Transmission Error 1	Digital operator error
CPF01	Digital Operator Transmission Error 2	Not detected as traceback data.

9. INSTALLATION AND WIRING

9.1 RECEIVING

This motor has been put through stringent tests at the factory before shipment. After unpacking, however, check for the following.

- Its nameplate ratings meet your requirements.
- It has sustained no damage while in transit.
- The output shaft can be hand-rotated freely. However, motors with holding brake do not rotate.
- Fastening bolts and screws are not loose.

If any part of the motor is damaged or lost, immediately contact your YASKAWA representative giving full details and nameplate data.

9.2 INSTALLATION

9.2.1 SGM SERVOMOTOR

AC SERVOMOTOR can be installed either horizontally or vertically.

(1) Before Mounting

Wash off anticorrosive paint on shaft extension and flange surface with thinner before connecting the motor to the driven machine. Do not subject other parts of the motor to thinner.

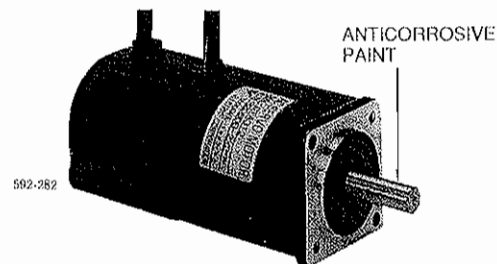


Fig. 9.1 Anticorrosive Paint to be Removed

(2) Location

Use the motor under the following conditions.

- Indoors
- Free from corrosive and/or explosive gases or liquids
- Ambient temperature : 0 to +40°C
- Accessible for inspection maintenance and cleaning

If the AC SERVOMOTOR is subject to excessive water or oil droplets, protect the motor with a cover.

(3) Environmental Conditions

- Ambient Temperature : 0 to +40°C
- Storage Temperature : -20 to +60°C
- Humidity : 20 to 80%RH (non-condensing)

(4) Load Coupling

True alignment of motor and driven machine is essential to prevent vibration, reduced bearing and coupling life, or shaft and bearing failures.

Use flexible couplings for direct drives. Alignment should be made in accordance with Fig. 9.2.

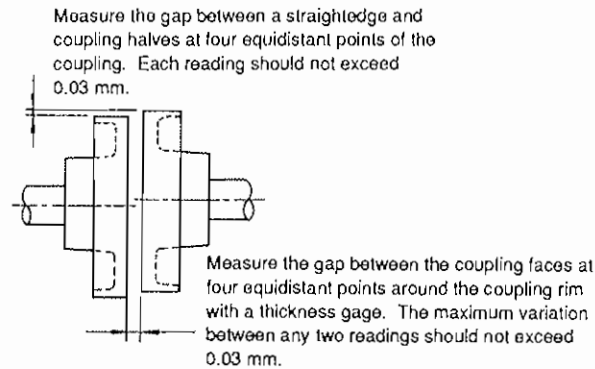


Fig. 9.2 Alignment of Coupling

(5) Allowable Bearing Load

Avoid shock to the motor shaft when mounting gear box, coupling or pulley (50 G or less). Don't exceed thrust and radial loads specified in Table 4.1.

9.2.2 SGD SERVOPACK

(1) Installation

SGD SERVOPACK (type SGD-) is a base-mounted type.

(2) Location

- When installed in a panel :
Keep the ambient temperature around SGD SERVOPACK at 55°C or below.
- When installed near a heat source :
Keep the ambient temperature around SGD SERVOPACK below 55°C.
- If subjected to vibration :
Mount the unit on shock absorbing material.
- If corrosive gases are present :
Avoid locations where corrosive gases exist since it may cause extensive damage over long use. Contactors and replays are especially vulnerable.

(3) Mounting Direction

Mount the unit vertically on the wall using the mounting holes on the base plate, with main terminals at the bottom. (Fig. 9.3)

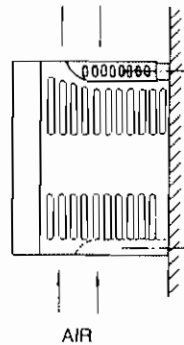


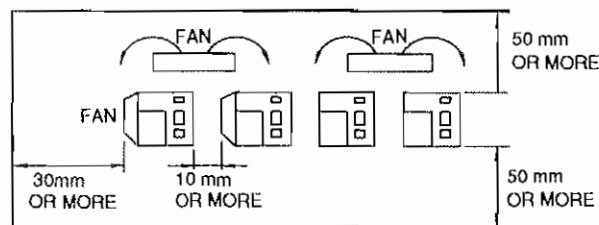
Fig. 9.3 Mounting of SGD SERVOPACK

· Location

Ambient Temperature	0 to 55°C (above freezing)*
Humidity	90% RH (non-condensing)
Vibration	0.5G (4.9 m/s ²) or below

· Precautions for mounting

- (1) Mount the unit vertically on a wall using the mounting holes on the base plate, with main terminals at the bottom.
- (2) Make sure to mount the unit keeping enough surrounding space since cooling method of SERVOPACK is free convection type.
- (3) If SERVOPACKS are mounted side by side, temperature may rise somewhat because of the uneven temperature inside the panels. Therefore, provide a fan/fans above the SERVOPACK blowing down on the units.



9.3 WIRING

9.3.1 Rated Current and Cable Size

Tables 9.1 and 9.2 show external terminals, rated current, and cable sizes of the power unit and SERVOPACK, respectively. Select the type and size of cables to meet ambient conditions and current capacity. The cable size is calculated so that a bundle of three cables can carry the rated current at an ambient temperature of 40°C. Table 9.3 lists the type of cables.

Table 9.1 Rated Current


External Terminal		Symbol	Rated Current A (rms) (Effective Current)									
			200 V AC						100 V AC			
			SGD-A3AP	SGD-A5AP	SGD-01AP	SGD-02AP	SGD-04AP	SGD-08AP	SGD-A3BP	SGD-A5BP	SGD-01BP	SGD-02BP
On Line	Main Circuit Power Input	Ⓡ Ⓣ	1.3	1.5	2.5	4.0	6.0	11.0	2.0	2.6	4.5	8.0
	Motor Connection	Ⓢ Ⓥ Ⓦ	0.42	0.6	0.87	2.0	2.6	5.5	0.63	0.7	2.2	2.7
Off Line	Control I/O Signal Connector	1CN	100 mA DC max									
	PG Signal Connector	2CN	100 mA DC max (500 mA for power line only)									
	Ground		—									

Table 9.2 Recommended Cable Size of SERVOPACK

External Terminal	Symbol	Cable Size mm ²										
		200 V AC					100 V AC					
		SGD-A3AP	SGD-A5AP	SGD-01AP	SGD-02AP	SGD-04AP	SGD-08AP	SGD-A3BP	SGD-A5BP	SGD-01BP	SGD-02BP	
On Line	Main Circuit Power Input	Ⓜ Ⓣ		HIV 1.25 or more			HIV 2.0		HIV 1.25 or more		HIV 2.0 or more	
	Motor Connection	Ⓢ Ⓥ Ⓦ Ⓧ		Use cables provided by YASKAWA. For details, see Par. 10.5, "CABLES." If other cables are used, confirm your rated current and select a twisted cable within a range of AWG22 to AWG18 (0.3 to 0.89 mm ²).								
Off Line	Control I/O Signal Connector	1CN	Cable	Two-core twisted shielded cable								
			Applicable Cable	AWG 24, 28, 30								
			Finished Cable Dimension	φ 16.0 mm max.								
	PG Signal Connector	2CN	Cable	Use cables provided by YASKAWA. For details, see Par. 10.5, "CABLES." If other cables are used, use a two-core twisted shielded cable.								
			Applicable Cable	AWG 24, 26, 28, 30 For power supply (for encoder) and FG line, apply AWG 22 (0.32 mm ²). For other signals, apply AWG 26 (0.12 mm ²). By connecting above, cables, wiring distance can be extended to 20 m.								
			Finished Cable Dimension	φ 11.6 mm max.								

Table 9.3 Cable

Type of Lead	Allowable Conductor Temperature (°C)
Vinyl Cable (PVC)	—
600 V Vinyl Cable (IV)	60
Special Heat-Resistant Cable (HIV)	75

Notes :

1. For main circuits, use cables of 600 V or more.
2. Where cables are bundled or run in a duct (unplasticized polyvinyl chloride conduit or metallic conduit), select a cable size larger than listed considering the current drop rate of the cables.
3. Where the ambient (panel interior) temperature is high (40°C to 60°C), use heat-resistant cables.

9.3.2 Wiring Precautions

SERVOPACK is a device for speed control of 5000 : 1, and signal level of several milli-volts or less. The following precautions should be taken when wiring.

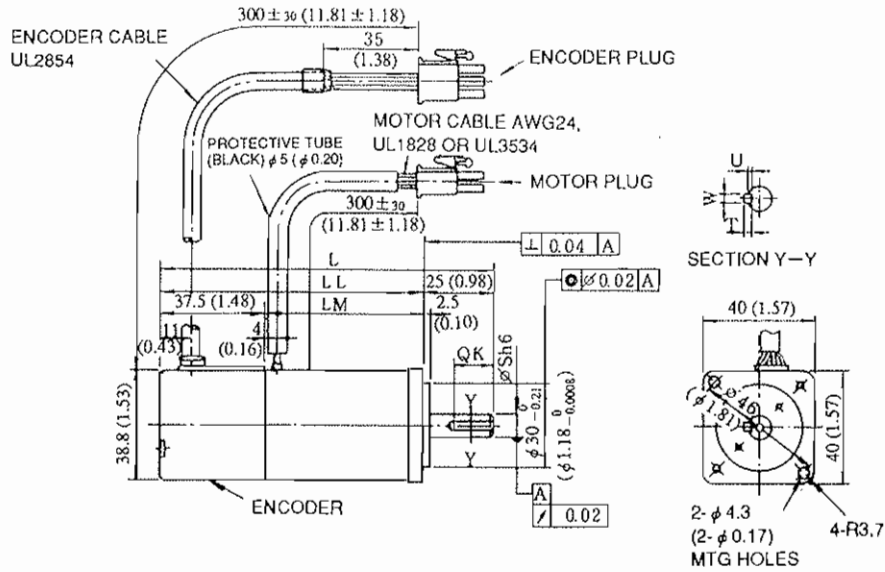
- (1) For signal lines and PG feedback lines, use twisted cables or multi-core shielded twisted-pair cables (Yaskawa Drawing No. B9400064 or DE8400093). Cable length is a maximum of 3 m for reference input lines and a maximum of 20 m for PG feedback lines. Use the shortest possible length.
- (2) For ground line, cable should be as heavy as possible to provide Class 3 ground (ground resistance 100 Ω or less). Use central grounding point. If the motor and machine are insulated, ground the motor.
- (3) To prevent malfunction due to noise, take the following precautions :
 - Place noise filters, SGD SERVOPACK and I/O reference as near as possible to each other.
 - Make sure to insert a surge suppressing circuit into the relay, electromagnetic contact, and solenoid coils.
 - Run the power line and signal line, keeping the distance to 30 cm or more ; do not run them in the same duct or in a bundle.
 - When the same power is used for SERVOPACK as for an electric welder or electrical discharge machine or when a high-frequency noise source is present in the vicinity, use filters in the power and input circuits.
 - The SERVOPACK uses a switching amplifier, and electrical noise may be present in the signal line.
- (4) Remedy for Radio Frequency Interference (R.F.I)
SGD SERVOPACK may interfere with radio reception. If the controller interferes with radio reception, connect a noise filter to the power supply.
- (5) The signal line uses cables whose cores is extremely fine (0.2 to 0.3 mm²). Avoid using excessive force which may damage these cables.

10. OUTSIDE DIMENSIONS in mm (inches)

10.1 SGM SERVOMOTOR

(1) With Incremental Encoder, without Brake

·30 W (0.04 HP), 50 W (0.07 HP), 100 W (0.13 HP)



Type SGM-	L	LL	LM	S	QK	U	W	T	Output W (HP)	Mass g (lb)	Allowable Radial load N (lb)	Allowable Thrust Load N (lb)
A3A312	94.5 (3.72)	69.5 (2.74)	32.0 (1.26)	6 (0.24)	Without key				30 (0.04)	300 (0.66)	49 (11)	19 (4)
A3B312					14 (0.55)	1.2 (0.05)	2 (0.08)	2 (0.08)				
A3A314												
A5A312	102.0 (4.02)	77.0 (3.03)	39.5 (1.56)	6 (0.24)	Without key				50 (0.07)	400 (0.88)	68 (15)	19 (4)
A5B312					14 (0.55)	1.2 (0.05)	2 (0.08)	2 (0.08)				
A5A314												
01A312	119.5 (4.70)	94.5 (3.72)	57.0 (2.24)	8 (0.31)	Without key				100 (0.13)	500 (1.10)	68 (15)	19 (4)
01B312					14 (0.55)	1.8 (0.07)	3 (0.12)	3 (0.12)				
01A314												
01B314												

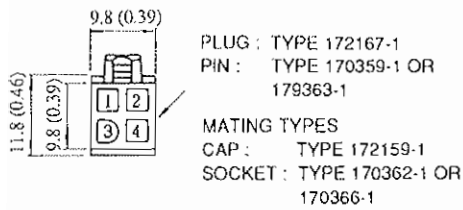
Notes :

1. Detector uses incremental encoder 2048 P/R.

2. As for type designation, "A" shows that SERVOMOTOR applies 200 VAC power and "B" shows that SERVOMOTOR applies 100 VAC power.

Connector specifications

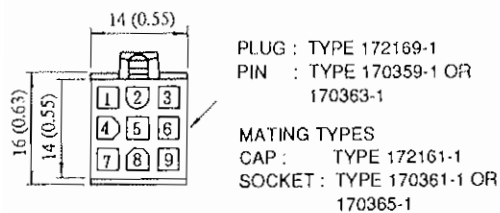
Ⓐ Motor plug



• Motor connection

1	Phase-U	Red
2	Phase-V	White
3	Phase-W	Blue
4	FG (Frame ground)	Green

Ⓑ Encoder plug

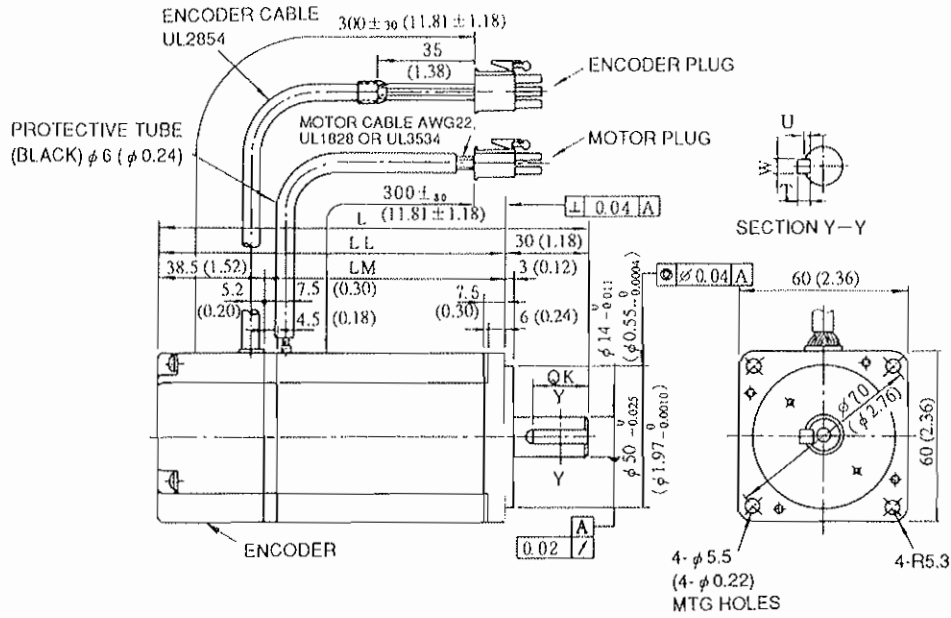


• Incremental encoder connection

1	Channel A output	Blue
2	Channel A output	Blue/Black
3	Channel B output	Yellow
4	Channel B output	Yellow/Black
5	Channel C output	Green
6	Channel C output	Green/Black
7	0V (Power supply)	Gray
8	+5V (Power supply)	Red
9	FG (Frame ground)	Orange

Manufacturer of connector : Amp.

· 200 W (0.27 HP), 400 W (0.53 HP)



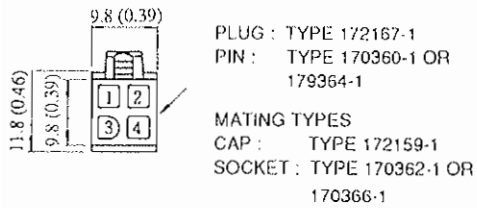
Type SGM-	L	LL	LM	QK	U	W	T	Output W (HP)	Mass g (lb)	Allowable Radial Load N (lb)	Allowable Thrust Load N (lb)
02A312	126.5 (4.98)	96.5 (3.80)	58.0 (2.28)	Without key				200 (0.27)	1100 (2.43)	196 (44)	49 (11)
02B312				20 (0.79)	3 (0.12)	5 (0.20)	5 (0.20)				
02A314	154.5 (6.08)	124.5 (4.90)	86.0 (3.39)	Without key				400 (0.53)	1700 (3.75)	196 (44)	68 (15)
02B314				20 (0.79)	3 (0.12)	5 (0.20)	5 (0.20)				

Notes :

1. Detector uses incremental encoder 2048 P/R.
2. As for type designation, "A" shows that SERVOMOTOR applies 200 VAC power and "B" shows that SERVOMOTOR applies 100 VAC power.

Connector specifications

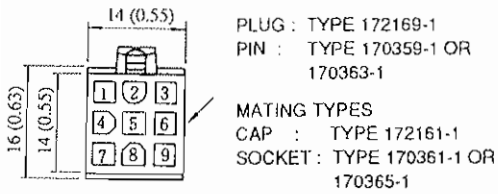
A Motor plug



• Motor connection

1	Phase-U	Red
2	Phase-V	White
3	Phase-W	Blue
4	FG (Frame ground)	Green

B Encoder plug

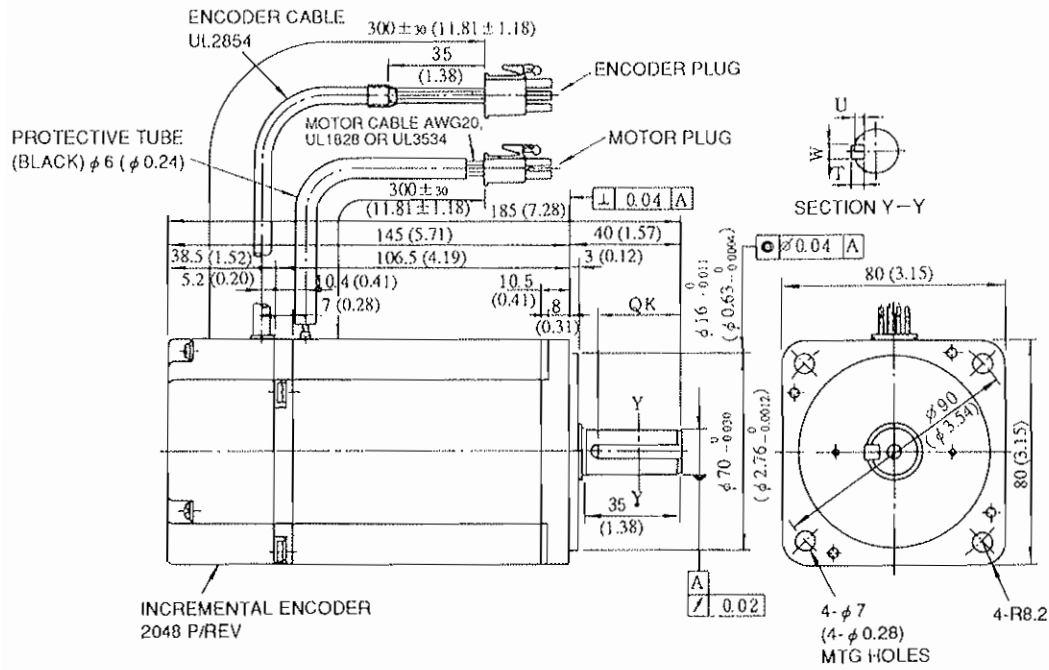


• Incremental encoder connection

1	Channel A output	Blue
2	Channel A output	Blue/Black
3	Channel B output	Yellow
4	Channel B output	Yellow/Black
5	Channel C output	Green
6	Channel C output	Green/Black
7	0V (Power supply)	Gray
8	+5V (Power supply)	Red
9	FG (Frame ground)	Orange

Manufacturer of connector : Amp.

· 750 W (1.01 HP)



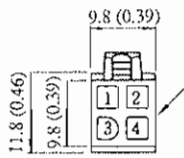
Type SGM-	QK	U	W	T	Output W (HP)	Mass g (lb)	Allowable Radial Load N (lb)	Allowable Thrust Load N (lb)
08A312	Without key				750 (1.01)	3400 (7.50)	343 (77)	98 (22)
08A314	30 (1.18)	3 (0.12)	5 (0.20)	5 (0.20)				

Notes :

1. Detector uses incremental encoder 2048 P/R.
2. As for type designation, "A" shows that SERVOPACK applies 200 VAC power.

Connector specifications

Ⓐ Motor plug



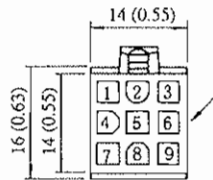
PLUG : TYPE 172167-1
PIN : TYPE 170360-1 OR
179364-1

MATING TYPES
CAP : TYPE 172159-1
SOCKET : TYPE 170362-1 OR
170366-1

· Motor connection

1	Phase-U	Red
2	Phase-V	White
3	Phase-W	Blue
4	FG (Frame ground)	Green

Ⓑ Encoder plug



PLUG : TYPE 172169-1
PIN : TYPE 170359-1 OR
170363-1

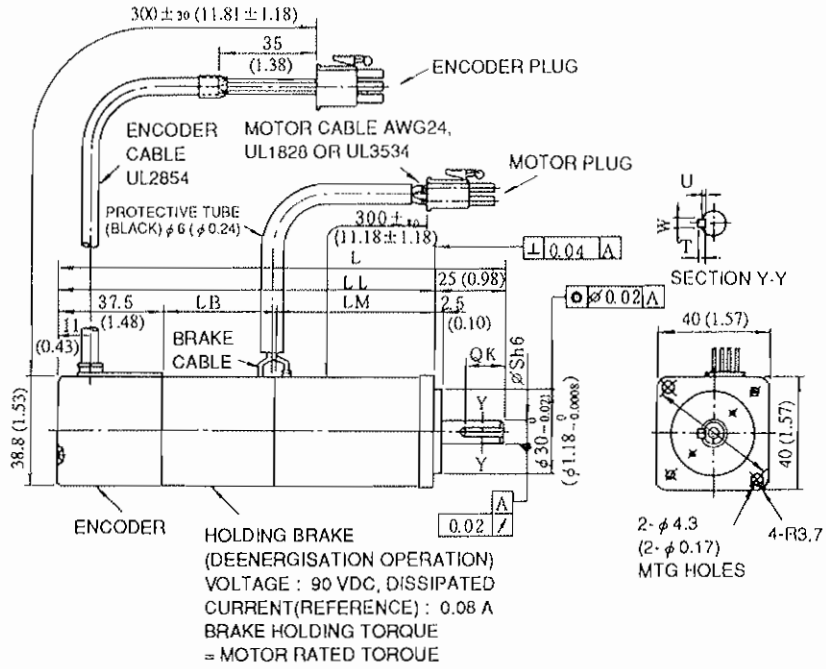
MATING TYPES
CAP : TYPE 172161-1
SOCKET : TYPE 170361-1 OR
170365-1

· Incremental encoder connection

1	Channel A output	Blue
2	Channel A output	Blue/Black
3	Channel B output	Yellow
4	Channel B output	Yellow/Black
5	Channel C output	Green
6	Channel C output	Green/Black
7	0V (Power supply)	Gray
8	+5V (Power supply)	Red
9	FG (Frame ground)	Orange

Manufacturer of connector : Amp.

- (2) With Incremental Encoder, with Brake
 ·30 W (0.04 HP), 50 W (0.07HP), 100 W (0.13 HP)



Type SGM-	L	LL	LM	LB	S	QK	U	W	T	Output W (HP)	Mass g (lb)	Allowable Radial Load N (lb)	Allowable Thrust Load N (lb)
A3A312B						Without key				30 (0.04)	600 (1.32)	49 (11)	19 (4)
A3B312B	126.0 (4.96)	101.0 (3.98)	32.0 (1.26)	31.5 (1.24)	6 (0.24)	14 (0.55)	1.2 (0.05)	2 (0.08)	2 (0.08)				
A3A314B						Without key				50 (0.07)	700 (1.54)	68 (15)	19 (4)
A3B314B						14 (0.55)	1.2 (0.05)	2 (0.08)	2 (0.08)				
A5A312B						Without key				100 (0.13)	800 (1.76)	68 (15)	19 (4)
A5B312B	133.5 (5.26)	108.5 (4.27)	39.5 (1.56)	31.5 (1.24)	6 (0.24)	14 (0.55)	1.2 (0.05)	2 (0.08)	2 (0.08)				
A5A314B						Without key				100 (0.13)	800 (1.76)	68 (15)	19 (4)
A5B314B						14 (0.55)	1.8 (0.07)	3 (0.12)	3 (0.12)				
01A312B						Without key				100 (0.13)	800 (1.76)	68 (15)	19 (4)
01B312B	160.0 (6.30)	135.0 (5.31)	57.0 (2.24)	40.5 (1.59)	8 (0.31)	14 (0.55)	1.8 (0.07)	3 (0.12)	3 (0.12)				
01A314B						Without key				100 (0.13)	800 (1.76)	68 (15)	19 (4)
01B314B						14 (0.55)	1.8 (0.07)	3 (0.12)	3 (0.12)				

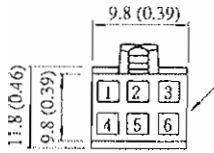
Notes :

1. Detector uses incremental encoder 2048 P/R.

2. As for type designation, "A" shows that SERVOMOTOR applies 200 VAC power and "B" shows that SERVOMOTOR applies 100 VAC power.

Connector specifications

(A) Motor plug

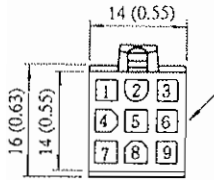


PLUG : TYPE 172168-1
 PIN : TYPE 170359-1 OR
 179363-1
 MATING TYPES
 CAP : TYPE 172160-1
 SOCKET : TYPE 170362-1 OR
 170366-1

· Motor and brake connection

1	Phase-U	Red
2	Phase-V	White
3	Phase-W	Blue
4	FG (Frame ground)	Green
5	Brake terminal	Red
6	Brake terminal	Black

(B) Encoder plug



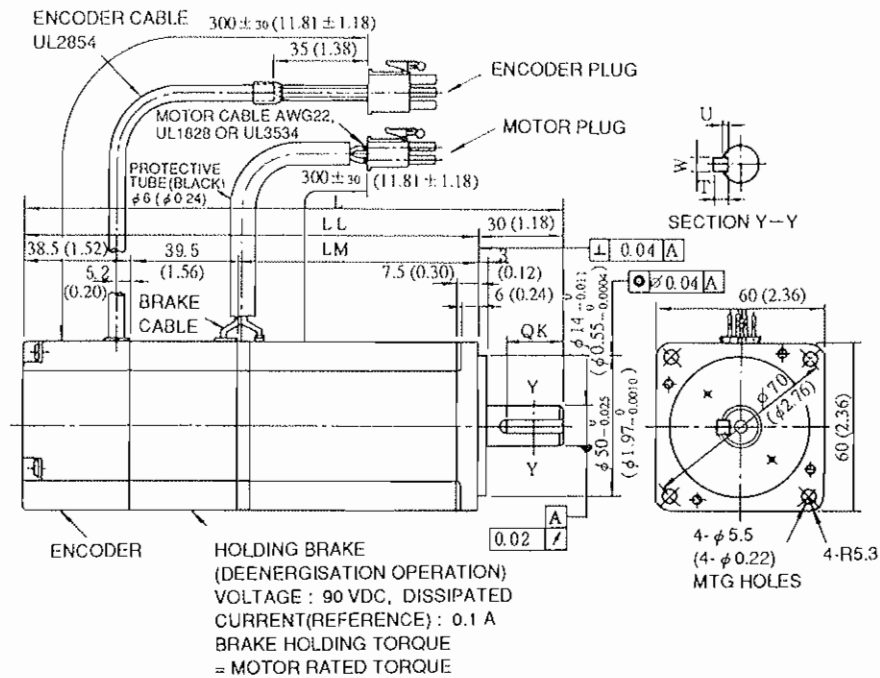
PLUG : TYPE 172169-1
 PIN : TYPE 170359-1 OR
 170363-1
 MATING TYPES
 CAP : TYPE 172161-1
 SOCKET : TYPE 170361-1 OR
 170365-1

· Incremental encoder connection

1	Channel A output	Blue
2	Channel A output	Blue/Black
3	Channel B output	Yellow
4	Channel B output	Yellow/Black
5	Channel C output	Green
6	Channel C output	Green/Black
7	0V (Power supply)	Gray
8	+5V (Power supply)	Red
9	FG (Frame ground)	Orange

Manufacturer of connector : Amp.

· 200 W (0.27 HP), 400 W (0.53HP)



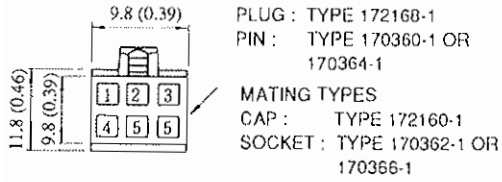
Type SGM-	L	LL	LM	QK	U	W	T	Output W (HP)	Mass g (lb)	Allowable Radial Load N (lb)	Allowable Thrust Load N (lb)
02A312B				Without key				200 (0.27)	1600 (3.53)	196 (44)	49 (11)
02B312B	166.0 (6.54)	136.0 (5.35)	58.0 (2.28)	20 (0.79)	3 (0.12)	5 (0.20)	5 (0.20)				
02A314B				Without key				400 (0.53)	2200 (4.85)	196 (44)	68 (15)
02B314B	194.0 (7.64)	164.0 (6.46)	86.0 (3.39)	20 (0.79)	3 (0.12)	5 (0.20)	5 (0.20)				

Notes :

1. Detector uses incremental encoder 2048 P/R.
2. As for type designation, "A" shows that SERVOMOTOR applies 200 VAC power and "B" shows that SERVOMOTOR applies 100 VAC power.

Connector specifications

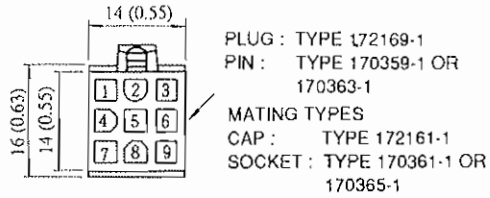
Ⓐ Motor plug



· Motor and brake connection

1	Phase-U	Red
2	Phase-V	White
3	Phase-W	Blue
4	FG (Frame ground)	Green
5	Brake terminal	Red
6	Brake terminal	Black

Ⓑ Encoder plug



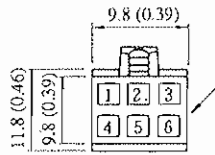
· Incremental encoder connection

1	Channel A output	Blue
2	Channel A output	Blue/Black
3	Channel B output	Yellow
4	Channel B output	Yellow/Black
5	Channel C output	Green
6	Channel C output	Green/Black
7	0V (Power supply)	Gray
8	+5V (Power supply)	Red
9	FG (Frame ground)	Orange

Manufacturer of connector : Amp.

Connector specifications

Ⓐ Motor plug

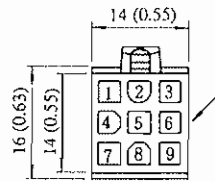


PLUG : TYPE 172168-1
 PIN : TYPE 170360-1 OR
 170364-1
 MATING TYPES
 CAP : TYPE 172160-1
 SOCKET : TYPE 170362-1 OR
 170366-1

• Motor and brake connection

1	Phase-U	Red
2	Phase-V	White
3	Phase-W	Blue
4	FG (Frame ground)	Green
5	Brake terminal	Red
6	Brake terminal	Black

Ⓑ Encoder plug



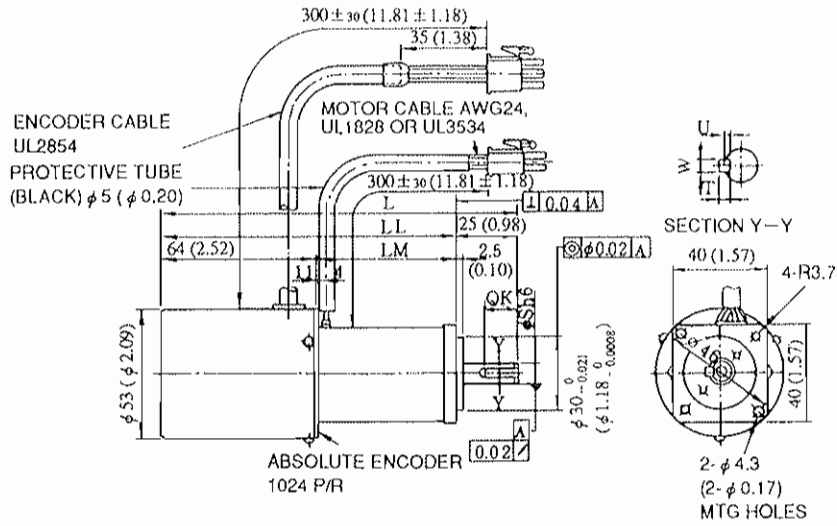
PLUG : TYPE 172169-1
 PIN : TYPE 170359-1 OR
 170363-1
 MATING TYPES
 CAP : TYPE 172161-1
 SOCKET : TYPE 170361-1 OR
 170365-1

• Incremental encoder connection

1	Channel A output	Blue
2	Channel A output	Blue/Black
3	Channel B output	Yellow
4	Channel B output	Yellow/Black
5	Channel C output	Green
6	Channel C output	Green/Black
7	0V (Power supply)	Gray
8	+5V (Power supply)	Red
9	FG (Frame Ground)	Orange

Manufacturer of connector : Amp.

- (3) With Absolute Encoder, without Brake
 · 30 W (0.04 HP), 50 W (0.07HP), 100 W (0.13 HP)



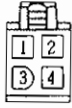
Type SGM-	L	LL	LM	S	OK	U	W	T	Output W (HP)	Mass g (lb)	Allowable Radial Load N (lb)	Allowable Thrust Load N (lb)
A3AW12					Without key				30	450	49 (11)	19 (4)
A3BW12	121.0	96.0	32.0	6	14	1.2	2	2	(0.04)	(0.99)		
A3AW14	(4.76)	(3.78)	(1.26)	(0.24)	(0.55)	(0.05)	(0.08)	(0.08)				
A3BW14												
A5AW12					Without key				50	550	68 (15)	19 (4)
A5BW12	128.5	103.5	39.5	6	14	1.2	2	2	(0.07)	(1.21)		
A5AW14	(5.06)	(4.07)	(1.56)	(0.24)	(0.55)	(0.05)	(0.08)	(0.08)				
A5BW14												
01AW12					Without key				100	650	68 (15)	19 (4)
01BW12	146.0	121.0	57.0	8	14	1.8	3	3	(0.13)	(1.43)		
01AW14	(5.75)	(4.76)	(2.24)	(0.31)	(0.55)	(0.07)	(0.12)	(0.12)				
01BW14												

Notes :

1. Detector uses 12-bit absolute encoder 1048 P/R.
2. As for type designation, "A" shows that SERVOMOTOR applies 200 VAC power and "B" shows that SERVOMOTOR applies 100 VAC power.

Connector specifications

Ⓐ Motor plug



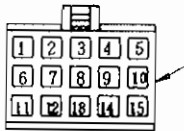
PLUG : TYPE 172167-1
 PIN : TYPE 170359-1 OR
 170363-1

MATING TYPES
 CAP : TYPE 172159-1
 SOCKET : TYPE 170362-1 OR
 170366-1

· Motor connection

1	Phase-U	Red
2	Phase-V	White
3	Phase-W	Blue
4	FG (Frame ground)	Green

Ⓑ Encoder plug



PLUG : TYPE 172171-1
 PIN : TYPE 170359-1 OR
 170363-1

MATING TYPES
 CAP : TYPE 172163-1
 SOCKET : TYPE 170361-1 OR
 170365-1

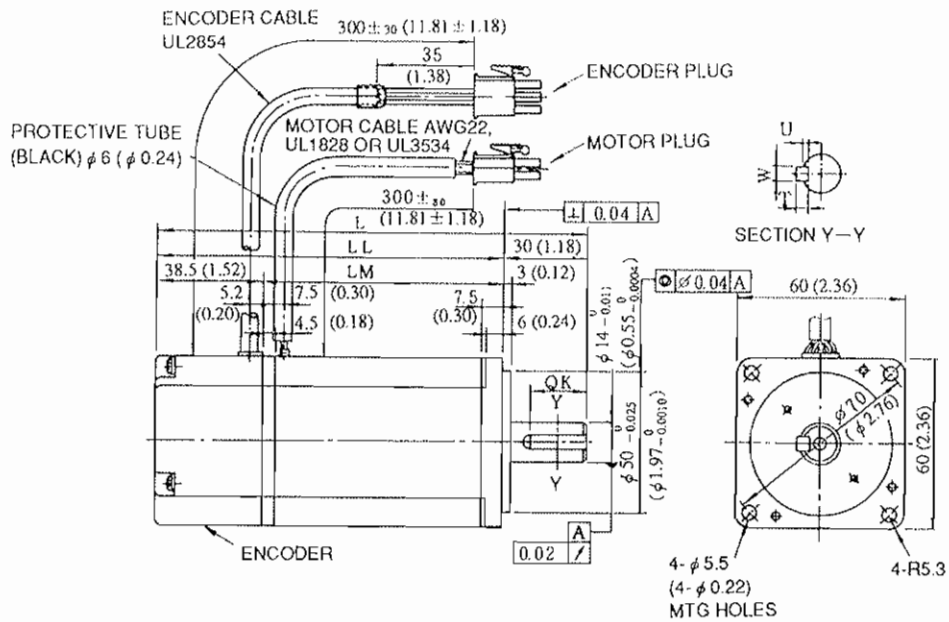
· Absolute encoder connection

1	Channel A output	Blue
2	Channel A output	White/Blue
3	Channel B output	Yellow
4	Channel B output	White/Yellow
5	Channel Z output	Green
6	Channel Z output	White/Green
7	0V (Power supply)	Black
8	+5V (Power supply)	Red
9	FG (Frame ground)	Green/Yellow
10	Channel S output	Purple
11	Channel S output	White/Purple
* (12)	(Capacitor reset)	(Gray)
13	Reset	White/Gray
14	0V (Battery)	White/Orange
15	3.6V (Battery)	Orange

Manufacturer of connector : Amp.

* Don't use this terminal since this is used for capacitor discharge terminal at shipment.

· 200 W (0.27 HP), 400 W (0.53 HP)



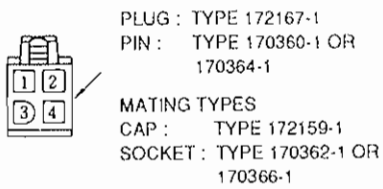
Type SGM-	L	LL	LM	QK	U	W	T	Output W (HP)	Mass g (lb)	Allowable Radial Load N (lb)	Allowable Thrust Load N (lb)
02AW12	149.5 (5.89)	119.5 (4.70)	58.0 (2.28)	Without key				200 (7.87)	1200 (2.65)	196 (44)	49 (11)
02BW12				20 (0.79)	3 (0.12)	5 (0.20)	5 (0.20)				
02AW14	177.5 (6.99)	147.5 (5.81)	86.0 (3.39)	Without key				400 (15.7)	1800 (3.97)	196 (44)	68 (15)
04AW14				20 (0.79)	3 (0.12)	5 (0.20)	5 (0.20)				

Notes :

1. Detector uses 12-bit absolute encoder 1048 P/R.
2. As for type designation, "A" shows that SERVOMOTOR applies 200 VAC power and "B" shows that SERVOMOTOR applies 100 VAC power.

Connector specifications

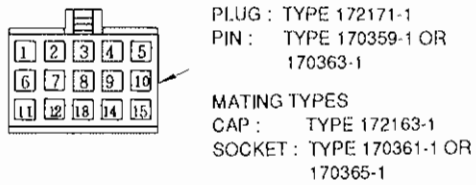
Ⓐ Motor plug



· Motor connection

1	Phase-U	Red
2	Phase-V	White
3	Phase-W	Blue
4	FG (Frame ground)	Green

Ⓑ Encoder plug



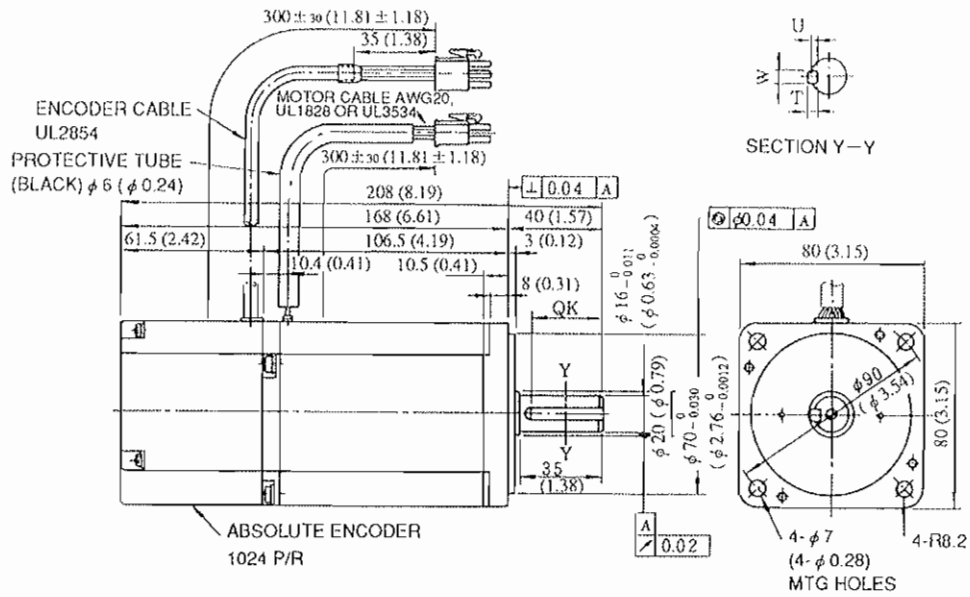
· Absolute encoder connection

1	Channel A output	Blue
2	Channel A output	White/Blue
3	Channel B output	Yellow
4	Channel B output	White/Yellow
5	Channel Z output	Green
6	Channel Z output	White/Green
7	0V (Power supply)	Black
8	+5V (Power supply)	Red
9	FG (Frame ground)	Green/Yellow
10	Channel S output	Purple
11	Channel S output	White/Purple
* (12)	(Capacitor reset)	(Gray)
13	Reset	White/Gray
14	0V (Battery)	White/Orange
15	3.6V (Battery)	Orange

Manufacturer of connector : Amp.

* Don't use this terminal since this is used for capacitor discharge terminal at shipment.

· 750 W (1.01 HP)



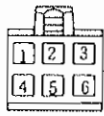
Type SGM-	QK	U	W	T	Output W (HP)	Moss g (lb)	Allowable Radial Load N (lb)	Allowable Thrust Load N (lb)
08AW12	Without key				750	3500	343 (77)	98 (22)
08AW14	30 (1.18)	3 (0.12)	5 (0.20)	5 (0.20)	(1.01)	(7.72)		

Notes :

1. Detector uses 12-bit absolute encoder 1024 P/R.
2. As for type designation, "A" shows that SERVOMOTOR applies 200 VAC power.

Connector specifications

Ⓐ Motor plug



PLUG : TYPE 172167-1
PIN : TYPE 170360-1 OR
170364-1

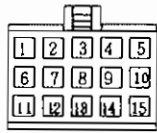
MATING TYPES

CAP : TYPE 172159-1
SOCKET : TYPE 170362-1 OR
170366-1

· Motor connection

1	Phase-U	Red
2	Phase-V	White
3	Phase-W	Blue
4	FG (Frame ground)	Green

Ⓑ Encoder plug



PLUG : TYPE 172171-1
PIN : TYPE 170359-1 OR
170363-1

MATING TYPES

CAP : TYPE 172163-1
SOCKET : TYPE 170361-1 OR
170365-1

· Absolute encoder connection

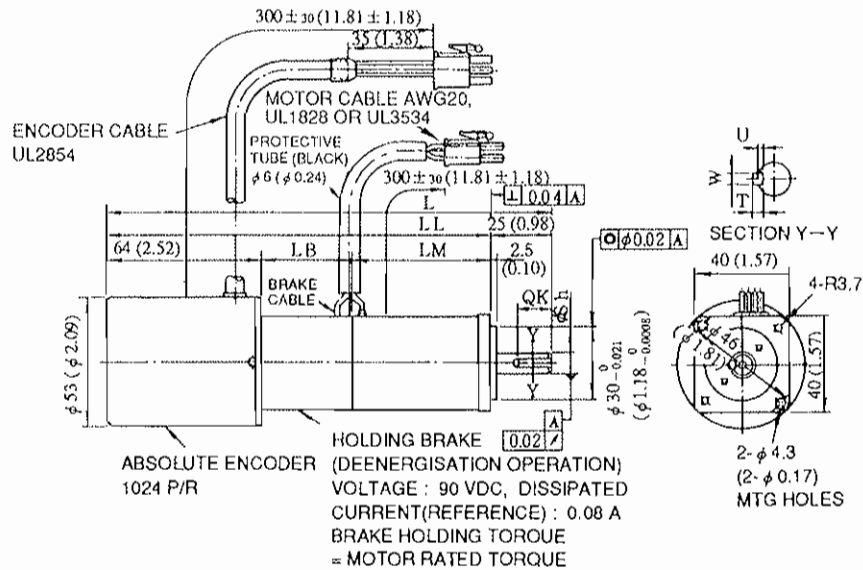
1	Channel A output	Blue
2	Channel A output	White/Blue
3	Channel B output	Yellow
4	Channel B output	White/Yellow
5	Channel Z output	Green
6	Channel Z output	White/Green
7	0V (Power supply)	Black
8	+5V (Power supply)	Red
9	FG (Frame ground)	Green/Yellow
10	Channel S output	Purple
11	Channel S output	White/Purple
* (12)	(Capacitor reset)	(Gray)
13	Reset	White/Gray
14	0V (Battery)	White/Orange
15	3.6V (Battery)	Orange

* Don't use this terminal since this is used for capacitor discharge terminal at shipment.

Manufacturer of connector : Amp.

(4) With Absolute Encoder, with Brake

· 30 W (0.04 HP), 50 W (0.07HP), 100 W (0.13 HP)



Type SGM-	L	LL	LM	LB	QK	U	W	T	S	Output W (HP)	Mass g (lb)	Allowable Radial Load N (lb)	Allowable Thrust Load N (lb)
A3AW12B	149.5 (5.86)	124.5 (4.90)	32.0 (1.26)	28.5 (1.12)	Without key				6 (0.24)	30 (0.04)	750 (1.65)	49 (11)	19 (4)
A3BW12B					14 (0.55)	1.2 (0.05)	2 (0.08)	2 (0.08)					
A5AW12B	157.0 (6.18)	132.0 (5.20)	39.5 (1.56)	28.5 (1.12)	Without key				6 (0.24)	50 (0.07)	850 (1.87)	68 (15)	19 (4)
A5BW12B					14 (0.55)	1.2 (0.05)	2 (0.08)	2 (0.08)					
01AW12B	183.5 (7.22)	158.5 (6.24)	57.0 (2.24)	37.5 (1.48)	Without key				8 (0.31)	100 (0.13)	950 (2.09)	68 (15)	19 (4)
01BW12B					14 (0.55)	1.8 (0.07)	3 (0.12)	3 (0.12)					

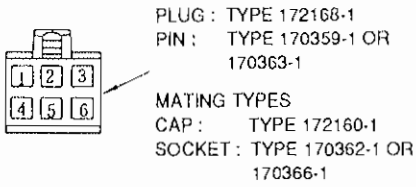
Notes :

1. Detector uses 12-bit absolute encoder 2048 P/R.

2. As for type designation, "A" shows that SERVOMOTOR applies 200 VAC power and "B" shows that SERVOMOTOR applies 100 VAC power.

Connector specifications

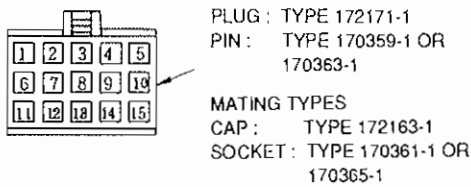
Ⓐ Motor plug



• Motor and brake connection

1	Phase-U	Red
2	Phase-V	White
3	Phase-W	Blue
4	FG (Frame ground)	Green
5	Brake terminal	Red
6	Brake terminal	Black

Ⓑ Encoder plug



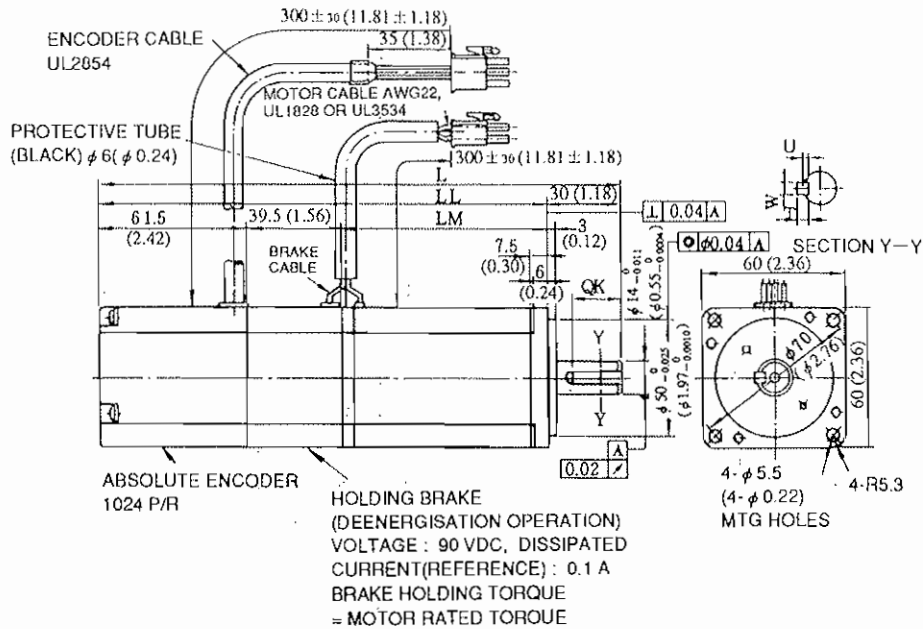
• Absolute encoder connection

1	Channel A output	Blue
2	Channel A output	White/Blue
3	Channel B output	Yellow
4	Channel B output	White/Yellow
5	Channel Z output	Green
6	Channel Z output	White/Green
7	0V (Power supply)	Black
8	+5V (Power supply)	Red
9	FG (Frame ground)	Green/Yellow
10	Channel S output	Purple
11	Channel S output	White/Purple
* (12)	(Capacitor reset)	(Gray)
13	Reset	White/Gray
14	0V (Battery)	White/Orange
15	3.6V (Battery)	Orange

Manufacturer of connector : Amp.

* Don't use this terminal since this is used for capacitor discharge terminal at shipment.

· 200 W (0.27 HP), 400 W (0.53HP)



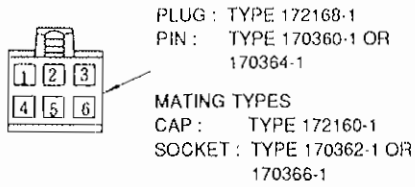
Type SGM-	L	LL	LM	OK	U	W	T	Output W (HP)	Mass g (lb)	Allowable Radial Load N (lb)	Allowable Thrust Load N (lb)
02A W12B	189.0 (7.44)	159.0 (6.26)	58.0 (2.28)	Without key				200 (7.87)	1700 (3.75)	196 (44)	49 (11)
02B W12B				20 (0.79)	3 (0.12)	5 (0.20)	5 (0.20)				
02A W14B	217.0 (8.54)	187.0 (7.36)	86.0 (3.39)	Without key				400 (15.7)	2300 (5.07)	196 (44)	68 (15)
02B W14B				20 (0.79)	3 (0.12)	5 (0.20)	5 (0.20)				

Notes :

1. Detector uses 12-bit absolute encoder 1024 P/R.
2. As for type designation, "A" shows that SERVOMOTOR applies 200 VAC power and "B" shows that SERVOMOTOR applies 100 VAC power.

Connector specifications

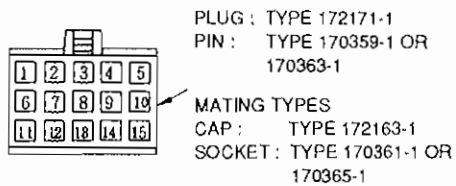
Ⓐ Motor plug



· Motor and brake connection

1	Phase-U	Red
2	Phase-V	White
3	Phase-W	Blue
4	FG (Frame ground)	Green
5	Brake terminal	Red
6	Brake terminal	Black

Ⓑ Encoder plug



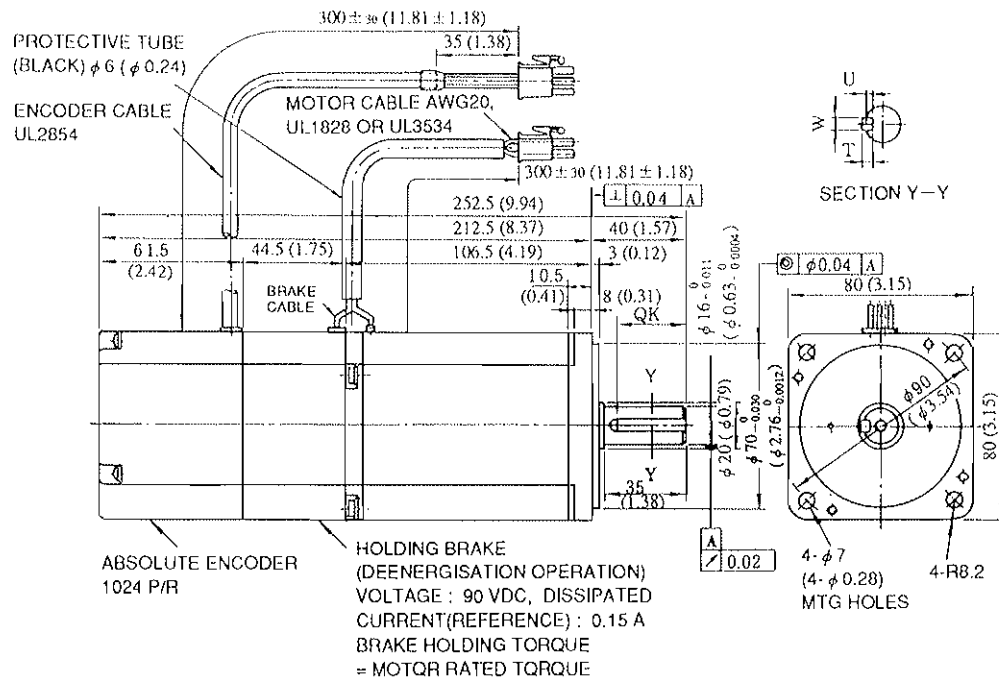
· Absolute encoder connection

1	Channel A output	Blue
2	Channel \bar{A} output	White/Blue
3	Channel B output	Yellow
4	Channel \bar{B} output	White/Yellow
5	Channel Z output	Green
6	Channel \bar{Z} output	White/Green
7	0V (Power supply)	Black
8	+5V (Power supply)	Red
9	FG (Frame ground)	Green/Yellow
10	Channel S output	Purple
11	Channel \bar{S} output	White/Purple
* (12)	(Capacitor reset)	(Gray)
13	Reset	White/Gray
14	0V (Battery)	White/Orange
15	3.6V (Battery)	Orange

Manufacturer of connector : Amp.

* Don't use this terminal since this is used for capacitor discharge terminal at shipment.

· 750 W (1.01 HP)



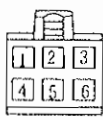
Type SGM-	OK	U	W	T	Output W (HP)	Mass g (lb)	Allowable Radial Load N (lb)	Allowable Thrust Load N (lb)
08AW12B	Without key				750 (1.01)	4500 (9.92)	343 (77)	98 (22)
08AW14B	30 (1.18)	3 (0.12)	5 (0.20)	5 (0.20)				

Notes :

1. Detector uses 12-bit absolute encoder 1024 P/R.
2. As for type designation, "A" shows that SERVOMOTOR applies 200 VAC power.

Connector specifications

Ⓐ Motor plug

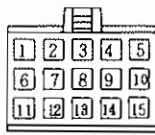


PLUG : TYPE 172168-1
 PIN : TYPE 170360-1 OR
 170364-1
 MATING TYPES
 CAP : TYPE 172160-1
 SOCKET : TYPE 170362-1 OR
 170366-1

· Motor and brake connection

1	Phase-U	Red
2	Phase-V	White
3	Phase-W	Blue
4	FG (Frame ground)	Green
5	Brake terminal	Red
6	Brake terminal	Black

Ⓑ Encoder plug



PLUG : TYPE 172171-1
 PIN : TYPE 170359-1 OR
 170363-1
 MATING TYPES
 CAP : TYPE 172163-1
 SOCKET : TYPE 170361-1 OR
 170365-1

· Absolute encoder connection

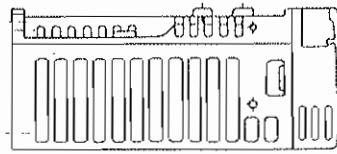
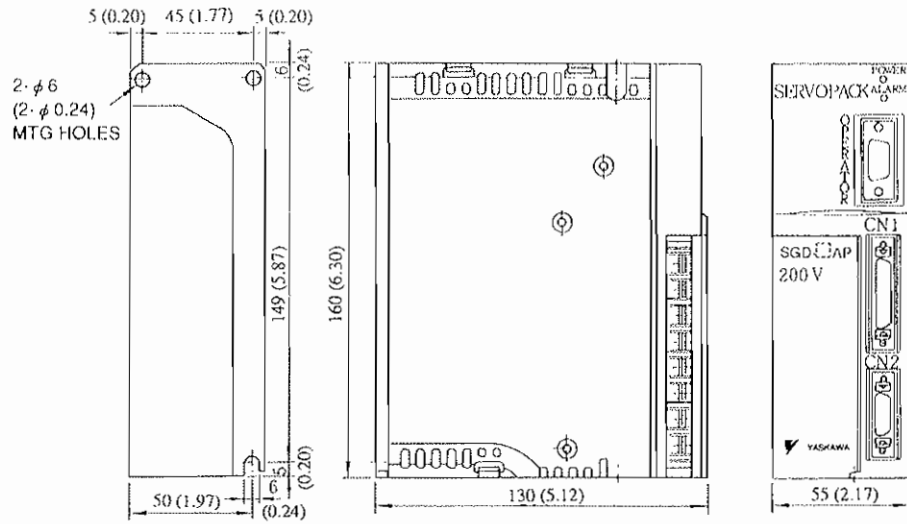
1	Channel A output	Blue
2	Channel A output	White/Blue
3	Channel B output	Yellow
4	Channel B output	White/Yellow
5	Channel Z output	Green
6	Channel Z output	White/Green
7	0V (Power supply)	Black
8	+5V (Power supply)	Red
9	FG (Frame ground)	Green/Yellow
10	Channel S output	Purple
11	Channel S output	White/Purple
* (12)	(Capacitor reset)	(Gray)
13	Reset	White/Gray
14	0V (Battery)	White/Orange
15	3.6V (Battery)	Orange

Manufacturer of connector : Amp.

* Don't use this terminal since this is used for capacitor discharge terminal at shipment.

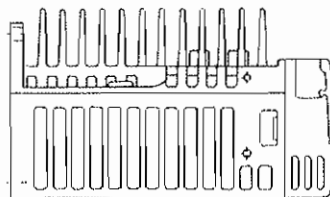
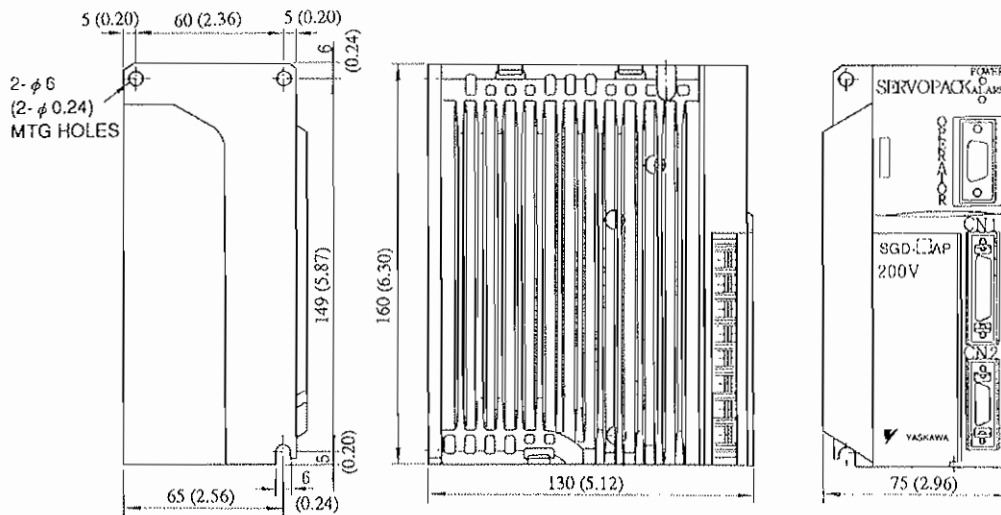
10.2 SGD SERVOPACK

- Types SGD-A3A □ to 02 □ (200 V : 30 (0.04 HP) to 200 W (0.27 HP))
 SGD-A3B □ to 01 □ (100 V : 30 (0.04 HP) to 100 W (0.13 HP))



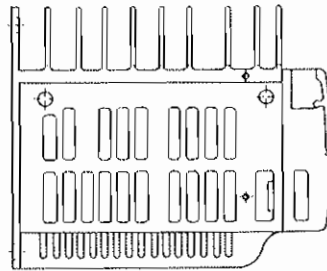
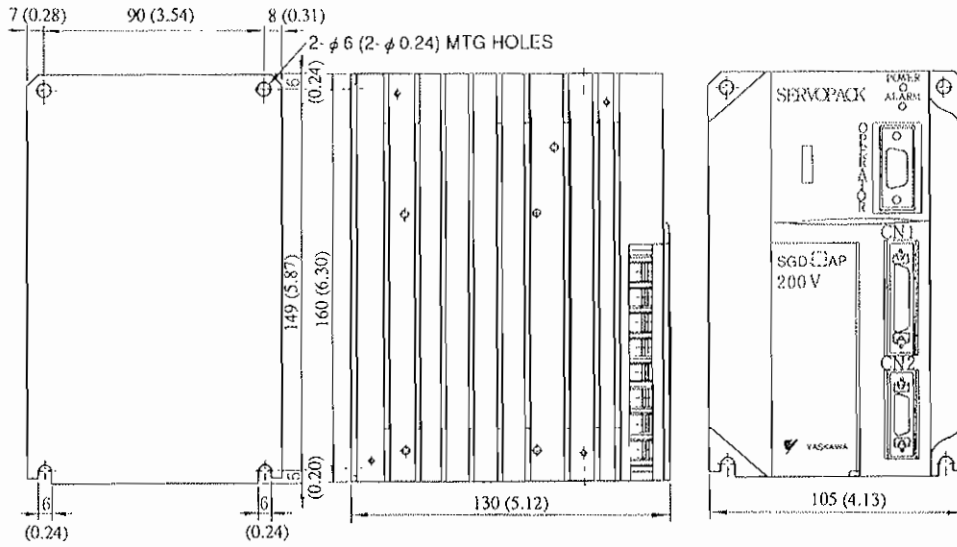
Approx. Mass : 0.9 kg (1.98 lb)

- Types SGD-04A □ (200 V : 400 W (0.53 HP))
 SGD-02B □ (100 V : 200 W (0.27 HP))



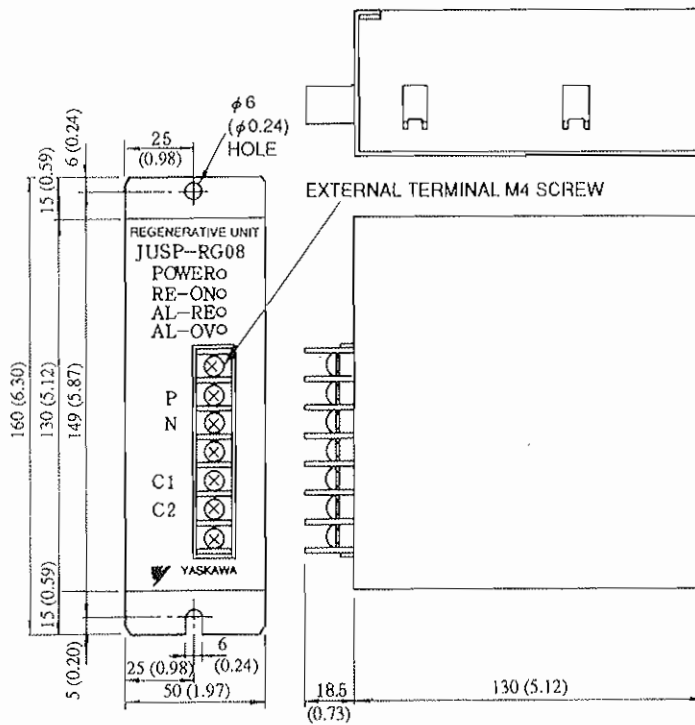
Approx. Mass : 1.2 kg (2.65 lb)

· Type SGD-08A (200 V : 750 W (1.01 HP))



Approx. Mass : 1.5 kg (3.31 lb)

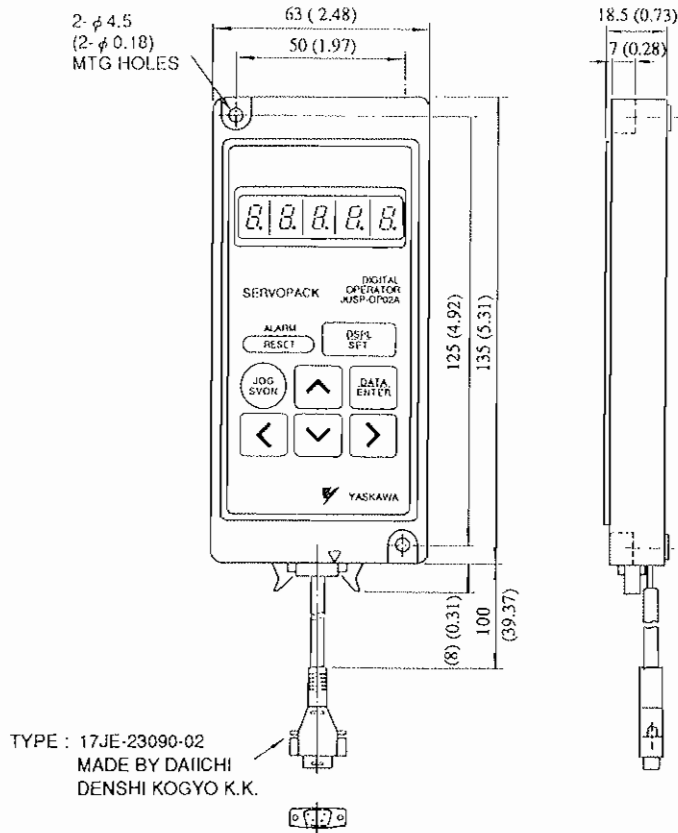
10.3 REGENERATIVE UNIT



Approx. Mass : 1 kg (2.20 lb)

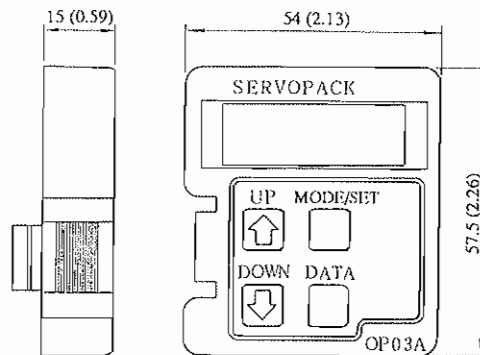
10.4 DIGITAL OPERATOR

· Type JUSP-OP02A-1



Approx. Mass : 0.18 kg (0.40 lb)

· Type JUSP-OP03A



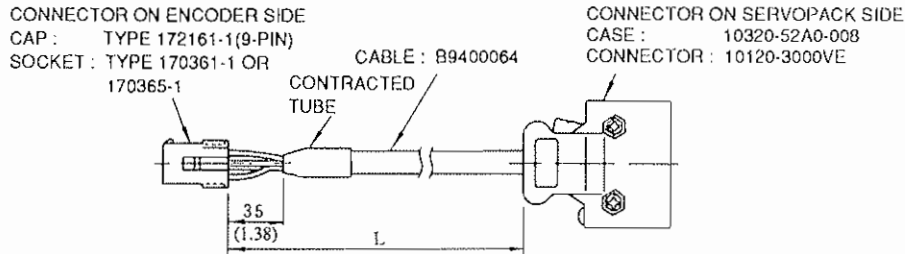
Approx. Mass : 0.02 kg (0.04 lb)

10.5 CABLES

10.5.1 When Provided by YASKAWA

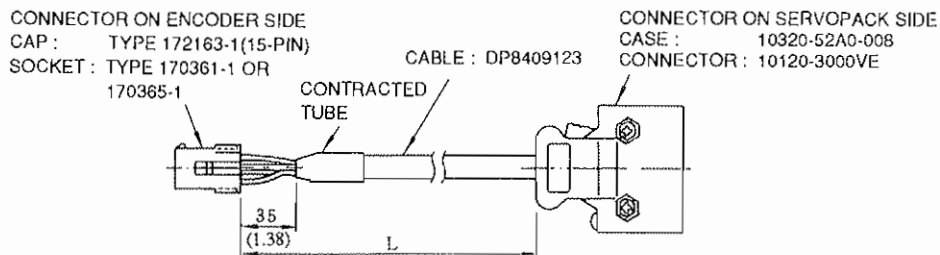
(1) Cable for Incremental/Absolute Encoder

- For motor with incremental encoder
Cable with double-end connector



Type	L in mm (feet)
DP9320089-1	3000 $^{+100}_0$ (10 $^{+0.33}_0$)
DP9320089-2	5000 $^{+100}_0$ (16.7 $^{+0.33}_0$)
DP9320089-3	10000 $^{+500}_0$ (33.3 $^{+1.67}_0$)
DP9320089-4	15000 $^{+500}_0$ (50 $^{+1.67}_0$)
DP9320089-5	20000 $^{+500}_0$ (66.7 $^{+1.67}_0$)

- For motor with absolute encoder
Cable with double-end connector

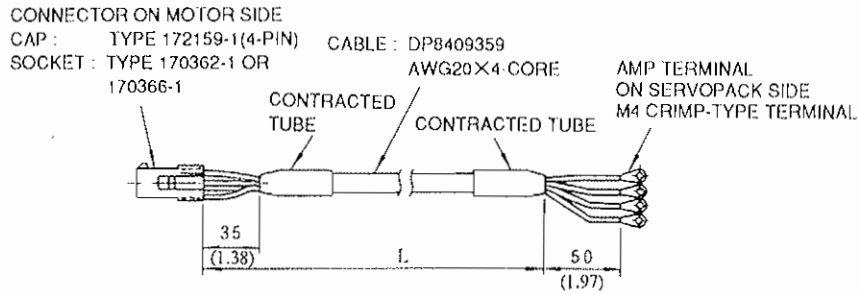


Type	L in mm (feet)
DP9320088-1	3000 $^{+100}_0$ (10 $^{+0.33}_0$)
DP9320088-2	5000 $^{+100}_0$ (16.7 $^{+0.33}_0$)
DP9320088-3	10000 $^{+500}_0$ (33.3 $^{+1.67}_0$)
DP9320088-4	15000 $^{+500}_0$ (50 $^{+1.67}_0$)
DP9320088-5	20000 $^{+500}_0$ (66.7 $^{+1.67}_0$)

(2) Cable for Motor

· For motor without brake

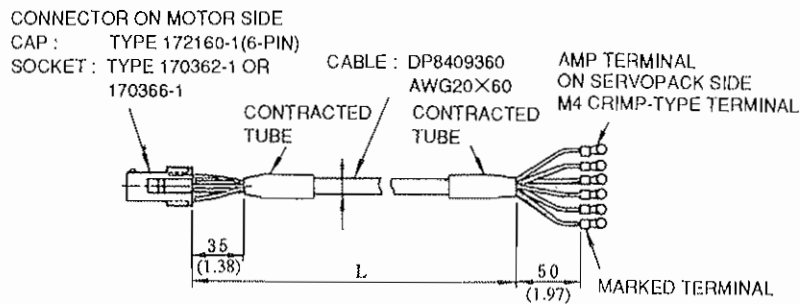
With connector and amplifier terminal



Type	L in mm (feet)
DP9320081-1	$3000 \begin{smallmatrix} +100 \\ 0 \end{smallmatrix} (10 \begin{smallmatrix} +0.33 \\ 0 \end{smallmatrix})$
DP9320081-2	$5000 \begin{smallmatrix} +100 \\ 0 \end{smallmatrix} (16.7 \begin{smallmatrix} +0.33 \\ 0 \end{smallmatrix})$
DP9320081-3	$10000 \begin{smallmatrix} +500 \\ 0 \end{smallmatrix} (33.3 \begin{smallmatrix} +1.67 \\ 0 \end{smallmatrix})$
DP9320081-4	$15000 \begin{smallmatrix} +500 \\ 0 \end{smallmatrix} (50 \begin{smallmatrix} +1.67 \\ 0 \end{smallmatrix})$
DP9320081-5	$20000 \begin{smallmatrix} +500 \\ 0 \end{smallmatrix} (66.7 \begin{smallmatrix} +1.67 \\ 0 \end{smallmatrix})$

· For motor with brake

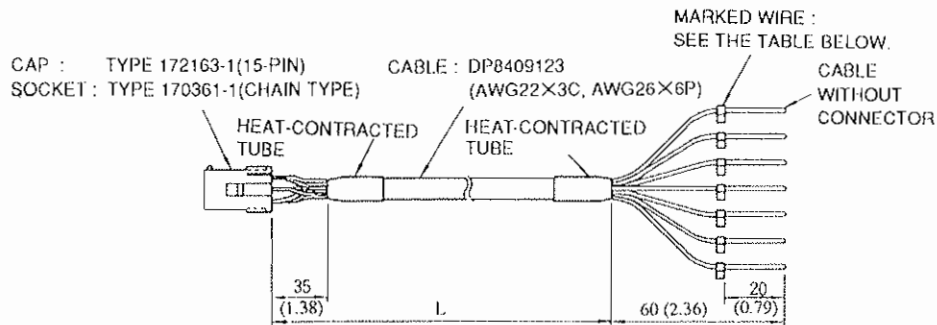
With connector and amplifier terminal



Type	L in mm (feet)
DP9320083-1	$3000 \begin{smallmatrix} +100 \\ 0 \end{smallmatrix} (10 \begin{smallmatrix} +0.33 \\ 0 \end{smallmatrix})$
DP9320083-2	$5000 \begin{smallmatrix} +100 \\ 0 \end{smallmatrix} (16.7 \begin{smallmatrix} +0.33 \\ 0 \end{smallmatrix})$
DP9320083-3	$10000 \begin{smallmatrix} +500 \\ 0 \end{smallmatrix} (33.3 \begin{smallmatrix} +1.67 \\ 0 \end{smallmatrix})$
DP9320083-4	$15000 \begin{smallmatrix} +500 \\ 0 \end{smallmatrix} (50 \begin{smallmatrix} +1.67 \\ 0 \end{smallmatrix})$
DP9320083-5	$20000 \begin{smallmatrix} +500 \\ 0 \end{smallmatrix} (66.7 \begin{smallmatrix} +1.67 \\ 0 \end{smallmatrix})$

10.5.2 When Connector on SERVOPACK Side is Provided by User

- Cable for absolute encoder (with single connector on SERVOMOTOR side)



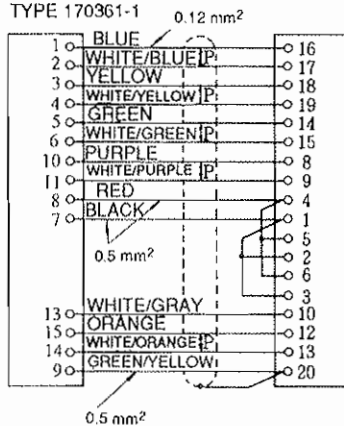
Cable Color Coding

No.	Color
1	Black
4	Red
8	Purple
9	White/Purple
10	White/Gray
12	Orange
13	White/Orange
14	Green
15	White/Green
16	Blue
17	White/Blue
18	Yellow
19	White/Yellow
20	Green/Yellow

THE FOLLOWING SHOULD BE PROVIDED BY USER :

CASE : 10320-52A0-008
 (MADE BY SUMITOMO 3M LTD.)
 CONNECTOR : 10120-3000VE
 (MADE BY SUMITOMO 3M LTD.)

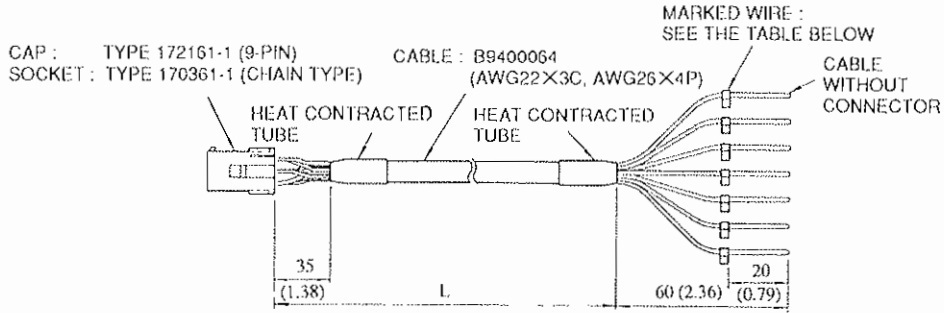
CAP : TYPE 172163-1
 SOCKET : TYPE 170361-1



P : Twisted pair wires

Type	L in mm (feet)
DP9320085-1	3000 ⁺¹⁰⁰ ₀ (10 ^{+0.33} ₀)
DP9320085-2	5000 ⁺¹⁰⁰ ₀ (16.7 ^{+0.33} ₀)
DP9320085-3	10000 ⁺¹⁰⁰ ₀ (33.3 ^{+0.33} ₀)
DP9320085-4	15000 ⁺¹⁰⁰ ₀ (50 ^{+0.33} ₀)
DP9320085-5	20000 ⁺¹⁰⁰ ₀ (66.7 ^{+0.33} ₀)

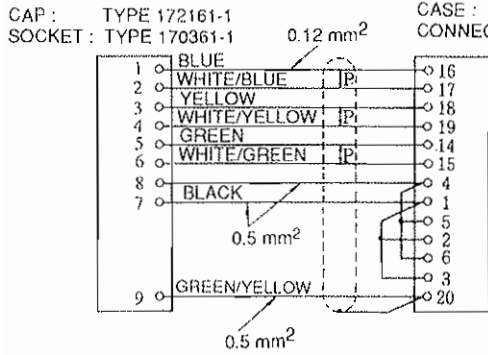
· Cable for incremental encoder (with single connector on SERVOMOTOR side)



Cable Treatment

No.	Color
1	Black
4	Red
14	Green
15	White/Green
16	Blue
17	White/Blue
18	Yellow
19	White/Yellow
20	Green/Yellow

THE FOLLOWING SHOULD PROVIDED BY USER :
 CASE : 10320-52A0-008
 CONNECTOR : 10120-3000VE



Type	L in mm (feet)
DP9320086-1	3000 $\begin{smallmatrix} +100 \\ 0 \end{smallmatrix}$ (10 $\begin{smallmatrix} +0.33 \\ 0 \end{smallmatrix}$)
DP9320086-2	5000 $\begin{smallmatrix} +100 \\ 0 \end{smallmatrix}$ (16.7 $\begin{smallmatrix} +0.33 \\ 0 \end{smallmatrix}$)
DP9320086-3	10000 $\begin{smallmatrix} +100 \\ 0 \end{smallmatrix}$ (33.3 $\begin{smallmatrix} +0.33 \\ 0 \end{smallmatrix}$)
DP9320086-4	15000 $\begin{smallmatrix} +100 \\ 0 \end{smallmatrix}$ (50 $\begin{smallmatrix} +0.33 \\ 0 \end{smallmatrix}$)
DP9320086-5	20000 $\begin{smallmatrix} +100 \\ 0 \end{smallmatrix}$ (66.7 $\begin{smallmatrix} +0.33 \\ 0 \end{smallmatrix}$)

10.5.3 Cable without Connector

(1) Cable for Incremental/Absolute Encoder

• For incremental encoder

Type	L in mm (feet)
DP9400064-1	3000 $\begin{smallmatrix} +100 \\ 0 \end{smallmatrix}$ (10 $\begin{smallmatrix} +0.33 \\ 0 \end{smallmatrix}$)
DP9400064-2	5000 $\begin{smallmatrix} +100 \\ 0 \end{smallmatrix}$ (16.7 $\begin{smallmatrix} +0.33 \\ 0 \end{smallmatrix}$)
DP9400064-3	10000 $\begin{smallmatrix} +500 \\ 0 \end{smallmatrix}$ (33.3 $\begin{smallmatrix} +1.67 \\ 0 \end{smallmatrix}$)
DP9400064-4	15000 $\begin{smallmatrix} +500 \\ 0 \end{smallmatrix}$ (50 $\begin{smallmatrix} +1.67 \\ 0 \end{smallmatrix}$)
DP9400064-5	20000 $\begin{smallmatrix} +500 \\ 0 \end{smallmatrix}$ (66.7 $\begin{smallmatrix} +1.67 \\ 0 \end{smallmatrix}$)

THE FOLLOWING SHOULD BE PROVIDED

BY USER :

CAP : TYPE 172161-1

(MADE BY AMP.)

SOCKET : TYPE 170361-1 OR

170365-1

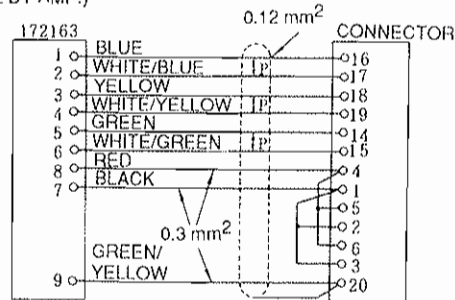
(MADE BY AMP.)

THE FOLLOWING SHOULD BE PROVIDED

BY USER :

CASE : 10320-52A0-008

CONNECTOR : 10120-3000VE



• For absolute encoder

Type	L in mm (feet)
DP8409123-1	3000 $\begin{smallmatrix} +100 \\ 0 \end{smallmatrix}$ (10 $\begin{smallmatrix} +0.33 \\ 0 \end{smallmatrix}$)
DP8409123-2	5000 $\begin{smallmatrix} +100 \\ 0 \end{smallmatrix}$ (16.7 $\begin{smallmatrix} +0.33 \\ 0 \end{smallmatrix}$)
DP8409123-3	10000 $\begin{smallmatrix} +500 \\ 0 \end{smallmatrix}$ (33.3 $\begin{smallmatrix} +1.67 \\ 0 \end{smallmatrix}$)
DP8409123-4	15000 $\begin{smallmatrix} +500 \\ 0 \end{smallmatrix}$ (50 $\begin{smallmatrix} +1.67 \\ 0 \end{smallmatrix}$)
DP8409123-5	20000 $\begin{smallmatrix} +500 \\ 0 \end{smallmatrix}$ (66.7 $\begin{smallmatrix} +1.67 \\ 0 \end{smallmatrix}$)

THE FOLLOWING SHOULD BE PROVIDED

BY USER :

CAP : TYPE 172163-1

SOCKET : 170361-1 OR

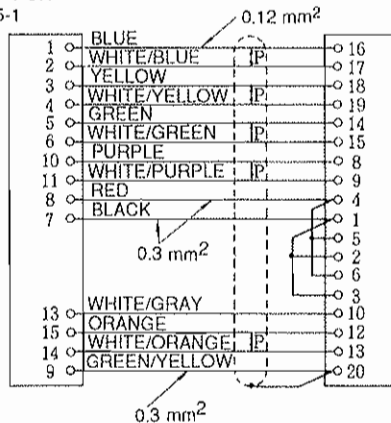
170365-1

THE FOLLOWING SHOULD BE PROVIDED

BY USER :

CASE : 10320-52A0-008

CONNECTOR : 10120-3000VE



IP : Twisted pair wires

Note : For details of caps, sockets, cases and connectors, refer to Par. 10.6, "CONNECTOR KIT."

(2) Cable for Motor

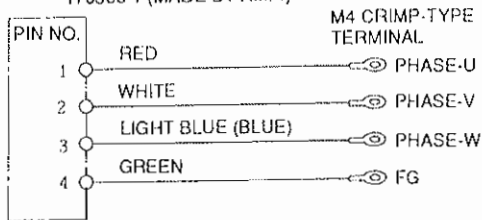
· For motor without brake

Type	L in mm (feet)
DP8409359-1	3000 $\begin{smallmatrix} +100 \\ 0 \end{smallmatrix}$ (10 $\begin{smallmatrix} 0.33 \\ 0 \end{smallmatrix}$)
DP8409359-2	5000 $\begin{smallmatrix} +100 \\ 0 \end{smallmatrix}$ (16.7 $\begin{smallmatrix} 0.33 \\ 0 \end{smallmatrix}$)
DP8409359-3	10000 $\begin{smallmatrix} +500 \\ 0 \end{smallmatrix}$ (33.3 $\begin{smallmatrix} 1.67 \\ 0 \end{smallmatrix}$)
DP8409359-4	15000 $\begin{smallmatrix} +500 \\ 0 \end{smallmatrix}$ (50 $\begin{smallmatrix} 1.67 \\ 0 \end{smallmatrix}$)
DP8409359-5	20000 $\begin{smallmatrix} +500 \\ 0 \end{smallmatrix}$ (66.7 $\begin{smallmatrix} 1.67 \\ 0 \end{smallmatrix}$)

AMP CONNECTOR

CAP : TYPE 172159-1

SOCKET : TYPE 170362-1 OR
170366-1 (MADE BY AMP.)



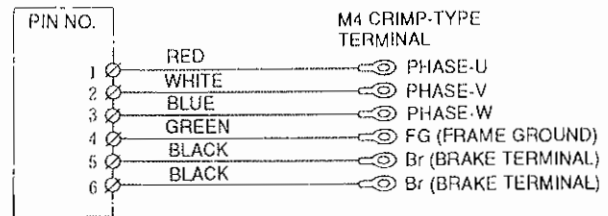
· For motor without brake

Type	L in mm (feet)
DP8409360-1	3000 $\begin{smallmatrix} +100 \\ 0 \end{smallmatrix}$ (10 $\begin{smallmatrix} 0.33 \\ 0 \end{smallmatrix}$)
DP8409360-2	5000 $\begin{smallmatrix} +100 \\ 0 \end{smallmatrix}$ (16.7 $\begin{smallmatrix} 0.33 \\ 0 \end{smallmatrix}$)
DP8409360-3	10000 $\begin{smallmatrix} +500 \\ 0 \end{smallmatrix}$ (33.3 $\begin{smallmatrix} 1.67 \\ 0 \end{smallmatrix}$)
DP8409360-4	15000 $\begin{smallmatrix} +500 \\ 0 \end{smallmatrix}$ (50 $\begin{smallmatrix} 1.67 \\ 0 \end{smallmatrix}$)
DP8409360-5	20000 $\begin{smallmatrix} +500 \\ 0 \end{smallmatrix}$ (66.7 $\begin{smallmatrix} 1.67 \\ 0 \end{smallmatrix}$)

AMP CONNECTOR

CAP : TYPE 172160-1

SOCKET : TYPE 170362-1 OR
170366-1 (MADE BY AMP.)

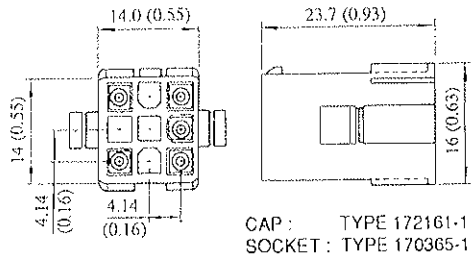


Note : For details of caps and sockets, refer to Par. 10.6, "CONNECTOR KIT."

10.6 CONNECTOR KIT

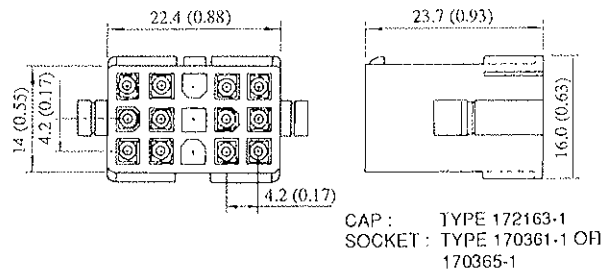
(1)-A Cap for Encoder Cable

• For incremental encoder



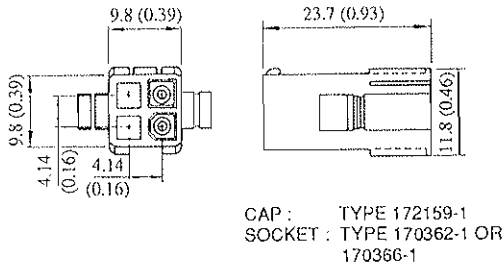
(1)-B Cap for Encoder Cable

• For absolute encoder



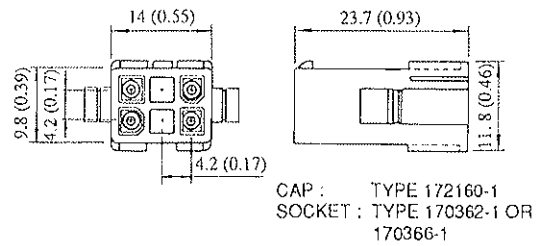
(2)-A Cap for Motor Cable

• For motor without brake



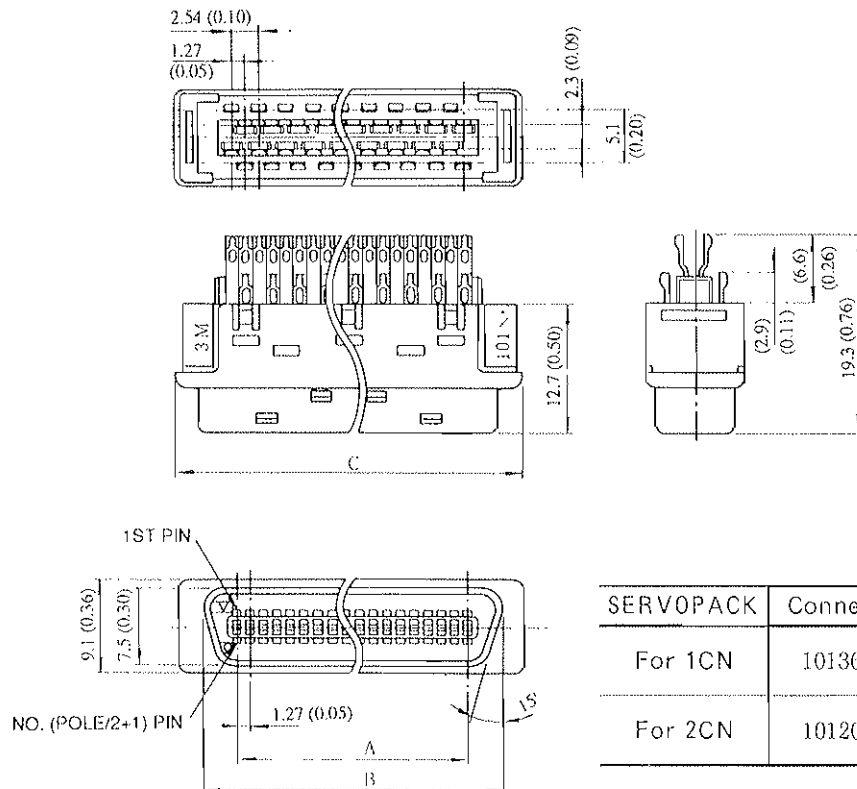
(2)-B Cap for Motor Cable

• For motor with brake



(3) SGD SERVOPACK 1CN, 2CN

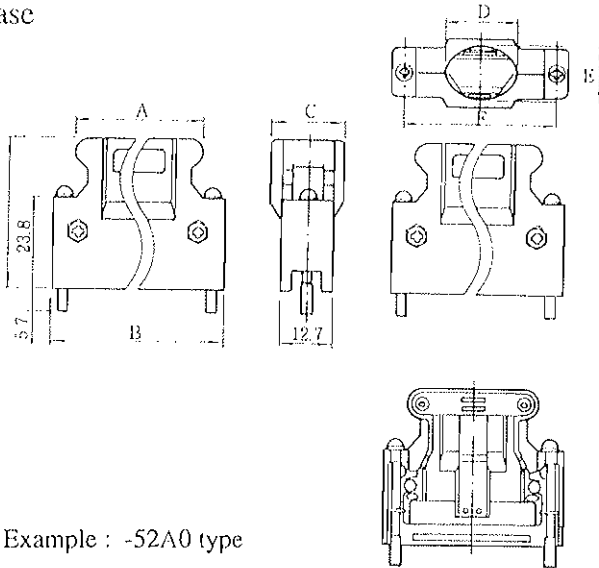
• Connector



in mm (inches)

SERVOPACK	Connector Type	A	B	C
For 1CN	10136-3000VE	21.59 (0.85)	27.8 (1.09)	32.2 (1.27)
For 2CN	10120-3000VE	11.43 (0.45)	17.6 (0.69)	22.0 (0.87)

· Case



Example : -52A0 type

in mm (inches)

SERVOPACK	Connector Type	Shell Type	A	B	C	D	E	F
For 1CN	10136-3000VE	10336-52A0-008	32.2 (1.27)	43.5 (1.71)	18.0 (0.71)	17.0 (0.67)	14.0 (0.55)	37.6 (1.48)
For 2CN	10120-3000VE	10320-52A0-008	22.0 (0.87)	18.0 (0.71)	14.0 (0.55)	12.0 (0.47)	10.0 (0.39)	27.4 (1.08)

Connector Kit Type	Application		Connector Kit Parts List												
	For Encoder/ Motor Cable		For Encoder Cable								For Motor Cable				
			On Encoder Side				On SERVOPACK Side								
	Encoder Type	Motor Brake	Cap		Socket		Connector		Case		Cap		Socket		
Type			Qty	Type	Qty	Type	Qty	Type	Qty	Type	Qty	Type	Qty		
DP9420006-1	Incremental encoder	Without	172161-1*	1		†	10					172159-1*	1		5†
DP9420006-2	Incremental encoder	With			170365-1*			10120-3000VE	1	10320-52A0-008	1-set	172160-1*	1		7†
DP9420006-3	Absolute encoder	Without				†	16					172159-1*	1	170366-1*	5†
DP9420006-4	Absolute encoder	With	172163-1*	1								162160-1*	1		7†

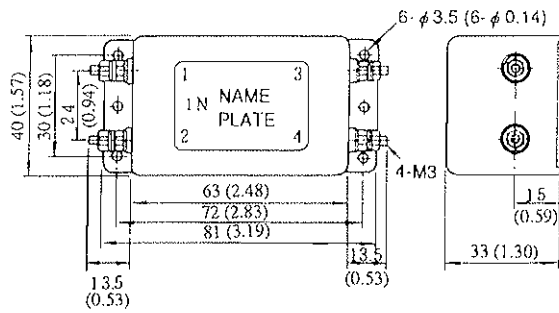
Connector Kit Type	Application	Connector Kit Parts List			
		Connector		Case	
		Type	Qty	Type	Qty
DP9420007	I/O connector for 1CN	10136-3000VE	1	10336-52A0-008	1-set

* Made by AMP.

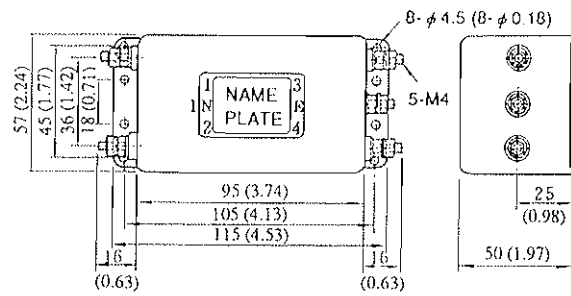
† Including 1 spare.

10.7 NOISE FILTER

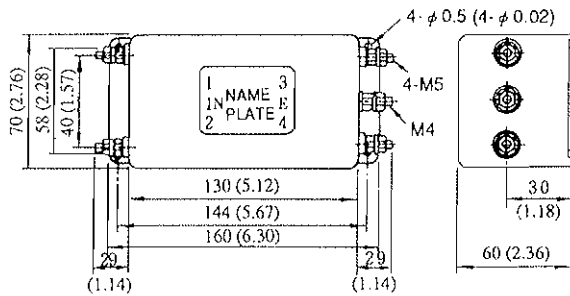
· Type LF-205A



· Type LF-210



· Type LF-220

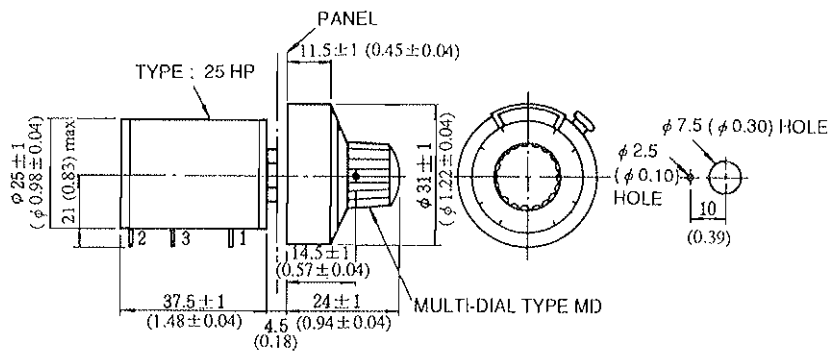


Made by Tokin Corp.

10.8 PERIPHERAL DEVICES

(1) Variable Resistor for Speed Setting

· Type 25HP-10B

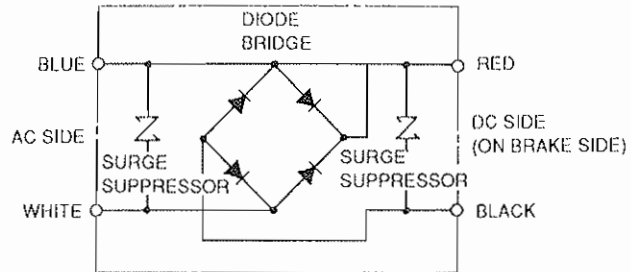
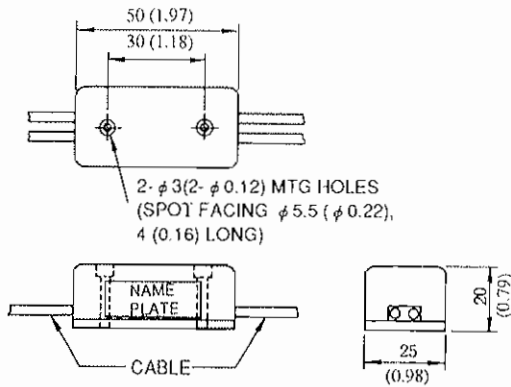


(2) Power Supply for Brake

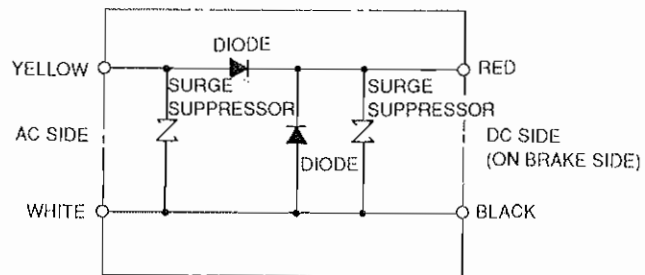
You can select two types of power supply for brake (100/200 VAC).

- Input 100 VAC/90 VDC (DP8401002-2)
- Input 200 VAC/90 VDC (DP8401002-1)

• Internal circuit for 100 VAC



• Internal circuit for 200 VAC



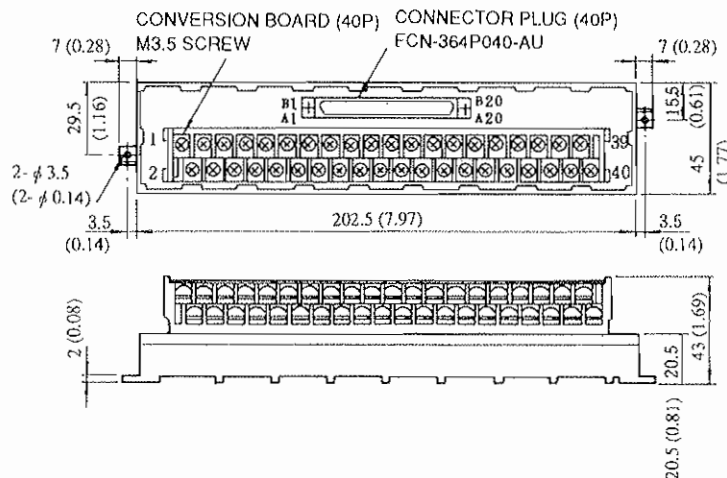
- Cable length : 500 mm each
- Cables are distinguished by color.

AC Input Side		On Brake Side
100 V	200 V	
Blue, White	Yellow, White	Red, Black

Note : The brake power circuit can be turned ON and OFF on either the AC or DC side. Normally, switching on the AC side is safer. If switched on the DC side, surge voltage may damage the brake coil. To avoid this, place a surge suppressor near the brake coil.

- Max. ambient temperature : 60°C

(3) Connector to Terminal Conversion Unit (Type JUSP-TA36P)



11. TEST RUN

Before test run, check the following. Correct any deficiency.

11.1 CHECK ITEMS BEFORE TEST RUN

11.1.1 SGM SERVOMOTOR

Before test run, check the following. If the test run is performed after long storage, see Par. 13, "INSPECTION AND MAINTENANCE."

- Connection to machines or devices, wiring, and grounding are correct.
- Bolts and nuts are tightened.
- For motors with shaft seals, the seals are not damaged and motor is properly lubricated.

11.1.2 SGD SERVOPACK

- Parameters are correctly set to satisfy the specifications for the applicable SERVOMOTOR.
- Connection and wiring leads are firmly connected to terminals or inserted into the connectors.
- The power supply is turned OFF if servo alarm occurs.
- Voltage supplied to SGD SERVOPACK is 200 to 230 VAC^{+10%}/_{-15%} (100 to 115 VAC^{+10%}/_{-15%}). If a voltage line other than 200 V (100 V) is used, the voltage should be dropped to 200 V (100 V) through a power transformer.
- The speed reference should be 0 V.

11.2 TEST RUN PROCEDURES

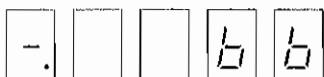
11.2.1 Preparation for Operation

During test run, loads should not be applied to the SERVOMOTOR. If it is necessary to start with the driven machine connected to the motor, confirm that the driven system is ready for emergency stop at any time.

(1) Power ON

After checking items in Par. 6.1, turn ON the power supply. When the power ON sequence is correct, according to Par. 6.1, the power is turned ON by depressing the POWER pushbutton for approximately 2 second.

- (2) If power is supplied normally, the power ON indicator LED (green) lights and the alarm LED (red) goes OFF. When a digital operator is used, the display shown below appears when power is supplied normally. (This display appears in base block status.)



(3) Inputting the servo ON signal (by switching ON the contact) activates the power circuit in the SGD SERVOPACK to be ready to drive the motor. (The display shown below appears on the digital operator, provided that the motor is stopped.)

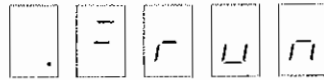


11.2.2 Operation

The operation is possible only while Servo ON signal is ON.

The motor is operated at a low speed by continuously turning ON the reference pulse of low frequency.

Motor rotating speed and motor rotation angle are in proportion to reference pulse frequency and number of turning-ON reference pulses, respectively.



Check that the motor rotating direction coincides properly according to the forward run or reverse run command (differs depending on reference pulse input form).

The motor stops when supply of reference pulses is stopped.

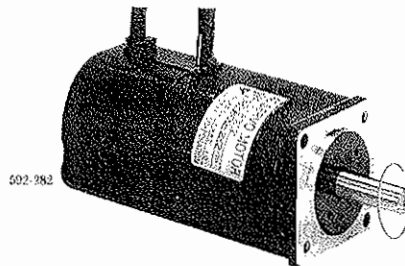


Fig. 11.1 Motor Forward Running

11.2.3 Inspection during Test Run

The following items should be checked for during the test run.

- Unusual vibration
- Abnormal noise
- Excessive temperature rise

If any fault is found, take corrective actions according to Par. 14. At a test operation, the load and machine may not fit well at first and result in overload.

12. ADJUSTMENT

12.1 CHARACTERISTICS PRESET AT THE FACTORY PRIOR TO SHIPMENT

Standard factory setting is speed control mode. To change to torque control mode, set up bit A or B of user constant Cn-02. Characteristics preset at the factory are shown below.

. In Speed Control Mode

(1) Speed Reference Input—SERVOMOTOR Speed Ratio

Condition : No load

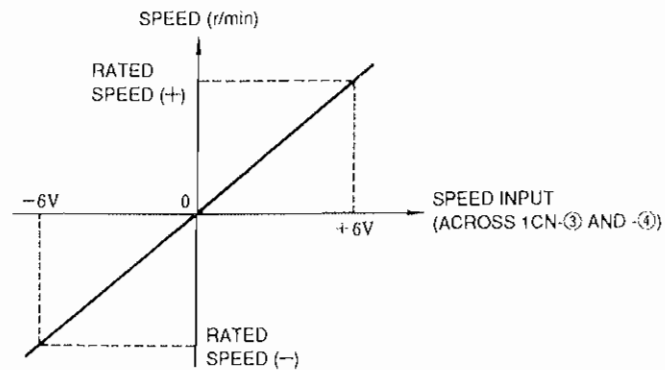


Fig. 12.1 Speed Reference Input—SERVOMOTOR Speed Ratio

(2) Start—Stop Response Characteristics

Condition :

I_P : Start current set value

Load inertia $J_L = \text{motor inertia } J_M \times 3$

Both overshoot (N_{OV}) and undershoot (N_{UD}) are 5% or less.

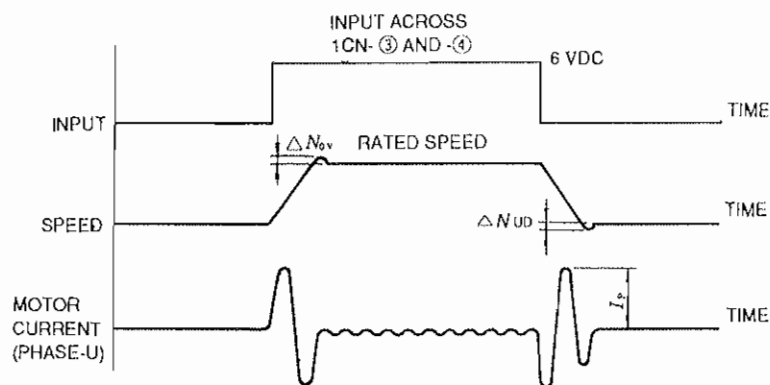


Fig. 12.2 Start—Stop Response Characteristics

(3) Speed Regulation

Speed regulation $\Delta N, \Delta n$:

$$\frac{\Delta n}{N_R} \times 100\% \leq 0.03\%$$

$$\frac{\Delta N}{N_R} \times 100\% \leq 0.015\%$$

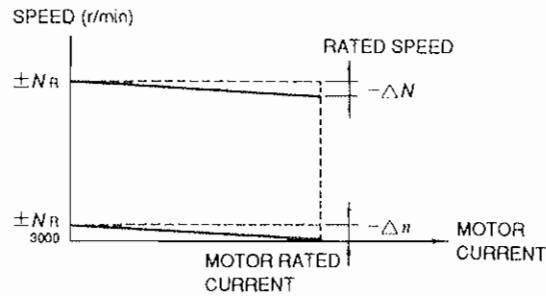


Fig. 12.3 Speed Regulation

• In Torque Control Mode

(1) Torque reference input—Torque characteristics

Conditions : No load

Continuous pulse

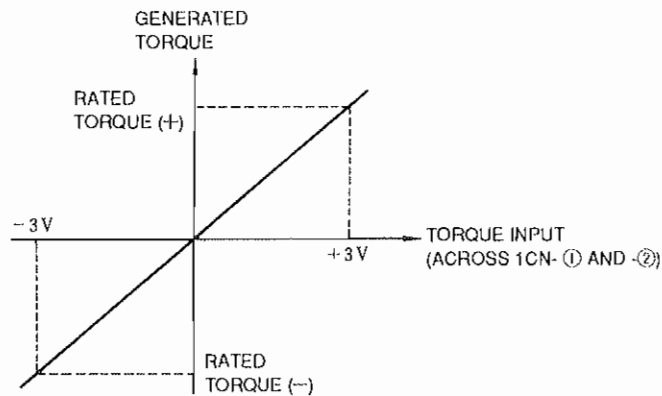


Fig. 12.4 Torque Reference Input—Torque Characteristics

12.2 RESET

If resetting of parameters is necessary, refer to Par. 8, "DIGITAL OPERATOR (JUSP-OP02A-1, -OP03A)."

13. INSPECTION AND MAINTENANCE

13.1 SGM SERVOMOTOR

SGM SERVOMOTOR has no movable wearing parts (eg. brushes), so simple daily inspection is sufficient. The inspection schedule for the motor is shown in Table 13.1.

Do not disassemble the motor. If disassembly should become necessary, contact your YASKAWA representative.

Table 13.1 Inspection Schedule for Motors

Inspection Item	Frequency	Inspection Operation
Vibration	Daily	Touch by hand
Noise	Daily	Aurally
Exterior and Cleaning	As required	Clean with dry cloth or compressed air.
Insulation Resistance	Annually	Make sure that it is more than 10M Ω by measuring with a 500V megger after disconnecting the motor from the controller.
Shaft Seal	Every 5000 hours	Replace shaft seal.
Overhaul	Every 20,000 hours or 5 years	If worn or damaged, replace after disconnecting the motor from the driven machine. Contact your YASKAWA representative.

13.2 SGD SERVOPACK

SGD SERVOPACK does not require any special maintenance. Remove dust and tighten screws periodically.

13.3 PRECAUTIONS FOR BATTERY REPLACEMENT

The life of the lithium battery (type ER6VC, made by Toshiba Corp.) is approximately 10 years. The battery for absolute encoder (provided by user) is replaced as follows :

- 1.* After SERVOPACK power is turned ON, SEN signal remains at a high-level for 3 minutes minimum. (The capacitor in encoder is charged.)
2. Replace the battery. (SERVOPACK power may be turned OFF or ON.)

The encoder position data remains in the same way as prior to replacement.

*After this operation is performed, the encoder will operate normally for two days maximum even without a battery.

14. TROUBLESHOOTING

14.1 SGM SERVOMOTOR

WARNING

Corrective actions in should be performed after turning OFF the power.

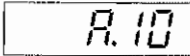
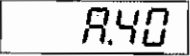
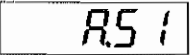
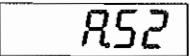
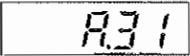
Table 14.1 Troubleshooting Guide for AC SERVOMOTOR

Trouble	Cause	What to do
Motor does not start	Loose connection	Tighten connection.
	Wrong wiring	Correct wiring.
	Overload	Reduce load or use a larger motor.
Unstable operation	Wrong wiring	Inspect and correct wiring across motor terminals U, V, and W, and PG.
Motor overheats	Excessive ambient temperature	Reduce ambient temperature below 40°C.
	Motor surface is dirty	Clean motor surface.
	Overload	Reduce load or use a larger motor.
Unusual noise	Motor loosely mounted	Tighten foundation bolts.
	Motor misaligned	Realign with driven machine.
	Coupling out of balance	Balance coupling.
	Noisy bearings	Check alignment, noise of bearings, lubrication and contact your YASKAWA representative.
	Vibration of driven machine	Contact the machine manufacturer.

14.2 SGD SERVOPACK

14.2.1 LED Indication (7-segment) for Troubleshooting

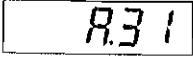
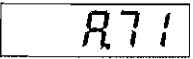




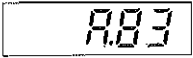
Table 14.2 LED Indication for Troubleshooting

Digital Operator Indication* (Traceback Monitor)	Lighting Condition	Probable Cause	Corrective Actions
 Overcurrent	Goes ON when power is supplied to the control circuit.	Defective control circuit board (1PWB).	Replace the SERVOPACK.
	Goes ON when power is supplied to the main circuit and servo power is turned ON.	<ul style="list-style-type: none"> Defective current feedback circuit. Defective main circuit transistor module. Motor grounding 	<ul style="list-style-type: none"> Replace the SERVOPACK. Correct grounding
	Lights during operation. Lights even after turning power OFF and then ON again. Operation is restarted after turning power OFF, waiting for a while, and resetting.	Ambient temperature near the SERVOPACK is over 55°C.	Reduce ambient temperature around the SERVOPACK to 55°C or lower. (Heat sink overheat)
 Overvoltage	Goes ON when the motor accelerates or decelerates.	Load inertia J_L is too large.	<ul style="list-style-type: none"> Check the inertia of the machine with the value converted to the motor shaft. Connect the regenerative unit.
		Defective regenerative circuit.	Replace the SERVOPACK.
 Overspeed	When the reference is input, the motor runs fast and LED goes ON.	<ul style="list-style-type: none"> Motor connection error Absolute encoder connection error Improper gain adjustment 	<ul style="list-style-type: none"> Correct the motor connection. Check pulses in phases A, B and C on 2CN and correct wiring. Correct gains
 Overspeed Reference	When the reference is input, the motor runs fast and LED goes ON.	The reference input voltage is too large.	Decrease the reference input voltage.
 Overflow	The reference pulse is input, but the PG pulse is not returned.	<ul style="list-style-type: none"> Motor connection error Absolute encoder connection error 	Correct the motor connection. Check the pulses of phases A, B, C for lead disconnection, short-circuit, no power supply, defective control circuit board. Correct the connections.
		Defective control circuit board (1PWB)	Replace the SERVOPACK.

* Display format is as indicated.



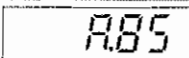

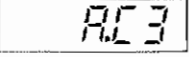
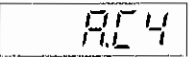
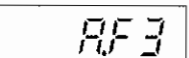
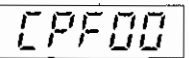
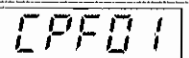
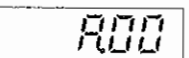
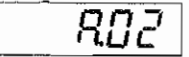
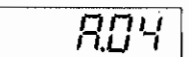
Table 14.2 LED Indication for Troubleshooting (Cont'd)

Digital Operator Indication* (Traceback Monitor)	Lighting Condition	Probable Cause	Corrective Actions
 Overflow	High-speed operation resulting in overflow.	<ul style="list-style-type: none"> • Motor connection error • Absolute encoder connection error 	Correct the motor connection. Check the pulses of phases A, B, C for lead disconnection, short-circuit, no power supply, defective control circuit board. Correct the connections.
		Defective control circuit board (1PWB)	• Replace the SERVOPACK.
	The operation is normal, but it overflows if long reference are given.	Faulty adjustment of the SERVOPACK.	Increase the speed loop gain.
		Load capacity too large.	Check and correct the load (overload, load inertia too high.)
 Instantaneous Overload	Goes ON during operation. When power to the control circuit is turned OFF and then turned ON again, the operation starts.	Operation is continued for several seconds to several tens seconds at a torque exceeding the rating.	Check for overload and adjust as necessary.
		<ul style="list-style-type: none"> • Operation is continued for several tens of seconds to several hundreds of seconds at a torque exceeding the rating. • Motor connection 	<ul style="list-style-type: none"> • Check for overload and adjust as necessary. • Correct wiring U → A, V → B, W → C.
 Continuous Overload	Goes ON during operation. When power to the control circuit is turned OFF and then turned ON again, the operation starts.	Erroneous wiring or incomplete contact of the absolute encoder.	Check and correct signal cables of phases A, B and C of 2CN.
		Malfunction of the SERVOPACK pulse counter	<ul style="list-style-type: none"> • Turn OFF the SEN signal, reset the alarm, then turn ON the SEN signal again. • Take noise-control measures.
 Encoder Error	Goes ON during operation.	Absolute encoder backup voltage dropped.	Set up the absolute encoder.
 Encoder Backup Error	Goes ON after SEN signal is input.	Absolute encoder memory data check error	Set up the absolute encoder.
 Encoder Checksum Error	Goes ON after SEN signal is input.	Absolute encoder battery voltage dropped.	Replace the battery and enter the SEN signal twice.
 Encoder Battery Alarm	Goes ON after SEN signal is input.		

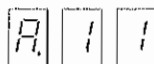
* Display format is as indicated.



Table 14.2 LED Indication for Troubleshooting (Cont'd)

Digital Operator Indication* (Traceback Monitor)	Lighting Condition	Probable Cause	Corrective Actions
 Encoder Overspeed	Goes ON after SEN signal is input.	The motor is running when the SEN signal is input.	Enter the SEN signal when the motor stops.
 Overrun	The motor starts momentarily, then LED goes ON.	Motor connection error	Correct the motor connection.
		Encoder connection error	Correct wiring of the optical encoder.
 Wire Break with Phase PA, PB	The motor starts momentarily, then LED goes ON.	Wire break with phase PA or PB of the optical encoder	Correct signal cables of the optical encoder.
 Wire Break with Phase PC	The motor starts momentarily, then LED goes ON.	Wire break with phase PC of the encoder	Correct signal cables of the optical encoder.
 Digital Operator Transmission Error 1	Goes ON when power is turned ON.	After interrupting the power supply, turns ON the power during power holding time.	Interrupt the power and turn ON the power again when power holding time elapses.
 Digital Operator Transmission Error 1	Goes ON when power is supplied to the control circuit or goes ON immediately when the digital operator is connected to the SERVOPACK.	Poor connection between digital operator and SGD SERVOPACK	Check the connection.
		Defective SGD SERVOPACK board	Replace the SERVOPACK.
		Digital operator failure	Replace the digital operator.
 Digital Operator Transmission Error 2	Goes ON during operation.	Malfunction of the internal circuit.	Resume after resetting operation.
		Failure of the internal circuit	Replace the SERVOPACK.
 Absolute Encoder Error	Goes ON after SEN signal is input.	Absolute encoder works incorrectly	<ul style="list-style-type: none"> • Enter the SEN signal again. • Set up the absolute encoder.
		Absolute encoder connection error	Correct wiring of the absolute encoder.
 Parameter Failure	Goes ON when power is turned ON.	Defective control circuit board (1PWB).	Replace the SERVOPACK.
 Parameter Setting Error	Goes ON when power is turned ON.	Set the value without a setting range by serial communication.	Reset the value.

* Display format is as indicated.

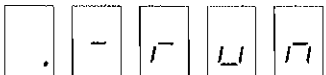


† Alarm A.00 is reset only by turning OFF the power. Normal alarm reset methods are invalid.

‡ Digital operator transmission errors are not recorded in traceback data.

14.2.2 Examples of Troubleshooting for Defective Wiring or Parts (Table 14.3)

Table 14.3 Examples of Troubleshooting for Defective Wiring or Parts

Trouble	Check Items	Corrective Actions
The reference is input, but the motor does not run.	<ul style="list-style-type: none"> • Voltage across (R) and (T). • Alarm LED OFF • Speed reference voltage • P-CON, N-OT, P-OT, S-ON • SEN signal (for absolute encoder) • Digital operator display 	<ul style="list-style-type: none"> • Check the AC power supply circuit. • If LED is ON, check the cause. • Adjust the speed setting potentiometer (supplied by the user).

14.2.3 Examples of Errors Resulting Setting Errors (Table 14.4)

Table 14.4 Examples of Errors Resulting Setting Errors

Error Condition	Cause	Corrective Actions
The motor vibrates at a high frequency of about 200 to 300 Hz. (The vibration frequency matches commercial frequency.)	Speed loop gain is too high. (Influence by induced noise in the SERVOPACK input circuit since the cable is too long or is bundled together with a power line.)	Adjust Cn-04 [LOOP Hz] to reduce speed loop gain until vibration stops. Separate the input circuit cable from the power lines or receive power to the input circuit from a power supply of a lower impedance (about 100Ω or lower. AC is allowable.)
Too much overshoot is observed with the rotation speed at acceleration and deceleration.	Speed loop gain is too high.	Adjust Cn-04 [LOOP Hz] to reduce speed loop gain until vibration stops.

14.2.4 Cause and Corrective Actions :
No Alarm is Displayed but the Motor does not Run

Table 14.5

Trouble	Cause	Condition	Corrective Actions
The motor does not run at all.	The servo-ON signal input is OFF.	Bit 0 of Cn-01 is 0.	Turn ON the servo-ON signal.
	Cables of the encoder and motor are not connected.		Connect the cables.
	The encoder is not suitable for the SGD SERVOPACK.		Use the applicable encoder.
	The P-OT or N-OT input signal is OFF.	Bit 2 or 3 of Cn-01 is 0.	Turn ON the P-OT or N-OT input signal.
	The error counter clear signal input is ON.		Turn OFF the error counter clear signal.
	Wrong select of reference pulse mode (Bit 3, 4, or 5 of user constant Cn-02)		Select bit 3, 4 or 5 of Cn-02 properly.
The motor moves momentarily, then stops and does not start again.	The number of pulses of the encoder being used does not match the set value of Cn-11.		Set proper value for Cn-11.
	Connection of the motor and the encoder are wrong.		Correct the connections.
The motor suddenly stops during operation and does not start again.	An alarm occurs while the alarm reset signal is ON.		Remove the cause of the alarm, then turn the alarm reset signal input ON and OFF.

Σ SERIES SGM/SGD

AC SERVO DRIVES WITH INCREMENTAL / ABSOLUTE ENCODER
FOR POSITIONING CONTROL

SERVOMOTOR: TYPES SGM- [] A [] 1 [] [] , SGM- [] B [] 1 [] []
SERVOPACK: TYPES SGD- [] AP, SGD- [] BP

TOKYO OFFICE Ohtemachi Bldg, 1-6-1 Ohtemachi, Chiyoda-ku, Tokyo, 100 Japan
Phone (03) 3284-9111 Telex YASKAWA J33530 Fax (03) 3284-9034

SEOUL OFFICE 8th Floor Seoul Center Bldg, 91-1, Sogong-Dong, Chung-ku, Seoul, Korea 100-070
Phone (02) 776-7844 Fax (02) 753-2639

TAIPEI OFFICE Shen Hsiang Tang Sung Chiang Building 10F 146 Sung Chiang Road, Taipei, Taiwan
Phone (02) 563-0010, -7732 Fax (02) 567-4677

YASKAWA ELECTRIC AMERICA, INC.
Chicago-Corporate Headquarters 2942 MacArthur Blvd Northbrook, IL 60062-2028, U.S.A
Phone (708) 291-2340 Fax (708) 498-2430
Chicago-Technical Center 3160 MacArthur Blvd Northbrook, IL 60062-1917, U.S.A
Phone (708) 291-0411 Fax (708) 291-1018

MOTOMAN INC.
805 Liberty Lane West Carrollton, OH 45449, U.S.A.
Phone (513) 847-6200 Fax (513) 847-6277

YASKAWA ELECTRIC EUROPE GmbH
Niederhochstadler Straße 73, 61476 Kronberg-Oberhochstadt, Germany
Phone (06173) 9380 Telex 415660 YASE D Fax (06173) 68421

YASKAWA ELÉTRICO DO BRASIL COMÉRCIO, L.T.D.A.
Rua Conde Do Pinhal 8-5°, Andar Sala 51 CEP 01501-São Paulo-SP, Brasil
Phone (011) 35-1911 Fax (011) 37-7375

YASKAWA ELECTRIC (SINGAPORE) PTE. LTD.
Head Office : CPF Bldg, 79 Robinson Road # 13-05, Singapore 0106, SINGAPORE
Phone 221-7530 Telex (87) 24890 YASKAWA RS Fax 224-5854
Service Center : 221 Henderson Road, # 07-20 Henderson Building Singapore 0315, SINGAPORE
Phone 276-7407 Fax 276-7406

YATEC ENGINEERING CORPORATION
Shen Hsiang Tang Sung Chiang Building 10F 146 Sung Chiang Road, Taipei, Taiwan
Phone (02) 563-0010 Fax (02) 567-4677



YASKAWA ELECTRIC CORPORATION

YASKAWA

TSE-S800-15.2B

© Printed in Japan December 1993 93-12 3TA